

## FCC - TEST REPORT

Report Number : **68.950.19.0606.01** Date of Issue: **July 26, 2019**

---

Model : **3BOX A2**

---

Product Type : **Wearable on Neck Host**

---

Applicant : **VR Technology (Shenzhen) Limited**

---

Address : **Room 201, 12 Gaoxin South Road, Huiheng Building, Nanshan**  
**District, Shenzhen**

---

Manufacturer : **VR Technology (Shenzhen) Limited**

---

Address : **Room 201, 12 Gaoxin South Road, Huiheng Building, Nanshan**  
**District, Shenzhen**

---

Test Result :  **Positive**     **Negative**

---

Total pages including Appendices : **65**

*TÜV SÜD Certification and Testing (China) Co., Ltd. Shenzhen Branch is a subcontractor to TÜV SÜD Product Service GmbH according to the principles outlined in ISO 17025.*

*TÜV SÜD Certification and Testing (China) Co., Ltd. Shenzhen Branch reports apply only to the specific samples tested under stated test conditions. Construction of the actual test samples has been documented. It is the manufacturer's responsibility to assure that additional production units of this model are manufactured with identical electrical and mechanical components. The manufacturer/importer is responsible to the Competent Authorities in Europe for any modifications made to the production units which result in non-compliance to the relevant regulations. TÜV SÜD Certification and Testing (China) Co., Ltd. Shenzhen Branch shall have no liability for any deductions, inferences or generalizations drawn by the client or others from TÜV SÜD Certification and Testing (China) Co., Ltd. Shenzhen Branch issued reports.*

*This report is the confidential property of the client. As a mutual protection to our clients, the public and ourselves, extracts from the test report shall not be reproduced except in full without our written approval.*



# 1 Table of Contents

1	Table of Contents .....	2
2	Details about the Test Laboratory .....	3
3	Description of the Equipment Under Test .....	4
4	Summary of Test Standards .....	5
5	Summary of Test Results .....	6
6	General Remarks .....	7
7	Test Setups .....	8
8	Systems test configuration .....	9
9	Technical Requirement .....	10
9.1	Conducted peak output power .....	10
9.2	6dB bandwidth and 99% Occupied Bandwidth .....	12
9.3	Power spectral density .....	27
9.4	Spurious RF conducted emissions.....	28
9.5	Band edge testing .....	55
9.6	Spurious radiated emissions for transmitter.....	61
10	Test Equipment List.....	64
11	System Measurement Uncertainty .....	65

## 2 Details about the Test Laboratory

### Details about the Test Laboratory

#### Test Site 1

Company name: TÜV SÜD Certification and Testing (China) Co., Ltd. Shenzhen Branch  
Building 12 & 13, Zhiheng Wisdomland Business Park, Nantou Checkpoint  
Road 2, Nanshan District  
Shenzhen 518052  
P.R. China

Telephone: 86 755 8828 6998

Fax: 86 755 8828 5299

FCC Registration No.: 514049

FCC Designation Number: CA5009

IC Registration No.: 10320A

### 3 Description of the Equipment Under Test

Product:	Wearable on Neck Host
Model no.:	3BOX A2
FCC ID:	2AKA6-A2
Options and accessories:	Adapter and USB Cable
Rating:	Supplied by 5*3.8Vdc 1100mAh Li-ion Rechargeable battery Charged by 5.0Vdc, 3.0A external adapter
Adapter information:	Adapter Model: A138A-120150U-US2 Input: 100-240Vac, 50/60Hz; 0.5A Output: 5.0Vdc, 3.0A
RF Transmission Frequency:	2412MHz-2462MHz
No. of Operated Channel:	11
Modulation:	DSSS, OFDM
Antenna Type:	Integrated antenna
Antenna Gain:	3.0dBi
Description of the EUT:	The Equipment Under Test (EUT) is a Wearable on Neck Host which support Bluetooth function and Wi-Fi operated at 5GHz and 2.4GHz. Only 2.4GWiFi included in this report.

## 4 Summary of Test Standards

Test Standards	
FCC Part 15 Subpart C 10-1-2018 Edition	PART 15 - RADIO FREQUENCY DEVICES Subpart C - Intentional Radiators

All the test methods were according to  
 KDB 558074 D01 15.247 Meas Guidance v05r02,  
 KDB 662911 D01 Multiple Transmitter Output v02r01,  
 ANSI C63.10 (2013).

## 5 Summary of Test Results

Technical Requirements						
FCC Part 15 Subpart C						
Test Condition	Pages	Test Site	Test Result			
			Pass	Fail	N/A	
§15.207	Conducted emission AC power port	---	---	<input type="checkbox"/>	<input type="checkbox"/>	<input checked="" type="checkbox"/>
§15.247 (b) (1)	Conducted peak output power	10	Site 1	<input checked="" type="checkbox"/>	<input type="checkbox"/>	<input type="checkbox"/>
§15.247(a)(1)	20dB bandwidth	---	---	<input type="checkbox"/>	<input type="checkbox"/>	<input checked="" type="checkbox"/>
§15.247(a)(1)	Carrier frequency separation	---	---	<input type="checkbox"/>	<input type="checkbox"/>	<input checked="" type="checkbox"/>
§15.247(a)(1)(iii)	Number of hopping frequencies	---	---	<input type="checkbox"/>	<input type="checkbox"/>	<input checked="" type="checkbox"/>
§15.247(a)(1)(iii)	Dwell Time	---	---	<input type="checkbox"/>	<input type="checkbox"/>	<input checked="" type="checkbox"/>
§15.247(a)(2)	6dB bandwidth and 99% Occupied Bandwidth	12	Site 1	<input checked="" type="checkbox"/>	<input type="checkbox"/>	<input type="checkbox"/>
§15.247(e)	Power spectral density	27	Site 1	<input checked="" type="checkbox"/>	<input type="checkbox"/>	<input type="checkbox"/>
§15.247(d)	Spurious RF conducted emissions	34	Site 1	<input checked="" type="checkbox"/>	<input type="checkbox"/>	<input type="checkbox"/>
§15.247(d)	Band edge	54	Site 1	<input checked="" type="checkbox"/>	<input type="checkbox"/>	<input type="checkbox"/>
§15.247(d)	Spurious radiated emissions for transmitter	60	Site 1	<input checked="" type="checkbox"/>	<input type="checkbox"/>	<input type="checkbox"/>
§15.203	Antenna requirement	See note 2		<input checked="" type="checkbox"/>	<input type="checkbox"/>	<input type="checkbox"/>

Note 1: N/A=Not Applicable.

Note 2: The EUT uses an internal antenna, which gain is 3.0dBi. In accordance to §15.203, It is considered sufficiently to comply with the provisions of this section.

## 6 General Remarks

### Remarks

This submittal(s) (test report) is intended for FCC ID: 2AKA6-A2 complies with Section 15.207, 15.209, 15.247 of the FCC Part 15, Subpart C rules.

### SUMMARY:

All tests according to the regulations cited on page 5 were

- Performed

- **Not** Performed

The Equipment Under Test

- **Fulfills** the general approval requirements.

- **Does not** fulfill the general approval requirements.

Sample Received Date: June 13, 2019

Testing Start Date: June 14, 2019

Testing End Date: July 10, 2019

TÜV SÜD Certification and Testing (China) Co., Ltd. Shenzhen Branch

Reviewed by:

Prepared by:

Tested by:



John Zhi  
Project Manager

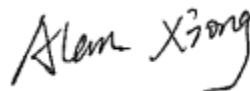

Alan Xiong  
Project Engineer



Tree Zhan  
Test Engineer

## 7 Test Setups

### 7.1 Radiated test setups Below 1GHz

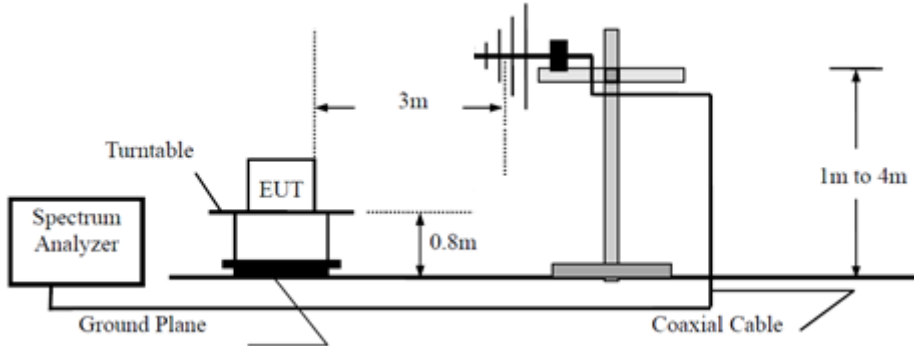

### Above 1GHz

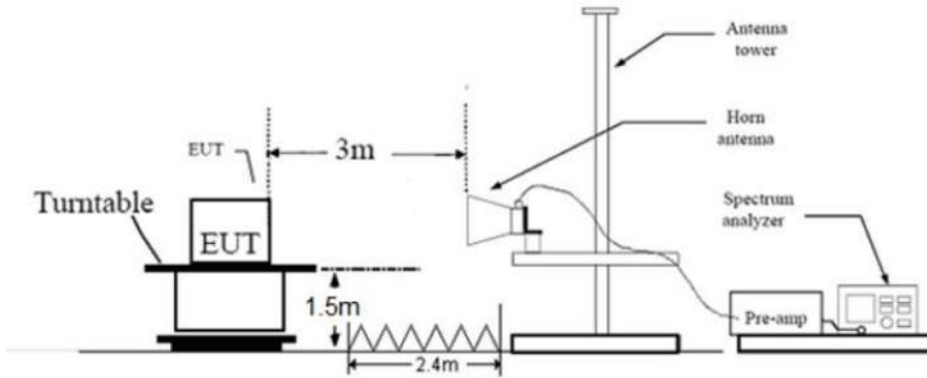

### 7.2 Conducted RF test setups

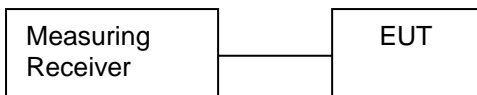



## 8 Systems test configuration

Auxiliary Equipment Used during Test:

DESCRIPTION	MANUFACTURER	MODEL NO.(SHIELD)	S/N(LENGTH)
PC	Lenovo	X240	---

The system was configured to non-hopping mode.

Non-hopping mode: The system was configured to operate at a signal channel transmitting. The test software allows the configuration and operation at the worst-case duty and the highest transmit power.

Through pre-scan all kind of modulation and all kind of rates, find the 1Mbps of rate is the worst case of 802.11b; the 6Mbps of rate is the worst case of 802.11g; the 6.5Mbps of rate is the worst case of 802.11n20; the 13.5Mbps of rate is the worst case of 802.11n40, only the worst case transmitter rate data mode in recorded in the report.

The system was configured to the following transmit power

Modulation	Ant0	Ant1	Ant0+Ant1
802.11b	14	11	---
802.11g	15	14	---
802.11n20	---	---	12
802.11n40	---	---	12

## 9 Technical Requirement

### 9.1 Conducted peak output power

#### Test Method

1. The RF output of EUT was connected to the power meter by RF cable. The path loss was compensated to the results for each measurement.
2. Set to the maximum power setting and enable the EUT transmit continuously
3. Use the following test receiver settings:  
Span = approximately 5 times the 20dB bandwidth, centered on a hopping channel  
RBW > the 20dB bandwidth of the emission being measured, VBW ≥ RBW,  
Sweep = auto, Detector function = peak, Trace = max hold
4. Allow the trace to stabilize. Use the marker-to-peak function to set the marker to the peak of the emission. The indicated level is the peak output power and record the results in the test report.
5. Repeat above procedures until all frequencies measured were complete.

#### Limits

According to §15.247 (b) (1), conducted peak output power limit as below:

Frequency Range MHz	Limit W	Limit dBm
2400-2483.5	≤1	≤30

Test result as below table

802.11b\_SISO modulation Test Result

Frequency (MHz)	Conducted Peak Output Power (dBm)		Result
	Ant 0	Ant 1	
Low channel 2412MHz	14.5	13.4	Pass
Middle channel 2437MHz	14.3	12.6	Pass
High channel 2462MHz	14.5	13.4	Pass

802.11g\_SISO modulation Test Result

Frequency (MHz)	Conducted Peak Output Power (dBm)		Result
	Ant 0	Ant 1	
Low channel 2412MHz	15.5	16.4	Pass
Middle channel 2437MHz	15.2	14.5	Pass
High channel 2462MHz	15.5	16.3	Pass

802.11n20\_MIMO modulation Test Result

Frequency (MHz)	Conducted Peak Output Power (dBm)			Result
	Ant0	Ant1	SUM	
Low channel 2412MHz	13.5	13.1	16.3	Pass
Middle channel 2437MHz	12.1	11.3	14.7	Pass
High channel 2462MHz	13.8	12.9	16.4	Pass

802.11n40\_MIMO modulation Test Result

Frequency (MHz)	Conducted Peak Output Power (dBm)			Result
	Ant0	Ant1	SUM	
Low channel 2422MHz	12.5	12.2	15.4	Pass
Middle channel 2437MHz	12.1	11.4	14.8	Pass
High channel 2452MHz	12.4	12.0	15.2	Pass

## 9.2 6dB bandwidth and 99% Occupied Bandwidth

### Test Method for 6 dB Bandwidth

1. Use the following spectrum analyzer settings:  
RBW=100K, VBW $\geq$ 3RBW, Sweep = auto, Detector function = peak, Trace = max hold
2. Use the automatic bandwidth measurement capability of an instrument, may be employed using the X dB bandwidth mode with X set to 6 dB, care shall be taken so that the bandwidth measurement is not influenced by any intermediate power nulls in the fundamental emission that might be  $\geq$  6 dB.
3. Allow the trace to stabilize, record the X dB Bandwidth value.

### Test Method for 99 % Bandwidth

1. Use the following spectrum analyzer settings:  
RBW=1% to 5% of the actual occupied, VBW $\geq$ 3RBW, Sweep = auto, Detector function = peak, Trace = max hold
2. Use the automatic bandwidth measurement capability of an instrument, care shall be taken so that the bandwidth measurement is not influenced by any intermediate power nulls in the fundamental emission that might be  $\geq$  6 dB.
3. Allow the trace to stabilize, record the X dB Bandwidth value.

### Limit

Limit [kHz]

---

$\geq 500$

**6dB Bandwidth**

TestMode	Antenna	Channel [MHz]	DTS BW [MHz]	FL[MHz]	FH[MHz]	Limit [MHz]	Verdict
11B_SISO	Ant0	2412	8.160	2407.920	2416.080	0.5	PASS
	Ant1	2412	8.120	2407.920	2416.040	0.5	PASS
	Ant0	2437	8.160	2432.880	2441.040	0.5	PASS
	Ant1	2437	8.120	2432.920	2441.040	0.5	PASS
	Ant0	2462	8.160	2457.880	2466.040	0.5	PASS
	Ant1	2462	8.160	2457.880	2466.040	0.5	PASS
11G_SISO	Ant0	2412	16.400	2403.800	2420.200	0.5	PASS
	Ant1	2412	16.440	2403.760	2420.200	0.5	PASS
	Ant0	2437	16.400	2428.760	2445.160	0.5	PASS
	Ant1	2437	16.440	2428.760	2445.200	0.5	PASS
	Ant0	2462	16.400	2453.760	2470.160	0.5	PASS
	Ant1	2462	16.440	2453.760	2470.200	0.5	PASS
11N20_MIMO	Ant0+Ant1	2412	17.640	2403.160	2420.800	0.5	PASS
		2437	17.680	2428.120	2445.800	0.5	PASS
		2462	17.680	2453.120	2470.800	0.5	PASS
11N40_MIMO	Ant0+Ant1	2422	36.480	2403.760	2440.240	0.5	PASS
		2437	36.480	2418.760	2455.240	0.5	PASS
		2452	36.480	2433.760	2470.240	0.5	PASS

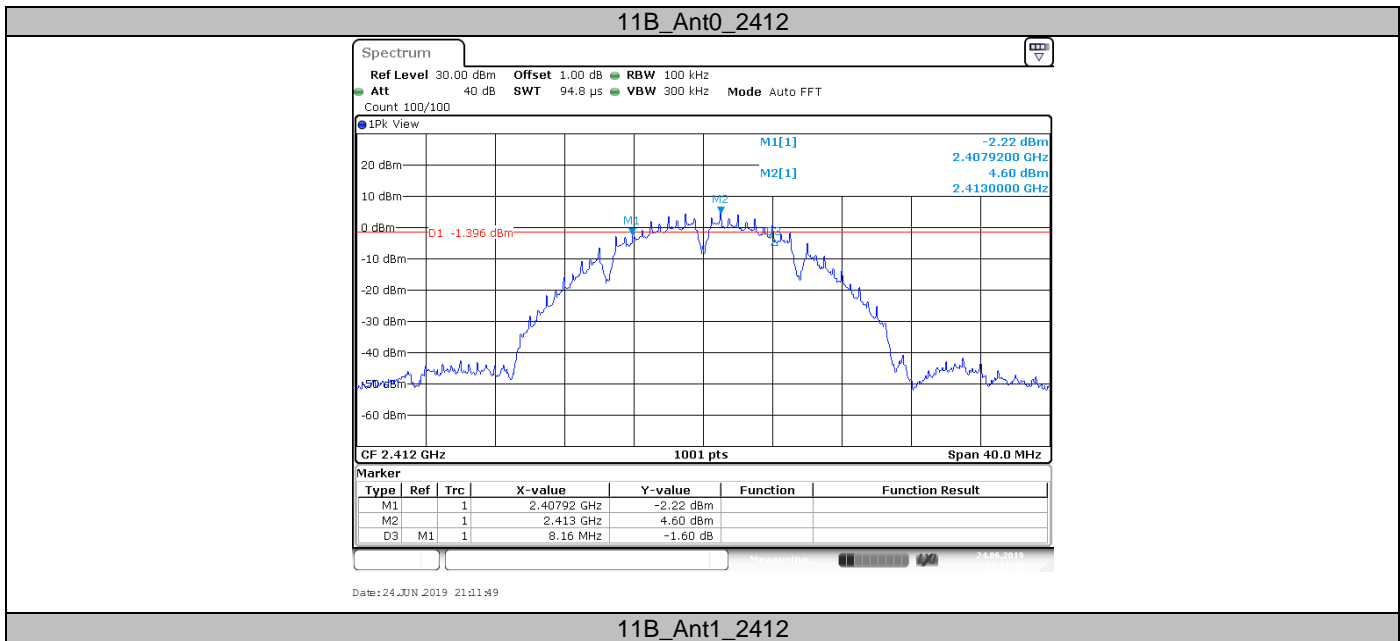

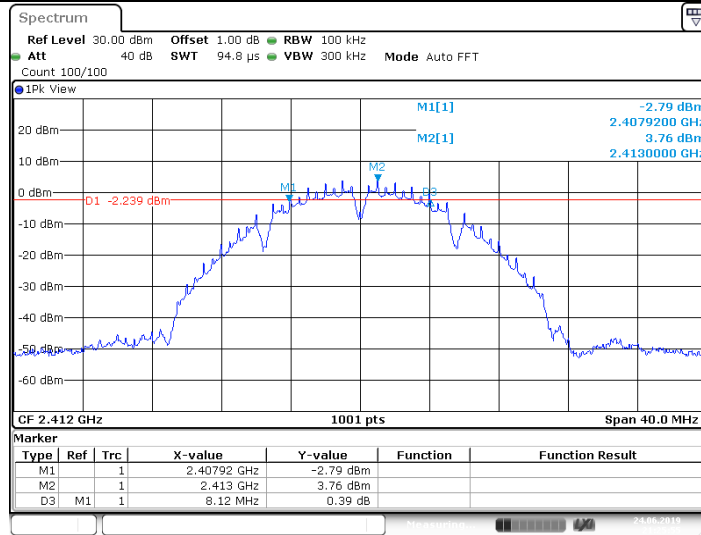

Date: 24 JUN 2019 21:25:55

11B\_Ant0\_2437

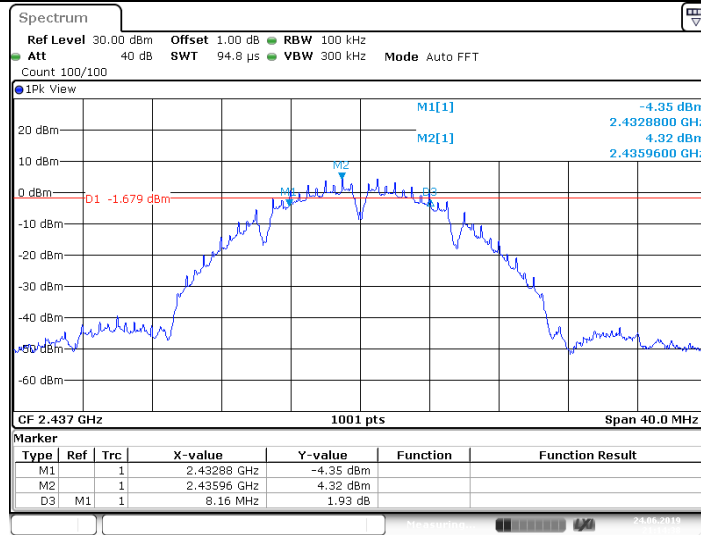

Date: 24 JUN 2019 21:14:39

11B\_Ant1\_2437

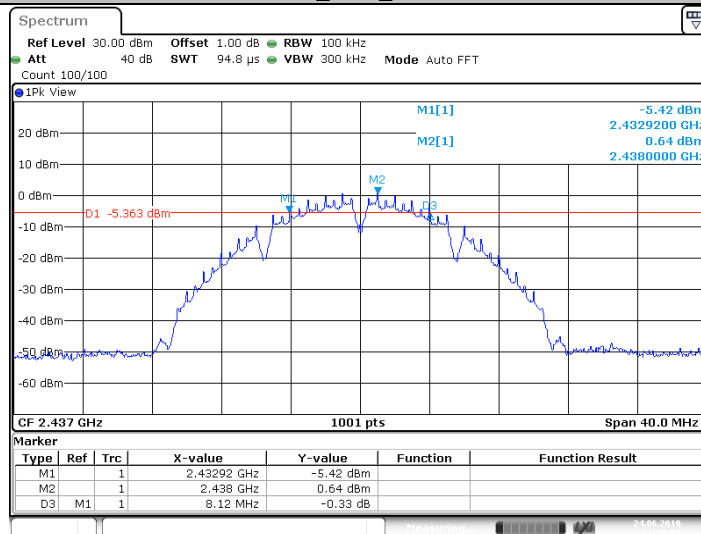

Date: 24 JUN 2019 21:28:09

11B\_Ant0\_2462

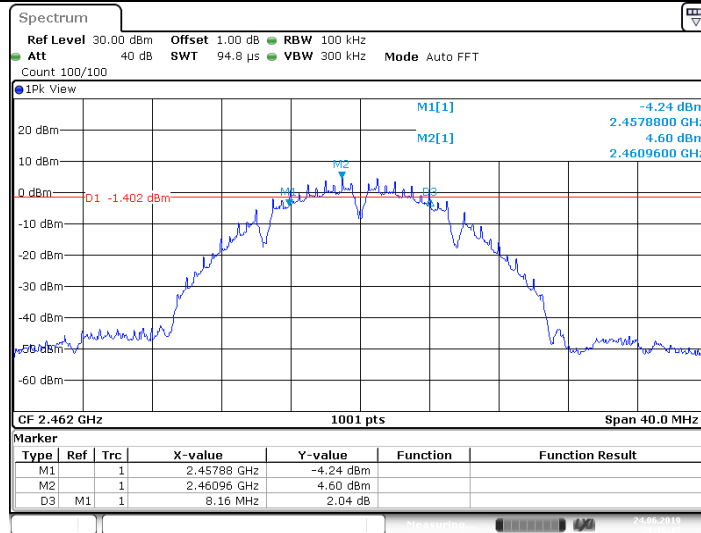

Date: 24 JUN 2019 21:16:16

11B\_Ant1\_2462

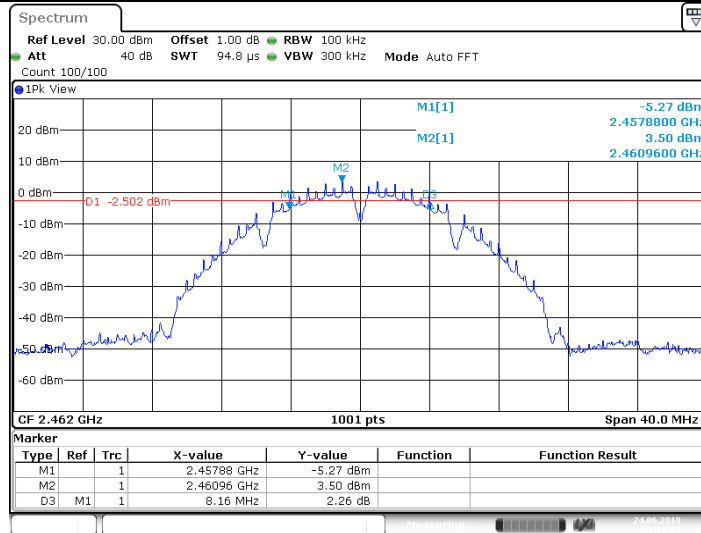

Date: 24 JUN 2019 21:29:57

11G\_Ant0\_2412

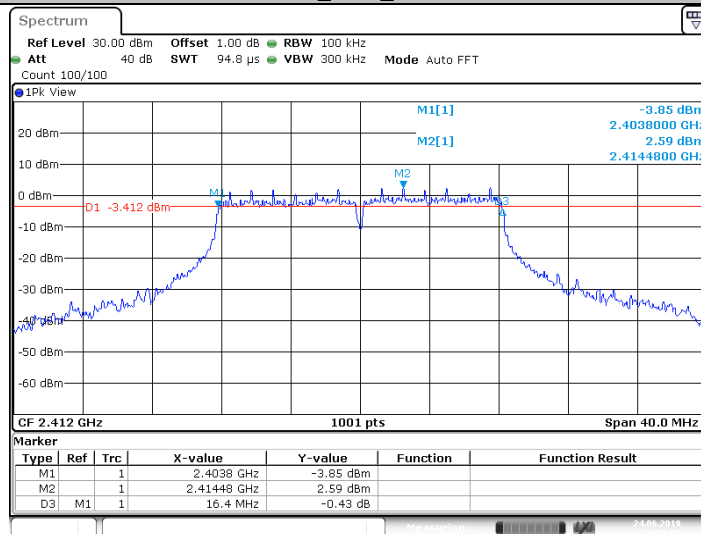

Date: 24 JUN 2019 21:19:03

11G\_Ant1\_2412

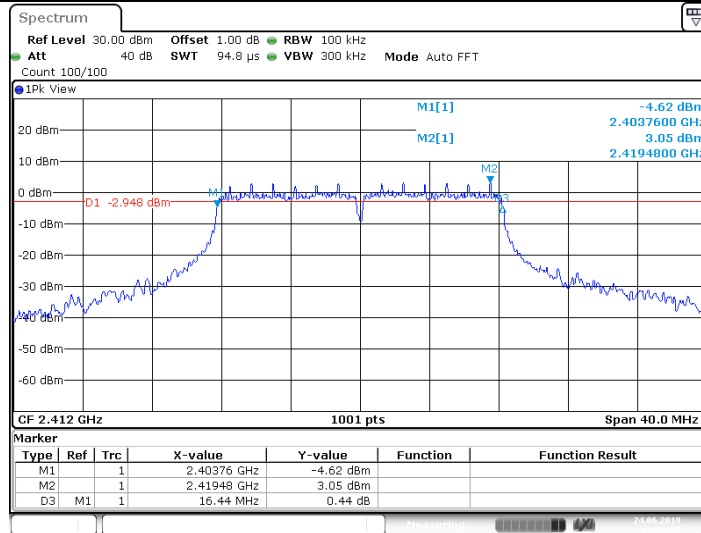

Date: 24 JUN 2019 21:32:38

11G\_Ant0\_2437

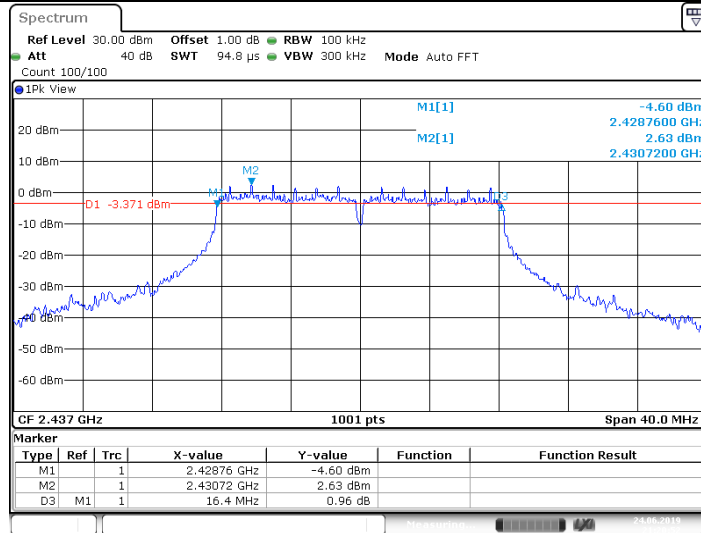

Date: 24 JUN 2019 21:20:52

11G\_Ant1\_2437

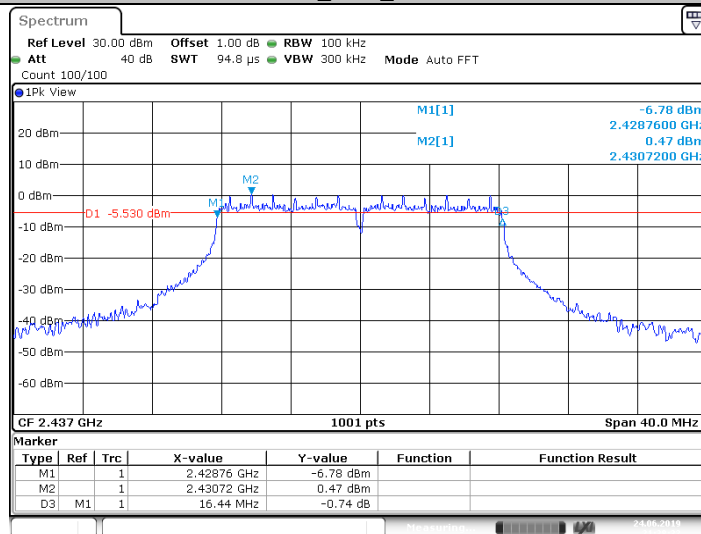

Date: 24 JUN 2019 21:38:33

11G\_Ant0\_2462



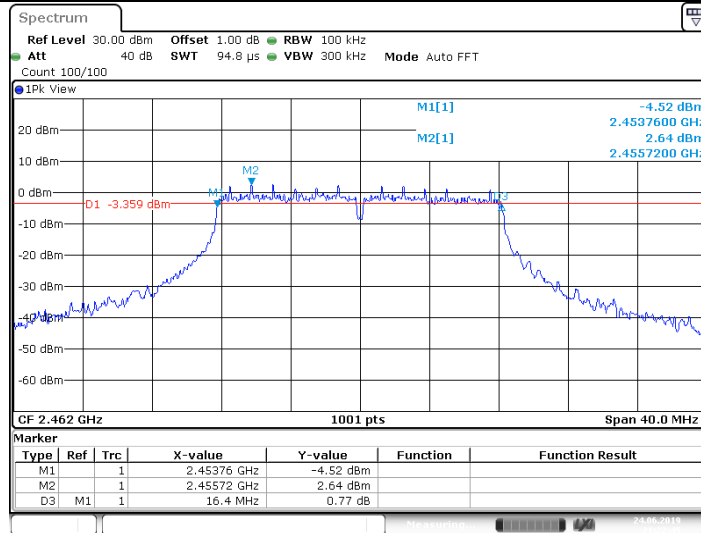

Date: 24 JUN 2019 21:22:45

11G Ant1\_2462

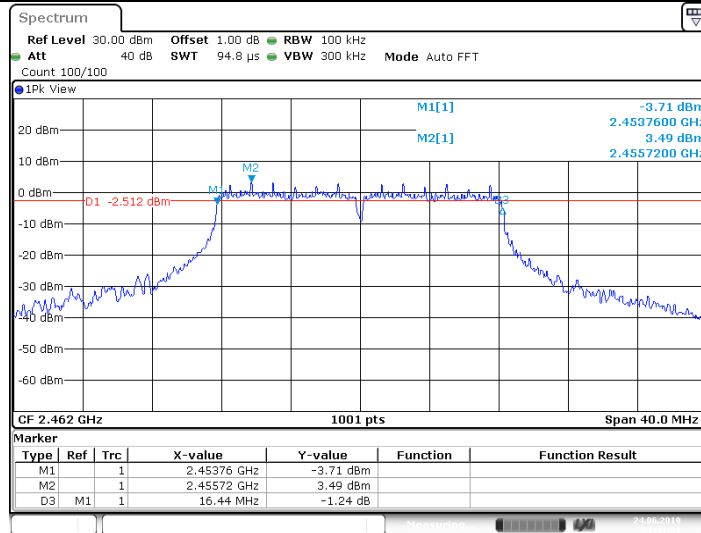

Date: 24 JUN 2019 21:41:21

11N20MIMO\_2412

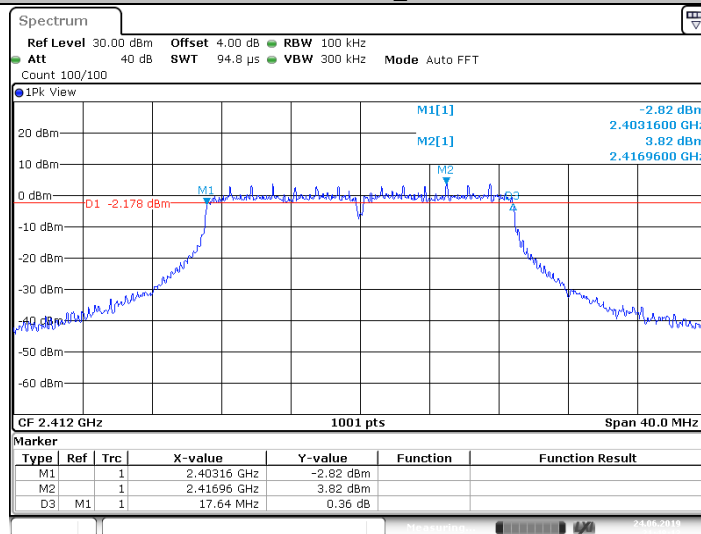

Date: 24 JUN 2019 21:48:14

11N20MIMO\_2437

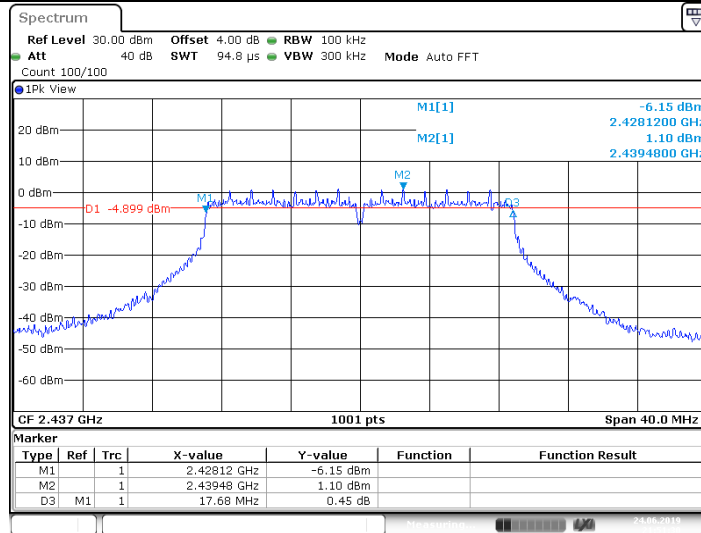

Date: 24 JUN 2019 21:51:31

11N20MIMO\_2462

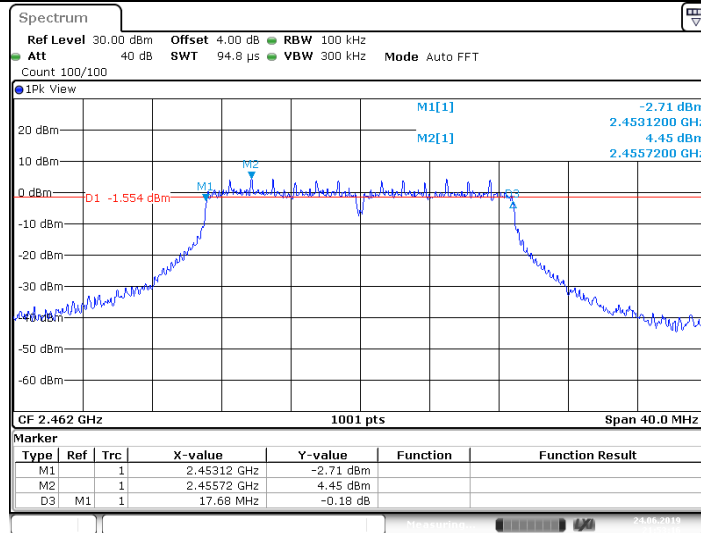

Date: 24 JUN 2019 21:53:17

11N40MIMO\_2422

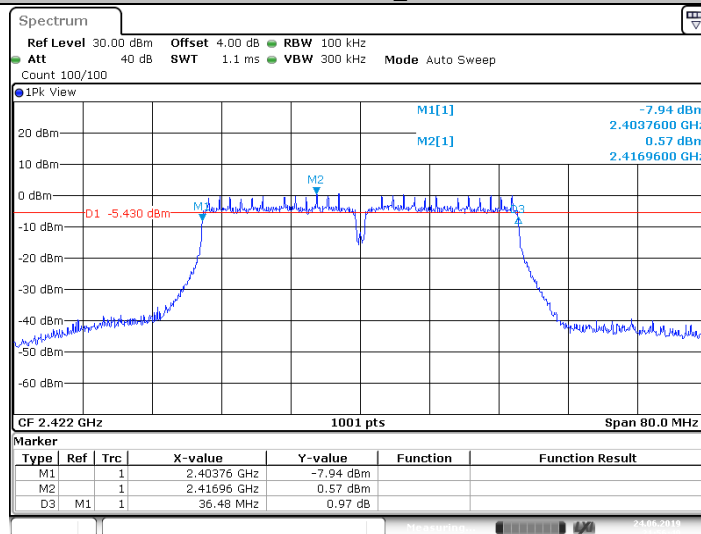

Date: 24 JUN 2019 21:56:49

11N40MIMO\_2437

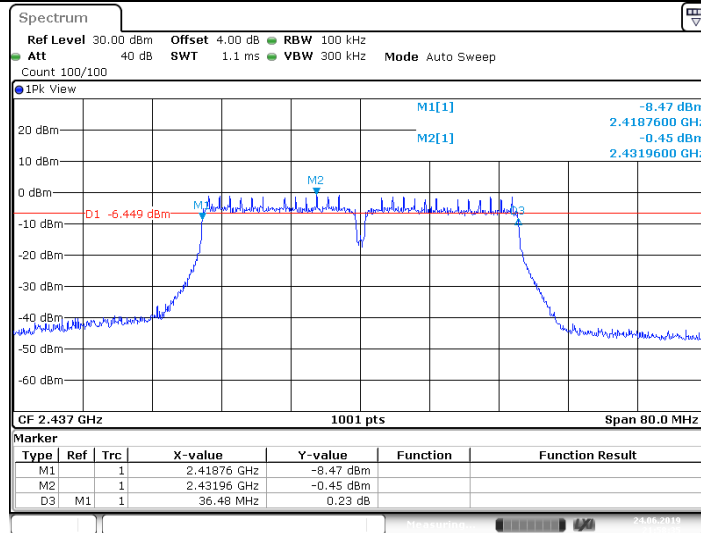

Date: 24 JUN 2019 21:58:35

11N40MIMO\_2452



Date: 24 JUN 2019 22:00:35

**99% Bandwidth**

TestMode	Antenna	Channel [MHz]	OCB [MHz]	FL[MHz]	FH[MHz]	Limit [MHz]	Verdict
11B_SISO	Ant0	2412	13.826	2405.287	2419.113	---	PASS
	Ant1	2412	13.666	2405.287	2418.953	---	PASS
	Ant0	2437	13.906	2429.927	2443.833	---	PASS
	Ant1	2437	13.866	2430.047	2443.913	---	PASS
	Ant0	2462	13.666	2455.047	2468.713	---	PASS
	Ant1	2462	13.786	2455.047	2468.833	---	PASS
11G_SISO	Ant0	2412	17.542	2403.209	2420.751	---	PASS
	Ant1	2412	17.622	2403.129	2420.751	---	PASS
	Ant0	2437	17.662	2427.929	2445.591	---	PASS
	Ant1	2437	17.502	2428.049	2445.551	---	PASS
	Ant0	2462	17.423	2453.089	2470.511	---	PASS
	Ant1	2462	17.702	2452.929	2470.631	---	PASS
11N20_MIMO	Ant0+An1	2412	18.462	2402.729	2421.191	---	PASS
		2437	18.501	2427.609	2446.111	---	PASS
		2462	18.541	2452.569	2471.111	---	PASS
11N40_MIMO	Ant0+Ant1	2422	36.843	2403.698	2440.541	---	PASS
		2437	36.923	2418.538	2455.462	---	PASS
		2452	36.923	2433.538	2470.462	---	PASS

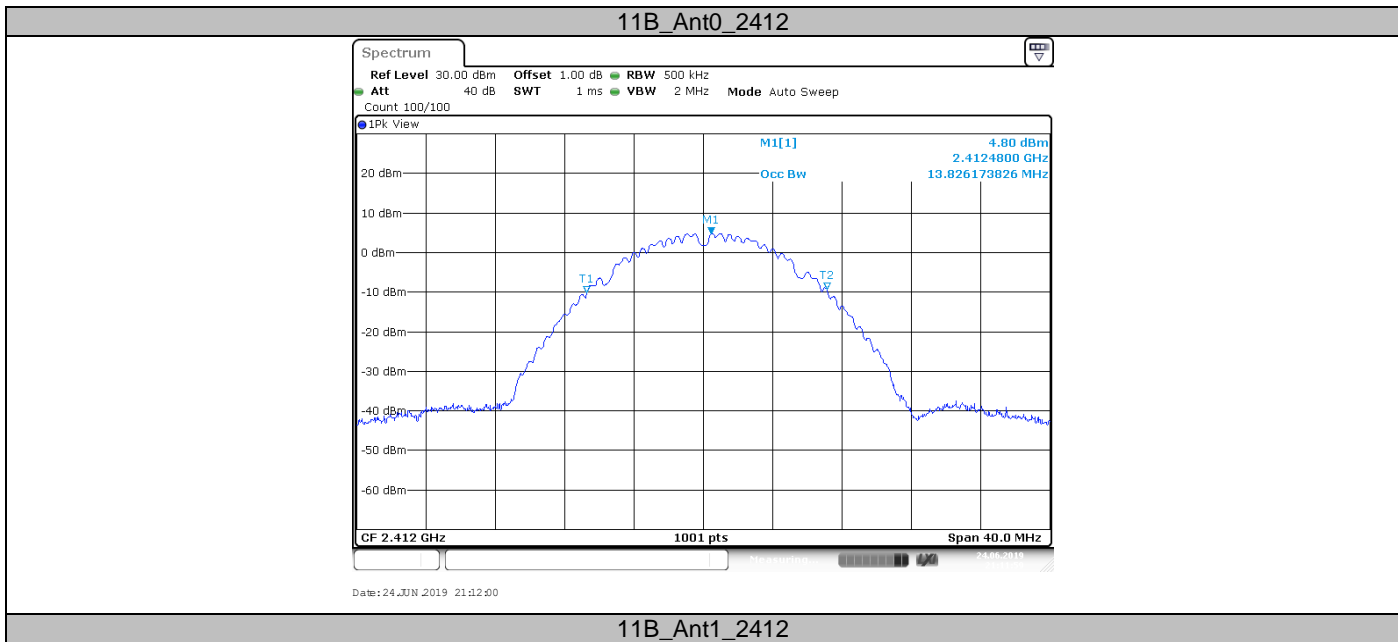

**11B\_Ant1\_2412**

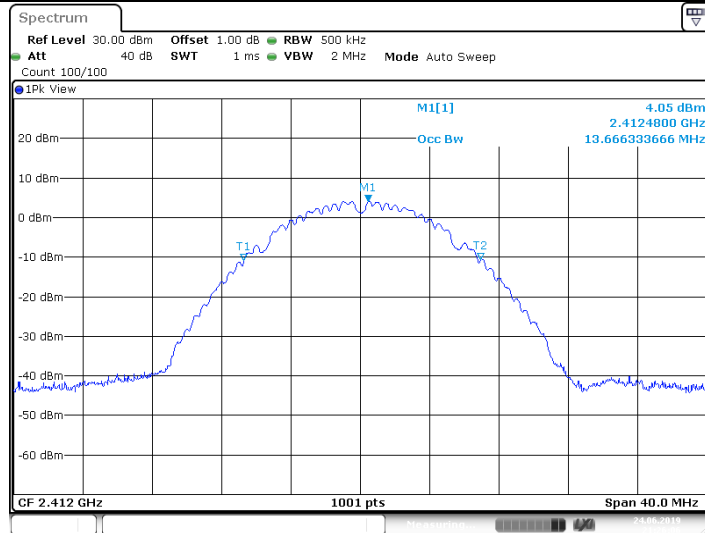

Date: 24 JUN 2019 21:26:06

11B\_Ant0\_2437

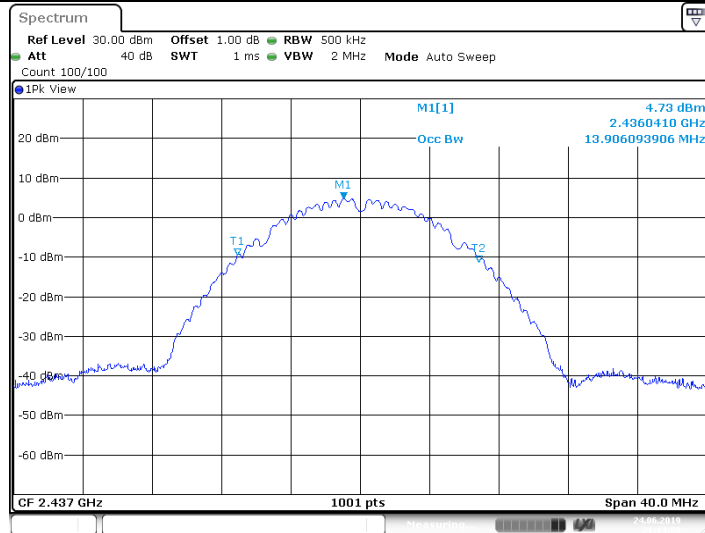

Date: 24 JUN 2019 21:14:50

11B\_Ant1\_2437

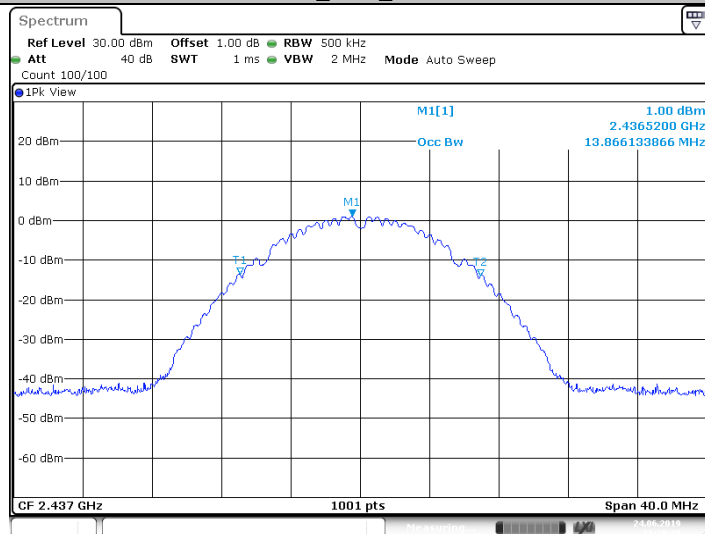

Date: 24 JUN 2019 21:28:20

11B\_Ant0\_2462

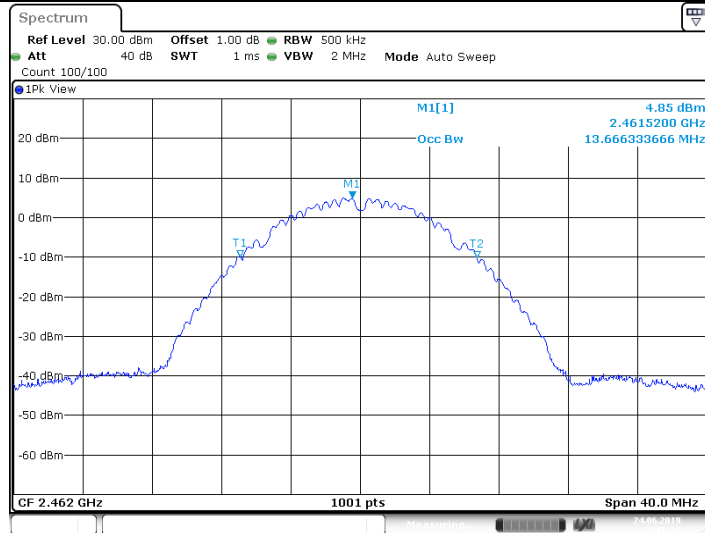

Date: 24 JUN 2019 21:16:27

11B\_Ant1\_2462

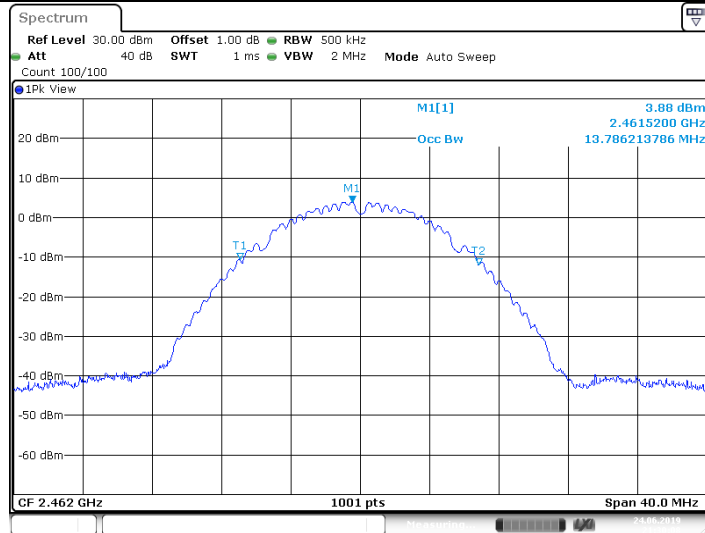

Date: 24 JUN 2019 21:30:08

11G\_Ant0\_2412

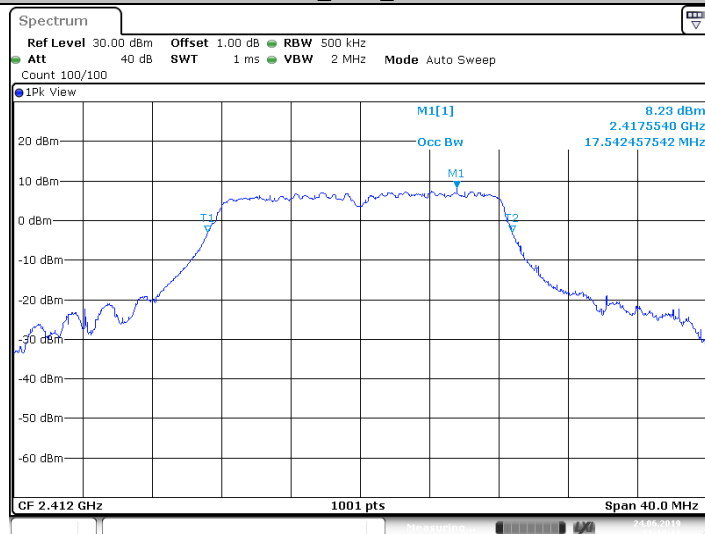

Date: 24 JUN 2019 21:19:14

11G\_Ant1\_2412

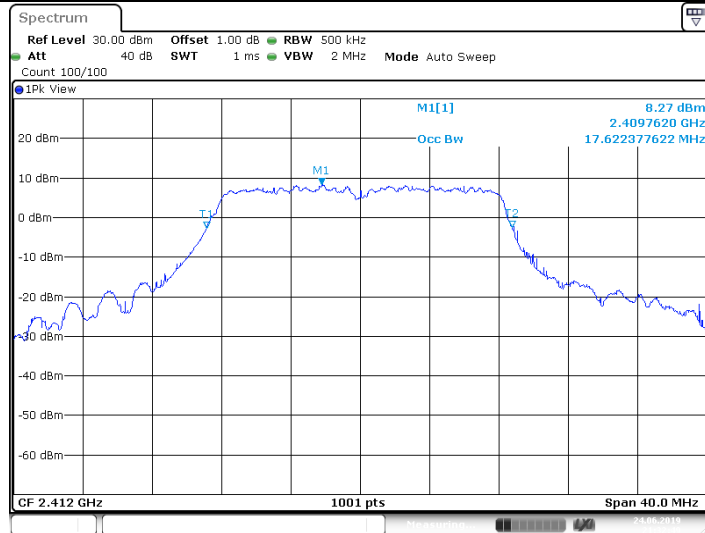

Date: 24 JUN 2019 21:32:49

11G\_Ant0\_2437



Date: 24 JUN 2019 21:21:03

11G\_Ant1\_2437

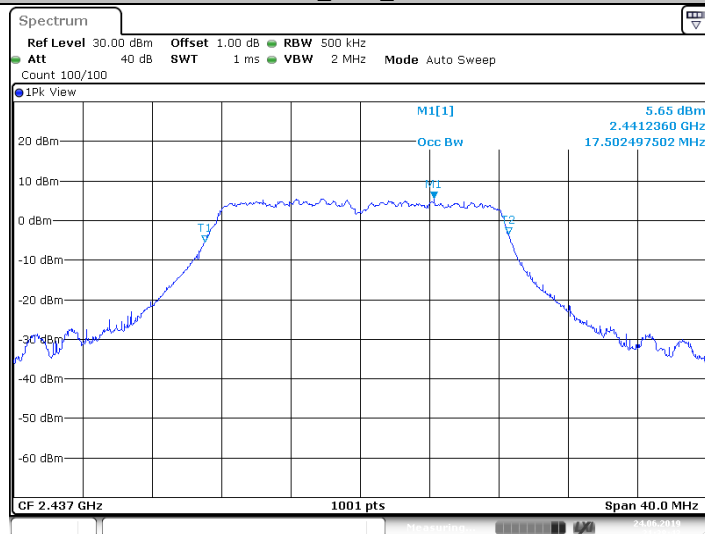

Date: 24 JUN 2019 21:38:44

11G\_Ant0\_2462

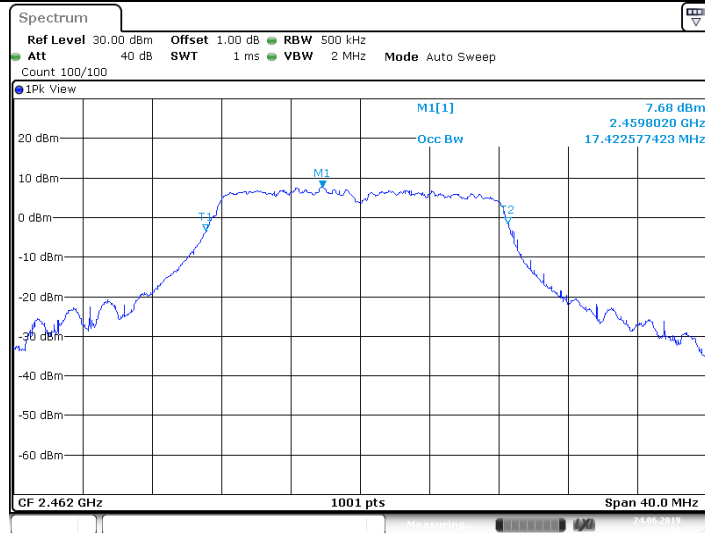

Date: 24 JUN 2019 21:22:56

11G Ant1\_2462

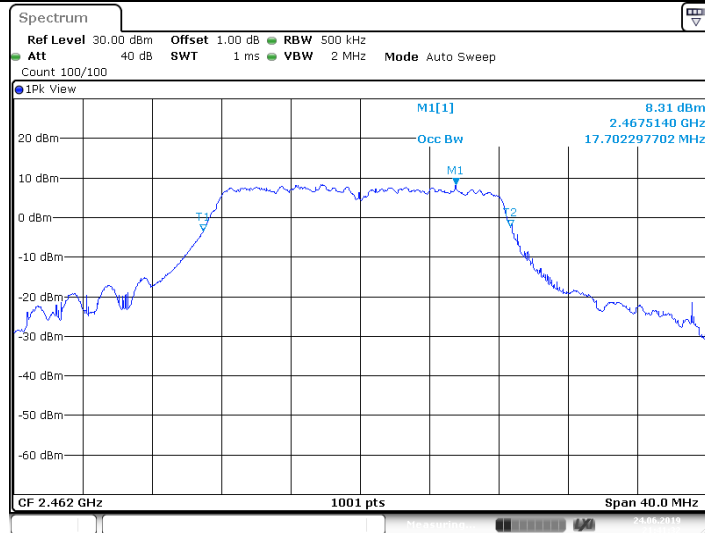

Date: 24 JUN 2019 21:41:32

11N20MIMO\_2412

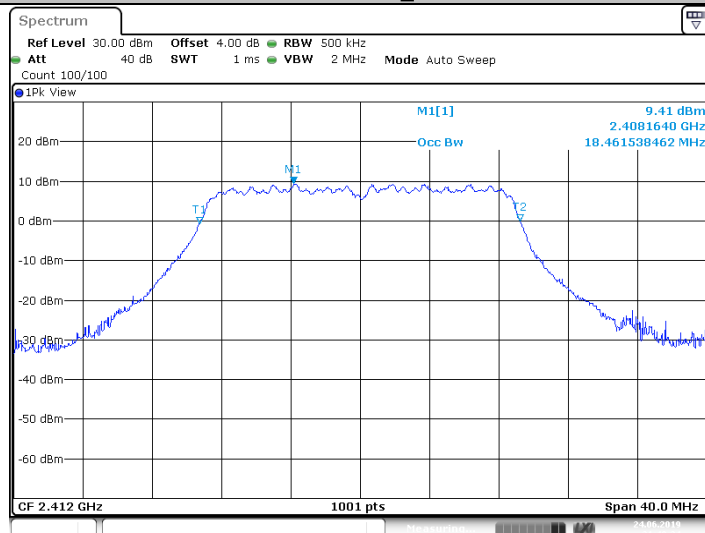

Date: 24 JUN 2019 21:48:25

11N20MIMO\_2437



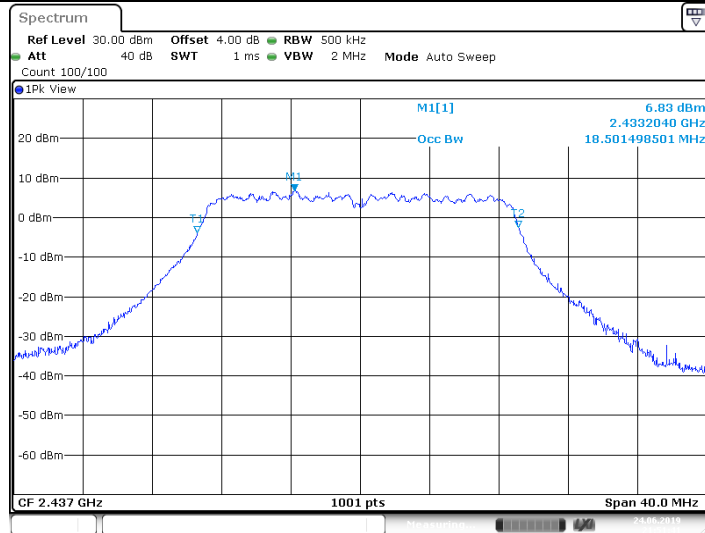

Date: 24 JUN 2019 21:51:42

11N20MIMO\_2462

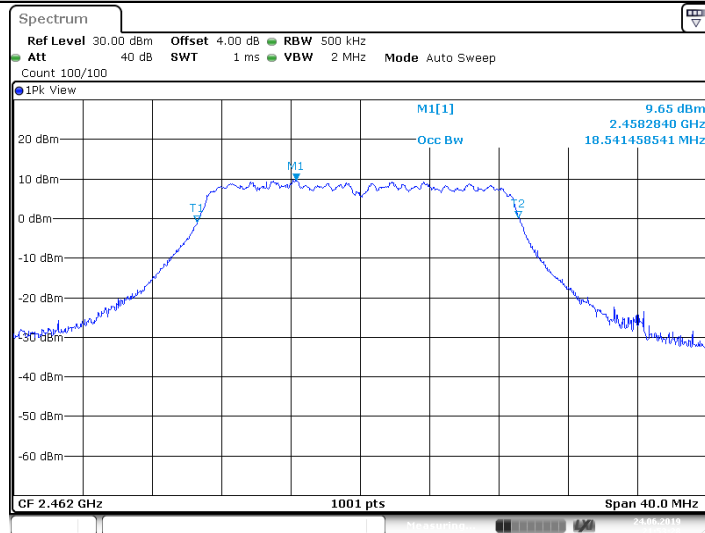

Date: 24 JUN 2019 21:53:28

11N40MIMO\_2422

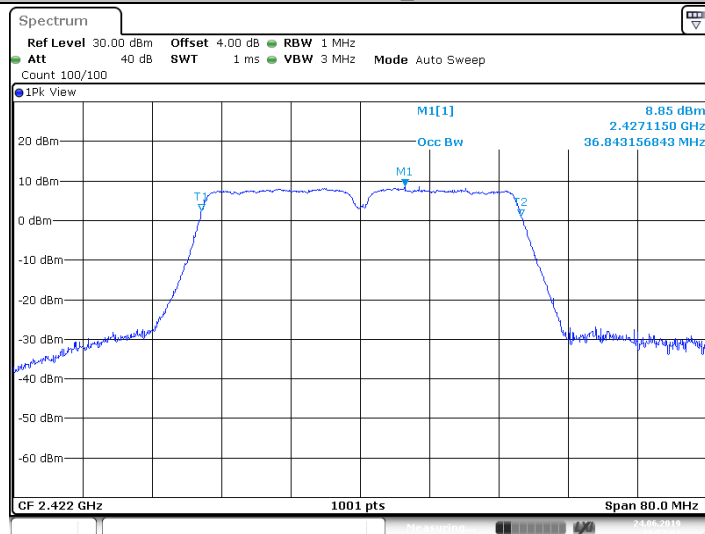

Date: 24 JUN 2019 21:57:00

11N40MIMO\_2437



11N40MIMO\_2452



### 9.3 Power spectral density

#### Test Method

This procedure shall be used if maximum peak conducted output power was used to demonstrate compliance:

1. The RF output of EUT was connected to the test receiver by RF cable. The path loss was compensated to the results for each measurement.
2. Set analyzer center frequency to DTS channel center frequency. RBW=10kHz, VBW=3RBW, Span=1.5 times DTS bandwidth, Detector=Peak, Sweep=auto, Trace= max hold.
3. Allow trace to fully stabilize, use the peak marker function to determine the maximum amplitude level within the RBW.
4. Repeat above procedures until other frequencies measured were completed.

#### Limit

Limit [dBm]

≤8

802.11b\_SISO modulation Test Result

Frequency (MHz)	Power spectral density (dBm/3KHz)		Limit (dBm)	Result
	Ant 0	Ant 1		
Low channel 2412MHz	4.42	3.48	8	Pass
Middle channel 2437MHz	4.26	3.50	8	Pass
High channel 2462MHz	4.44	3.38	8	Pass

802.11g\_SISO modulation Test Result

Frequency (MHz)	Power spectral density (dBm/3KHz)		Limit (dBm)	Result
	Ant 0	Ant 1		
Low channel 2412MHz	-12.89	-11.73	8	Pass
Middle channel 2437MHz	-13.22	-14.19	8	Pass
High channel 2462MHz	-13.04	-12.31	8	Pass

802.11n-HT20\_MIMO modulation Test Result

Frequency (MHz)	Power spectral density (dBm/3KHz)	Limit (dBm)	Result
Low channel 2412MHz	-11.31	8	Pass
Middle channel 2437MHz	-12.47	8	Pass
High channel 2462MHz	-10.47	8	Pass

802.11n-HT40\_MIMO modulation Test Result

Frequency (MHz)	Power spectral density (dBm/3KHz)	Limit (dBm)	Result
Low channel 2422MHz	-14.67	8	Pass
Middle channel 2437MHz	-16.63	8	Pass
High channel 2452MHz	-14.56	8	Pass

NOTE: According to the test results of output power, Ant0 is considered to have the highest power, so PSD for Multiple mode are performed with this antenna and add 3dBi factor, this factor has been compensated in the test.

11B\_Ant0\_2412

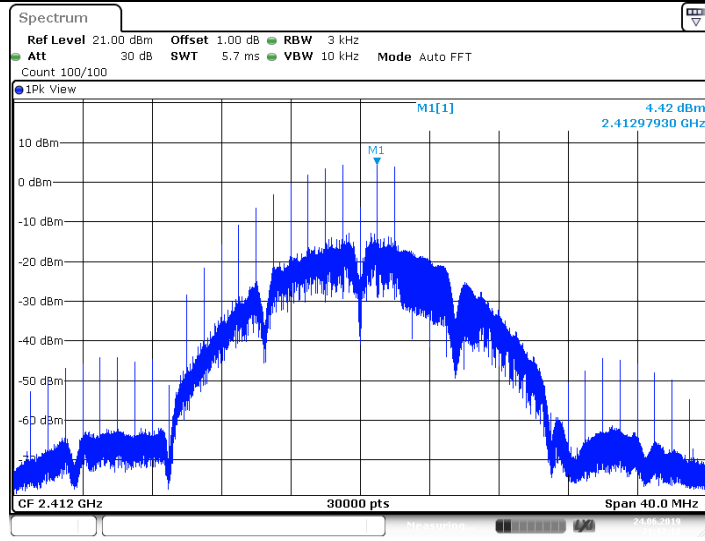

Date: 24 JUN 2019 21:22:22

11B\_Ant1\_2412

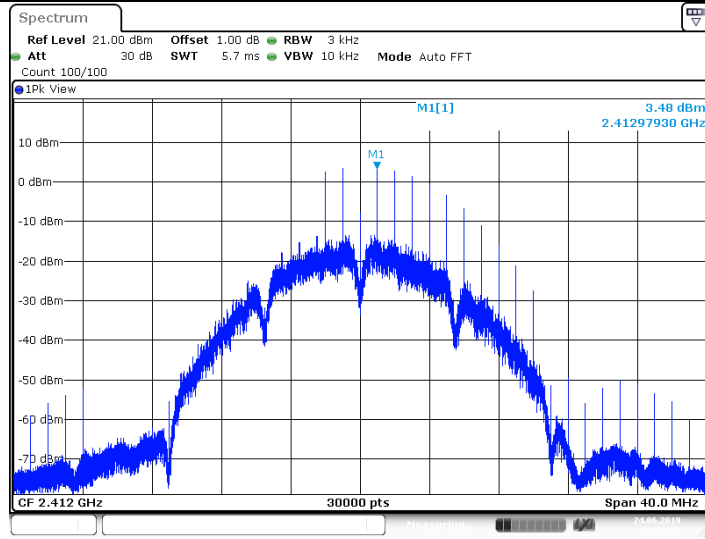

Date: 24 JUN 2019 21:26:18

11B\_Ant0\_2437

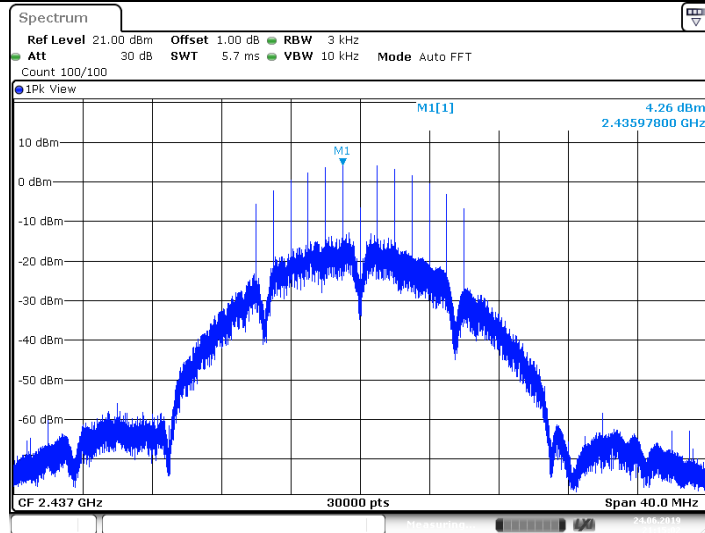

Date: 24 JUN 2019 21:15:02

11B\_Ant1\_2437

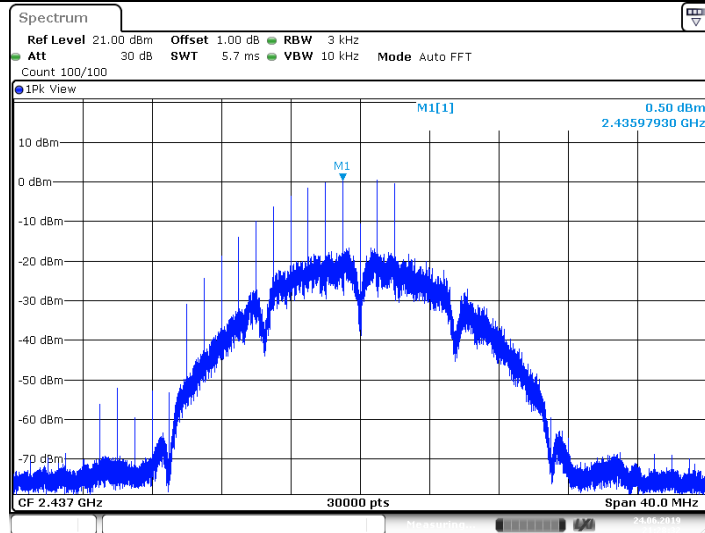

Date: 24 JUN 2019 21:28:32

11B\_Ant0\_2462

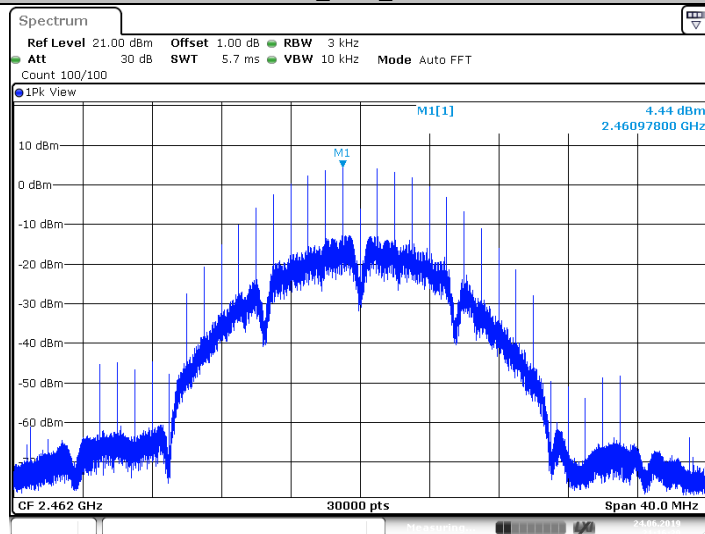

Date: 24 JUN 2019 21:16:39

11B\_Ant1\_2462

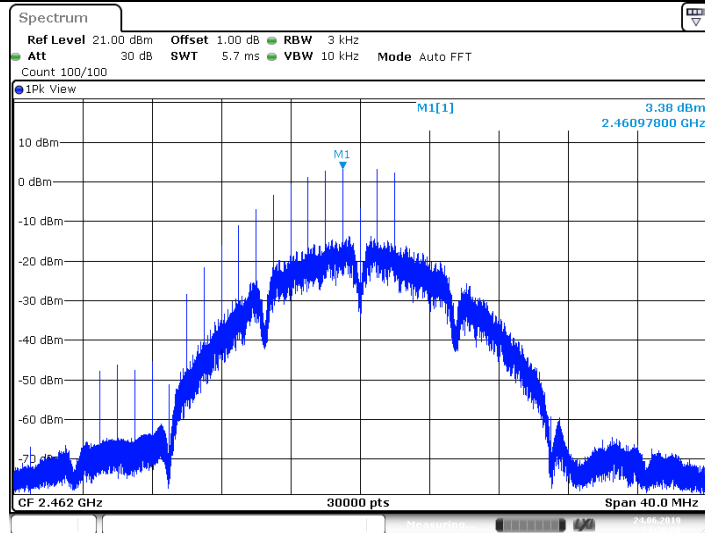

Date: 24 JUN 2019 21:30:21

11G\_Ant0\_2412

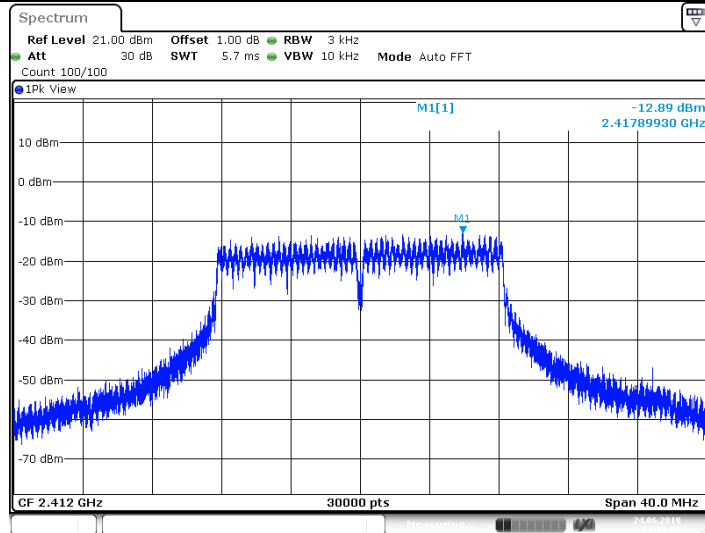

Date: 24 JUN 2019 21:19:26

11G\_Ant1\_2412

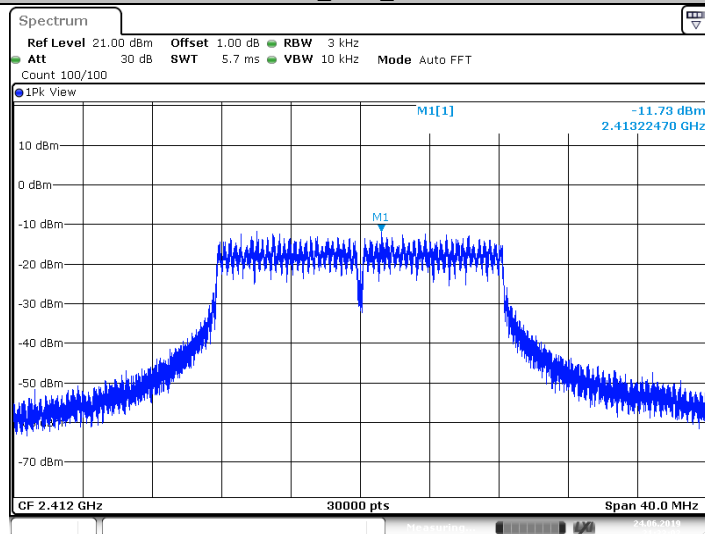

Date: 24 JUN 2019 21:33:02

11G\_Ant0\_2437

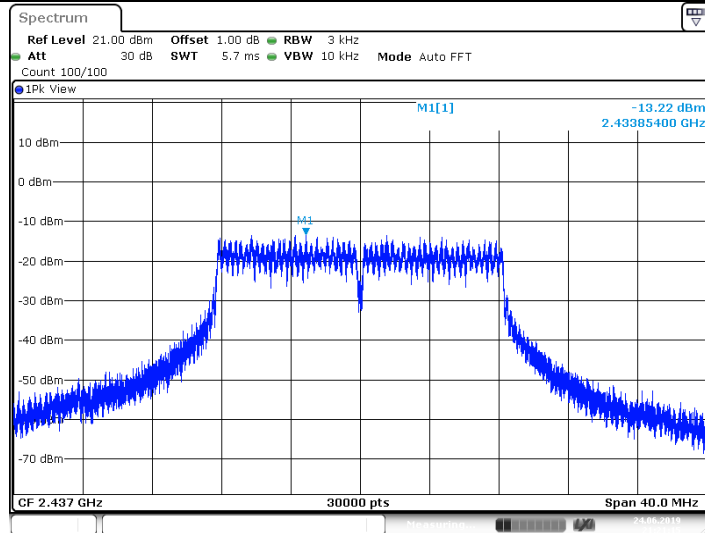

Date: 24 JUN 2019 21:21:16

11G\_Ant1\_2437

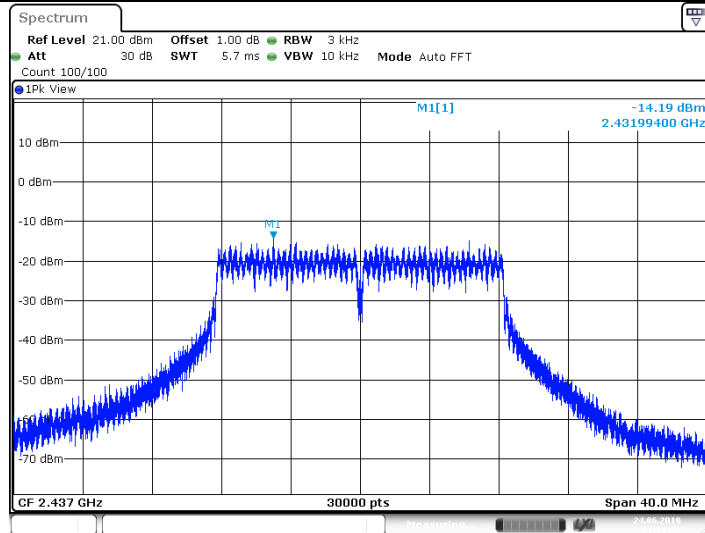

Date: 24 JUN 2019 21:38:56

11G\_Ant0\_2462

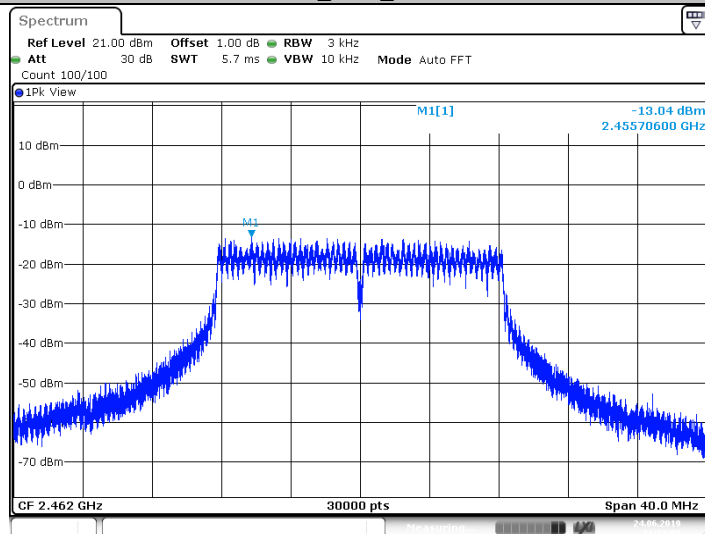

Date: 24 JUN 2019 21:23:58

11G\_Ant1\_2462

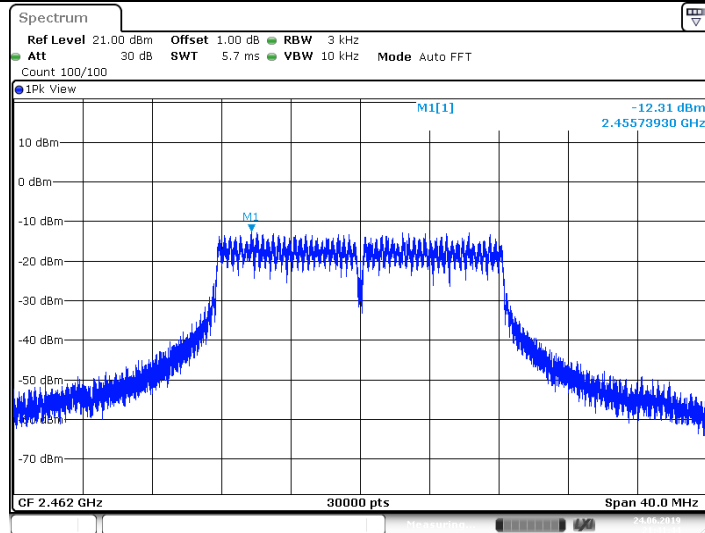

Date: 24 JUN 2019 21:41:44

11N20MIMO\_2412

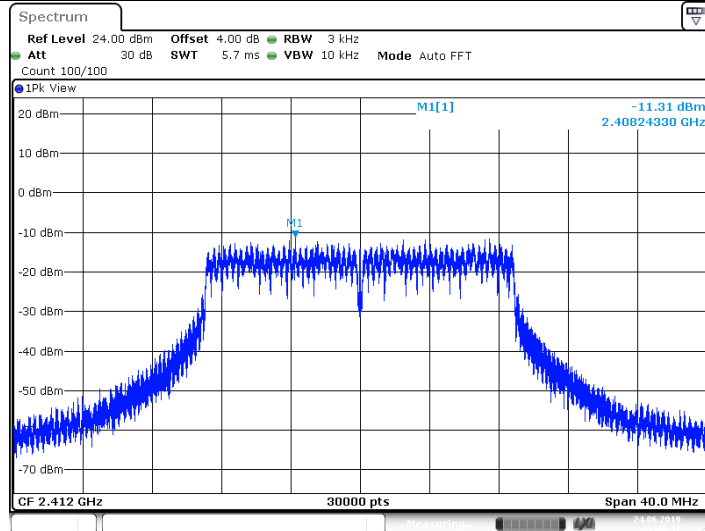

Date: 24 JUN 2019 21:48:37

11N20MIMO\_2437

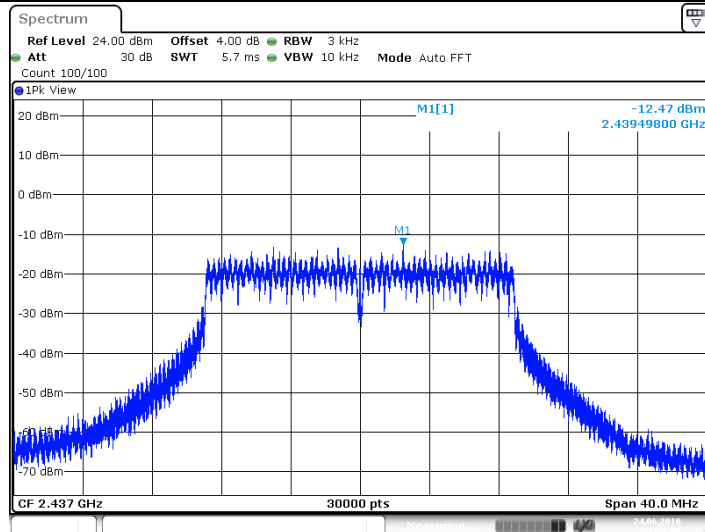

Date: 24 JUN 2019 21:51:54

11N20MIMO\_2462



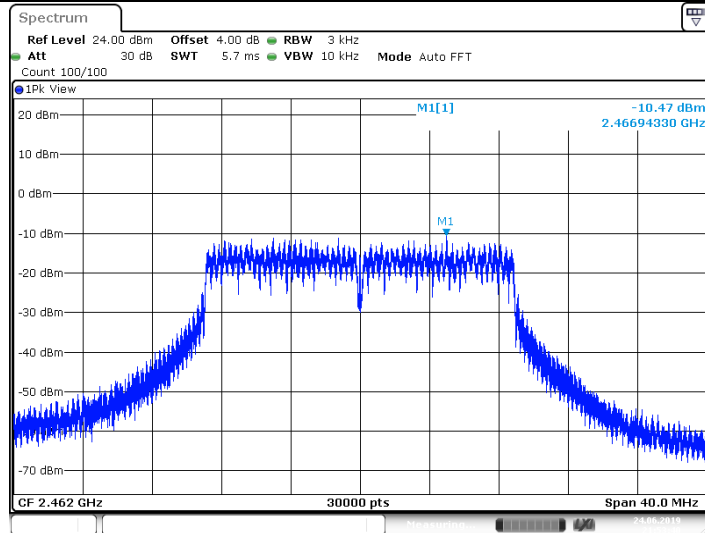

Date: 24 JUN 2019 21:53:40

11N20MIMO\_2422

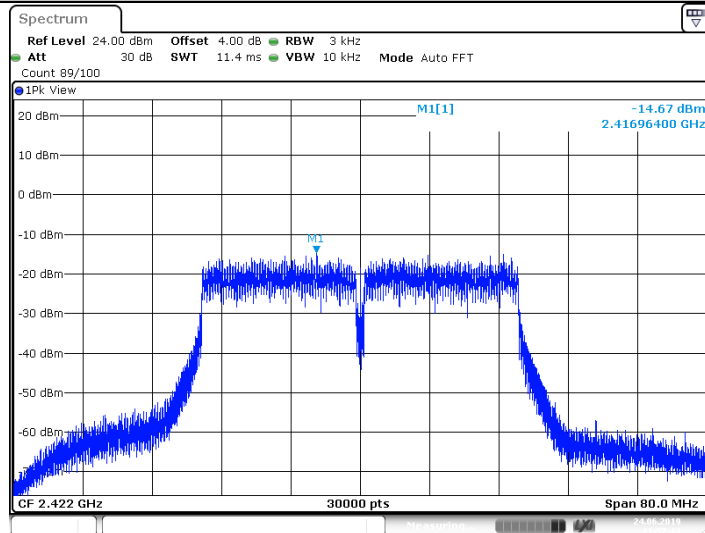

Date: 24 JUN 2019 21:57:13

11N20MIMO\_2437

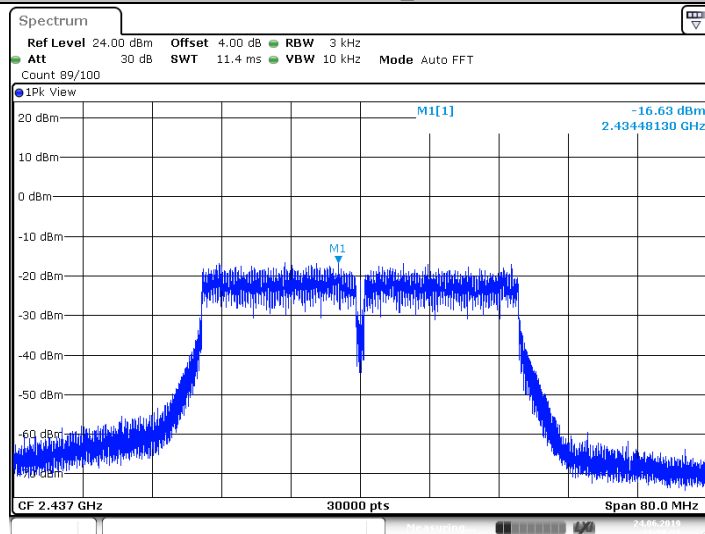

Date: 24 JUN 2019 21:58:59

11N20MIMO\_2452

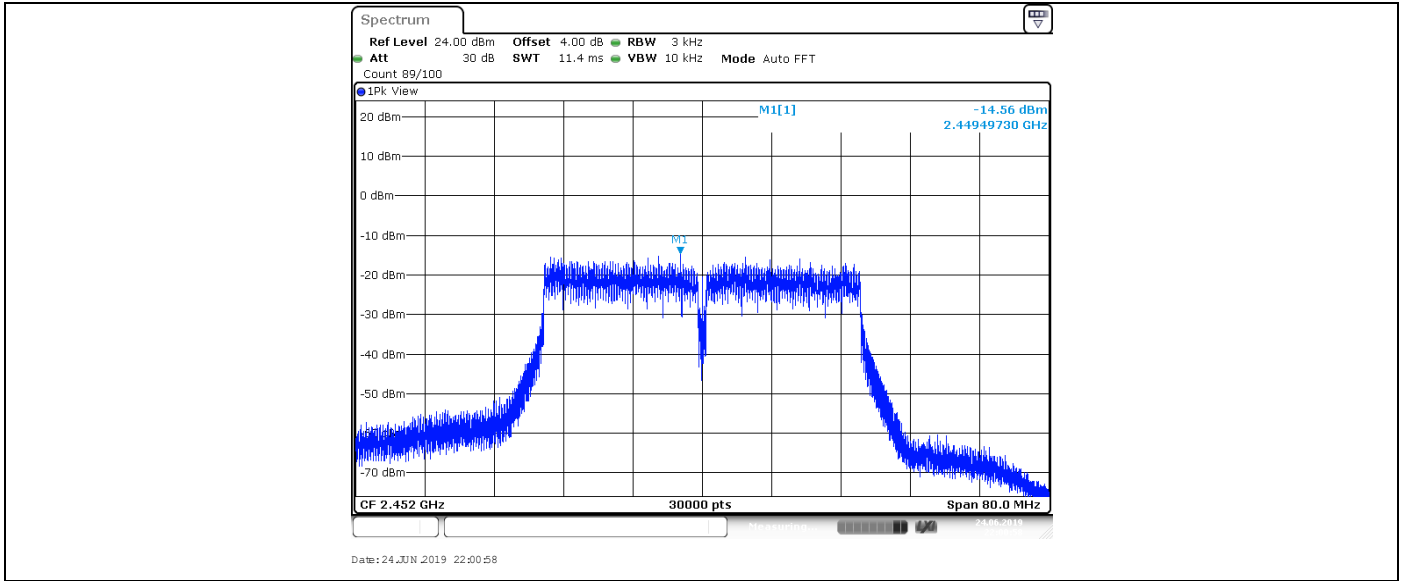

## 9.4 Spurious RF conducted emissions

### Test Method

1. The RF output of EUT was connected to the spectrum analyzer by RF cable. The path loss was compensated to the results for each measurement.
2. Use the following spectrum analyzer settings:  
Span = wide enough to capture the peak level of the in-band emission and all spurious emissions (e.g., harmonics) from the lowest frequency generated in the EUT up through the 10<sup>th</sup> harmonic. Typically, several plots are required to cover this entire span.  
RBW = 100 kHz, VBW ≥ RBW, Sweep = auto, Detector function = peak, Trace = max hold
3. Allow the trace to stabilize. Set the marker on the peak of any spurious emission recorded.
4. The level displayed must comply with the limit specified in this Section. Submit these plots.
5. Repeat above procedures until all frequencies measured were complete.

### Limit

Frequency Range MHz	Limit (dBc)
30-25000	-20



**Spurious RF conducted emissions**

TestMode	Antenna	Channel (MHz)	FreqRange (MHz)	RefLevel	Result (dBm)	Limit (dBm)	Verdict
11B_SISO	Ant0	2412	Reference	4.43	4.43	---	PASS
		2412	30~1000	30~1000	-69.01	<=-15.57	PASS
		2412	1000~26500	1000~26500	-52.81	<=-15.57	PASS
	Ant1	2412	Reference	3.52	3.52	---	PASS
		2412	30~1000	30~1000	-69.05	<=-16.48	PASS
		2412	1000~26500	1000~26500	-52.7	<=-16.48	PASS
	Ant0	2437	Reference	4.54	4.54	---	PASS
		2437	30~1000	30~1000	-68.39	<=-15.46	PASS
		2437	1000~26500	1000~26500	-53.39	<=-15.46	PASS
	Ant1	2437	Reference	0.78	0.78	---	PASS
		2437	30~1000	30~1000	-68.49	<=-19.22	PASS
		2437	1000~26500	1000~26500	-53.04	<=-19.22	PASS
	Ant0	2462	Reference	4.53	4.53	---	PASS
		2462	30~1000	30~1000	-68.94	<=-15.47	PASS
		2462	1000~26500	1000~26500	-52.99	<=-15.47	PASS
	Ant1	2462	Reference	3.45	3.45	---	PASS
		2462	30~1000	30~1000	-69.18	<=-16.55	PASS
		2462	1000~26500	1000~26500	-52.74	<=-16.55	PASS
11G_SISO	Ant0	2412	Reference	1.56	1.56	---	PASS
		2412	30~1000	30~1000	-68.75	<=-18.44	PASS
		2412	1000~26500	1000~26500	-53.61	<=-18.44	PASS
	Ant1	2412	Reference	2.91	2.91	---	PASS
		2412	30~1000	30~1000	-68.45	<=-17.09	PASS
		2412	1000~26500	1000~26500	-53.1	<=-17.09	PASS
	Ant0	2437	Reference	1.31	1.31	---	PASS
		2437	30~1000	30~1000	-68.64	<=-18.69	PASS
		2437	1000~26500	1000~26500	-52.79	<=-18.69	PASS
	Ant1	2437	Reference	0.02	0.02	---	PASS
		2437	30~1000	30~1000	-68.57	<=-19.98	PASS
		2437	1000~26500	1000~26500	-53.17	<=-19.98	PASS
	Ant0	2462	Reference	2.34	2.34	---	PASS
		2462	30~1000	30~1000	-68.88	<=-17.66	PASS
		2462	1000~26500	1000~26500	-52.06	<=-17.66	PASS
	Ant1	2462	Reference	3.08	3.08	---	PASS
		2462	30~1000	30~1000	-68.61	<=-16.92	PASS
		2462	1000~26500	1000~26500	-53.03	<=-16.92	PASS
11N20	Ant0 (NOTE)	2412	Reference	4.05	4.05	---	PASS
		2412	30~1000	30~1000	-65.42	<=-15.95	PASS
		2412	1000~26500	1000~26500	-49.63	<=-15.95	PASS
		2437	Reference	0.31	0.31	---	PASS
		2437	30~1000	30~1000	-65.91	<=-19.69	PASS
		2437	1000~26500	1000~26500	-49.41	<=-19.69	PASS
		2462	Reference	3.53	3.53	---	PASS
		2462	30~1000	30~1000	-65.53	<=-16.47	PASS
11N40	Ant0 (NOTE)	2422	Reference	0.40	0.40	---	PASS
		2422	30~1000	30~1000	-65.62	<=-19.6	PASS
		2422	1000~26500	1000~26500	-50.5	<=-19.6	PASS
		2437	Reference	-1.20	-1.20	---	PASS
		2437	30~1000	30~1000	-65.05	<=-21.2	PASS
		2437	1000~26500	1000~26500	-48.96	<=-21.2	PASS
		2452	Reference	-0.11	-0.11	---	PASS
		2452	30~1000	30~1000	-65.7	<=-20.11	PASS
		2452	1000~26500	1000~26500	-49.78	<=-20.11	PASS

NOTE: We test Ant0 and Ant1 separately, only the WORSE case recorded in this report.

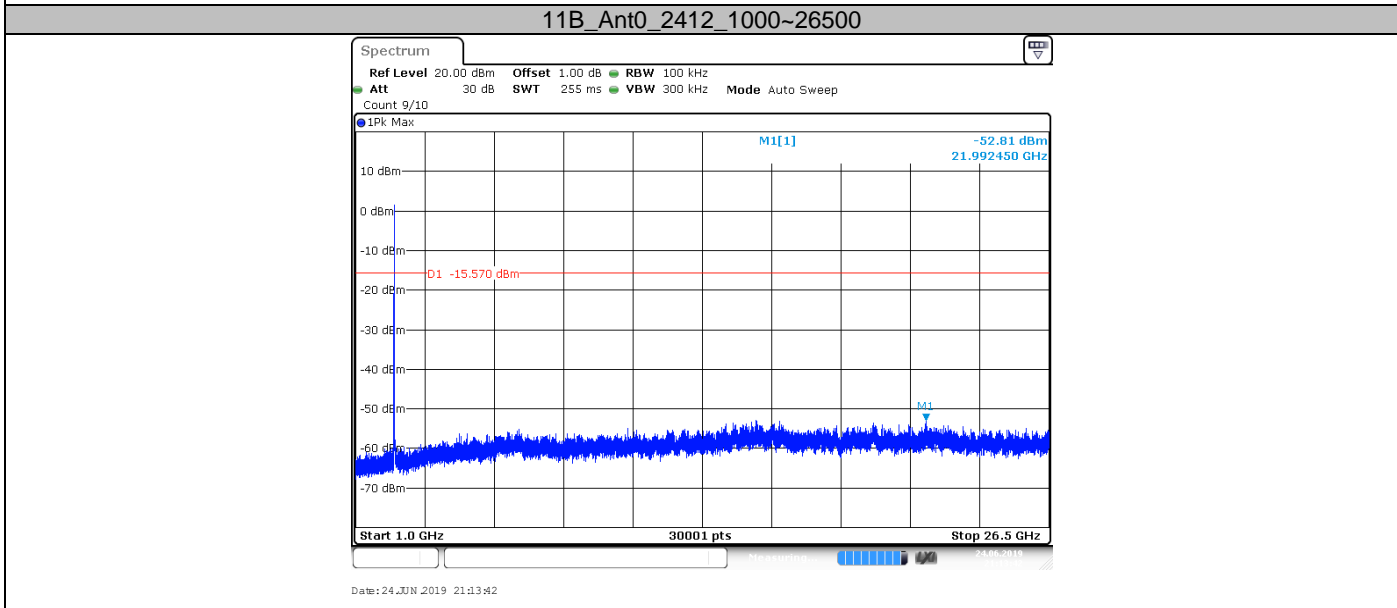
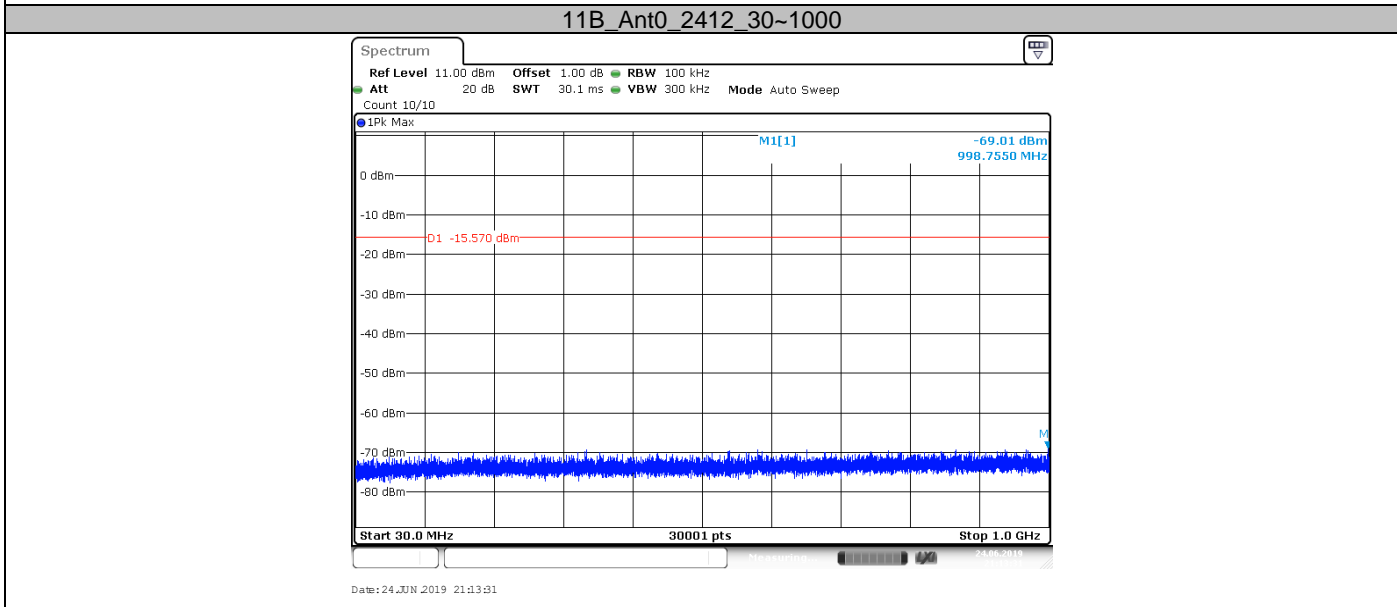
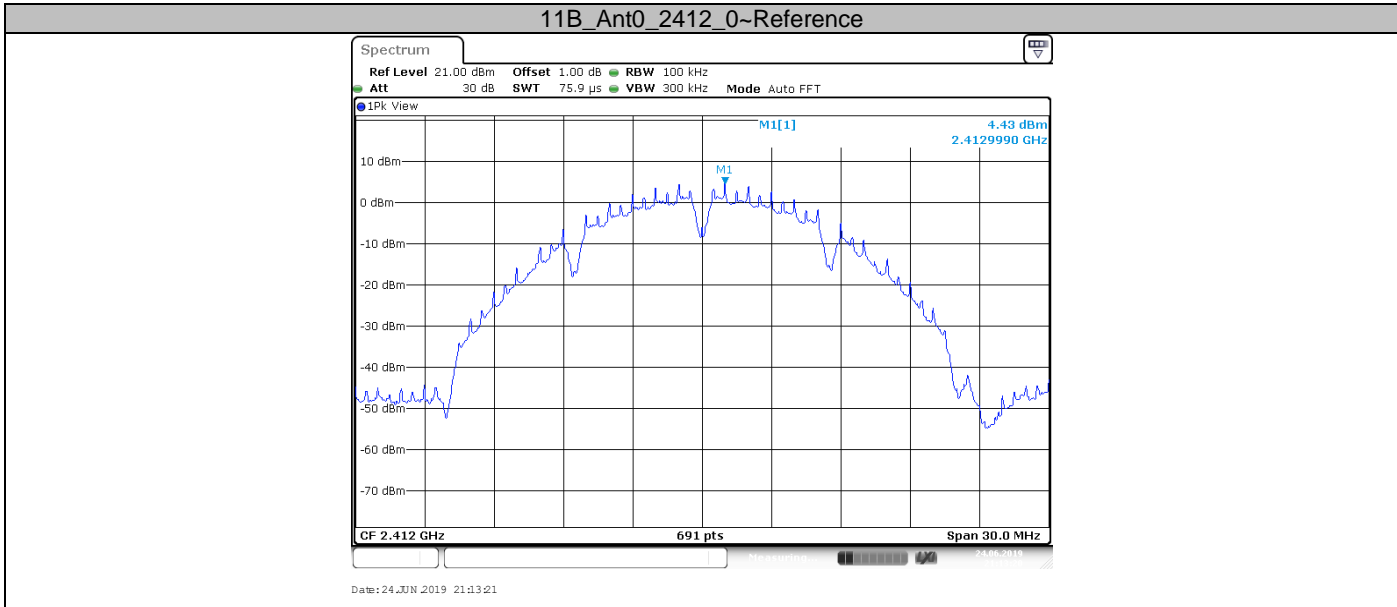

### 11B\_Ant1\_2412\_0~Reference

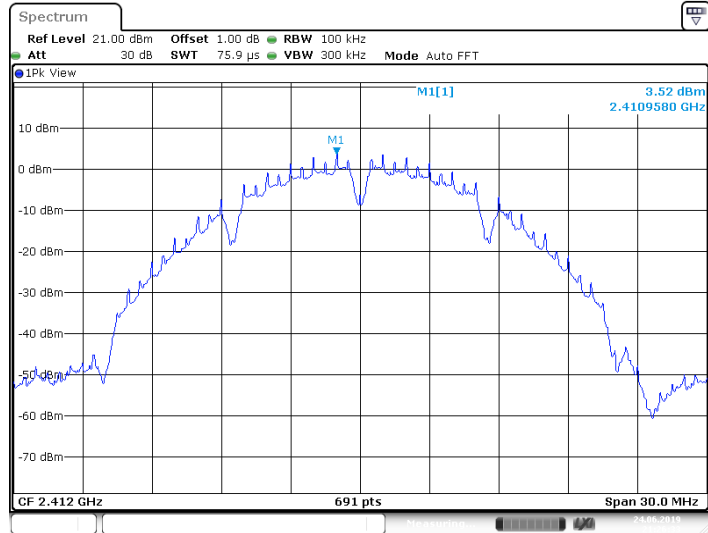

### 11B\_Ant1\_2412\_30~1000

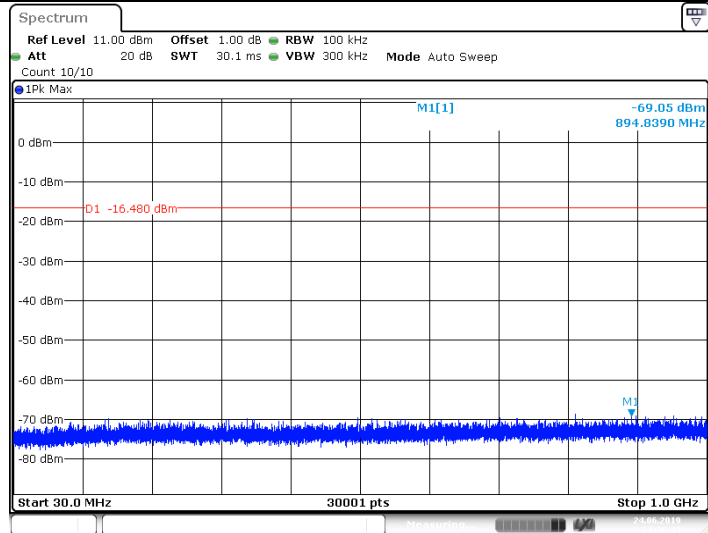

### 11B\_Ant1\_2412\_1000~26500

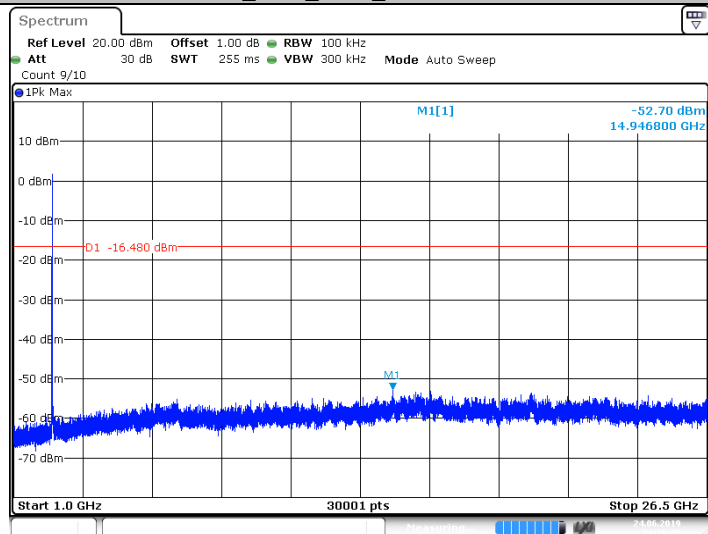

### 11B\_Ant0\_2437\_0~Reference

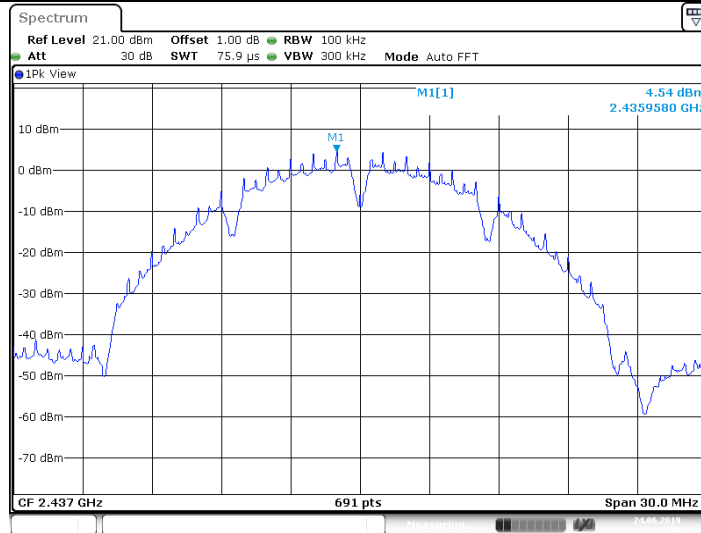

Date: 24 JUN 2019 21:15:08

11B\_Ant0\_2437\_30~1000

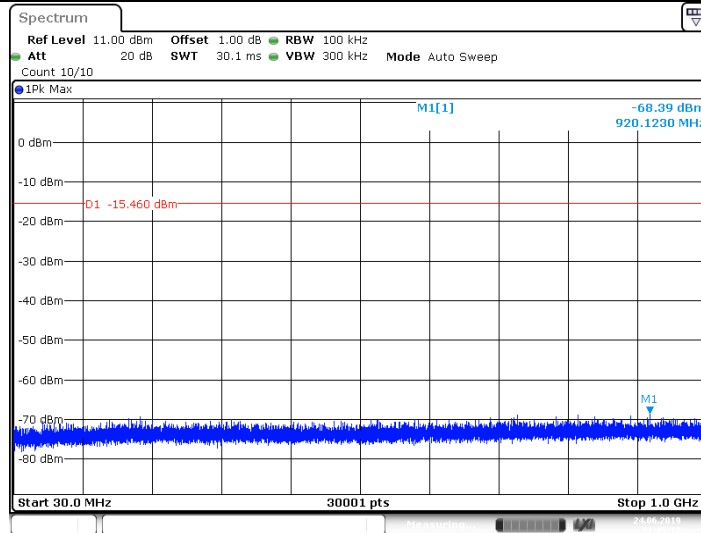

Date: 24 JUN 2019 21:15:18

11B\_Ant0\_2437\_1000~26500

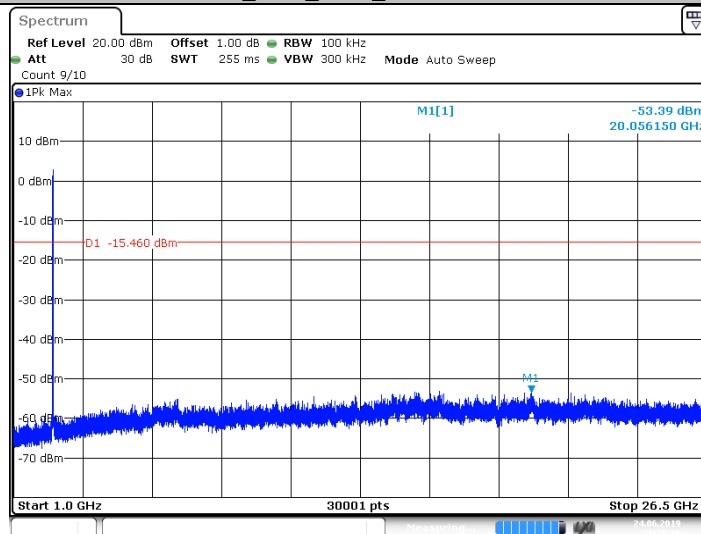

Date: 24 JUN 2019 21:15:29

11B\_Ant1\_2437\_0~Reference

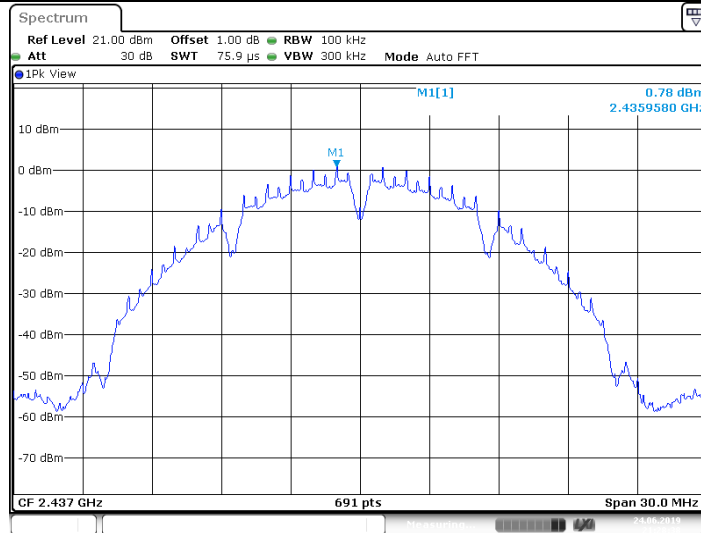

Date: 24 JUN 2019 21:28:38

11B\_Ant1\_2437\_30~1000

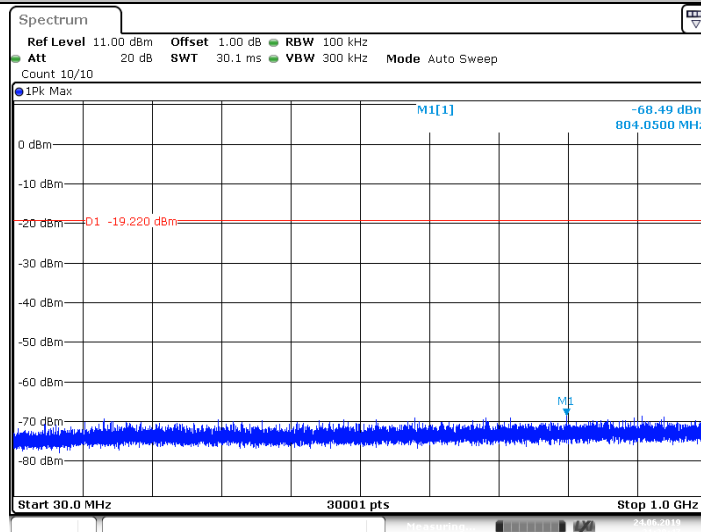

Date: 24 JUN 2019 21:28:48

11B\_Ant1\_2437\_1000~26500

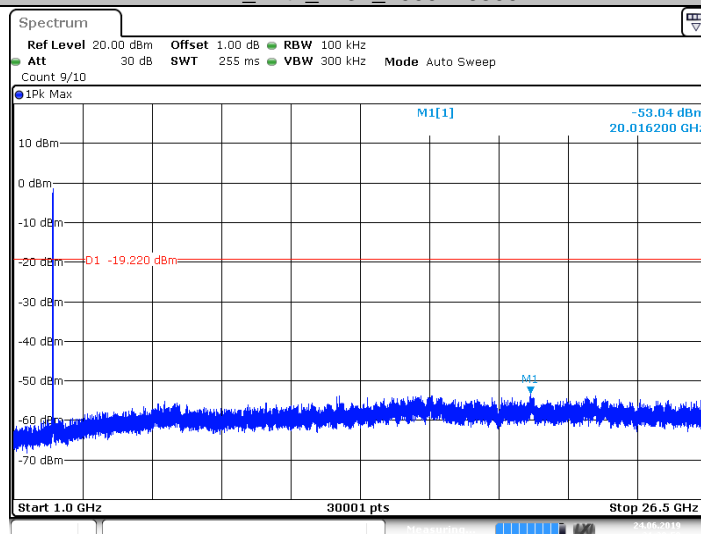

Date: 24 JUN 2019 21:28:59

11B\_Ant0\_2462\_0~Reference



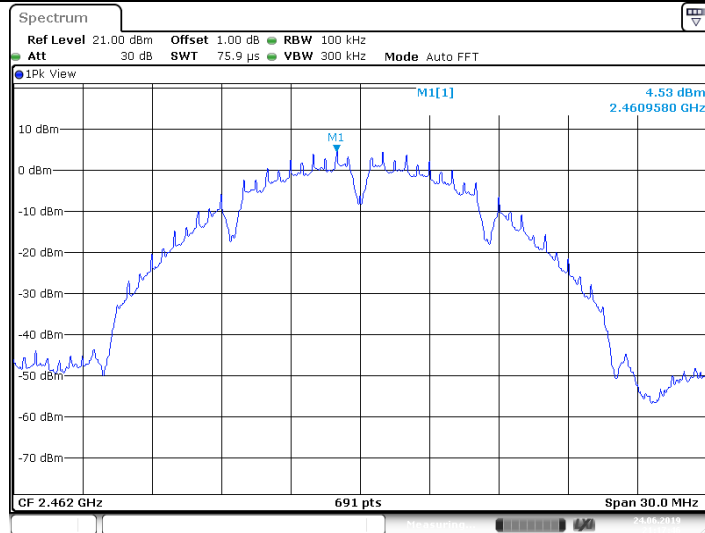

11B\_Ant0\_2462\_30~1000

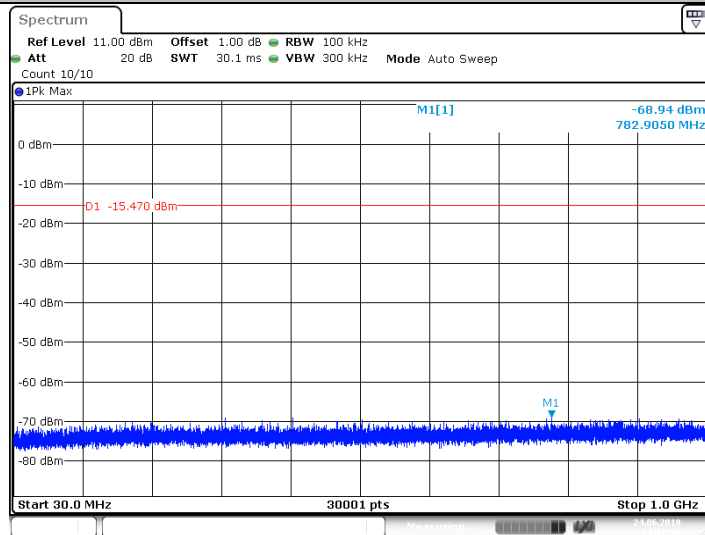

11B\_Ant0\_2462\_1000~26500

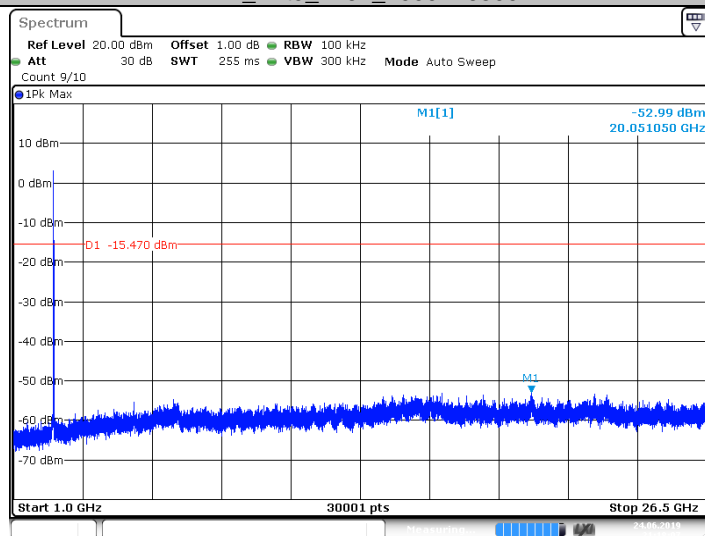

11B\_Ant1\_2462\_0~Reference

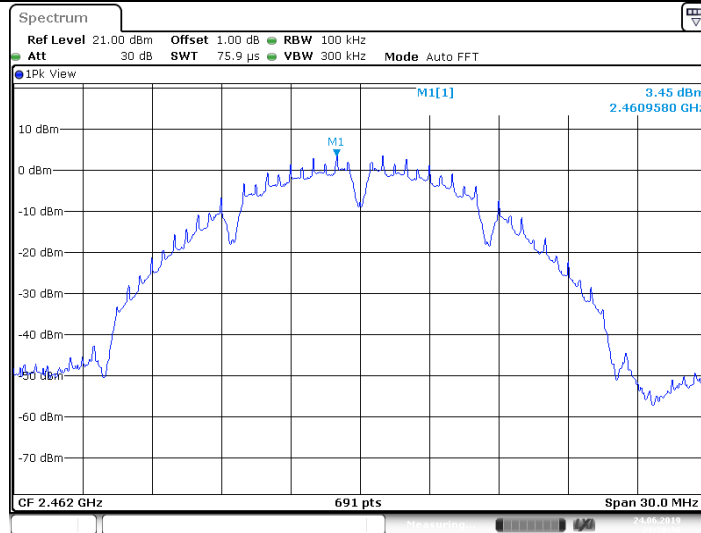

Date: 24 JUN 2019 21:30:36

11B\_Ant1\_2462\_30~1000

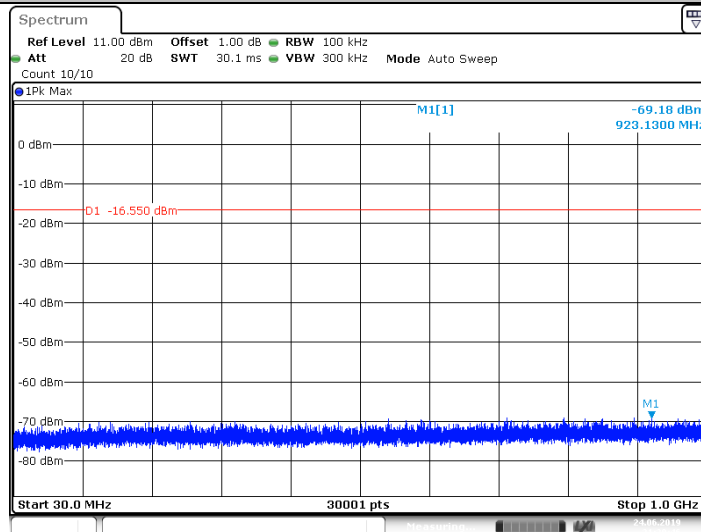

Date: 24 JUN 2019 21:30:46

11B\_Ant1\_2462\_1000~26500

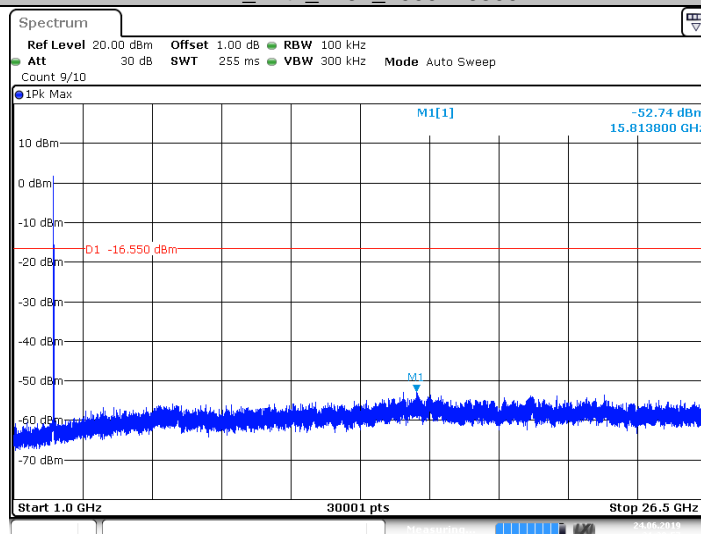

Date: 24 JUN 2019 21:30:57

11G\_Ant0\_2412\_0~Reference

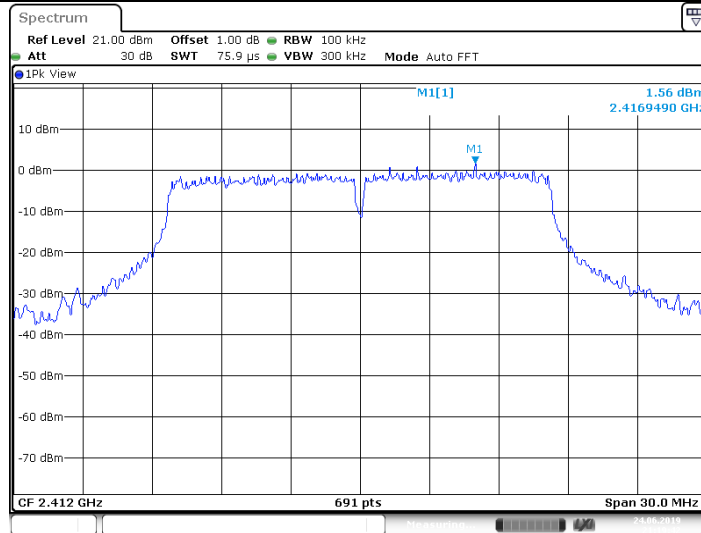

Date: 24 JUN 2019 21:19:42

11G\_Ant0\_2412\_30~1000

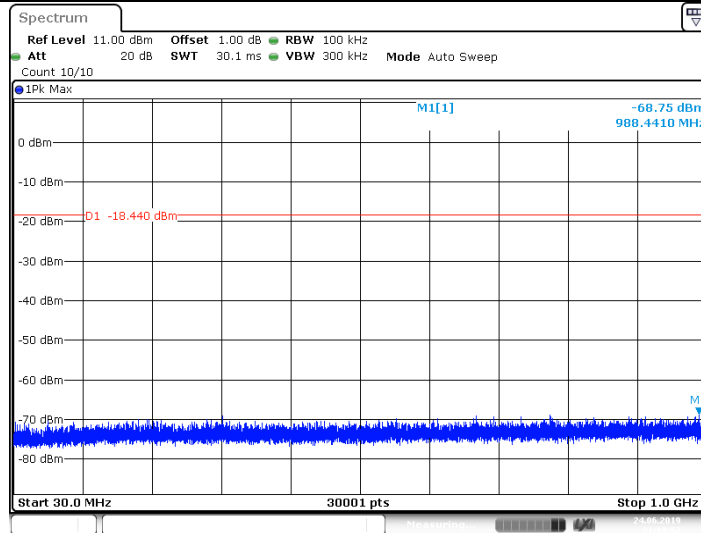

Date: 24 JUN 2019 21:19:52

11G\_Ant0\_2412\_1000~26500

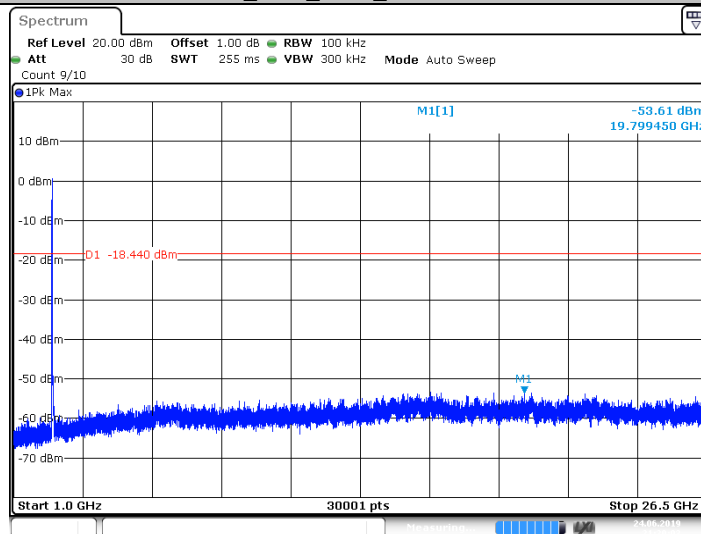

Date: 24 JUN 2019 21:20:03

11G\_Ant1\_2412\_0~Reference

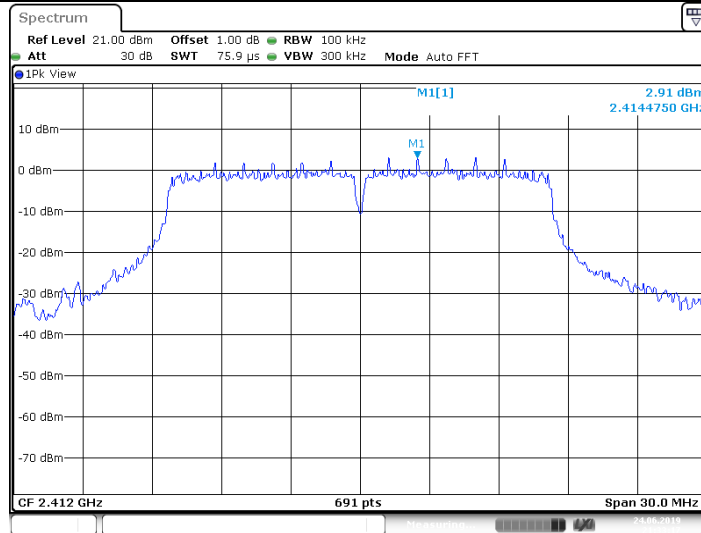

Date: 24 JUN 2019 21:33:17

11G\_Ant1\_2412\_30~1000

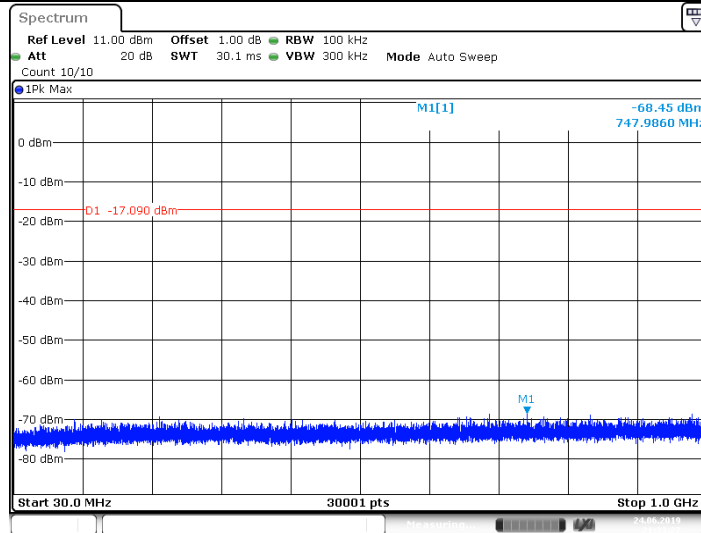

Date: 24 JUN 2019 21:33:27

11G\_Ant1\_2412\_1000~26500

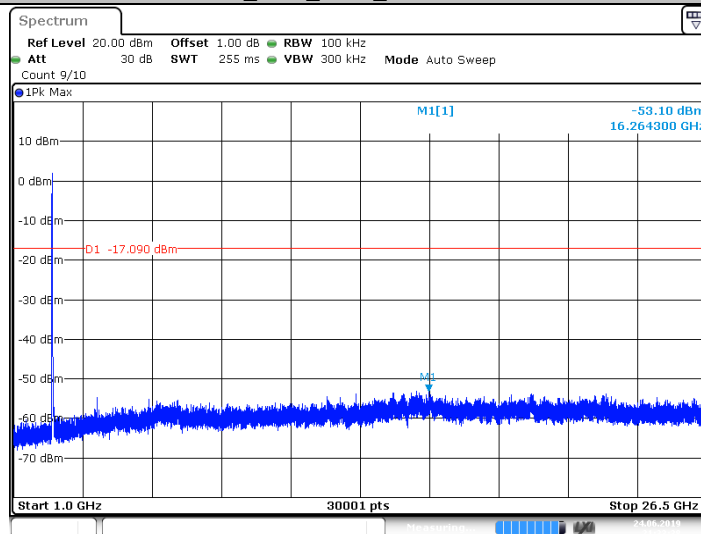

Date: 24 JUN 2019 21:33:39

11G\_Ant0\_2437\_0~Reference

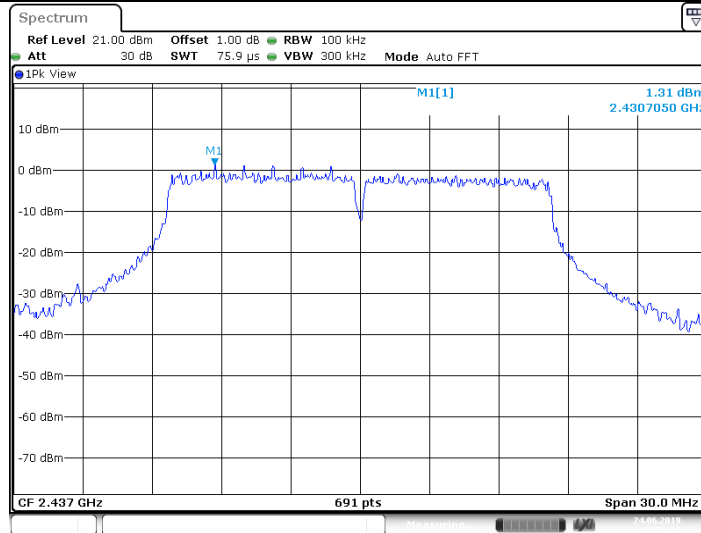

Date: 24 JUN 2019 21:21:22

11G\_Ant0\_2437\_30~1000

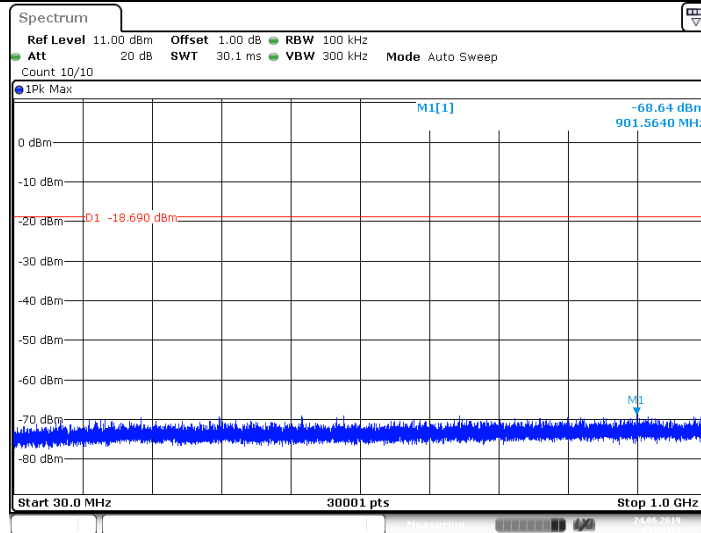

Date: 24 JUN 2019 21:21:31

11G\_Ant0\_2437\_1000~26500

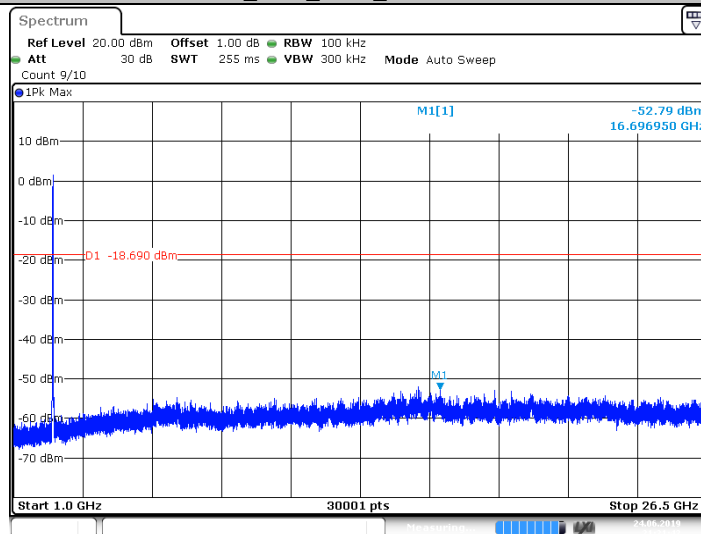

Date: 24 JUN 2019 21:21:43

11G\_Ant1\_2437\_0~Reference

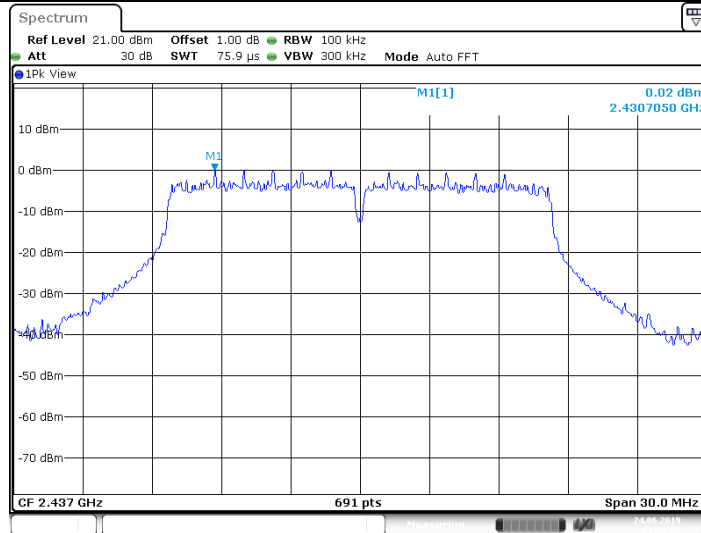

11G\_Ant1\_2437\_30~1000

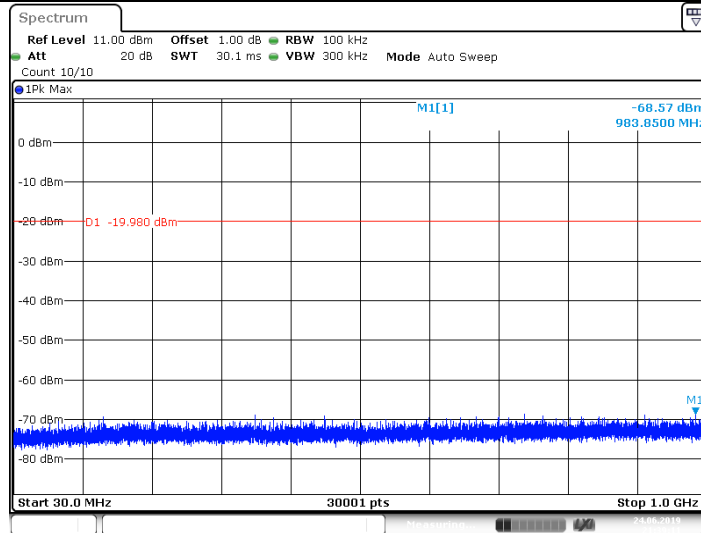

11G\_Ant1\_2437\_1000~26500

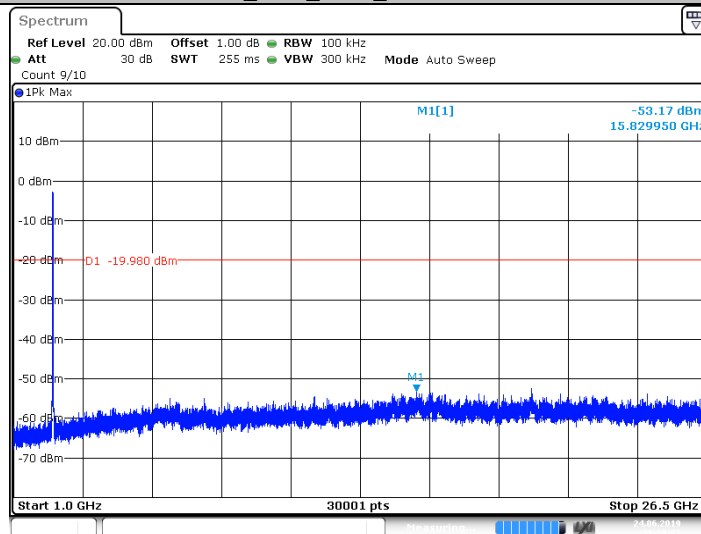

11G\_Ant0\_2462\_0~Reference

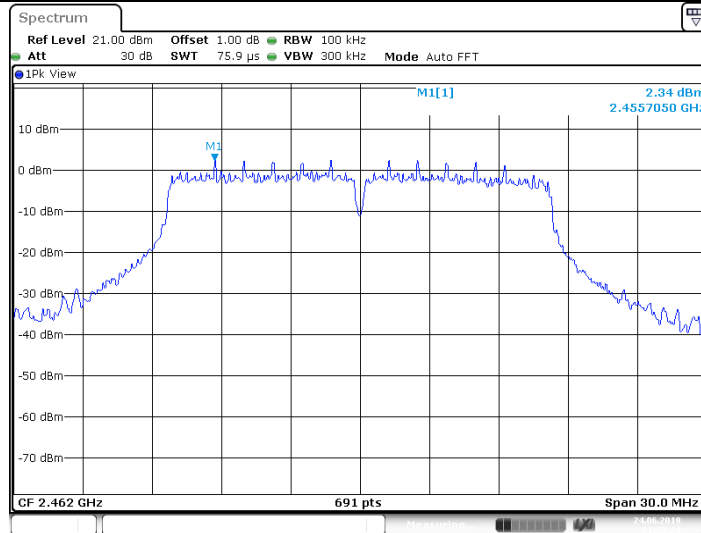

Date: 24 JUN 2019 21:23:24

11G\_Ant0\_2462\_30~1000

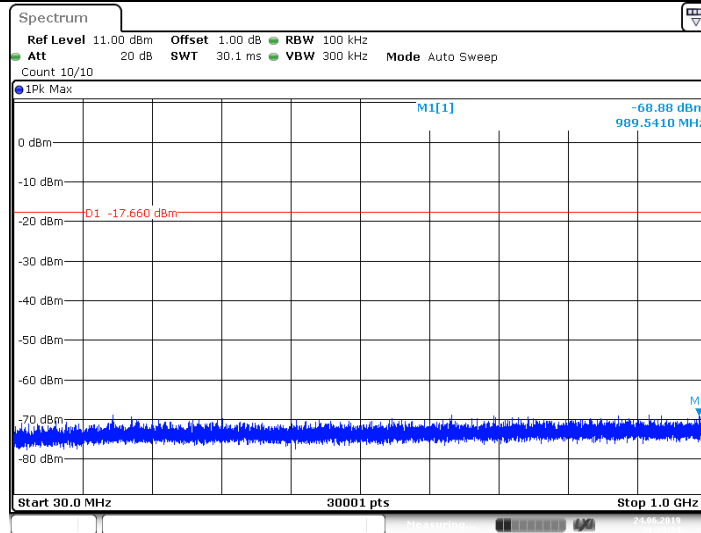

Date: 24 JUN 2019 21:23:34

11G\_Ant0\_2462\_1000~26500

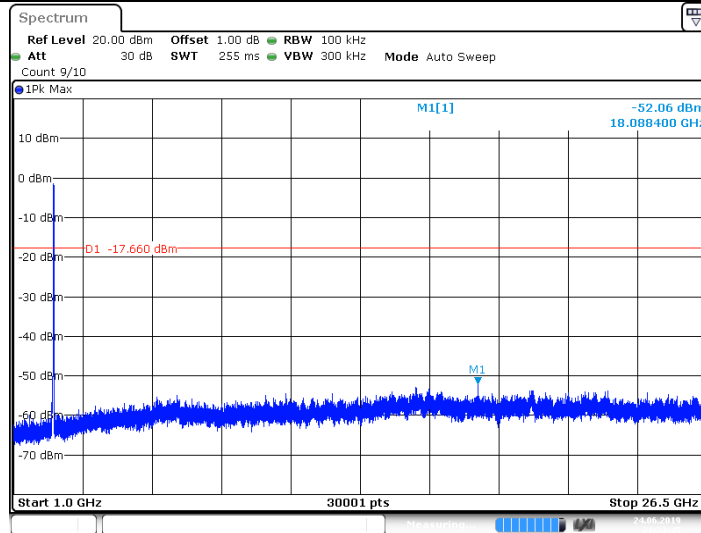

Date: 24 JUN 2019 21:23:45

11G\_Ant1\_2462\_0~Reference

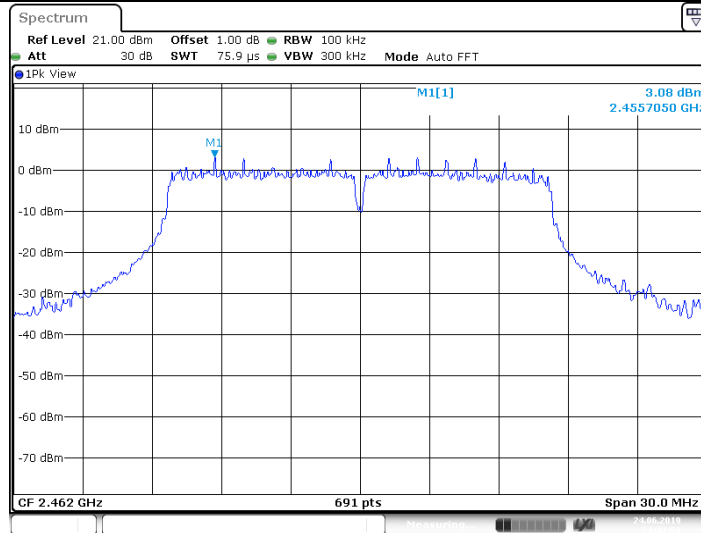

Date: 24 JUN 2019 21:42:00

11G\_Ant1\_2462\_30~1000

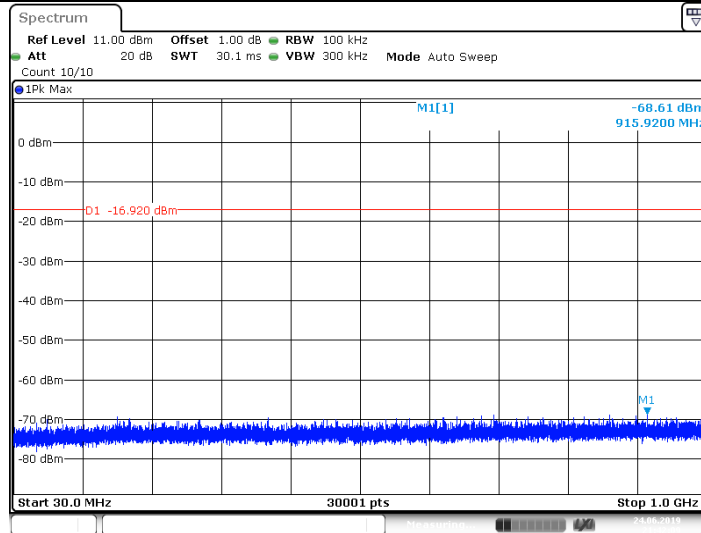

Date: 24 JUN 2019 21:42:09

11G\_Ant1\_2462\_1000~26500

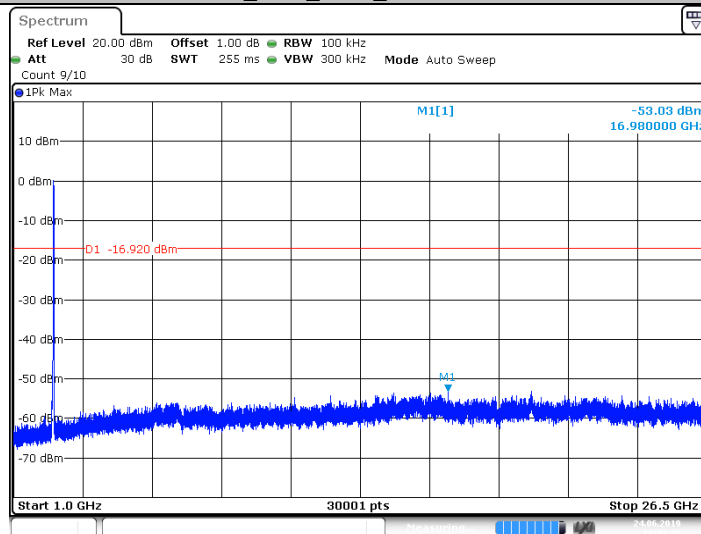

Date: 24 JUN 2019 21:42:21

11N20\_Ant0\_2412\_0~Reference



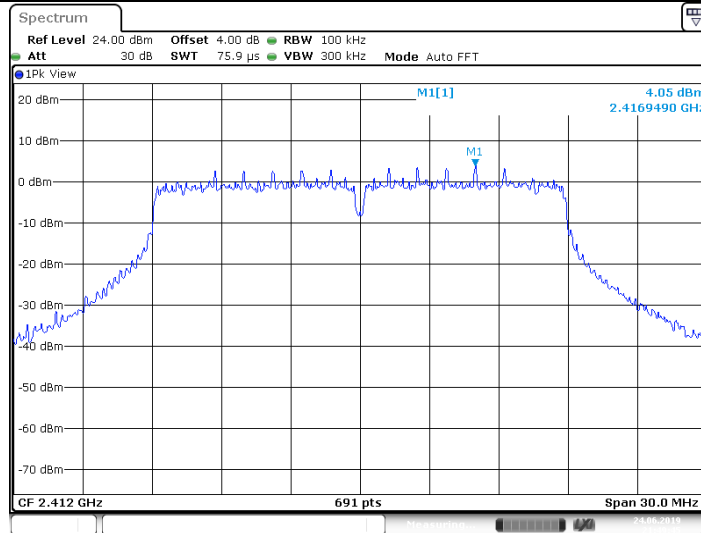

Date: 24 JUN 2019 21:49:55

11N20\_Ant0\_2412\_30~1000

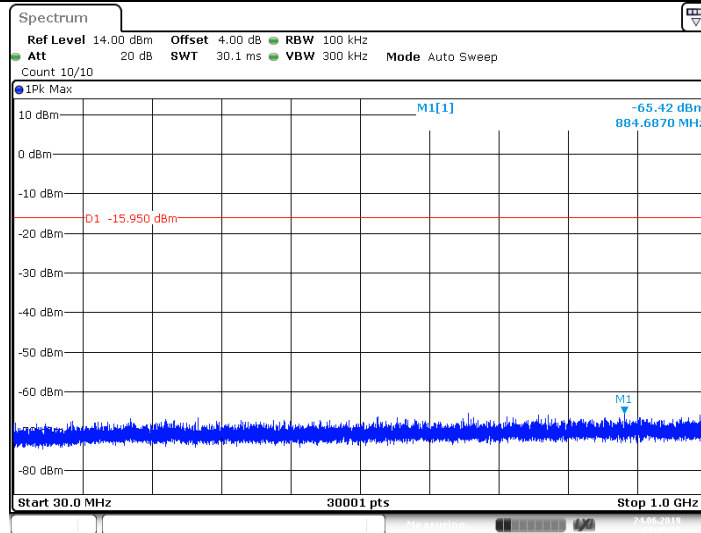

Date: 24 JUN 2019 21:49:55

11N20\_Ant0\_2412\_1000~26500

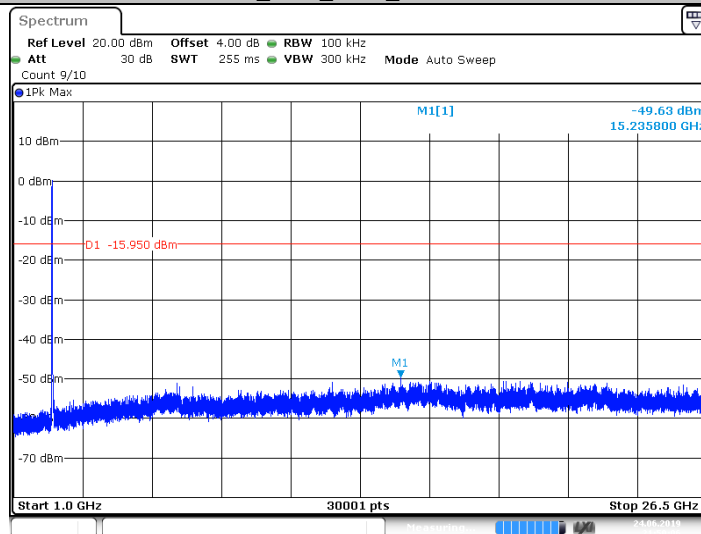

Date: 24 JUN 2019 21:50:06

11N20\_Ant0\_2437\_0~Reference

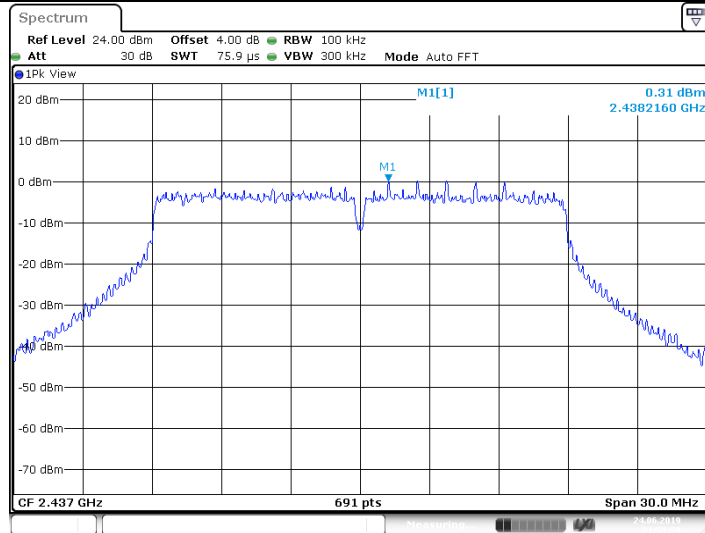

11N20\_Ant0\_2437\_30~1000

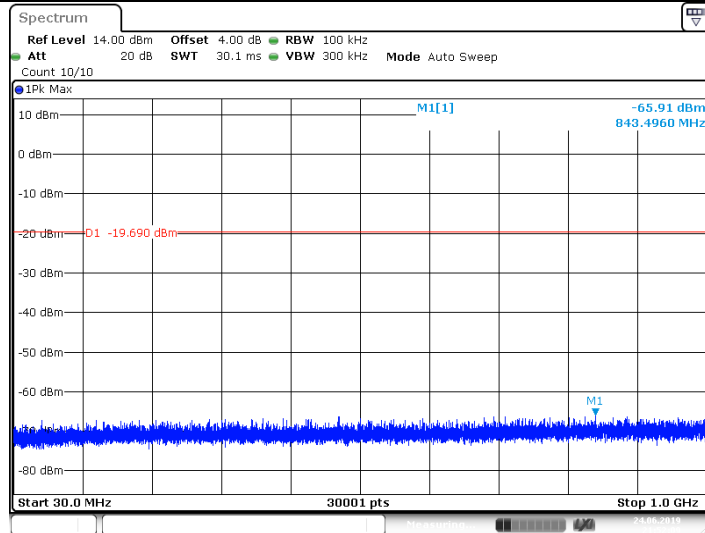

11N20\_Ant0\_2437\_1000~26500

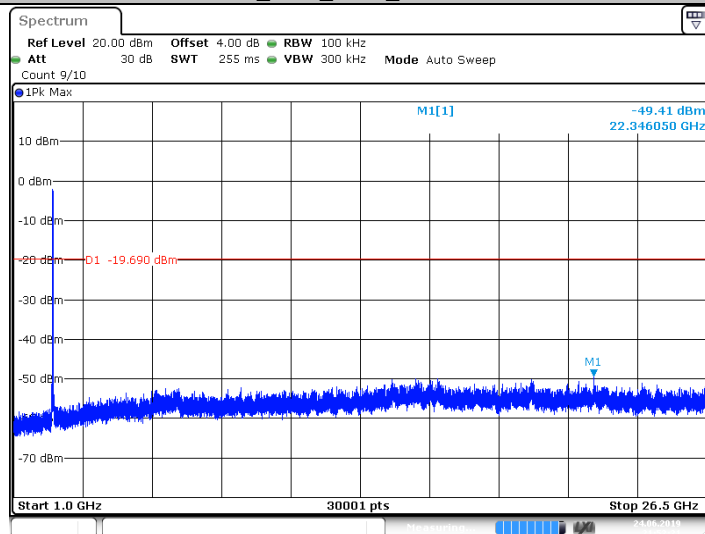

11N20\_Ant0\_2462\_0~Reference

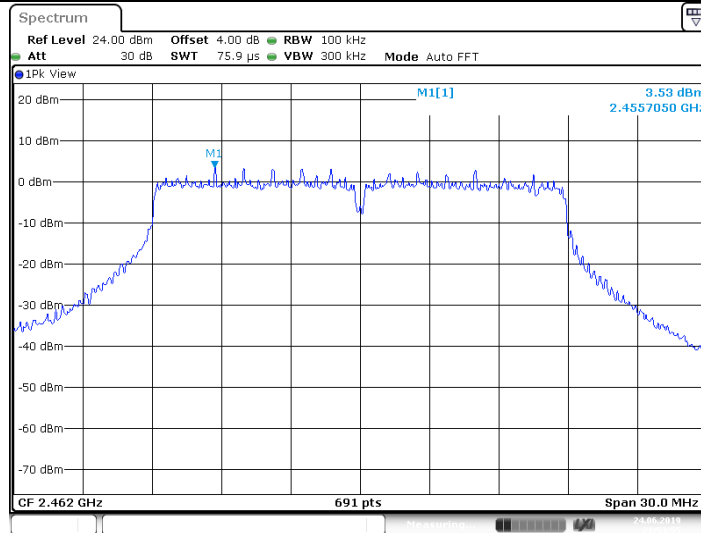

11N20\_Ant0\_2462\_30~1000

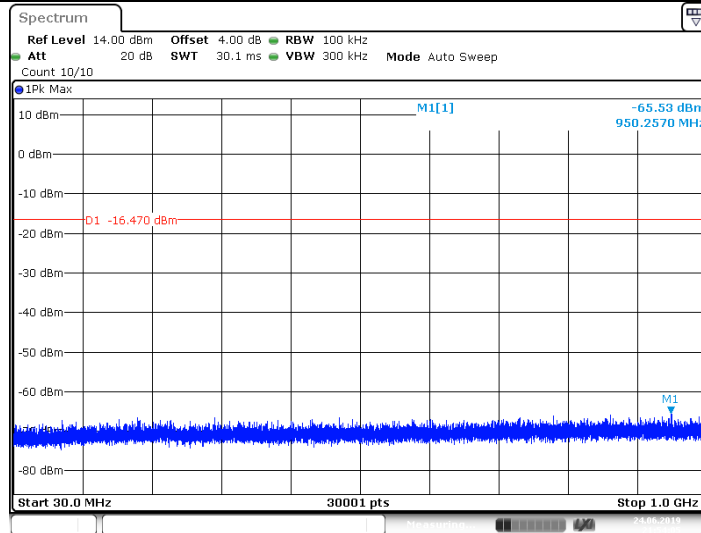

11N20\_Ant0\_2462\_1000~26500

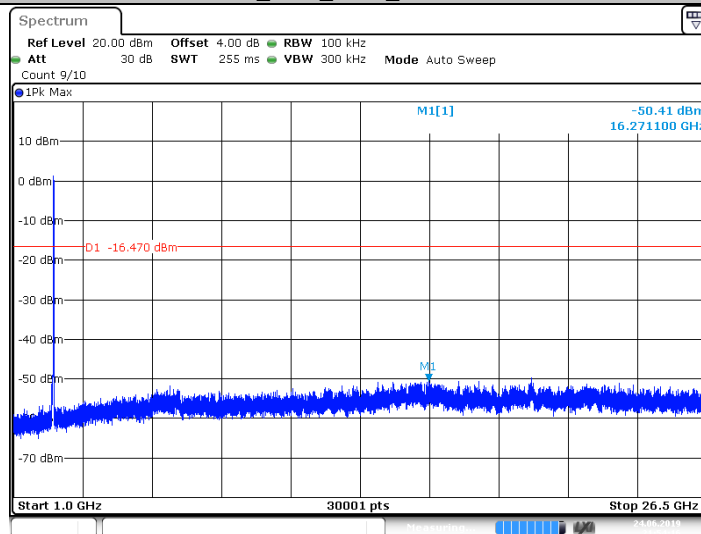

11N40\_Ant0\_2422\_0~Reference

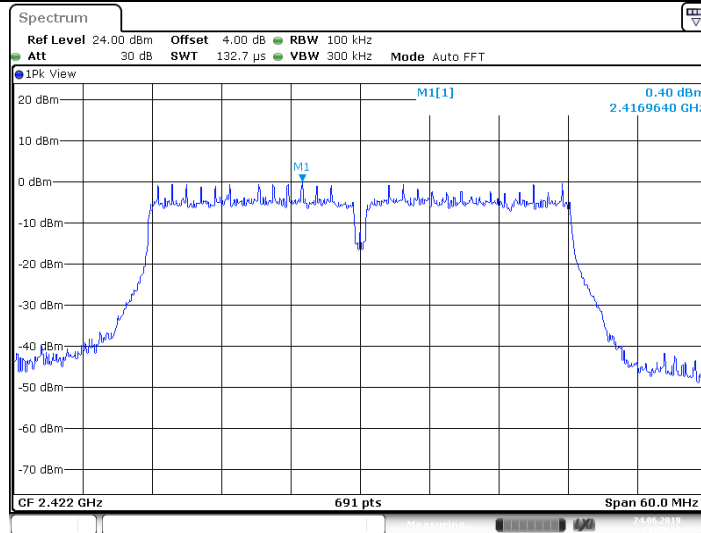

11N40\_Ant0\_2422\_30~1000

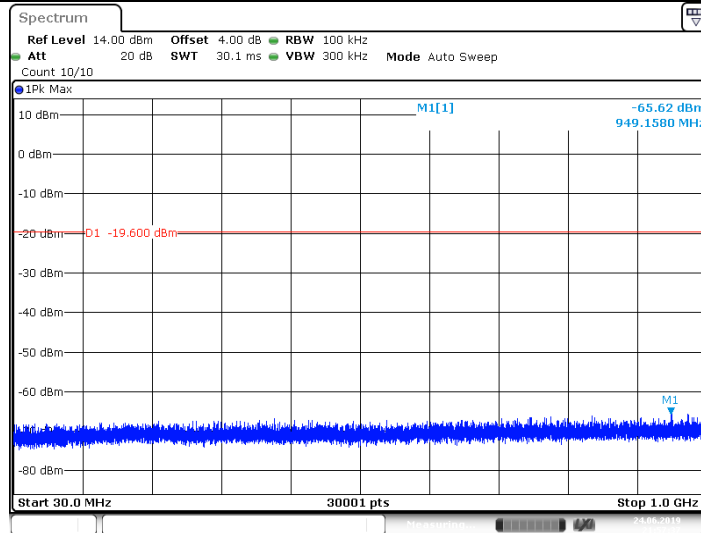

11N40\_Ant0\_2422\_1000~26500

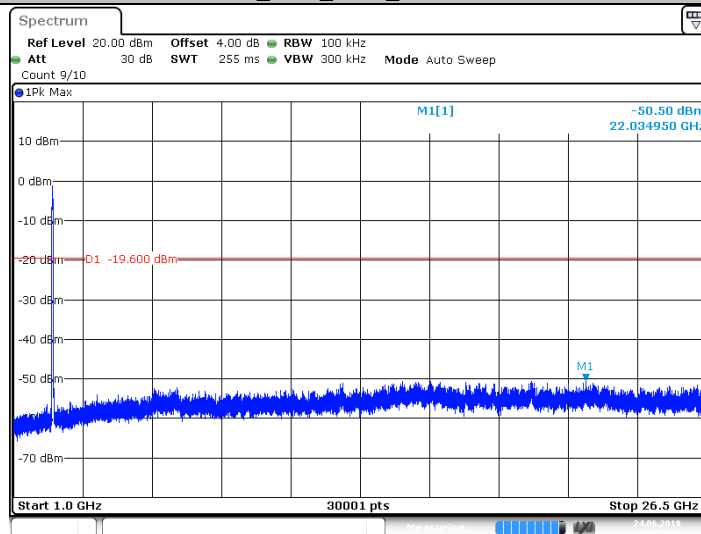

11N40\_Ant0\_2437\_0~Reference

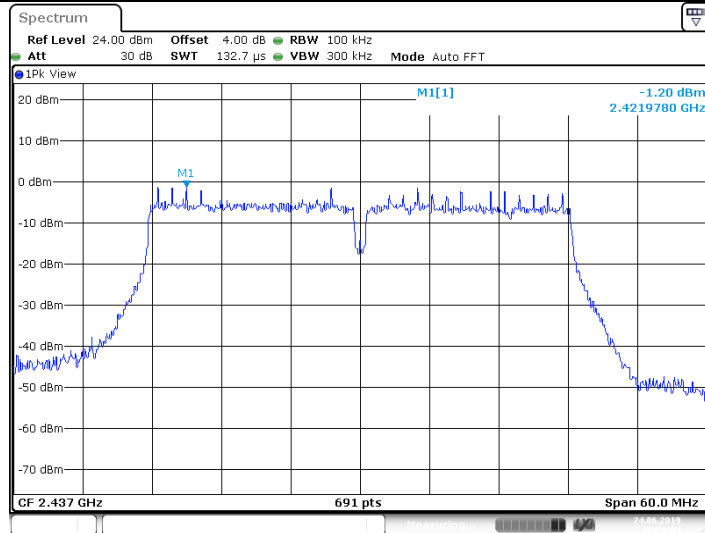

Date: 24 JUN 2019 21:59:04

11N40\_Ant0\_2437\_30~1000

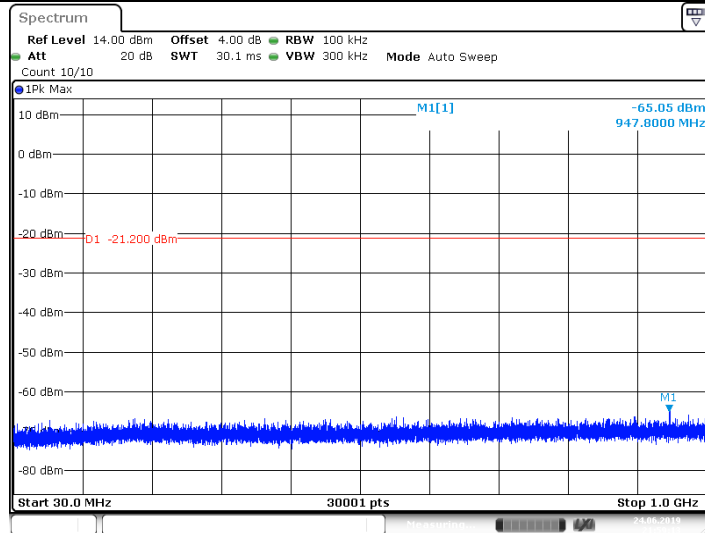

Date: 24 JUN 2019 21:59:14

11N40\_Ant0\_2437\_1000~26500

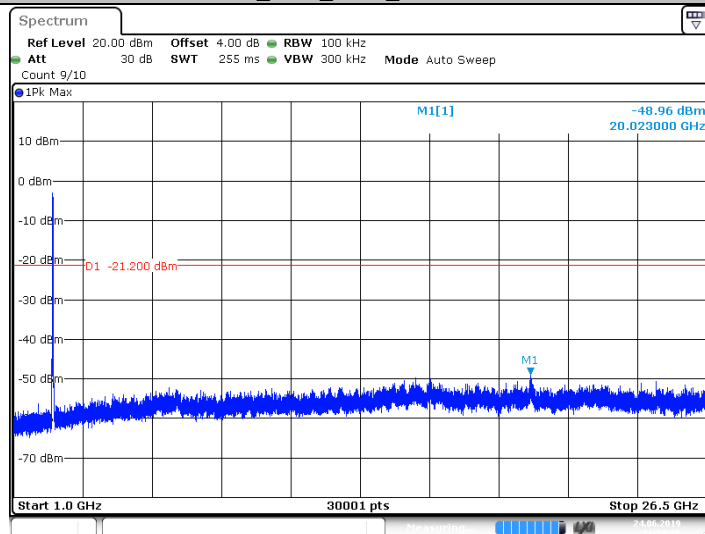

Date: 24 JUN 2019 21:59:25

11N40\_Ant0\_2452\_0~Reference

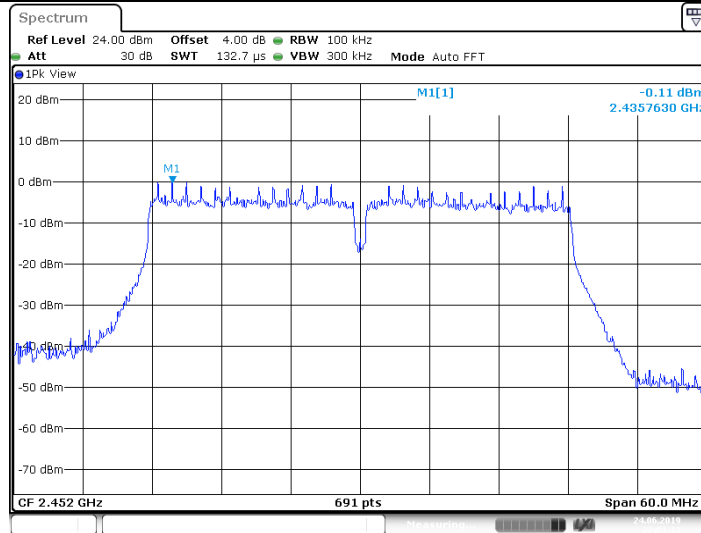

11N40\_Ant0\_2452\_30~1000

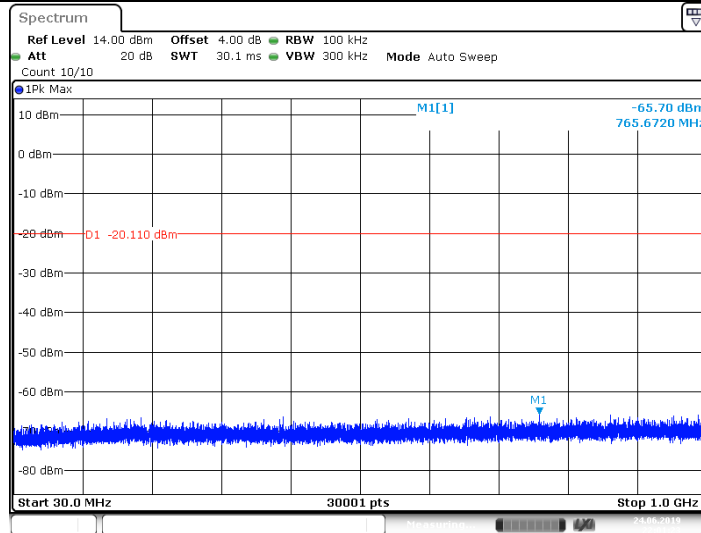

11N40\_Ant0\_2452\_1000~26500

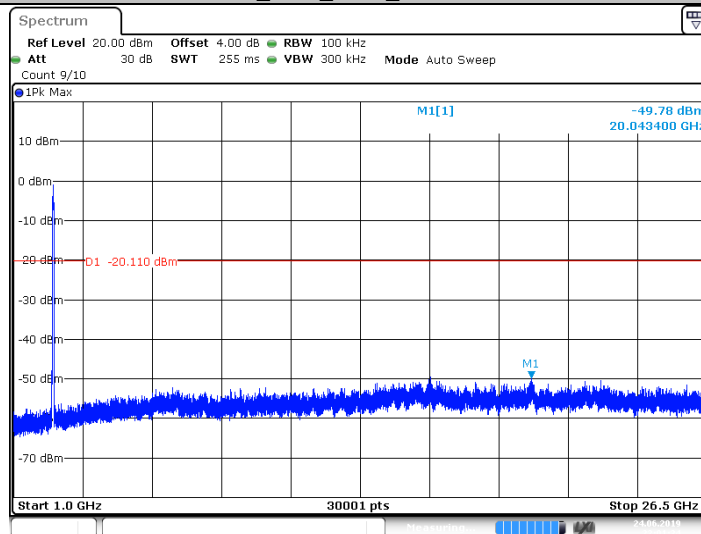

## 9.5 Band edge testing

### Test Method

1. The RF output of EUT was connected to the spectrum analyzer by RF cable. The path loss was compensated to the results for each measurement.
2. Use the following spectrum analyzer settings:  
Span = wide enough to capture the peak level of the in-band emission and all spurious  
RBW = 100 kHz, VBW  $\geq$  RBW, Sweep = auto, Detector function = peak, Trace = max hold
3. Allow the trace to stabilize, use the peak and delta measurement to record the result.
4. The level displayed must comply with the limit specified in this Section.
5. Repeat the test at the hopping off and hopping on mode, submit all the plots.

### Limit:

According to §15.247(d), in any 100 kHz bandwidth outside the frequency bands in which the spread spectrum intentional radiator is operating, the radio frequency power that is produced by the intentional radiator shall be at least 20 dB below that in the 100 kHz bandwidth within the band that contains the highest level of the desired power, based on either an RF conducted or a radiated measurement, provided the transmitter demonstrates compliance with the peak conducted power limits. In addition, radiated emissions which fall in the restricted bands, as defined in §15.205(a), must also comply with the radiated emission limits specified in 15.209(a) (see Section 15.205(c)).

Frequency Range MHz	Limit (dBc)
30-25000	-20

### Band edge testing

TestMode	Antenna	ChName	Channel (MHz)	RefLevel (dBm)	Result (dBm)	Limit (dBm)	Verdict
11B_SISO	Ant0	Low	2412	4.65	-44.7	<=-15.35	PASS
	Ant1	Low	2412	3.63	-47.95	<=-16.37	PASS
	Ant0	High	2462	4.59	-58.5	<=-15.41	PASS
	Ant1	High	2462	3.52	-59.19	<=-16.48	PASS
11G_SISO	Ant0	Low	2412	1.83	-31.69	<=-18.17	PASS
	Ant1	Low	2412	0.18	-28.04	<=-19.82	PASS
	Ant0	High	2462	2.30	-46.83	<=-17.7	PASS
	Ant1	High	2462	1.06	-41.82	<=-18.94	PASS
11N20	Ant0	Low	2412	4.17	-30.97	<=-15.83	PASS
	(NOTE)	High	2462	4.06	-44.32	<=-15.94	PASS
11N40	Ant0	Low	2422	-0.37	-37.47	<=-20.37	PASS
	(NOTE)	High	2452	0.19	-48.26	<=-19.81	PASS

NOTE: We test Ant0 and Ant1 separately, only the WORSE case recorded in this report.

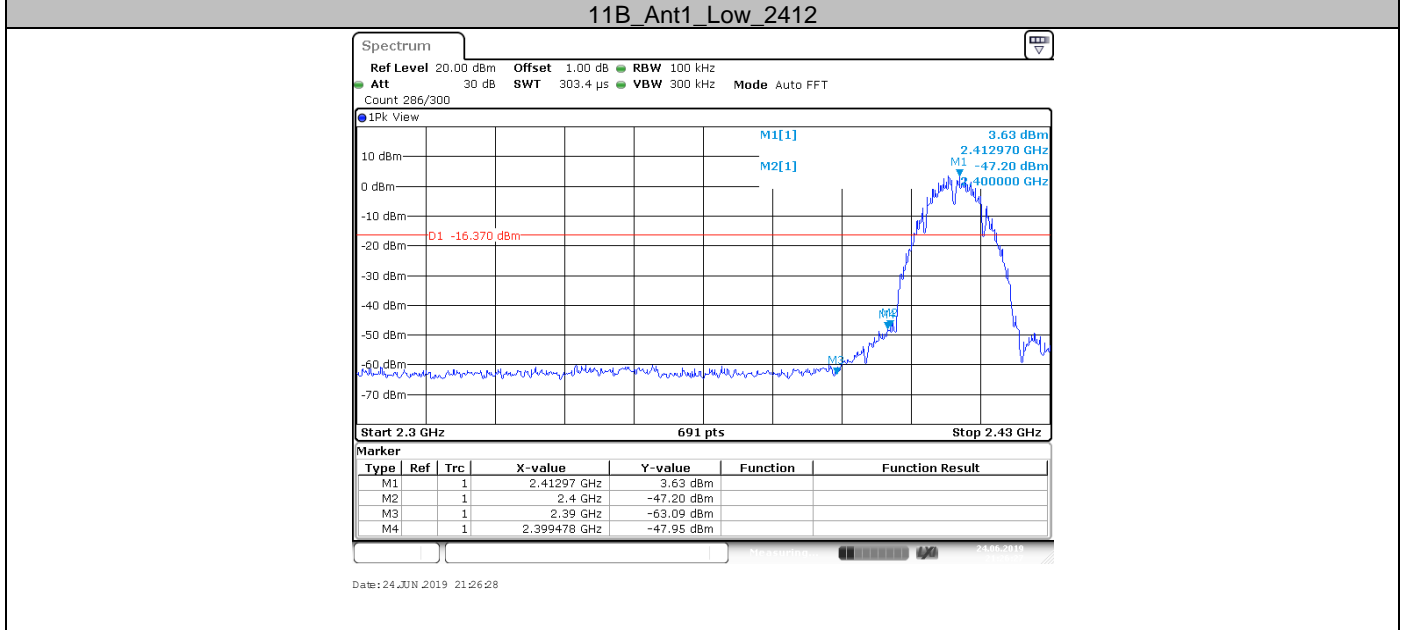
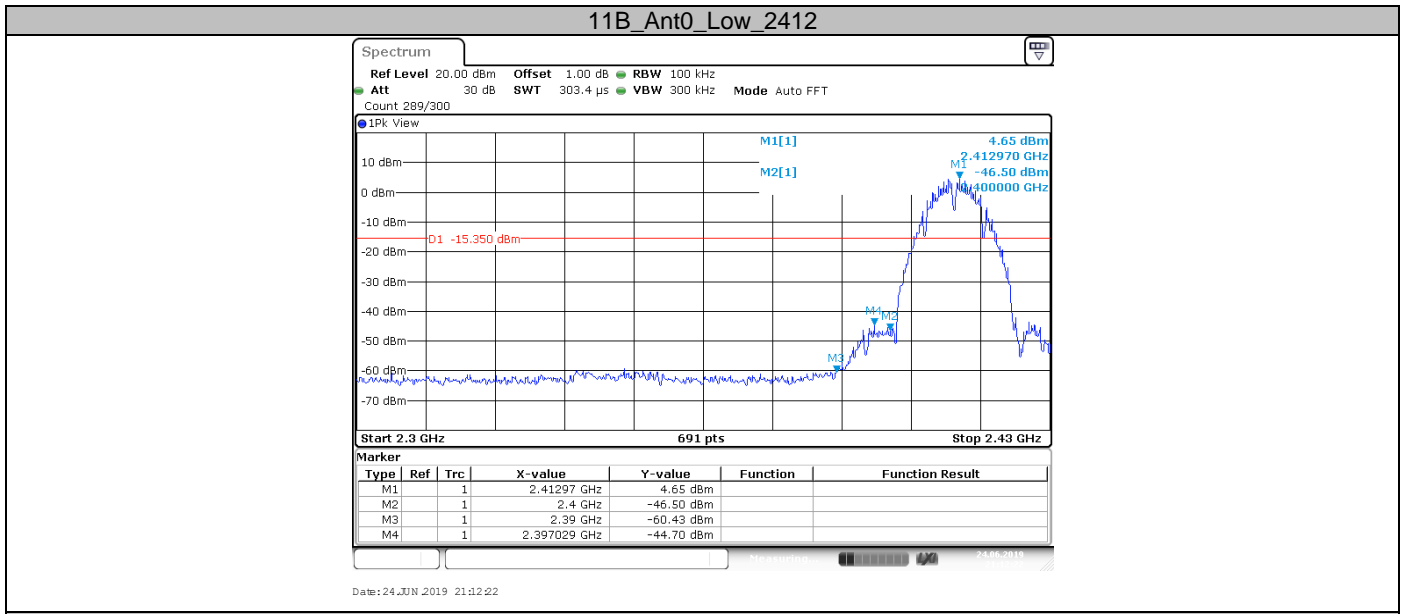



### 11B\_Ant0\_High\_2462

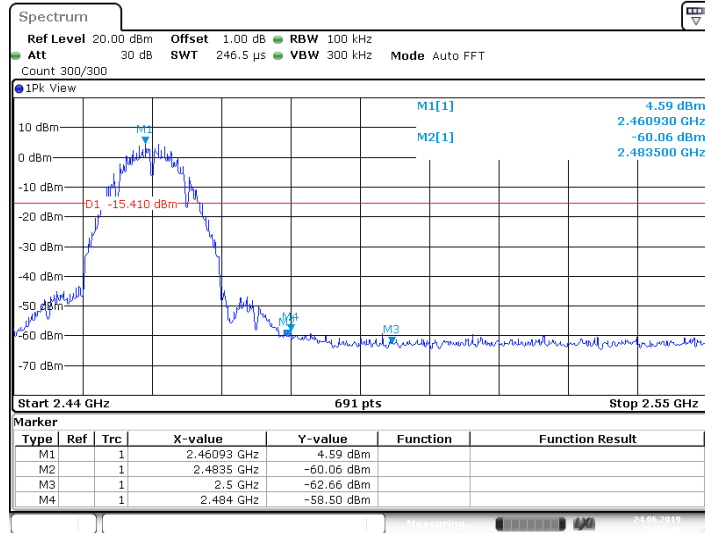

### 11B\_Ant1\_High\_2462

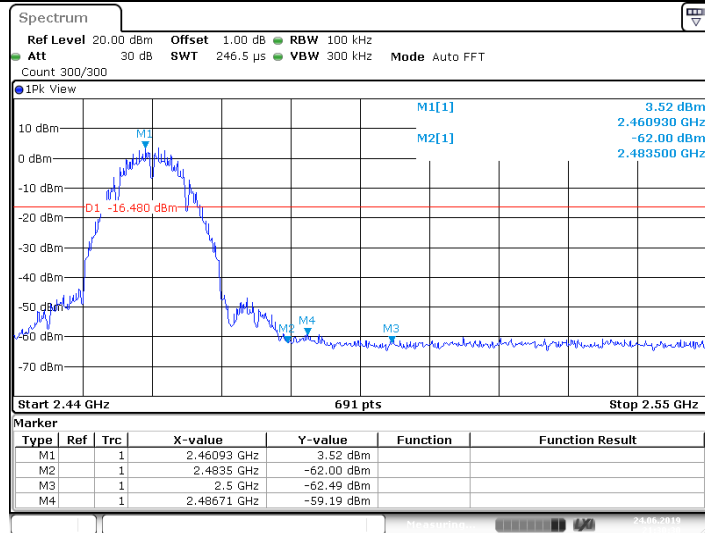

### 11G\_Ant0\_Low\_2412

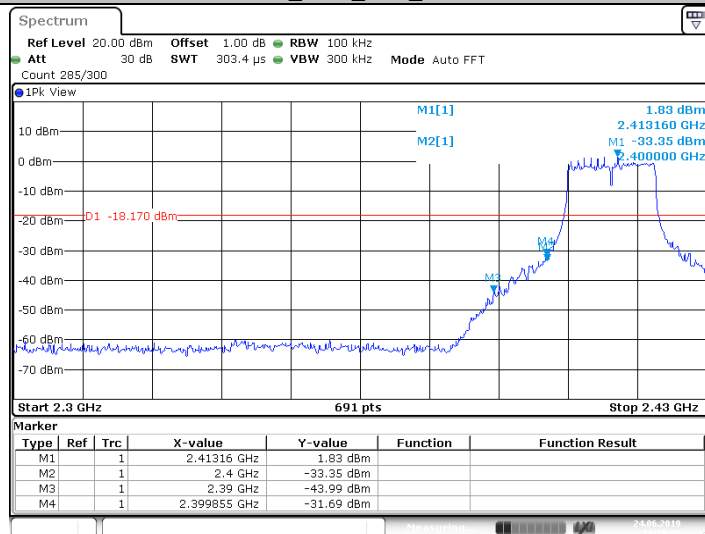

### 11G\_Ant1\_Low\_2412

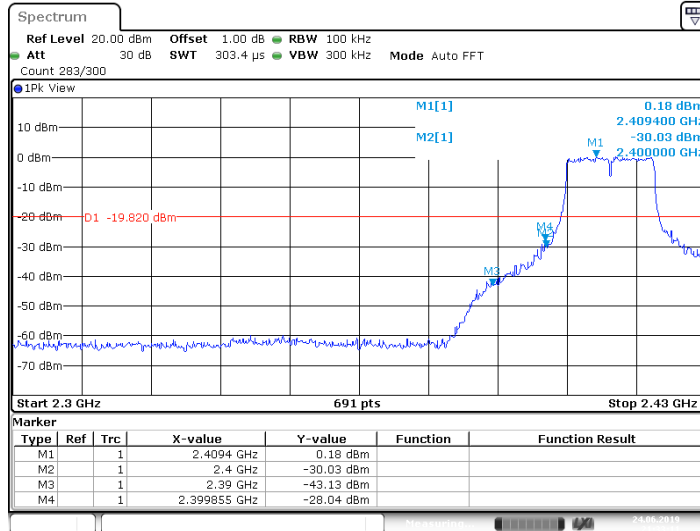

### 11G\_Ant0\_High\_2462

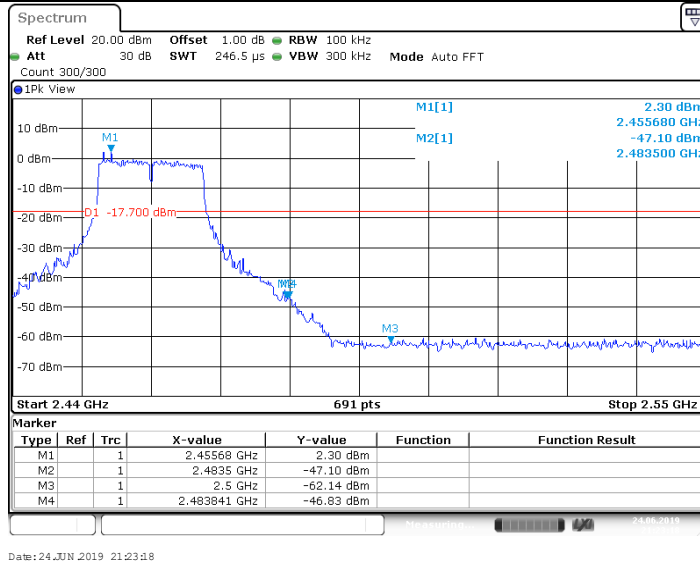

### 11G\_Ant1\_High\_2462

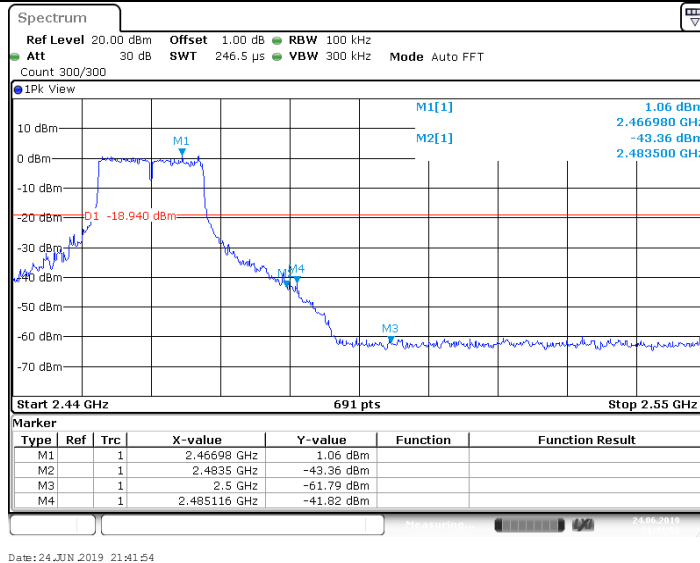

11N20\_Ant0\_Low\_2412

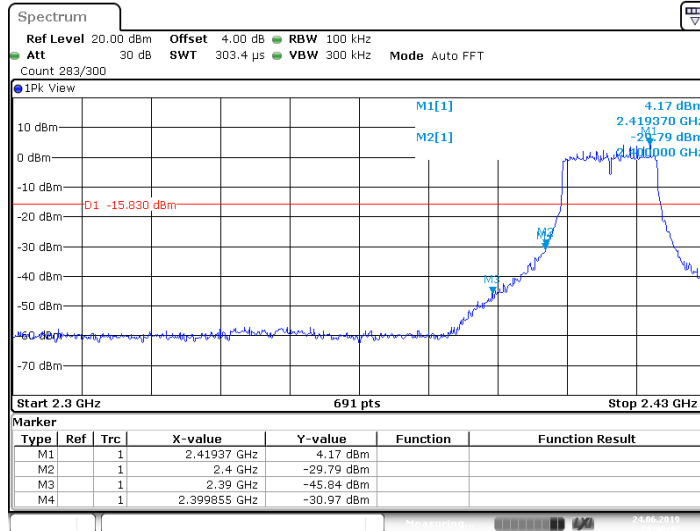

11N20\_Ant0\_High\_2462

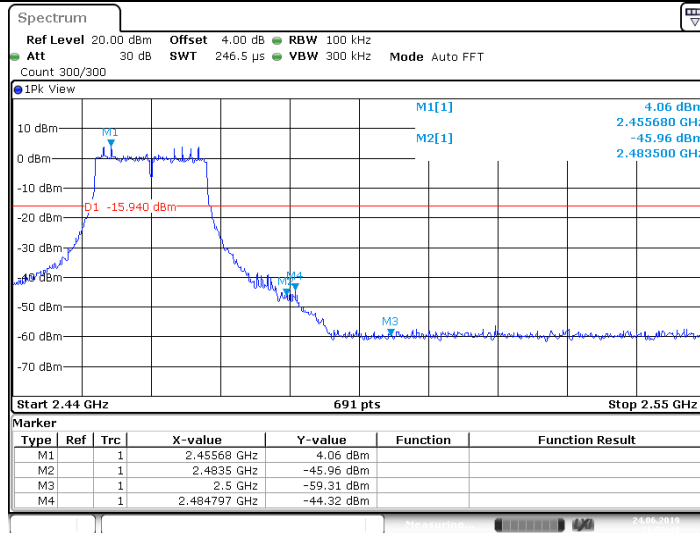

11N20\_Ant0\_Low\_2422

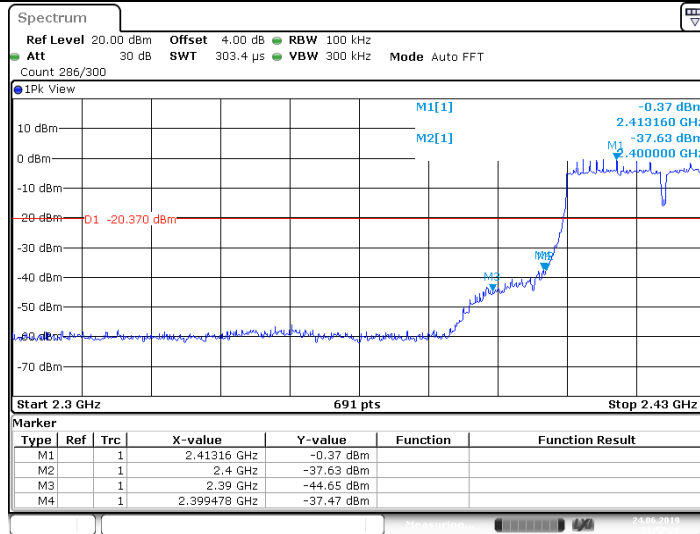

11N20\_Ant0\_High\_2452

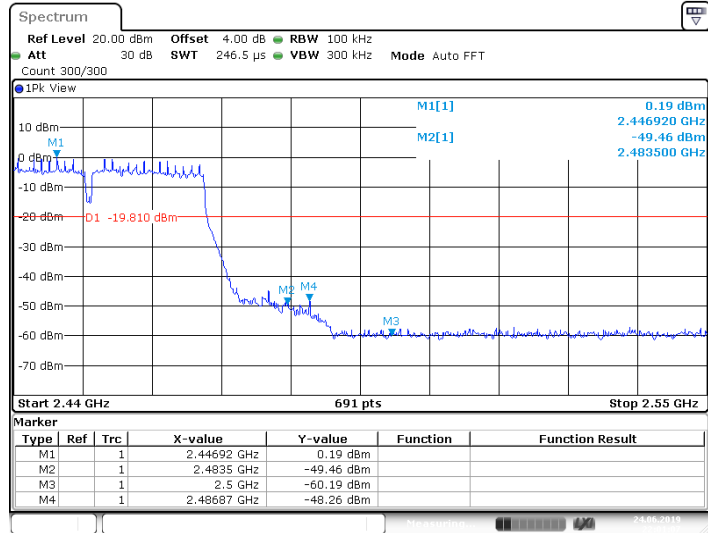

## 9.6 Spurious radiated emissions for transmitter

### Test Method

1. The EUT was placed on a turn table which is 1.5m above ground plane for above 1GHz and 0.8m above ground for below 1GHz at 3meter chamber room for test. The table was rotated 360 degrees to determine the position of the highest radiation.
2. Set to the maximum power setting and enable the EUT transmit continuously
3. The EUT was set 3 meters away from the interference – receiving antenna, which was mounted on the top of a variable – height antenna tower.
4. The height of antenna is varied from one meter to four meters above the ground to determine the maximum value of the field strength. Both horizontal and vertical polarizations of the antenna are set to make the measurement.
5. For each suspected emission, the EUT was arranged to its worst case and then the antenna was tuned to heights from 1 meter to 4 meters and the rotatable table was turned
6. Use the following spectrum analyzer settings According to C63.10:  
For Above 1GHz  
Span = wide enough to capture the peak level of the in-band emission and all spurious  
RBW = 1MHz, VBW $\geq$ RBW for peak measurement and VBW = 10Hz for average measurement, Sweep = auto, Detector function = peak, Trace = max hold.  
For Below 1GHz  
Use the following spectrum analyzer settings:  
Span = wide enough to capture the peak level of the in-band emission and all spurious  
RBW = 100 KHz, VBW $\geq$ RBW for peak measurement, Sweep = auto, Detector function = peak, Trace = max hold.
7. Repeat above procedures until all frequencies measured were complete.

### Note:

1. The resolution bandwidth and video bandwidth of test receiver/spectrum analyzer is 120 KHz for Quasi-peak detection (QP) at frequency below 1GHz.
2. The resolution bandwidth of test receiver/spectrum analyzer is 1MHz and the video bandwidth is 3MHz for peak detection (PK) at frequency above 1GHz.
3. The resolution bandwidth of test receiver/spectrum analyzer is 1MHz and the video bandwidth is 3MHz for RMS Average ((duty cycle < 98%) for Average detection (AV) at frequency above 1GHz, then the measurement results was added to a correction factor (20log(1/duty cycle)).
4. The resolution bandwidth of test receiver/spectrum analyzer is 1MHz and the video bandwidth is 10Hz (duty cycle > 98%) for Average detection (AV) at frequency above 1GHz.

## Limit

The radio emission outside the operating frequency band shall be at least 20 dB below that in the 100 kHz bandwidth within the band that contains the highest level of the desired power. Radiated emissions which fall in the restricted bands, as defined in section 15.205, must comply with the radiated emission limits specified in section 15.209.

Frequency MHz	Field Strength $\mu$ V/m	Field Strength dB $\mu$ V/m	Detector
30-88	100	40	QP
88-216	150	43.5	QP
216-960	200	46	QP
960-1000	500	54	QP
Above 1000	500	54	AV
Above 1000	5000	74	PK

## Spurious radiated emissions for transmitter

According to C63.10, if the peak (or quasi-peak) measured value complies with the average limit, it is unnecessary to perform an average measurement, so AV emission value did not show in below table if the peak value complies with average limit.

The only worse case (802.11B\_2412MHz\_Ant1 mode) test result is listed in the report.

### Transmitting spurious emission test result as below:

#### 802.11B Modulation 2412MHz Test Result

Frequency Band	Frequency	Emission Level	Polarization	Limit	Detector	Margin	Correct factor (dB)	Result
	MHz	dB $\mu$ V/m		dB $\mu$ V/m		dB $\mu$ V/m		
30-1000MHz	53.60	20.95	H	40	QP	19.05	18.2	Pass
	518.88	27.16	H	46	QP	18.84	23.5	Pass
	745.81	29.89	H	46	QP	16.11	26.3	Pass
	879.29	34.58	H	46	QP	11.42	28.6	Pass
	Other Frequencies	--	H	--	QP	--	--	Pass
	43.80	21.01	V	40	QP	18.99	18.9	Pass
	60.66	24.97	V	40	QP	15.03	17.0	Pass
	631.08	28.21	V	46	QP	17.79	25.3	Pass
	943.26	35.51	V	46	QP	10.49	29.3	Pass
	Other Frequencies	--	V	--	QP	--	--	Pass
1000-25000MHz	1249.75	33.04	H	74	PK	40.96	-12.1	Pass
	2275.38	33.97	H	74	PK	40.03	-7.0	Pass
	Other Frequencies	--	H	--	PK	--	--	Pass
	1528.81	34.18	V	74	PK	39.82	-11.1	Pass
	2321.25	32.09	V	74	PK	41.91	-6.6	Pass
	Other Frequencies	--	V	--	PK	--	--	Pass

#### Remark:

- (1) "\*" means the emission(s) appear within the restrict bands shall follow the requirement of section 15.205.
- (2) Data of measurement within this frequency range shown "--" in the table above means the reading of emissions are the noise floor or attenuated more than 20dB below the permissible limits or the field strength is too small to be measured.
- (3) Corrected Amplitude = Read level + Corrector factor  
 Above 1GHz: Corrector factor = Antenna Factor + Cable Loss- Amplifier Gain  
 Below 1GHz: Corrector factor = Antenna Factor + Cable Loss  
 (The Reading Level is recorded by software which is not shown in the sheet)

## 10 Test Equipment List

### Radiated Emission Test

DESCRIPTION	MANUFACTURER	MODEL NO.	SERIAL NO.	CAL. DUE DATE
EMI Test Receiver	Rohde & Schwarz	ESR 26	101269	2020-6-28
Trilog Super Broadband Test Antenna	Schwarzbeck	VULB 9163	707	2020-6-28
Horn Antenna	Rohde & Schwarz	HF907	102294	2020-6-22
Loop Antenna	Rohde & Schwarz	HFH2-Z2	100398	2020-7-7
Pre-amplifier	Rohde & Schwarz	SCU 18	102230	2020-6-28
Signal Generator	Rohde & Schwarz	SMY01	839369/005	2020-6-28
Attenuator	Agilent	8491A	MY39264334	2020-6-28
3m Semi-anechoic chamber	TDK	9X6X6	----	2020-7-7

### Conducted RF Test System

DESCRIPTION	MANUFACTURER	MODEL NO.	SERIAL NO.	CAL. DUE DATE
Signal Analyzer	Rohde & Schwarz	FSV40	101030	2020-6-28
RF Switch Module	Rohde & Schwarz	OSP120/OSP-B157	101226/100851	2020-6-28
Power Splitter	Weinschel	1580	SC319	2020-7-7
Test software	Tonscend	System for BT/WIFI	Version 2.5.77.0418	N/A



## 11 System Measurement Uncertainty

For a 95% confidence level, the measurement expanded uncertainties for defined systems, in accordance with the recommendations of ISO 17025 were:

System Measurement Uncertainty	
Test Items	Extended Uncertainty
Uncertainty for Radiated Spurious Emission 25MHz-3000MHz	Horizontal: 4.91dB; Vertical: 4.89dB;
Uncertainty for Radiated Spurious Emission 3000MHz-18000MHz	Horizontal: 4.80dB; Vertical: 4.79dB;
Uncertainty for Radiated Spurious Emission 18000MHz-40000MHz	Horizontal: 5.05dB; Vertical: 5.04dB;
Uncertainty for Conducted RF test with TS 8997	RF Power Conducted: 1.16dB Frequency test involved: $0.6 \times 10^{-7}$ or 1%