

FCC - TEST REPORT

Report Number : **68.950.19.0607.01** Date of Issue: **July 30, 2019**

Model : **3BOX A2**

Product Type : Wearable on Neck Host

Applicant : VR Technology (Shenzhen) Limited

Address : Room 201, 12 Gaoxin South Road, Huiheng Building, Nanshan
District, Shenzhen

Manufacturer : VR Technology (Shenzhen) Limited

Address : Room 201, 12 Gaoxin South Road, Huiheng Building, Nanshan
District, Shenzhen

Test Result : Positive Negative

Total pages including
Appendices : **73**

TÜV SÜD Certification and Testing (China) Co., Ltd. Shenzhen Branch is a subcontractor to TÜV SÜD Product Service GmbH according to the principles outlined in ISO 17025.

TÜV SÜD Certification and Testing (China) Co., Ltd. Shenzhen Branch reports apply only to the specific samples tested under stated test conditions. Construction of the actual test samples has been documented. It is the manufacturer's responsibility to assure that additional production units of this model are manufactured with identical electrical and mechanical components. The manufacturer/importer is responsible to the Competent Authorities in Europe for any modifications made to the production units which result in non-compliance to the relevant regulations. TÜV SÜD Certification and Testing (China) Co., Ltd. Shenzhen Branch shall have no liability for any deductions, inferences or generalizations drawn by the client or others from TÜV SÜD Certification and Testing (China) Co., Ltd. Shenzhen Branch issued reports.

This report is the confidential property of the client. As a mutual protection to our clients, the public and ourselves, extracts from the test report shall not be reproduced except in full without our written approval.

1 Table of Contents

1	Table of Contents	2
2	Details about the Test Laboratory	3
3	Description of the Equipment Under Test	4
4	Summary of Test Standards	5
5	Summary of Test Results	6
6	General Remarks	7
7	Test setups	8
8	Systems test configuration	9
9	Technical Requirements	10
9.1	Emission bandwidth	13
9.2	Maximum Conducted Output Power	15
9.3	Peak Power Spectral Density	18
9.4	Unwanted Emissions	30
9.5	Duty Cycle	69
9.6	Frequency Stability	70
10	Test Equipment List	72
11	System Measurement Uncertainty	73



2 Details about the Test Laboratory

Details about the Test Laboratory

Test Site 1

Company name: TÜV SÜD Certification and Testing (China) Co., Ltd. Shenzhen Branch
Building 12 & 13, Zhiheng Wisdomland Business Park, Nantou Checkpoint
Road 2, Nanshan District
Shenzhen 518052
P.R. China

Telephone: 86 755 8828 6998

Fax: 86 755 8828 5299

FCC Registration No.: 514049

FCC Designation Number: CA5009

IC Registration No.: 10320A

3 Description of the Equipment Under Test

Product:	Wearable on Neck Host
Model no.:	3BOX A2
FCC ID:	2AKA6-A2
Options and accessories:	Adapter and USB Cable
Rating:	Supplied by 5*3.8Vdc 1100mAh Li-ion Rechargeable battery Charged by 5.0Vdc, 3.0A external adapter
Adapter information:	Adapter Model: A138A-120150U-US2 Input: 100-240Vac, 50/60Hz; 0.5A Output: 5.0Vdc, 3.0A
RF Transmission Frequency:	2402MHz-2480MHz
No. of Operated Channel:	40
Modulation:	GFSK
Antenna Type:	Integrated antenna
Antenna Gain:	3.0dBi
Description of the EUT:	The Equipment Under Test (EUT) is a Wearable on Neck Host which support Bluetooth function and WiFi operated at 5GHz and 2.4GHz. Only 5GWiFi included in this report.

4 Summary of Test Standards

Test Standards	
FCC Part 15 Subpart E, 10-1-2018 Edition	PART 15 - RADIO FREQUENCY DEVICES Subpart E - Unlicensed National Information Infrastructure Devices

Test Method:

KDB 789033 D02 General UNII Test Procedures New Rules v02r01

ANSI C63.10-2013, American National Standard for Testing Unlicensed Wireless Devices

KDB 662911 D01 Multiple Transmitter Output v02r01

5 Summary of Test Results

Technical Requirements				
FCC Part 15 Subpart E				
Test Condition	Pages	Test Result		
		Pass	Fail	N/A
15.207 Conducted Emission AC Power Port	--	<input type="checkbox"/>	<input type="checkbox"/>	<input checked="" type="checkbox"/>
15.403(a)(5) Emission bandwidth	10	<input checked="" type="checkbox"/>	<input type="checkbox"/>	<input type="checkbox"/>
15.407(a)(1) 15.407(a)(3) Maximum Conducted Output Power	13	<input checked="" type="checkbox"/>	<input type="checkbox"/>	<input type="checkbox"/>
15.407(a)(1) 15.407(a)(3) Peak Power Spectral Density	15	<input checked="" type="checkbox"/>	<input type="checkbox"/>	<input type="checkbox"/>
15.407(b)(1) 15.407(b)(4) 15.407(b)(6) 15.407(b)(7) 15.209 Unwanted Emissions	30	<input checked="" type="checkbox"/>	<input type="checkbox"/>	<input type="checkbox"/>
Duty Cycle	69	<input checked="" type="checkbox"/>	<input type="checkbox"/>	<input type="checkbox"/>
15.407(g) Frequencies Stability	70	<input checked="" type="checkbox"/>	<input type="checkbox"/>	<input type="checkbox"/>
15.407(h) Dynamic Frequency Selection (DFS). ^a	--	<input type="checkbox"/>	<input type="checkbox"/>	<input checked="" type="checkbox"/>

NOTE 1^a: This product only supports 5150-5250MHz and 5725-5850MHz, so DFS is not applicable.

6 General Remarks

Remarks

This submittal(s) (test report) is intended for FCC ID: 2AKA6-A2, complies with Section FCC Part 15 Subpart C Rules and FCC Part 15 Subpart E Rules.

SUMMARY:

All tests according to the regulations cited on page 5 were

- Performed

- **Not** Performed

The Equipment Under Test

- **Fulfills** the general approval requirements.

- **Does not** fulfill the general approval requirements.

Sample Received Date: June 13, 2019

Testing Start Date: June 14, 2019

Testing End Date: July 10, 2019

- TÜV SÜD Certification and Testing (China) Co., Ltd. Shenzhen Branch –

Reviewed by:

Prepared by:

Tested by:



John Zhi
Project Manager

Alan Xiong
Project Engineer

Tree Zhan
Test Engineer

7 Test setups

7.1 Radiated test setups

Below 1GHz

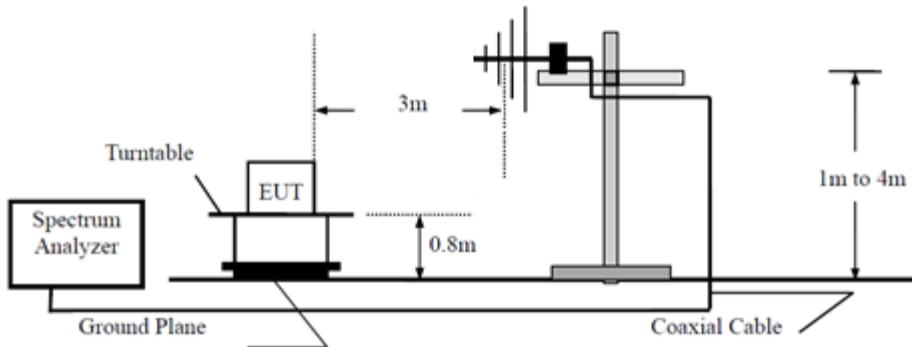

Above 1GHz

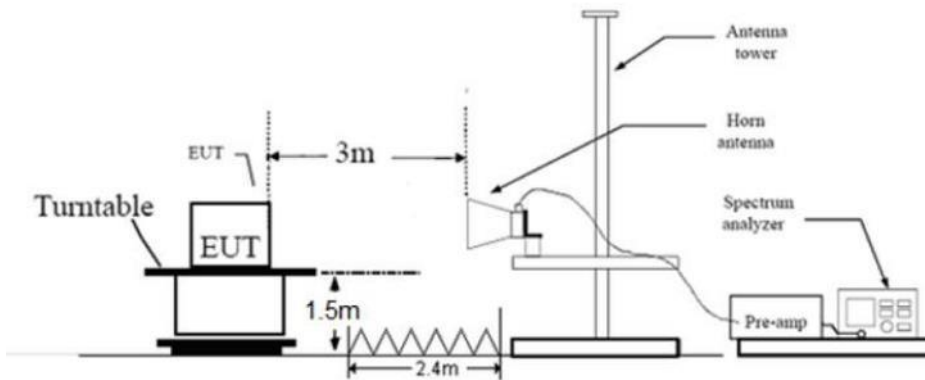

7.2 Conducted RF test setups

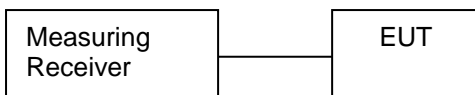

8. Systems test configuration

Auxiliary Equipment Used during Test:

DESCRIPTION	MANUFACTURER	MODEL NO.(SHIELD)	S/N(LENGTH)
PC	Lenovo	X240	---

In order to find the worst case condition, pre-tests are needed at the presence of different data rate. Preliminary tests have been done on all the configuration for confirming worst case. Data rate below means worst-case rate of each test item.

Band	Data Rate
802.11a	6 Mbps
802.11n HT20	MCS0
802.11n HT40	MCS0
802.11ac HT20	MCS0
802.11ac HT40	MCS0
802.11ac HT80	MCS0

The system was configured to the following channels

Modulation	Channel	Frequency (MHz)
802.11a / 802.11n20 / 802.11ac20	36	5180
	44	5220
	48	5240
	149	5745
	157	5785
	165	5825
802.11n40 / 802.11ac40	38	5190
	46	5230
	151	5755
	159	5795
802.11ac80	42	5210
	155	5775

The system was configured to the following transmit power

Modulation	Ant0	Ant1	Ant0+Ant1
802.11a	Default value	Default value	---
802.11n20 / 802.11ac20	---	---	Default value
802.11n40 / 802.11ac40	---	---	Default value
802.11ac80	---	---	Default value

9 Technical Requirement

9.1 Emission bandwidth

1、 Test Method of 26dB Bandwidth

According to KDB789033 D02

- a) Set RBW = approximately 1% of the emission bandwidth.
- b) Set the VBW > RBW.
- c) Detector = Peak.
- d) Trace mode = max hold.
- e) Measure the maximum width of the emission that is 26 dB down from the maximum of the emission. Compare this with the RBW setting of the analyzer. Readjust RBW and repeat measurement as needed until the RBW/EBW ratio is approximately 1%.

Limit: No limit

2、 Test Method of 6dB Bandwidth

According to KDB789033 D02

- a) Set RBW = 100KHz
- b) Set the video bandwidth (VBW) $\geq 3 \times$ RBW
- c) Detector = Peak.
- d) Trace mode = max hold.
- e) Sweep = auto couple.
- f) Allow the trace to stabilize.
- g) Measure the maximum width of the emission that is constrained by the frequencies associated with the two outermost amplitude points (upper and lower frequencies) that are attenuated by 6 dB relative to the maximum level measured in the fundamental emission.

Limit: ≥ 500 KHz

3、 Test Method of 99% Bandwidth

According to KDB789033 D02

- a) Set center frequency to the nominal EUT channel center frequency
- b) Set span = 1.5 times to 5.0 times the OBW.
- c) Set RBW = 1 % to 5 % of the OBW
- d) Set VBW $\geq 3 \cdot$ RBW
- e) Video averaging is not permitted. Where practical, a sample detection and single sweep mode shall be used. Otherwise, peak detection and max hold mode (until the trace stabilizes) shall be used.
- f) Use the 99 % power bandwidth function of the instrument (if available).
- g) If the instrument does not have a 99 % power bandwidth function, the trace data points are recovered and directly summed in power units. The recovered amplitude data points, beginning at the lowest frequency, are placed in a running sum until 0.5 % of the total is reached; that frequency is recorded as the lower frequency. The process is repeated until 99.5 % of the total is reached; that frequency is recorded as the upper frequency. The 99% occupied bandwidth is the difference between these two frequencies.

Limit: No limit

Test result as below table:

IEEE 802.11a_SISO modulation Test Result

Band	Channel	Channel Frequency (MHz)	Measured 99% Bandwidth (MHz)		Measured 26dB Bandwidth (MHz)		Measured 6dB Bandwidth (MHz)	
			Ant0	Ant1	Ant0	Ant1	Ant0	Ant1
U-NII-1	Low	5180	17.902	17.902	22.160	21.400	N/A	N/A
	Middle	5220	17.862	17.942	21.560	21.440	N/A	N/A
	High	5240	17.902	17.982	21.440	21.520	N/A	N/A
U-NII-3	Low	5745	17.862	17.902	N/A	N/A	16.440	16.440
	Middle	5785	17.902	17.902	N/A	N/A	16.440	16.440
	High	5825	17.902	17.902	N/A	N/A	16.440	16.440

IEEE 802.11n-HT20_MIMO modulation Test Result

Band	Channel	Channel Frequency (MHz)	Measured 99% Bandwidth (MHz)	Measured 26dB Bandwidth (MHz)	Measured 6dB Bandwidth (MHz)
U-NII-1	Low	5180	18.781	21.640	N/A
	Middle	5220	18.901	21.680	N/A
	High	5240	18.941	21.600	N/A
U-NII-3	Low	5745	18.781	N/A	17.680
	Middle	5785	18.861	N/A	17.680
	High	5825	18.781	N/A	17.680

IEEE 802.11n-HT40_MIMO modulation Test Result

Band	Channel	Channel Frequency (MHz)	Measured 99% Bandwidth (MHz)	Measured 26dB Bandwidth (MHz)	Measured 6dB Bandwidth (MHz)
U-NII-1	Low	5190	36.843	40.720	N/A
	High	5230	36.923	40.800	N/A
U-NII-3	Low	5755	36.923	N/A	36.560
	High	5795	36.923	N/A	36.480

IEEE 802.1ac-VHT20_MIMO modulation Test Result

Band	Channel	Channel Frequency (MHz)	Measured 99% Bandwidth (MHz)	Measured 26dB Bandwidth (MHz)	Measured 6dB Bandwidth (MHz)
U-NII-1	Low	5180	18.821	21.560	N/A
	Middle	5220	18.861	21.760	N/A
	High	5240	18.861	21.560	N/A
U-NII-3	Low	5745	18.781	N/A	17.680
	Middle	5785	18.781	N/A	17.680
	High	5825	18.821	N/A	17.680

IEEE 802.1ac-VHT40 modulation Test Result

Band	Channel	Channel Frequency (MHz)	Measured 99% Bandwidth (MHz)	Measured 26dB Bandwidth (MHz)	Measured 6dB Bandwidth (MHz)
U-NII-1	Low	5190	36.843	40.480	N/A
	High	5230	36.763	40.640	N/A
U-NII-3	Low	5755	36.923	N/A	36.560
	High	5795	36.923	N/A	36.560

IEEE 802.1ac-VHT80 modulation Test Result

Band	Channel	Channel Frequency (MHz)	Measured 99% Bandwidth (MHz)	Measured 26dB Bandwidth (MHz)	Measured 6dB Bandwidth (MHz)
U-NII-1	Low	5210	76.084	82.880	N/A
U-NII-3	High	5775	76.404	N/A	75.580

Remark: "N/A" means "Not Applicable"

9.3 Maximum conducted output power

Test Method

According to KDB789033 D02

Limits: For client devices in the 5.15-5.25 GHz band, the maximum conducted output power over the frequency band of operation shall not exceed 250 mW provided the maximum antenna gain does not exceed 6 dBi.

For the 5.25-5.35 GHz and 5.47-5.725 GHz bands, the maximum conducted output power over the frequency bands of operation shall not exceed the lesser of 250 mW or 11 dBm + 10 log B, where B is the 26dB emission bandwidth in megahertz.

For the band 5.725-5.85 GHz, the maximum conducted output power over the frequency band of operation shall not exceed 1 W.

Test result as below table

IEEE 802.11a_SISO modulation Test Result

Band	Channel	Channel Frequency (MHz)	Maximum Conducted Output Power (dBm)		Power Limit (dBm)
			Ant0	Ant1	
U-NII-1	Low	5180	16.2	15.5	24.00
	Middle	5220	15.9	15.8	24.00
	High	5240	16.1	15.0	24.00
U-NII-3	Low	5745	15.7	16.0	30.00
	Middle	5785	16.1	15.6	30.00
	High	5825	15.9	16.4	30.00

IEEE 802.11n-HT20_MIMO modulation Test Result

Band	Channel	Channel Frequency (MHz)	Maximum Conducted Output Power (dBm)			Power Limit (dBm)
			Ant0	Ant1	SUM	
U-NII-1	Low	5180	16.2	15.2	18.7	24.00
	Middle	5220	16.0	14.7	18.4	24.00
	High	5240	15.8	14.5	18.2	24.00
U-NII-3	Low	5745	15.5	14.8	18.2	30.00
	Middle	5785	15.9	14.6	18.3	30.00
	High	5825	15.9	14.8	18.4	30.00

IEEE 802.11n-HT40_MIMO modulation Test Result

Band	Channel	Channel Frequency (MHz)	Maximum Conducted Output Power (dBm)			Power Limit (dBm)
			Ant0	Ant1	SUM	
U-NII-1	Low	5190	15.5	14.7	18.1	24.00
	High	5230	15.2	14.4	17.8	24.00
U-NII-3	Low	5755	15.6	14.7	18.2	30.00
	High	5795	15.7	14.5	18.2	30.00

IEEE 802.11ac-VHT20_MIMO modulation Test Result

Band	Channel	Channel Frequency (MHz)	Maximum Conducted Output Power (dBm)			Power Limit (dBm)
			Ant0	Ant1	SUM	
U-NII-1	Low	5180	15.8	14.5	18.3	24.00
	Middle	5220	15.5	14.6	18.1	24.00
	High	5240	15.2	14.5	17.9	24.00
U-NII-3	Low	5745	15.4	14.8	18.1	30.00
	Middle	5785	15.6	14.8	18.2	30.00
	High	5825	16.0	15.0	18.5	30.00

IEEE 802.11ac-VHT40_MIMO modulation Test Result

Band	Channel	Channel Frequency (MHz)	Maximum Conducted Output Power (dBm)			Power Limit (dBm)
			Ant0	Ant1	SUM	
U-NII-1	Low	5190	15.5	14.9	18.2	24.00
	High	5230	15.0	14.6	17.8	24.00
U-NII-3	Low	5755	15.9	14.5	18.3	30.00
	High	5795	15.6	14.8	18.2	30.00

IEEE 802.11ac-VHT80_MIMO modulation Test Result

Band	Channel	Channel Frequency (MHz)	Maximum Conducted Output Power (dBm)			Power Limit (dBm)
			Ant0	Ant1	SUM	
U-NII-1	42	5210	15.3	14.5	17.9	24.00
U-NII-3	155	5755	15.8	14.7	18.3	30.00

Remark: the 11 dBm + 10 log B is greater than 250mW.

9.4 Maximum power spectral density

Test Method

According to KDB789033 D02

For devices operating in the bands 5.15-5.25 GHz, 5.25-5.35 GHz, and 5.47-5.725 GHz, the above procedures make use of 1 MHz RBW to satisfy directly the 1 MHz reference bandwidth specified in § 15.407(a)(5). For devices operating in the band 5.725-5.85 GHz, the rules specify a measurement bandwidth of 500 kHz. Many spectrum analyzers do not have 500 kHz RBW, thus a narrower RBW may need to be used. The rules permit the use of a RBWs less than 1 MHz, or bandwidth” to show the total power over the specified measurement bandwidth (i.e., 1 MHz, or 500 kHz). If measurements are performed using a reduced resolution bandwidth (< 1 MHz, or < 500 kHz) and integrated over 1 MHz, or 500 KHz bandwidth, the following adjustments to the procedures apply:

- a) Set $RBW \geq 1/T$, where T is defined in section II.B.I.a).
- b) Set $VBW \geq 3 RBW$.
- c) If measurement bandwidth of Maximum PSD is specified in 500 kHz, add $10\log(500\text{kHz}/RBW)$ to the measured result, whereas RBW (< 500 KHz) is the reduced resolution bandwidth of the spectrum analyzer set during measurement.
- d) If measurement bandwidth of Maximum PSD is specified in 1 MHz, add $10\log(1\text{MHz}/RBW)$ to the measured result, whereas RBW (< 1 MHz) is the reduced resolution bandwidth of spectrum analyzer set during measurement.
- e) Care must be taken to ensure that the measurements are performed during a period of continuous transmission or are corrected upward for duty cycle.

Note: As a practical matter, it is recommended to use reduced RBW of 100 KHz for the sections 5.c) and 5.d) above, since RBW=100 KHz is available on nearly all spectrum analyzers.

Limit: The maximum power spectral density shall not exceed 11dBm for the 5.15-5.25GHz, 5.25-5.35GHz, 5.47-5.725 GHz Band and 30dBm for the 5.8GHz Band in any 1 megahertz band.

IEEE 802.11a_SISO modulation Test Result

Band	Channel	Channel Frequency (MHz)	Maximum PSD (dBm/MHz)		PSD Limit (dBm/MHz)
			Ant0	Ant1	
U-NII-1	Low	5180	8.77	8.39	11.00
	Middle	5220	8.76	8.10	11.00
	High	5240	8.14	7.51	11.00
U-NII-3	Low	5745	12.69	12.00	30.00
	Middle	5785	12.77	12.28	30.00
	High	5825	12.85	12.48	30.00

IEEE 802.11n-HT20_MIMO modulation Test Result

Band	Channel	Frequency (MHz)	Maximum PSD (dBm/MHz)	PSD Limit (dBm/MHz)
U-NII-1	Low	5180	9.43	11.00
	Middle	5220	9.13	11.00
	High	5240	9.39	11.00
U-NII-3	Low	5745	8.24	30.00
	Middle	5785	8.57	30.00
	High	5825	9.19	30.00

IEEE 802.11n-HT40_MIMO modulation Test Result

Band	Channel	Frequency (MHz)	Maximum PSD (dBm/MHz)	PSD Limit (dBm/MHz)
U-NII-1	Low	5190	5.98	11.00
	High	5230	5.99	11.00
U-NII-3	Low	5755	1.66	30.00
	High	5795	6.50	30.00

IEEE 802.11ac-VHT20_MIMO modulation Test Result

Band	Channel	Frequency (MHz)	Maximum PSD (dBm/MHz)	PSD Limit (dBm/MHz)
U-NII-1	Low	5180	9.64	11.00
	Middle	5220	9.45	11.00
	High	5240	9.53	11.00
U-NII-3	Low	5745	9.81	30.00
	Middle	5785	9.32	30.00
	High	5825	10.13	30.00

IEEE 802.11ac-VHT40_MIMO modulation Test Result

Band	Channel	Frequency (MHz)	Maximum PSD (dBm/MHz)	PSD Limit (dBm/MHz)
U-NII-1	Low	5190	6.98	11.00
	High	5230	6.75	11.00
U-NII-3	Low	5755	6.55	30.00
	High	5795	6.03	30.00

IEEE 802.11ac-VHT80_MIMO modulation Test Result

Band	Channel	Frequency (MHz)	Maximum PSD (dBm/MHz)	PSD Limit (dBm/MHz)
U-NII-1	42	5210	3.81	11.00
U-NII-3	155	5775	3.83	30.00

NOTE: According to the test results of output power, Ant0 is considered to have the highest power, so PSD for Multiple mode are performed with this antenna and add 3dBi factor, this factor has been compensated in the test.

11A_Ant0_5180

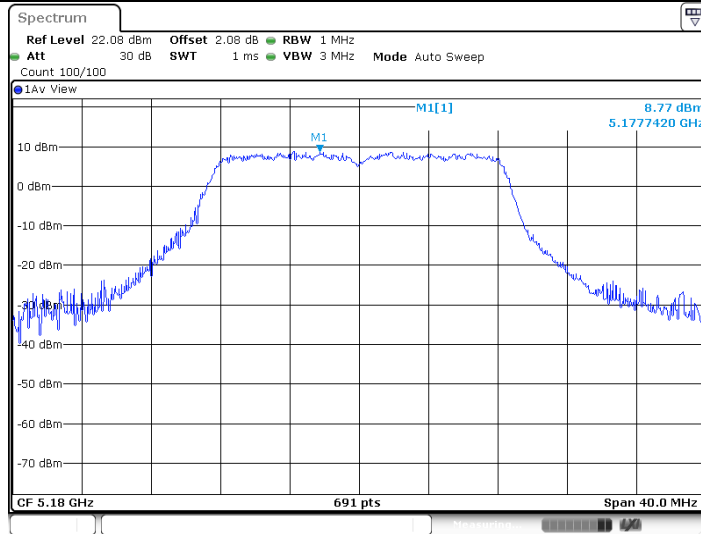

Date: 29 JUL 2019 18:12:31

11A_Ant1_5180

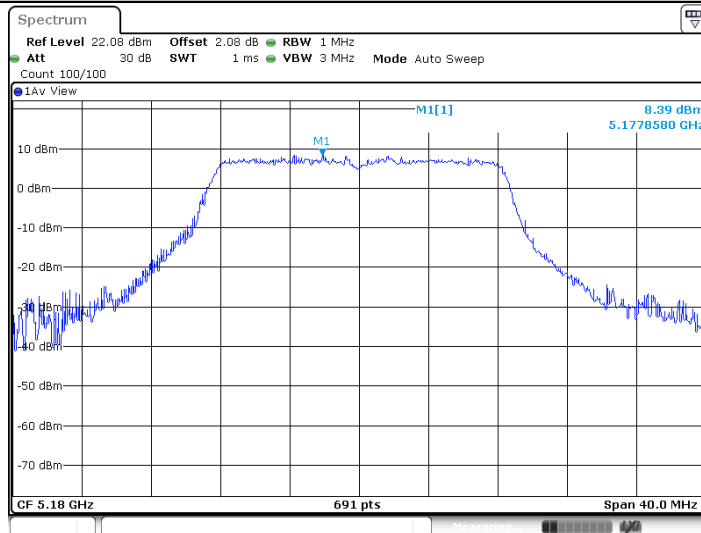

Date: 29 JUL 2019 17:14:51

11A_Ant0_5200

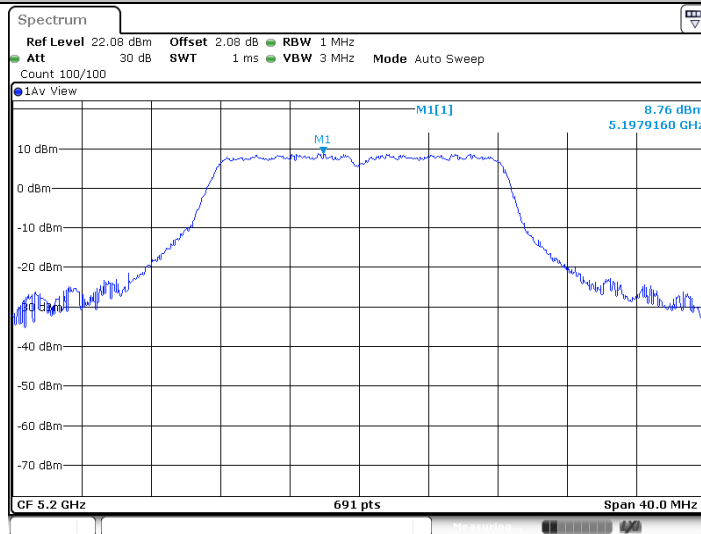

Date: 29 JUL 2019 18:14:22

11A_Ant1_5200

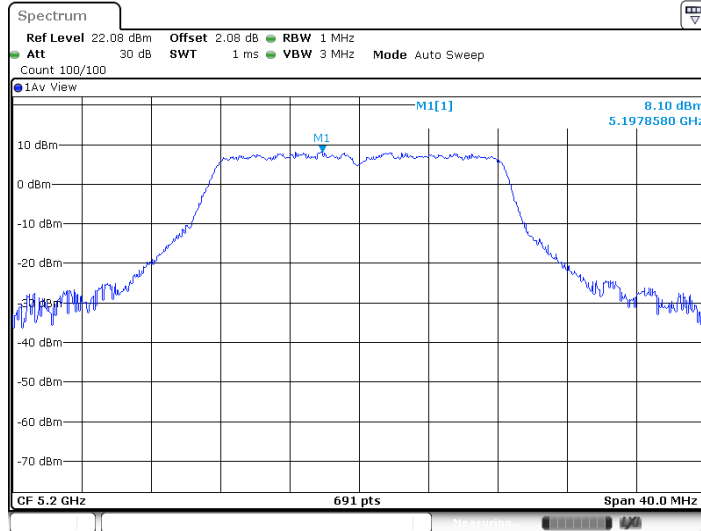

Date: 29 JUL 2019 17:17:27

11A_Ant0_5240

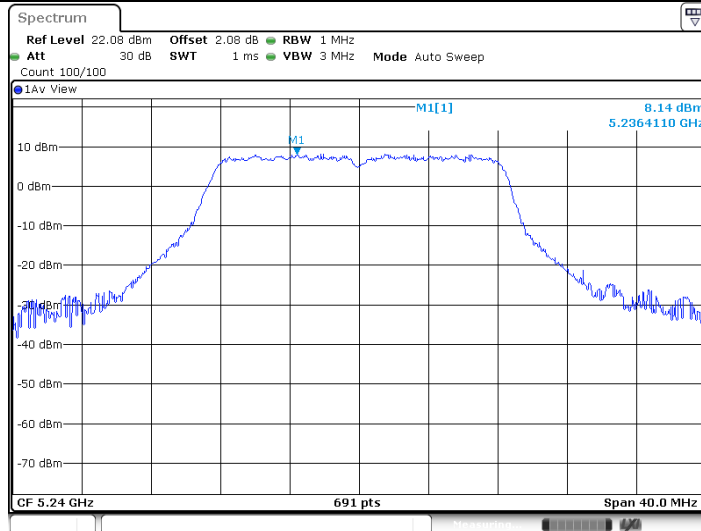

Date: 29 JUL 2019 18:15:56

11A_Ant1_5240

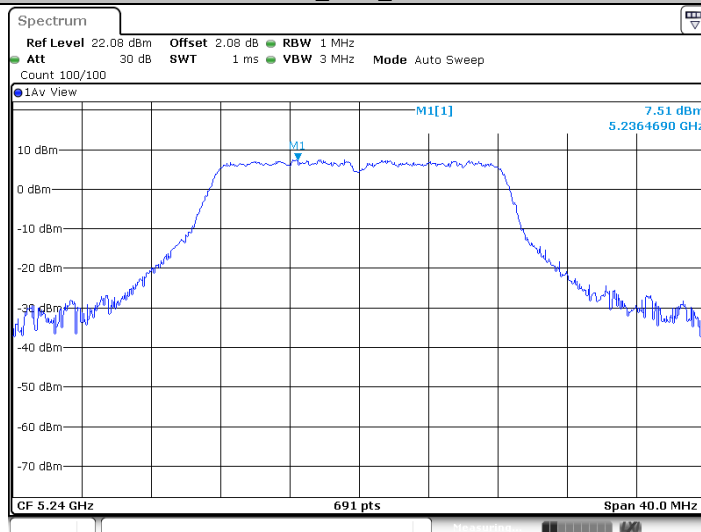

Date: 29 JUL 2019 17:19:17

11A_Ant0_5745

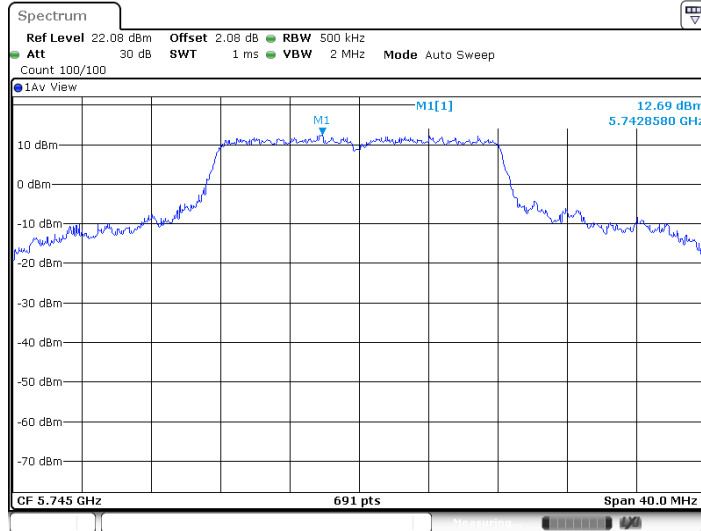

Date: 29 JUL 2019 18:18:06

11A_Ant1_5745

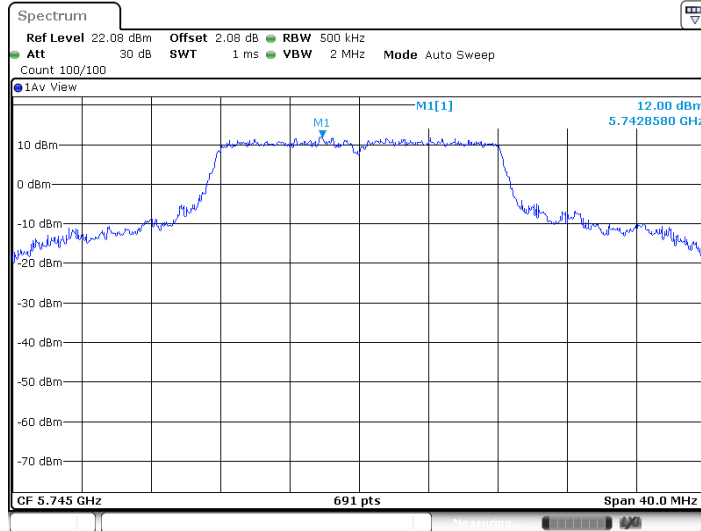

Date: 29 JUL 2019 17:21:45

11A_Ant0_5785

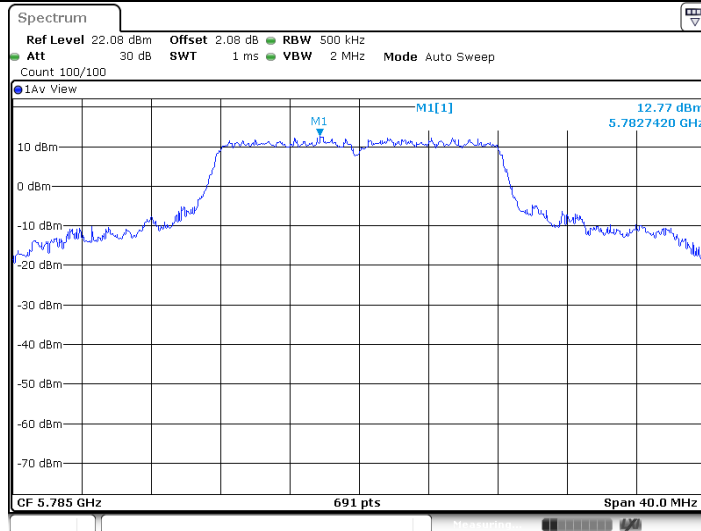

Date: 29 JUL 2019 18:20:11

11A_Ant1_5785

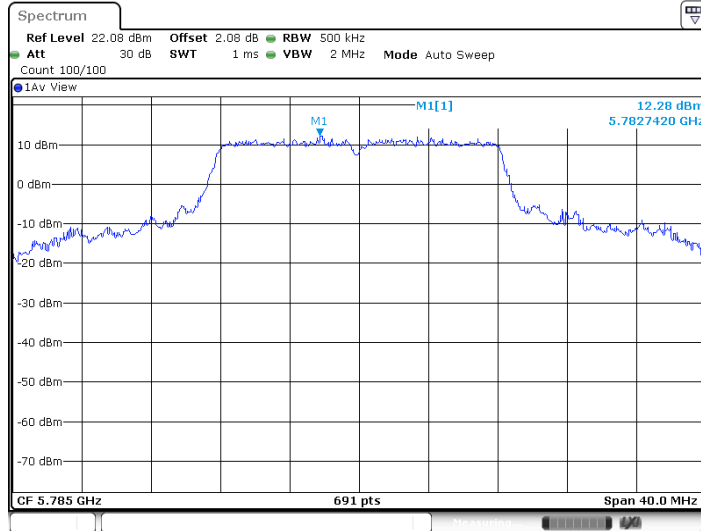

Date: 29 JUL 2019 17:24:38

11A_Ant0_5825

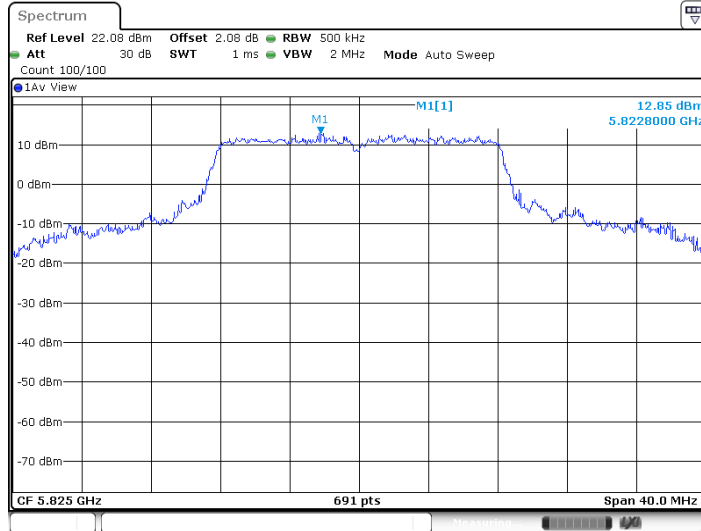

Date: 29 JUL 2019 18:22:03

11A_Ant1_5825



Date: 29 JUL 2019 17:27:04

11N20MIMO_5180

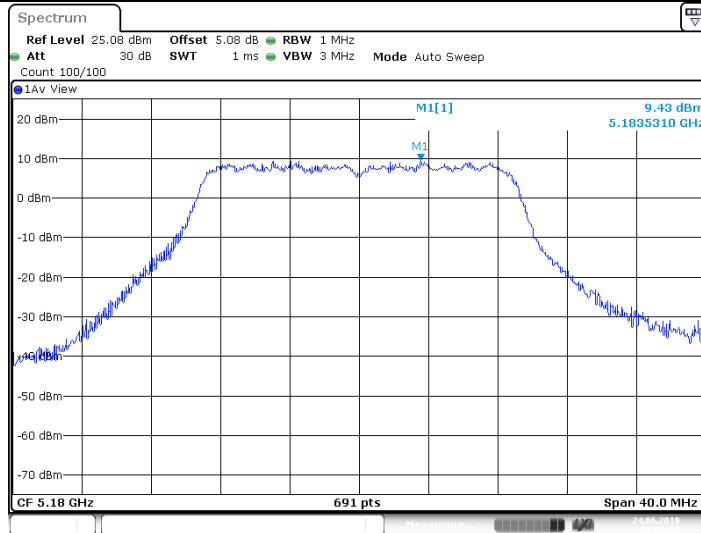

Date: 24 JUN 2019 22:09:09

11N20MIMO_5200

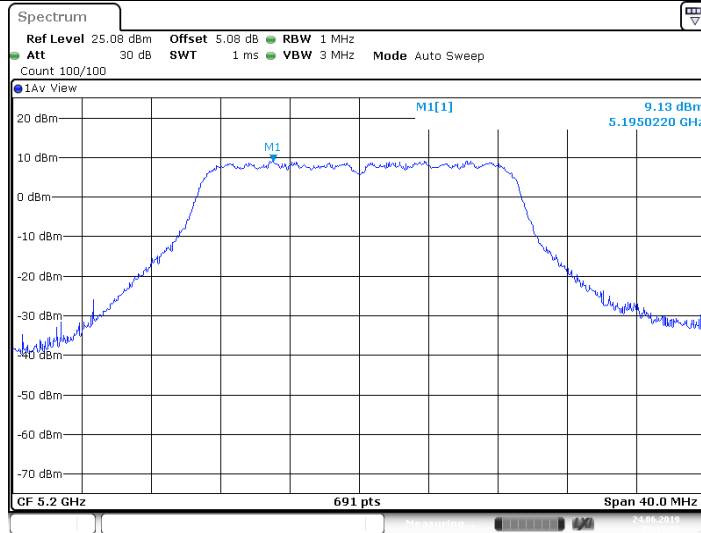

Date: 24 JUN 2019 22:12:28

11N20MIMO_5240

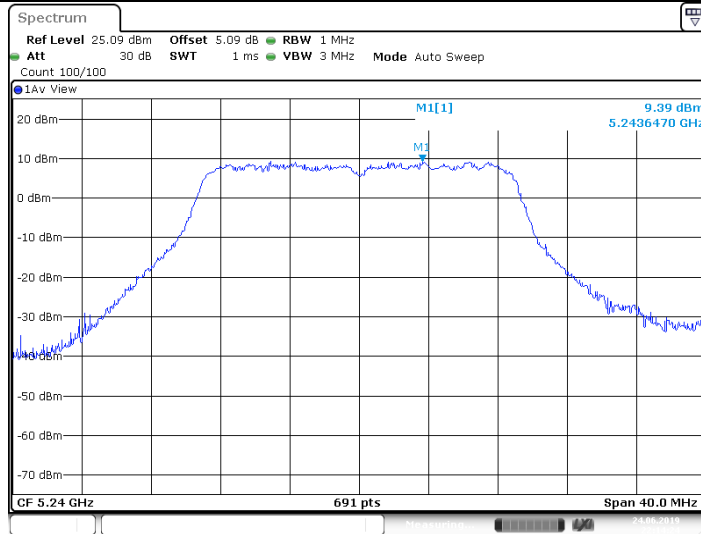

Date: 24 JUN 2019 22:14:25

11N20MIMO_5745

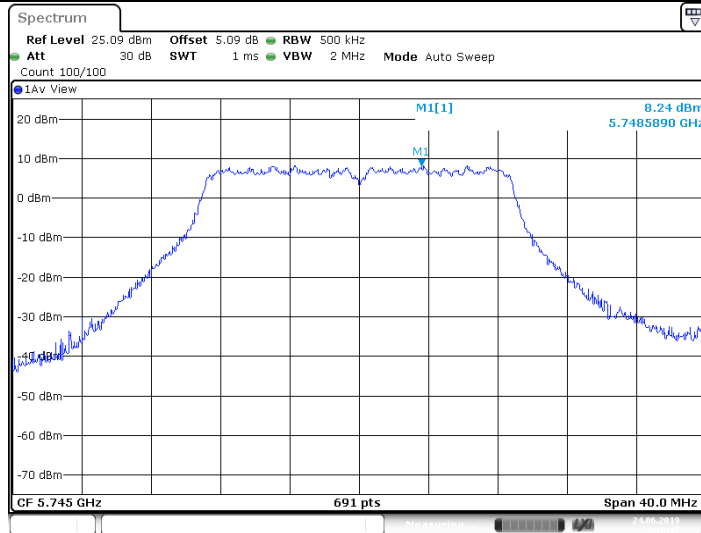

Date: 24 JUN 2019 22:16:17

11N20MIMO_5785

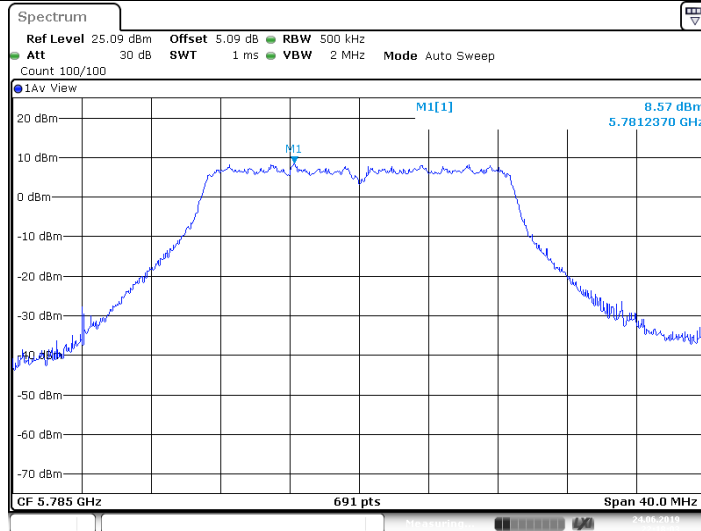

Date: 24 JUN 2019 22:18:03

11N20MIMO_5825

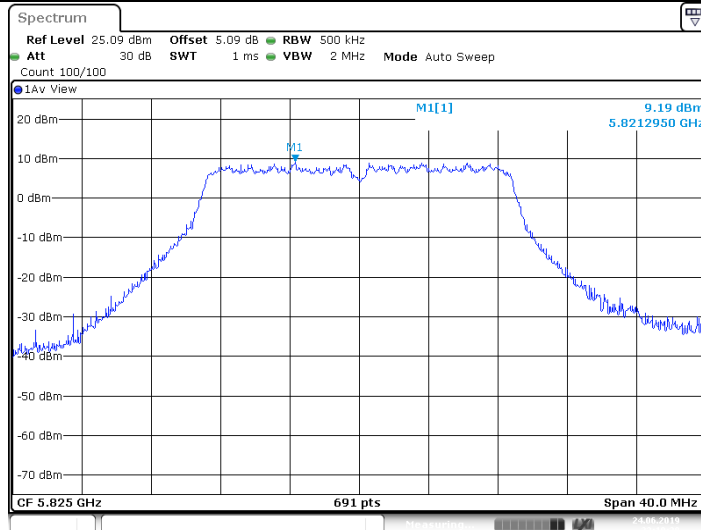

Date: 24 JUN 2019 22:19:39

11N40MIMO_5190

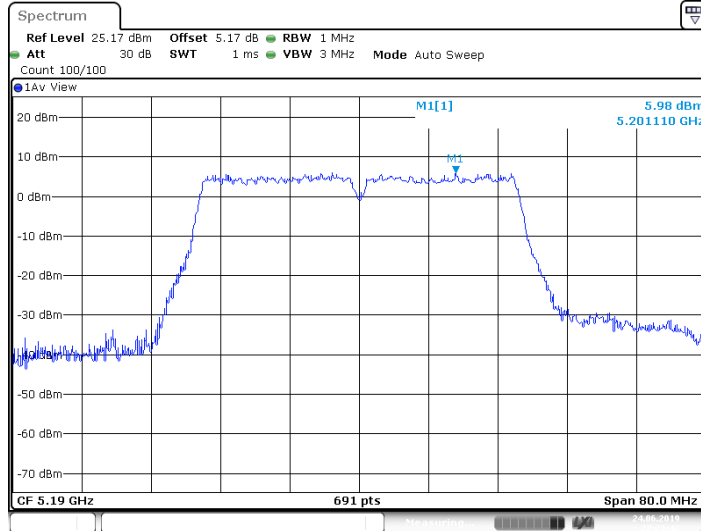

Date: 24 JUN 2019 22:21:42

11N40MIMO_5230

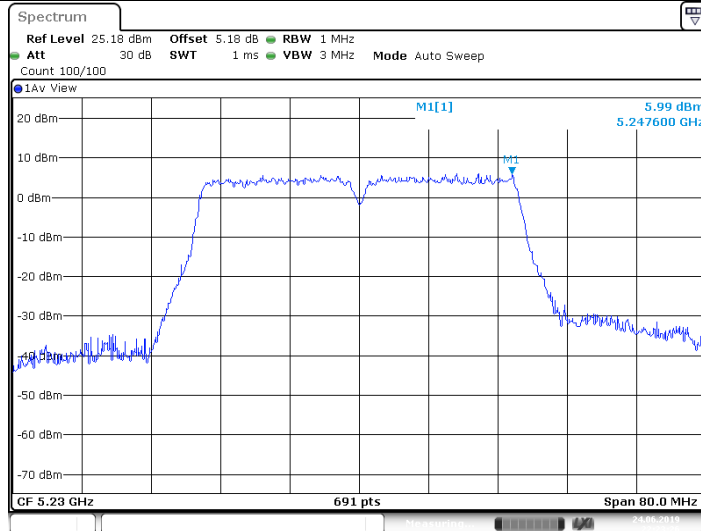

Date: 24 JUN 2019 22:23:27

11N40MIMO_5755

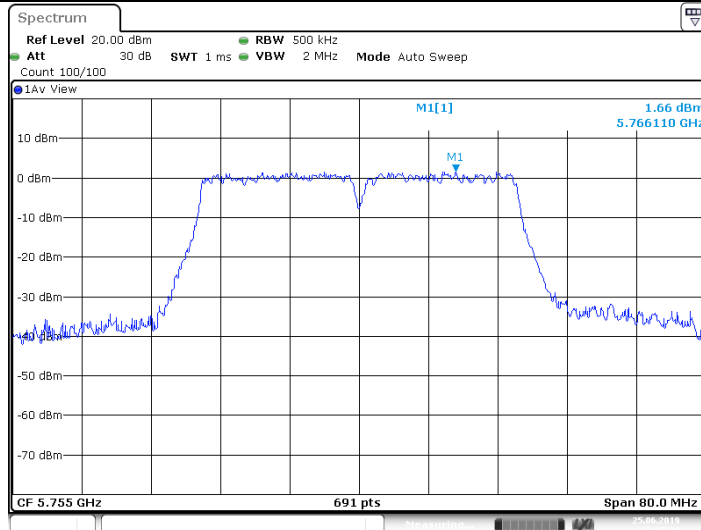

Date: 25 JUN 2019 18:03:39

11N40MIMO_5795

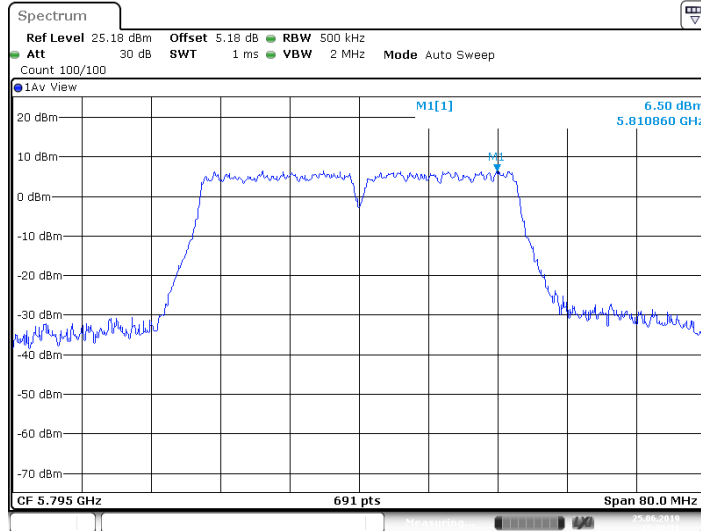

Date: 25 JUN 2019 18:06:31

11AC20MIMO_5180

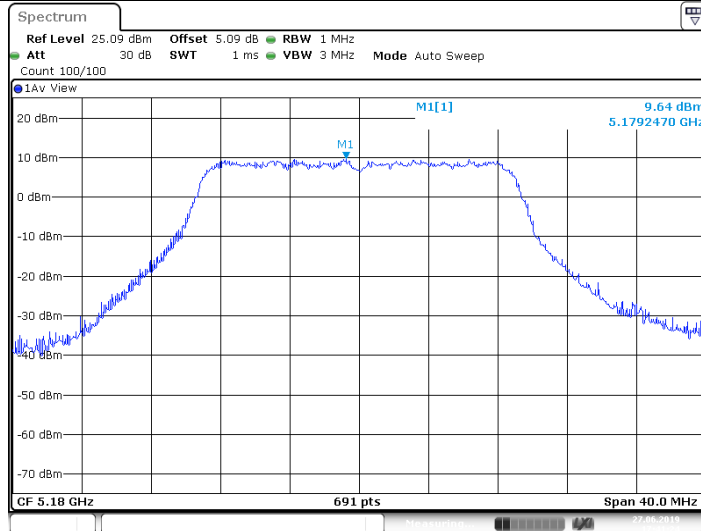

Date: 27 JUN 2019 17:41:25

11AC20MIMO_5200

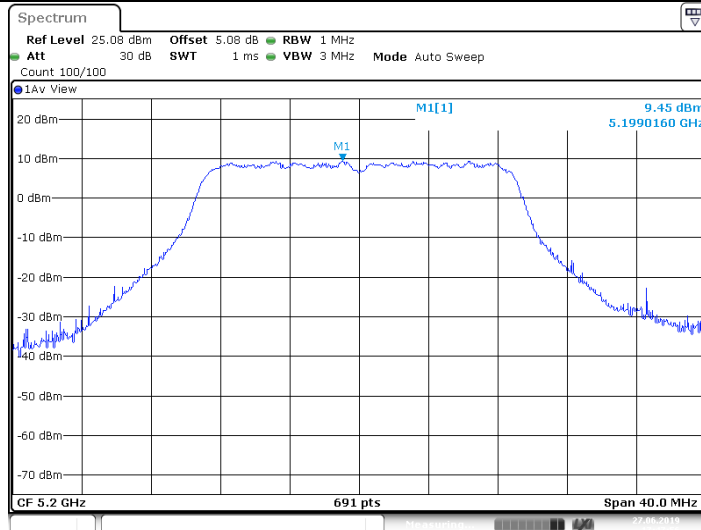

Date: 27 JUN 2019 17:47:57

11AC20MIMO_5240

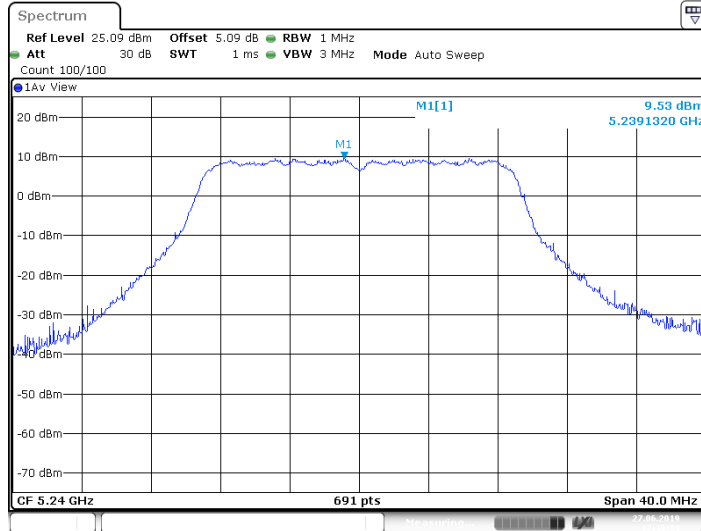

Date: 27 JUN 2019 17:49:34

11AC20MIMO_5745

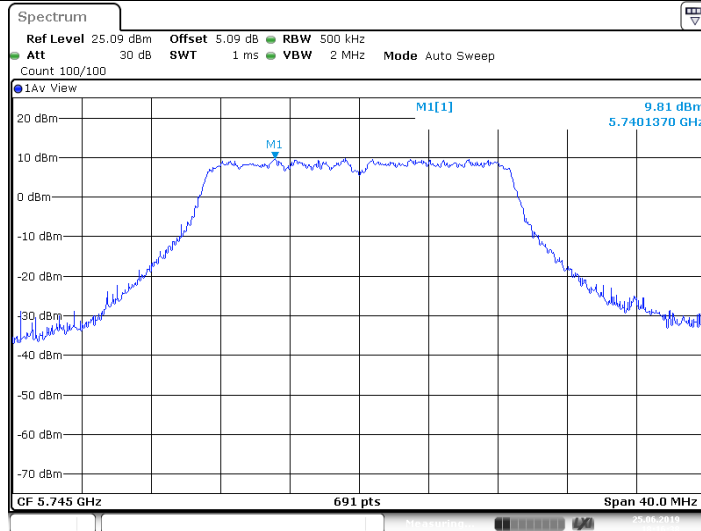

Date: 25 JUN 2019 18:16:39

11AC20MIMO_5785

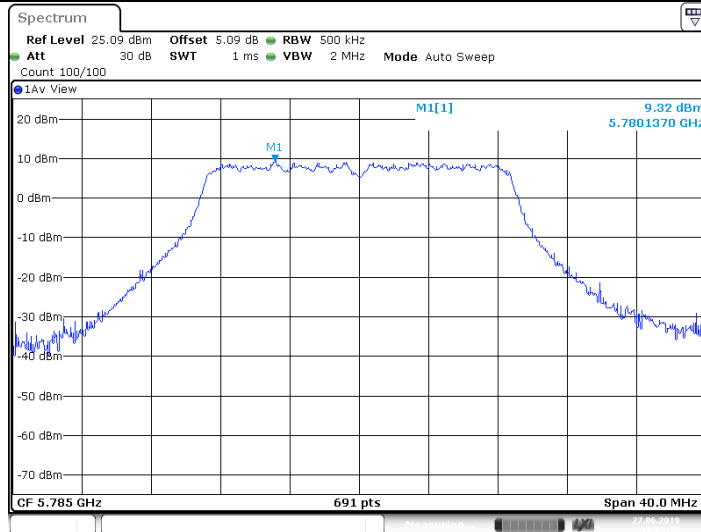

Date: 27 JUN 2019 17:03:55

11AC20MIMO_5825

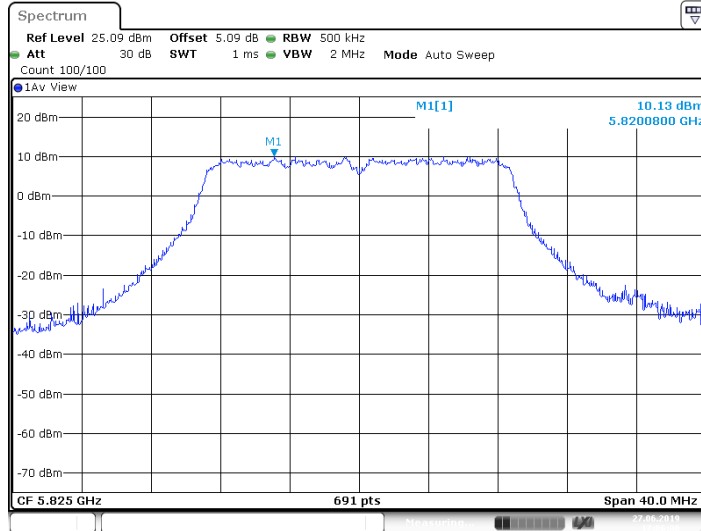

Date: 27 JUN 2019 17:06:00

11AC40MIMO_5190

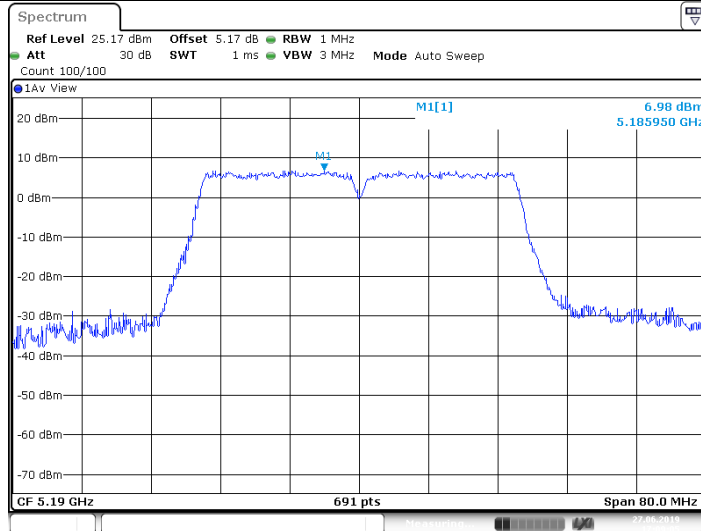

Date: 27 JUN 2019 17:09:06

11AC40MIMO_5230

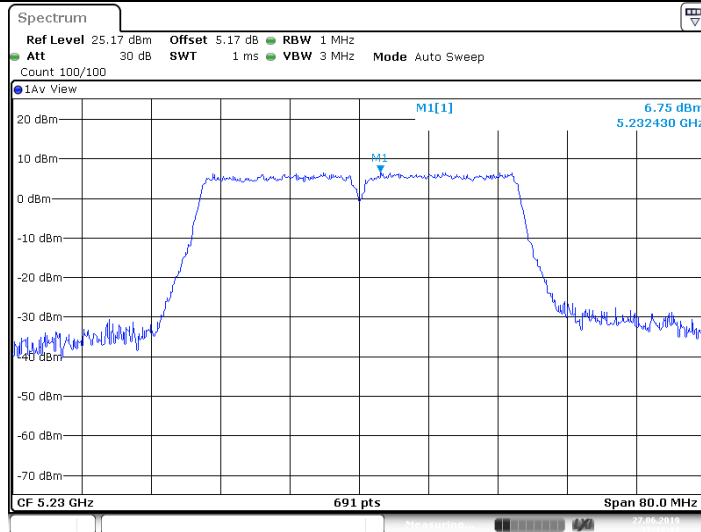

Date: 27 JUN 2019 17:12:11

11AC40MIMO_5755

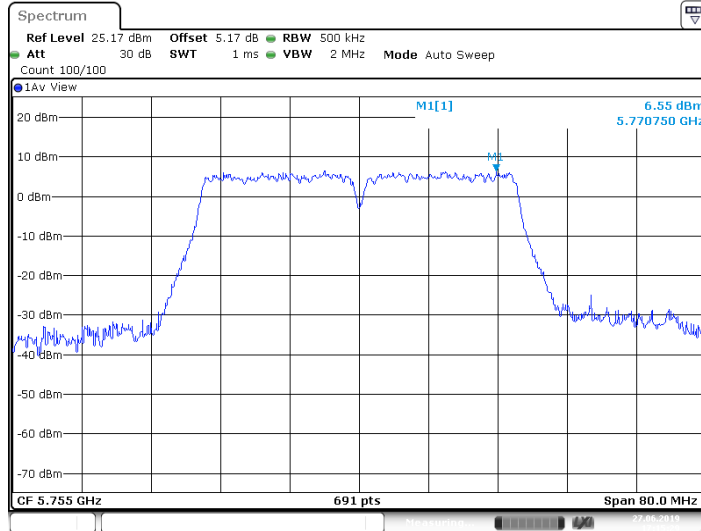

Date: 27 JUN 2019 17:15:29

11AC40MIMO_5795

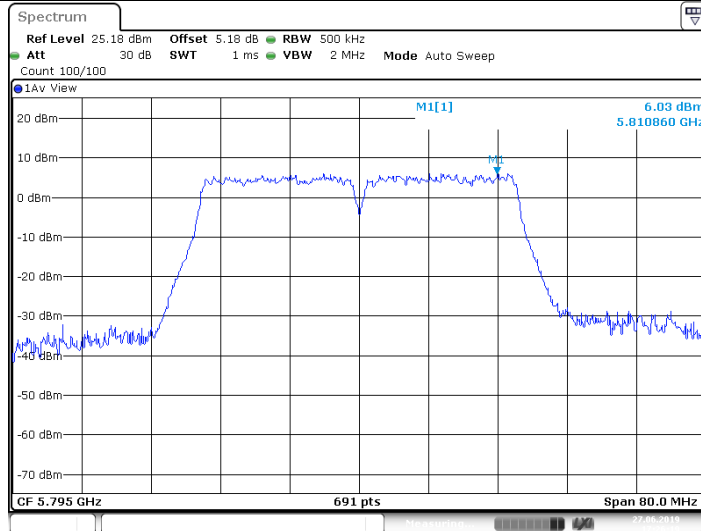

Date: 27 JUN 2019 17:26:19

11AC80MIMO_5210

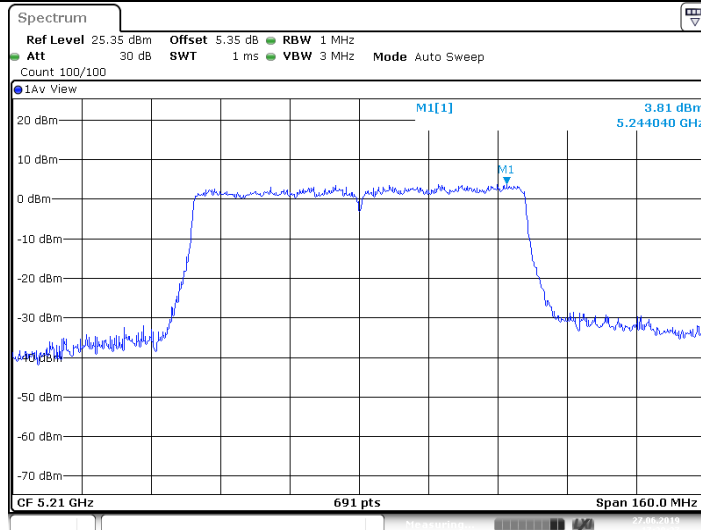

Date: 27 JUN 2019 17:28:37

11AC80MIMO_5775

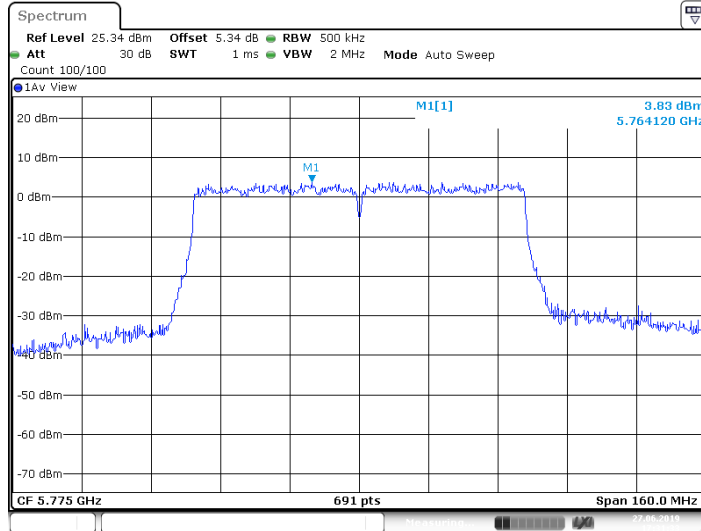

Date: 27 JUN 2019 17:31:33

9.5 Unwanted emissions

Test Method

According to KBD789033 D02

Limits:

For transmitters operating in the 5.15-5.25 GHz band: All emissions outside of the 5.15-5.35 GHz band shall not exceed an e.i.r.p. of -27 dBm/MHz.

For transmitters operating in the 5.25-5.35 GHz band: All emissions outside of the 5.15-5.35 GHz band shall not exceed an e.i.r.p. of -27 dBm/MHz.

For transmitters operating in the 5.47-5.725 GHz band: All emissions outside of the 5.47-5.725 GHz band shall not exceed an e.i.r.p. of -27 dBm/MHz.

For transmitters operating in the 5.725-5.85 GHz band: All emissions shall be limited to a level of -27 dBm/MHz at 75 MHz or more above or below the band edge increasing linearly to 10 dBm/MHz at 25 MHz above or below the band edge, and from 25 MHz above or below the band edge increasing linearly to a level of 15.6 dBm/MHz at 5 MHz above or below the band edge, and from 5 MHz above or below the band edge increasing linearly to a level of 27 dBm/MHz at the band edge.

Unwanted emissions below 1 GHz must comply with the general field strength limits set forth in §15.209. Further, any U-NII devices using an AC power line are required to comply also with the conducted limits set forth in §15.207.

The provisions of §15.205 apply to intentional radiators operating under this section.



Test Data as below:

TestMode	Antenna	Channel (MHz)	FreqRange (MHz)	Max. Fre	Max. Level (dBm)	Limit (dBm)	Verdict
11A_SISO	Ant0	5180	30~5140	30~5140	-36.25	<=-27	PASS
		5180	5360~40000	5360~40000	-46.17	<=-27	PASS
	Ant1	5180	30~5140	30~5140	-37.85	<=-27	PASS
		5180	5360~40000	5360~40000	-47.12	<=-27	PASS
	Ant0	5200	30~5140	30~5140	-36.2	<=-27	PASS
		5200	5360~40000	5360~40000	-45.78	<=-27	PASS
	Ant1	5200	30~5140	30~5140	-37.1	<=-27	PASS
		5200	5360~40000	5360~40000	-45.97	<=-27	PASS
	Ant0	5240	30~5140	30~5140	-39.29	<=-27	PASS
		5240	5360~40000	5360~40000	-46.6	<=-27	PASS
	Ant1	5240	30~5140	30~5140	-39.16	<=-27	PASS
		5240	5360~40000	5360~40000	-46.23	<=-27	PASS
	Ant0	5745	30~5650	30~5650	-40.51	<=-27	PASS
		5745	5925~40000	5925~40000	-46.23	<=-27	PASS
	Ant1	5745	30~5650	30~5650	-40.85	<=-27	PASS
		5745	5925~40000	5925~40000	-46.68	<=-27	PASS
	Ant0	5785	30~5650	30~5650	-40.41	<=-27	PASS
		5785	5925~40000	5925~40000	-45.88	<=-27	PASS
	Ant1	5785	30~5650	30~5650	-40.93	<=-27	PASS
		5785	5925~40000	5925~40000	-45.29	<=-27	PASS
	Ant0	5825	30~5650	30~5650	-40.09	<=-27	PASS
		5825	5925~40000	5925~40000	-45.67	<=-27	PASS
	Ant1	5825	30~5650	30~5650	-41.55	<=-27	PASS
		5825	5925~40000	5925~40000	-46.64	<=-27	PASS
11N20MIMO	Ant0+3dBi (NOTE)	5180	30~5140	30~5140	-38.63	<=-27	PASS
		5180	5360~40000	5360~40000	-34.32	<=-27	PASS
		5200	30~5140	30~5140	-40.78	<=-27	PASS
		5200	5360~40000	5360~40000	-34.01	<=-27	PASS
		5240	30~5140	30~5140	-41.16	<=-27	PASS
		5240	5360~40000	5360~40000	-33.42	<=-27	PASS
		5745	30~5650	30~5650	-42.75	<=-27	PASS
		5745	5925~40000	5925~40000	-33.93	<=-27	PASS
		5785	30~5650	30~5650	-42.32	<=-27	PASS
		5785	5925~40000	5925~40000	-33.61	<=-27	PASS
		5825	30~5650	30~5650	-42.84	<=-27	PASS
		5825	5925~40000	5925~40000	-33.7	<=-27	PASS
11N40MIMO	Ant0+3dBi (NOTE)	5190	30~5140	30~5140	-36.86	<=-27	PASS
		5190	5360~40000	5360~40000	-33.71	<=-27	PASS
		5230	30~5140	30~5140	-41.19	<=-27	PASS
		5230	5360~40000	5360~40000	-34.39	<=-27	PASS
		5755	30~5650	30~5650	-41.11	<=-27	PASS
		5755	5925~40000	5925~40000	-34.45	<=-27	PASS
		5795	30~5650	30~5650	-41.38	<=-27	PASS
5795	5925~40000	5925~40000	-34.19	<=-27	PASS		
11AC20MIMO	Ant0+3dBi (NOTE)	5180	30~5140	30~5140	-39.43	<=-27	PASS
		5180	5360~40000	5360~40000	-34.8	<=-27	PASS
		5200	30~5140	30~5140	-42.42	<=-27	PASS
		5200	5360~40000	5360~40000	-34.58	<=-27	PASS
		5240	30~5140	30~5140	-42.68	<=-27	PASS
		5240	5360~40000	5360~40000	-33.88	<=-27	PASS
		5745	30~5650	30~5650	-41.5	<=-27	PASS
		5745	5925~40000	5925~40000	-34.5	<=-27	PASS
		5785	30~5650	30~5650	-42.65	<=-27	PASS
		5785	5925~40000	5925~40000	-33.29	<=-27	PASS
		5825	30~5650	30~5650	-40.94	<=-27	PASS
5825	5925~40000	5925~40000	-33.08	<=-27	PASS		
11AC40MIMO	Ant0+3dBi (NOTE)	5190	30~5140	30~5140	-37	<=-27	PASS
		5190	5360~40000	5360~40000	-34.34	<=-27	PASS
		5230	30~5140	30~5140	-41.77	<=-27	PASS



		5230	5360~40000	5360~40000	-34.13	<=-27	PASS
		5755	30~5650	30~5650	-40.55	<=-27	PASS
		5755	5925~40000	5925~40000	-33.25	<=-27	PASS
		5795	30~5650	30~5650	-42.24	<=-27	PASS
		5795	5925~40000	5925~40000	-34.84	<=-27	PASS
11AC80MIMO	Ant0+3dBi (NOTE)	5210	30~5140	30~5140	-31.45	<=-27	PASS
		5210	5360~40000	5360~40000	-34.31	<=-27	PASS
		5775	30~5650	30~5650	-41.82	<=-27	PASS
		5775	5925~40000	5925~40000	-34.47	<=-27	PASS

NOTE: According to the test results of output power, Ant0 is considered to have the highest power, so conducted emission for Multiple mode are performed with this antenna and add 3dBi factor, this factor has been compensated in the test.

Test Graphs as below:

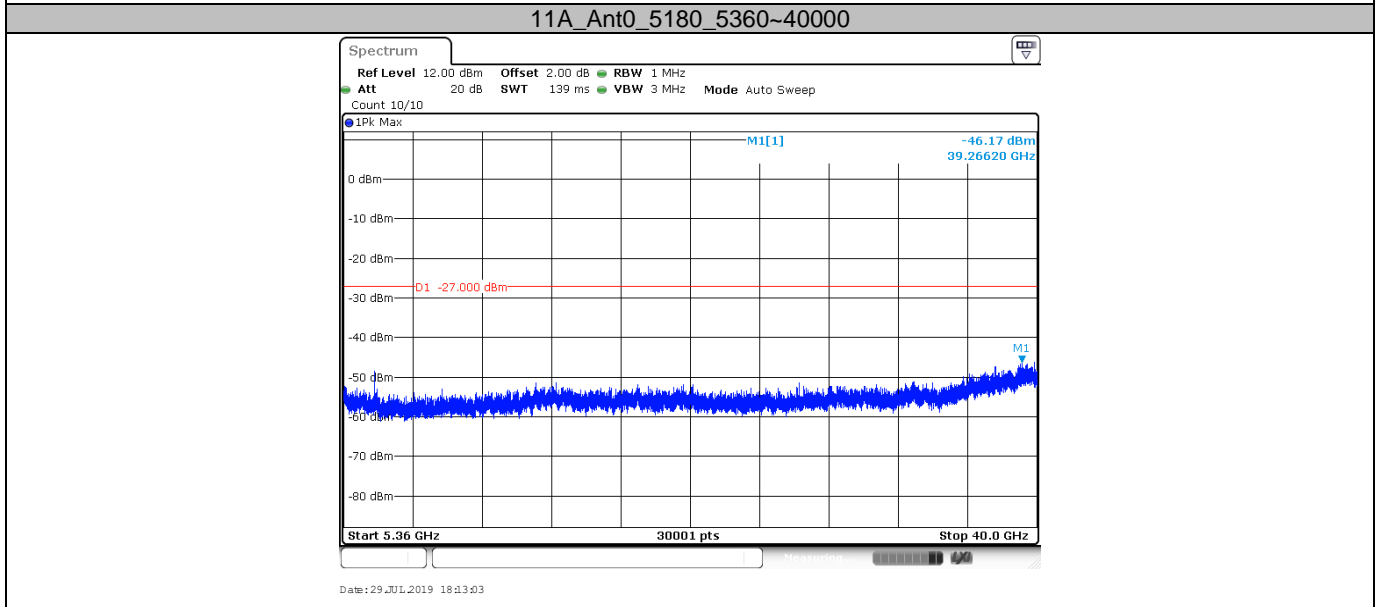
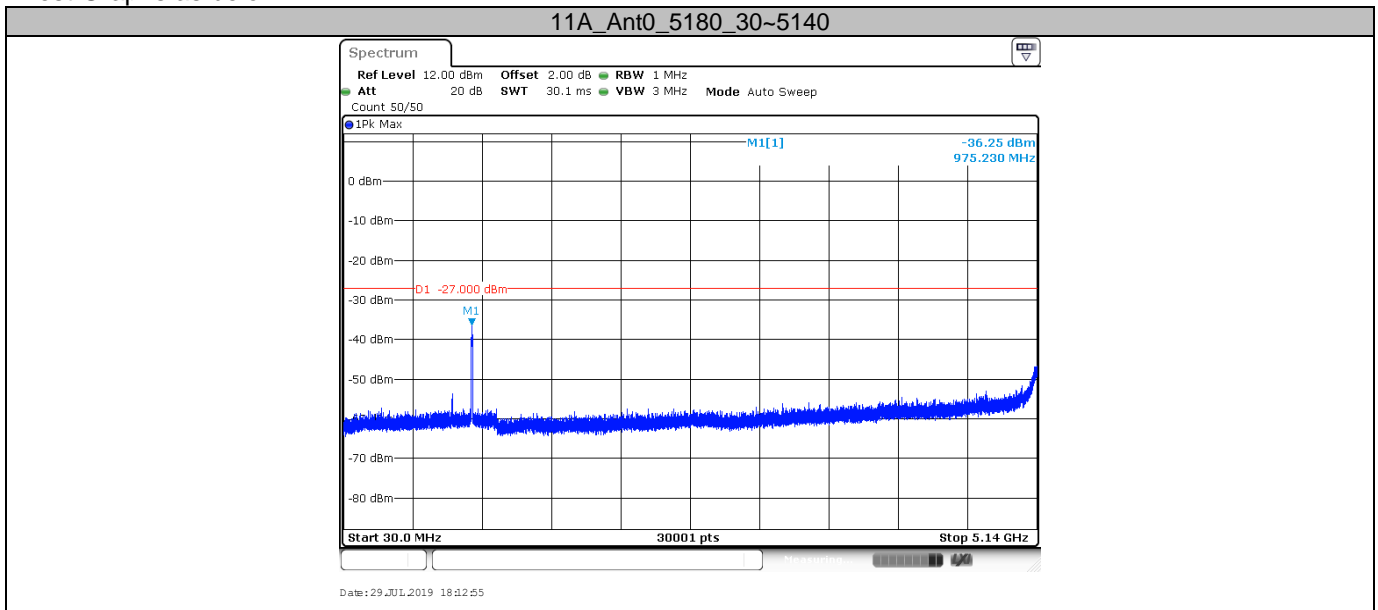

11A_Ant1_5180_30~5140

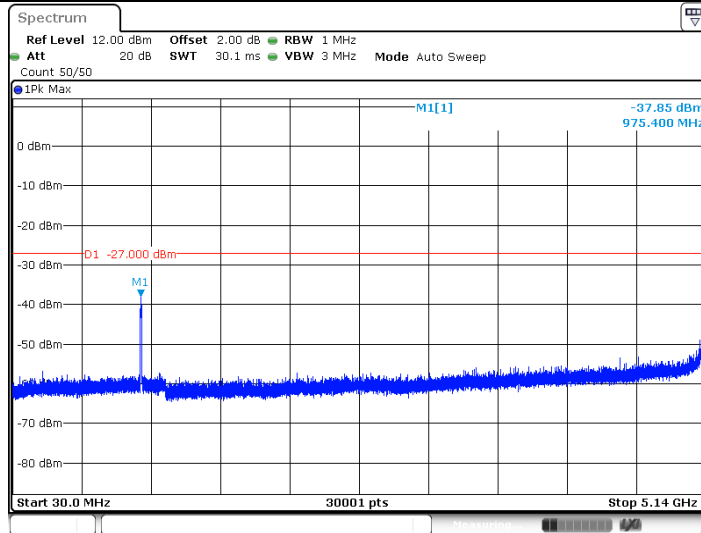

Date: 29 JUL 2019 17:15:15

11A_Ant1_5180_5360~40000

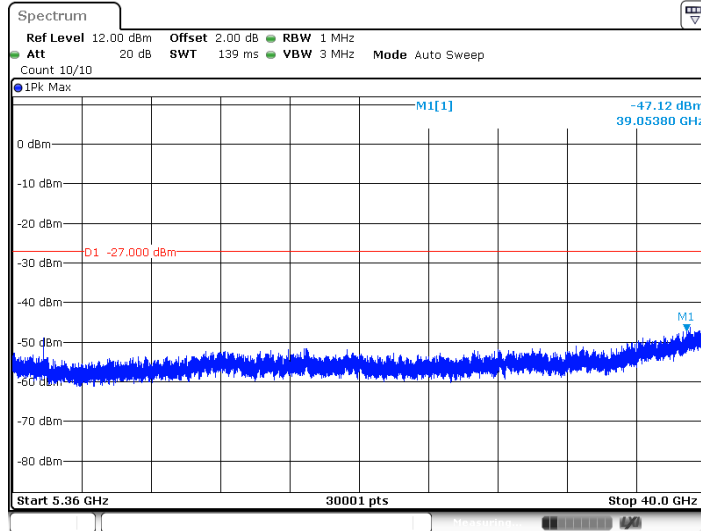

Date: 29 JUL 2019 17:15:24

11A_Ant0_5200_30~5140

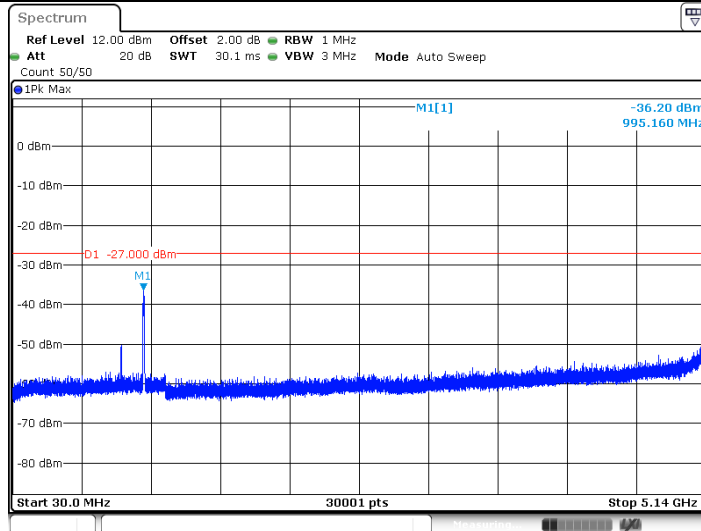

Date: 29 JUL 2019 18:14:33

11A_Ant0_5200_5360~40000

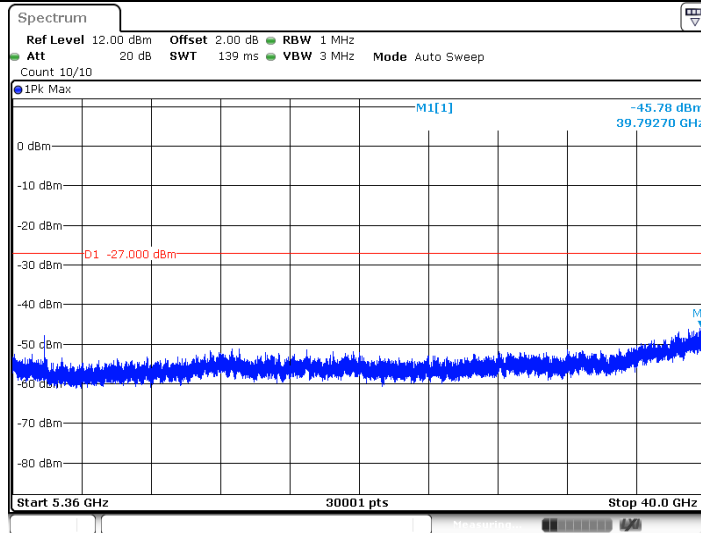

Date: 29 JUL 2019 18:14:41

11A_Ant1_5200_30-5140

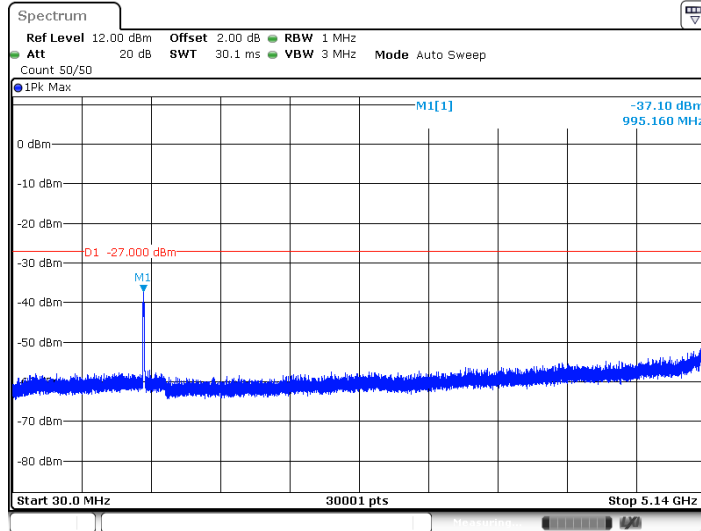

Date: 29 JUL 2019 17:17:37

11A_Ant1_5200_5360-40000

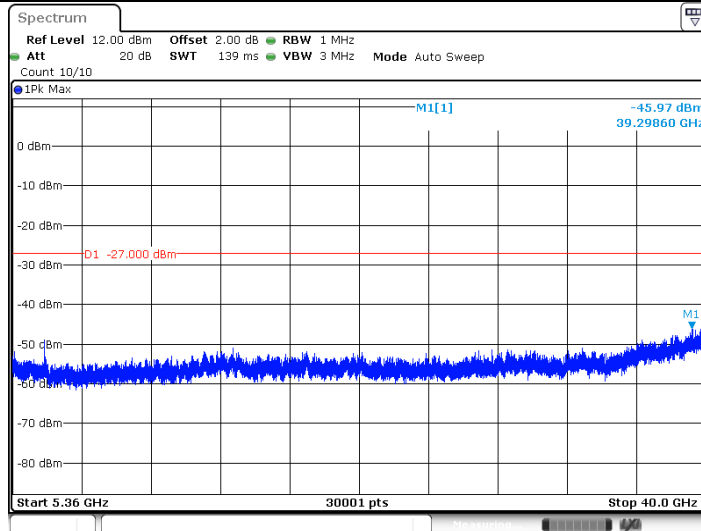

Date: 29 JUL 2019 17:17:46

11A_Ant0_5240_30-5140

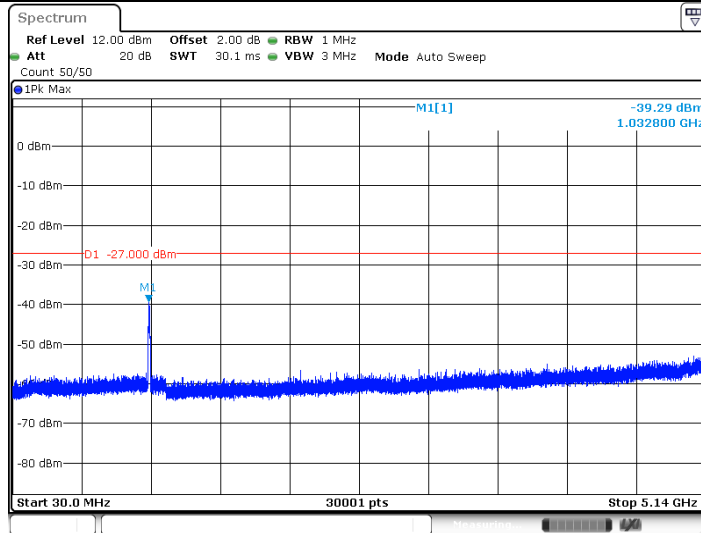

Date: 29 JUL 2019 18:16:20

11A_Ant0_5240_5360~40000

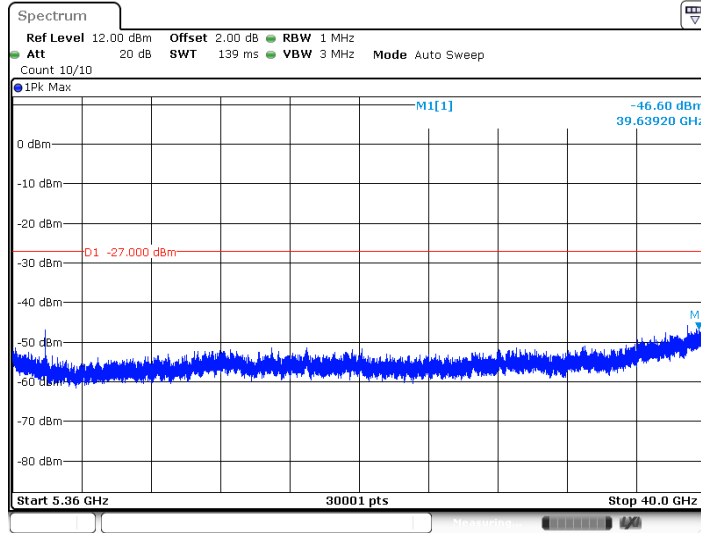

Date: 29 JUL 2019 18:16:28

11A_Ant1_5240_30~5140

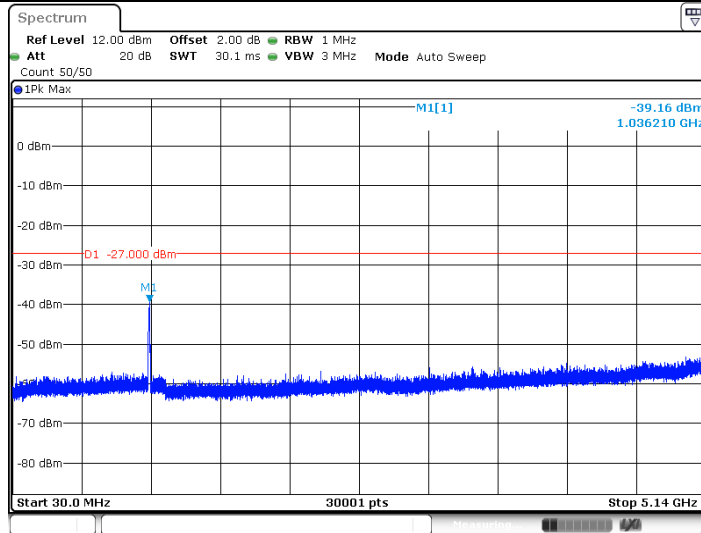

Date: 29 JUL 2019 17:19:41

11A_Ant1_5240_5360~40000

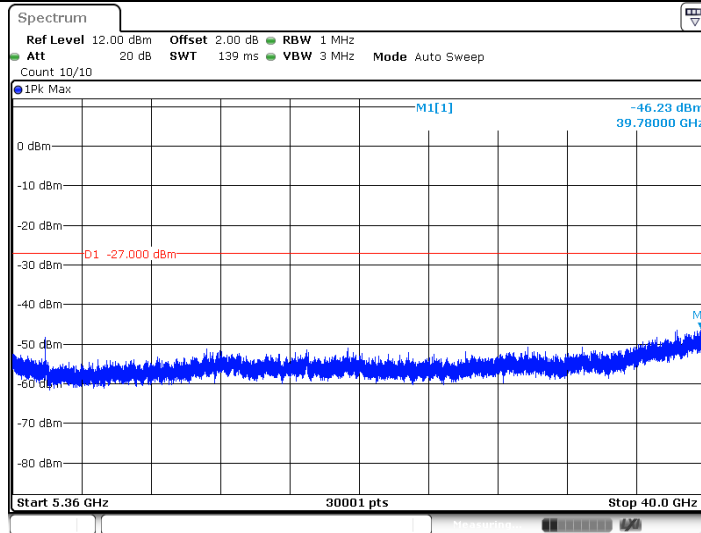

Date: 29 JUL 2019 17:19:50

11A_Ant0_5745_30-5650

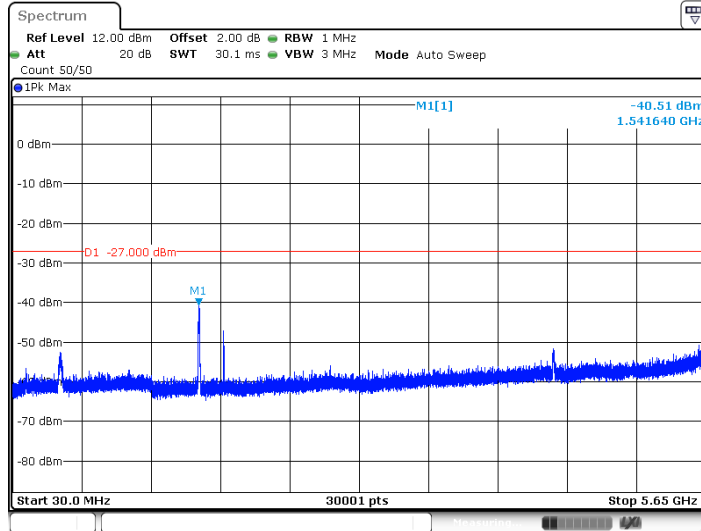

Date: 29 JUL 2019 18:18:32

11A_Ant0_5745_5925-40000

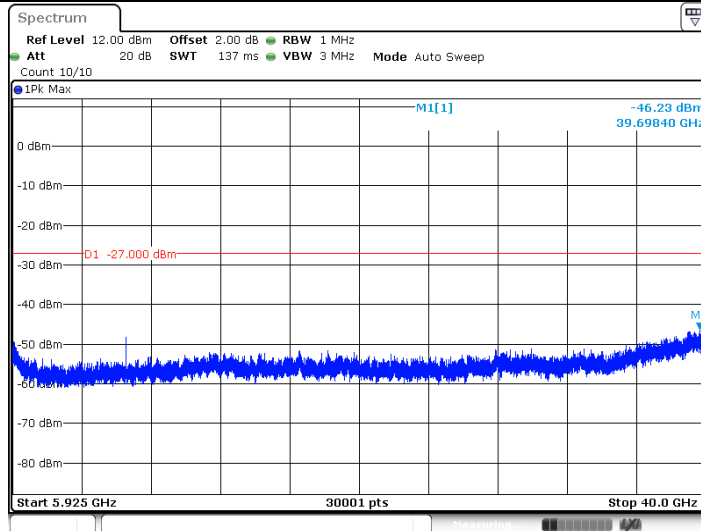

Date: 29 JUL 2019 18:18:41

11A_Ant1_5745_30-5650

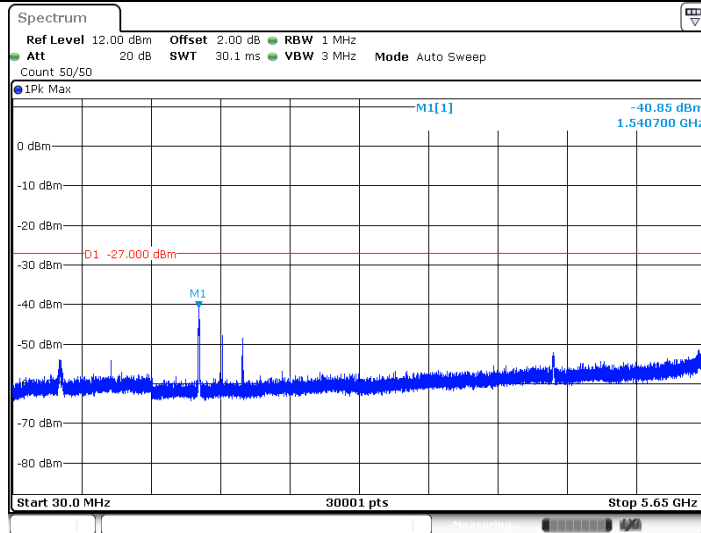

Date: 29 JUL 2019 17:22:11

11A_Ant1_5745_5925~40000

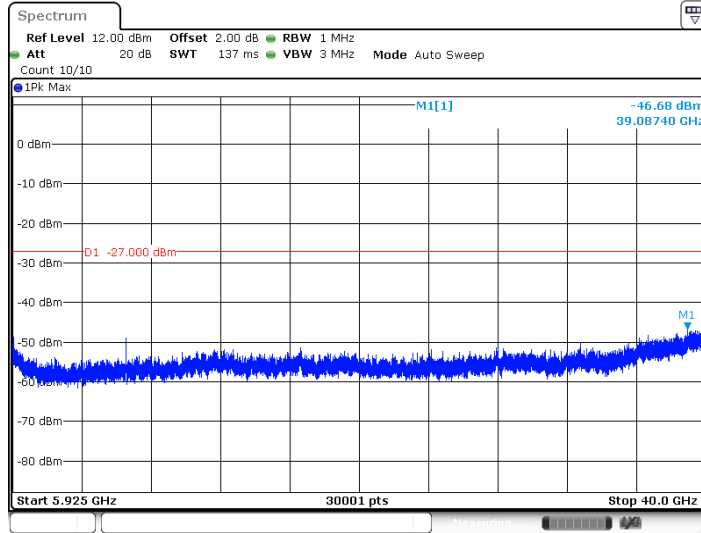

Date: 29 JUL 2019 17:22:19

11A_Ant0_5785_30~5650

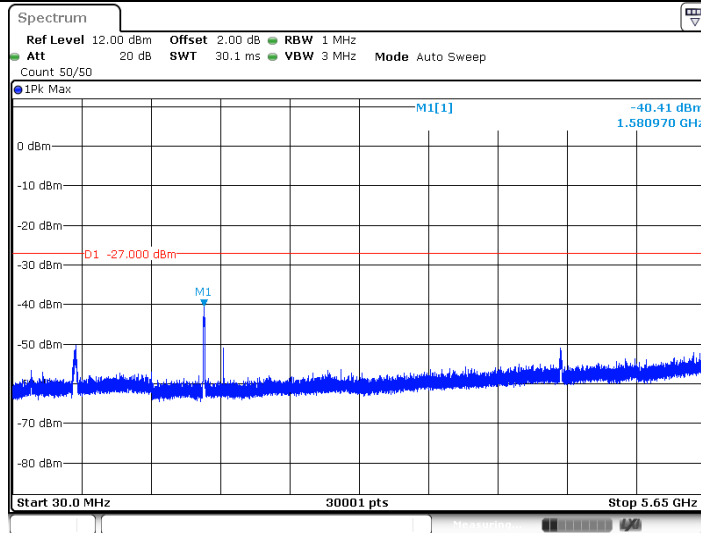

Date: 29 JUL 2019 18:20:22

11A_Ant0_5785_5925~40000

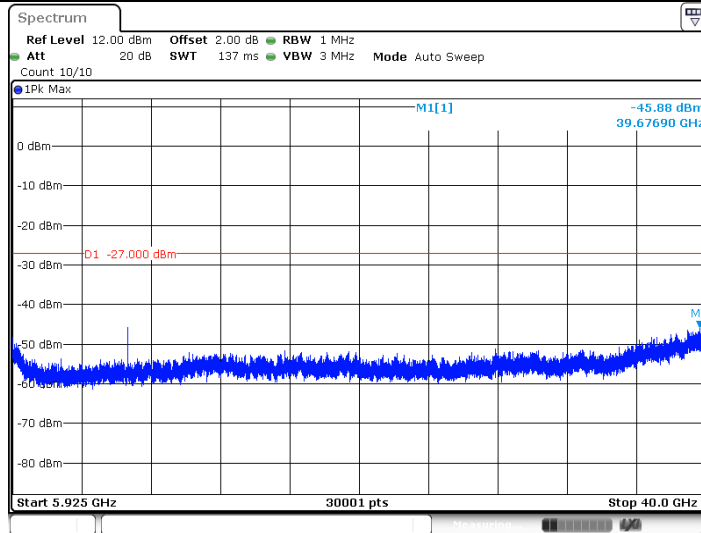

Date: 29 JUL 2019 18:20:31

11A_Ant1_5785_30-5650

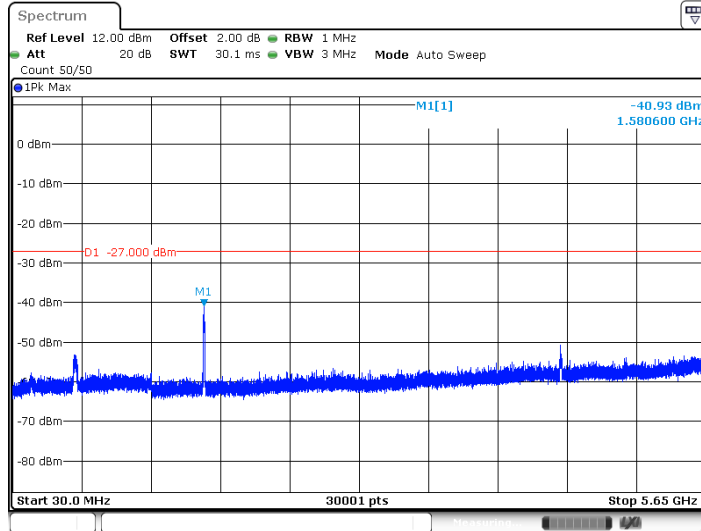

Date: 29 JUL 2019 17:24:49

11A_Ant1_5785_5925-40000

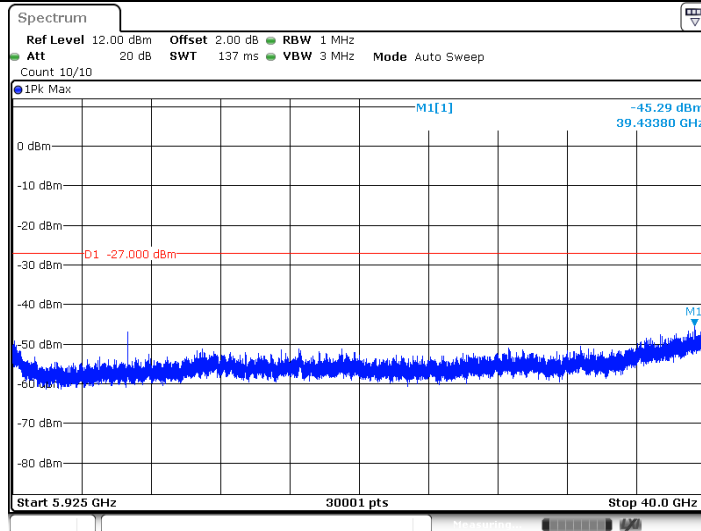

Date: 29 JUL 2019 17:24:58

11A_Ant0_5825_30-5650

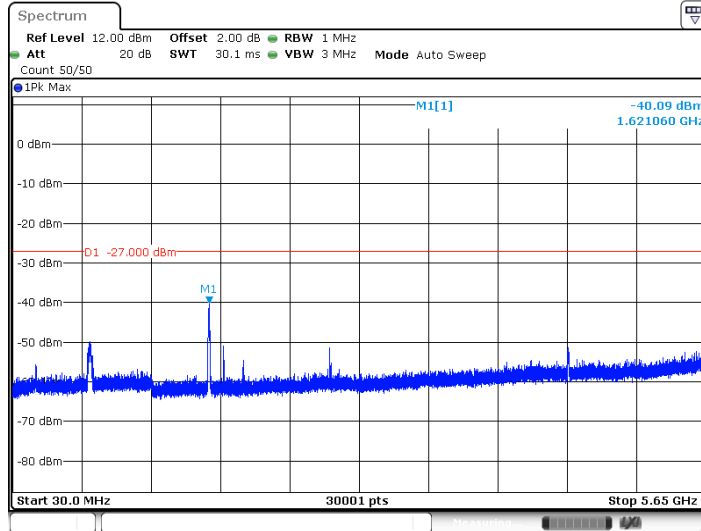

11A_Ant0_5825_5925~40000

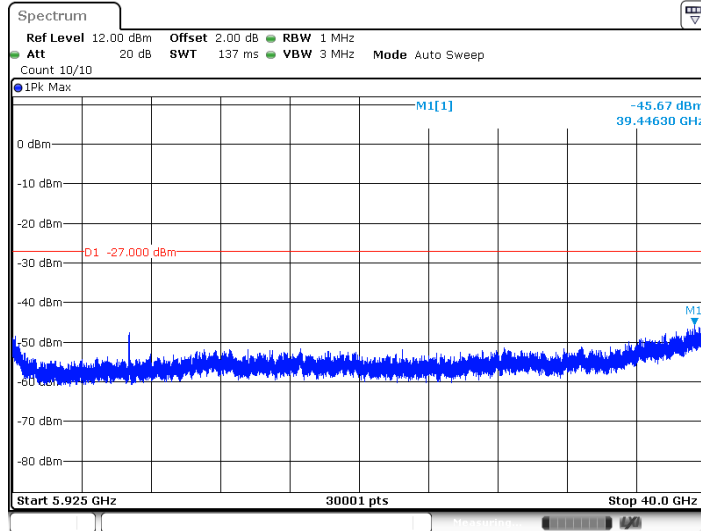

11A_Ant1_5825_30~5650

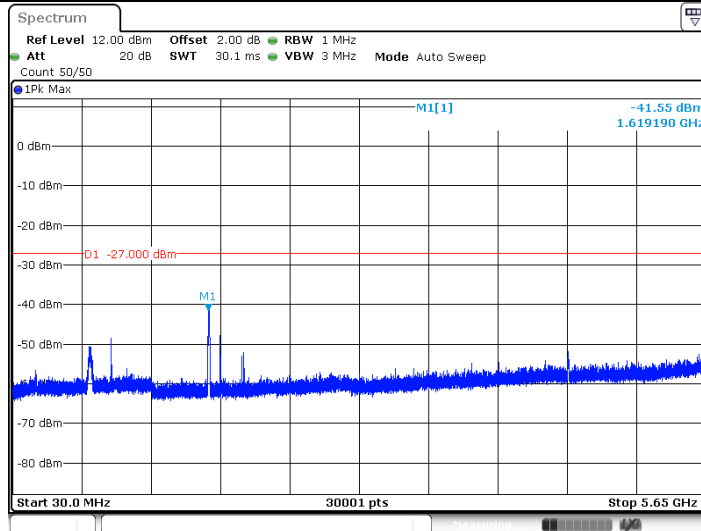

11A_Ant1_5825_5925~40000

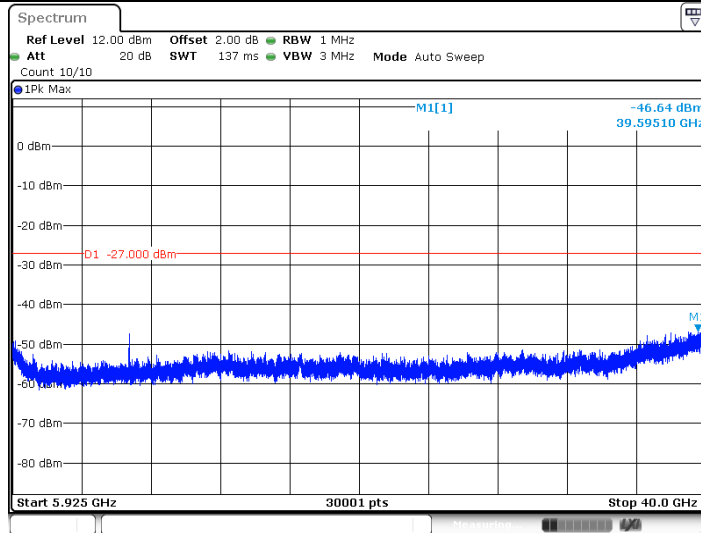

11N20MIMO_5180_30~5140

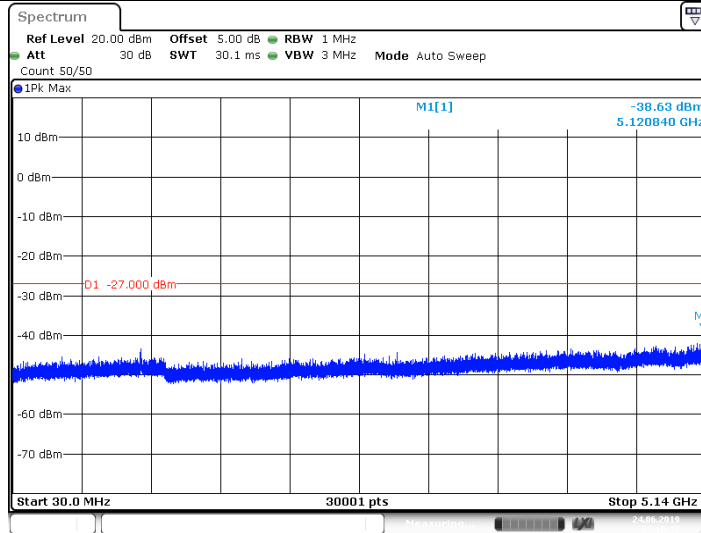

11N20MIMO_5180_5360~40000

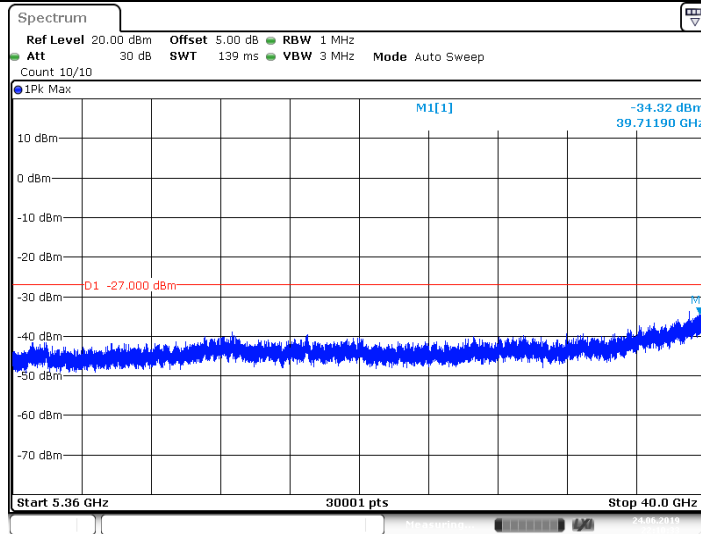

11N20MIMO_5200_30~5140

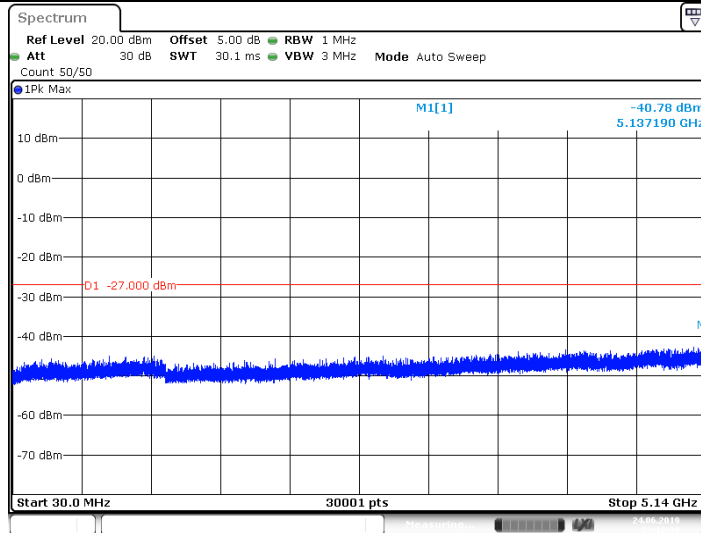

Date: 24 JUN 2019 22:12:38

11N20MIMO_5200_5360~40000

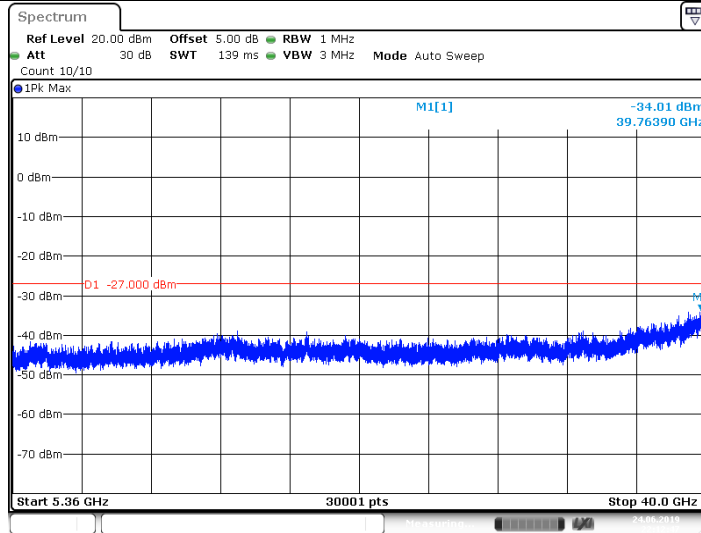

Date: 24 JUN 2019 22:12:47

11N20MIMO_5240_30~5140

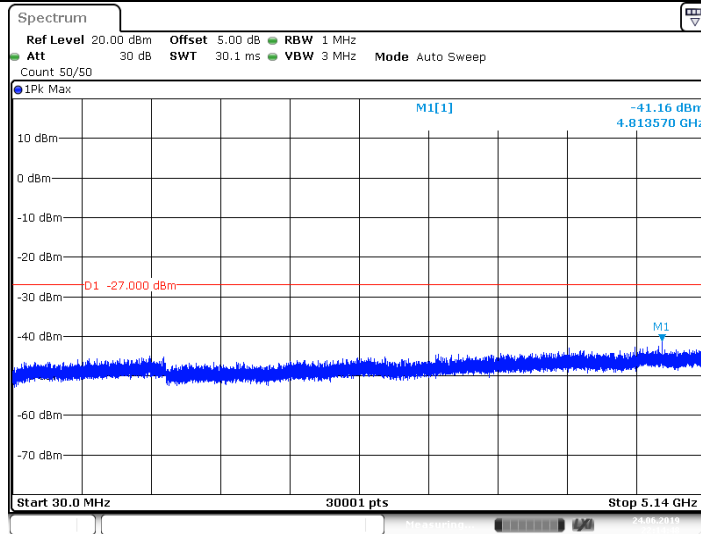

Date: 24 JUN 2019 22:14:49

11N20MIMO_5240_5360~40000

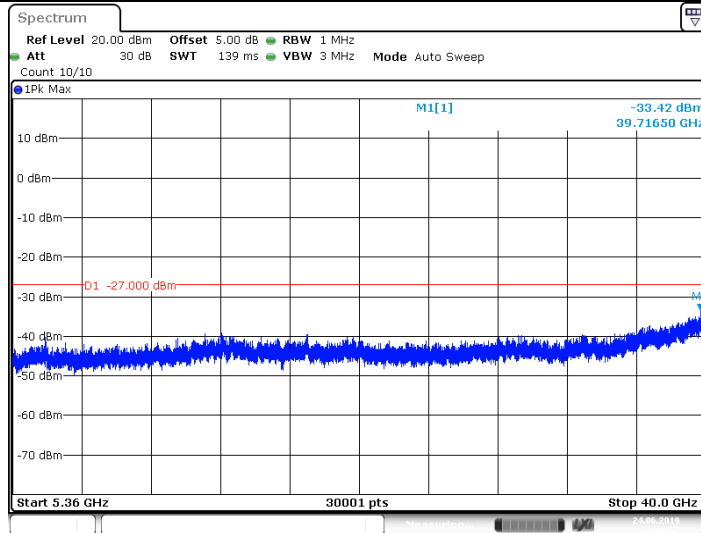

Date: 24 JUN 2019 22:14:58

11N20MIMO_5745_30~5650

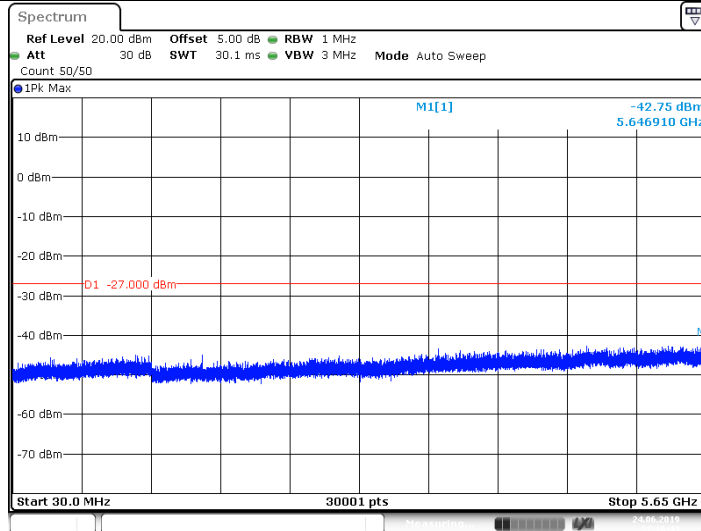

Date: 24 JUN 2019 22:16:43

11N20MIMO_5745_5925~40000

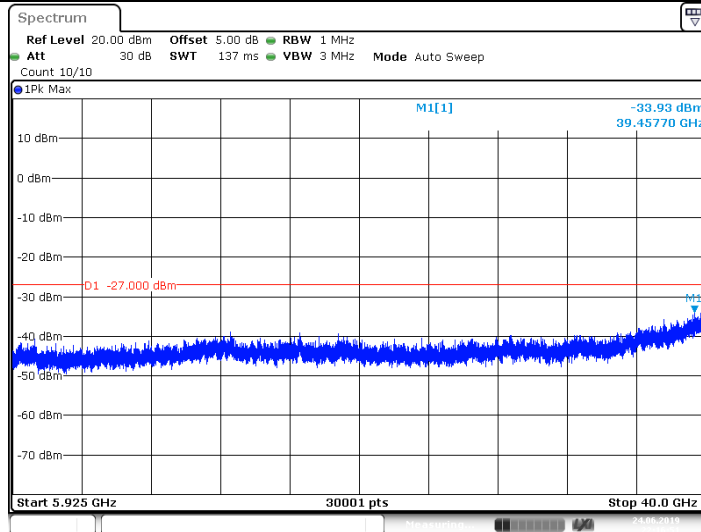

Date: 24 JUN 2019 22:16:51

11N20MIMO_5785_30~5650

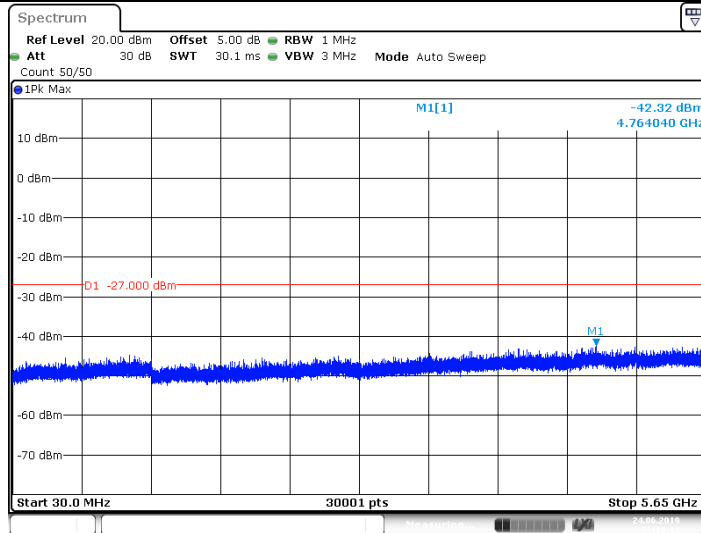

Date: 24 JUN 2019 22:18:14

11N20MIMO_5785_5925~40000

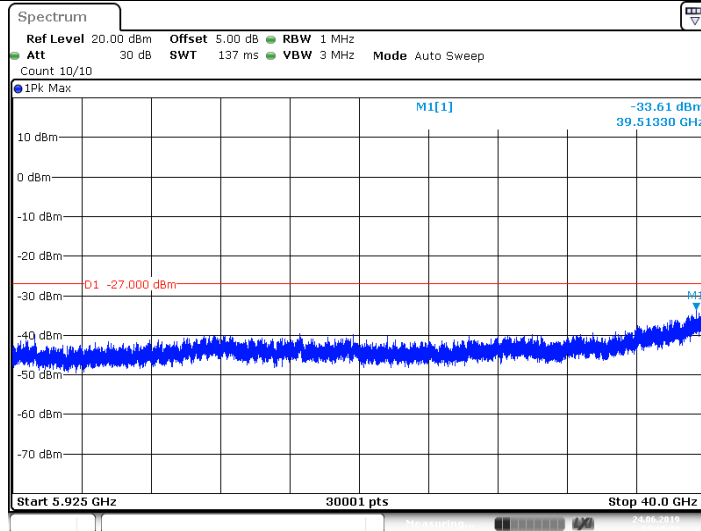

Date: 24 JUN 2019 22:18:22

11N20MIMO_5825_30~5650

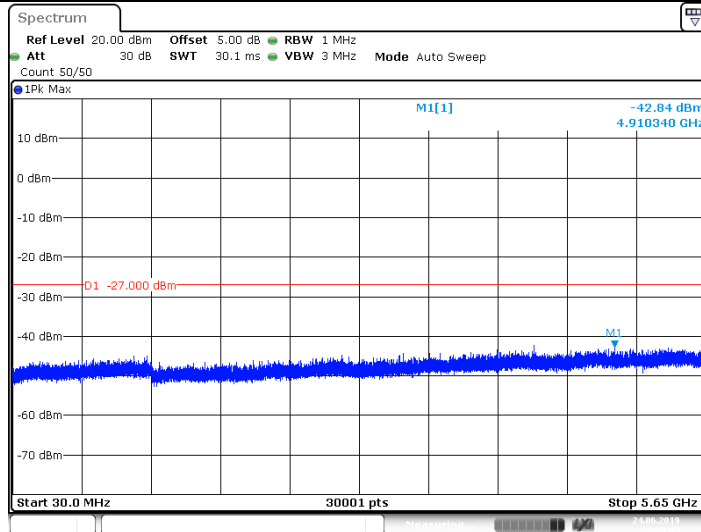

Date: 24 JUN 2019 22:20:05

11N20MIMO_5825_5925~40000

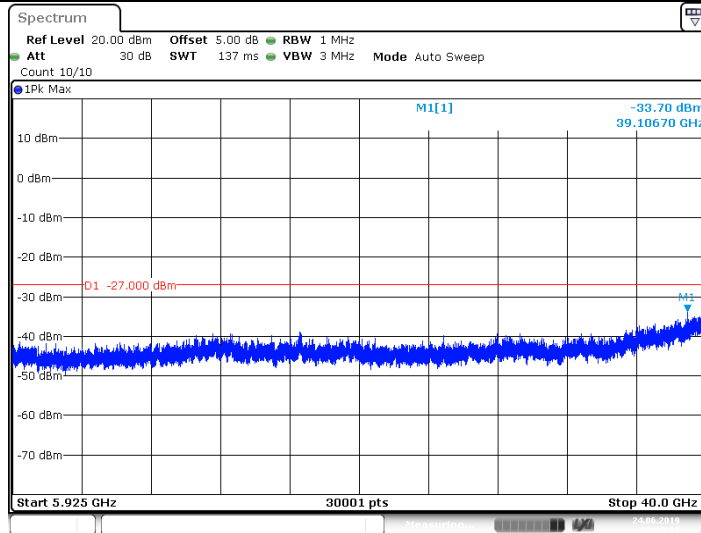

Date: 24 JUN 2019 22:20:13

11N40MIMO_5190_30~5140

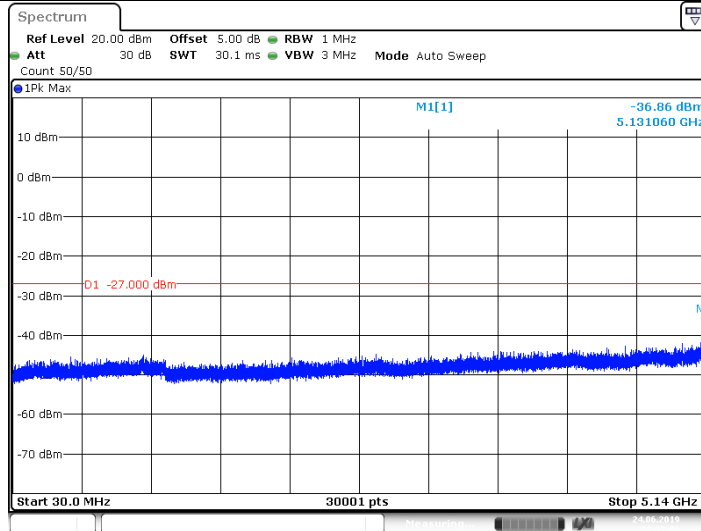

Date: 24 JUN 2019 22:22:07

11N40MIMO_5190_5360~40000

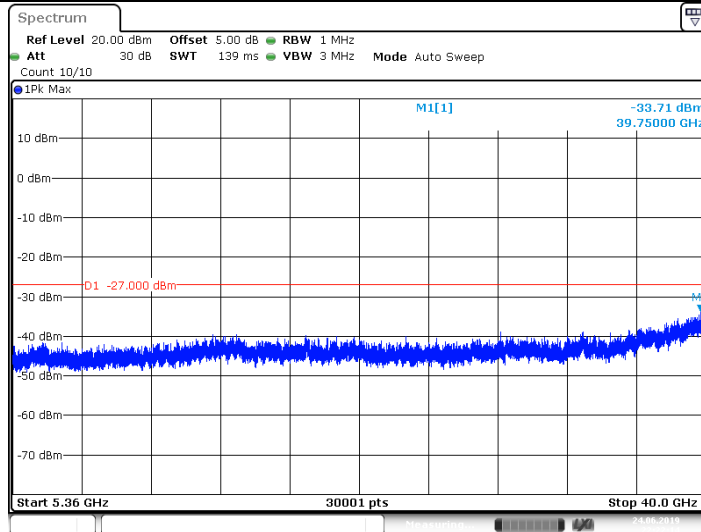

Date: 24 JUN 2019 22:22:15

11N40MIMO_5230_30~5140

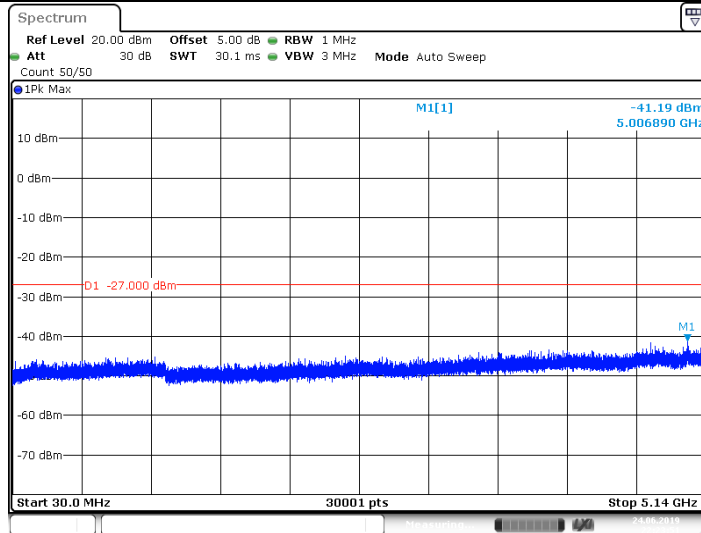

Date: 24 JUN 2019 22:23:51

11N40MIMO_5230_5360~40000

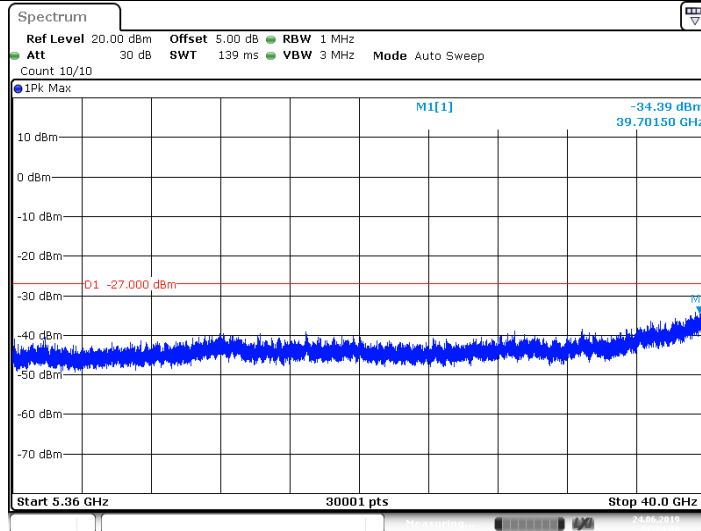

Date: 24 JUN 2019 22:24:00

11N40MIMO_5755_30~5650

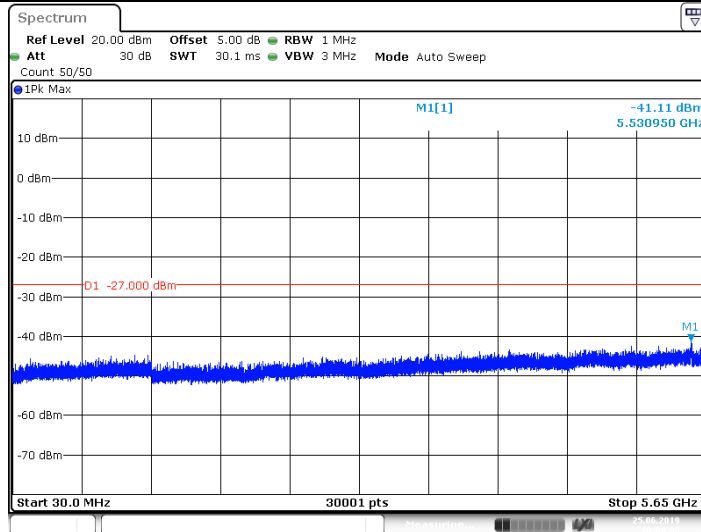

Date: 25 JUN 2019 18:04:06

11N40MIMO_5755_5925~40000

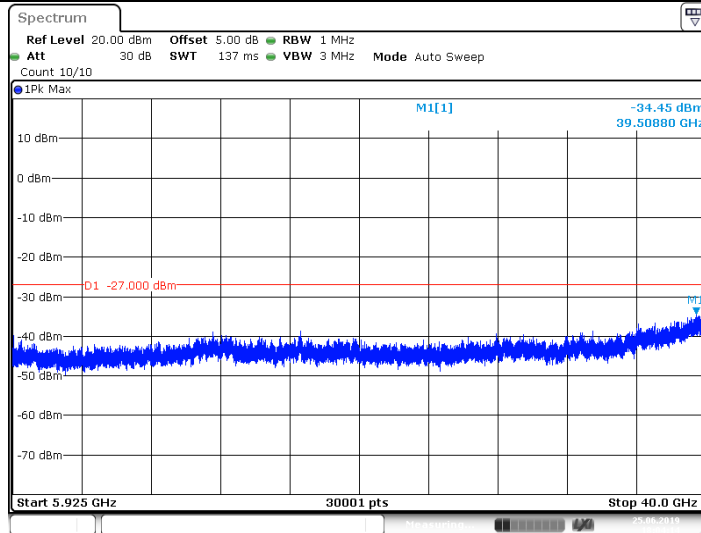

Date: 25 JUN 2019 18:04:15

11N40MIMO_5795_30~5650

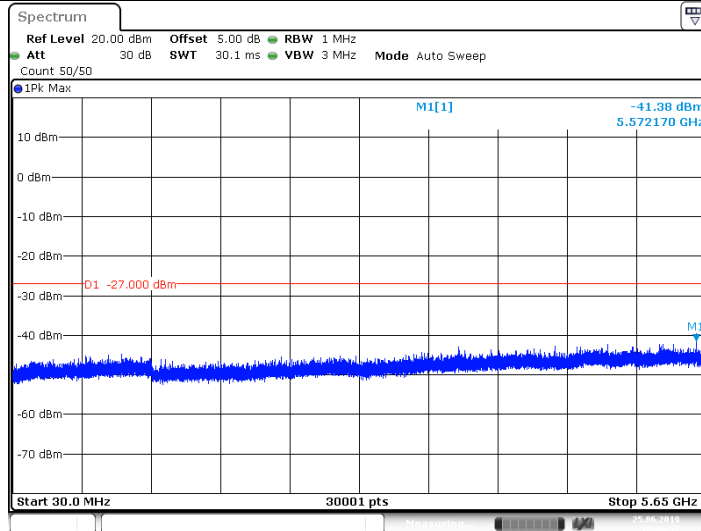

Date: 25 JUN 2019 18:06:57

11N40MIMO_5795_5925~40000

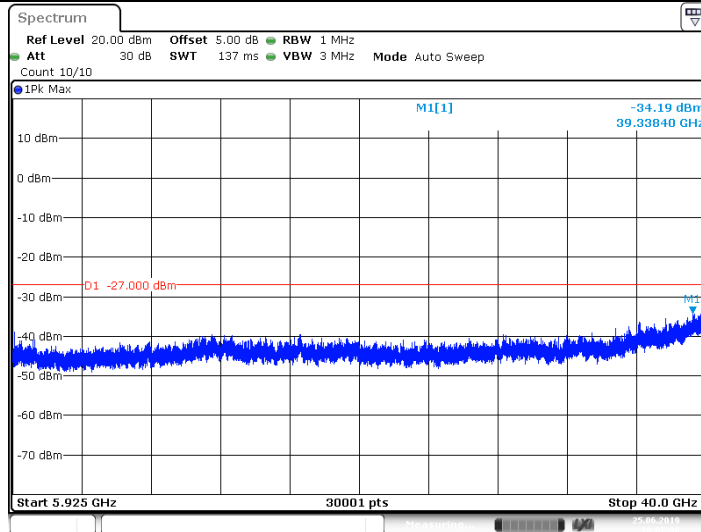

Date: 25 JUN 2019 18:07:06

11AC20MIMO_5180_30~5140

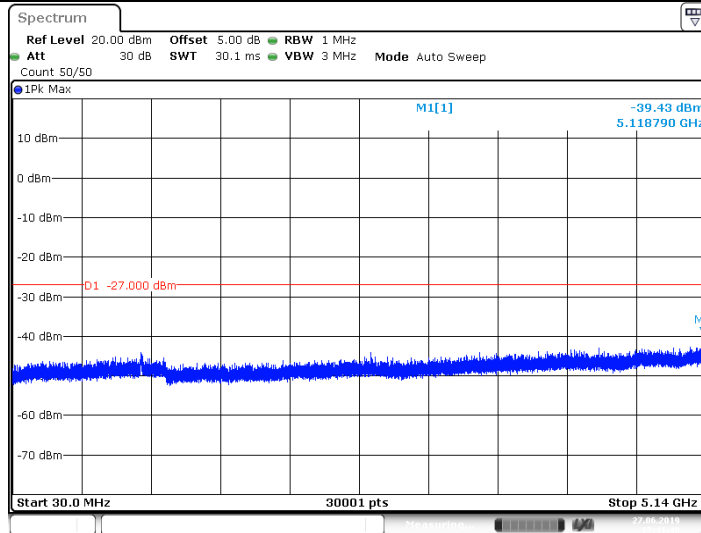

Date: 27 JUN 2019 17:41:49

11AC20MIMO_5180_5360~40000

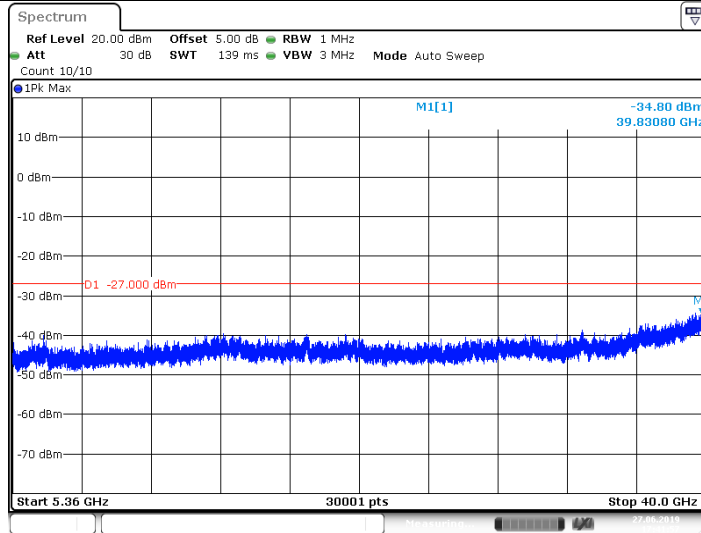

Date: 27 JUN 2019 17:41:57

11AC20MIMO_5200_30~5140

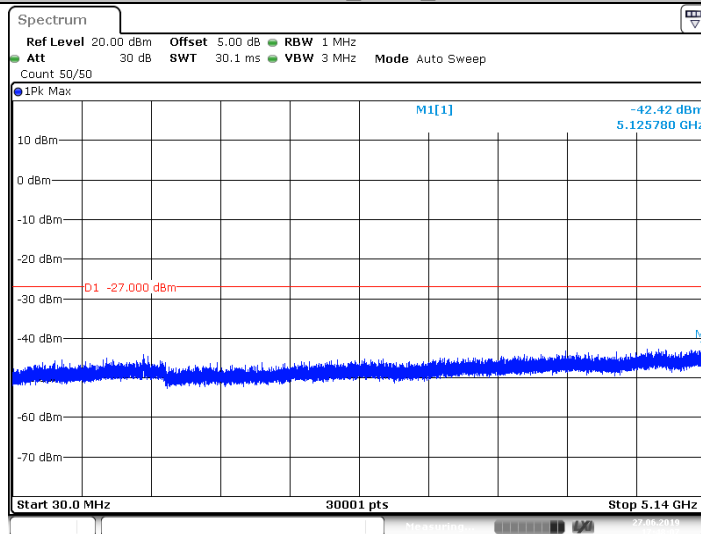

Date: 27 JUN 2019 17:48:08

11AC20MIMO_5200_5360~40000

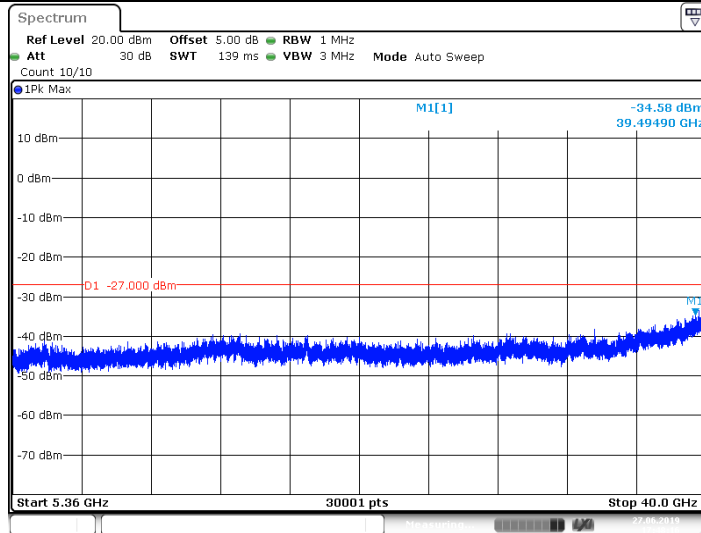

Date: 27 JUN 2019 17:48:16

11AC20MIMO_5240_30~5140

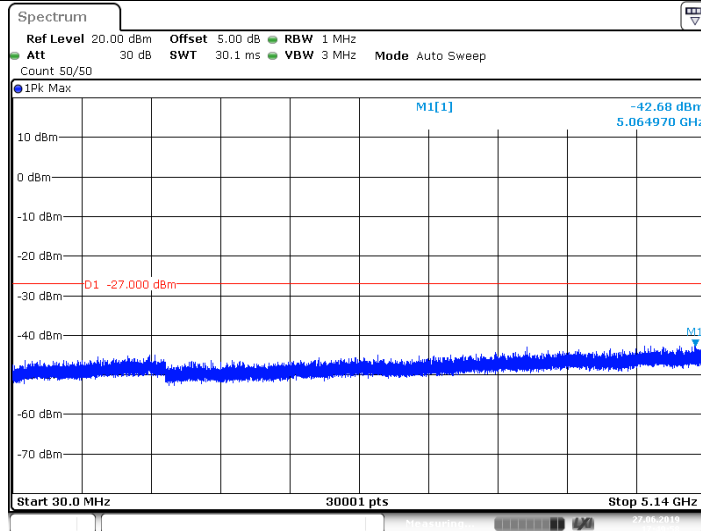

Date: 27 JUN 2019 17:49:58

11AC20MIMO_5240_5360~40000

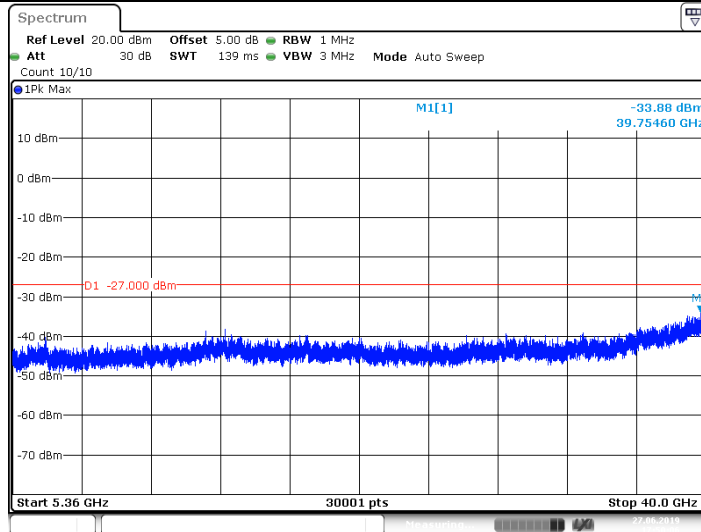

Date: 27 JUN 2019 17:50:07

11AC20MIMO_5745_30~5650

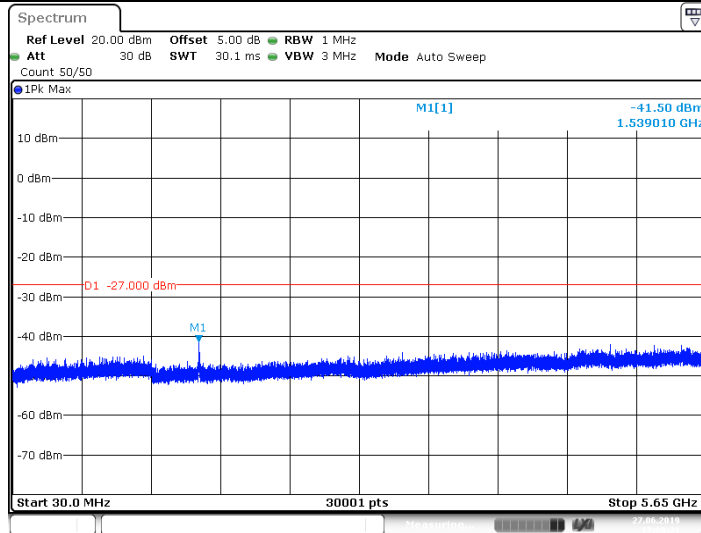

Date: 27 JUN 2019 17:00:21

11AC20MIMO_5745_5925~40000

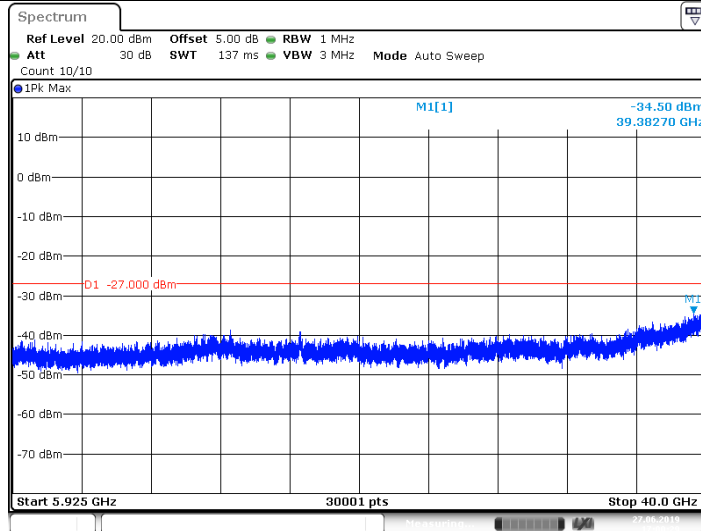

Date: 27 JUN 2019 17:00:30

11AC20MIMO_5785_30~5650

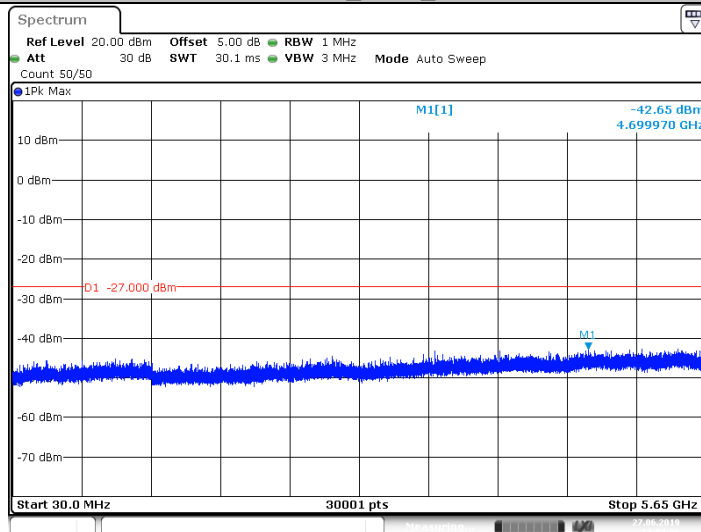

Date: 27 JUN 2019 17:04:06

11AC20MIMO_5785_5925~40000

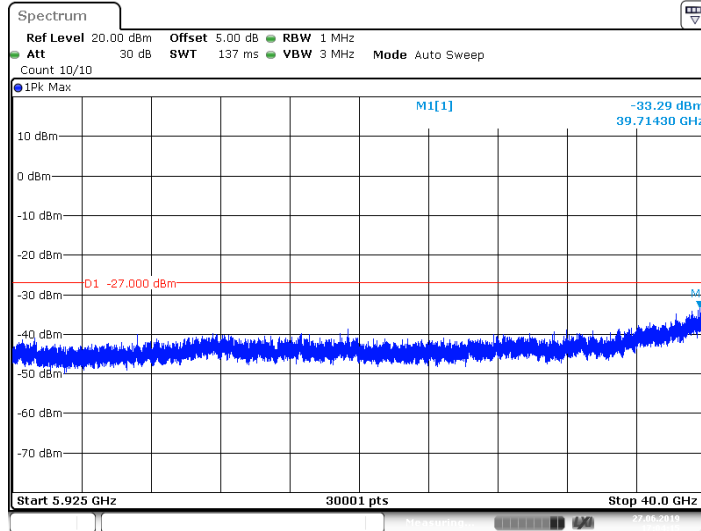

Date: 27 JUN 2019 17:04:15

11AC20MIMO_5825_30~5650

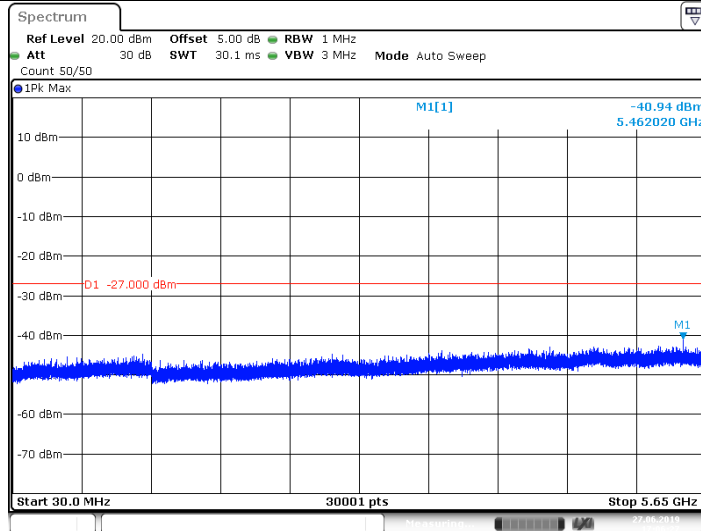

Date: 27 JUN 2019 17:06:27

11AC20MIMO_5825_5925~40000

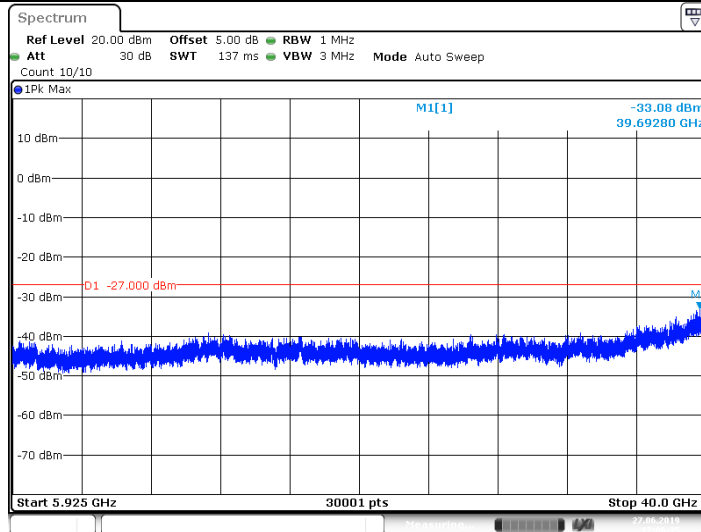

Date: 27 JUN 2019 17:06:36

11AC40MIMO_5190_30~5140

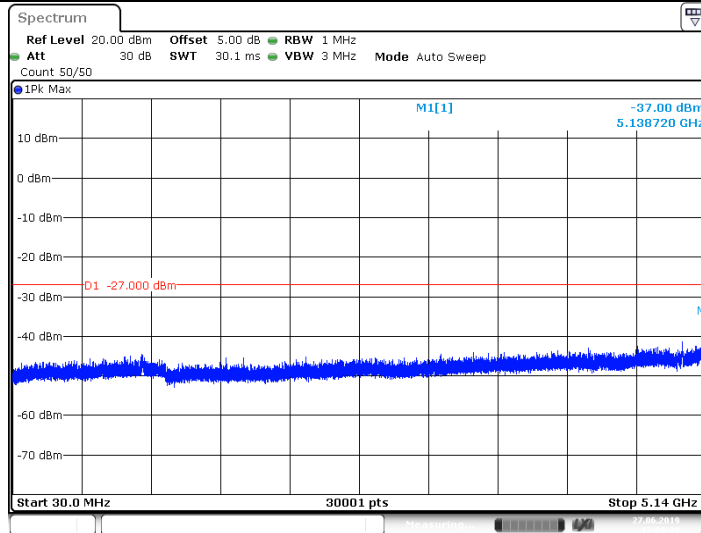

Date: 27 JUN 2019 17:09:30

11AC40MIMO_5190_5360~40000

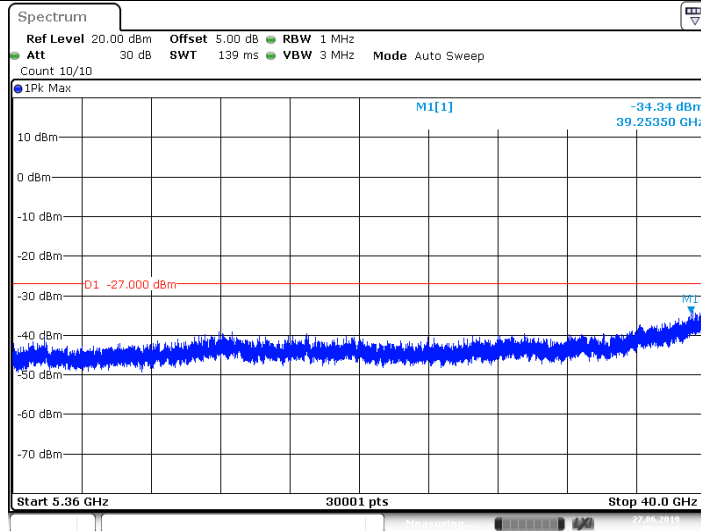

Date: 27 JUN 2019 17:09:39

11AC40MIMO_5230_30~5140

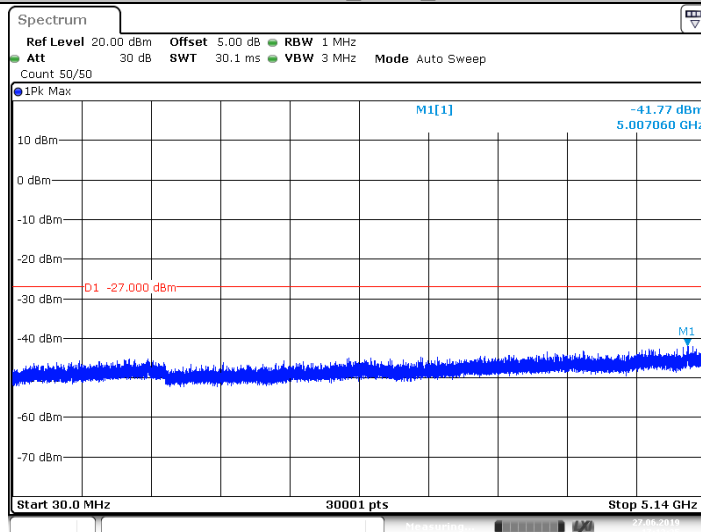

Date: 27 JUN 2019 17:12:35

11AC40MIMO_5230_5360~40000

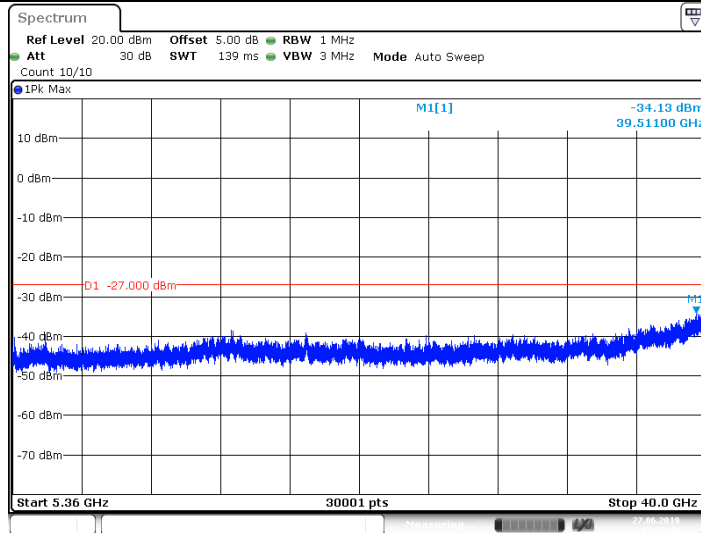

Date: 27 JUN 2019 17:12:44

11AC40MIMO_5755_30~5650

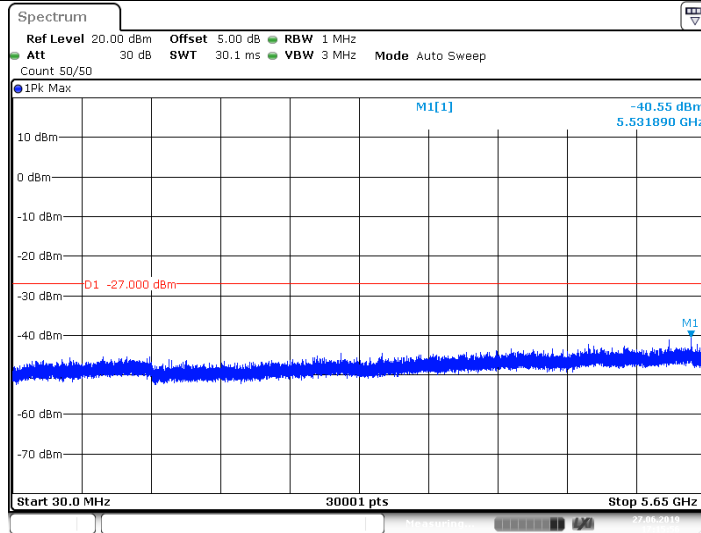

Date: 27 JUN 2019 17:15:56

11AC40MIMO_5755_5925~40000

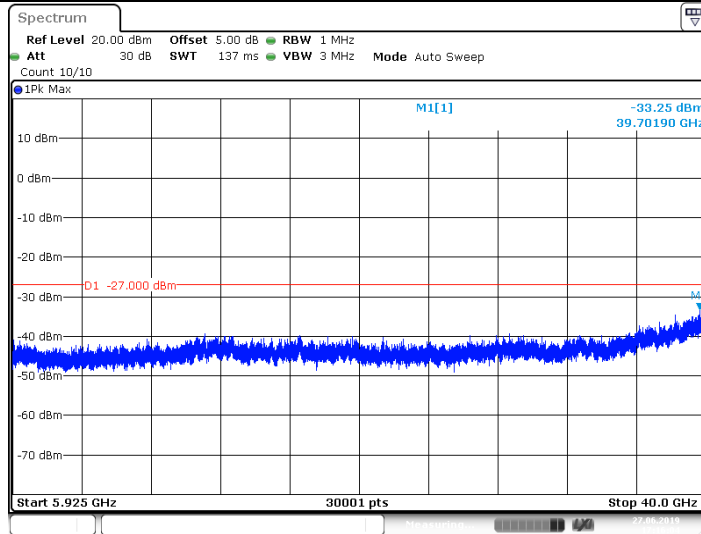

Date: 27 JUN 2019 17:16:04

11AC40MIMO_5795_30~5650

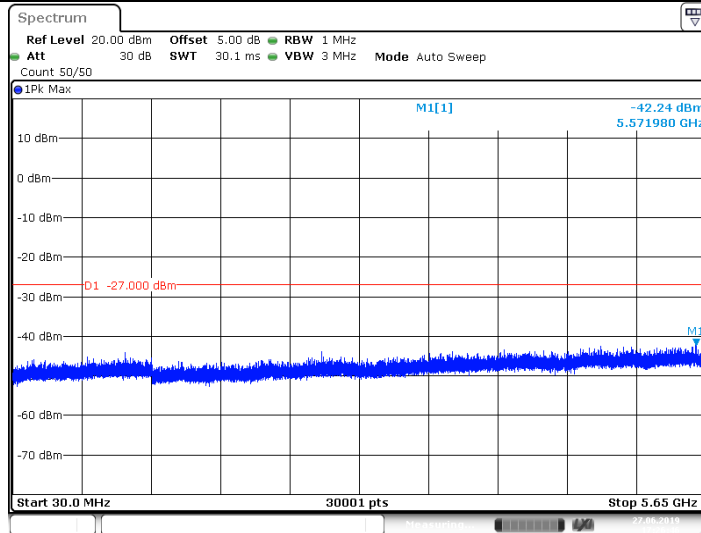

Date: 27 JUN 2019 17:26:46

11AC40MIMO_5795_5925~40000

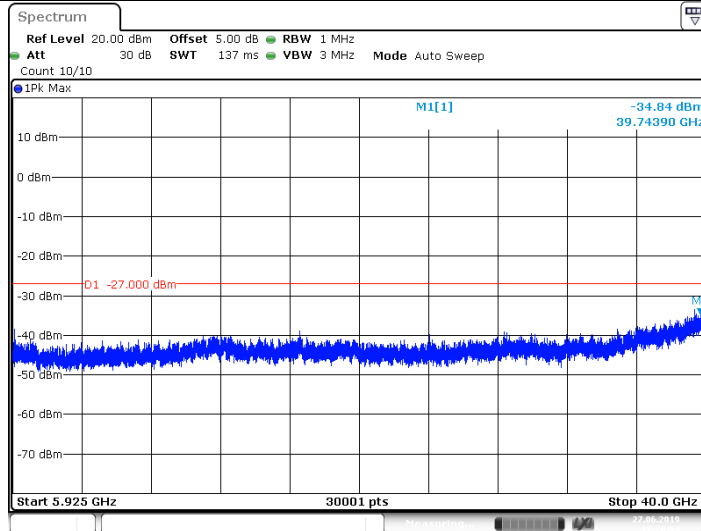

Date: 27 JUN 2019 17:26:54

11AC40MIMO_5210_30~5140

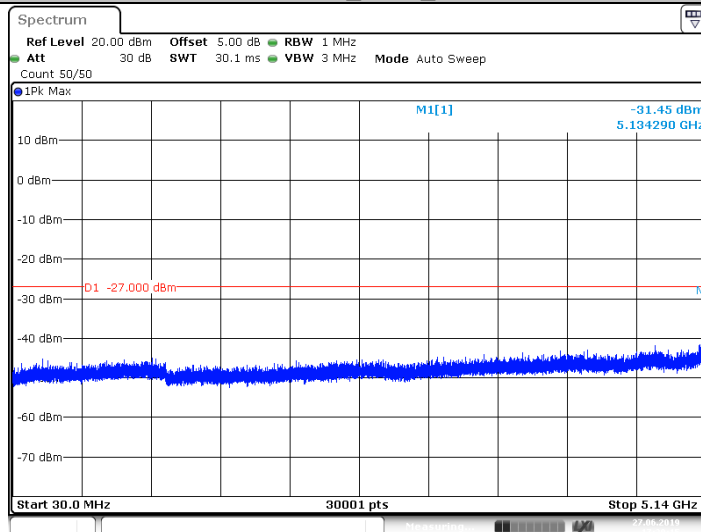

Date: 27 JUN 2019 17:29:15

11AC80MIMO_5210_5360~40000

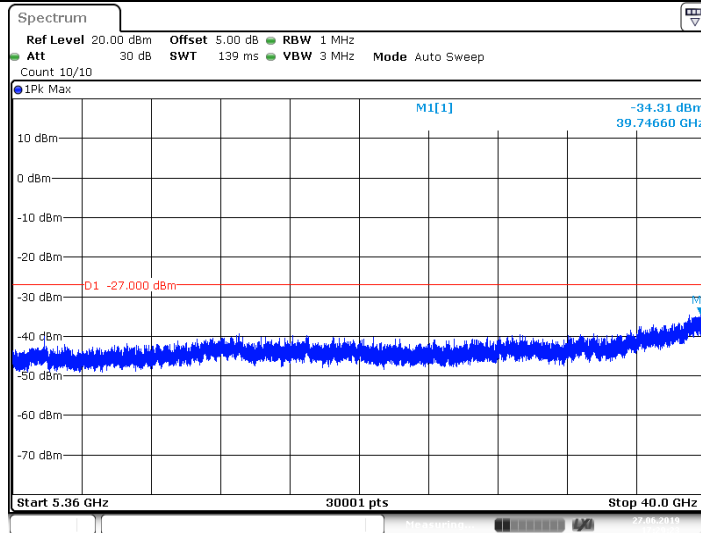

Date: 27 JUN 2019 17:29:23

11AC80MIMO_5775_30~5650

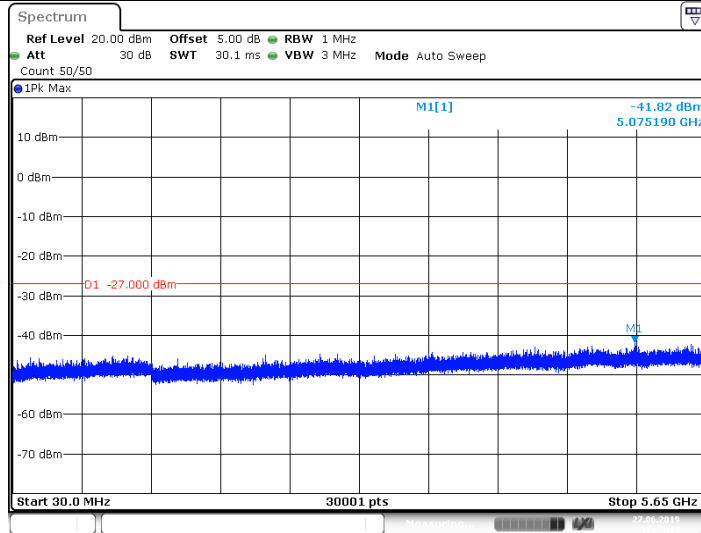

Date: 27 JUN 2019 17:32:15

11AC80MIMO_5775_5925~40000

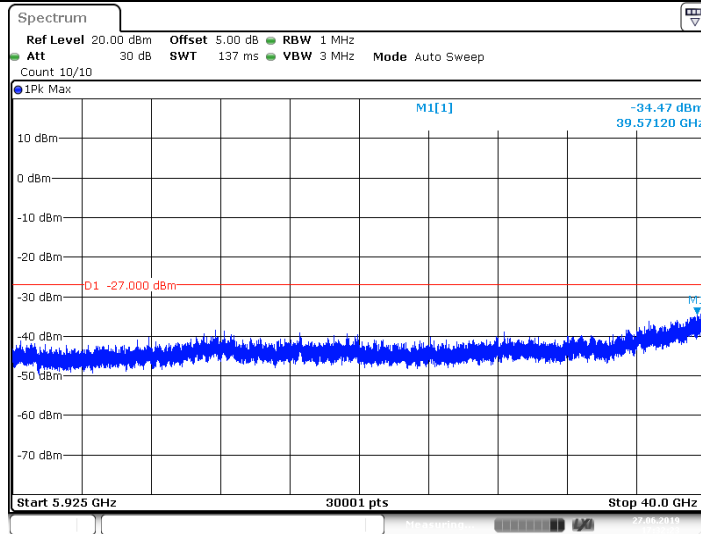

Date: 27 JUN 2019 17:32:24



Transmitting spurious emission test result as below (Band edge measurements):

TestMode	Antenna	ChName	Channel (MHz)	Result (dBm)	Limit (dBm)	Verdict
11A_SISO	Ant0	Low	5180	-52.6	<=-27	PASS
	Ant1	Low	5180	-51.45	<=-27	PASS
	Ant0	High	5240	-54.13	<=-27	PASS
	Ant1	High	5240	-53.35	<=-27	PASS
11N20MIMO	Ant0+3dBi (NOTE)	Low	5180	-48.72	<=-27	PASS
		High	5240	-51.87	<=-27	PASS
11N40MIMO	Ant0+3dBi (NOTE)	Low	5190	-47.53	<=-27	PASS
		High	5230	-49.45	<=-27	PASS
11AC20MIMO	Ant0+3dBi (NOTE)	Low	5180	-49.8	<=-27	PASS
		High	5240	-52.52	<=-27	PASS
11AC40MIMO	Ant0+3dBi (NOTE)	Low	5190	-43.63	<=-27	PASS
		High	5230	-47.48	<=-27	PASS
11AC80MIMO	Ant0+3dBi (NOTE)	Low	5210	-41.88	<=-27	PASS
		High	5210	-52.06	<=-27	PASS

TestMode	Antenna	ChName	Channel (MHz)	FreqRange (MHz)	Result (dBm)	Limit (dBm)	Verdict
11A_SISO	Ant0	Low	5745	5650~5700	-50.43	9.75	PASS
		Low	5745	5700~5720	-32.92	15.60	PASS
		Low	5745	5720~5725	-22.77	27.00	PASS
		Low	5745	5645~5650	-55.73	-27	PASS
	Ant1	Low	5745	5650~5700	-51.05	7.16	PASS
		Low	5745	5700~5720	-34.61	15.60	PASS
		Low	5745	5720~5725	-23.76	27.00	PASS
		Low	5745	5645~5650	-55.63	-27	PASS
	Ant0	High	5825	5850~5855	-35.28	15.80	PASS
		High	5825	5855~5875	-40.22	10.49	PASS
		High	5825	5875~5925	-50.78	-24.88	PASS
		High	5825	5925~5935	-54.22	-27	PASS
	Ant1	High	5825	5850~5855	-37.11	16.25	PASS
		High	5825	5855~5875	-41.8	10.49	PASS
		High	5825	5875~5925	-50.81	-22.85	PASS
		High	5825	5925~5935	-54.98	-27	PASS
11N20MIMO	Ant0+3dBi (NOTE)	Low	5745	5650~5700	-50.89	4.08	PASS
		Low	5745	5700~5720	-50.54	15.18	PASS
		Low	5745	5720~5725	-48.24	22.06	PASS
		Low	5745	5645~5650	-54.19	-27	PASS
		High	5825	5850~5855	-48.79	26.51	PASS
		High	5825	5855~5875	-46.52	11.31	PASS
		High	5825	5875~5925	-50.63	-26.90	PASS
		High	5825	5925~5935	-52.71	-27	PASS
11N40MIMO	Ant0+3dBi (NOTE)	Low	5755	5650~5700	-46.11	8.97	PASS
		Low	5755	5700~5720	-37.12	15.25	PASS
		Low	5755	5720~5725	-36.41	16.79	PASS
		Low	5755	5645~5650	-51.28	-27	PASS
		High	5795	5850~5855	-47.42	24.03	PASS
		High	5795	5855~5875	-49.47	11.04	PASS
		High	5795	5875~5925	-50.15	-26.13	PASS
11AC20MIMO	Ant0+3dBi (NOTE)	Low	5745	5650~5700	-50.87	8.89	PASS
		Low	5745	5700~5720	-47.49	15.55	PASS
		Low	5745	5720~5725	-44.99	24.72	PASS
		Low	5745	5645~5650	-54.45	-27	PASS
		High	5825	5850~5855	-45.85	23.38	PASS
		High	5825	5855~5875	-48.68	10.60	PASS
		High	5825	5875~5925	-49.7	-11.41	PASS
11AC40MIMO	Ant0+3dBi	Low	5755	5650~5700	-48.28	8.10	PASS



	(NOTE)	Low	5755	5700~5720	-41.93	14.49	PASS
		Low	5755	5720~5725	-42.59	15.90	PASS
		Low	5755	5645~5650	-52.97	-27	PASS
		High	5795	5850~5855	-48.98	26.75	PASS
		High	5795	5855~5875	-49.66	10.17	PASS
		High	5795	5875~5925	-48.47	-24.19	PASS
		High	5795	5925~5935	-51.73	-27	PASS
11AC80MIMO	Ant0+3dBi (NOTE)	Low	5775	5650~5700	-42.33	9.86	PASS
		Low	5775	5700~5720	-38.53	15.23	PASS
		Low	5775	5720~5725	-38.98	18.74	PASS
		Low	5775	5645~5650	-52.24	-27	PASS
		High	5775	5850~5855	-38.03	16.23	PASS
		High	5775	5855~5875	-37.84	11.91	PASS
		High	5775	5875~5925	-44.76	-25.85	PASS
		High	5775	5925~5935	-52.69	-27	PASS

NOTE: According to the test results of output power, Ant0 is considered to have the highest power, so band edge testing for Multiple mode are performed with this antenna and add 3dBi factor, this factor has been compensated in the test.

Test Graphs as below:

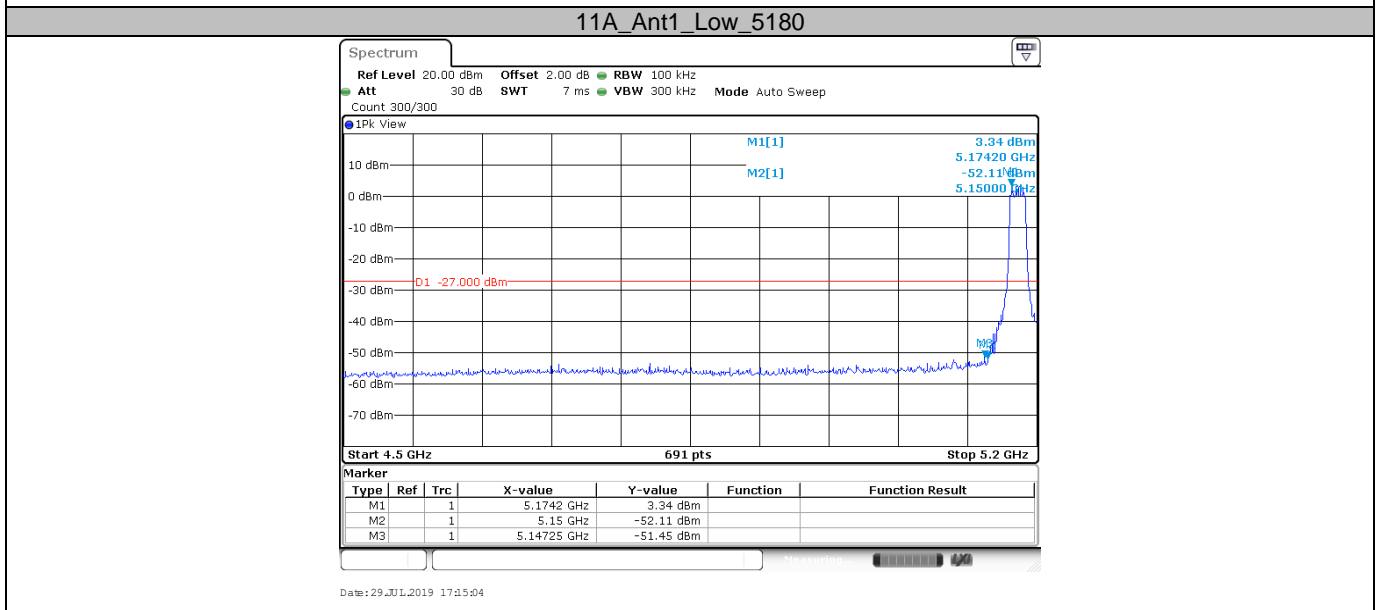
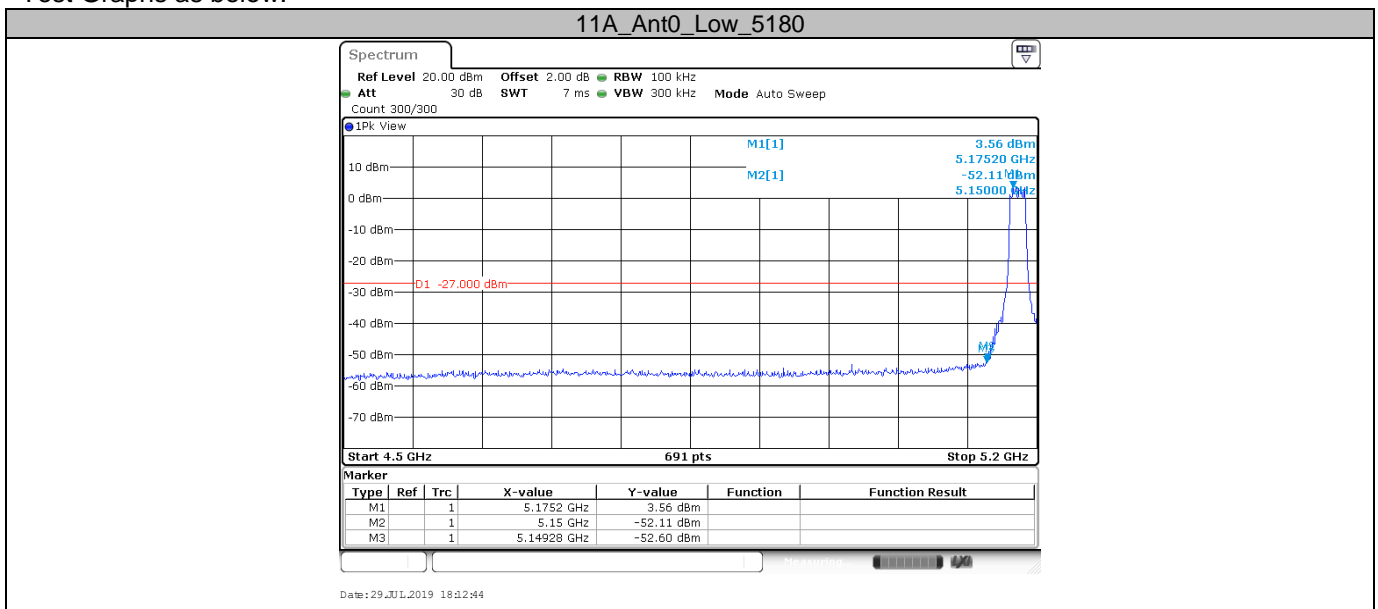

11A_Ant0_High_5240

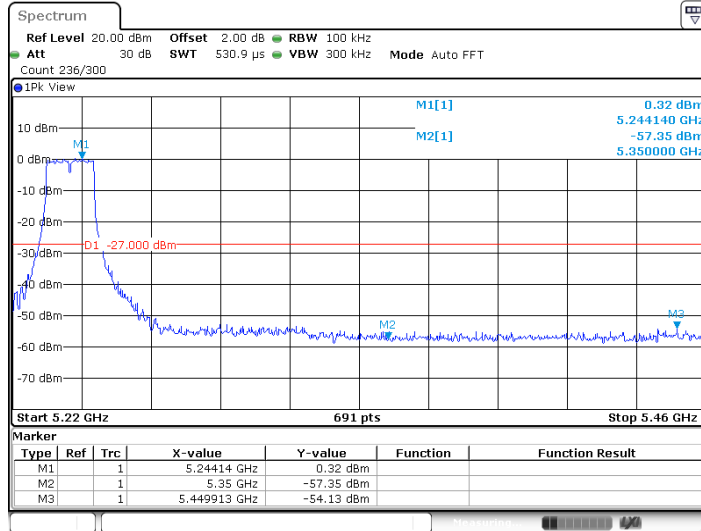

Date: 29.JUL.2019 18:16:09

11A_Ant1_High_5240

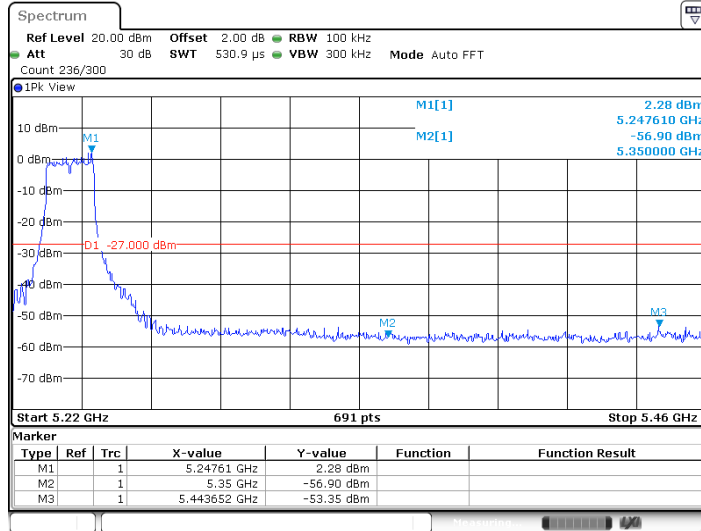

Date: 29.JUL.2019 17:19:31

11N20MIMO_Low_5180

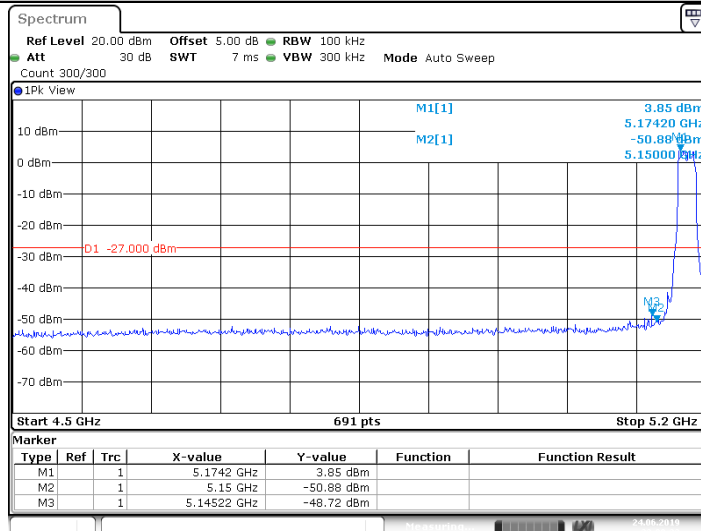

Date: 24.JUN.2019 22:09:22

11N20MIMO_High_5240

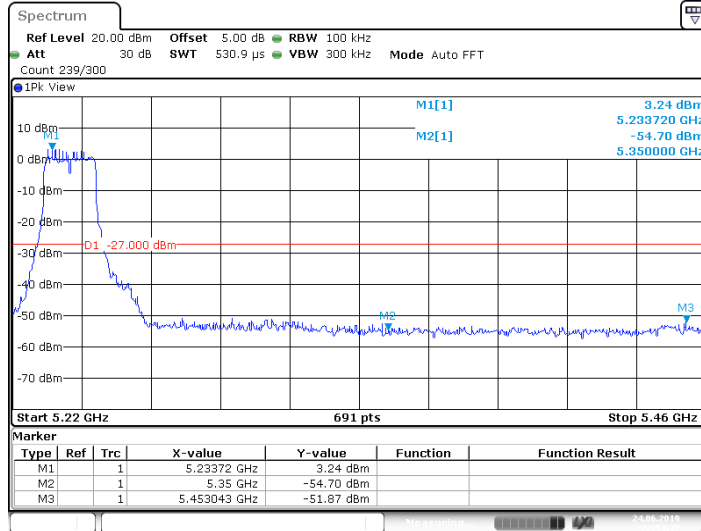

Date: 24 JUN 2019 22:14:38

11N40MIMO_Low_5190

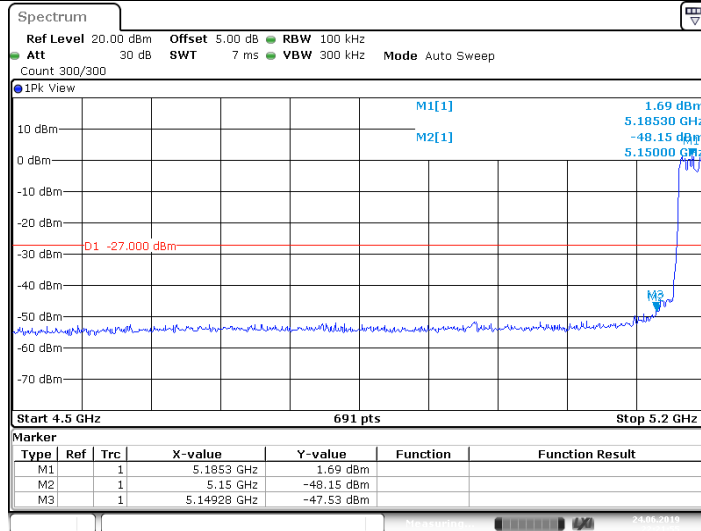

Date: 24 JUN 2019 22:21:56

11N40MIMO_High_5230



Date: 24 JUN 2019 22:23:40

11AC20MIMO_Low_5180

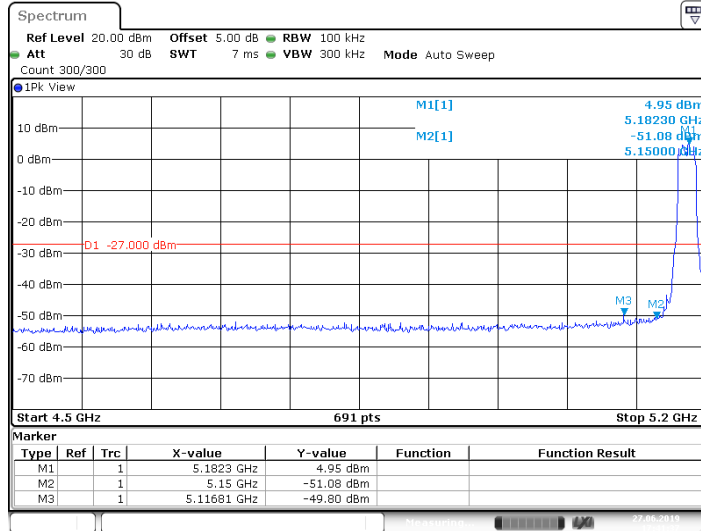

Date: 27 JUN 2019 17:41:38

11AC20MIMO_High_5240

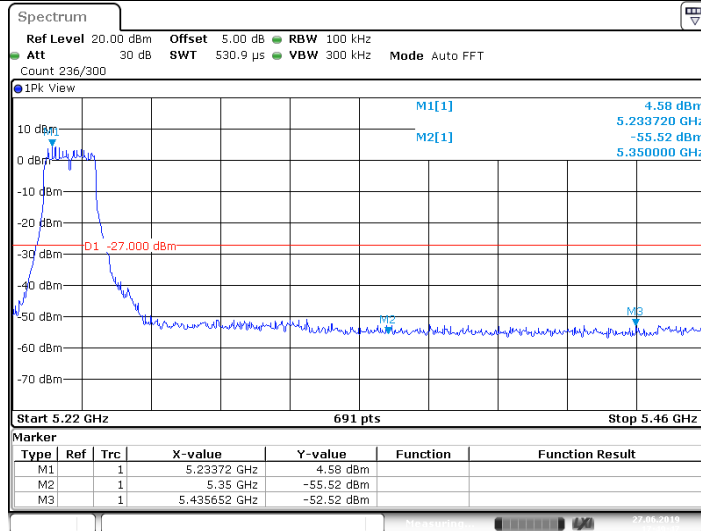

Date: 27 JUN 2019 17:49:47

11AC40MIMO_Low_5190

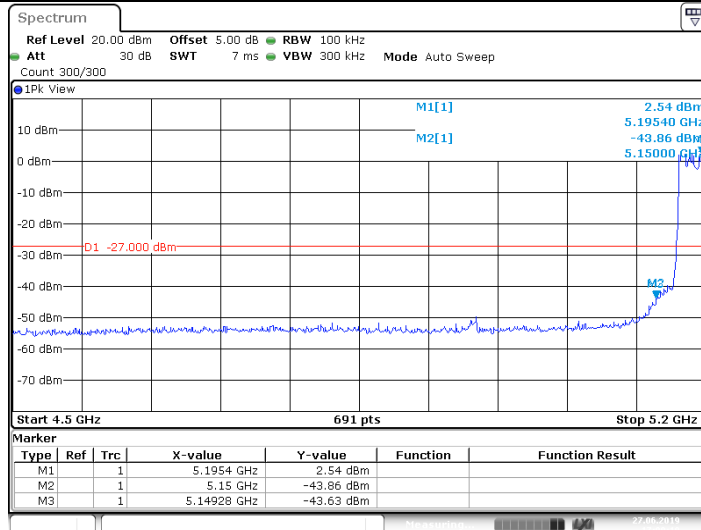

Date: 27 JUN 2019 17:09:19

11AC40MIMO_High_5230

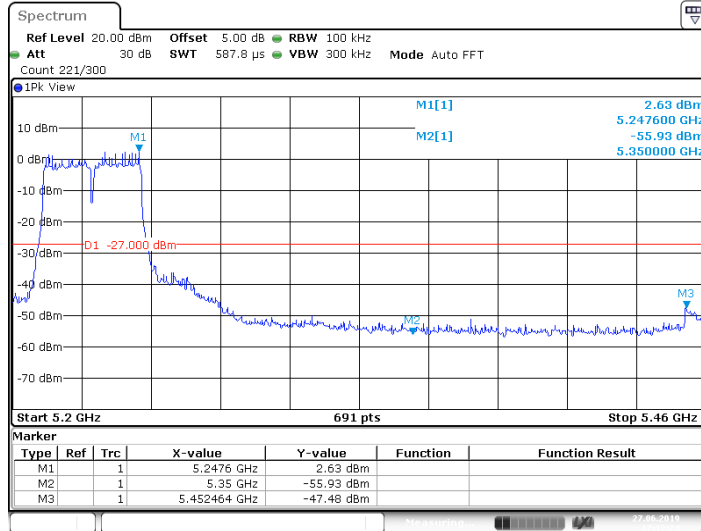

Date: 27 JUN 2019 17:12:24

11AC80MIMO_Low_5210

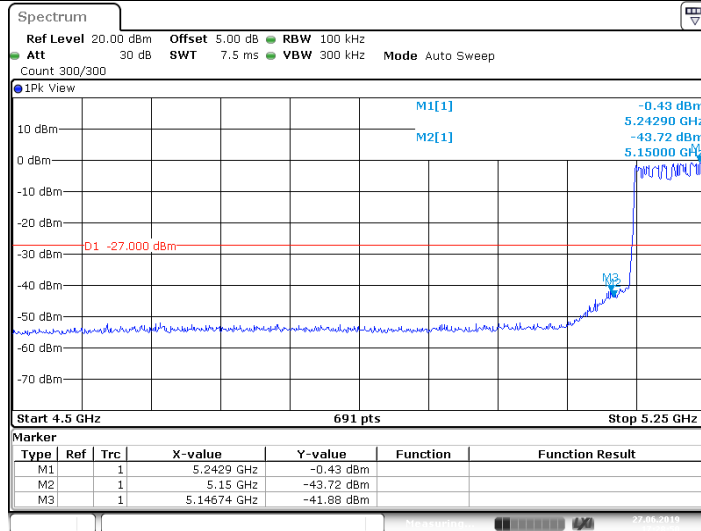

Date: 27 JUN 2019 17:28:50

11AC80MIMO_High_5210

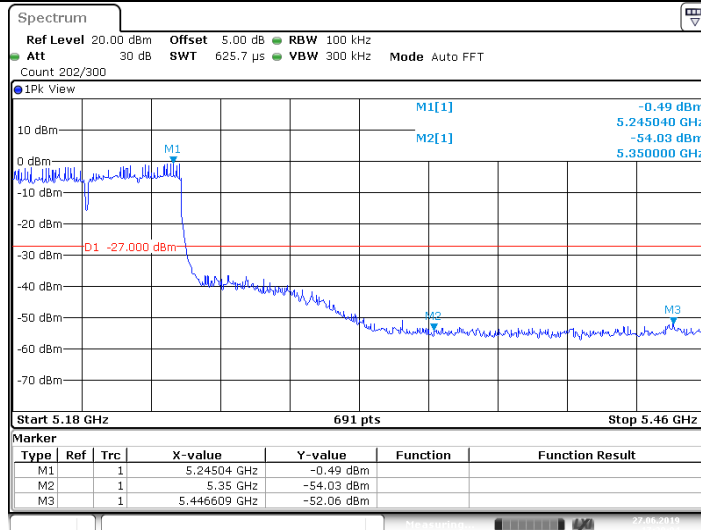

Date: 27 JUN 2019 17:29:04

11A_Ant0_Low_5745

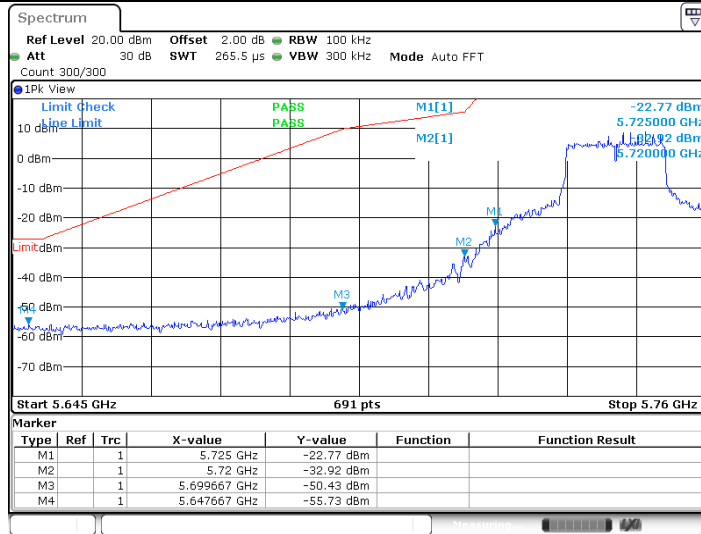

Date: 29 JUL 2019 18:18:20

11A_Ant1_Low_5745

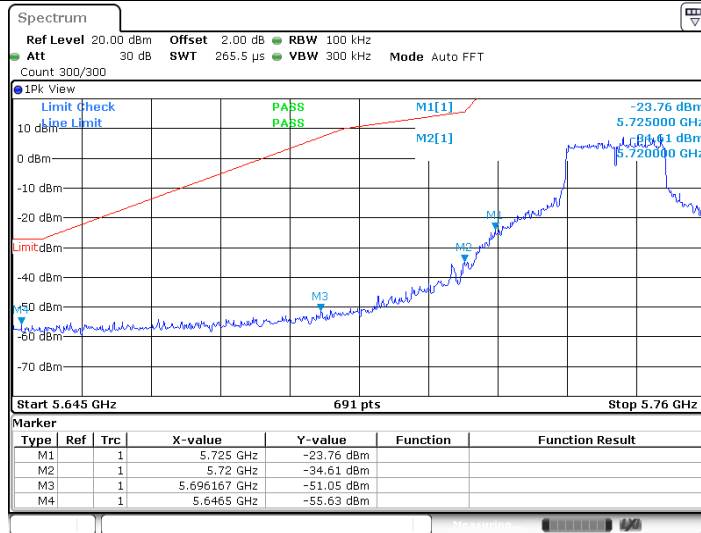

Date: 29 JUL 2019 17:21:58

11A_Ant0_High_5825

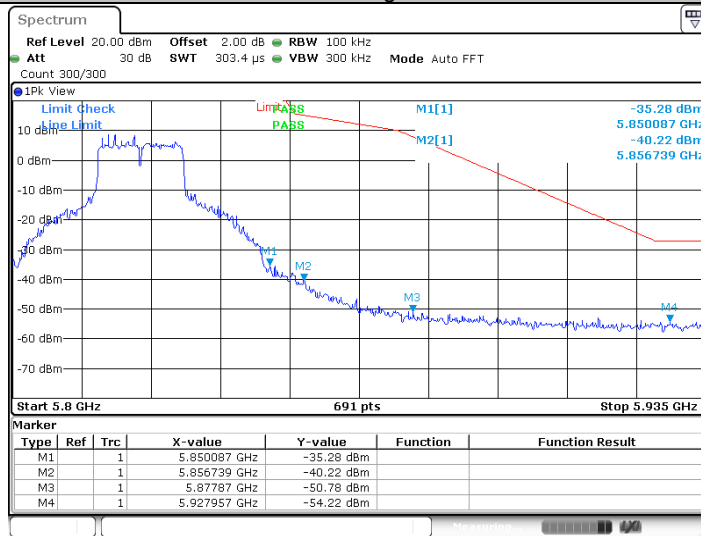

Date: 29 JUL 2019 18:22:17

11A_Ant1_High_5825

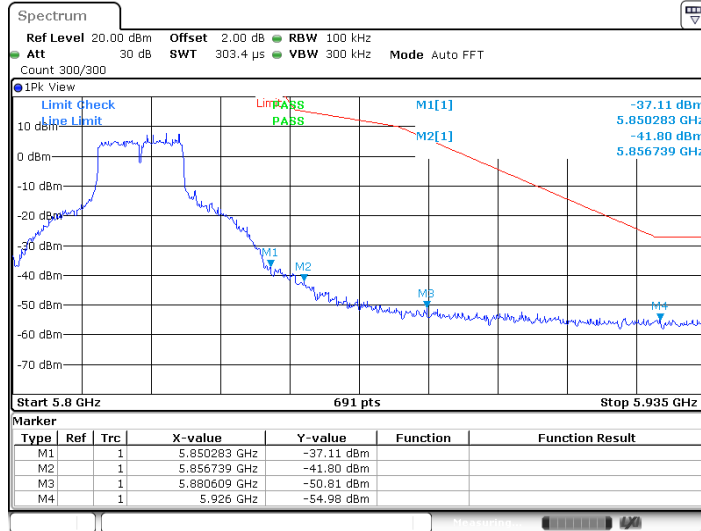

Date: 29 JUL 2019 17:27:17

11N20MIMO_Low_5745

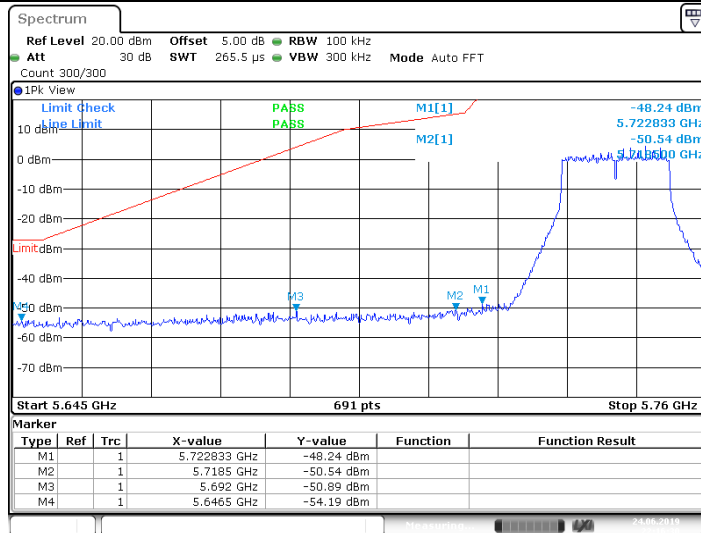

Date: 24 JUN 2019 22:16:30

11N20MIMO_High_5825

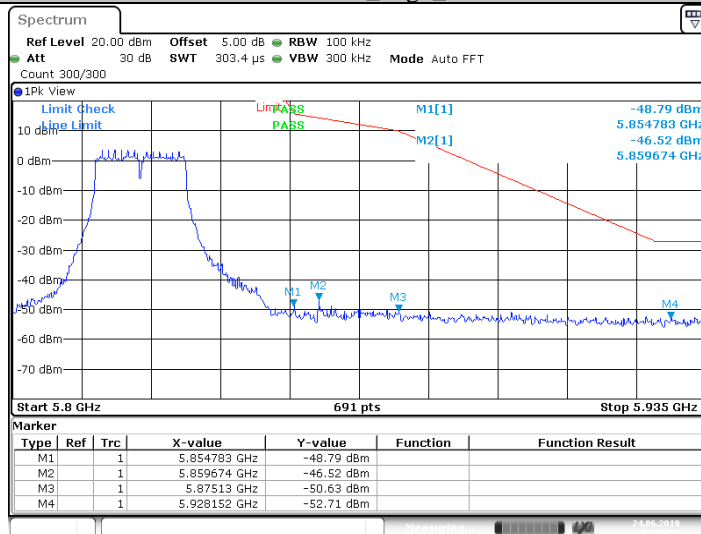

Date: 24 JUN 2019 22:19:52

11N40MIMO_Low_5755

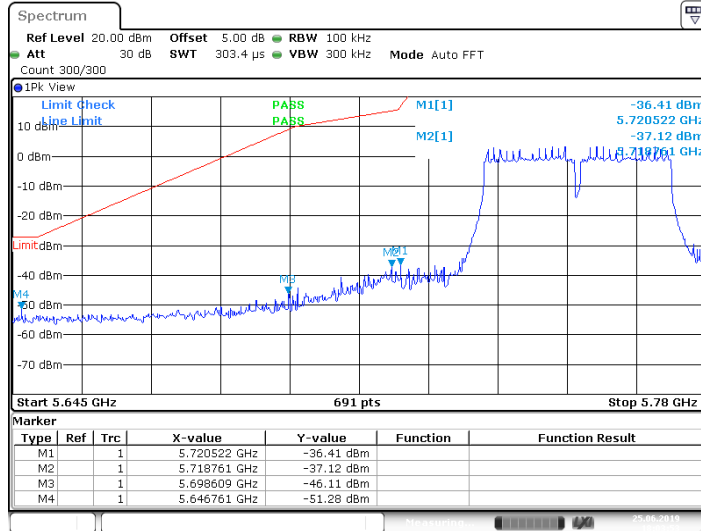

Date: 25 JUN 2019 18:03:53

11N40MIMO_High_5795

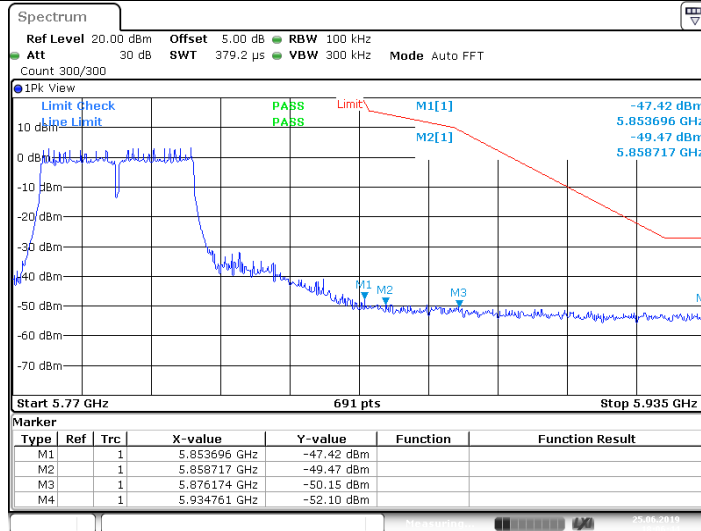

Date: 25 JUN 2019 18:06:44

11AC20MIMO_Low_5745

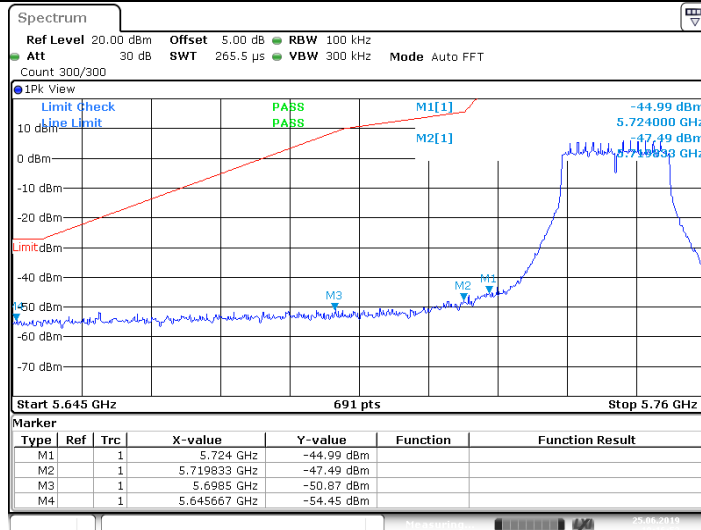

Date: 25 JUN 2019 18:16:52

11AC20MIMO_High_5825

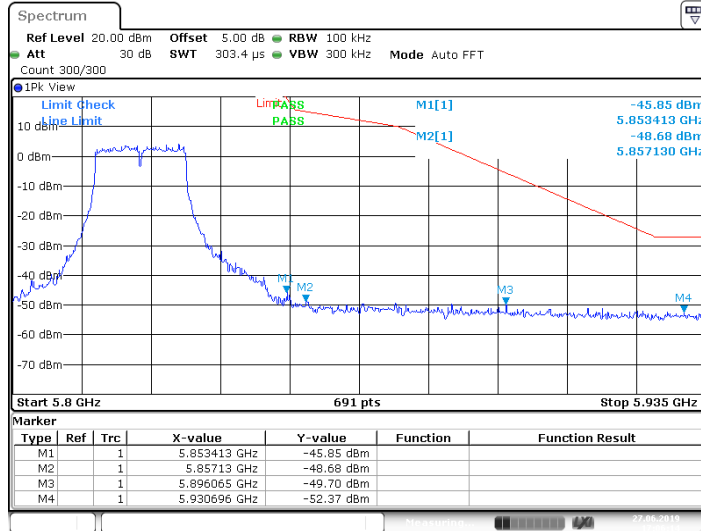

Date: 27 JUN 2019 17:06:14

11AC40MIMO_Low_5755

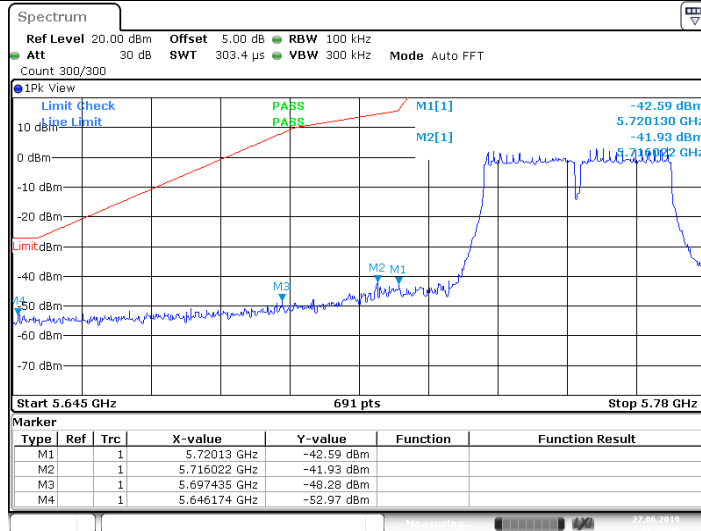

Date: 27 JUN 2019 17:15:43

11AC40MIMO_High_5795

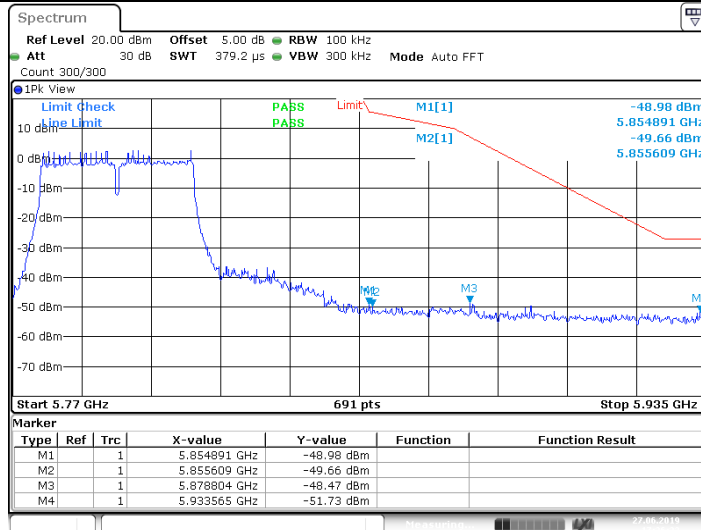

Date: 27 JUN 2019 17:26:33

11AC80MIMO_Low_5775

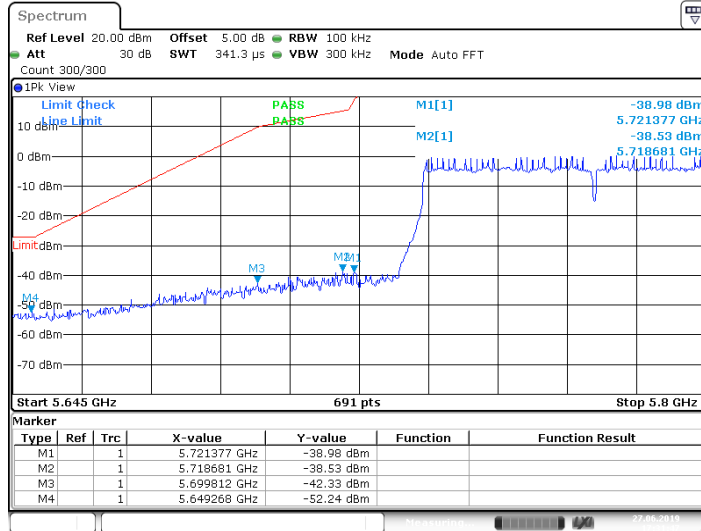

Date: 27 JUN 2019 17:31:47

11AC80MIMO_High_5775

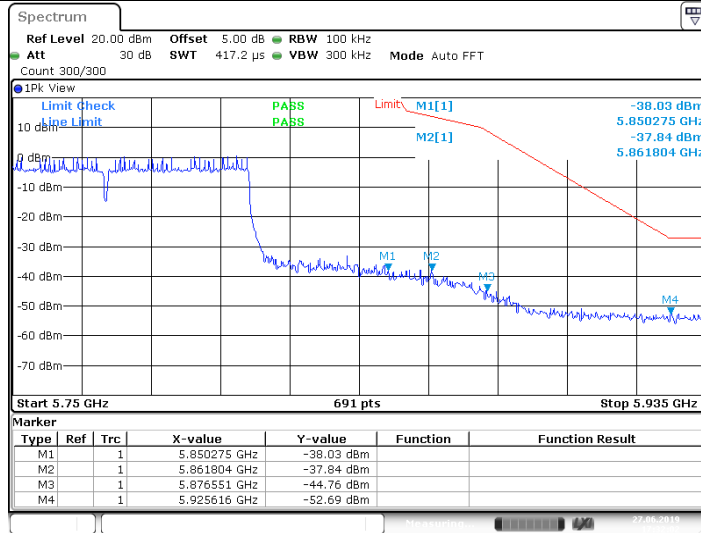

Date: 27 JUN 2019 17:32:02

Transmitting spurious emission test result as below (Radiated Mode):**Test Method**

1. The EUT was placed on a turn table which is 1.5m above ground plane for above 1GHz and 0.8m above ground for below 1GHz at 3meter chamber room for test. The table was rotated 360 degrees to determine the position of the highest radiation.
2. The EUT was set 3 meters away from the interference – receiving antenna, which was mounted on the top of a variable – height antenna tower.
3. The height of antenna is varied from one meter to four meters above the ground to determine the maximum value of the field strength. Both horizontal and vertical polarizations of the antenna are set to make the measurement.
4. For each suspected emission, the EUT was arranged to its worst case and then the antenna was tuned to heights from 1 meter to 4 meters and the rotatable table was turned
5. Use the following spectrum analyzer settings According to C63.10:
For Above 1GHz
Span = wide enough to capture the peak level of the in-band emission and all spurious
RBW = 1MHz, VBW \geq RBW for peak measurement and VBW = 10Hz for average measurement, Sweep = auto, Detector function = peak, Trace = max hold.
For Below 1GHz
Use the following spectrum analyzer settings:
Span = wide enough to capture the peak level of the in-band emission and all spurious
RBW = 100 KHz, VBW \geq RBW for peak measurement, Sweep = auto, Detector function =
= peak, Trace = max hold.

Note:

1. The resolution bandwidth and video bandwidth of test receiver/spectrum analyzer is 120 KHz for Quasi-peak detection (QP) at frequency below 1GHz.
2. The resolution bandwidth of test receiver/spectrum analyzer is 1MHz and the video bandwidth is 3MHz for peak detection (PK) at frequency above 1GHz.
3. The resolution bandwidth of test receiver/spectrum analyzer is 1MHz and the video bandwidth is 3MHz for RMS Average ((duty cycle < 98%) for Average detection (AV) at frequency above 1GHz, then the measurement results was added to a correction factor (20log(1/duty cycle)).
4. The resolution bandwidth of test receiver/spectrum analyzer is 1MHz and the video bandwidth is 10Hz (duty cycle > 98%) for Average detection (AV) at frequency above 1GHz.

Limit

According to part 15.247(d), the radio emission outside the operating frequency band shall be at least 20 dB below that in the 100 kHz bandwidth within the band that contains the highest level of the desired power. Radiated emissions which fall in the restricted bands, as defined in section 15.205, must comply with the radiated emission limits specified in section 15.209.

Frequency MHz	Field Strength uV/m	Field Strength dB μ V/m	Detector
30-88	100	40	QP
88-216	150	43.5	QP
216-960	200	46	QP
960-1000	500	54	QP
Above 1000	500	54	AV
Above 1000	5000	74	PK

According to C63.10, if the peak (or quasi-peak) measured value complies with the average limit, it is unnecessary to perform an average measurement, so AV emission value did not show in below table if the peak value complies with average limit.

Transmitting spurious emission test result as below:

802.11A Modulation 5180MHz Test Result

Frequency	Corr. Factor	Emission Level	Read level	Polarization	Limit	Margin	Detector	Result
MHz	dB	dBuV/m	dBuV/m		dBuV/m	dB		
518.88	-21.2	27.16	48.36	Horizontal	46	18.84	QP	Pass
745.81	-17.6	29.89	47.49	Horizontal	46	16.11	QP	Pass
879.29	-15.8	34.58	50.38	Horizontal	46	11.42	QP	Pass
Other frequency	---	---	---	Horizontal	---	---	QP	Pass
60.66	-27.0	24.97	51.97	Vertical	40	15.03	QP	Pass
631.08	-19.3	28.21	47.51	Vertical	46	17.79	QP	Pass
943.26	-15.3	35.51	50.81	Vertical	46	10.49	QP	Pass
Other frequency	---	---	---	Vertical	---	---	QP	Pass
2388.63	-6.0	30.62	36.62	Horizontal	74	43.38	PK	Pass
3449.31	-0.6	33.02	33.62	Horizontal	74	40.98	PK	Pass
6715.56	4.7	37.36	32.66	Horizontal	74	36.64	PK	Pass
*5150	1.8	---	---	Horizontal	74	---	PK	Pass
*5350	2.3	---	---	Horizontal	74	---	PK	Pass
*5460	3.2	---	---	Horizontal	74	---	PK	Pass
Other Frequency (1000-7000)	---	---	---	Horizontal	74	---	PK	Pass
7000-40000	---	---	---	Horizontal	74	---	PK	Pass
1254.44	-12.0	31.45	43.45	Vertical	74	42.55	PK	Pass
2391.63	-6.0	40.29	46.29	Vertical	74	33.71	PK	Pass
3952.94	-2.0	33.39	35.39	Vertical	74	40.61	PK	Pass
*5150	1.9	---	---	Vertical	74	---	PK	Pass
*5350	2.3	---	---	Vertical	74	---	PK	Pass
*5460	2.8	---	---	Vertical	74	---	PK	Pass
Other Frequency (1000-7000)	---	---	---	Vertical	74	---	PK	Pass
7000-40000	---	---	---	Vertical	74	---	PK	Pass

Remark:

- (1) Corrected Amplitude = Read level + Corrector factor
Above 1GHz: Corrector factor = Antenna Factor + Cable Loss- Amplifier Gain
Below 1GHz: Corrector factor = Antenna Factor + Cable Loss
Level=Reading Level + Correction Factor
(The Reading Level is recorded by software which is not shown in the sheet)
- (2) "*" means the emission(s) appear within the restrict bands shall follow the requirement of section 15.205.
- (3) We test all modes and only the worst case (802.11a modulation 5180MHz Channel) recorded in the report.
- (4) Testing is carried out with frequency rang 9KHz to 40GHz, which below 30MHz and data of measurement within this frequency range shown "---" in the table above means the reading of emissions are attenuated more than 30dB below the permissible limits or the field strength is too small to be measured.

9.6 Duty Cycle

Test Method

1. The RF output of EUT was connected to the spectrum analyzer by RF cable. The path loss was compensated to the results for each measurement.
2. Use the following spectrum analyzer settings:
Span = 0, RBW = 100 kHz, VBW \geq RBW, Sweep = auto, Detector function = peak, Trace = max hold
3. Allow the trace to stabilize. Mark the OFF time and ON time. and the duty cycle is $T_{on} / T_{on}+T_{off}$
4. Repeat above procedures until all frequencies measured were complete.

TestMode	Antenna	Channel	Duty Cycle [%]
11ASISO	Ant0	5180	98.20
	Ant1	5180	98.14
	Ant0	5220	98.20
	Ant1	5220	98.20
	Ant0	5240	98.14
	Ant1	5240	98.14
	Ant0	5745	98.14
	Ant1	5745	98.14
	Ant0	5785	98.14
	Ant1	5785	98.14
	Ant0	5825	98.14
	Ant1	5825	98.14
11N20SISO	Ant0+Ant1	5180	98.07
		5200	98.07
		5240	98.01
		5745	98.01
		5785	98.01
11N40SISO	Ant0+Ant1	5190	96.16
		5230	96.04
		5755	96.04
		5795	96.04
		5825	96.04
11AC20SISO	Ant0+Ant1	5180	98.02
		5200	98.08
		5240	98.02
		5745	98.02
		5785	98.02
11AC40SISO	Ant0+Ant1	5190	96.06
		5230	96.18
		5755	96.18
		5795	96.05
11AC80SISO	Ant0+Ant1	5210	92.21
		5775	92.44

9.7 Frequencies Stability

Test Method:

1, Frequency stability with respect to ambient temperature

- a) Supply the EUT with a nominal ac voltage or install a new or fully charged battery in the EUT. If possible, a dummy load shall be connected to the EUT because an antenna near the metallic walls of an environmental test chamber could affect the output frequency of the EUT. If the EUT is equipped with a permanently attached, adjustable-length antenna, then the EUT shall be placed in the center of the chamber with the antenna adjusted to the shortest length possible. Turn on the EUT and tune it to one of the number of frequency shown in section 8.
- b) Couple the unlicensed wireless device output to the measuring instrument by connecting an antenna to the measuring instrument with a suitable length of coaxial cable and placing the measuring antenna near the EUT, or by connecting a dummy load to the measuring instrument, through an attenuator if necessary.
- c) Adjust the location of the measurement antenna and the controls on the measurement instrument to obtain a suitable signal level
- d) Turn the EUT OFF and place it inside the environmental temperature chamber. For devices that have oscillator heaters, energize only the heater circuit
- e) Set the temperature control on the chamber to the highest specified in the regulatory requirements for the type of device and allow the oscillator heater and the chamber temperature to stabilize
- f) While maintaining a control on the chamber to the environmental chamber, turn the EUT ON and record the operating frequency at startup, and at 2 minutes, 5 minutes, and 10 minutes after the EUT is energized. Four measurements in total are made.
- g) Measure the frequency at each of frequency specified in section 8.
- h) Switch OFF the EUT but do not switch OFF the oscillator heater.
- i) Lower the chamber temperature by not more that 10°C, and allow the temperature inside the chamber to stabilize.
- j) Repeat step f) through step i) down to the lowest specified temperature.

2, Frequency stability when varying supply voltage

Unless otherwise specified, these tests shall be made at ambient room temperature. An antenna shall be connected to the antenna output terminals of the EUT if possible. If the EUT is equipped with or uses an adjustable-length antenna, then it shall be fully extended.

- a) Supply the EUT with nominal voltage or install a new or fully charged battery in the EUT. Turn ON the EUT and couple its output to a frequency counter or other frequency-measuring instrument.
- b) Turn the EUT to one of the number if frequencies required in Section 8. Adjust the location of the measurement antenna and the controls on the measurement instrument to obtain a suitable signal level.
- c) Measure the frequency at each of the frequencies specified in section 8.
- d) Repeat the above procedure at 85% and 115% of the nominal supply voltage.

Limit: It is required that that the emissions are maintained within the band of operation under all conditions of normal operation as specified in the user's manual.

Frequency Error vs. Voltage:

Test Conditions	Measured Frequency (MHz)
	5180
V nom(V)	5179.9400
V max(V)	5179.9550
V min(V)	5179.9560
Max. Deviation Frequency	-0.0600
Max. Frequency Error (ppm)	-11.58

Frequency Error vs. Temperature:

Test Conditions (°C)	Measured Frequency (MHz)
	5180
5	5179.9400
45	5179.9550
Max. Deviation Frequency	-0.0600
Max. Frequency Error (ppm)	-11.58

Frequency Error vs. Voltage:

Test Conditions	Measured Frequency (MHz)
	5500
V nom(V)	5499.9400
V max(V)	5499.9550
V min(V)	5499.9550
Max. Deviation Frequency	-0.0600
Max. Frequency Error (ppm)	-10.91

Frequency Error vs. Temperature:

Test Conditions (°C)	Measured Frequency (MHz)
	5500
5	5499.9550
45	5499.9550
Max. Deviation Frequency	-0.0450
Max. Frequency Error (ppm)	-8.18

Frequency Error vs. Voltage:

Test Conditions	Measured Frequency (MHz)
	5745
V nom(V)	5745.0430
V max(V)	5744.9400
V min(V)	5745.0430
Max. Deviation Frequency	0.0430
Max. Frequency Error (ppm)	7.48

Frequency Error vs. Temperature:

Test Conditions (°C)	Measured Frequency (MHz)
	5745
5	5744.9400
45	5744.9550
Max. Deviation Frequency	0.0450
Max. Frequency Error (ppm)	-7.83

Remark 1: V min(V) = 85% of the nominal supply voltage

V max(V)=115% of the nominal supply voltage

Remark 2: we test all frequencies which specified in section 8 and only show these representative frequencies.

10 Test Equipment List

Radiated Emission Test

DESCRIPTION	MANUFACTURER	MODEL NO.	SERIAL NO.	CAL. DUE DATE
EMI Test Receiver	Rohde & Schwarz	ESR 26	101269	2020-6-28
Trilog Super Broadband Test Antenna	Schwarzbeck	VULB 9163	707	2020-6-28
Horn Antenna	Rohde & Schwarz	HF907	102294	2020-6-22
Loop Antenna	Rohde & Schwarz	HFH2-Z2	100398	2020-7-7
Pre-amplifier	Rohde & Schwarz	SCU 18	102230	2020-6-28
Signal Generator	Rohde & Schwarz	SMY01	839369/005	2020-6-28
Attenuator	Agilent	8491A	MY39264334	2020-6-28
3m Semi-anechoic chamber	TDK	9X6X6	----	2020-7-7

Conducted RF Test System

DESCRIPTION	MANUFACTURER	MODEL NO.	SERIAL NO.	CAL. DUE DATE
Signal Analyzer	Rohde & Schwarz	FSV40	101030	2020-6-28
RF Switch Module	Rohde & Schwarz	OSP120/OSP-B157	101226/100851	2020-6-28
Power Splitter	Weinschel	1580	SC319	2020-7-7
Test software	Tonscend	System for BT/WIFI	Version 2.5.77.0418	N/A

11 System Measurement Uncertainty

For a 95% confidence level, the measurement expanded uncertainties for defined systems, in accordance with the recommendations of ISO 17025 were:

System Measurement Uncertainty	
Test Items	Extended Uncertainty
Uncertainty for Radiated Emission 25MHz-3000MHz	Horizontal: 4.91dB; Vertical: 4.89dB;
Uncertainty for Radiated Emission 3000MHz-18000MHz	Horizontal: 4.80dB; Vertical: 4.79dB;
Uncertainty for Radiated Emission 18000MHz-40000MHz	Horizontal: 5.05dB; Vertical: 5.04dB;
Uncertainty for Conducted RF test with TS 8997	Power level test involved: 1.16dB Frequency test involved: 0.6×10^{-7}

THE END