

FCC - TEST REPORT

Report Number : **68.950.19.0592.01** Date of Issue: **July 26, 2019**

Model : **3BOX A2**

Product Type : **Wearable on Neck Host**

Applicant : **VR Technology (Shenzhen) Limited**

Address : **Room 201, 12 Gaoxin South Road, Huiheng Building, Nanshan**
District, Shenzhen

Manufacturer : **VR Technology (Shenzhen) Limited**

Address : **Room 201, 12 Gaoxin South Road, Huiheng Building, Nanshan**
District, Shenzhen

Test Result : **Positive** **Negative**

Total pages including Appendices : **54**

TÜV SÜD Certification and Testing (China) Co., Ltd. – Shenzhen Branch is a subcontractor to TÜV SÜD Product Service GmbH according to the principles outlined in ISO 17025.

TÜV SÜD Certification and Testing (China) Co., Ltd. – Shenzhen Branch reports apply only to the specific samples tested under stated test conditions. Construction of the actual test samples has been documented. It is the manufacturer's responsibility to assure that additional production units of this model are manufactured with identical electrical and mechanical components. The manufacturer/importer is responsible to the Competent Authorities in Europe for any modifications made to the production units which result in non-compliance to the relevant regulations. TÜV SÜD Certification and Testing (China) Co., Ltd. – Shenzhen Branch shall have no liability for any deductions, inferences or generalizations drawn by the client or others from TÜV SÜD Certification and Testing (China) Co., Ltd. – Shenzhen Branch issued reports.

This report is the confidential property of the client. As a mutual protection to our clients, the public and ourselves, extracts from the test report shall not be reproduced except in full without our written approval.



1 Table of Contents

1	Table of Contents	2
2	Details about the Test Laboratory	3
3	Description of the Equipment Under Test	4
4	Summary of Test Standards	5
5	Summary of Test Results	6
6	General Remarks	7
7	Test Setups	8
8	Systems test configuration	9
9	Technical Requirement	10
9.1	Conducted peak output power	10
9.2	20 dB bandwidth and 99% Occupied Bandwidth	11
9.3	Carrier Frequency Separation	19
9.4	Number of hopping frequencies	22
9.5	Dwell Time.....	25
9.6	Spurious RF conducted emissions.....	33
9.7	Band edge testing	44
9.8	Spurious radiated emissions for transmitter	50
10	Test Equipment List.....	53
11	System Measurement Uncertainty	54



2 Details about the Test Laboratory

Details about the Test Laboratory

Test Site 1

Company name: TÜV SÜD Certification and Testing (China) Co., Ltd. Shenzhen Branch
Building 12 & 13, Zhiheng Wisdomland Business Park, Nantou Checkpoint
Road 2, Nanshan District
Shenzhen 518052
P.R. China

Telephone: 86 755 8828 6998

Fax: 86 755 8828 5299

FCC Registration No.: 514049

FCC Designation Number: CA5009

IC Registration No.: 10320A

3 Description of the Equipment Under Test

Product:	Wearable on Neck Host
Model no.:	3BOX A2
FCC ID:	2AKA6-A2
Options and accessories:	Adapter and USB Cable
Rating:	Supplied by 5*3.8Vdc 1100mAh Li-ion Rechargeable battery Charged by 5.0Vdc, 3.0A external adapter
Adapter information:	Adapter Model: A138A-120150U-US2 Input: 100-240Vac, 50/60Hz; 0.5A Output: 5.0Vdc, 3.0A
RF Transmission Frequency:	2402MHz-2480MHz
No. of Operated Channel:	79
Modulation:	GFSK, $\pi/4$ -DQPSK, 8DPSK
Antenna Type:	Integrated antenna
Antenna Gain:	3.0dBi
Description of the EUT:	The Equipment Under Test (EUT) is a Wearable on Neck Host which support Bluetooth function and Wi-Fi operated at 5GHz and 2.4GHz. Only Bluetooth (BDR+EDR) included in this report.

4 Summary of Test Standards

Test Standards	
FCC Part 15 Subpart C 10-1-2018 Edition	PART 15 - RADIO FREQUENCY DEVICES Subpart C - Intentional Radiators

All the test methods were according to KDB 558074 D01 15.247 Meas Guidance v05r02 and ANSI C63.10 (2013).

5 Summary of Test Results

Technical Requirements						
FCC Part 15 Subpart C						
Test Condition	Pages	Test Site	Test Result			
			Pass	Fail	N/A	
§15.207	Conducted emission AC power port	---	---	<input type="checkbox"/>	<input type="checkbox"/>	<input checked="" type="checkbox"/>
§15.247 (b) (1)	Conducted peak output power	10	Site 1	<input checked="" type="checkbox"/>	<input type="checkbox"/>	<input type="checkbox"/>
§15.247(a)(1)	20dB and 99% bandwidth	11	Site 1	<input checked="" type="checkbox"/>	<input type="checkbox"/>	<input type="checkbox"/>
§15.247(a)(1)	Carrier frequency separation	19	Site 1	<input checked="" type="checkbox"/>	<input type="checkbox"/>	<input type="checkbox"/>
§15.247(a)(1)(iii)	Number of hopping frequencies	22	Site 1	<input checked="" type="checkbox"/>	<input type="checkbox"/>	<input type="checkbox"/>
§15.247(a)(1)(iii)	Dwell Time	25	Site 1	<input checked="" type="checkbox"/>	<input type="checkbox"/>	<input type="checkbox"/>
§15.247(e)	Power spectral density	---	---	<input type="checkbox"/>	<input type="checkbox"/>	<input checked="" type="checkbox"/>
§15.247(d)	Spurious RF conducted emissions	33	Site 1	<input checked="" type="checkbox"/>	<input type="checkbox"/>	<input type="checkbox"/>
§15.247(d)	Band edge	44	Site 1	<input checked="" type="checkbox"/>	<input type="checkbox"/>	<input type="checkbox"/>
§15.247(d)	Spurious radiated emissions for transmitter	50	Site 1	<input checked="" type="checkbox"/>	<input type="checkbox"/>	<input type="checkbox"/>
§15.203	Antenna requirement	See note 2		<input checked="" type="checkbox"/>	<input type="checkbox"/>	<input type="checkbox"/>

Note 1: N/A=Not Applicable.

Note 2: The EUT uses an Integrated antenna, which gain is 3.0dBi. In accordance to §15.203, it is considered sufficiently to comply with the provisions of this section.

6 General Remarks

Remarks

This submittal(s) (test report) is intended for FCC ID: 2AKA6-A2 complies with Section 15.207, 15.209, 15.247 of the FCC Part 15, Subpart C rules.

SUMMARY:

All tests according to the regulations cited on page 5 were

■ - Performed

□ - **Not** Performed

The Equipment Under Test

■ - **Fulfills** the general approval requirements.

□ - **Does not** fulfill the general approval requirements.

Sample Received Date: June 13, 2019

Testing Start Date: June 14, 2019

Testing End Date: July 10, 2019

- TÜV SÜD Certification and Testing (China) Co., Ltd. Shenzhen Branch -

Reviewed by:

Prepared by:

Tested by:

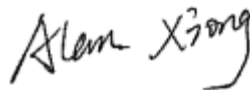

John Zhi
Project Manager

Alan Xiong
Project Engineer

Tree Zhan
Test Engineer

7 Test Setups

7.1 Radiated test setups

Below 1GHz

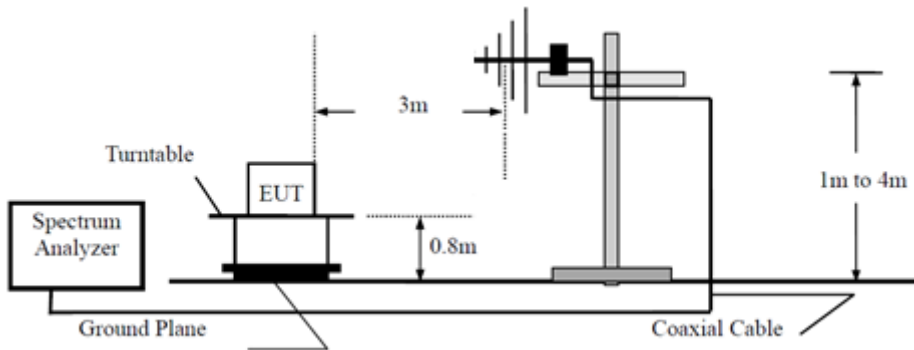

Above 1GHz

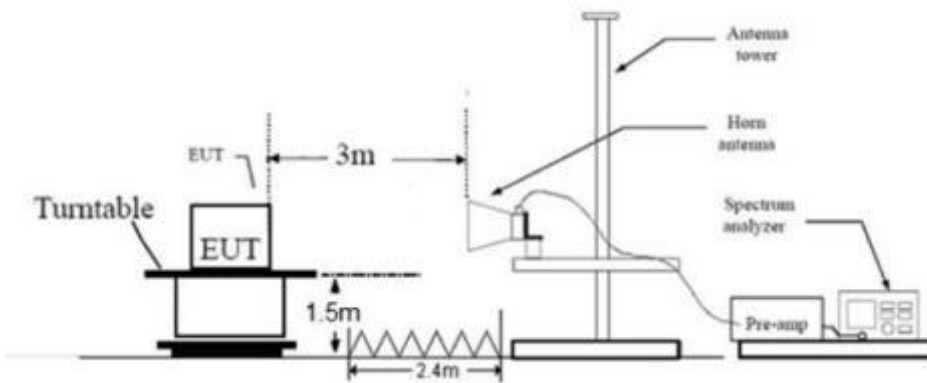

7.2 Conducted RF test setups

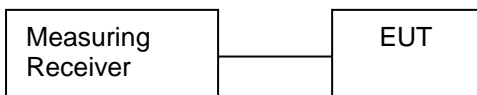

8 Systems test configuration

Auxiliary Equipment Used during Test:

DESCRIPTION	MANUFACTURER	MODEL NO.	S/N
Notebook	Lenovo	X240	---

The system was configured to hopping mode and non-hopping mode.

Hopping mode: typical working mode (normal hopping status)

Non-hopping mode: The system was configured to operate at a signal channel transmitting. The test software allows the configuration and operation at the worst-case duty and the highest transmit power

9 Technical Requirement

9.1 Conducted peak output power

Test Method

1. The RF output of EUT was connected to the power meter by RF cable. The path loss was compensated to the results for each measurement.
2. Set to the maximum power setting and enable the EUT transmit continuously
3. Use the following test receiver settings:
Span = approximately 5 times the 20dB bandwidth, centered on a hopping channel
RBW > the 20dB bandwidth of the emission being measured, VBW ≥ RBW,
Sweep = auto, Detector function = peak, Trace = max hold
4. Allow the trace to stabilize. Use the marker-to-peak function to set the marker to the peak of the emission. The indicated level is the peak output power and record the results in the test report.
5. Repeat above procedures until all frequencies measured were complete.

Limits

According to §15.247 (b) (1), conducted peak output power limit as below:

Frequency Range MHz	Limit W	Limit dBm
2400-2483.5	≤1	≤30

Test result as below table

Bluetooth Mode GFSK modulation Test Result

Frequency MHz	Conducted Peak Output Power dBm	Result
Low channel 2402MHz	4.65	Pass
Middle channel 2441MHz	4.50	Pass
High channel 2480MHz	4.06	Pass

Bluetooth Mode π/4-DQPSK modulation Test Result

Frequency MHz	Conducted Peak Output Power dBm	Result
Low channel 2402MHz	3.69	Pass
Middle channel 2441MHz	3.55	Pass
High channel 2480MHz	3.09	Pass

Bluetooth Mode 8DPSK modulation Test Result

Frequency MHz	Conducted Peak Output Power dBm	Result
Low channel 2402MHz	4.08	Pass
Middle channel 2441MHz	3.99	Pass
High channel 2480MHz	3.47	Pass

9.2 20 dB bandwidth and 99% Occupied Bandwidth

Test Method

1. The RF output of EUT was connected to the test receiver by RF cable. The path loss was compensated to the results for each measurement.
2. Set to the maximum power setting and enable the EUT transmit continuously.
3. Use the following test receiver settings:
Span = approximately 5 times the 20dB bandwidth, centered on a hopping channel
RBW > the 20dB bandwidth of the emission being measured, VBW \geq RBW,
Sweep = auto, Detector function = peak, Trace = max hold
4. Allow the trace to stabilize. Use the marker-to-peak function to set the marker to the peak of the emission. Measure the frequency difference of two frequencies that were attenuated 20 dB from the reference level. Record the frequency difference as the emission bandwidth. Record the results.
5. Repeat above procedures until all frequencies measured were complete.

Limit

Limit [kHz]

N/A

20 dB bandwidth and 99% Occupied Bandwidth

Bluetooth Mode GFSK Modulation test result

Test Mode	Antenna	Channel [MHz]	20db EBW[MHz]	FL[MHz]	FH[MHz]	Limit [MHz]	Verdict
DH5	Ant1	2402	1.101	2401.439	2402.540	---	PASS
		2441	1.101	2440.439	2441.540	---	PASS
		2480	1.104	2479.436	2480.540	---	PASS
2DH5	Ant1	2402	1.371	2401.301	2402.672	---	PASS
		2441	1.371	2440.301	2441.672	---	PASS
		2480	1.371	2479.301	2480.672	---	PASS
3DH5	Ant1	2402	1.383	2401.301	2402.684	---	PASS
		2441	1.380	2440.304	2441.684	---	PASS
		2480	1.380	2479.304	2480.684	---	PASS

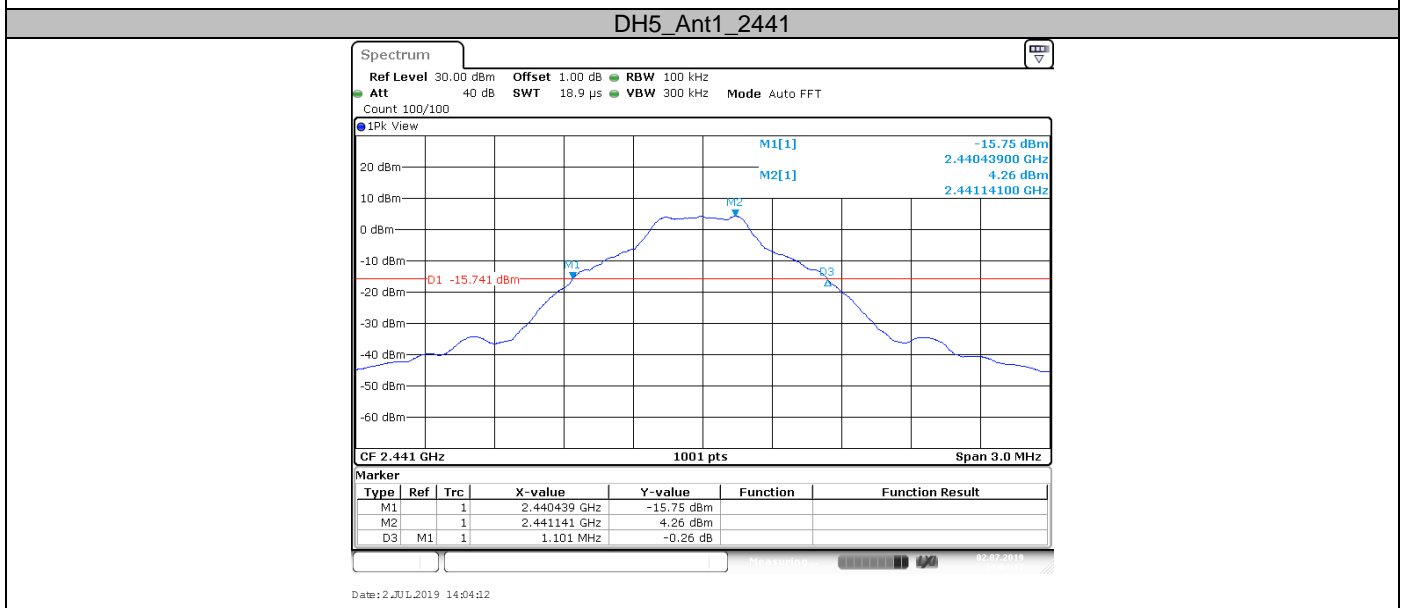
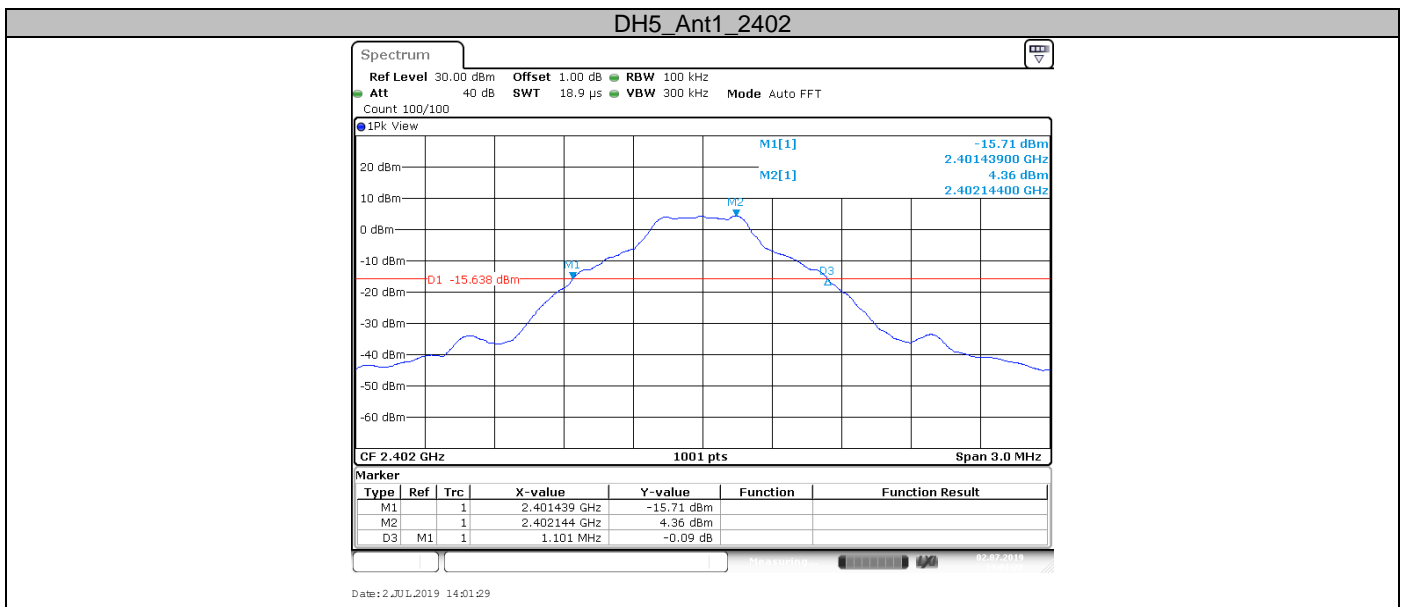

DH5_Ant1_2480

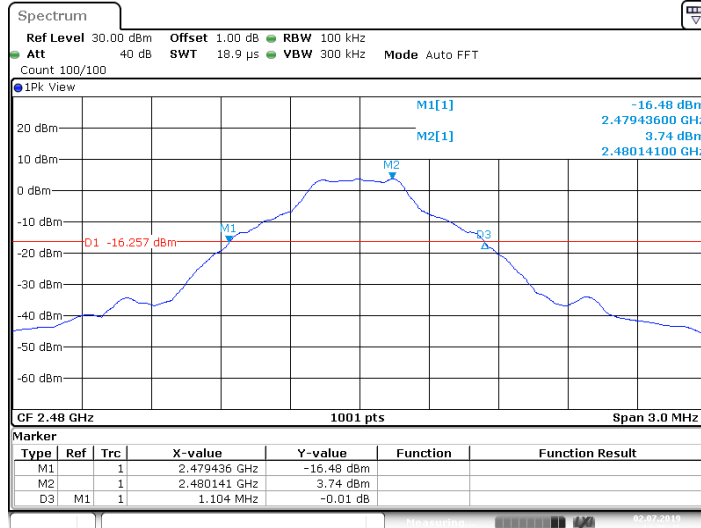

Date: 2 JUL 2019 14:05:46

2DH5_Ant1_2402

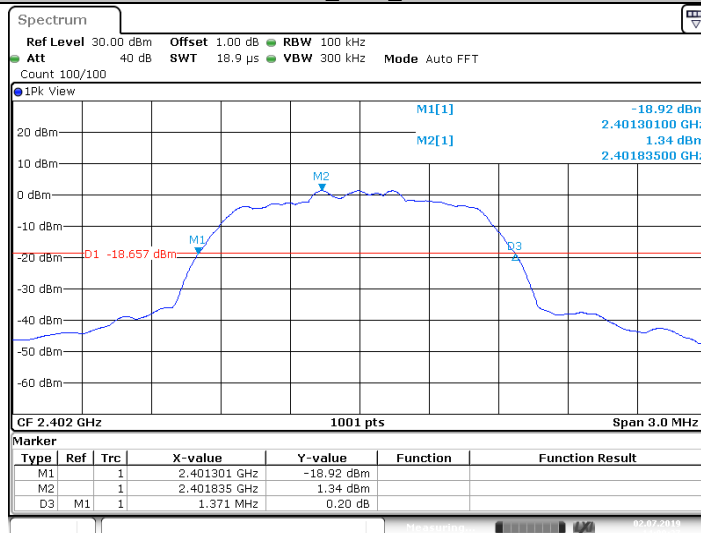

Date: 2 JUL 2019 14:09:27

2DH5_Ant1_2441

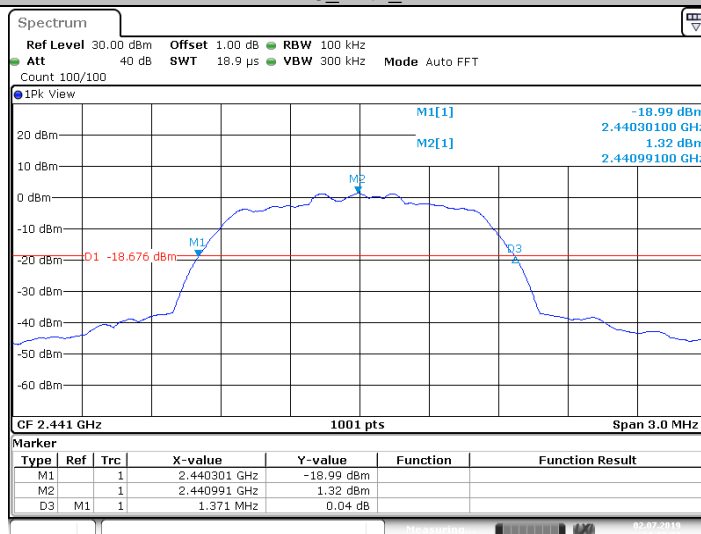

Date: 2 JUL 2019 14:12:22

2DH5_Ant1_2480

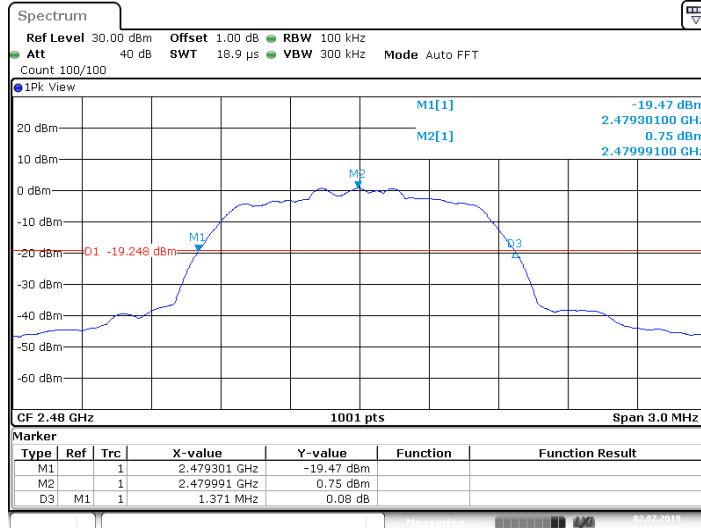

Date: 2 JUL 2019 14:14:32

3DH5_Ant1_2402

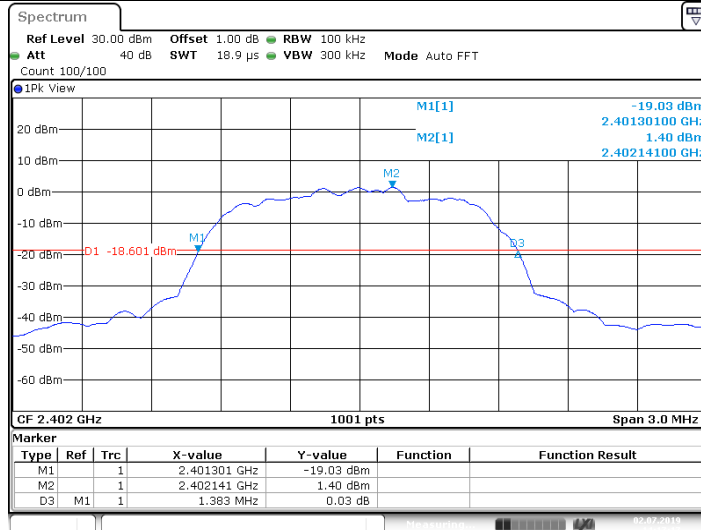

Date: 2 JUL 2019 14:17:17

3DH5_Ant1_2441

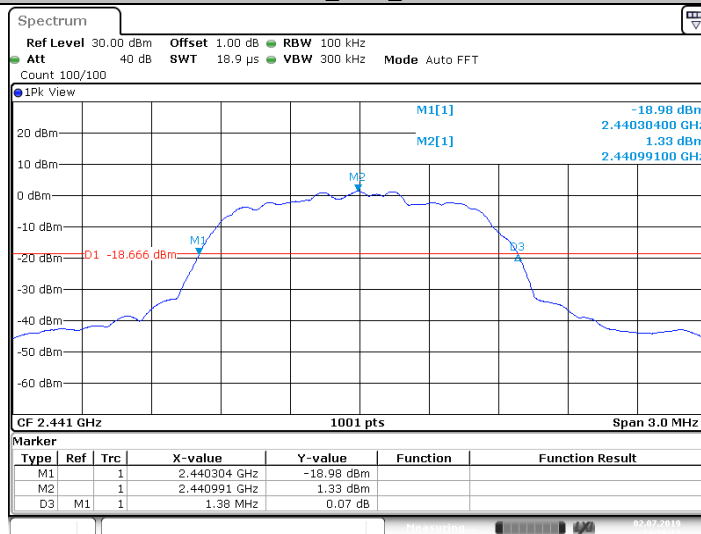

Date: 2 JUL 2019 14:20:12

3DH5_Ant1_2480

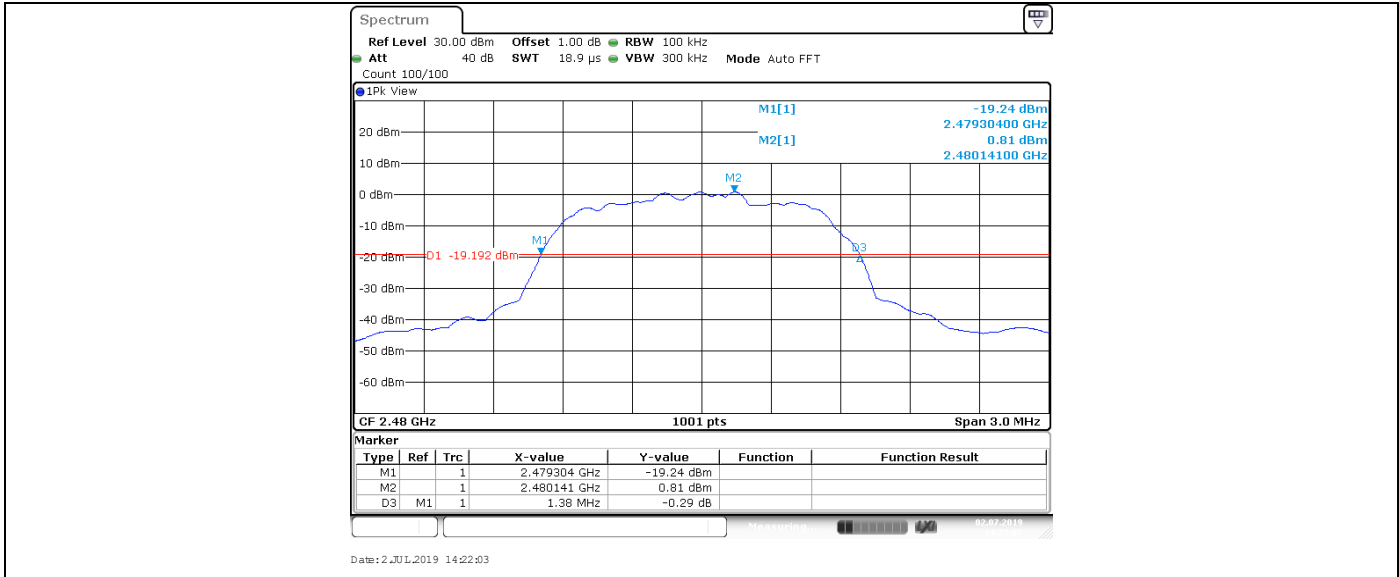

TestMode	Antenna	Channel	99% Bandwidth [MHz]	FL[MHz]	FH[MHz]	Limit[MHz]	Verdict
DH5	Ant1	2402	0.833	2401.568	2402.402	---	PASS
		2441	0.836	2440.565	2441.402	---	PASS
		2480	0.839	2479.565	2480.405	---	PASS
2DH5	Ant1	2402	1.172	2401.401	2402.572	---	PASS
		2441	1.172	2440.401	2441.572	---	PASS
		2480	1.172	2479.401	2480.572	---	PASS
3DH5	Ant1	2402	1.172	2401.401	2402.572	---	PASS
		2441	1.172	2440.401	2441.572	---	PASS
		2480	1.172	2479.401	2480.572	---	PASS

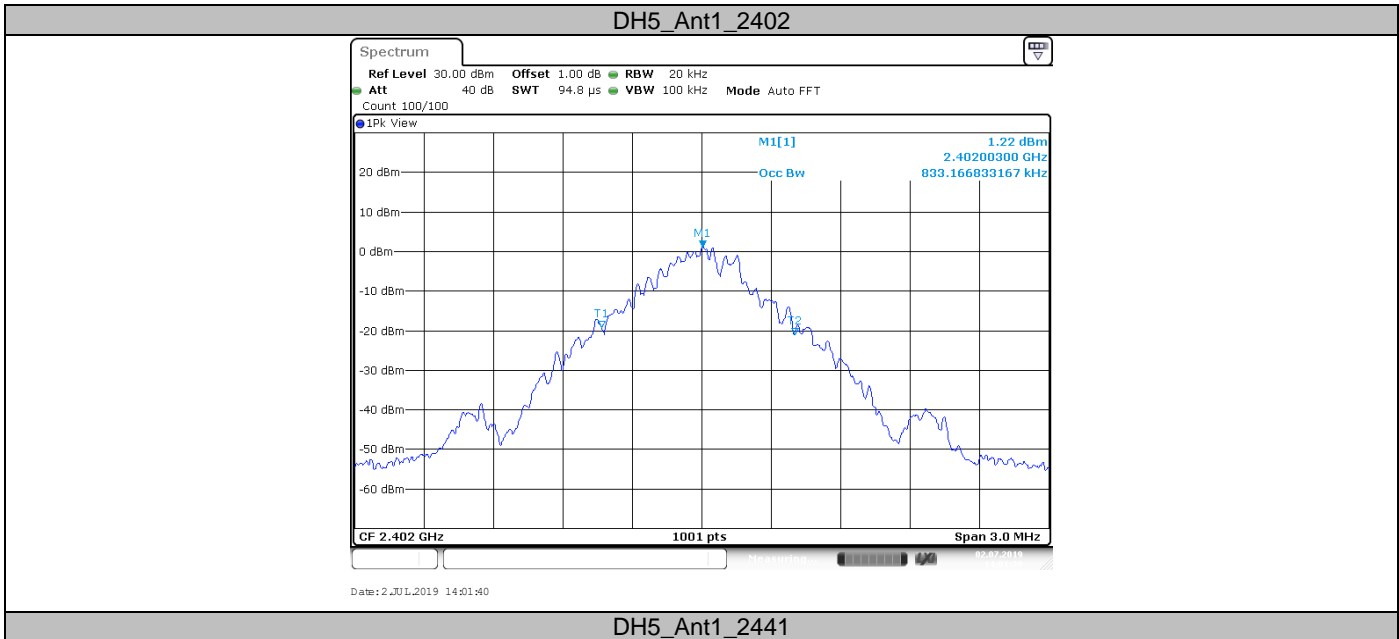

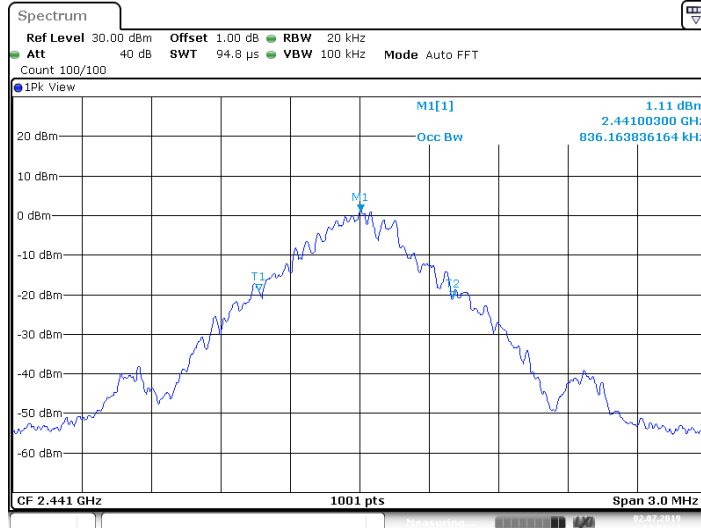

DH5_Ant1_2480

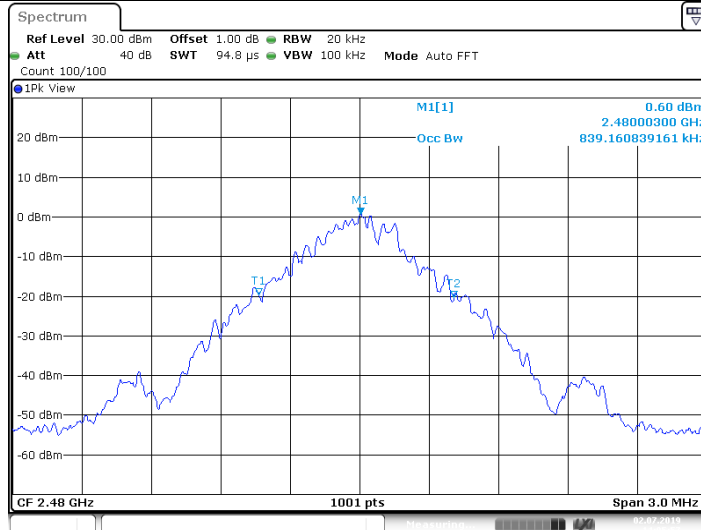

2DH5_Ant1_2402

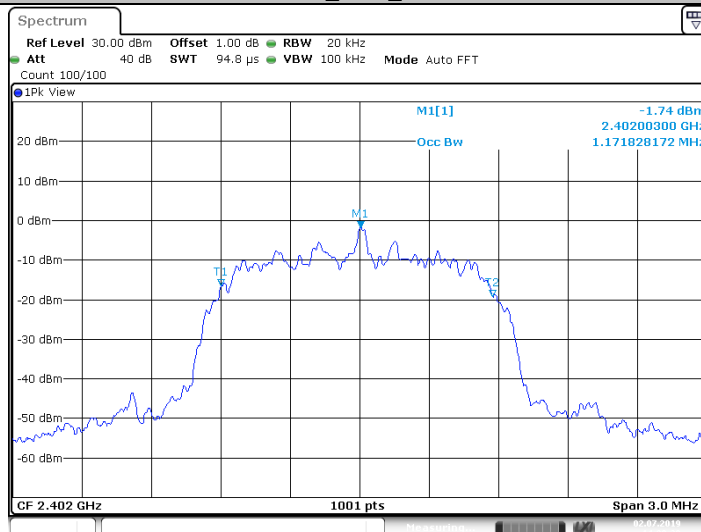

2DH5_Ant1_2441

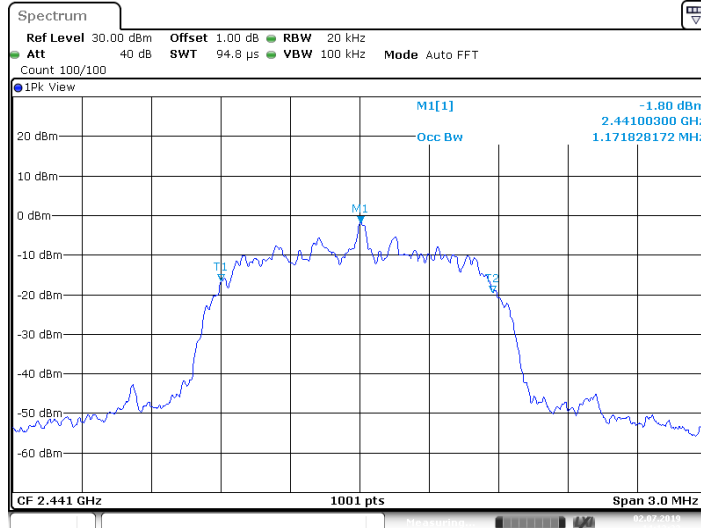

Date: 2 JUL 2019 14:12:33

2DH5_Ant1_2480

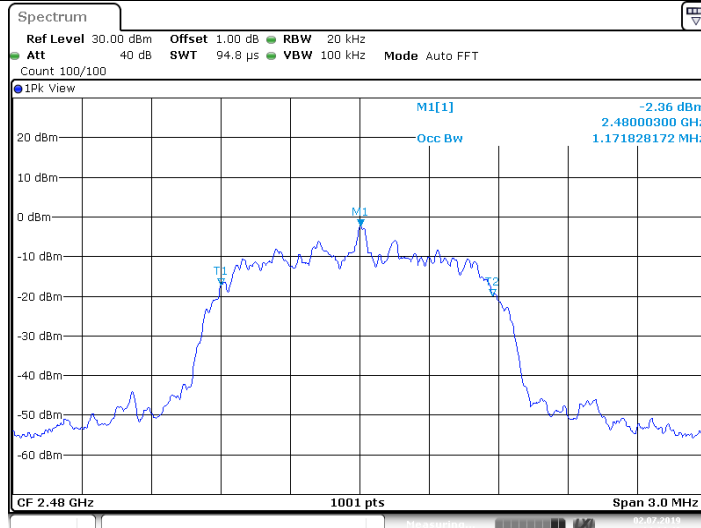

Date: 2 JUL 2019 14:14:43

3DH5_Ant1_2402

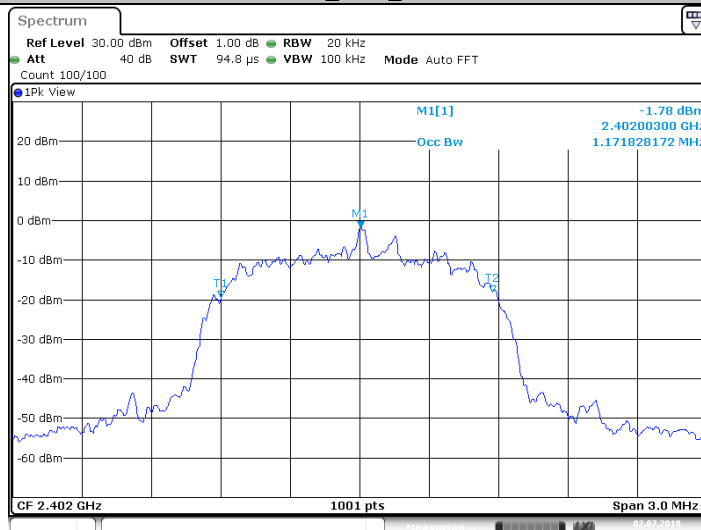

Date: 2 JUL 2019 14:17:28

3DH5_Ant1_2441

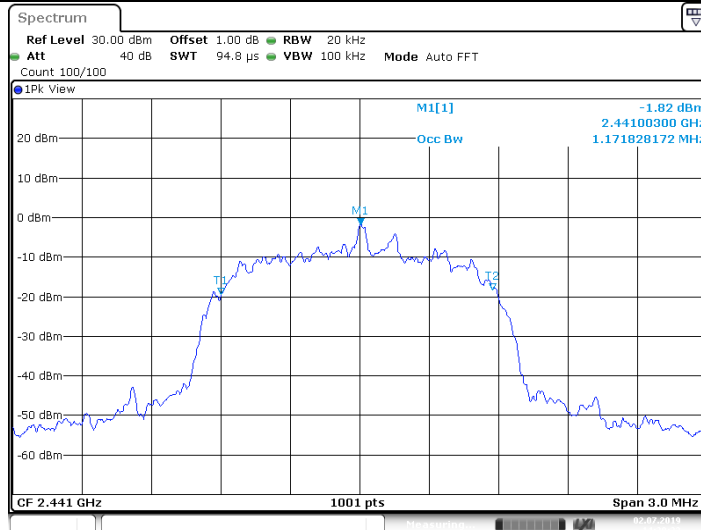

3DH5_Ant1_2480

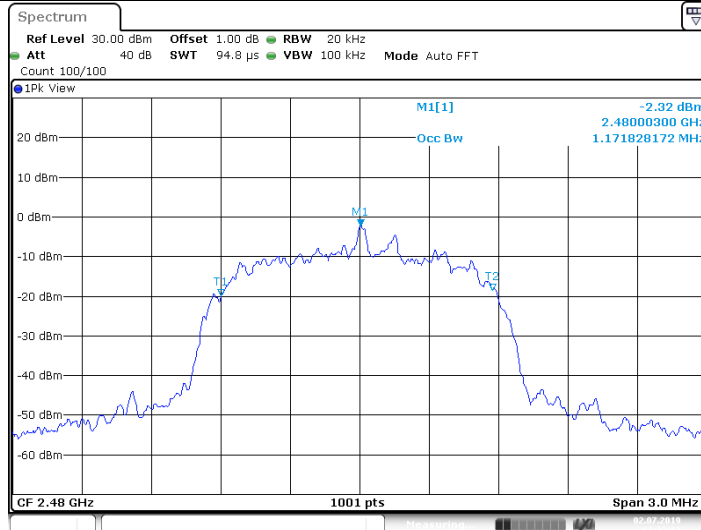



9.3 Carrier Frequency Separation

Test Method

1. The RF output of EUT was connected to the test receiver by RF cable the path loss was compensated to the results for each measurement.
2. Set to the maximum power setting and enable the EUT transmit to hopping mode.
3. Use the following spectrum analyzer settings:
Span = wide enough to capture the peaks of two adjacent channels, RBW \geq 1% of the span, VBW \geq RBW, Sweep = auto, Detector function = peak
4. By using the Max-Hold function record the separation of two adjacent channels.
5. Measure the frequency difference of these two adjacent channels by spectrum analyzer marker function. Record the results.
6. Repeat above procedures until all frequencies measured were complete.

Limit

Limit
kHz

 $\geq 25\text{kHz}$ or 2/3 of the 20 dB bandwidth which is greater

Limit

Frequency MHz	2/3 of 20 dB Bandwidth kHz
2402	736
2441	914
2480	920

Carrier Frequency Separation

Test result: The measurement was performed with the typical configuration (normal hopping status).

Modulation	Frequency MHz	Carrier Frequency Separation kHz	Result
GFSK	2441	849	Pass
$\pi/4$ -DQPSK	2441	1174	Pass
8DPSK	2441	1128	Pass

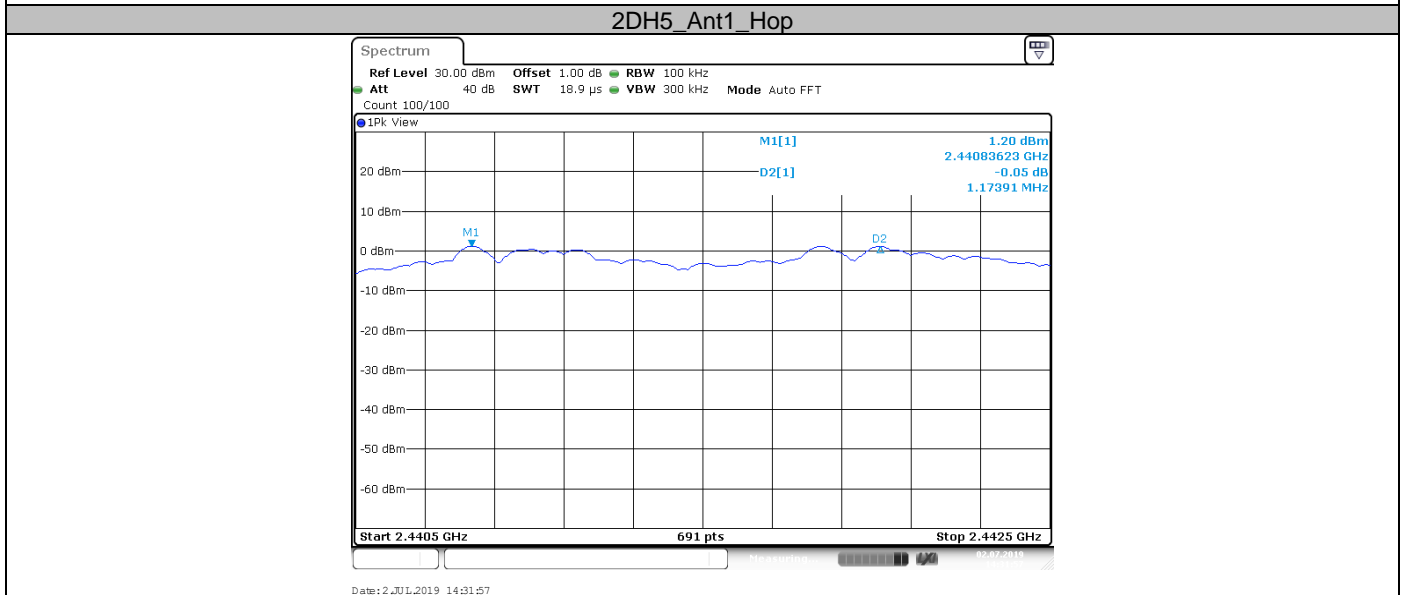
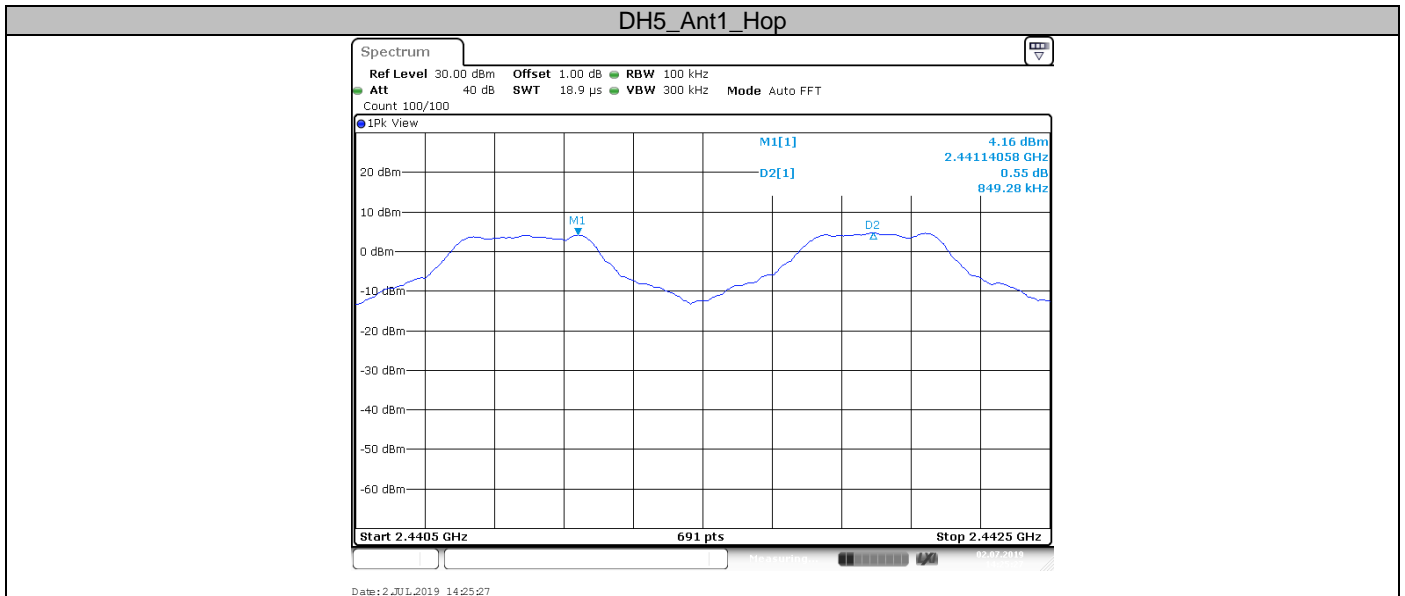

3DH5_Ant1_Hop

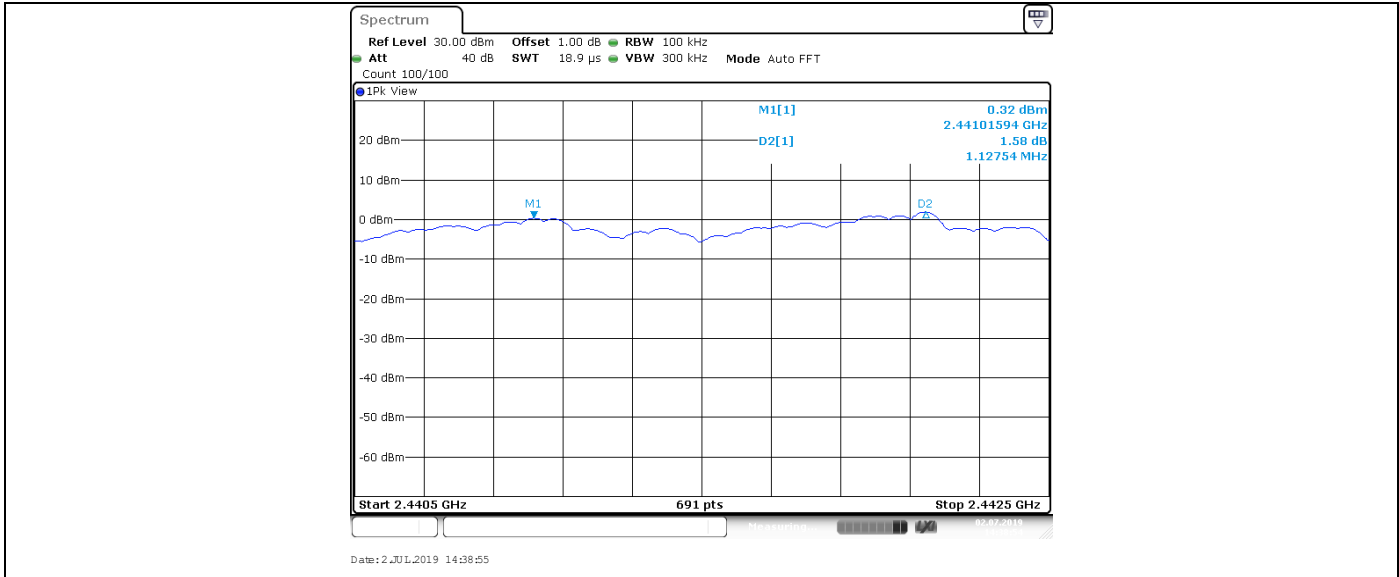

9.4 Number of hopping frequencies

Test Method

1. The RF output of EUT was connected to the test receiver by RF cable. The path loss was compensated to the results for each measurement.
2. Set to the maximum power setting and enable the EUT transmit to hopping mode.
3. Use the following spectrum analyzer settings:
Span = wide enough to capture the peaks of two adjacent channels, $RBW \geq 1\%$ of the span, $VBW \geq RBW$, Sweep = auto, Detector function = peak
4. Set the spectrum analyzer on Max-Hold Mode,
5. Record all the signals from each channel until each one has been recorded.
6. Repeat above procedures until all frequencies measured were complete.

Limit

Limit
number

≥ 15

Number of hopping frequencies

Test result: The measurement was performed with the typical configuration (normal hopping status), and the total hopping channels is constant for the all modulation mode according with the Bluetooth Core Specification.

TestMode	Antenna	Channel	Result	Limit	Verdict
DH5	Ant1	Hop	79	≥ 15	PASS
2DH5	Ant1	Hop	79	≥ 15	PASS
3DH5	Ant1	Hop	79	≥ 15	PASS

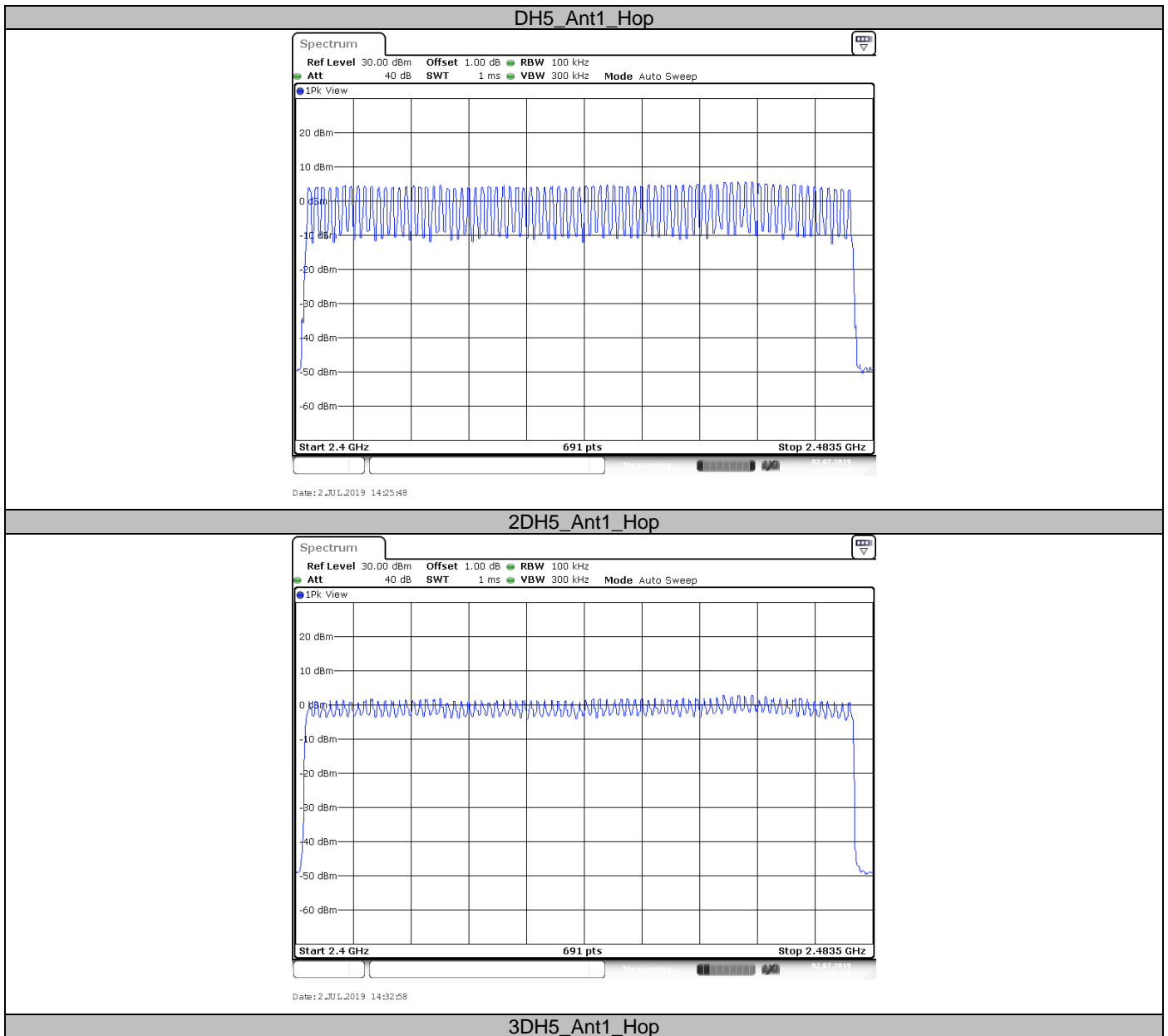

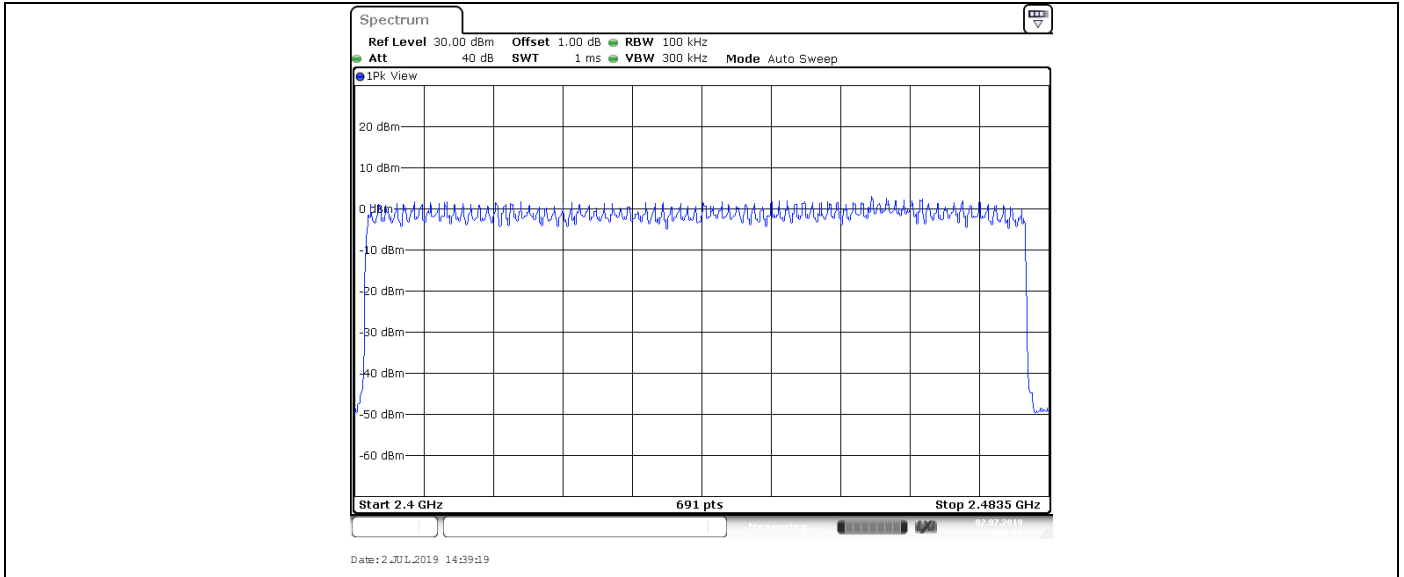

9.5 Dwell Time

Test Method

1. The RF output of EUT was connected to the test receiver by RF cable. The path loss was compensated to the results for each measurement.
2. Set to the maximum power setting and enable the EUT transmit to hopping mode.
3. Use the following spectrum analyzer settings:
RBW: 1MHz; VBW: 1MHz; SPAN: Zero Span
Set the spectrum analyzer on Max-Hold Mode,
4. Adjust the center frequency of spectrum analyzer on any frequency be measured.
5. Measure the Dwell Time by spectrum analyzer Marker function. Record the results.
Dwell Time = Burst Width * Total Hops
6. Repeat above procedures until all frequencies measured were complete.

Limit

The average time of occupancy on any frequency shall not be greater than 0.4 seconds within a period of 0.4 seconds multiplied by the number of hopping channels employed.

Dwell Time

Dwell time

The maximum dwell time shall be 0.4 s.

The Dwell Time = Burst Width * Total Hops. The detailed calculations are showed as follows:

The duration for dwell time calculation: 0.4 [s] * hopping number = 0.4 [s] * 79 [ch] = 31.6 [s*ch];

Test result as below:

TestMode	Antenna	Channel	BurstWidth (ms)	TotalHops	Result (s)	Limit (s)	Verdict
DH1	Ant1	Hop	0.38	330	0.125	<=0.4	PASS
DH3	Ant1	Hop	1.63	160	0.26	<=0.4	PASS
DH5	Ant1	Hop	2.87	110	0.315	<=0.4	PASS
2DH1	Ant1	Hop	0.38	320	0.123	<=0.4	PASS
2DH3	Ant1	Hop	1.63	150	0.244	<=0.4	PASS
2DH5	Ant1	Hop	2.87	90	0.258	<=0.4	PASS
3DH1	Ant1	Hop	0.38	320	0.123	<=0.4	PASS
3DH3	Ant1	Hop	1.63	180	0.293	<=0.4	PASS
3DH5	Ant1	Hop	2.87	100	0.287	<=0.4	PASS

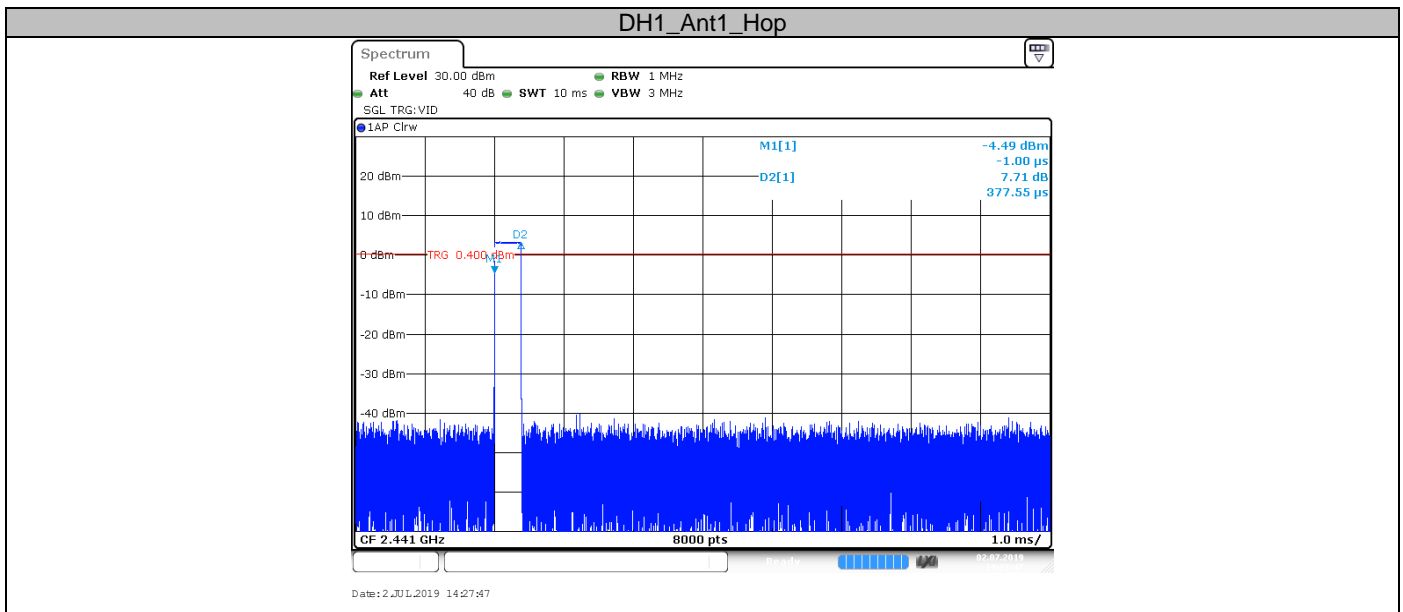

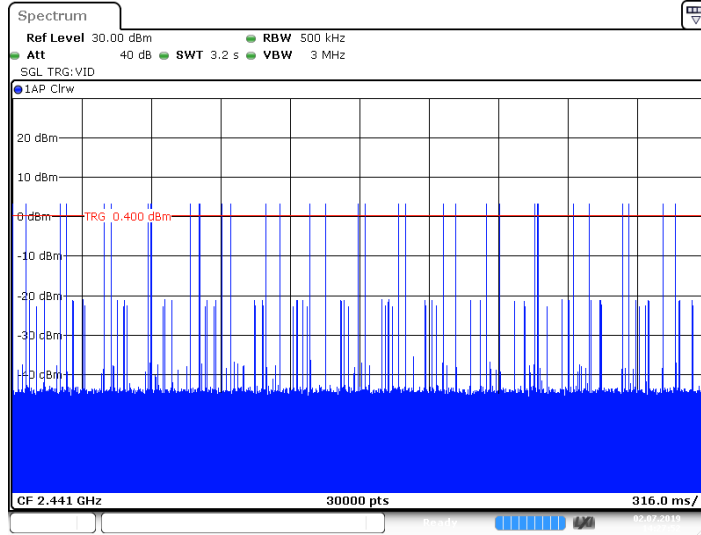

Date: 2 JUL 2019 14:27:53

DH3_Ant1_Hop

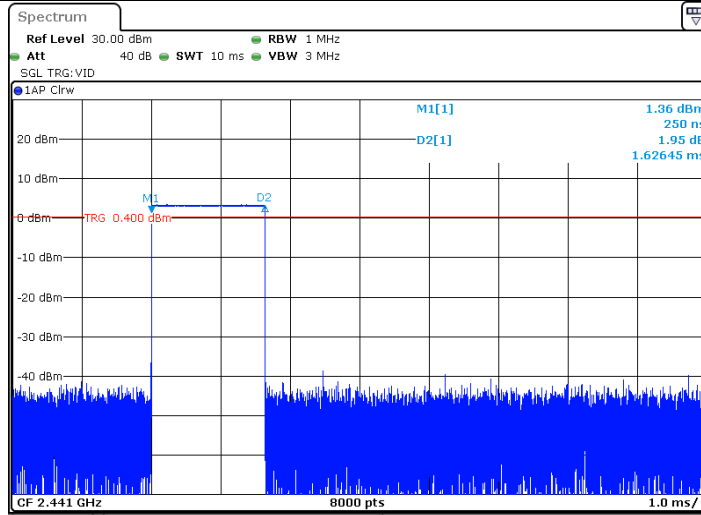

Date: 2 JUL 2019 14:28:42

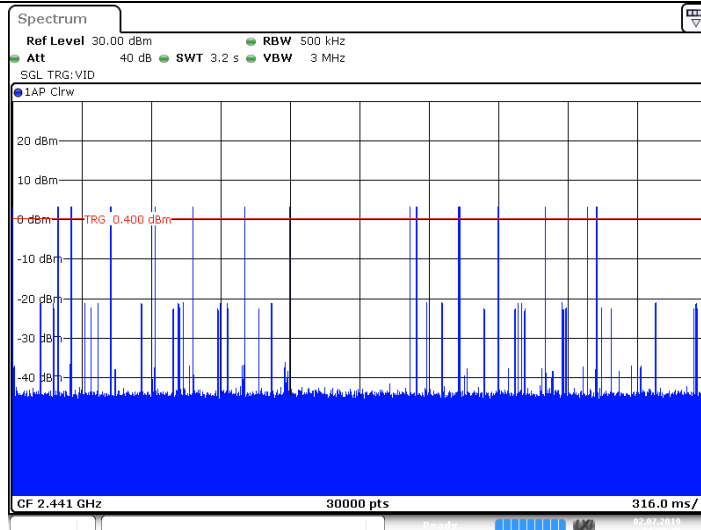

Date: 2 JUL 2019 14:28:48

DH5_Ant1_Hop

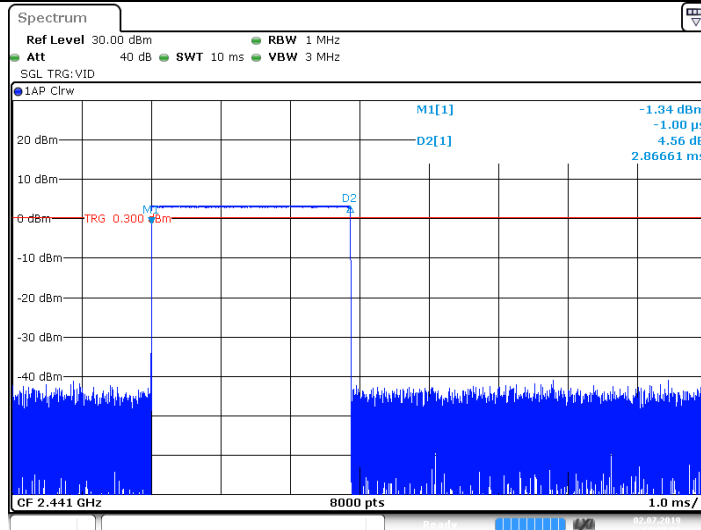

Date: 2 JUL 2019 14:27:06

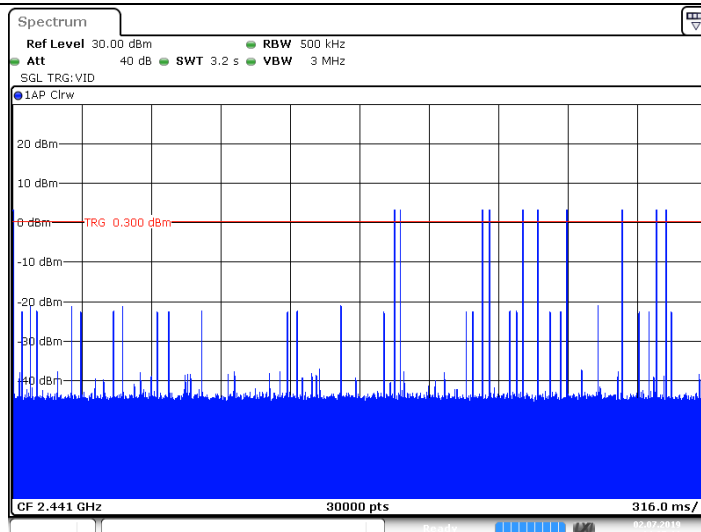

Date: 2 JUL 2019 14:27:11

2DH1_Ant1_Hop

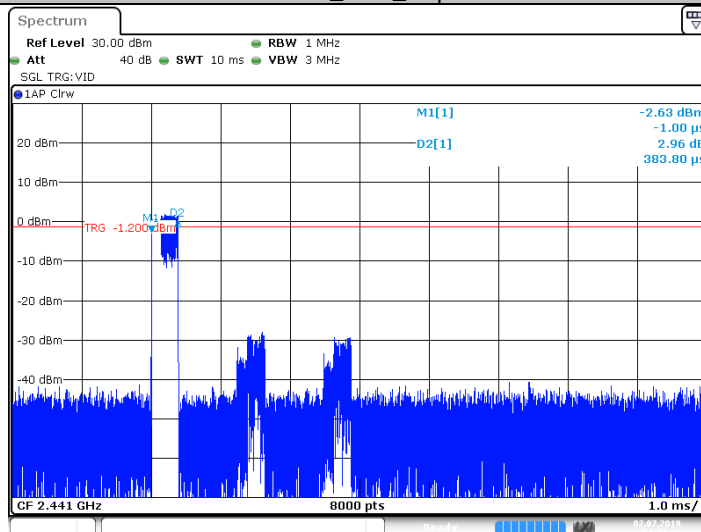

Date: 2 JUL 2019 14:34:30

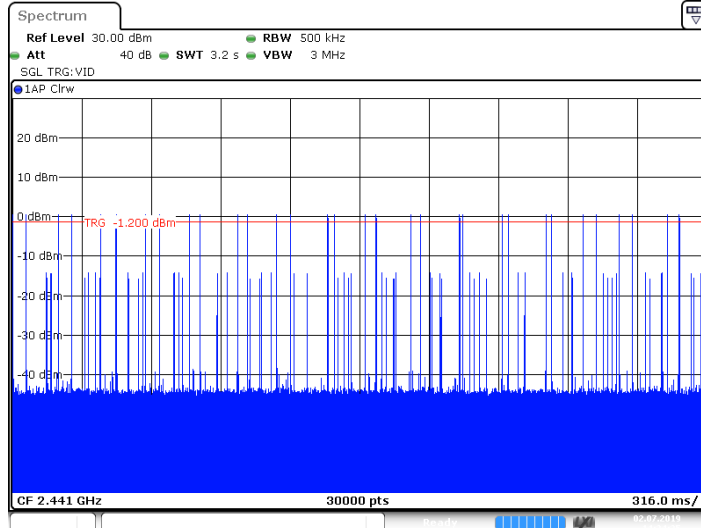

2DH3_Ant1_Hop

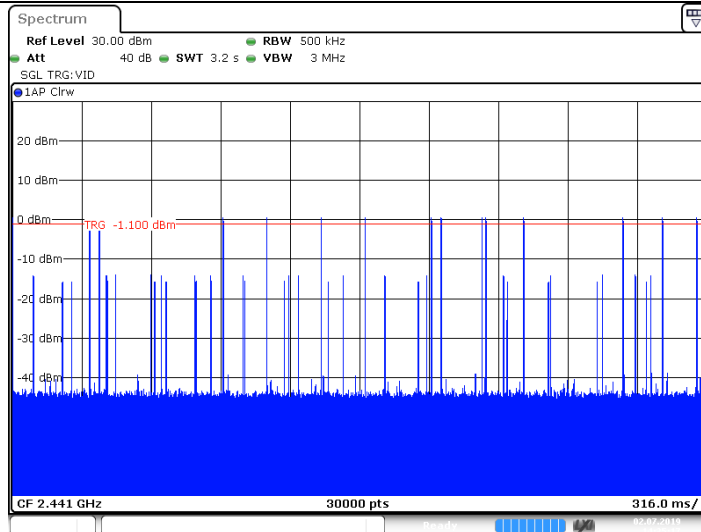
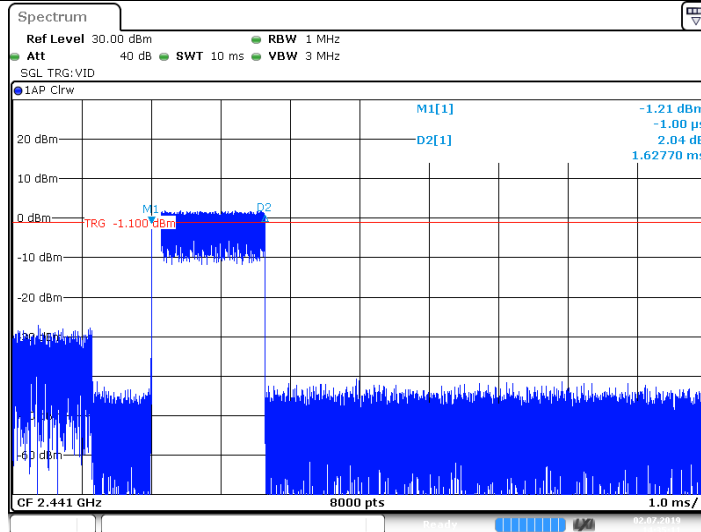

2DH5_Ant1_Hop

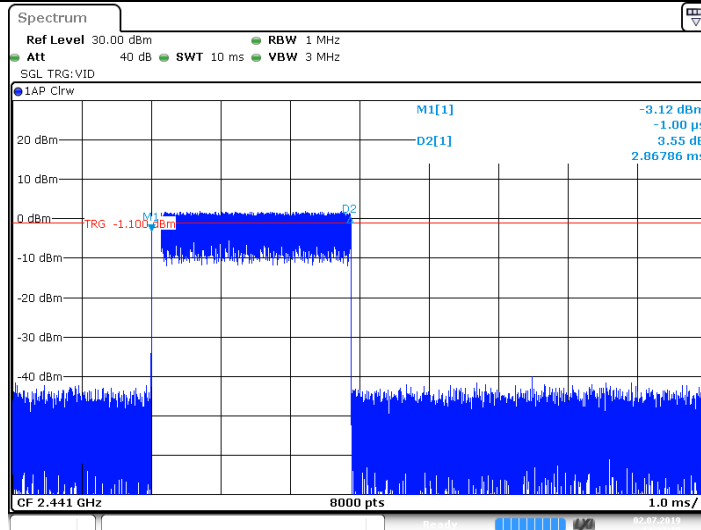

Date: 2 JUL 2019 14:33:10

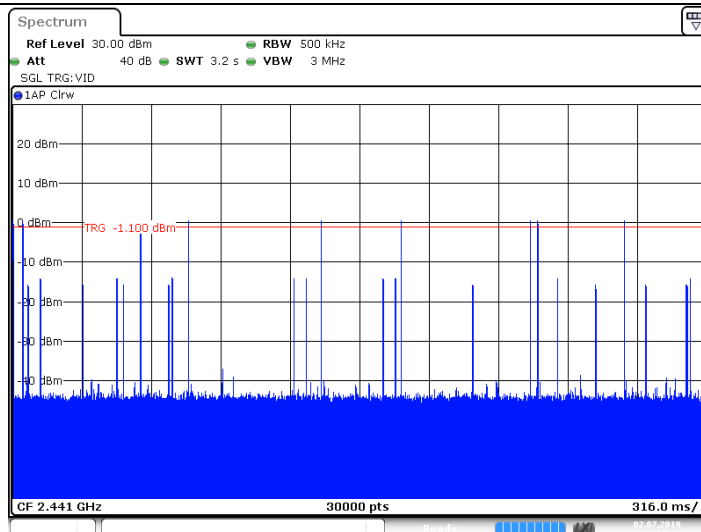

Date: 2 JUL 2019 14:33:16

3DH1_Ant1_Hop

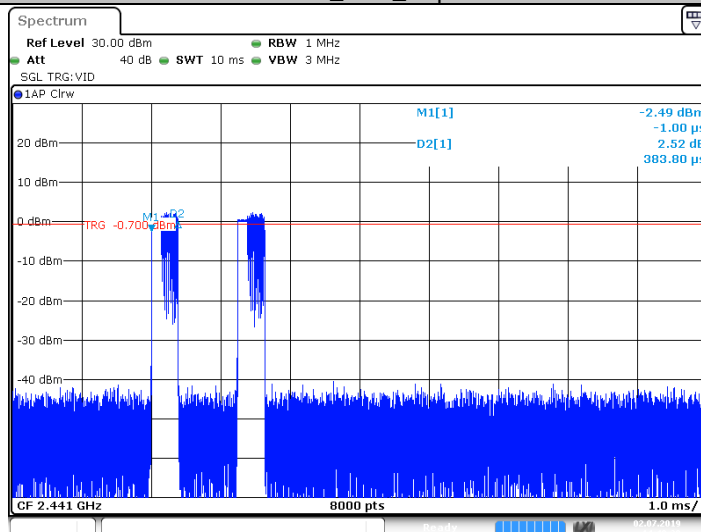

Date: 2 JUL 2019 14:40:20

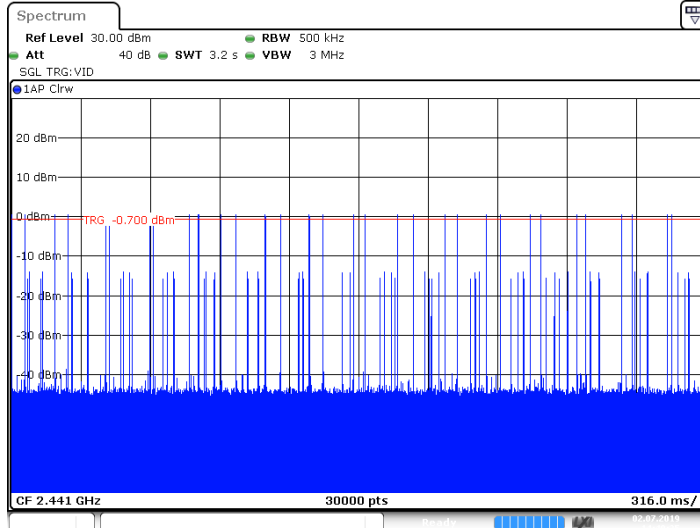

3DH3_Ant1_Hop

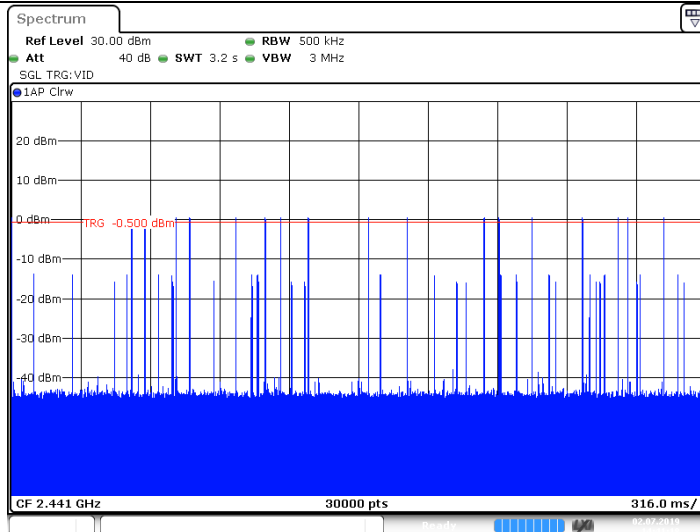
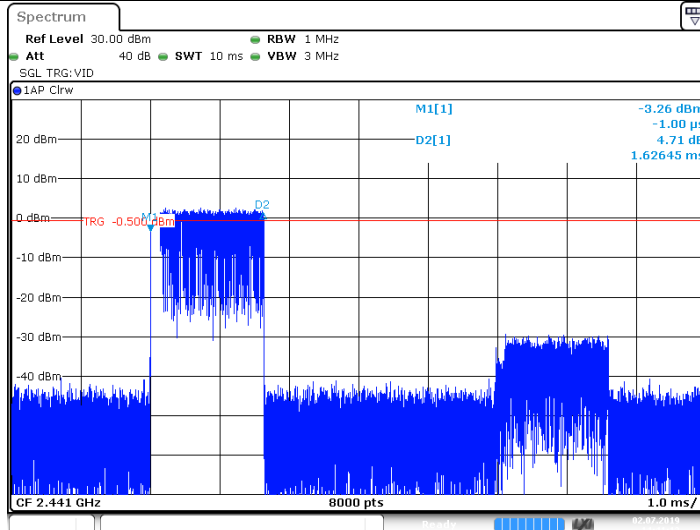

3DH5_Ant1_Hop

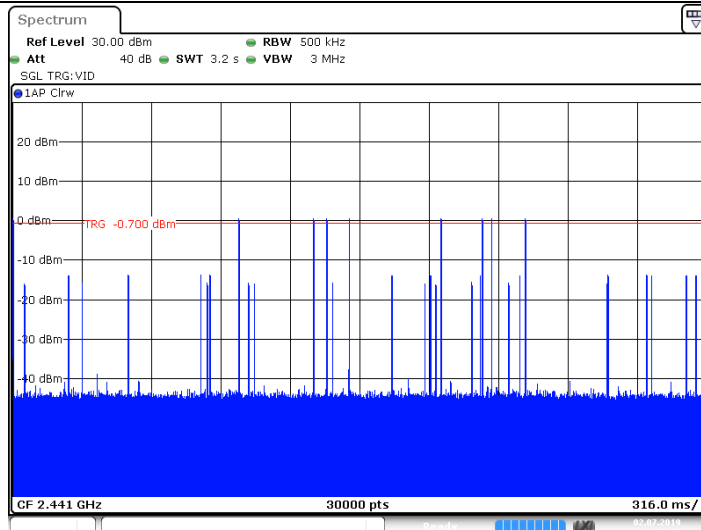
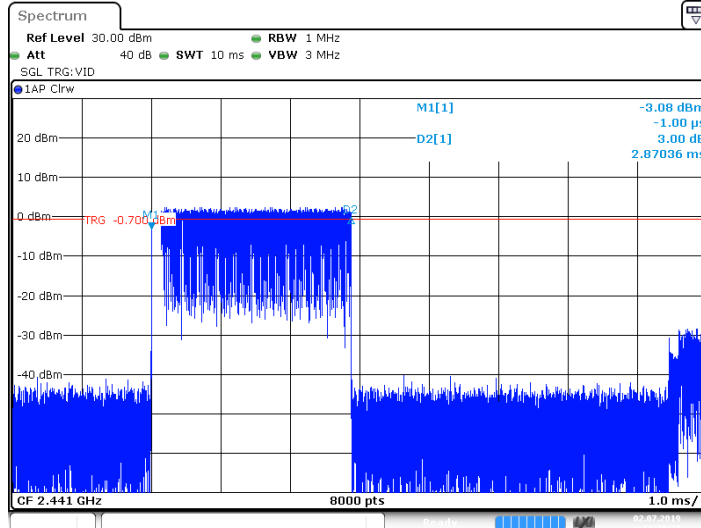

9.6 Spurious RF conducted emissions

Test Method

1. The RF output of EUT was connected to the spectrum analyzer by RF cable. The path loss was compensated to the results for each measurement.
2. Set to the maximum power setting and enable the EUT transmit continuously.
3. Set RBW = 100 kHz, VBW=300 kHz, Peak Detector. Unwanted Emissions measured in any 100 kHz bandwidth outside of the authorized frequency band shall be attenuated by at least 20 dB relative to the maximum in-band peak PSD level in 100 kHz when maximum peak conducted output power procedure is used. If the transmitter complies with the conducted power limits based on the use of RMS averaging over a time interval, the attenuation required under this paragraph shall be 30 dB instead of 20 dB.
4. Measure and record the results in the test report.
5. The RF fundamental frequency should be excluded against the limit line in the operating frequency

Limit

Frequency Range MHz	Limit (dBc)
30-25000	-20

Spurious RF conducted emissions

TestMode	Antenna	Channel (MHz)	FreqRange (MHz)	RefLevel	Result (dBm)	Limit (dBm)	Verdict
DH5	Ant1	2402	Reference	4.39	4.39	---	PASS
		2402	30~1000	30~1000	-68.13	<=-15.61	PASS
		2402	1000~26500	1000~26500	-51.58	<=-15.61	PASS
		2441	Reference	4.22	4.22	---	PASS
		2441	30~1000	30~1000	-68.1	<=-15.78	PASS
		2441	1000~26500	1000~26500	-52.21	<=-15.78	PASS
		2480	Reference	3.75	3.75	---	PASS
		2480	30~1000	30~1000	-67.94	<=-16.25	PASS
2DH5	Ant1	2402	Reference	1.37	1.37	---	PASS
		2402	30~1000	30~1000	-67.8	<=-18.63	PASS
		2402	1000~26500	1000~26500	-52.01	<=-18.63	PASS
		2441	Reference	1.27	1.27	---	PASS
		2441	30~1000	30~1000	-67.7	<=-18.73	PASS
		2441	1000~26500	1000~26500	-51.38	<=-18.73	PASS
		2480	Reference	0.79	0.79	---	PASS
		2480	30~1000	30~1000	-67.35	<=-19.21	PASS
3DH5	Ant1	2402	Reference	1.44	1.44	---	PASS
		2402	30~1000	30~1000	-67.89	<=-18.56	PASS
		2402	1000~26500	1000~26500	-52.24	<=-18.56	PASS
		2441	Reference	1.28	1.28	---	PASS
		2441	30~1000	30~1000	-68.26	<=-18.72	PASS
		2441	1000~26500	1000~26500	-51.83	<=-18.72	PASS
		2480	Reference	0.85	0.85	---	PASS
		2480	30~1000	30~1000	-67.31	<=-19.15	PASS
3DH5	Ant1	2480	1000~26500	1000~26500	-52.71	<=-19.15	PASS

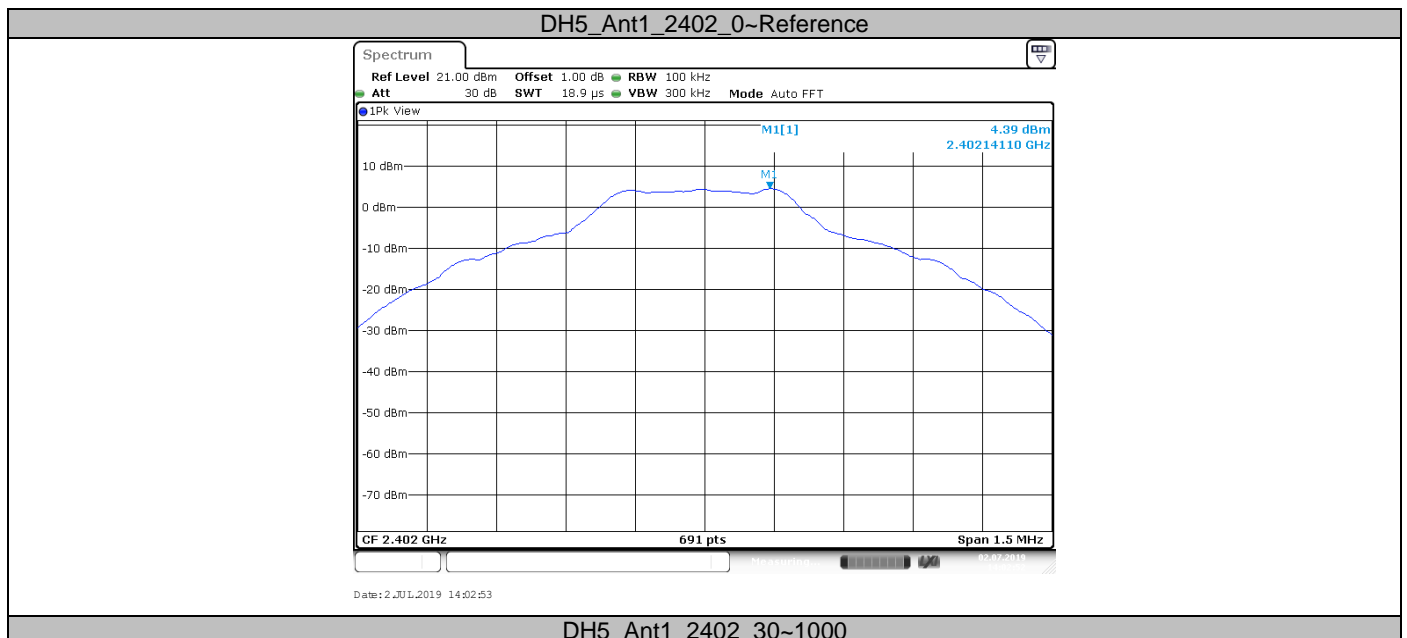

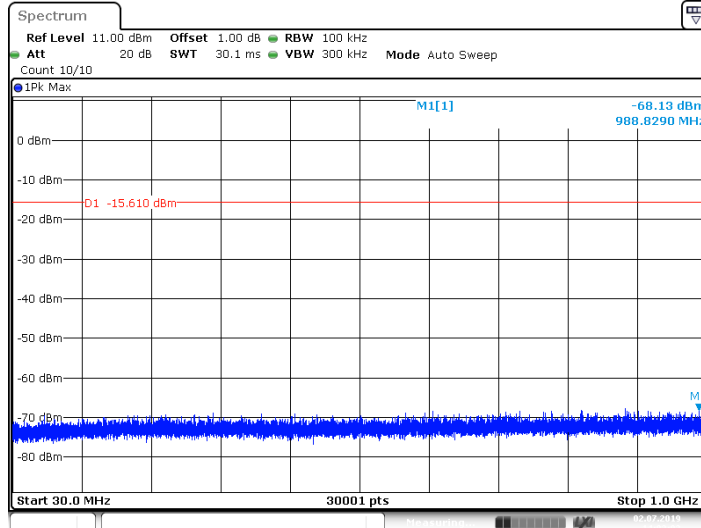

Date: 2 JUL 2019 14:03:02

DH5_Ant1_2402_1000~26500

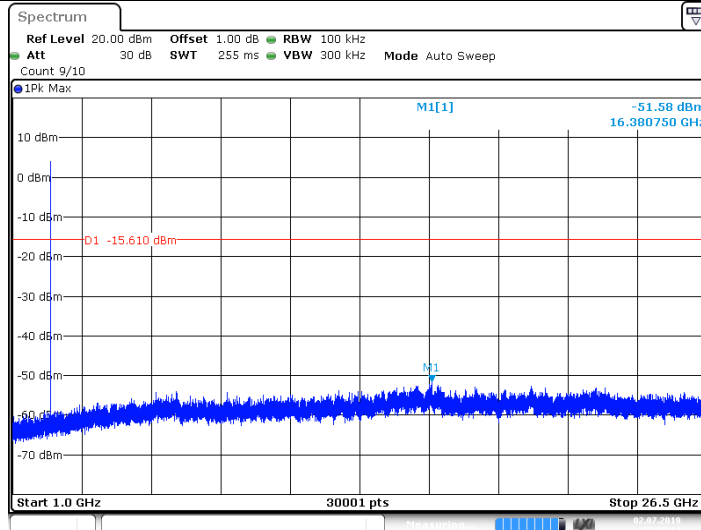

Date: 2 JUL 2019 14:03:14

DH5_Ant1_2441_0~Reference

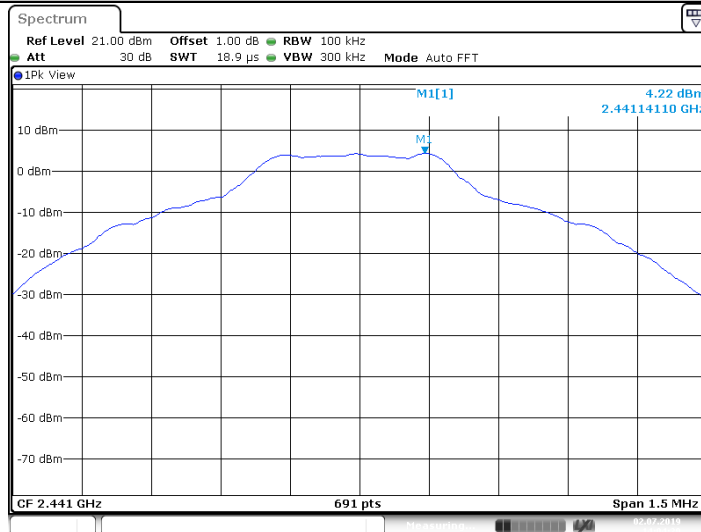

Date: 2 JUL 2019 14:04:29

DH5_Ant1_2441_30~1000

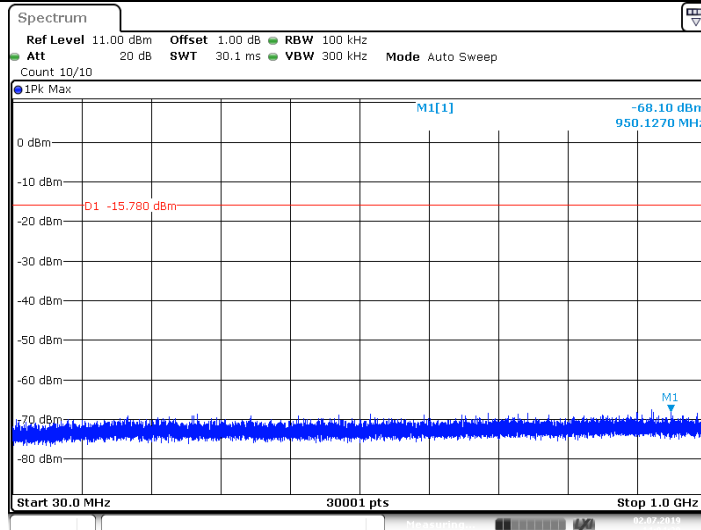

Date: 2 JUL 2019 14:04:39

DH5_Ant1_2441_1000~26500

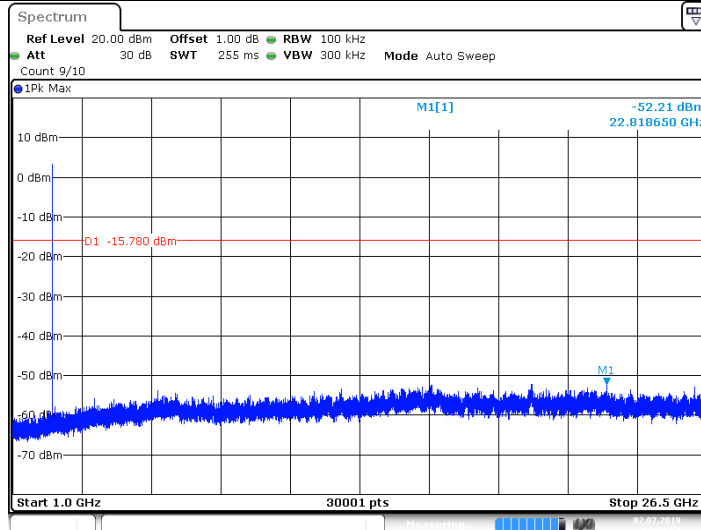

Date: 2 JUL 2019 14:04:50

DH5_Ant1_2480_0~Reference

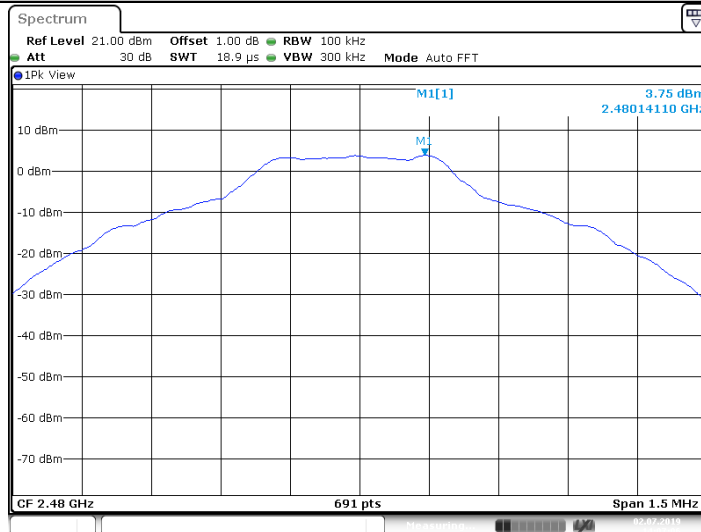

Date: 2 JUL 2019 14:07:07

DH5_Ant1_2480_30~1000

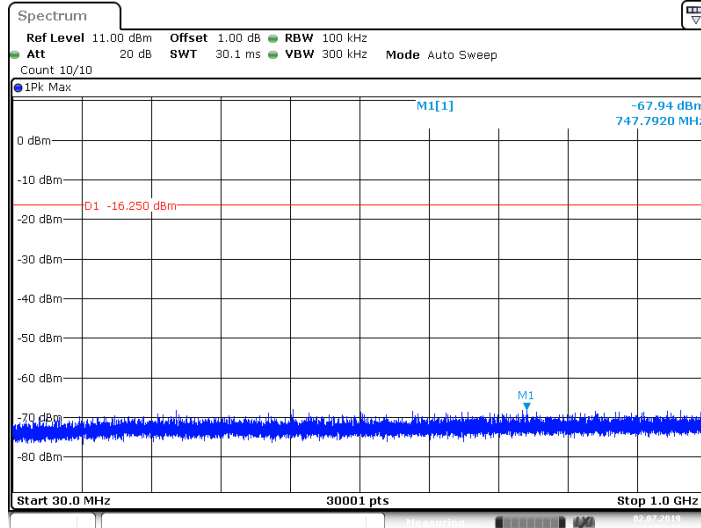

Date: 2 JUL 2019 14:07:16

DH5_Ant1_2480_1000~26500

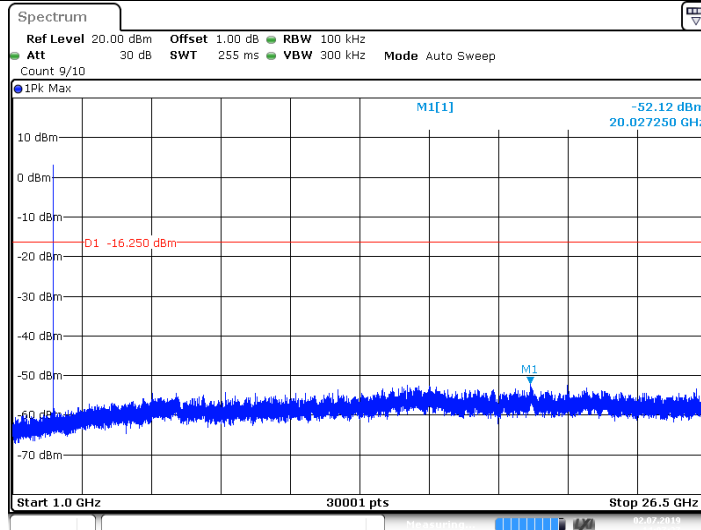

Date: 2 JUL 2019 14:07:28

2DH5_Ant1_2402_0~Reference

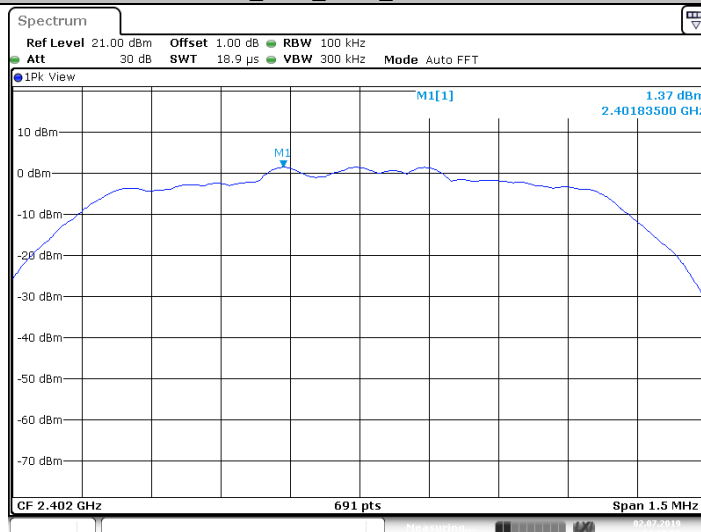

Date: 2 JUL 2019 14:10:50

2DH5_Ant1_2402_30~1000

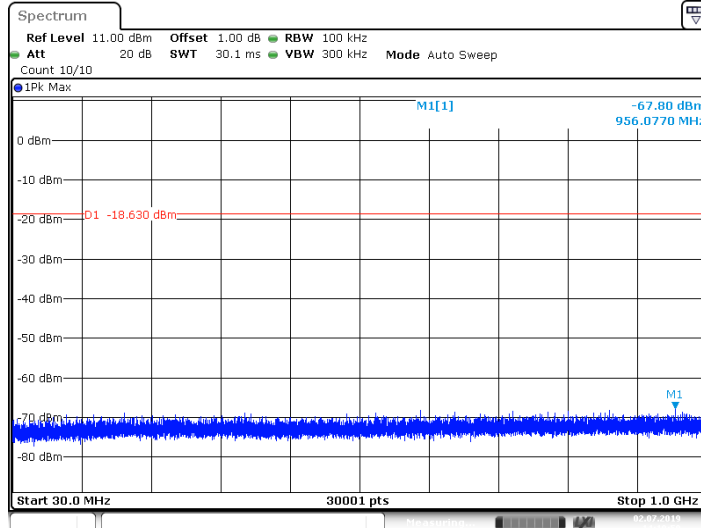

Date: 2 JUL 2019 14:11:50

2DH5_Ant1_2402_1000~26500

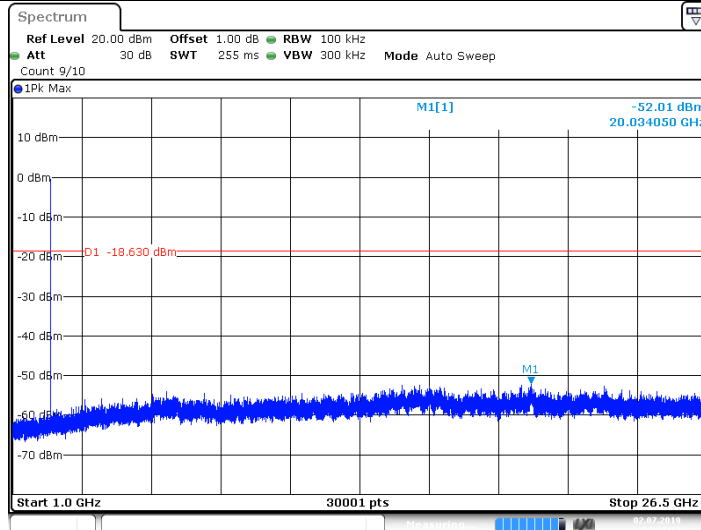

Date: 2 JUL 2019 14:11:11

2DH5_Ant1_2441_0~Reference

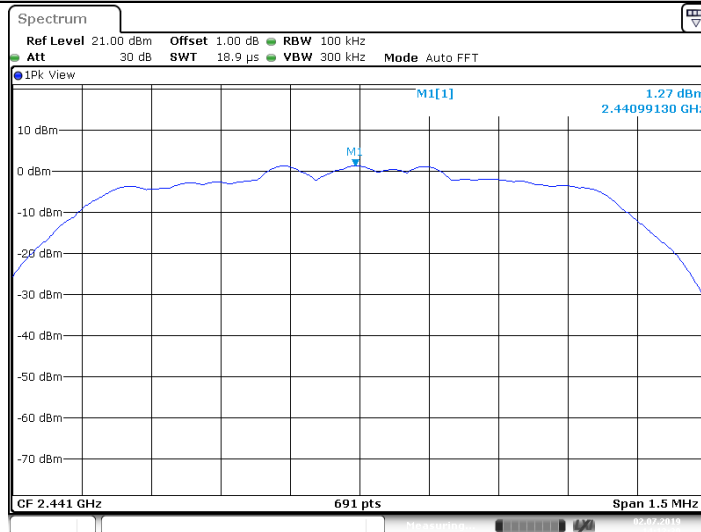

Date: 2 JUL 2019 14:12:39

2DH5_Ant1_2441_30~1000

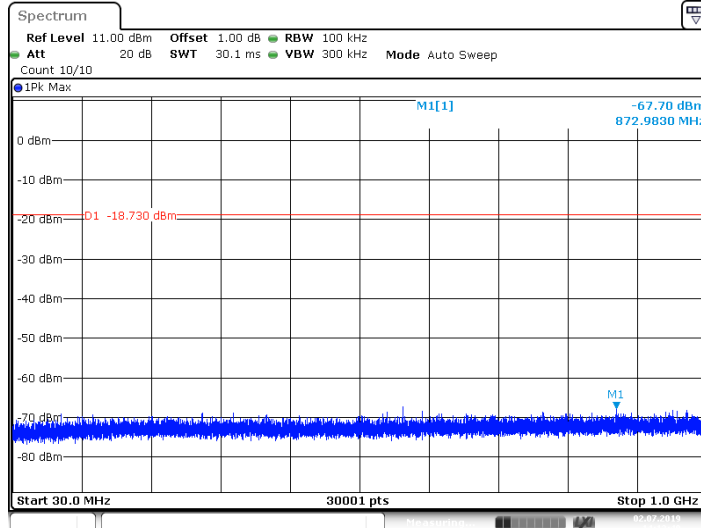

Date: 2 JUL 2019 14:12:49

2DH5_Ant1_2441_1000~26500

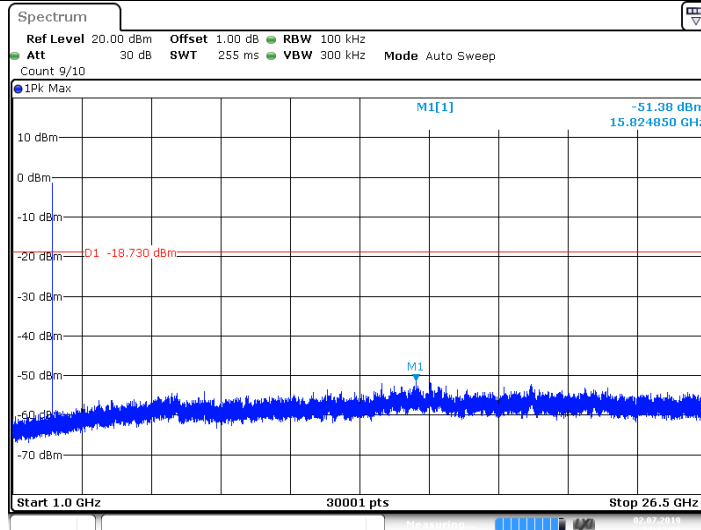

Date: 2 JUL 2019 14:13:00

2DH5_Ant1_2480_0~Reference

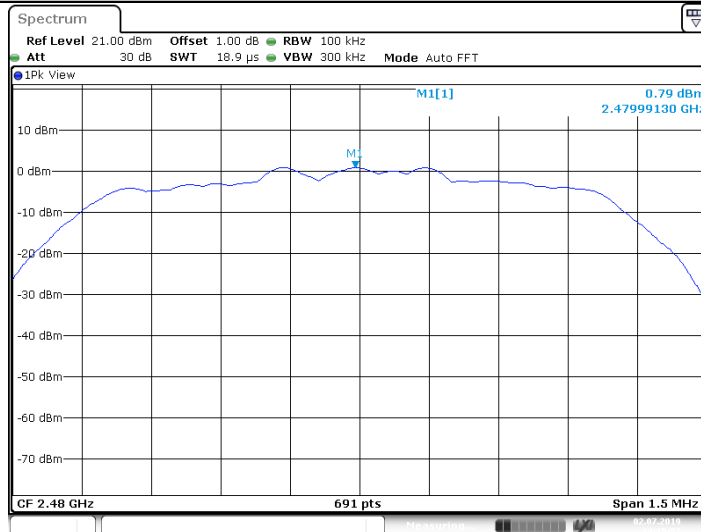

Date: 2 JUL 2019 14:15:53

2DH5_Ant1_2480_30~1000

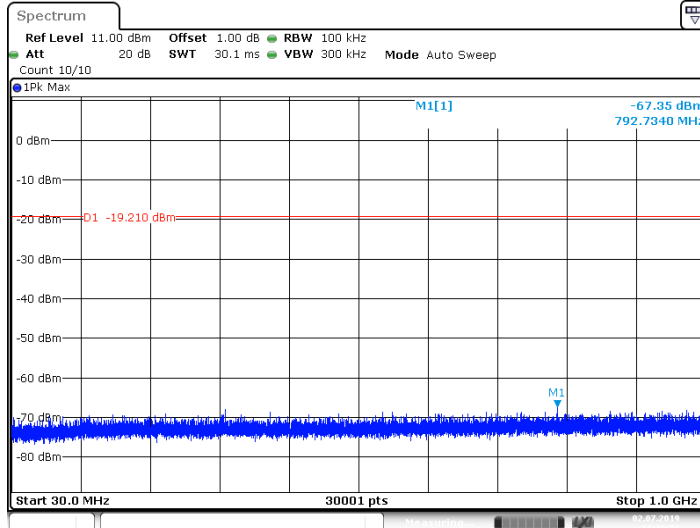

Date: 2 JUL 2019 14:16:02

2DH5_Ant1_2480_1000~26500

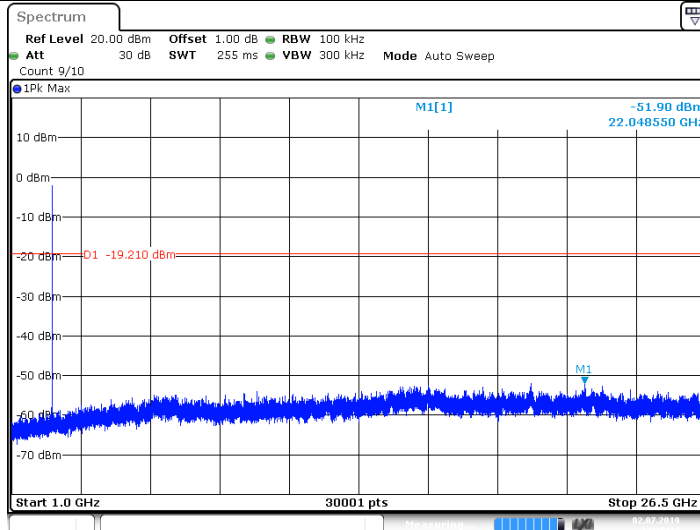

Date: 2 JUL 2019 14:16:14

3DH5_Ant1_2402_0~Reference

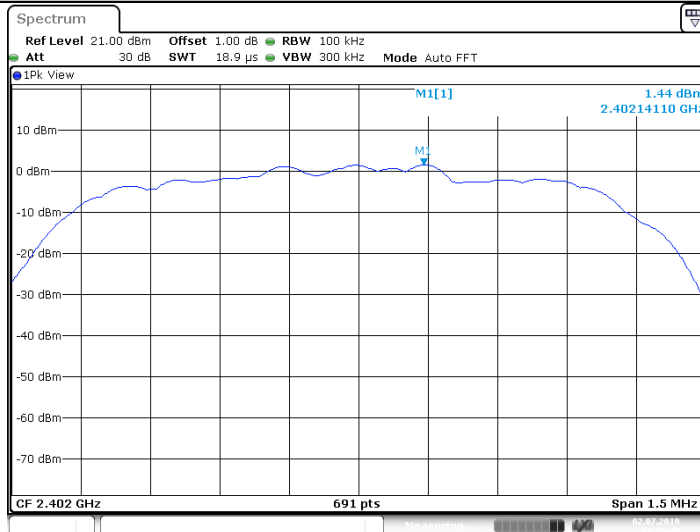

Date: 2 JUL 2019 14:18:40

3DH5_Ant1_2402_30~1000

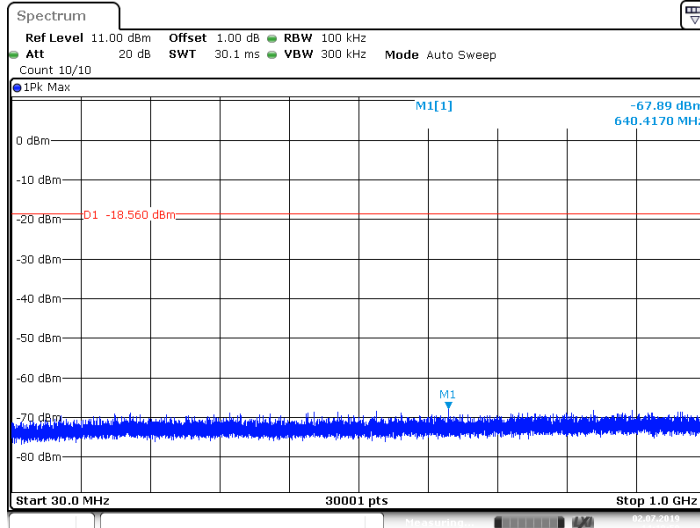

Date: 2 JUL 2019 14:18:50

3DH5_Ant1_2402_1000~26500

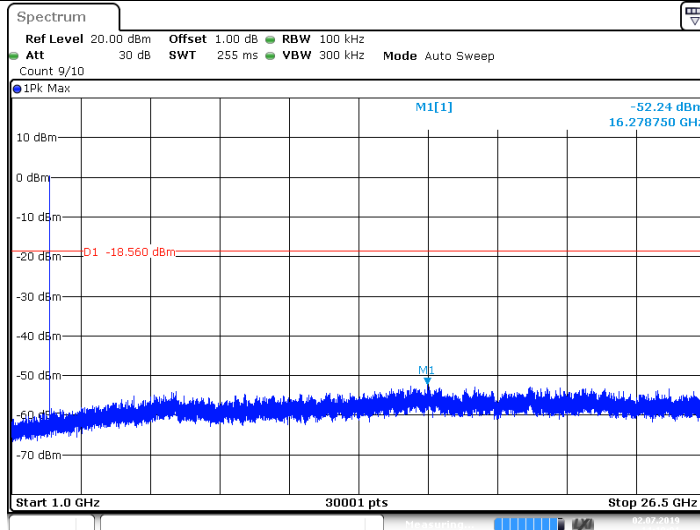

Date: 2 JUL 2019 14:19:01

3DH5_Ant1_2441_0~Reference

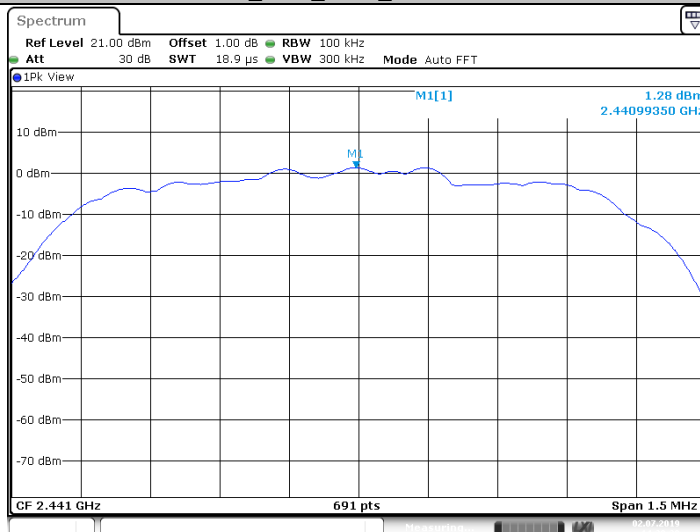

Date: 2 JUL 2019 14:20:29

3DH5_Ant1_2441_30~1000

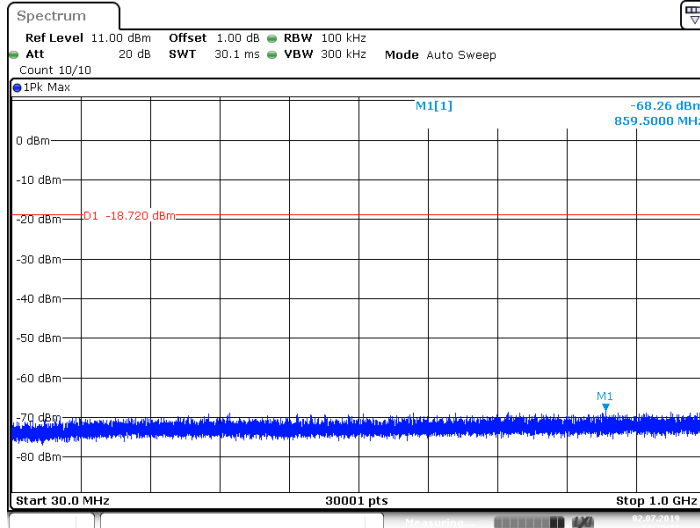

Date: 2 JUL 2019 14:20:39

3DH5_Ant1_2441_1000~26500

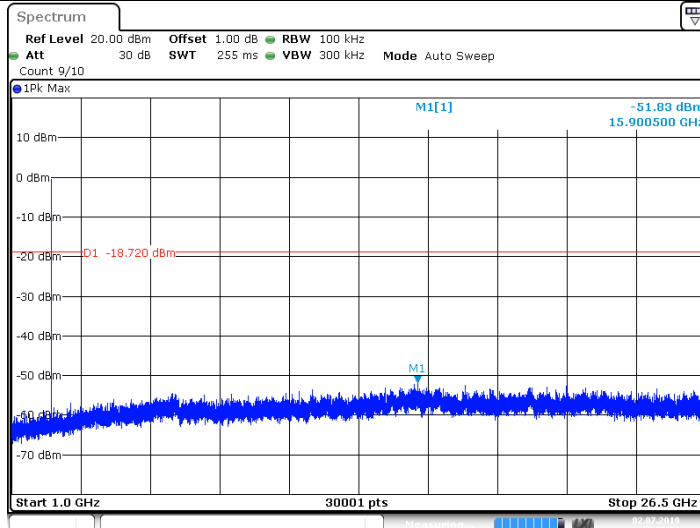

Date: 2 JUL 2019 14:20:50

3DH5_Ant1_2480_0~Reference

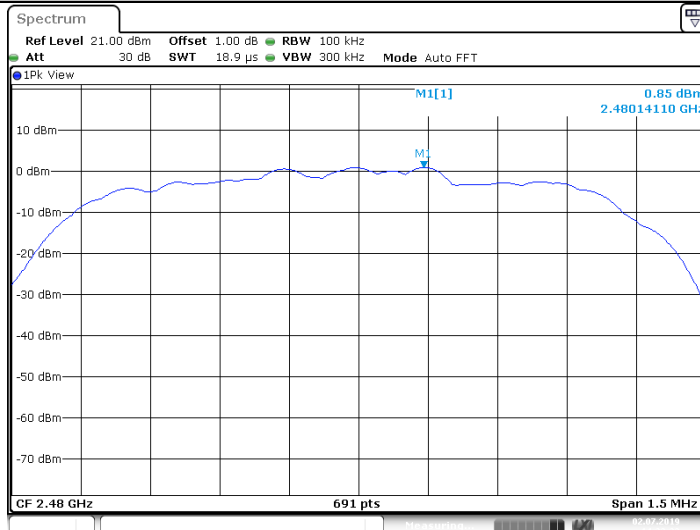

Date: 2 JUL 2019 14:23:24

3DH5_Ant1_2480_30~1000

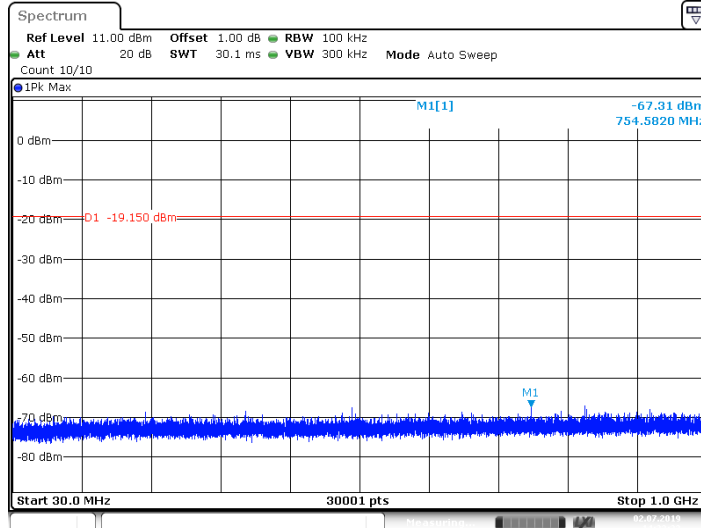

Date: 2 JUL 2019 14:23:33

3DH5_Ant1_2480_1000~26500

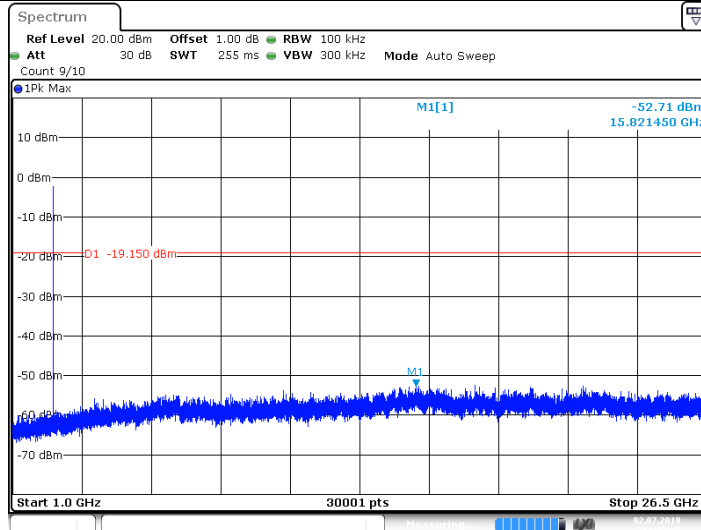

Date: 2 JUL 2019 14:23:45

9.7 Band edge testing

Test Method

1. The RF output of EUT was connected to the spectrum analyzer by RF cable. The path loss was compensated to the results for each measurement.
2. Set to the maximum power setting and enable the EUT transmit continuously.
3. Set RBW = 100 kHz, VBW=300 kHz, Peak Detector. Unwanted Emissions measured in any 100 kHz bandwidth outside of the authorized frequency band shall be attenuated by at least 20 dB relative to the maximum in-band peak PSD level in 100 kHz when maximum peak conducted output power procedure is used. If the transmitter complies with the conducted power limits based on the use of RMS averaging over a time interval, the attenuation required under this paragraph shall be 30 dB instead of 20 dB.
4. Measure and record the results in the test report.
5. The RF fundamental frequency should be excluded against the limit line in the operating frequency
6. Set to the maximum power setting and enable the EUT hopping mode, repeat the test.

Limit:

In any 100kHz bandwidth outside the frequency band in which the spread spectrum or digitally modulated device is operating, the RF power that is produced shall be at least 20 dB below that in the 100 kHz bandwidth within the band that contains the highest level of the desired power, based on either an RF conducted or a radiated measurement, provided that the transmitter demonstrates compliance with the peak conducted power limits.

Band edge

Test Result as below:

TestMode	Antenna	ChName	Channel (MHz)	RefLevel (dBm)	Result (dBm)	Limit (dBm)	Verdict
DH5	Ant1	Low	2402	4.17	-54.22	<=-15.83	PASS
		High	2480	3.72	-56.81	<=-16.28	PASS
		Low	Hop_2402	3.77	-58.29	-16.23	PASS
		High	Hop_2480	4.78	-57.42	-15.22	PASS
2DH5	Ant1	Low	2402	1.40	-58.68	<=-18.6	PASS
		High	2480	0.77	-56.9	<=-19.23	PASS
		Low	Hop_2402	-2.33	-58.71	-22.33	PASS
		High	Hop_2480	1.00	-57.26	-19	PASS
3DH5	Ant1	Low	2402	1.11	-58.24	<=-18.89	PASS
		High	2480	0.81	-56.61	<=-19.19	PASS
		Low	Hop_2402	-2.16	-57.95	-22.16	PASS
		High	Hop_2480	2.13	-58.12	-17.87	PASS

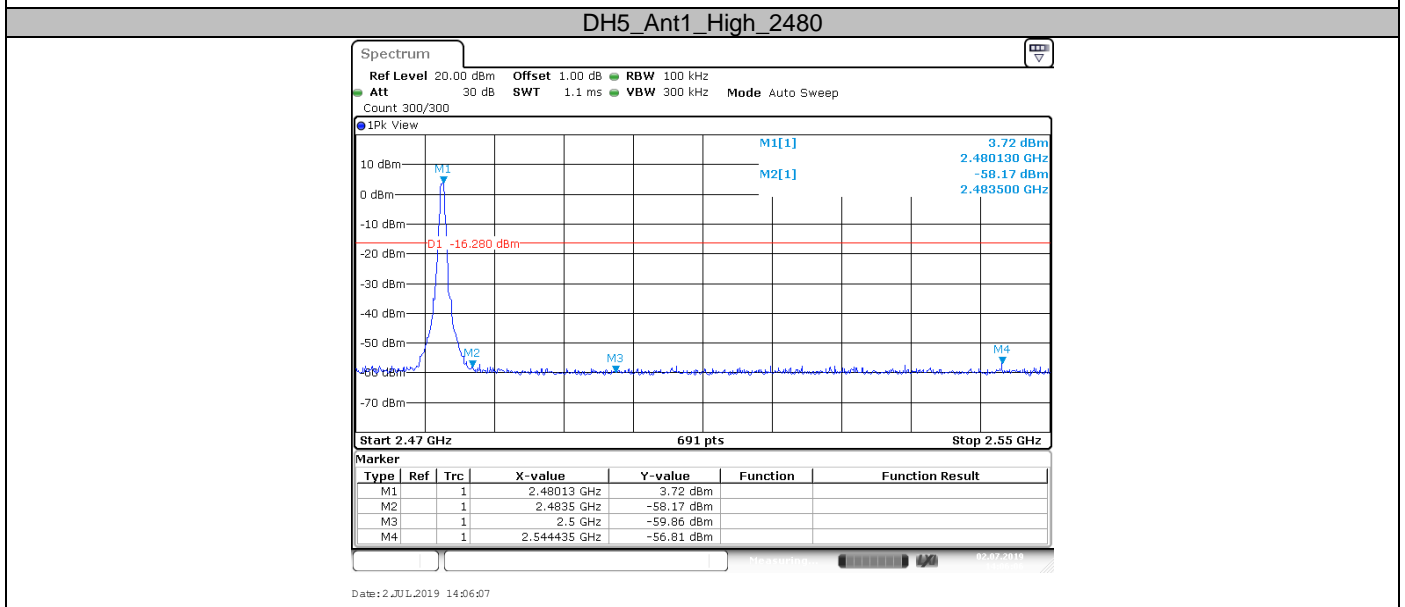
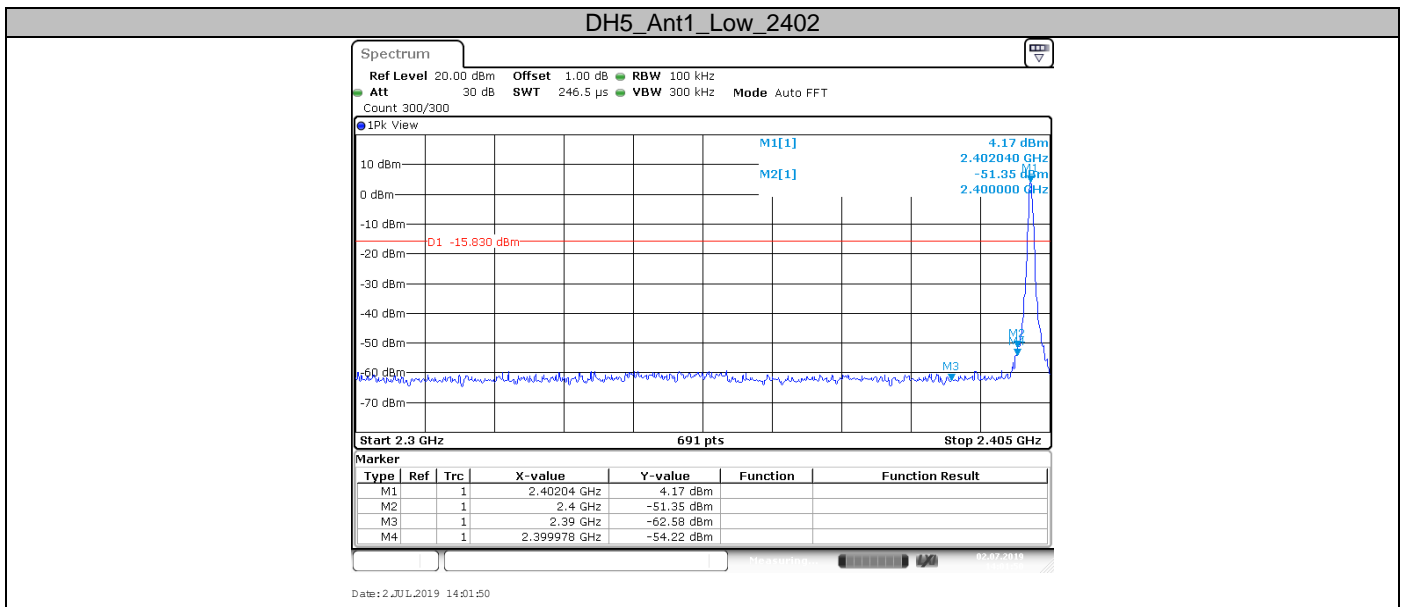

DH5_Ant1_Low_Hop_2402

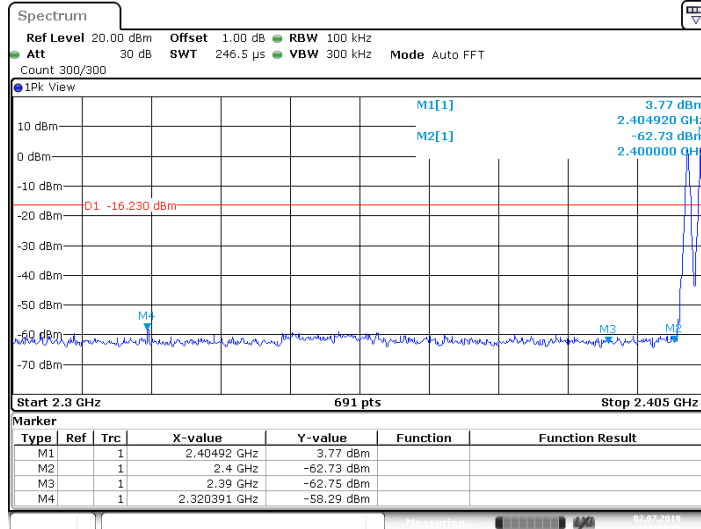

Date: 2 JUL 2019 14:24:21

DH5_Ant1_High_Hop_2480

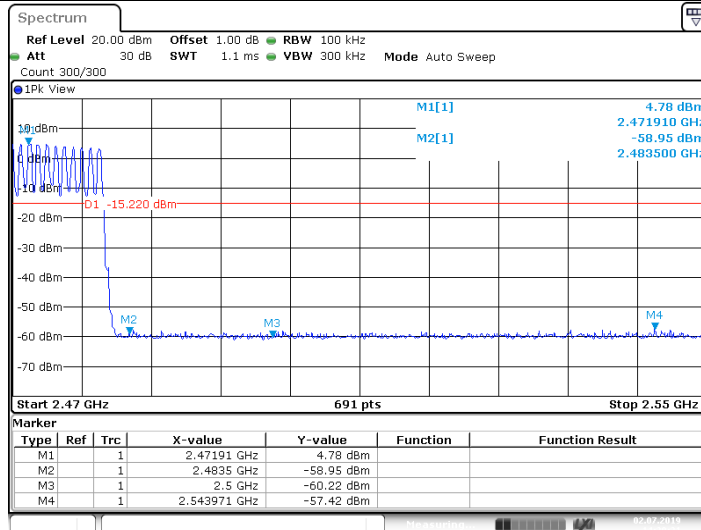

Date: 2 JUL 2019 14:29:31

2DH5_Ant1_Low_2402

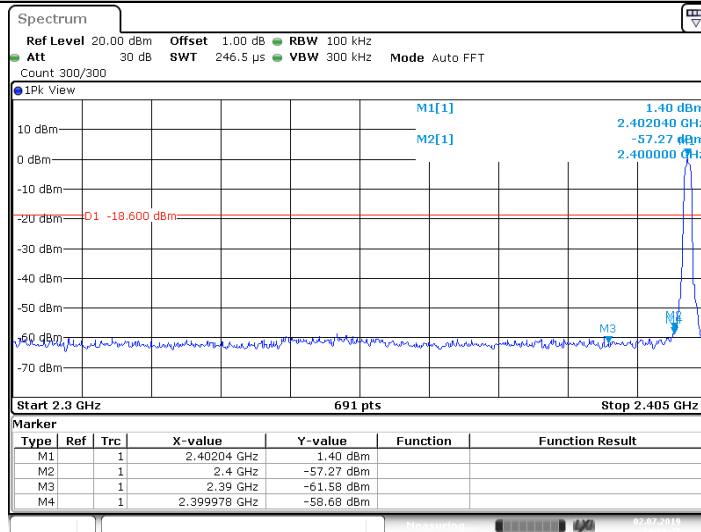

Date: 2 JUL 2019 14:09:48

2DH5_Ant1_High_2480

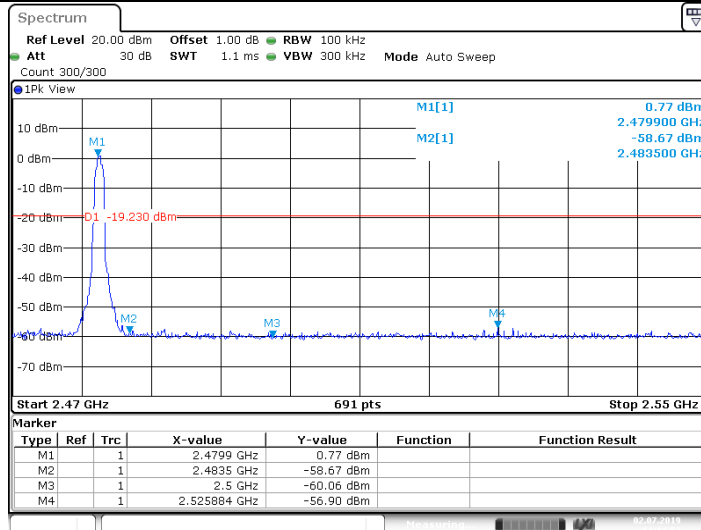

Date: 2 JUL 2019 14:14:53

2DH5_Ant1_Low_Hop_2402

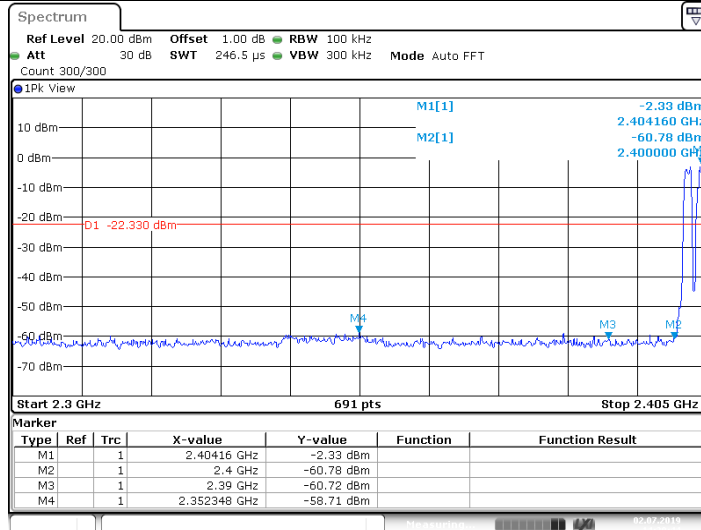

Date: 2 JUL 2019 14:30:44

2DH5_Ant1_High_Hop_2480

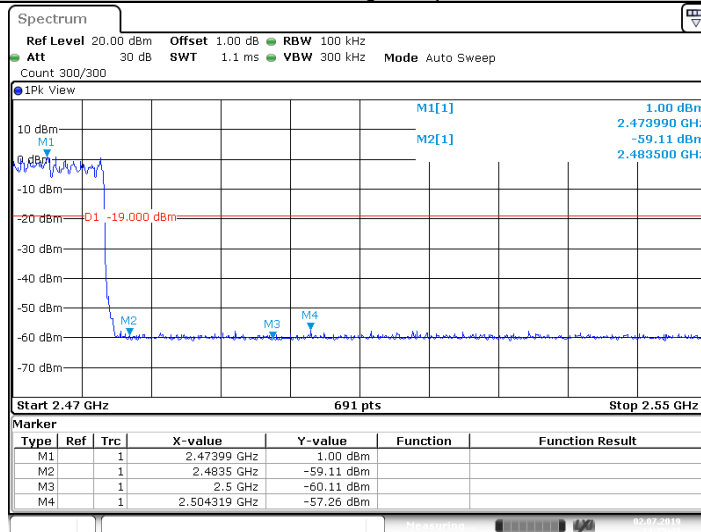

Date: 2 JUL 2019 14:35:42

3DH5_Ant1_Low_2402

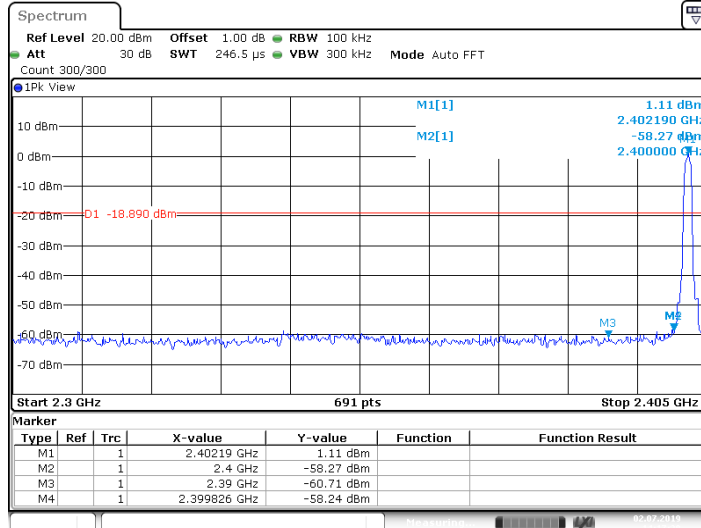

3DH5_Ant1_High_2480

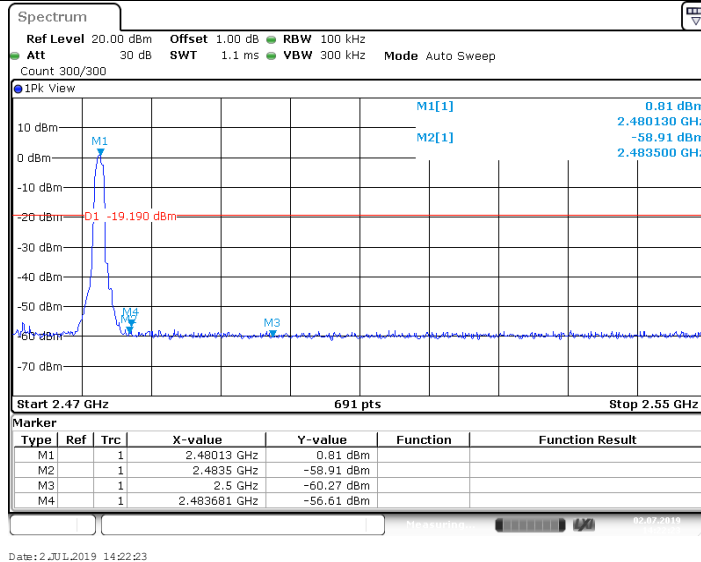

3DH5_Ant1_Low_Hop_2402

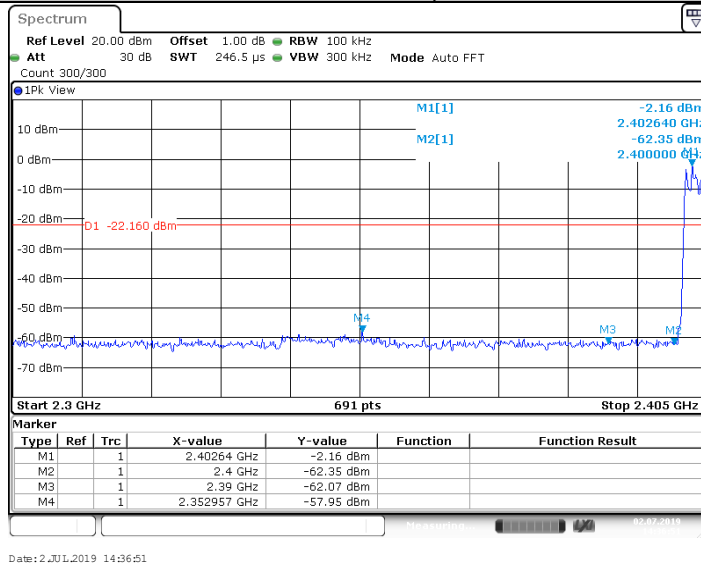

3DH5_Ant1_High_Hop_2480

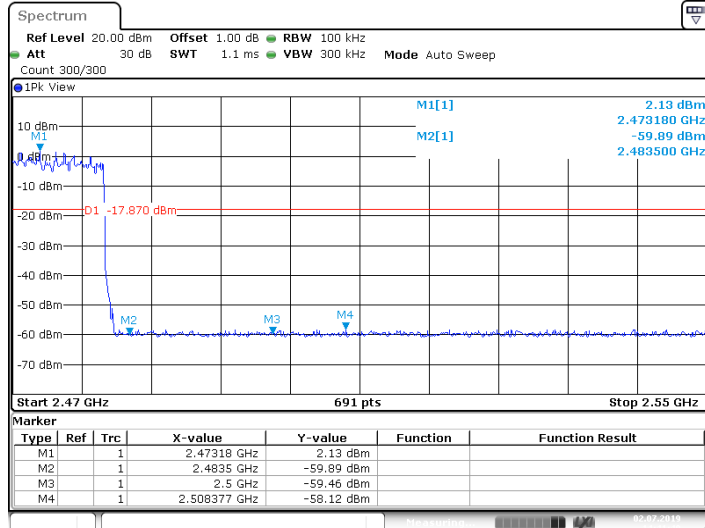

Date: 2 JUL 2019 14:41:49

9.8 Spurious radiated emissions for transmitter

Test Method

1. The EUT was placed on a turn table which is 1.5m above ground plane for above 1GHz and 0.8m above ground for below 1GHz at 3 meters chamber room for test. The table was rotated 360 degrees to determine the position of the highest radiation.
2. Set to the maximum power setting and enable the EUT transmit continuously
3. The EUT was set 3 meters away from the interference – receiving antenna, which was mounted on the top of a variable – height antenna tower.
4. The height of antenna is varied from one meter to four meters above the ground to determine the maximum value of the field strength. Both horizontal and vertical polarizations of the antenna are set to make the measurement.
5. For each suspected emission, the EUT was arranged to its worst case and then the antenna was tuned to heights from 1 meter to 4 meters and the rotatable table was turned from 0 degrees to 360 degrees to find the maximum reading.
6. Use the following spectrum analyzer settings According to C63.10:
 - (1) Span shall wide enough to fully capture the emission being measured;
 - (2) Set RBW=100 kHz for $f < 1$ GHz; VBW RBW; Sweep = auto; Detector function = peak; Trace = max hold;
 - (3) Set RBW = 1 MHz, VBW= 3MHz for $f \geq 1$ GHz for peak measurement.
 For average measurement:
 VBW = 10 Hz, when duty cycle is no less than 98 percent.
 VBW $\geq 1/T$, when duty cycle is less than 98 percent where T is the minimum transmission duration over which the transmitter is on and is transmitting at its maximum power control level for the tested mode of operation.
7. Repeat above procedures until all frequencies measured were complete.

Note:

- 1: The resolution bandwidth and video bandwidth of test receiver/spectrum analyzer is 120 KHz for Quasi-peak detection (QP) at frequency below 1GHz.
- 2: The resolution bandwidth of test receiver/spectrum analyzer is 1MHz and the video bandwidth is 3MHz for peak detection (PK) at frequency above 1GHz.
- 3: The resolution bandwidth of test receiver/spectrum analyzer is 1MHz and the video bandwidth is 3MHz for RMS Average ((duty cycle < 98%) for Average detection (AV) at frequency above 1GHz, then the measurement results was added to a correction factor ($20\log(1/\text{duty cycle})$).
- 4: The resolution bandwidth of test receiver/spectrum analyzer is 1MHz and the video bandwidth is 10Hz (duty cycle > 98%) for Average detection (AV) at frequency above 1GHz.

Spurious radiated emissions for transmitter

Limit

The radio emission outside the operating frequency band shall be at least 20 dB below that in the 100kHz bandwidth within the band that contains the highest level of the desired power. Radiated emissions which fall in the restricted bands, as defined in section 15.205, must comply with the radiated emission limits specified in section 15.209.

Frequency MHz	Field Strength $\mu\text{V/m}$	Field Strength $\text{dB}\mu\text{V/m}$	Detector
30-88	100	40	QP
88-216	150	43.5	QP
216-960	200	46	QP
960-1000	500	54	QP
Above 1000	500	54	AV
Above 1000	5000	74	PK

Spurious radiated emissions for transmitter

According to C63.10, if the peak (or quasi-peak) measured value complies with the average limit, it is unnecessary to perform an average measurement, so AV emission value did not show in below table if the peak value complies with average limit.

The only worse case (which is subject to the maximum EIRP, GFSK mode, 2402MHz) test result is listed in the report.

Transmitting spurious emission test result as below:

GFSK Modulation 2402MHz Test Result

Frequency Band	Frequency MHz	Emission Level dB μ V/m	Polarization	Limit dB μ V/m	Detector	Margin dB μ V/m	Correct factor (dB)	Result
30-1000MHz	53.60	20.95	H	40	QP	19.05	18.2	Pass
	518.88	27.16	H	46	QP	18.84	23.5	Pass
	745.81	29.89	H	46	QP	16.11	26.3	Pass
	879.29	34.58	H	46	QP	11.42	28.6	Pass
	Other Frequencies	--	H	--	QP	--	--	Pass
	43.80	21.01	V	40	QP	18.99	18.9	Pass
	60.66	24.97	V	40	QP	15.03	17.0	Pass
	631.08	28.21	V	46	QP	17.79	25.3	Pass
	943.26	35.51	V	46	QP	10.49	29.3	Pass
	Other Frequencies	--	V	--	QP	--	--	Pass
1000-25000MHz	1556.38	29.29	H	74	PK	44.71	-10.8	Pass
	2023.88	38.37	H	74	PK	35.63	-9.1	Pass
	*2496.94	42.61	H	74	PK	31.39	-5.1	Pass
	Other Frequencies	--	H	--	PK	--	--	Pass
	1256.06	29.01	V	74	PK	44.99	-12.0	Pass
	2522.94	33.08	V	74	PK	40.92	-5.0	Pass
	Other Frequencies	--	V	--	PK	--	--	Pass

Remark:

- (1) "*" means the emission(s) appear within the restrict bands shall follow the requirement of section 15.205.
- (2) Data of measurement within this frequency range shown "--" in the table above means the reading of emissions are the noise floor or attenuated more than 20dB below the permissible limits or the field strength is too small to be measured.
- (3) Corrected Amplitude = Read level + Corrector factor
 Above 1GHz: Corrector factor = Antenna Factor + Cable Loss- Amplifier Gain
 Below 1GHz: Corrector factor = Antenna Factor + Cable Loss
 (The Reading Level is recorded by software which is not shown in the sheet)

10 Test Equipment List

List of Test Instruments

Radiated Emission Test

DESCRIPTION	MANUFACTURER	MODEL NO.	SERIAL NO.	CAL. DUE DATE
EMI Test Receiver	Rohde & Schwarz	ESR 26	101269	2020-6-28
Trilog Super Broadband Test Antenna	Schwarzbeck	VULB 9163	707	2020-6-28
Horn Antenna	Rohde & Schwarz	HF907	102294	2020-6-22
Loop Antenna	Rohde & Schwarz	HFH2-Z2	100398	2020-7-7
Pre-amplifier	Rohde & Schwarz	SCU 18	102230	2020-6-28
Signal Generator	Rohde & Schwarz	SMY01	839369/005	2020-6-28
Attenuator	Agilent	8491A	MY39264334	2020-6-28
3m Semi-anechoic chamber	TDK	9X6X6	----	2020-7-7

Conducted RF Test System

DESCRIPTION	MANUFACTURER	MODEL NO.	SERIAL NO.	CAL. DUE DATE
Signal Analyzer	Rohde & Schwarz	FSV40	101030	2020-6-28
RF Switch Module	Rohde & Schwarz	OSP120/OSP-B157	101226/100851	2020-6-28
Power Splitter	Weinschel	1580	SC319	2020-7-7
Test software	Tonscend	System for BT/WIFI	Version 2.5.77.0418	N/A

11 System Measurement Uncertainty

For a 95% confidence level, the measurement expanded uncertainties for defined systems, in accordance with the recommendations of ISO 17025 were:

System Measurement Uncertainty	
Test Items	Extended Uncertainty
Uncertainty for Radiated Spurious Emission 25MHz-3000MHz	Horizontal: 4.91dB; Vertical: 4.89dB;
Uncertainty for Radiated Spurious Emission 3000MHz-18000MHz	Horizontal: 4.80dB; Vertical: 4.79dB;
Uncertainty for Radiated Spurious Emission 18000MHz-40000MHz	Horizontal: 5.05dB; Vertical: 5.04dB;
Uncertainty for Conducted RF test with TS 8997	RF Power Conducted: 1.16dB Frequency test involved: 0.6×10^{-7} or 1%