



		20175/1732.5	40°C/Normal Voltage	0.00137	-0.00032
		20175/1732.5	50°C/Normal Voltage	0.00151	-0.01071
		20175/1732.5	60°C/Normal Voltage	0.00287	-0.00877
		20175/1732.5	70°C/Normal Voltage	0.00133	-0.00516
		20175/1732.5	80°C/Normal Voltage	0.00112	-0.00762
		20175/1732.5	85°C/Normal Voltage	-0.00040	-0.00311
		20175/1732.5	20°C/Minimum Voltage	-0.00021	-0.00851
		20175/1732.5	20°C/Maximum Voltage	0.00068	-0.00203
	10MHz	20175/1732.5	-40°C/Normal Voltage	0.00605	-0.00777
		20175/1732.5	-30°C/Normal Voltage	0.00137	-0.00032
		20175/1732.5	-20°C/Normal Voltage	0.00171	0.01895
		20175/1732.5	-10°C/Normal Voltage	-0.00178	0.01656
		20175/1732.5	0°C/Normal Voltage	0.00104	0.01567
		20175/1732.5	10°C/Normal Voltage	0.00405	0.01745
		20175/1732.5	20°C/Normal Voltage	0.00079	-0.01113
		20175/1732.5	30°C/Normal Voltage	0.00263	-0.04043
		20175/1732.5	40°C/Normal Voltage	0.00163	0.01960
		20175/1732.5	50°C/Normal Voltage	0.00363	-0.01194
		20175/1732.5	60°C/Normal Voltage	0.00133	-0.00311
		20175/1732.5	70°C/Normal Voltage	0.00121	-0.00869
		20175/1732.5	80°C/Normal Voltage	0.00094	-0.01112
		20175/1732.5	85°C/Normal Voltage	0.00424	-0.01329
		20175/1732.5	20°C/Minimum Voltage	0.00096	0.01844
		20175/1732.5	20°C/Maximum Voltage	-0.00119	0.01889
		15MHz	20175/1732.5	-40°C/Normal Voltage	0.00194
	20175/1732.5		-30°C/Normal Voltage	0.00289	0.01680
	20175/1732.5		-20°C/Normal Voltage	0.00171	0.01895
	20175/1732.5		-10°C/Normal Voltage	-0.00178	0.01656
	20175/1732.5		0°C/Normal Voltage	0.00104	0.01567
	20175/1732.5		10°C/Normal Voltage	0.00405	0.01745
	20175/1732.5		20°C/Normal Voltage	0.00079	-0.01113
	20175/1732.5		30°C/Normal Voltage	0.00263	-0.04043
	20175/1732.5		40°C/Normal Voltage	0.00163	0.01960
	20175/1732.5		50°C/Normal Voltage	0.00363	-0.01194
	20175/1732.5		60°C/Normal Voltage	0.00250	0.01445
20175/1732.5	70°C/Normal Voltage		0.00177	0.01568	
20175/1732.5	80°C/Normal Voltage		0.00111	0.01119	
20175/1732.5	85°C/Normal Voltage		-0.00118	-0.00985	
20175/1732.5	20°C/Minimum Voltage		0.00096	0.01844	
20175/1732.5	20°C/Maximum Voltage	-0.00050	0.01889		
20MHz	20175/1732.5	-40°C/Normal Voltage	0.00367	-0.01856	
	20175/1732.5	-30°C/Normal Voltage	0.00462	-0.01567	
	20175/1732.5	-20°C/Normal Voltage	0.00343	0.01988	



	20175/1732.5	-10°C/Normal Voltage	-0.00005	0.01706
	20175/1732.5	0°C/Normal Voltage	0.00276	0.02005
	20175/1732.5	10°C/Normal Voltage	0.00578	0.02183
	20175/1732.5	20°C/Normal Voltage	0.00252	-0.00676
	20175/1732.5	30°C/Normal Voltage	0.00436	-0.03374
	20175/1732.5	40°C/Normal Voltage	0.00336	-0.02013
	20175/1732.5	50°C/Normal Voltage	0.00536	-0.00757
	20175/1732.5	60°C/Normal Voltage	0.00190	-0.00941
	20175/1732.5	70°C/Normal Voltage	-0.00441	0.01403
	20175/1732.5	80°C/Normal Voltage	0.00342	0.01982
	20175/1732.5	85°C/Normal Voltage	0.00054	0.01709
	20175/1732.5	20°C/Minimum Voltage	0.00268	0.02281
	20175/1732.5	20°C/Maximum Voltage	0.00054	0.02326

Mode	Bandwidth	Channel/ Frequency (MHz)	Test status	Frequency Stability (ppm)		
				QPSK	16QAM	
Band 12	1.4MHz	23095/707.5	-40°C/Normal Voltage	0.00155	-0.00290	
		23095/707.5	-30°C/Normal Voltage	-0.00052	-0.00055	
		23095/707.5	-20°C/Normal Voltage	0.00198	-0.00236	
		23095/707.5	-10°C/Normal Voltage	-0.00404	-0.00204	
		23095/707.5	0°C/Normal Voltage	-0.00117	-0.00222	
		23095/707.5	10°C/Normal Voltage	-0.00267	-0.00201	
		23095/707.5	20°C/Normal Voltage	-0.00168	-0.00384	
		23095/707.5	30°C/Normal Voltage	-0.00229	-0.00290	
		23095/707.5	40°C/Normal Voltage	-0.00188	-0.00062	
		23095/707.5	50°C/Normal Voltage	-0.00452	0.00020	
		23095/707.5	60°C/Normal Voltage	0.00379	-0.00492	
		23095/707.5	70°C/Normal Voltage	-0.00413	-0.00258	
		23095/707.5	80°C/Normal Voltage	-0.00140	-0.00038	
		23095/707.5	85°C/Normal Voltage	-0.00195	-0.00416	
		23095/707.5	20°C/Minimum Voltage	-0.00061	-0.00103	
		23095/707.5	20°C/Maximum Voltage	-0.00489	-0.00141	
		3MHz	23095/707.5	-40°C/Normal Voltage	0.00680	0.00691
			23095/707.5	-30°C/Normal Voltage	0.00287	0.00127
			23095/707.5	-20°C/Normal Voltage	0.00669	0.01245
			23095/707.5	-10°C/Normal Voltage	0.00408	0.00400
			23095/707.5	0°C/Normal Voltage	0.00155	0.00293
			23095/707.5	10°C/Normal Voltage	0.00643	0.00394
			23095/707.5	20°C/Normal Voltage	0.00161	0.01502
			23095/707.5	30°C/Normal Voltage	0.00188	0.00509
			23095/707.5	40°C/Normal Voltage	-0.00013	0.00835
			23095/707.5	50°C/Normal Voltage	0.00370	0.01484



		23095/707.5	60°C/Normal Voltage	-0.00278	-0.00369
		23095/707.5	70°C/Normal Voltage	-0.00194	-0.00274
		23095/707.5	80°C/Normal Voltage	0.00168	-0.00107
		23095/707.5	85°C/Normal Voltage	-0.00133	0.00023
		23095/707.5	20°C/Minimum Voltage	0.00424	0.00174
		23095/707.5	20°C/Maximum Voltage	0.00811	0.01213
	5MHz	23095/707.5	-40°C/Normal Voltage	0.00352	0.00563
		23095/707.5	-30°C/Normal Voltage	0.00141	0.00659
		23095/707.5	-20°C/Normal Voltage	0.00239	0.00261
		23095/707.5	-10°C/Normal Voltage	0.00184	0.00188
		23095/707.5	0°C/Normal Voltage	-0.00013	-0.00413
		23095/707.5	10°C/Normal Voltage	0.00057	-0.00249
		23095/707.5	20°C/Normal Voltage	0.00211	0.00431
		23095/707.5	30°C/Normal Voltage	0.00229	-0.00126
		23095/707.5	40°C/Normal Voltage	0.00133	-0.00216
		23095/707.5	50°C/Normal Voltage	-0.00254	-0.00396
		23095/707.5	60°C/Normal Voltage	-0.00451	-0.00293
		23095/707.5	70°C/Normal Voltage	0.00150	-0.00416
		23095/707.5	80°C/Normal Voltage	0.00290	-0.00274
		23095/707.5	85°C/Normal Voltage	-0.00373	-0.00406
	23095/707.5	20°C/Minimum Voltage	-0.00150	0.00393	
	23095/707.5	20°C/Maximum Voltage	0.00188	0.00273	
	10MHz	23095/707.5	-40°C/Normal Voltage	-0.00400	0.00090
		23095/707.5	-30°C/Normal Voltage	-0.00052	0.00155
		23095/707.5	-20°C/Normal Voltage	-0.00332	0.00295
		23095/707.5	-10°C/Normal Voltage	0.00098	0.00230
		23095/707.5	0°C/Normal Voltage	-0.00141	0.00445
		23095/707.5	10°C/Normal Voltage	-0.00088	-0.00072
		23095/707.5	20°C/Normal Voltage	0.00027	-0.00089
		23095/707.5	30°C/Normal Voltage	0.00131	-0.00030
23095/707.5		40°C/Normal Voltage	-0.00394	-0.00155	
23095/707.5		50°C/Normal Voltage	-0.00204	0.00095	
23095/707.5		60°C/Normal Voltage	-0.00030	-0.00686	
23095/707.5		70°C/Normal Voltage	0.00462	-0.00457	
23095/707.5		80°C/Normal Voltage	-0.00297	-0.00401	
23095/707.5		85°C/Normal Voltage	-0.00544	0.00462	
23095/707.5	20°C/Minimum Voltage	-0.00212	-0.00069		
23095/707.5	20°C/Maximum Voltage	0.00192	0.00206		

5.7 Spurious Emissions at Antenna Terminals

Ambient condition

Temperature	Relative humidity	Pressure
23°C ~25°C	45%~50%	101.5kPa

Method of Measurement

The EUT was connected to Spectrum Analyzer and Base Station Simulator via power Splitter. The measurement is carried out using a spectrum analyzer. The spectrum analyzer scans from 30MHz to the 10th harmonic of the carrier. The peak detector is used. Set RBW 1MHz and VBW 3MHz, Sweep is set to ATUO.

Test setup

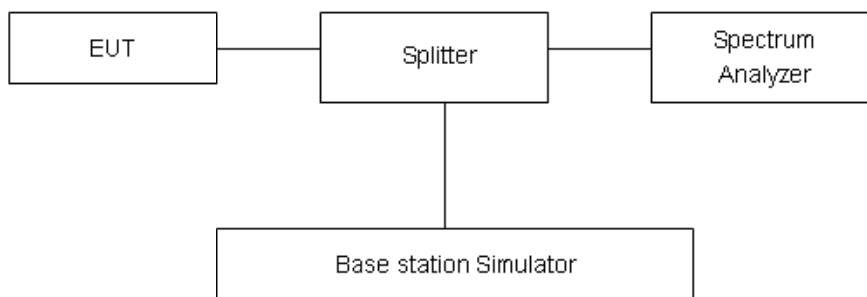

Limits

Rule Part 27.53(h) specifies that “for operations in the 1695-1710 MHz, 1710-1755 MHz, 1755-1780 MHz, 1915-1920 MHz, 1995-2000 MHz, 2000-2020 MHz, 2110-2155 MHz, 2155-2180 MHz, and 2180-2200 bands, the power of any emission outside a licensee's frequency block shall be attenuated below the transmitter power (P) in watts by at least $43 + 10 \log_{10}(P)$ dB..”

Rule Part 27.53 (g) For operations in the 600 MHz band and the 698-746 MHz band, the power of any emission outside a licensee's frequency band(s) of operation shall be attenuated below the transmitter power (P) within the licensed band(s) of operation, measured in watts, by at least $43 + 10 \log(P)$ dB. Compliance with this provision is based on the use of measurement instrumentation employing a resolution bandwidth of 100 kilohertz or greater. However, in the 100 kilohertz bands immediately outside and adjacent to a licensee's frequency block, a resolution bandwidth of at least 30 kHz may be employed.

Limit	-13 dBm
-------	---------

Measurement Uncertainty

The assessed measurement uncertainty to ensure 99.75% confidence level for the normal distribution is with the coverage factor $k = 1.96$.

Frequency	Uncertainty
100kHz-2GHz	0.684 dB
2GHz-18Hz	1.407 dB

Test Result: PASS

If disturbances were found more than 20dB below limit line, the mark is not required for the EUT.
 The signal beyond the limit is carrier in the following plots.

Test Data File Name	Frequency (MHz)	Peak (dBm)	Limit (dBm)	Margin (dB)
LTE B12_CHMID_1.4M_RB1_0.03-8GHz	1767.8	-24.02	-13.00	11.02
LTE B12_CHHIGH_1.4M_RB1_0.03-8GHz	1431.5	-29.04	-13.00	16.04
LTE B12_CHLOW_3M_RB1_0.03-8GHz	1748.8	-28.12	-13.00	15.12
LTE B12_CHMID_3M_RB1_0.03-8GHz	1771.0	-30.31	-13.00	17.31
LTE B12_CHHIGH_3M_RB1_0.03-8GHz	2140.3	-26.87	-13.00	13.87
LTE B12_CHLOW_5M_RB1_0.03-8GHz	1750.5	-29.34	-13.00	16.34
LTE B12_CHMID_5M_RB1_0.03-8GHz	1772.0	-26.20	-13.00	13.20
LTE B12_CHHIGH_5M_RB1_0.03-8GHz	1788.8	-28.18	-13.00	15.18
LTE B12_CHLOW_10M_RB1_0.03-8GHz	1770.5	-26.93	-13.00	13.93
LTE B12_CHMID_10M_RB1_0.03-8GHz	1406.3	-28.21	-13.00	15.21



LTE Band 4 1.4MHz CH-Low 30MHz~3GHz

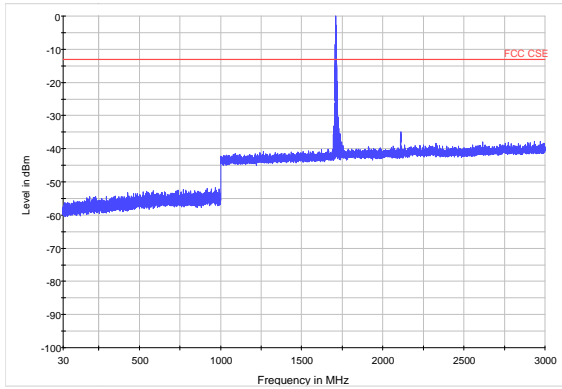

LTE Band 4 1.4MHz CH-Low 3GHz~18GHz

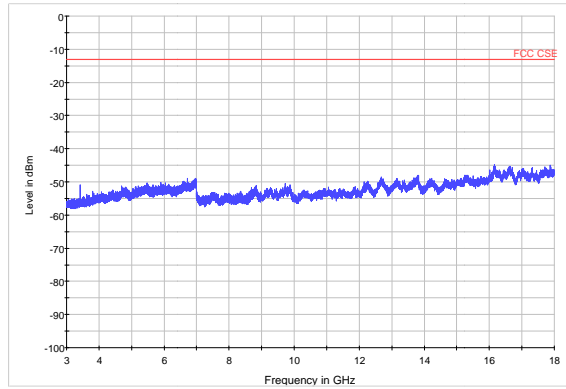

LTE Band 4 1.4MHz CH-Middle 30MHz~3GHz

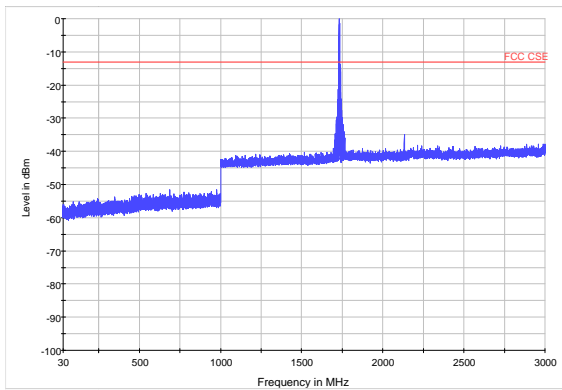

LTE Band 4 1.4MHz CH-Middle 3GHz~18GHz

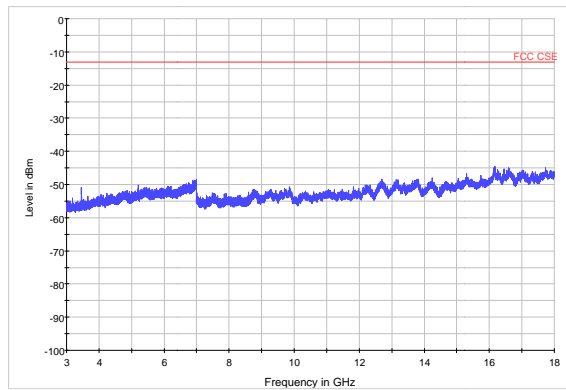

LTE Band 4 1.4MHz CH-High 30MHz~3GHz

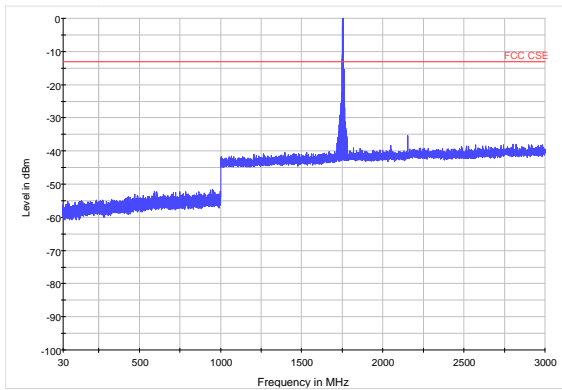

LTE Band 4 1.4MHz CH-High 3GHz~18GHz

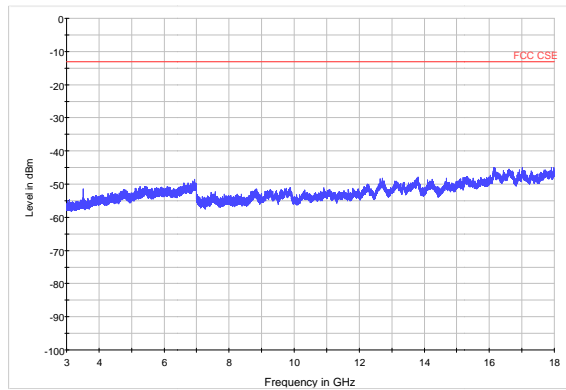



LTE Band 4 3MHz CH-Low 30MHz~3GHz

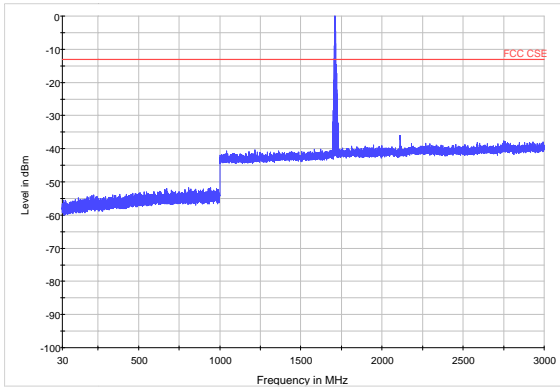

LTE Band 4 3MHz CH-Low 3GHz~18GHz

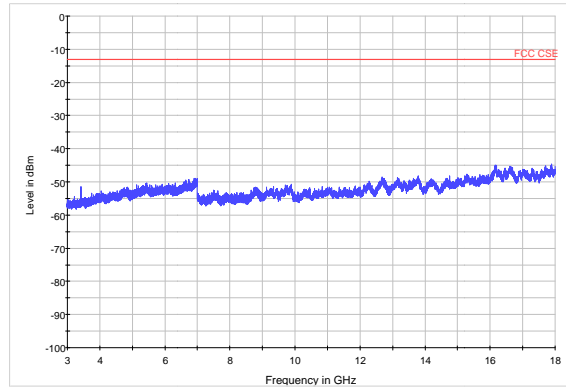

LTE Band 4 3MHz CH-Middle 30MHz~3GHz

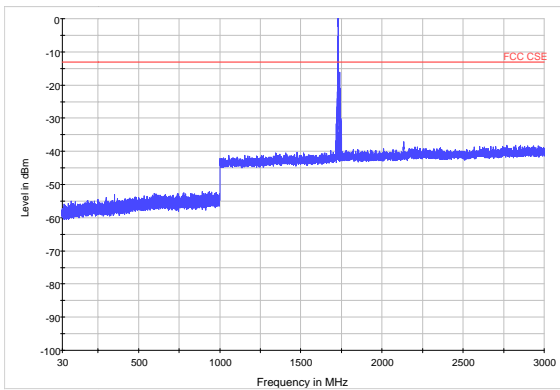

LTE Band 4 3MHz CH-Middle 3GHz~18GHz

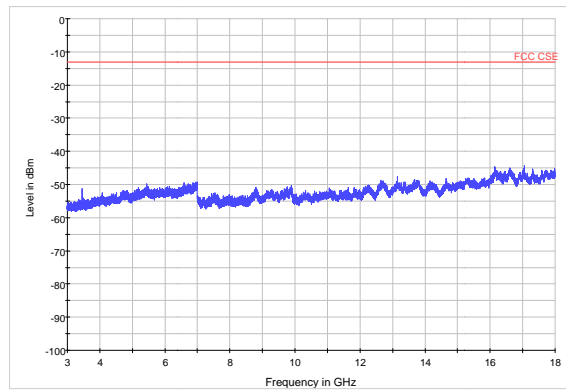

LTE Band 4 3MHz CH-High 30MHz~3GHz

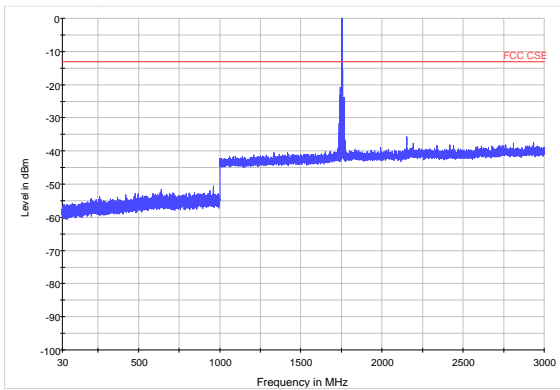

LTE Band 4 3MHz CH-High 3GHz~18GHz

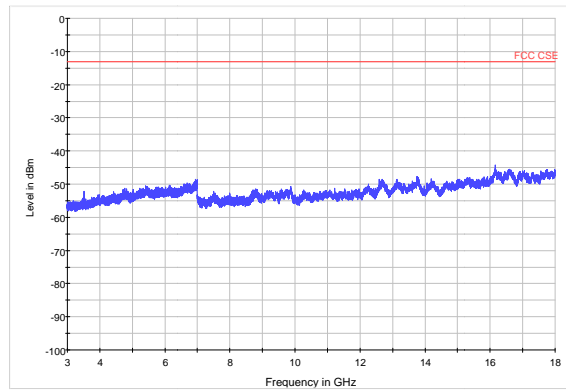



LTE Band 4 5MHz CH-Low 30MHz~3GHz

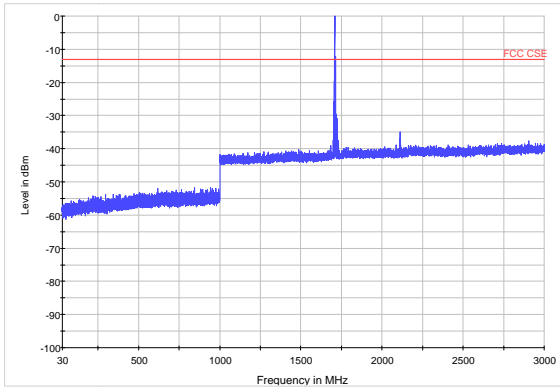

LTE Band 4 5MHz CH-Low 3GHz~18GHz

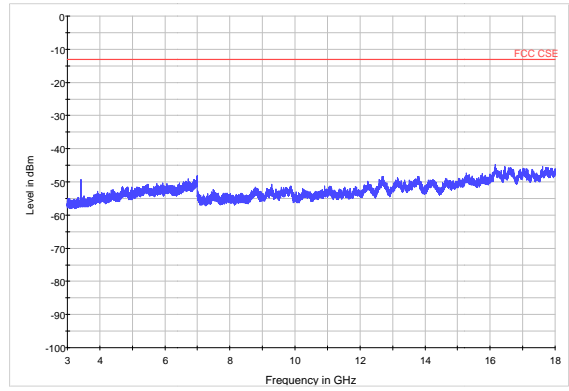

LTE Band 4 5MHz CH-Middle 30MHz~3GHz

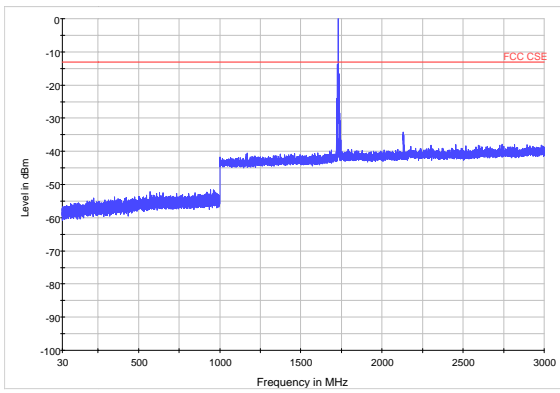

LTE Band 4 5MHz CH-Middle 3GHz~18GHz

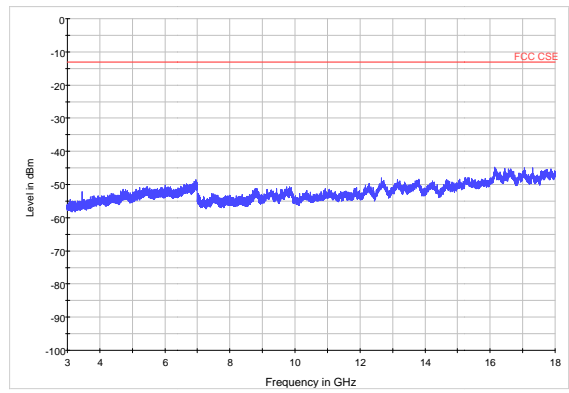

LTE Band 4 5MHz CH-High 30MHz~3GHz

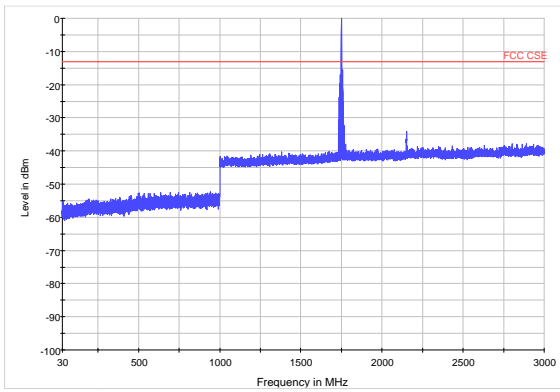

LTE Band 4 5MHz CH-High 3GHz~18GHz

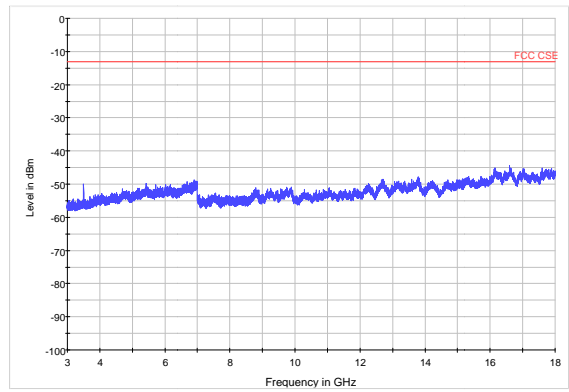



LTE Band 4 10MHz CH-Low 30MHz~3GHz

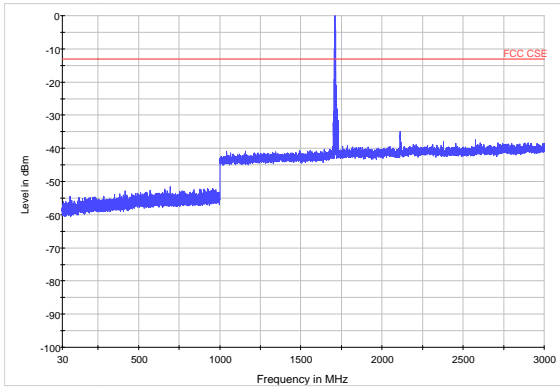

LTE Band 4 10MHz CH-Low 3GHz~18GHz

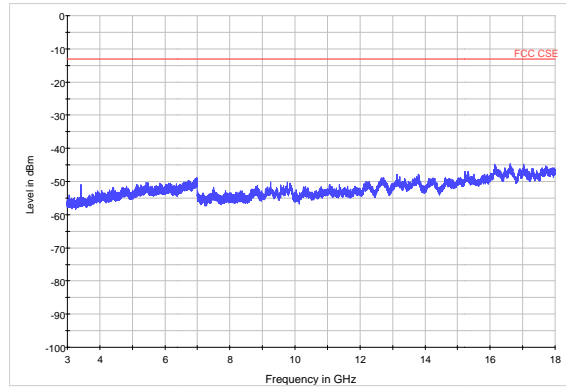

LTE Band 4 10MHz CH-Middle 30MHz~3GHz

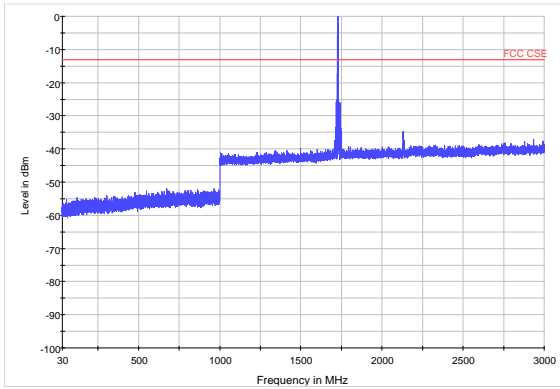

LTE Band 4 10MHz CH-Middle 3GHz~18GHz

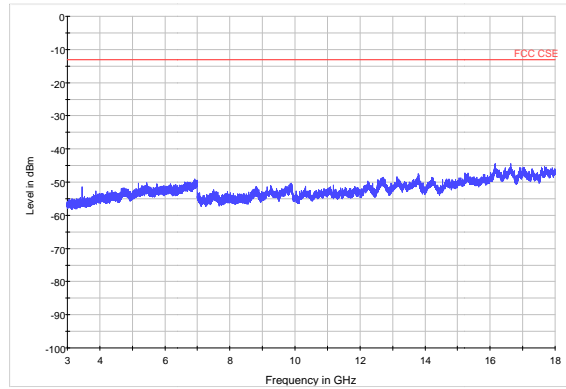

LTE Band 4 10MHz CH-High 30MHz~3GHz

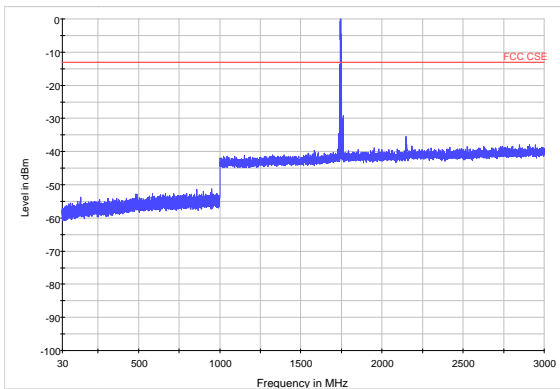

LTE Band 4 10MHz CH-High 3GHz~18GHz

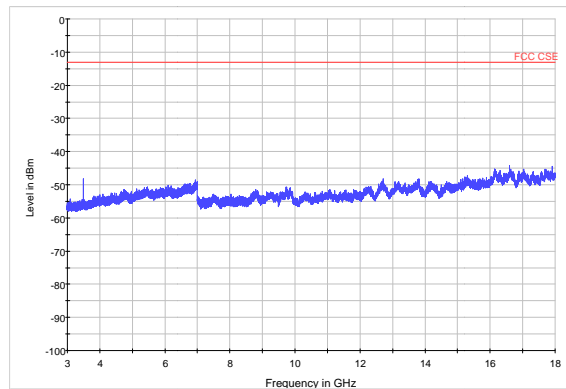



LTE Band 4 15MHz CH-Low 30MHz~3GHz

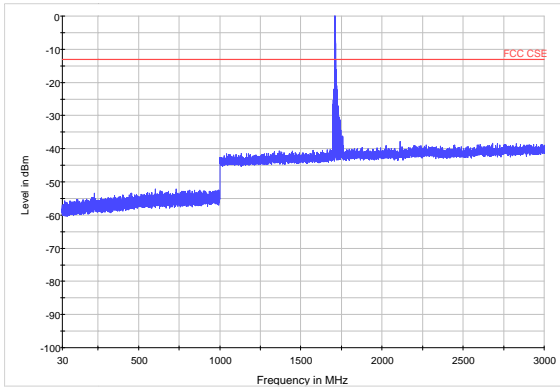

LTE Band 4 15MHz CH-Low 3GHz~18GHz

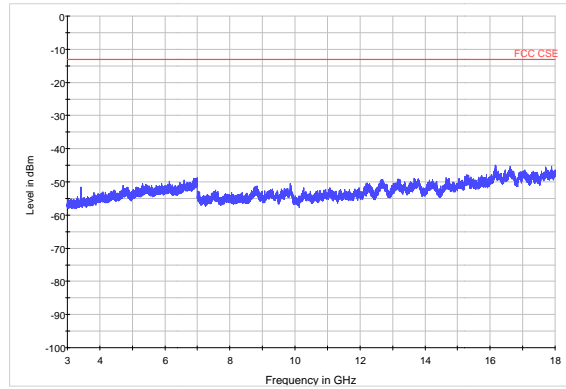

LTE Band 4 15MHz CH-Middle 30MHz~3GHz

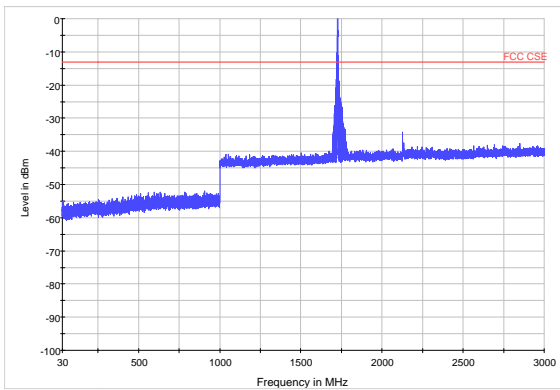

LTE Band 4 15MHz CH-Middle 3GHz~18GHz

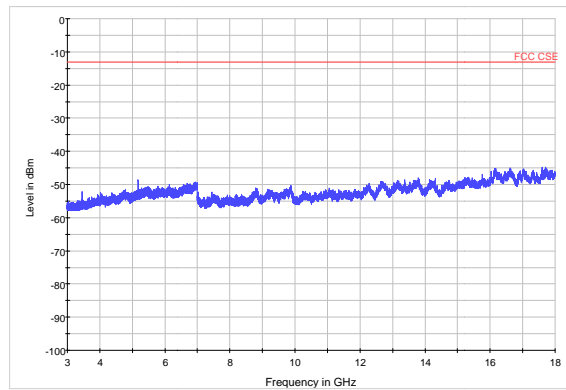

LTE Band 4 15MHz CH-High 30MHz~3GHz

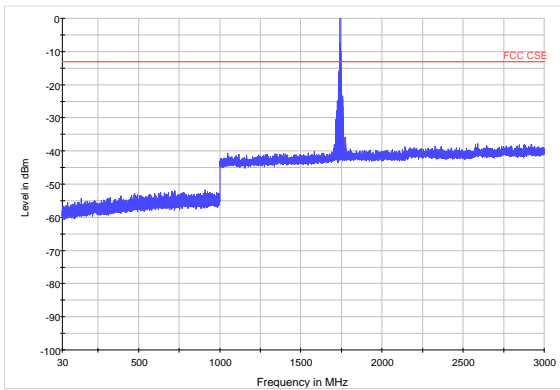

LTE Band 4 15MHz CH-High 3GHz~18GHz

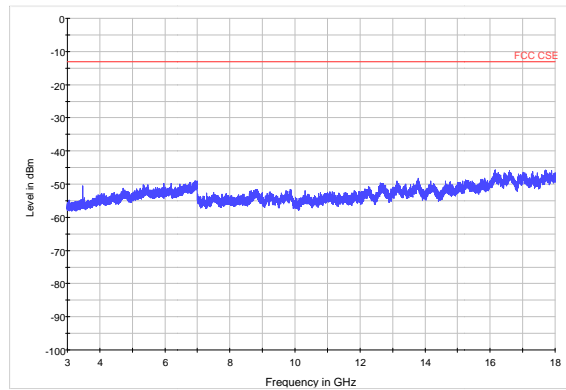



LTE Band 4 20MHz CH-Low 30MHz~3GHz

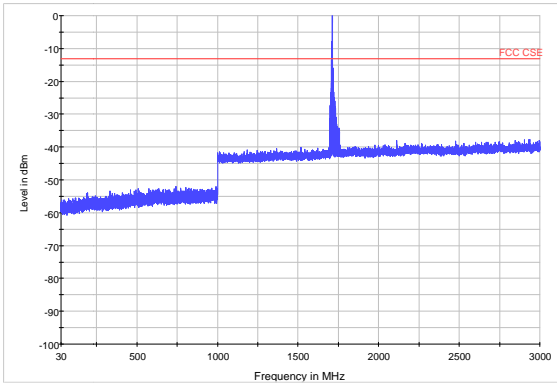

LTE Band 4 20MHz CH-Low 3GHz~18GHz

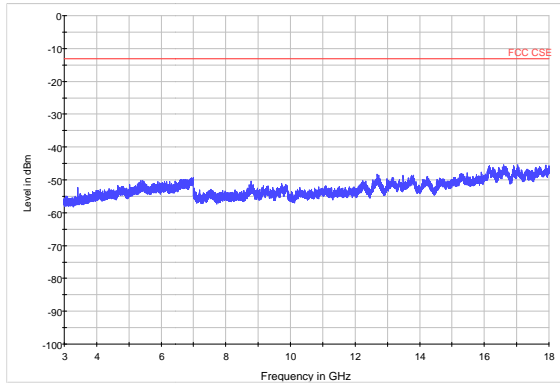

LTE Band 4 20MHz CH-Middle 30MHz~3GHz

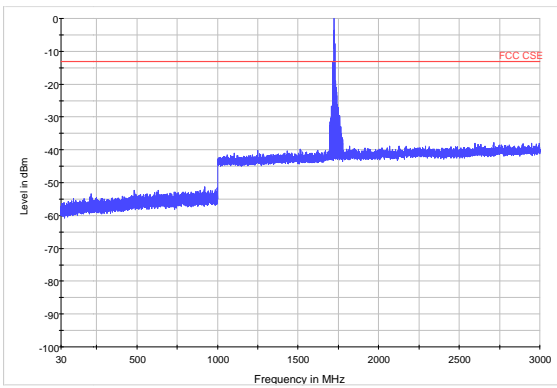

LTE Band 4 20MHz CH-Middle 3GHz~18GHz

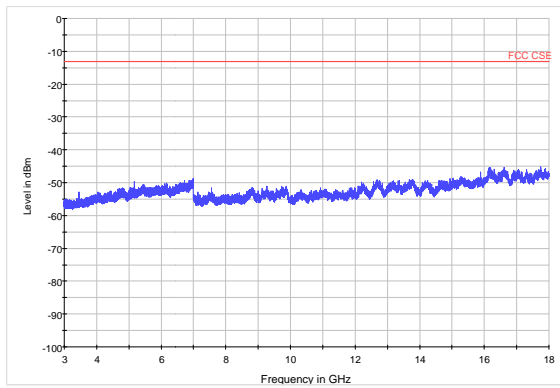

LTE Band 4 20MHz CH-High 30MHz~3GHz

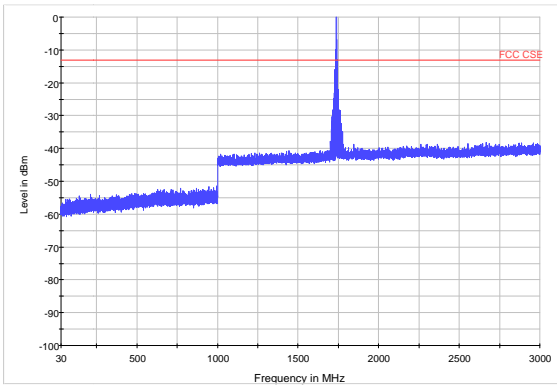

LTE Band 4 20MHz CH-High 3GHz~18GHz

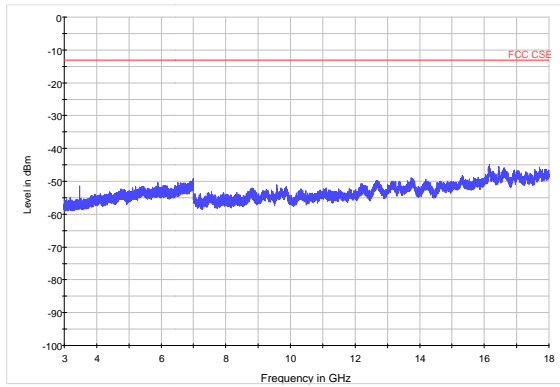

LTE Band 12 1.4MHz CH-Low 30MHz~8GHz

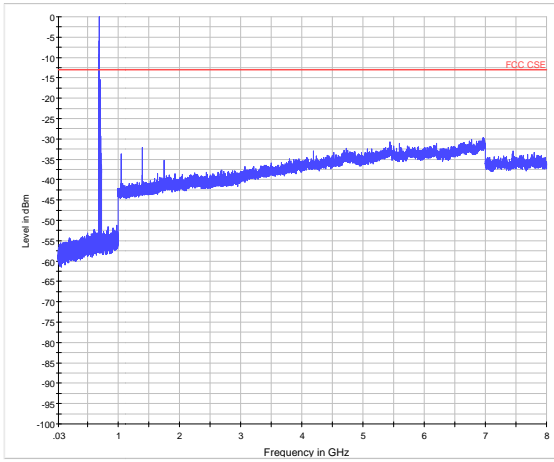

LTE Band 12 3MHz CH-Low 30MHz~8GHz

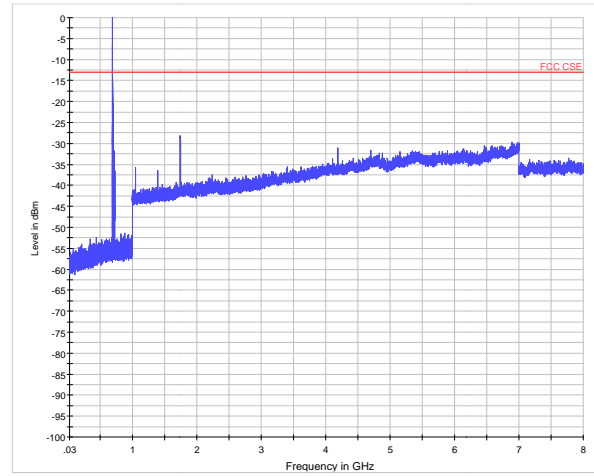

LTE Band 12 1.4MHz CH-Mid 30MHz~8GHz

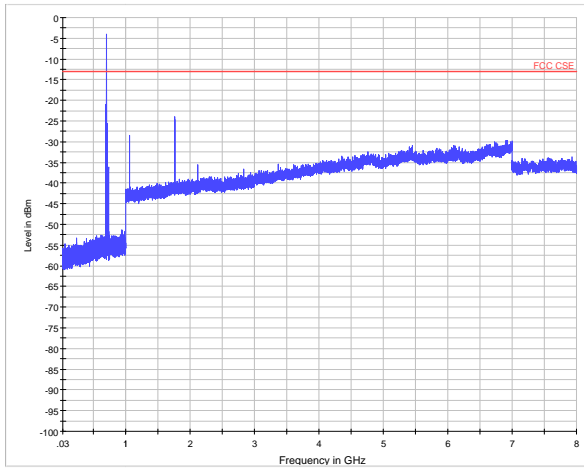

LTE Band 12 3MHz CH-Middle 30MHz~8GHz

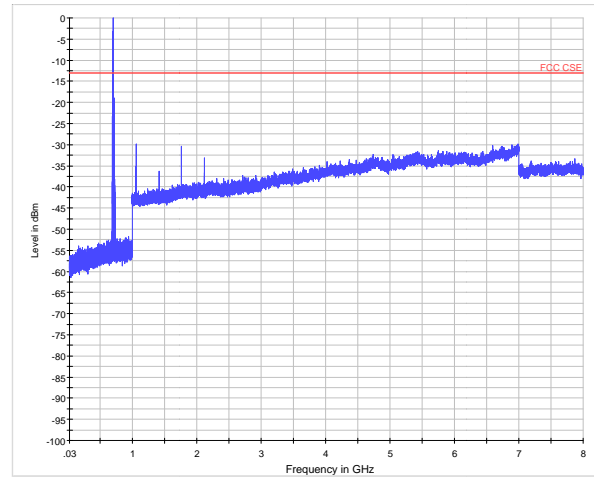

LTE Band 12 1.4MHz CH-High 30MHz~18GHz

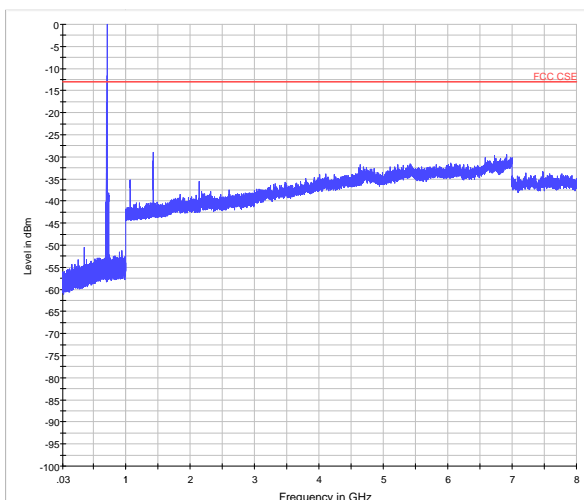

LTE Band 12 3MHz CH-High 30MHz~8GHz

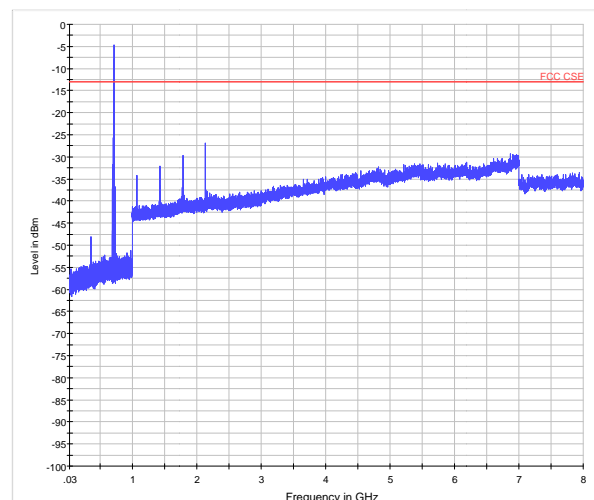



LTE Band 12 5MHz CH-Low 30MHz~8GHz

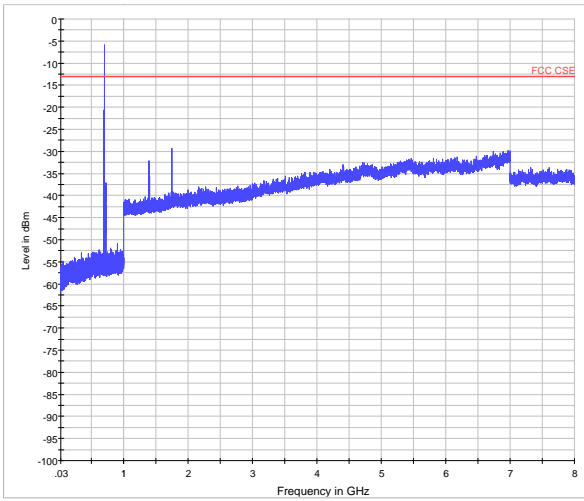

LTE Band 12 10MHz CH-Low 30MHz~8GHz

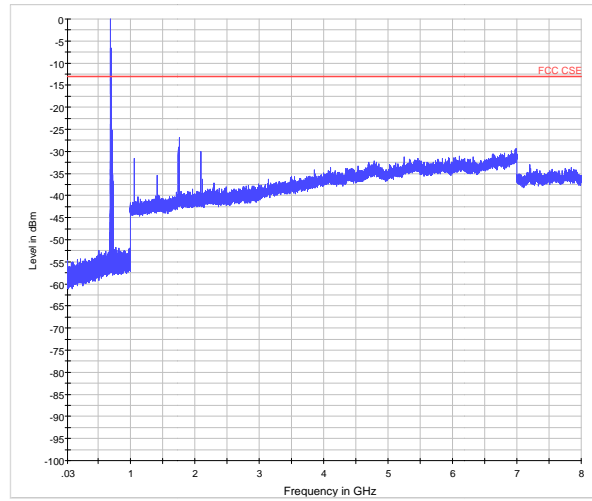

LTE Band 12 5MHz CH-Middle 30MHz~8GHz

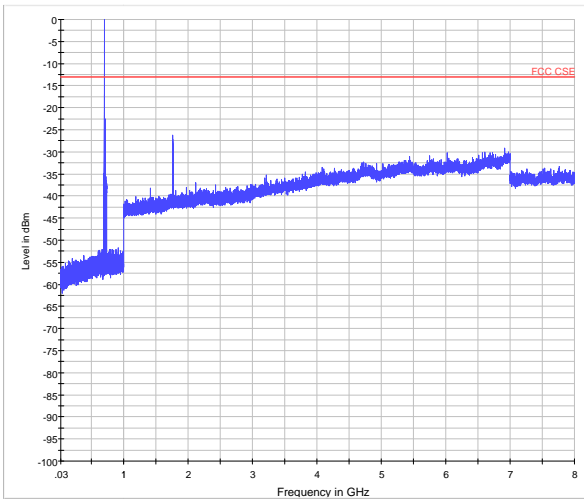

LTE Band 12 10MHz CH-Middle 30MHz~8GHz

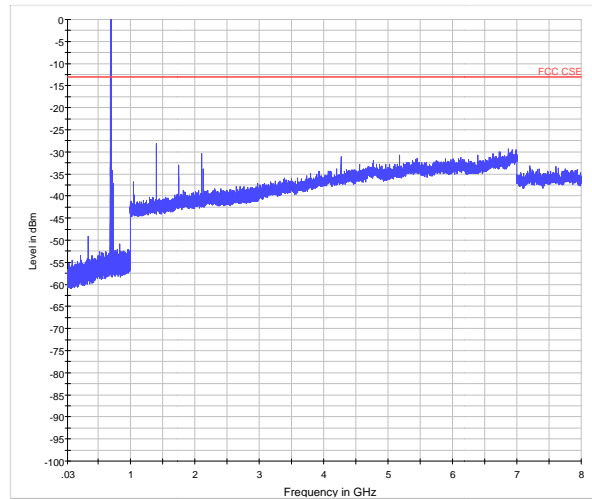

LTE Band 12 5MHz CH-High 30MHz~8GHz

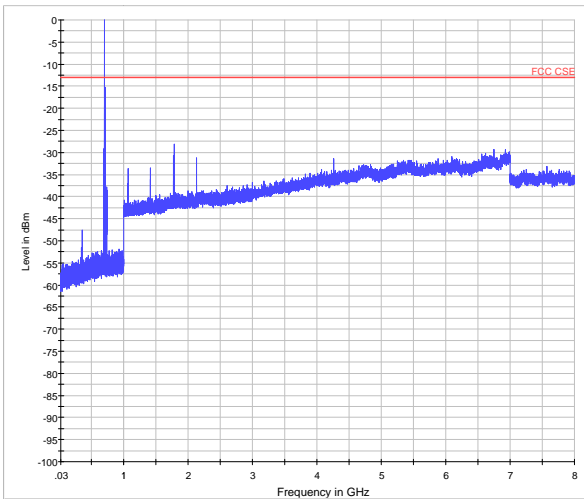

LTE Band 12 10MHz CH-High 30MHz~8GHz

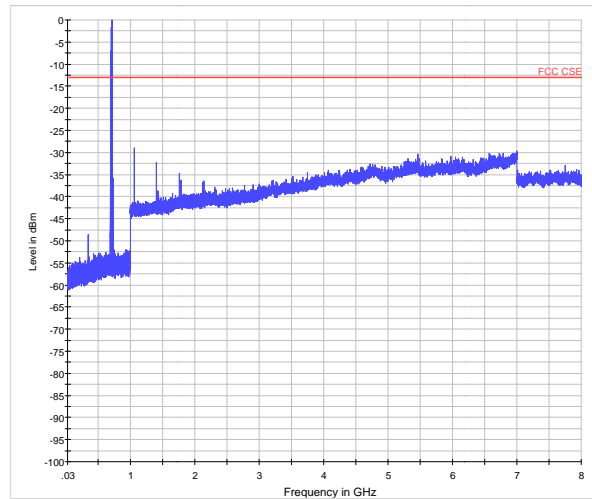

5.8 Radiates Spurious Emission

Ambient condition

Temperature	Relative humidity	Pressure
23°C ~25°C	45%~50%	101.5kPa

Method of Measurement

1. The testing follows FCC KDB 971168 v02r02 Section 5.8 and ANSI/TIA-603-D-2010.
2. The EUT is placed on a turntable 0.8 meters above the ground in the chamber, 3 meter away from the antenna. The maximal emission value is acquired by adjusting the antenna height, polarisation and turntable azimuth. Normally, the height range of antenna is 1 m to 4 m, the azimuth range of turntable is 0° to 360°, and the receive antenna has two polarizations Vertical (V) and Horizontal (H).
3. A log-periodic antenna or double-ridged waveguide horn antenna shall be substituted in place of the EUT. The log-periodic antenna will be driven by a signal generator and the level will be adjusted till the same power value on the spectrum analyzer or receiver. The level of the spurious emissions can be calculated through the level of the signal generator, cable loss, the gain of the substitution antenna and the reading of the spectrum analyzer or receiver.
4. The EUT is then put into continuously transmitting mode at its maximum power level during the test. Set Test Receiver or Spectrum RBW=1MHz, VBW=3MHz, And the maximum value of the receiver should be recorded as (Pr).
5. The EUT shall be replaced by a substitution antenna. In the chamber, an substitution antenna for the frequency band of interest is placed at the reference point of the chamber. An RF Signal source for the frequency band of interest is connected to the substitution antenna with a cable that has been constructed to not interfere with the radiation pattern of the antenna. A power (PMea) is applied to the input of the substitution antenna, and adjust the level of the signal generator output until the value of the receiver reach the previously recorded (Pr). The power of signal source (PMea) is recorded. The test should be performed by rotating the test item and adjusting the receiving antenna polarization.
6. A amplifier should be connected to the Signal Source output port. And the cable should be connect between the Amplifier and the Substitution Antenna. The cable loss (Pcl) ,the Substitution Antenna Gain (Ga) and the Amplifier Gain (PAg) should be recorded after test.
7. The measurement results are obtained as described below:

$$\text{Power(EIRP)} = \text{PMea} - \text{PAg} - \text{Pcl} + \text{Ga}$$
 The measurement results are amend as described below:

$$\text{Power(EIRP)} = \text{PMea} - \text{Pcl} + \text{Ga}$$
8. This value is EIRP since the measurement is calibrated using an antenna of known gain (2.15 dBi) and known input power. ERP can be calculated from EIRP by subtracting the gain of the dipole, ERP = EIRP-2.15dBi.

Test setup

30MHz~~~ 1GHz

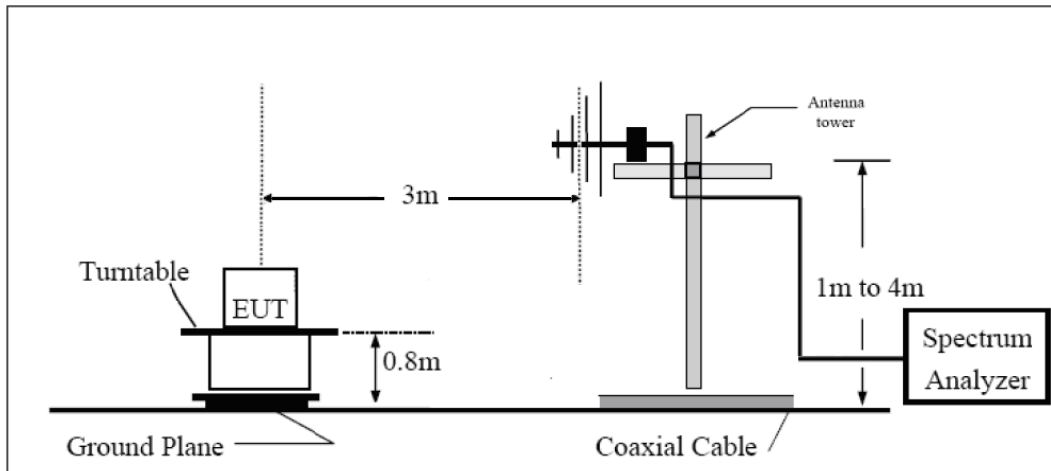

Above 1GHz

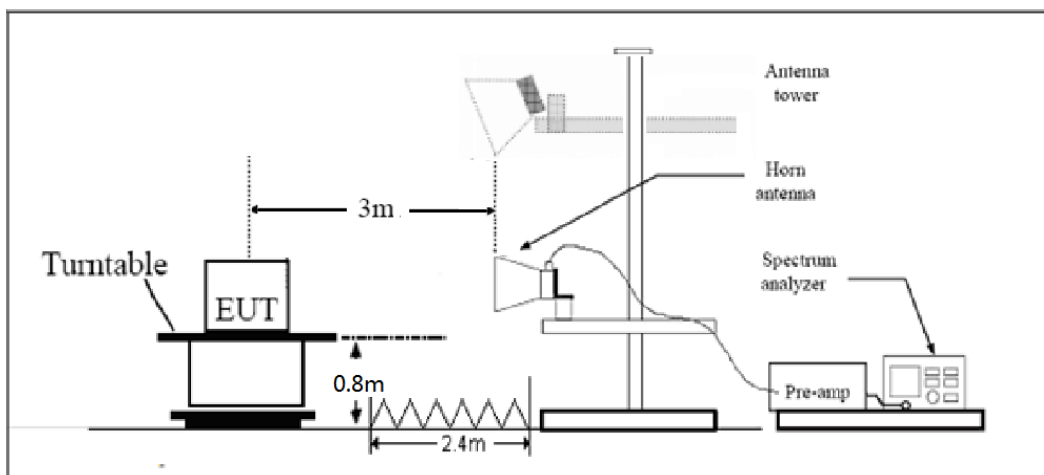

Note: Area side:2.4mX3.6m

The radiated emission was measured in the following position: EUT stand-up position (Z axis), lie-down position (X, Y axis). The worst emission was found in stand-up position (Z axis) and the worst case was recorded.

Limits

Rule Part 27.53(h) specifies that “for operations in the 1695-1710 MHz, 1710-1755 MHz, 1755-1780 MHz, 1915-1920 MHz, 1995-2000 MHz, 2000-2020 MHz, 2110-2155 MHz, 2155-2180 MHz, and 2180-2200 bands, the power of any emission outside a licensee's frequency block shall be attenuated below the transmitter power (P) in watts by at least $43 + 10 \log_{10} (P)$ dB..”

Rule Part 27.53 (g) For operations in the 600 MHz band and the 698-746 MHz band, the power of any emission outside a licensee's frequency band(s) of operation shall be attenuated below the transmitter power (P) within the licensed band(s) of operation, measured in watts, by at least $43 + 10 \log (P)$ dB. Compliance with this provision is based on the use of measurement instrumentation employing a resolution bandwidth of 100 kilohertz or greater. However, in the 100 kilohertz bands



immediately outside and adjacent to a licensee's frequency block, a resolution bandwidth of at least 30 kHz may be employed.

Limit	-13 dBm
-------	---------

Measurement Uncertainty

The assessed measurement uncertainty to ensure 95% confidence level for the normal distribution is with the coverage factor $k = \pm 1.96$, $U = \pm 3.55$ dB.

Test Result

LTE Band 4 QPSK 1.4MHz CH-Low, RB 1

Harmonic	Frequency (MHz)	SG (dBm)	Cable Loss (dB)	Gain (dBi)	Antenna Polarization	EIRP Level (dBm)	Limit (dBm)	Margin (dB)	Azimuth (deg)
2	3421.4	-53.65	2.6	10.15	Horizontal	-46.1	-13	33.1	90
3	5132.1	-54.35	2.4	11.35	Horizontal	-45.4	-13	32.4	135
4	6842.8	-50.25	4.5	10.85	Horizontal	-43.9	-13	30.9	225
5	8553.5	-46.85	5.1	11.35	Horizontal	-40.6	-13	27.6	270
6	10264.2	-44.85	5.3	11.95	Horizontal	-38.2	-13	25.2	180
7	11974.9	-45.15	5.5	13.55	Horizontal	-37.1	-13	24.1	45
8	13685.6	-43.35	6.3	13.75	Horizontal	-35.9	-13	22.9	135
9	15396.3	-44.55	6.7	13.85	Horizontal	-37.4	-13	24.4	225
10	17107.0	-42.35	6.8	14.25	Horizontal	-34.9	-13	21.9	90

- Note: 1.The other Spurious RF Radiated emissions level is no more than noise floor.
 2. The worst emission was found in the antenna is Horizontal position.

LTE Band 4 QPSK 1.4MHz CH-Middle, RB 1

Harmonic	Frequency (MHz)	SG (dBm)	Cable Loss (dB)	Gain (dBi)	Antenna Polarization	EIRP Level (dBm)	Limit (dBm)	Margin (dB)	Azimuth (deg)
2	3465.0	-57.25	2.6	10.75	Horizontal	-49.1	-13	36.1	135
3	5197.5	-54.65	2.4	11.05	Horizontal	-46.0	-13	33.0	90
4	6930.0	-47.95	4.5	11.15	Horizontal	-41.3	-13	28.3	135
5	8662.5	-46.35	5.1	11.35	Horizontal	-40.1	-13	27.1	225
6	10395.0	-45.45	5.3	11.95	Horizontal	-38.8	-13	25.8	270
7	12127.5	-45.85	5.5	13.55	Horizontal	-37.8	-13	24.8	180
8	13860.0	-43.35	6.3	13.75	Horizontal	-35.9	-13	22.9	45
9	15592.5	-43.65	6.7	13.85	Horizontal	-36.5	-13	23.5	135
10	17325.0	-42.95	6.8	14.25	Horizontal	-35.5	-13	22.5	225

- Note: 1.The other Spurious RF Radiated emissions level is no more than noise floor.
 2. The worst emission was found in the antenna is Horizontal position.

LTE Band 4 QPSK 1.4MHz CH-High, RB 1

Harmonic	Frequency (MHz)	SG (dBm)	Cable Loss (dB)	Gain (dBi)	Antenna Polarization	EIRP Level (dBm)	Limit (dBm)	Margin (dB)	Azimuth (deg)
2	3508.6	-50.45	2.6	10.15	Horizontal	-42.9	-13	29.9	90
3	5262.9	-54.75	2.4	11.05	Horizontal	-46.1	-13	33.1	45
4	7017.2	-49.35	4.5	11.15	Horizontal	-42.7	-13	29.7	135
5	8771.5	-46.75	5.1	11.35	Horizontal	-40.5	-13	27.5	45
6	10525.8	-44.15	5.3	11.95	Horizontal	-37.5	-13	24.5	90
7	12280.1	-45.75	5.5	13.55	Horizontal	-37.7	-13	24.7	90
8	14034.4	-41.75	6.3	13.75	Horizontal	-34.3	-13	21.3	135
9	15788.7	-43.95	6.7	13.85	Horizontal	-36.8	-13	23.8	225
10	17543.0	-41.55	6.8	14.25	Horizontal	-34.1	-13	21.1	270

Note: 1.The other Spurious RF Radiated emissions level is no more than noise floor.

2. The worst emission was found in the antenna is Horizontal position.

LTE Band 4 QPSK 3MHz CH-Low, RB 1

Harmonic	Frequency (MHz)	SG (dBm)	Cable Loss (dB)	Gain (dBi)	Antenna Polarization	EIRP Level (dBm)	Limit (dBm)	Margin (dB)	Azimuth (deg)
2	3420.0	-52.15	2.6	10.15	Horizontal	-44.6	-13	31.6	180
3	5131.1	-54.55	2.4	11.35	Horizontal	-45.6	-13	32.6	45
4	6846.0	-50.05	4.5	10.85	Horizontal	-43.7	-13	30.7	135
5	8557.5	-46.65	5.1	11.35	Horizontal	-40.4	-13	27.4	225
6	10269.0	-45.35	5.3	11.95	Horizontal	-38.7	-13	25.7	90
7	11980.5	-45.45	5.5	13.55	Horizontal	-37.4	-13	24.4	90
8	13692.0	-43.15	6.3	13.75	Horizontal	-35.7	-13	22.7	45
9	15403.5	-44.55	6.7	13.85	Horizontal	-37.4	-13	24.4	90
10	17115.0	-42.35	6.8	14.25	Horizontal	-34.9	-13	21.9	135

Note: 1.The other Spurious RF Radiated emissions level is no more than noise floor.

2. The worst emission was found in the antenna is Horizontal position.

LTE Band 4 QPSK 3MHz CH-Middle, RB 1

Harmonic	Frequency (MHz)	SG (dBm)	Cable Loss (dB)	Gain (dBi)	Antenna Polarization	EIRP Level (dBm)	Limit (dBm)	Margin (dB)	Azimuth (deg)
2	3462.4	-55.05	2.6	10.75	Horizontal	-46.9	-13	33.9	225
3	5193.8	-54.65	2.4	11.05	Horizontal	-46.0	-13	33.0	270
4	6930.0	-48.05	4.5	11.15	Horizontal	-41.4	-13	28.4	180
5	8662.5	-46.95	5.1	11.35	Horizontal	-40.7	-13	27.7	45
6	10395.0	-44.65	5.3	11.95	Horizontal	-38.0	-13	25.0	135
7	12127.5	-45.25	5.5	13.55	Horizontal	-37.2	-13	24.2	225
8	13860.0	-42.35	6.3	13.75	Horizontal	-34.9	-13	21.9	90
9	15592.5	-44.65	6.7	13.85	Horizontal	-37.5	-13	24.5	225
10	17325.0	-42.75	6.8	14.25	Horizontal	-35.3	-13	22.3	0

Note: 1.The other Spurious RF Radiated emissions level is no more than noise floor.

2. The worst emission was found in the antenna is Horizontal position.

LTE Band 4 QPSK 3MHz CH-High, RB 1

Harmonic	Frequency (MHz)	SG (dBm)	Cable Loss (dB)	Gain (dBi)	Antenna Polarization	EIRP Level (dBm)	Limit (dBm)	Margin (dB)	Azimuth (deg)
2	3505.1	-52.35	2.6	10.15	Horizontal	-44.8	-13	31.8	135
3	5256.8	-53.75	2.4	11.05	Horizontal	-45.1	-13	32.1	90
4	7014.0	-49.35	4.5	11.15	Horizontal	-42.7	-13	29.7	135
5	8767.5	-47.75	5.1	11.35	Horizontal	-41.5	-13	28.5	225
6	10521.0	-45.15	5.3	11.95	Horizontal	-38.5	-13	25.5	270
7	12274.5	-45.75	5.5	13.55	Horizontal	-37.7	-13	24.7	180
8	14028.0	-42.35	6.3	13.75	Horizontal	-34.9	-13	21.9	45
9	15781.5	-43.95	6.7	13.85	Horizontal	-36.8	-13	23.8	135
10	17535.0	-41.85	6.8	14.25	Horizontal	-34.4	-13	21.4	225

Note: 1.The other Spurious RF Radiated emissions level is no more than noise floor.

2. The worst emission was found in the antenna is Horizontal position.

LTE Band 4 QPSK 5MHz CH-Low, RB 1

Harmonic	Frequency (MHz)	SG (dBm)	Cable Loss (dB)	Gain (dBi)	Antenna Polarization	EIRP Level (dBm)	Limit (dBm)	Margin (dB)	Azimuth (deg)
2	3420.4	-53.95	2.6	10.15	Horizontal	-46.4	-13	33.4	90
3	5131.1	-54.55	2.4	11.35	Horizontal	-45.6	-13	32.6	180
4	6850.0	-51.05	4.5	10.85	Horizontal	-44.7	-13	31.7	90
5	8562.5	-47.65	5.1	11.35	Horizontal	-41.4	-13	28.4	135
6	10275.0	-45.35	5.3	11.95	Horizontal	-38.7	-13	25.7	225
7	11987.5	-45.45	5.5	13.55	Horizontal	-37.4	-13	24.4	270
8	13700.0	-44.15	6.3	13.75	Horizontal	-36.7	-13	23.7	180
9	15412.5	-44.55	6.7	13.85	Horizontal	-37.4	-13	24.4	45
10	17125.0	-42.35	6.8	14.25	Horizontal	-34.9	-13	21.9	135

Note: 1.The other Spurious RF Radiated emissions level is no more than noise floor.

2. The worst emission was found in the antenna is Horizontal position.

LTE Band 4 QPSK 5MHz CH-Middle, RB 1

Harmonic	Frequency (MHz)	SG (dBm)	Cable Loss (dB)	Gain (dBi)	Antenna Polarization	EIRP Level (dBm)	Limit (dBm)	Margin (dB)	Azimuth (deg)
2	3465.0	-54.75	2.6	10.75	Horizontal	-46.6	-13	33.6	225
3	5190.8	-54.85	2.4	11.05	Horizontal	-46.2	-13	33.2	90
4	6930.0	-47.95	4.5	11.15	Horizontal	-41.3	-13	28.3	135
5	8662.5	-46.35	5.1	11.35	Horizontal	-40.1	-13	27.1	225
6	10395.0	-44.95	5.3	11.95	Horizontal	-38.3	-13	25.3	90
7	12127.5	-45.95	5.5	13.55	Horizontal	-37.9	-13	24.9	135
8	13860.0	-42.95	6.3	13.75	Horizontal	-35.5	-13	22.5	225
9	15592.5	-43.95	6.7	13.85	Horizontal	-36.8	-13	23.8	270
10	17325.0	-41.85	6.8	14.25	Horizontal	-34.4	-13	21.4	180

Note: 1.The other Spurious RF Radiated emissions level is no more than noise floor.

2. The worst emission was found in the antenna is Horizontal position.

LTE Band 4 QPSK 5MHz CH-High, RB 1

Harmonic	Frequency (MHz)	SG (dBm)	Cable Loss (dB)	Gain (dBi)	Antenna Polarization	EIRP Level (dBm)	Limit (dBm)	Margin (dB)	Azimuth (deg)
2	3500.3	-50.25	2.6	10.15	Horizontal	-42.7	-13	29.7	45
3	5251.1	-54.55	2.4	11.05	Horizontal	-45.9	-13	32.9	135
4	7010.0	-48.95	4.5	11.15	Horizontal	-42.3	-13	29.3	225
5	8762.5	-47.65	5.1	11.35	Horizontal	-41.4	-13	28.4	90
6	10515.0	-44.75	5.3	11.95	Horizontal	-38.1	-13	25.1	270
7	12267.5	-46.15	5.5	13.55	Horizontal	-38.1	-13	25.1	225
8	14020.0	-42.65	6.3	13.75	Horizontal	-35.2	-13	22.2	135
9	15772.5	-43.35	6.7	13.85	Horizontal	-36.2	-13	23.2	90
10	17525.0	-41.55	6.8	14.25	Horizontal	-34.1	-13	21.1	135

Note: 1.The other Spurious RF Radiated emissions level is no more than noise floor.

2. The worst emission was found in the antenna is Horizontal position.

LTE Band 4 QPSK 10MHz CH-Low, RB 1

Harmonic	Frequency (MHz)	SG (dBm)	Cable Loss (dB)	Gain (dBi)	Antenna Polarization	EIRP Level (dBm)	Limit (dBm)	Margin (dB)	Azimuth (deg)
2	3421.1	-52.45	2.6	10.15	Horizontal	-44.9	-13	31.9	225
3	5131.9	-53.75	2.4	11.35	Horizontal	-44.8	-13	31.8	270
4	6860.0	-47.95	4.5	10.85	Horizontal	-41.6	-13	28.6	180
5	8575.0	-47.35	5.1	11.35	Horizontal	-41.1	-13	28.1	45
6	10290.0	-45.55	5.3	11.95	Horizontal	-38.9	-13	25.9	135
7	12005.0	-45.95	5.5	13.55	Horizontal	-37.9	-13	24.9	225
8	13720.0	-41.95	6.3	13.75	Horizontal	-34.5	-13	21.5	90
9	15435.0	-44.95	6.7	13.85	Horizontal	-37.8	-13	24.8	90
10	17150.0	-42.75	6.8	14.25	Horizontal	-35.3	-13	22.3	90

Note: 1.The other Spurious RF Radiated emissions level is no more than noise floor.

2. The worst emission was found in the antenna is Horizontal position.

LTE Band 4 QPSK 10MHz CH-Middle, RB 1

Harmonic	Frequency (MHz)	SG (dBm)	Cable Loss (dB)	Gain (dBi)	Antenna Polarization	EIRP Level (dBm)	Limit (dBm)	Margin (dB)	Azimuth (deg)
2	3465.0	-53.05	2.6	10.75	Horizontal	-44.9	-13	31.9	135
3	5184.4	-54.25	2.4	11.05	Horizontal	-45.6	-13	32.6	225
4	6930.0	-47.95	4.5	11.15	Horizontal	-41.3	-13	28.3	270
5	8662.5	-46.45	5.1	11.35	Horizontal	-40.2	-13	27.2	180
6	10395.0	-45.65	5.3	11.95	Horizontal	-39.0	-13	26.0	45
7	12127.5	-45.95	5.5	13.55	Horizontal	-37.9	-13	24.9	135
8	13860.0	-41.95	6.3	13.75	Horizontal	-34.5	-13	21.5	225
9	15592.5	-44.95	6.7	13.85	Horizontal	-37.8	-13	24.8	90
10	17325.0	-42.75	6.8	14.25	Horizontal	-35.3	-13	22.3	135

Note: 1.The other Spurious RF Radiated emissions level is no more than noise floor.
2. The worst emission was found in the antenna is Horizontal position.

LTE Band 4 QPSK 10MHz CH-High, RB 1

Harmonic	Frequency (MHz)	SG (dBm)	Cable Loss (dB)	Gain (dBi)	Antenna Polarization	EIRP Level (dBm)	Limit (dBm)	Margin (dB)	Azimuth (deg)
2	3491.6	-49.75	2.6	10.15	Horizontal	-42.2	-13	29.2	225
3	5236.5	-53.65	2.4	11.05	Horizontal	-45.0	-13	32.0	315
4	7000.0	-48.65	4.5	11.15	Horizontal	-42.0	-13	29.0	270
5	8750.0	-47.35	5.1	11.35	Horizontal	-41.1	-13	28.1	225
6	10500.0	-46.75	5.3	11.95	Horizontal	-40.1	-13	27.1	135
7	12250.0	-45.45	5.5	13.55	Horizontal	-37.4	-13	24.4	90
8	14000.0	-42.05	6.3	13.75	Horizontal	-34.6	-13	21.6	135
9	15750.0	-45.15	6.7	13.85	Horizontal	-38.0	-13	25.0	225
10	17500.0	-42.85	6.8	14.25	Horizontal	-35.4	-13	22.4	270

Note: 1.The other Spurious RF Radiated emissions level is no more than noise floor.
2. The worst emission was found in the antenna is Horizontal position.

LTE Band 4 QPSK 15MHz CH Low, RB 1

Harmonic	Frequency (MHz)	SG (dBm)	Cable Loss (dB)	Gain (dBi)	Antenna Polarization	EIRP Level (dBm)	Limit (dBm)	Margin (dB)	Azimuth (deg)
2	3421.9	-51.55	2.6	10.15	Horizontal	-44.0	-13	31.0	180
3	5132.6	-55.05	2.4	11.35	Horizontal	-46.1	-13	33.1	45
4	6870.0	-47.45	4.5	10.85	Horizontal	-41.1	-13	28.1	135
5	8587.5	-46.55	5.1	11.35	Horizontal	-40.3	-13	27.3	225
6	10305.0	-45.65	5.3	11.95	Horizontal	-39.0	-13	26.0	90
7	12022.5	-44.95	5.5	13.55	Horizontal	-36.9	-13	23.9	180
8	13740.0	-41.55	6.3	13.75	Horizontal	-34.1	-13	21.1	90
9	15457.5	-44.15	6.7	13.85	Horizontal	-37.0	-13	24.0	135
10	17175.0	-43.15	6.8	14.25	Horizontal	-35.7	-13	22.7	225

Note: 1.The other Spurious RF Radiated emissions level is no more than noise floor.

2. The worst emission was found in the antenna is Horizontal position.

LTE Band 4 QPSK 15MHz CH-Middle, RB 1

Harmonic	Frequency (MHz)	SG (dBm)	Cable Loss (dB)	Gain (dBi)	Antenna Polarization	EIRP Level (dBm)	Limit (dBm)	Margin (dB)	Azimuth (deg)
2	3465.0	-57.45	2.6	10.75	Horizontal	-49.3	-13	36.3	270
3	5177.6	-54.45	2.4	11.05	Horizontal	-45.8	-13	32.8	180
4	6930.0	-48.95	4.5	11.15	Horizontal	-42.3	-13	29.3	45
5	8662.5	-47.15	5.1	11.35	Horizontal	-40.9	-13	27.9	135
6	10395.0	-44.95	5.3	11.95	Horizontal	-38.3	-13	25.3	225
7	12127.5	-45.75	5.5	13.55	Horizontal	-37.7	-13	24.7	90
8	13860.0	-42.85	6.3	13.75	Horizontal	-35.4	-13	22.4	135
9	15592.5	-43.65	6.7	13.85	Horizontal	-36.5	-13	23.5	225
10	17325.0	-43.05	6.8	14.25	Horizontal	-35.6	-13	22.6	315

Note: 1.The other Spurious RF Radiated emissions level is no more than noise floor.

2. The worst emission was found in the antenna is Horizontal position.

LTE Band 4 QPSK 15MHz CH-High, RB 1

Harmonic	Frequency (MHz)	SG (dBm)	Cable Loss (dB)	Gain (dBi)	Antenna Polarization	EIRP Level (dBm)	Limit (dBm)	Margin (dB)	Azimuth (deg)
2	3481.9	-50.85	2.6	10.15	Horizontal	-43.3	-13	30.3	90
3	5222.6	-54.65	2.4	11.05	Horizontal	-46.0	-13	33.0	135
4	6990.0	-49.75	4.5	11.15	Horizontal	-43.1	-13	30.1	225
5	8737.5	-46.25	5.1	11.35	Horizontal	-40.0	-13	27.0	270
6	10485.0	-45.25	5.3	11.95	Horizontal	-38.6	-13	25.6	180
7	12232.5	-45.45	5.5	13.55	Horizontal	-37.4	-13	24.4	45
8	13980.0	-43.05	6.3	13.75	Horizontal	-35.6	-13	22.6	135
9	15727.5	-43.15	6.7	13.85	Horizontal	-36.0	-13	23.0	225
10	17475.0	-42.85	6.8	14.25	Horizontal	-35.4	-13	22.4	90

Note: 1.The other Spurious RF Radiated emissions level is no more than noise floor.

2. The worst emission was found in the antenna is Horizontal position.

LTE Band 4 QPSK 20MHz CH-Low, RB 1

Harmonic	Frequency (MHz)	SG (dBm)	Cable Loss (dB)	Gain (dBi)	Antenna Polarization	EIRP Level (dBm)	Limit (dBm)	Margin (dB)	Azimuth (deg)
2	3423.0	-52.75	2.6	10.15	Horizontal	-45.2	-13	32.2	135
3	5133.4	-53.85	2.4	11.35	Horizontal	-44.9	-13	31.9	90
4	6880.0	-49.95	4.5	10.85	Horizontal	-43.6	-13	30.6	135
5	8600.0	-46.45	5.1	11.35	Horizontal	-40.2	-13	27.2	225
6	10320.0	-44.85	5.3	11.95	Horizontal	-38.2	-13	25.2	270
7	12040.0	-45.35	5.5	13.55	Horizontal	-37.3	-13	24.3	180
8	13760.0	-43.45	6.3	13.75	Horizontal	-36.0	-13	23.0	45
9	15480.0	-42.35	6.7	13.85	Horizontal	-35.2	-13	22.2	135
10	17200.0	-42.25	6.8	14.25	Horizontal	-34.8	-13	21.8	225

Note: 1.The other Spurious RF Radiated emissions level is no more than noise floor.

2. The worst emission was found in the antenna is Horizontal position.

LTE Band 4 QPSK 20MHz CH-Middle, RB 1

Harmonic	Frequency (MHz)	SG (dBm)	Cable Loss (dB)	Gain (dBi)	Antenna Polarization	EIRP Level (dBm)	Limit (dBm)	Margin (dB)	Azimuth (deg)
2	3465.0	-51.35	2.6	10.75	Horizontal	-43.2	-13	30.2	90
3	5170.5	-52.05	2.4	11.05	Horizontal	-43.4	-13	30.4	270
4	6930.0	-47.15	4.5	11.15	Horizontal	-40.5	-13	27.5	225
5	8662.5	-47.15	5.1	11.35	Horizontal	-40.9	-13	27.9	90
6	10395.0	-45.05	5.3	11.95	Horizontal	-38.4	-13	25.4	135
7	12127.5	-45.55	5.5	13.55	Horizontal	-37.5	-13	24.5	225
8	13860.0	-42.85	6.3	13.75	Horizontal	-35.4	-13	22.4	270
9	15592.5	-44.05	6.7	13.85	Horizontal	-36.9	-13	23.9	180
10	17325.0	-41.95	6.8	14.25	Horizontal	-34.5	-13	21.5	45

Note: 1.The other Spurious RF Radiated emissions level is no more than noise floor.

2. The worst emission was found in the antenna is Horizontal position.

LTE Band 4 QPSK 20MHz CH-High, RB 1

Harmonic	Frequency (MHz)	SG (dBm)	Cable Loss (dB)	Gain (dBi)	Antenna Polarization	EIRP Level (dBm)	Limit (dBm)	Margin (dB)	Azimuth (deg)
2	3472.5	-53.05	2.6	10.15	Horizontal	-45.5	-13	32.5	135
3	5208.4	-52.55	2.4	11.05	Horizontal	-43.9	-13	30.9	225
4	6980.0	-47.25	4.5	11.15	Horizontal	-40.6	-13	27.6	90
5	8725.0	-47.45	5.1	11.35	Horizontal	-41.2	-13	28.2	90
6	10470.0	-45.25	5.3	11.95	Horizontal	-38.6	-13	25.6	90
7	12215.0	-45.05	5.5	13.55	Horizontal	-37.0	-13	24.0	135
8	13960.0	-44.25	6.3	13.75	Horizontal	-36.8	-13	23.8	225
9	15705.0	-43.45	6.7	13.85	Horizontal	-36.3	-13	23.3	270
10	17450.0	-42.85	6.8	14.25	Horizontal	-35.4	-13	22.4	180

Note: 1.The other Spurious RF Radiated emissions level is no more than noise floor.

2. The worst emission was found in the antenna is Horizontal position.

LTE Band 12 QPSK 1.4MHz CH-Low, RB 1

Harmonic	Frequency (MHz)	SG (dBm)	Cable Loss (dB)	Gain (dBi)	Antenna Polarization	ERP Level (dBm)	Limit (dBm)	Margin (dB)	Azimuth (deg)
2	1398.5	-39.2	2.00	10.15	Horizontal	-33.2	-13	20.2	90
3	2097.5	-42	2.50	11.35	Horizontal	-35.3	-13	22.3	135
4	2797.0	-52.2	4.20	10.85	Horizontal	-47.7	-13	34.7	225
5	3498.5	-55.7	5.20	11.35	Horizontal	-51.7	-13	38.7	270
6	4198.2	-52.6	5.50	11.95	Horizontal	-48.3	-13	35.3	180
7	4897.9	-52.2	5.70	13.55	Horizontal	-46.5	-13	33.5	45
8	5597.6	-51.3	6.30	13.75	Horizontal	-46.0	-13	33.0	135
9	6297.3	-50.5	6.80	13.85	Horizontal	-45.6	-13	32.6	225
10	6997.0	-49.1	6.90	14.25	Horizontal	-43.9	-13	30.9	90

Note: 1.The other Spurious RF Radiated emissions level is no more than noise floor.
2. The worst emission was found in the antenna is Horizontal position.

LTE Band 12 QPSK 1.4MHz CH-Middle, RB 1

Harmonic	Frequency (MHz)	SG (dBm)	Cable Loss (dB)	Gain (dBi)	Antenna Polarization	ERP Level (dBm)	Limit (dBm)	Margin (dB)	Azimuth (deg)
2	1414.0	-44.3	2.00	10.75	Horizontal	-37.7	-13	24.7	135
3	2121.0	-46.19	2.51	11.05	Horizontal	-39.8	-13	26.8	225
4	2828.3	-52.7	4.20	11.15	Horizontal	-47.9	-13	34.9	270
5	3537.5	-53.9	5.20	11.15	Horizontal	-50.1	-13	37.1	180
6	4245.0	-54	5.50	11.95	Horizontal	-49.7	-13	36.7	90
7	4952.5	-53.2	5.70	13.55	Horizontal	-47.5	-13	34.5	180
8	5660.0	-52.9	6.30	13.75	Horizontal	-47.6	-13	34.6	90
9	6367.5	-49.1	6.80	13.85	Horizontal	-44.2	-13	31.2	135
10	7075.0	-47.5	6.90	14.25	Horizontal	-42.3	-13	29.3	225

Note: 1.The other Spurious RF Radiated emissions level is no more than noise floor.
2. The worst emission was found in the antenna is Horizontal position.

LTE Band 12 QPSK 1.4MHz CH-High, RB 1

Harmonic	Frequency (MHz)	SG (dBm)	Cable Loss (dB)	Gain (dBi)	Antenna Polarization	ERP Level (dBm)	Limit (dBm)	Margin (dB)	Azimuth (deg)
2	1429.8	-43.4	2.00	10.15	Horizontal	-37.4	-13	24.4	270
3	2144.3	-42.79	2.51	11.05	Horizontal	-36.4	-13	23.4	45
4	2859.8	-51.4	4.20	11.15	Horizontal	-46.6	-13	33.6	135
5	3577.5	-53.6	5.20	11.15	Horizontal	-49.8	-13	36.8	225
6	4589.3	-46.4	5.50	11.95	Horizontal	-42.1	-13	29.1	90
7	5008.5	-52	5.70	13.55	Horizontal	-46.3	-13	33.3	270
8	5724.0	-52.3	6.30	13.75	Horizontal	-47.0	-13	34.0	45
9	6439.5	-50.6	6.80	13.85	Horizontal	-45.7	-13	32.7	225
10	7155.0	-46.6	6.90	14.25	Horizontal	-41.4	-13	28.4	270

Note: 1.The other Spurious RF Radiated emissions level is no more than noise floor.

2. The worst emission was found in the antenna is Horizontal position.

LTE Band 12 QPSK 3MHz CH-Low, RB 1

Harmonic	Frequency (MHz)	SG (dBm)	Cable Loss (dB)	Gain (dBi)	Antenna Polarization	ERP Level (dBm)	Limit (dBm)	Margin (dB)	Azimuth (deg)
2	1398.8	-39.2	2.00	10.15	Horizontal	-33.2	-13	20.2	45
3	2098.5	-40.59	2.51	11.35	Horizontal	-33.9	-13	20.9	135
4	2797.8	-52.8	4.20	10.85	Horizontal	-48.3	-13	35.3	225
5	3502.5	-54.6	5.20	11.35	Horizontal	-50.6	-13	37.6	90
6	4203.0	-53.4	5.50	11.95	Horizontal	-49.1	-13	36.1	270
7	4903.5	-53.5	5.70	13.55	Horizontal	-47.8	-13	34.8	45
8	5604.0	-53.1	6.30	13.75	Horizontal	-47.8	-13	34.8	135
9	6304.5	-49.2	6.80	13.85	Horizontal	-44.3	-13	31.3	225
10	7005.0	-49.4	6.90	14.25	Horizontal	-44.2	-13	31.2	90

Note: 1.The other Spurious RF Radiated emissions level is no more than noise floor.

2. The worst emission was found in the antenna is Horizontal position.

LTE Band 12 QPSK 3MHz CH-Middle, RB 1

Harmonic	Frequency (MHz)	SG (dBm)	Cable Loss (dB)	Gain (dBi)	Antenna Polarization	ERP Level (dBm)	Limit (dBm)	Margin (dB)	Azimuth (deg)
2	1414.8	-44.1	2.00	10.75	Horizontal	-37.5	-13	24.5	90
3	2119.3	-45.79	2.51	11.05	Horizontal	-39.4	-13	26.4	135
4	2825.8	-53.3	4.20	11.15	Horizontal	-48.5	-13	35.5	225
5	3537.5	-53.8	5.20	11.15	Horizontal	-50.0	-13	37.0	270
6	4245.0	-54	5.50	11.95	Horizontal	-49.7	-13	36.7	45
7	4952.5	-54.3	5.70	13.55	Horizontal	-48.6	-13	35.6	135
8	5660.0	-51.9	6.30	13.75	Horizontal	-46.6	-13	33.6	225
9	6367.5	-50.3	6.80	13.85	Horizontal	-45.4	-13	32.4	90
10	7075.0	-47.5	6.90	14.25	Horizontal	-42.3	-13	29.3	270

- Note: 1.The other Spurious RF Radiated emissions level is no more than noise floor.
2. The worst emission was found in the antenna is Horizontal position.

LTE Band 12 QPSK 3MHz CH-High, RB 1

Harmonic	Frequency (MHz)	SG (dBm)	Cable Loss (dB)	Gain (dBi)	Antenna Polarization	ERP Level (dBm)	Limit (dBm)	Margin (dB)	Azimuth (deg)
2	1426.8	-42.3	2.00	10.15	Horizontal	-36.3	-13	23.3	45
3	2140.5	-40.09	2.51	11.05	Horizontal	-33.7	-13	20.7	135
4	2853.5	-48.9	4.20	11.15	Horizontal	-44.1	-13	31.1	225
5	3567.0	-51.4	5.20	11.15	Horizontal	-47.6	-13	34.6	90
6	4280.6	-48	5.50	11.95	Horizontal	-43.7	-13	30.7	135
7	5001.5	-51.3	5.70	13.55	Horizontal	-45.6	-13	32.6	225
8	5716.0	-52.1	6.30	13.75	Horizontal	-46.8	-13	33.8	270
9	6430.5	-50.3	6.80	13.85	Horizontal	-45.4	-13	32.4	180
10	7145.0	-46.3	6.90	14.25	Horizontal	-41.1	-13	28.1	45

- Note: 1.The other Spurious RF Radiated emissions level is no more than noise floor.
2. The worst emission was found in the antenna is Horizontal position.

LTE Band 12 QPSK 5MHz CH-Low, RB 1

Harmonic	Frequency (MHz)	SG (dBm)	Cable Loss (dB)	Gain (dBi)	Antenna Polarization	ERP Level (dBm)	Limit (dBm)	Margin (dB)	Azimuth (deg)
2	1398.5	-39.3	2.00	10.15	Horizontal	-33.3	-13	20.3	45
3	2098.0	-40.4	2.50	11.35	Horizontal	-33.7	-13	20.7	135
4	2797.8	-52.6	4.20	10.85	Horizontal	-48.1	-13	35.1	225
5	3507.5	-55	5.20	11.35	Horizontal	-51.0	-13	38.0	90
6	4195.9	-51	5.50	11.95	Horizontal	-46.7	-13	33.7	270
7	4910.5	-52.8	5.70	13.55	Horizontal	-47.1	-13	34.1	45
8	5612.0	-51.6	6.30	13.75	Horizontal	-46.3	-13	33.3	135
9	6313.5	-48.6	6.80	13.85	Horizontal	-43.7	-13	30.7	225
10	7015.0	-48.5	6.90	14.25	Horizontal	-43.3	-13	30.3	90

Note: 1.The other Spurious RF Radiated emissions level is no more than noise floor.
 2. The worst emission was found in the antenna is Horizontal position.

LTE Band 12 QPSK 5MHz CH-Middle, RB 1

Harmonic	Frequency (MHz)	SG (dBm)	Cable Loss (dB)	Gain (dBi)	Antenna Polarization	ERP Level (dBm)	Limit (dBm)	Margin (dB)	Azimuth (deg)
2	1410.5	-44.1	2.00	10.75	Horizontal	-37.5	-13	24.5	225
3	2116.0	-42.99	2.51	11.05	Horizontal	-36.6	-13	23.6	90
4	2821.3	-54.3	4.20	11.15	Horizontal	-49.5	-13	36.5	270
5	3537.5	-53.8	5.20	11.15	Horizontal	-50.0	-13	37.0	45
6	4245.0	-52.2	5.50	11.95	Horizontal	-47.9	-13	34.9	225
7	4952.5	-53.9	5.70	13.55	Horizontal	-48.2	-13	35.2	270
8	5660.0	-51.9	6.30	13.75	Horizontal	-46.6	-13	33.6	45
9	6367.5	-49.8	6.80	13.85	Horizontal	-44.9	-13	31.9	135
10	7075.0	-47.3	6.90	14.25	Horizontal	-42.1	-13	29.1	225

Note: 1.The other Spurious RF Radiated emissions level is no more than noise floor.
 2. The worst emission was found in the antenna is Horizontal position.

LTE Band 12 QPSK 5MHz CH-High, RB 1

Harmonic	Frequency (MHz)	SG (dBm)	Cable Loss (dB)	Gain (dBi)	Antenna Polarization	ERP Level (dBm)	Limit (dBm)	Margin (dB)	Azimuth (deg)
2	1422.8	-38.4	2.00	10.15	Horizontal	-32.4	-13	19.4	90
3	2133.8	-37.59	2.51	11.05	Horizontal	-31.2	-13	18.2	270
4	2845.5	-51.2	4.20	11.15	Horizontal	-46.4	-13	33.4	45
5	3556.9	-52.4	5.20	11.15	Horizontal	-48.6	-13	35.6	90
6	4268.3	-47.6	5.50	11.95	Horizontal	-43.3	-13	30.3	45
7	4994.5	-53.2	5.70	13.55	Horizontal	-47.5	-13	34.5	135
8	5708.0	-52	6.30	13.75	Horizontal	-46.7	-13	33.7	225
9	6421.5	-50.8	6.80	13.85	Horizontal	-45.9	-13	32.9	270
10	7135.0	-46.6	6.90	14.25	Horizontal	-41.4	-13	28.4	45

- Note: 1.The other Spurious RF Radiated emissions level is no more than noise floor.
2. The worst emission was found in the antenna is Horizontal position.

LTE Band 12 QPSK 10MHz CH-Low, RB 1

Harmonic	Frequency (MHz)	SG (dBm)	Cable Loss (dB)	Gain (dBi)	Antenna Polarization	ERP Level (dBm)	Limit (dBm)	Margin (dB)	Azimuth (deg)
2	1403.5	-40.6	2.00	10.15	Horizontal	-34.6	-13	21.6	135
3	2105.5	-41.59	2.51	11.35	Horizontal	-34.9	-13	21.9	225
4	2807.5	-50.4	4.20	10.85	Horizontal	-45.9	-13	32.9	90
5	3520.0	-54.9	5.20	11.35	Horizontal	-50.9	-13	37.9	270
6	4224.0	-53.1	5.50	11.95	Horizontal	-48.8	-13	35.8	45
7	4928.0	-53.4	5.70	13.55	Horizontal	-47.7	-13	34.7	45
8	5632.0	-51.1	6.30	13.75	Horizontal	-45.8	-13	32.8	135
9	6336.0	-50.6	6.80	13.85	Horizontal	-45.7	-13	32.7	225
10	7040.0	-48.2	6.90	14.25	Horizontal	-43.0	-13	30.0	90

- Note: 1.The other Spurious RF Radiated emissions level is no more than noise floor.
2. The worst emission was found in the antenna is Horizontal position.

LTE Band 12 QPSK 10MHz CH-Middle, RB 1

Harmonic	Frequency (MHz)	SG (dBm)	Cable Loss (dB)	Gain (dBi)	Antenna Polarization	ERP Level (dBm)	Limit (dBm)	Margin (dB)	Azimuth (deg)
2	1411.0	-44.2	2.00	10.75	Horizontal	-37.6	-13	24.6	270
3	2115.8	-43.39	2.51	11.05	Horizontal	-37.0	-13	24.0	45
4	2821.5	-53.2	4.20	11.15	Horizontal	-48.4	-13	35.4	225
5	3537.5	-54.1	5.20	11.15	Horizontal	-50.3	-13	37.3	270
6	4232.3	-50.8	5.50	11.95	Horizontal	-46.5	-13	33.5	45
7	4950.4	-51.8	5.70	13.55	Horizontal	-46.1	-13	33.1	135
8	5660.0	-52.3	6.30	13.75	Horizontal	-47.0	-13	34.0	225
9	6367.5	-49.2	6.80	13.85	Horizontal	-44.3	-13	31.3	90
10	7075.0	-47.5	6.90	14.25	Horizontal	-42.3	-13	29.3	270

- Note: 1.The other Spurious RF Radiated emissions level is no more than noise floor.
2. The worst emission was found in the antenna is Horizontal position.

LTE Band 12 QPSK 10MHz CH-High, RB 1

Harmonic	Frequency (MHz)	SG (dBm)	Cable Loss (dB)	Gain (dBi)	Antenna Polarization	ERP Level (dBm)	Limit (dBm)	Margin (dB)	Azimuth (deg)
2	1417.3	-43	2.00	10.15	Horizontal	-37.0	-13	24.0	45
3	2126.3	-45.39	2.51	11.05	Horizontal	-39.0	-13	26.0	180
4	2835.3	-50	4.20	11.15	Horizontal	-45.2	-13	32.2	45
5	3555.0	-53.5	5.20	11.15	Horizontal	-49.7	-13	36.7	45
6	4266.0	-53.6	5.50	11.95	Horizontal	-49.3	-13	36.3	135
7	4977.0	-52.7	5.70	13.55	Horizontal	-47.0	-13	34.0	225
8	5688.0	-51.4	6.30	13.75	Horizontal	-46.1	-13	33.1	90
9	6399.0	-50.2	6.80	13.85	Horizontal	-45.3	-13	32.3	270
10	7110.0	-46.1	6.90	14.25	Horizontal	-40.9	-13	27.9	45

- Note: 1.The other Spurious RF Radiated emissions level is no more than noise floor.
2. The worst emission was found in the antenna is Horizontal position.

6 Main Test Instruments

Name	Manufacturer	Type	Serial Number	Calibration Date	Expiration Time
Base Station Simulator	R&S	CMW500	113645	2017-05-14	2018-05-13
Power Splitter	Hua Xiang	SHX-GF2-2-13	10120101	2017-05-14	2018-05-13
Universal Radio Communication Tester	Agilent	E5515C	MY48367192	2017-05-14	2018-05-13
Spectrum Analyzer	Agilent	N9010A	MY47191109	2017-05-14	2018-05-13
Signal Analyzer	R&S	FSV30	100815	2016-12-16	2017-12-15
Signal generator	R&S	SMB 100A	102594	2017-05-14	2018-05-13
EMI Test Receiver	R&S	ESCI	100948	2017-05-20	2018-05-19
Trilog Antenna	SCHWARZBECK	VUBL 9163	9163-201	2014-12-06	2017-12-05
Horn Antenna	R&S	HF907	100126	2014-12-06	2017-12-05
Horn Antenna	ETS-Lindgren	3160-09	00102643	2015-01-30	2018-01-29
Climatic Chamber	Re Ce	PT-30B	20101891	2015-07-18	2018-07-17
RF Cable	Agilent	SMA 15cm	0001	2017-08-04	2018-02-03
Preamplifier	R&S	SCU18	102327	2017-06-18	2018-06-17

ANNEX A: EUT Appearance and Test Setup

A.1 EUT Appearance

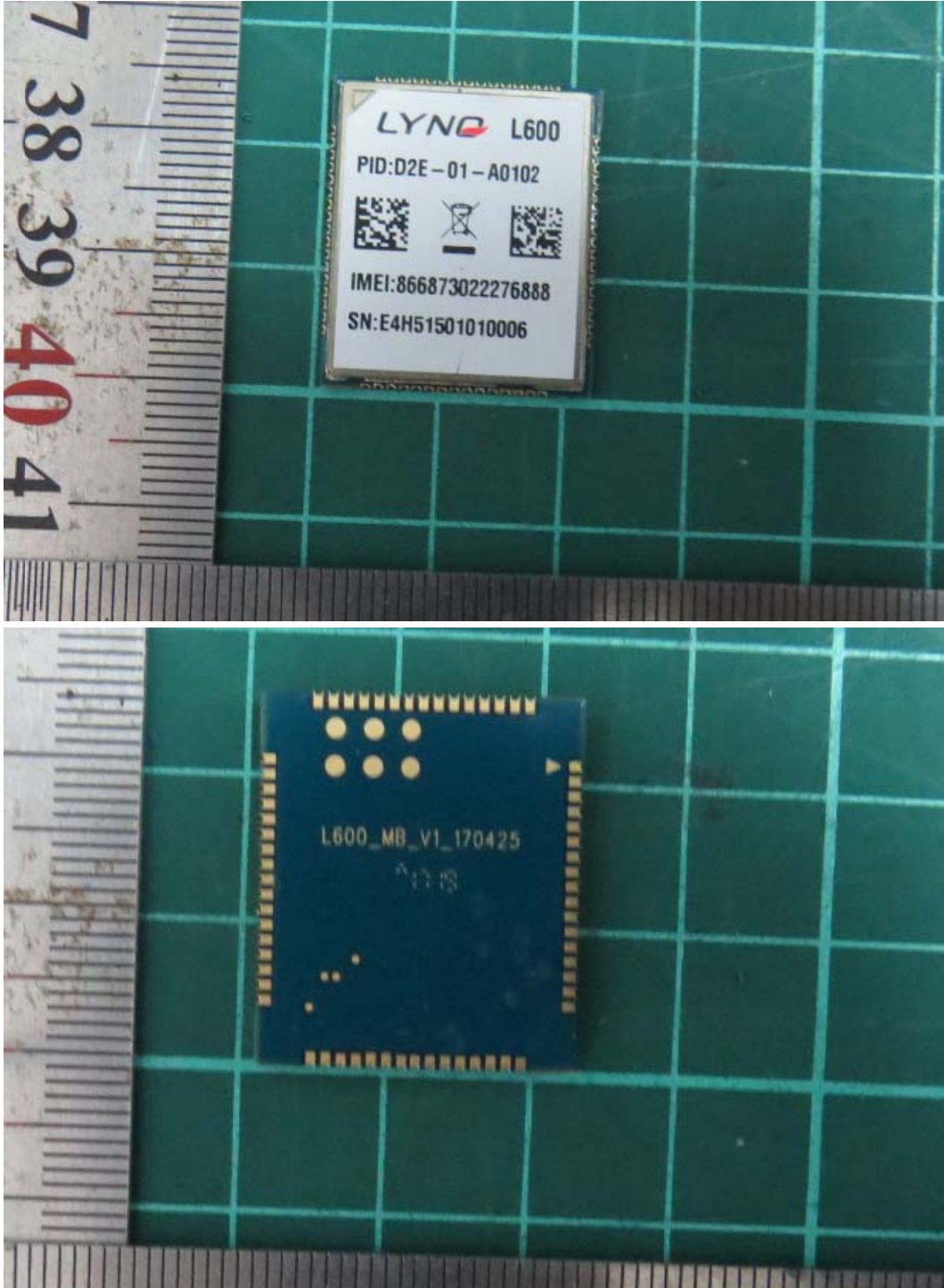

Picture 1 EUT

A.2 Test Setup

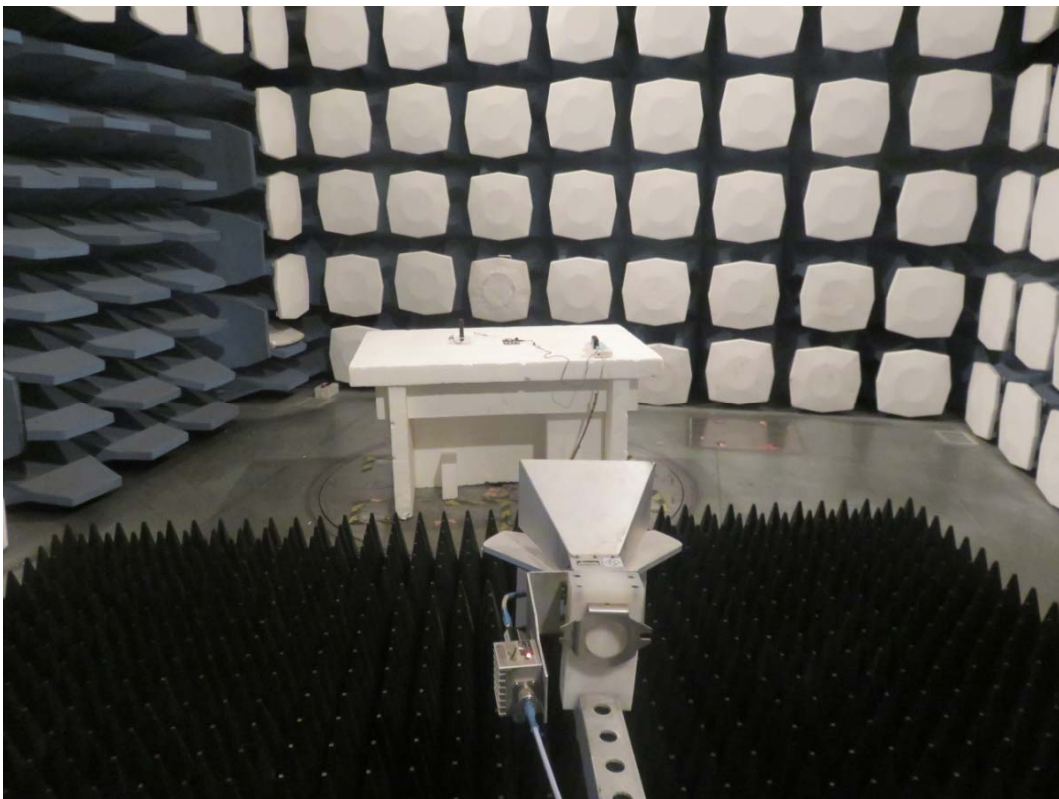
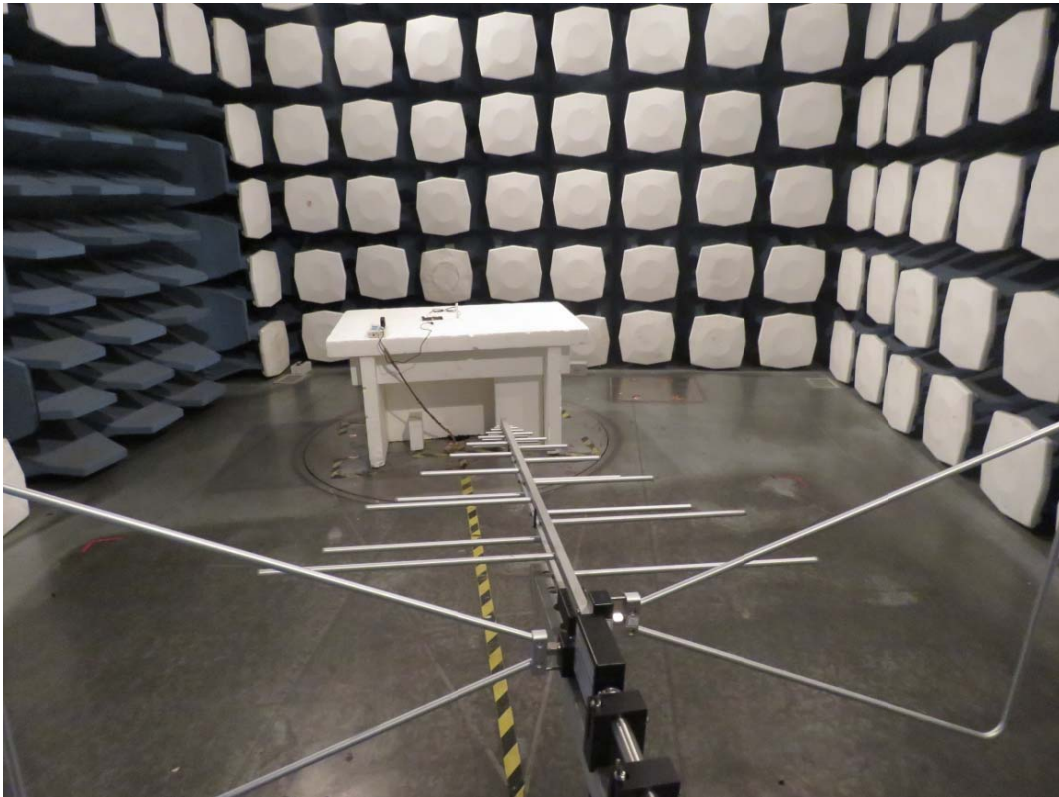

Picture 2: Radiated Spurious Emissions Test setup