



RF TEST REPORT

Applicant Shanghai MobileTek Communication Ltd.
FCC ID 2AK9DL600A
Product IOT module
Model L600A
Report No. RXA1709-0329RF01
Issue Date November 14, 2017

TA Technology (Shanghai) Co., Ltd. tested the above equipment in accordance with the requirements in **FCC CFR47 Part 2 (2017)/ FCC CFR 47 Part 24E (2017)**. The test results show that the equipment tested is capable of demonstrating compliance with the requirements as documented in this report.

Performed by: Jiangpeng Lan

Approved by: Kai Xu

TA Technology (Shanghai) Co., Ltd.

No.145, Jintang Rd, Tangzhen Industry Park, Pudong Shanghai, China

TEL: +86-021-50791141/2/3

FAX: +86-021-50791141/2/3-8000



TABLE OF CONTENT

1. Test Laboratory	4
1.1. Notes of the test report.....	4
1.2. Test facility.....	4
1.3. Testing Location	5
2. General Description of Equipment under Test.....	6
3. Applied Standards.....	7
4. Test Configuration.....	8
5. Test Case Results.....	9
5.1. RF Power Output.....	9
5.2. Effective Isotropic Radiated Power	11
5.3. Occupied Bandwidth	14
5.4. Band Edge Compliance.....	18
5.5. Peak-to-Average Power Ratio (PAPR)	27
5.6. Frequency Stability	29
5.7. Spurious Emissions at Antenna Terminals	33
5.8. Radiates Spurious Emission	42
6. Main Test Instruments	53
ANNEX A: EUT Appearance and Test Setup.....	54
A.1 EUT Appearance	54
A.2 Test Setup.....	55



Summary of measurement results

No.	Test Case	Clause in FCC rules	Verdict
1	RF power output	2.1046	PASS
2	Effective Isotropic Radiated power	24.232(c)	PASS
3	Occupied Bandwidth	2.1049	PASS
4	Band Edge Compliance	2.1051 /24.238(a)	PASS
5	Peak-to-Average Power Ratio	24.232/KDB 971168 D01(5.7)	PASS
6	Frequency Stability	2.1055 / 24.235	PASS
7	Spurious Emissions at Antenna Terminals	2.1051 / 24.238(a)	PASS
8	Radiates Spurious Emission	2.1053 / 24.238(a)	PASS
Date of Testing: October 10, 2017~ October 29, 2017			
Note: PASS: The EUT complies with the essential requirements in the standard. FAIL: The EUT does not comply with the essential requirements in the standard.			



1. Test Laboratory

1.1. Notes of the test report

This report shall not be reproduced in full or partial, without the written approval of **TA technology (shanghai) co., Ltd.** The results documented in this report apply only to the tested sample, under the conditions and modes of operation as described herein. Measurement Uncertainties were not taken into account and are published for informational purposes only. This report is written to support regulatory compliance of the applicable standards stated above. This report must not be used by the client to claim product certification, approval, or endorsement by any government agencies.

1.2. Test facility

CNAS (accreditation number: L2264)

TA Technology (Shanghai) Co., Ltd. has obtained the accreditation of China National Accreditation Service for Conformity Assessment (CNAS).

FCC (Designation number: CN1179, Test Firm Registration Number: 446626)

TA Technology (Shanghai) Co., Ltd. has been listed on the US Federal Communications Commission list of test facilities recognized to perform electromagnetic emissions measurements.

IC (recognition number is 8510A)

TA Technology (Shanghai) Co., Ltd. has been listed by industry Canada to perform electromagnetic emission measurement.

VCCI (recognition number is C-4595, T-2154, R-4113, G-10766)

TA Technology (Shanghai) Co., Ltd. has been listed by industry Japan to perform electromagnetic emission measurement.

A2LA (Certificate Number: 3857.01)

TA Technology (Shanghai) Co., Ltd. has been listed by American Association for Laboratory Accreditation to perform electromagnetic emission measurement.



1.3. Testing Location

Company: TA Technology (Shanghai) Co., Ltd.
Address: No.145, Jintang Rd, Tangzhen Industry Park, Pudong
City: Shanghai
Post code: 201201
Country: P. R. China
Contact: Xu Kai
Telephone: +86-021-50791141/2/3
Fax: +86-021-50791141/2/3-8000
Website: <http://www.ta-shanghai.com>
E-mail: xukai@ta-shanghai.com

2. General Description of Equipment under Test

Client Information

Applicant	Shanghai MobileTek Communication Ltd.
Applicant address	Free Trade Zone No. 33, No. 17 building 6H Xiya Road Shanghai, China
Manufacturer	Shanghai MobileTek Communication Ltd.
Manufacturer address	Free Trade Zone No. 33, No. 17 building 6H Xiya Road Shanghai, China

General information

EUT Description			
Model	L600A		
Product IMEI:	866908030000332		
Hardware Version	V1		
Software Version	L600v02.01b03		
Power Supply	External power supply		
Antenna Type	The EUT don't have standard Antenna, The Antenna used for testing in this report is the after-market accessory (Rod antenna)		
Test Mode(s)	LTE Band 2;		
Test Modulation	(LTE)QPSK,16QAM		
LTE Category	M1		
Maximum E.I.R.P	LTE Band 2:	23.99 dBm	
Rated Power Supply Voltage	3.8V		
Extreme Voltage	Minimum: 3.4V	Maximum: 4.2V	
Extreme Temperature	Lowest: -40°C	Highest: +85°C	
Operating Frequency Range(s)	Band	Tx (MHz)	Rx (MHz)
	LTE Band 2	1850 ~ 1910	1930 ~ 1990
Note: The information of the EUT is declared by the manufacturer.			

Accessory equipment	
Evaluation Board	RF Cable
Adapter	Antenna: Rod antenna
Micro USB Cable	/



3. Applied Standards

According to the specifications of the manufacturer, it must comply with the requirements of the following standards:

FCC CFR47 Part 2 (2017)

FCC CFR 47 Part 24E (2017)

ANSI/TIA-603-D (2010)

KDB 971168 D01 Power Meas License Digital Systems v02r02

4. Test Configuration

Radiated measurements are performed by rotating the EUT in three different orthogonal test planes. EUT stand-up position (Z axis), lie-down position (X, Y axis). Receiver antenna polarization (horizontal and vertical), the worst emission was found in position (Z axis, horizontal polarization) and the worst case was recorded.

All mode and data rates and positions and RB size and modulations were investigated.

Subsequently, only the worst case emissions are reported.

The following testing in LTE is set based on the maximum RF Output Power.

The following testing in different Bandwidth is set to detailin the following table:

Test modes are chosen to be reported as the worst case configuration below for LTE Band 2:

Test items	Bandwidth (MHz)						Modulation		RB			Test Channel		
	1.4	3	5	10	15	20	QPSK	16QAM	1	50%	100%	L	M	H
RF power output	O	O	O	O	O	O	O	O	O	O	O	O	O	O
Effective Isotropic Radiated power	O	O	O	O	O	O	O	O	-	-	O	O	O	O
Occupied Bandwidth	O	O	O	O	O	O	O	O	-	-	O	O	O	O
Band Edge Compliance	O	O	O	O	O	O	O	O	O	-	O	O	-	O
Peak-to-Average Power Ratio	O	O	O	O	O	O	O	O	-	-	O	O	O	O
Frequency Stability	O	O	O	O	O	O	O	O	-	-	O	-	O	-
Conducted Spurious Emissions	O	O	O	O	O	O	O	-	O	-	-	O	O	O
Radiates Spurious Emission	O	O	O	O	O	O	O	-	O	-	-	O	O	O
Note	1. The mark "O" means that this configuration is chosen for testing. 2. The mark "-" means that this configuration is not testing.													

5. Test Case Results

5.1.RF Power Output

Ambient condition

Temperature	Relative humidity	Pressure
23°C ~25°C	45%~50%	101.5kPa

Methods of Measurement

During the process of the testing, The EUT is controlled by the Base Station Simulator to ensure max power transmission and proper modulation.

Test Setup

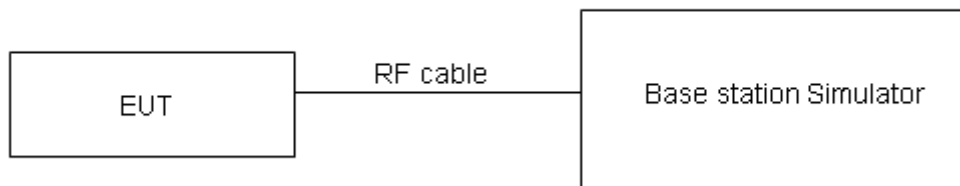

The loss between RF output port of the EUT and the input port of the tester has been taken into consideration.

Limits

No specific RF power output requirements in part 2.1046.

Measurement Uncertainty

The assessed measurement uncertainty to ensure 95% confidence level for the normal distribution is with the coverage factor $k = 2$, $U = 0.4$ dB.



Test Results

Mode	Bandwidth	Channel/ Frequency(MHz)	RB	Index	Conducted Power (dBm)	
					QPSK	16QAM
Band 2	1.4MHz	18607/1850.7	1#0	0	22.23	21.77
			6#0	0	20.49	20.36
		18900/1880	1#0	0	22.56	21.20
			6#0	0	20.62	20.82
		19193/1909.3	1#5	0	22.25	21.03
			6#0	0	20.54	20.69
	3MHz	18615/1851.5	1#0	0	22.37	21.91
			6#0	0	20.63	20.83
		18900/1880	1#0	0	22.30	21.81
			6#0	0	20.59	20.49
		19185/1908.5	1#5	1	22.27	21.64
			6#0	1	20.54	20.62
	5MHz	18625/1852.5	1#0	0	22.51	21.92
			6#0	0	21.80	20.84
		18900/1880	1#0	0	22.37	21.99
			6#0	0	21.57	20.76
		19175/1907.5	1#5	3	22.20	21.66
			6#0	3	21.70	20.82
	10MHz	18650/1855	1#0	0	22.52	21.91
			4#0	0	21.51	21.80
		18900/1880	1#0	0	22.26	22.13
			4#0	0	21.48	21.58
		19150/1905	1#5	7	22.37	21.21
			4#2	7	21.65	21.62
	15MHz	18675/1857.5	1#0	0	22.55	22.07
			6#0	0	22.68	22.15
		18900/1880	1#0	0	22.30	22.14
			6#0	0	22.45	22.47
		19125/1902.5	1#5	11	22.60	22.50
			6#0	11	22.78	22.14
	20MHz	18700/1860	1#0	0	22.55	21.85
			6#0	0	22.66	22.24
18900/1880		1#0	0	22.61	22.46	
		6#0	0	22.56	22.53	
19100/1900		1#5	15	22.79	22.60	
		6#0	15	22.84	22.40	

5.2. Effective Isotropic Radiated Power

Ambient condition

Temperature	Relative humidity	Pressure
23°C ~25°C	45%~50%	101.5kPa

Methods of Measurement

1. The testing follows FCC KDB 971168 v02r02 Section 5.8 and ANSI/TIA-603-D-2010.

a) Connect the equipment as illustrated. Mount the equipment with the manufacturer specified antenna in a vertical orientation on a manufacturer specified mounting surface located on a non-conducting rotating platform of a RF anechoic chamber (preferred) or a standard radiation site.

b) Key the transmitter, then rotate the EUT 360° azimuthally and record spectrum analyzer power level (LVL) measurements at angular increments that are sufficiently small to permit resolution of all peaks. If a standard radiation test site is used, raise and lower the test antenna to obtain a maximum reading at each angular increment. (Note: several batteries may be needed to offset the effect of battery voltage droop, which should not exceed 5% of the manufactured specified battery voltage during transmission).

c) Replace the transmitter under test with a vertically polarized half-wave dipole (or an antenna whose gain is known relative to an ideal half-wave dipole). The center of the antenna should be at the same location as the center of the antenna under test.

d) Connect the antenna to a signal generator with a known output power and record the path loss (in dB) as LOSS. If a standard radiation test site is used, raise and lower the test antenna to obtain a maximum reading. $LOSS = \text{Generator Output Power (dBm)} - \text{Analyzer reading (dBm)}$

e) Determine the effective radiated output power at each angular position from the readings in steps b) and d) using the following equation: $ERP \text{ (dBm)} = \text{LVL (dBm)} + \text{LOSS (dB)}$

f) The maximum ERP is the maximum value determined in the preceding step.

g) When calculating ERP, in addition to knowing the antenna radiation and matching characteristics, it is necessary to know the loss values of all elements (e.g. transmission line attenuation, mismatches, filters, combiners) interposed between the point where transmitter output power is measured, and the point where power is applied to the antenna. ERP can then be calculated as follows:

$$ERP \text{ (dBm)} = \text{Output Power (dBm)} - \text{Losses (dB)} + \text{Antenna Gain (dBd)}$$

where: dBd refers to gain relative to an ideal dipole.

$$EIRP \text{ (dBm)} = ERP \text{ (dBm)} + 2.15 \text{ (dB)}$$

Test setup

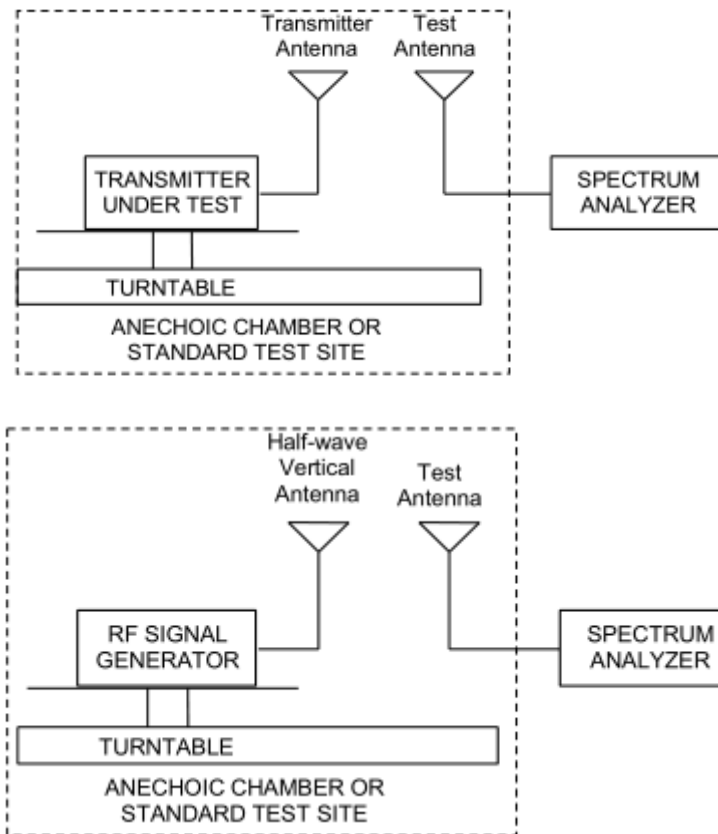

Limits

Rule Part 24.232(c) Mobile and portable stations are limited to 2 watts EIRP.

Rule Part 24.232(e) Peak transmit power must be measured over any interval of continuous transmission using instrumentation calibrated in terms of an rms-equivalent voltage.

Limit (EIRP)	$\leq 2 \text{ W}$ (33 dBm)
--------------	-----------------------------

Measurement Uncertainty

The assessed measurement uncertainty to ensure 95% confidence level for the normal distribution is with the coverage factor $k = 2$, $U = 1.19 \text{ dB}$

**Test Results:**

The measurement is performed for both of horizontal and vertical antenna Polarization, and only the data of worst mode is recorded in this report.

Mode	Bandwidth	Modulation	Channel/Frequency (MHz)	Polarization	RB	Index	Output power (dBm)	Losses (dBm)	Ant gain (dBi)	EIRP (dBm)	EIRP (W)
Band2	1.4MHz	QPSK	18607/1850.7	H	1#0	0	-35.12	-54.89	1.90	21.66	0.15
			18900/1880	H	1#2	0	-36.81	-56.66	1.92	21.77	0.15
			19193/1909.3	H	1#5	0	-37.93	-58.09	1.91	22.07	0.16
		16QAM	18607/1850.7	H	1#0	0	-35.46	-54.89	1.90	21.33	0.14
			18900/1880	H	1#2	0	-37.19	-56.66	1.92	21.39	0.14
			19193/1909.3	H	1#5	0	-38.25	-58.09	1.91	21.75	0.15
	3MHz	QPSK	18615/1851.5	H	1#0	0	-36.08	-54.93	1.91	20.75	0.12
			18900/1880	H	1#5	0	-37.10	-56.66	1.94	21.50	0.14
			19185/1908.5	H	1#5	1	-38.24	-58.08	1.91	21.75	0.15
		16QAM	18615/1851.5	H	1#0	0	-36.39	-54.93	1.91	20.45	0.11
			18900/1880	H	1#5	0	-37.30	-56.66	1.94	21.30	0.13
			19185/1908.5	H	1#5	1	-38.54	-58.08	1.91	21.45	0.14
	5MHz	QPSK	18625/1852.5	H	1#0	0	-33.62	-54.98	1.92	23.28	0.21
			18900/1880	H	1#5	1	-35.21	-56.66	1.94	23.39	0.22
			19175/1907.5	H	1#5	3	-36.60	-58.05	1.90	23.35	0.22
		16QAM	18625/1852.5	H	1#0	0	-33.91	-54.98	1.92	22.99	0.20
			18900/1880	H	1#5	1	-35.45	-56.66	1.94	23.15	0.21
			19175/1907.5	H	1#5	3	-36.85	-58.05	1.90	23.10	0.20
	10MHz	QPSK	18650/1855	H	4#0	0	-33.06	-55.09	1.91	23.93	0.25
			18900/1880	H	4#2	3	-35.27	-56.66	1.94	23.33	0.22
			19150/1905	H	4#2	7	-38.49	-58.01	1.92	21.45	0.14
		16QAM	18650/1855	H	4#0	0	-33.38	-55.09	1.91	23.62	0.23
			18900/1880	H	4#2	3	-35.60	-56.66	1.94	23.00	0.20
			19150/1905	H	4#2	7	-38.78	-58.01	1.92	21.15	0.13
	15MHz	QPSK	18675/1857.5	H	1#0	0	-33.62	-55.23	1.93	23.54	0.23
			18900/1880	H	1#5	5	-34.80	-56.66	1.94	23.80	0.24
			19125/1902.5	H	1#5	11	-37.69	-57.95	1.92	22.18	0.17
		16QAM	18675/1857.5	H	1#0	0	-33.91	-55.23	1.93	23.25	0.21
			18900/1880	H	1#5	5	-35.10	-56.66	1.94	23.50	0.22
			19125/1902.5	H	1#5	11	-37.87	-57.95	1.92	22.00	0.16
20MHz	QPSK	18700/1860	H	6#0	0	-35.02	-55.35	1.93	22.27	0.17	
		18900/1880	H	6#0	7	-34.99	-56.66	1.94	23.61	0.23	
		19100/1900	H	6#0	15	-35.79	-57.86	1.92	23.99	0.25	
	16QAM	18700/1860	H	6#0	0	-35.27	-55.35	1.93	22.01	0.16	
		18900/1880	H	6#0	7	-35.30	-56.66	1.94	23.30	0.21	
		19100/1900	H	6#0	15	-36.23	-57.86	1.92	23.55	0.23	

5.3.Occupied Bandwidth

Ambient condition

Temperature	Relative humidity	Pressure
23°C ~25°C	45%~50%	101.5kPa

Method of Measurement

The EUT was connected to Spectrum Analyzer and Base Station Simulator via power Splitter. The occupied bandwidth is measured using spectrum analyzer.

RBW is set to 51kHz, VBW is set to 160kHz for LTE Band 2

99% power and -26dBc occupied bandwidths are recorded. Spectrum analyzer plots are included on the following pages.

Test Setup

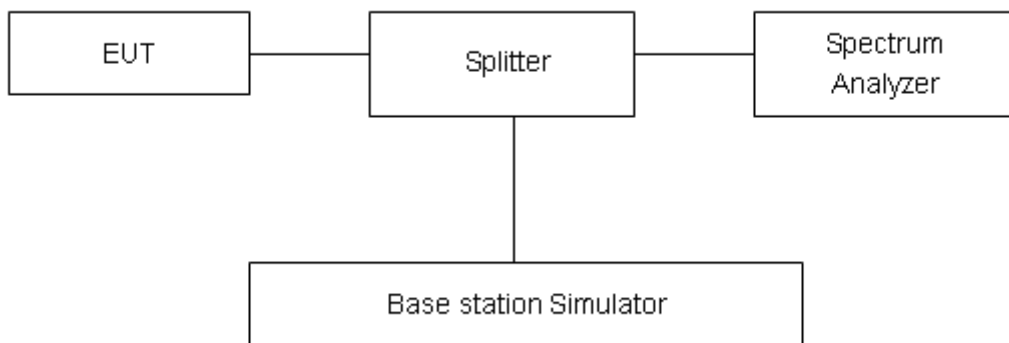

Limits

No specific occupied bandwidth requirements in part 2.1049.

Measurement Uncertainty

The assessed measurement uncertainty to ensure 95% confidence level for the normal distribution is with the coverage factor $k = 2$, $U = 624\text{Hz}$.



Test Result

Mode	Bandwidth	Modulation	Channel/ Frequency (MHz)	RB	Index	Bandwidth(MHz)	
						99% Power	-26dBc
Band 2	1.4MHz	QPSK	18900/1880	6#0	0	1.1130	1.357
		16QAM	18900/1880	6#0	0	0.9414	1.286
	3MHz	QPSK	18900/1880	6#0	0	1.1430	1.538
		16QAM	18900/1880	6#0	0	1.0004	1.376
	5MHz	QPSK	18900/1880	6#0	0	1.1404	1.523
		16QAM	18900/1880	6#0	0	0.9746	1.319
	10MHz	QPSK	18900/1880	6#0	0	1.1826	1.756
		16QAM	18900/1880	6#0	0	1.0688	1.669
	15MHz	QPSK	18900/1880	6#0	0	1.2530	2.178
		16QAM	18900/1880	6#0	0	1.1291	2.132
	20MHz	QPSK	18900/1880	6#0	0	1.2768	2.068
		16QAM	18900/1880	6#0	0	1.1839	2.006

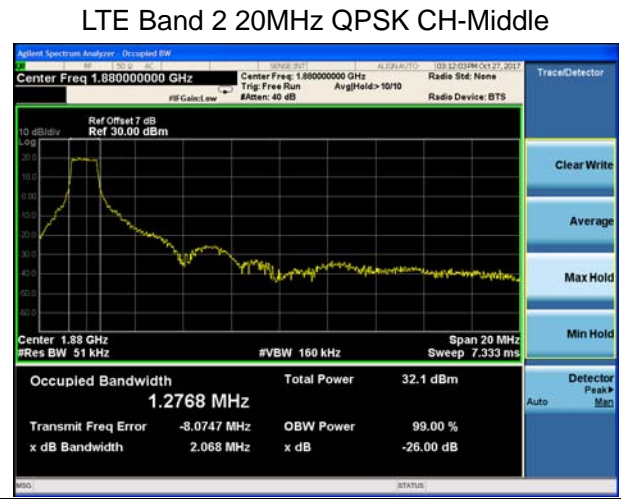
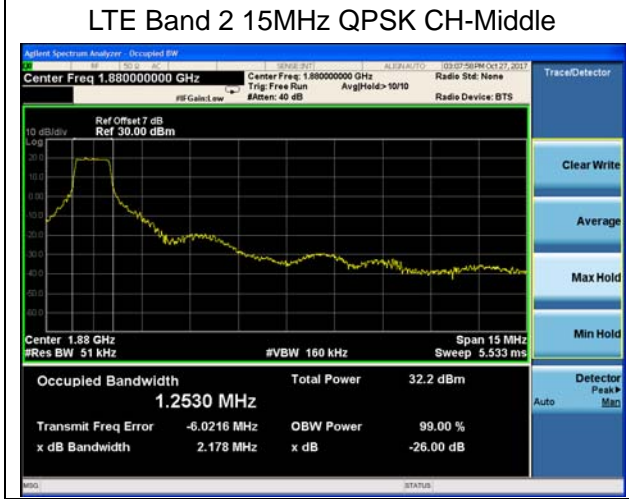
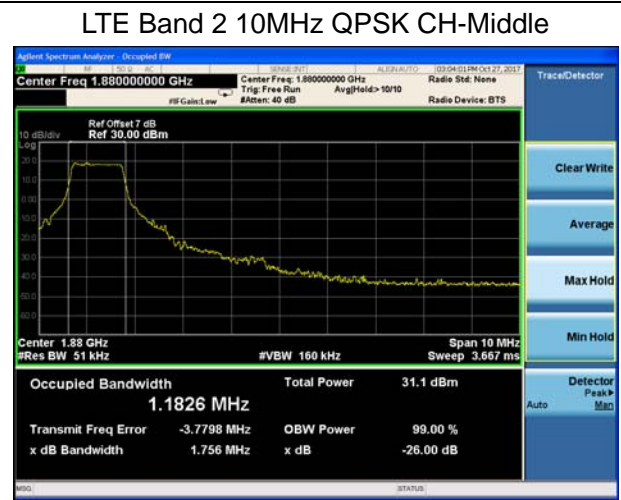
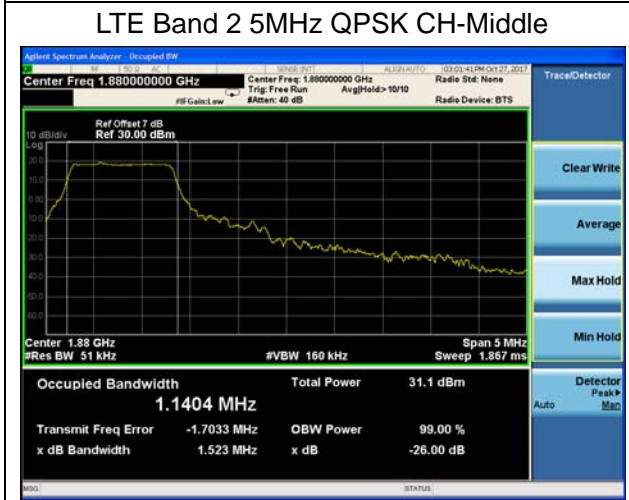
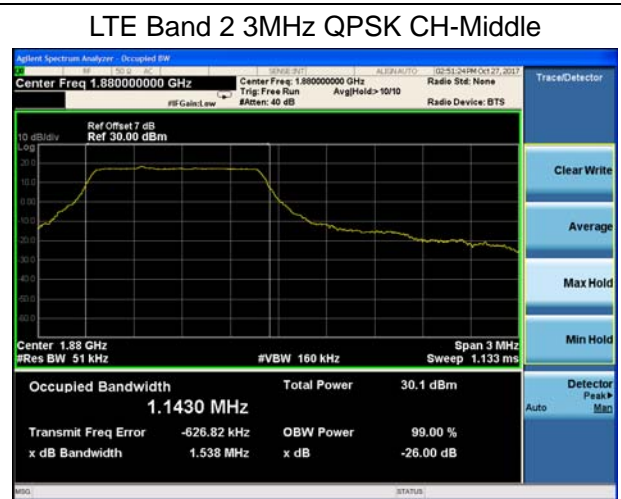
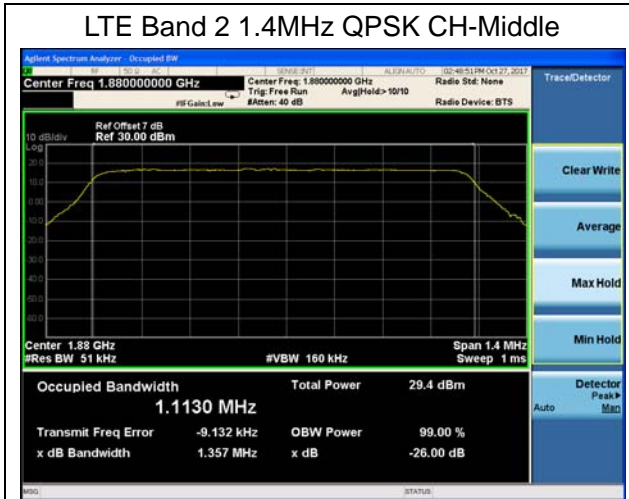

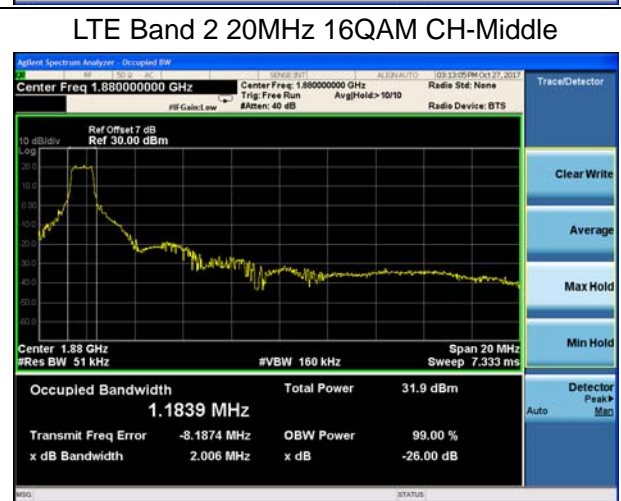
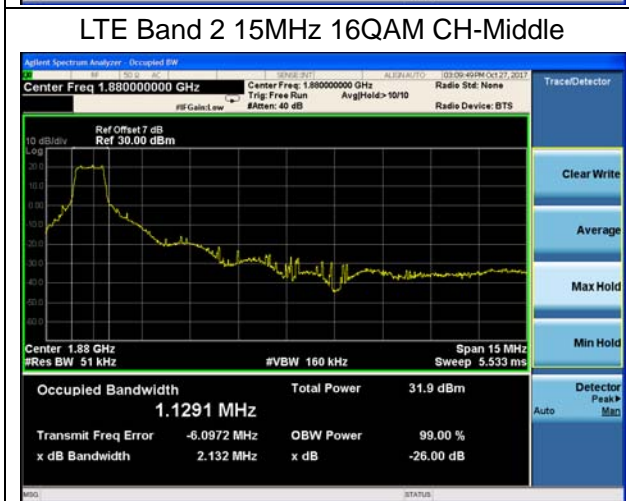
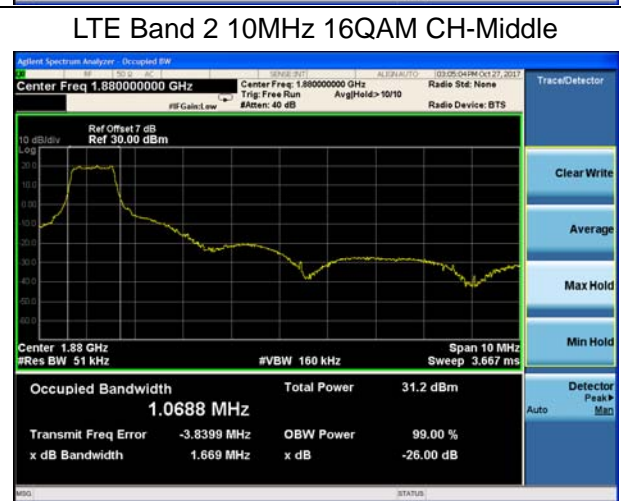
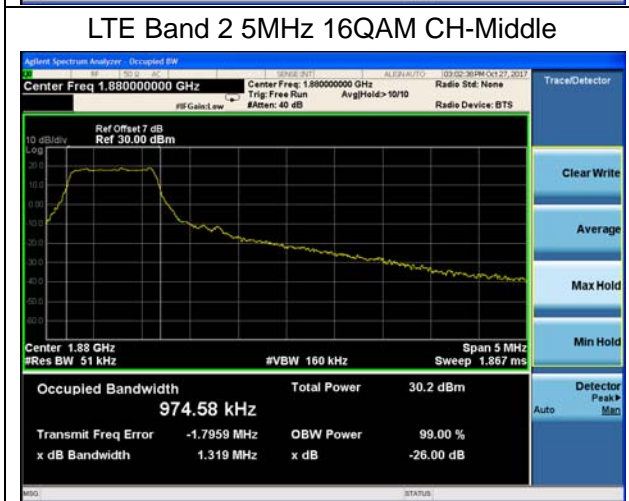
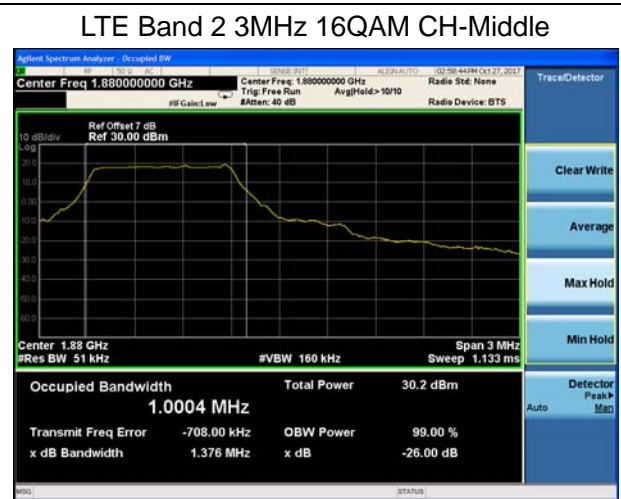
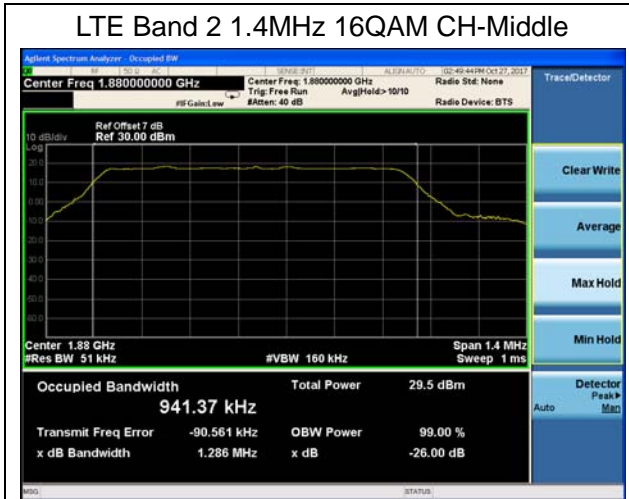

5.4. Band Edge Compliance

Ambient condition

Temperature	Relative humidity	Pressure
23°C ~25°C	45%~50%	101.5kPa

Method of Measurement

The EUT was connected to Spectrum Analyzer and Base Station Simulator via power Splitter. The band edge of the lowest and highest channels were measured. The Average detector is used and RBW is set to 51kHz, VBW is set to 160kHz for LTE Band 2. Spectrum analyzer plots are included on the following pages.

Test Setup

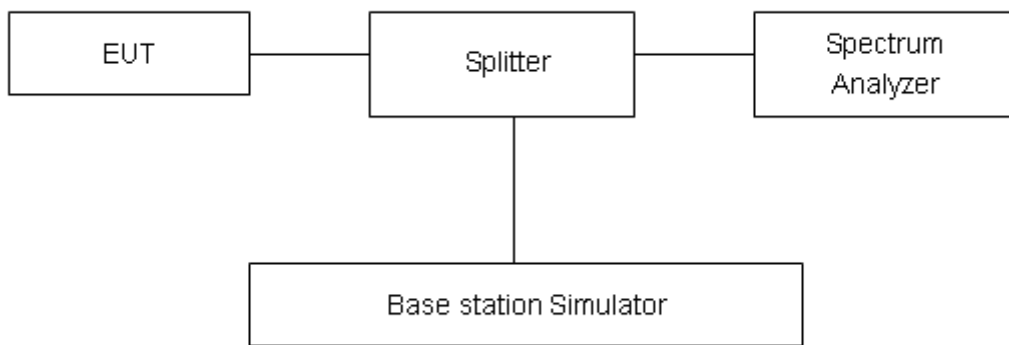

Limits

Rule Part 24.238(a) specifies that “on any frequency outside a licensee’s frequency block, the power of any emission shall be attenuated below the transmitter power (P) by at least $43 + 10 \log_{10} (P)$ dB.”

Limit	-13 dBm
-------	---------

Measurement Uncertainty

The assessed measurement uncertainty to ensure 95% confidence level for the normal distribution is with the coverage factor $k = 1.96$, $U=0.684$ dB.



Test Result:

LTE Band 2 1.4MHz QPSK 1RB CH-Low



LTE Band 2 1.4MHz QPSK 1RB CH-High

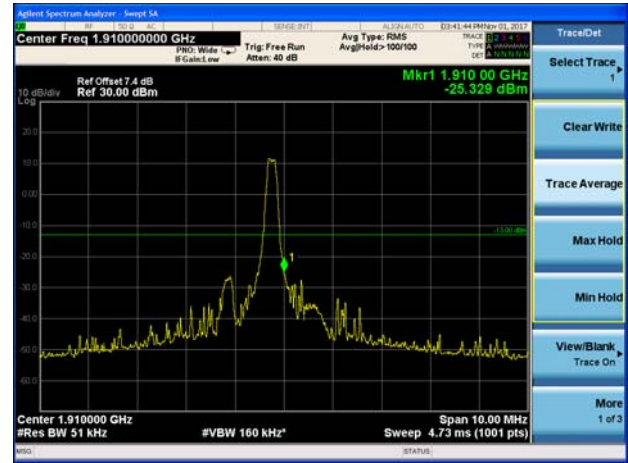

LTE Band 2 1.4MHz QPSK 100%RB CH-Low

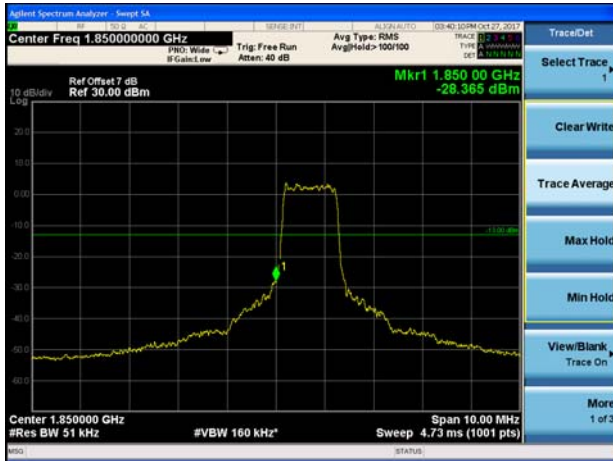

LTE Band 2 1.4MHz QPSK 100%RB CH-High

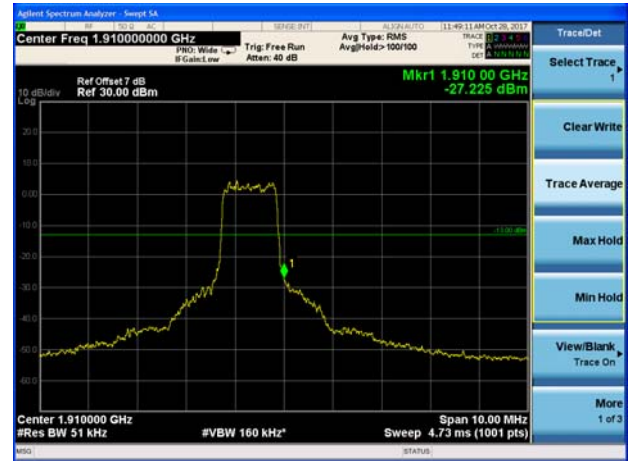

LTE Band 2 3MHz QPSK 1RB CH-Low

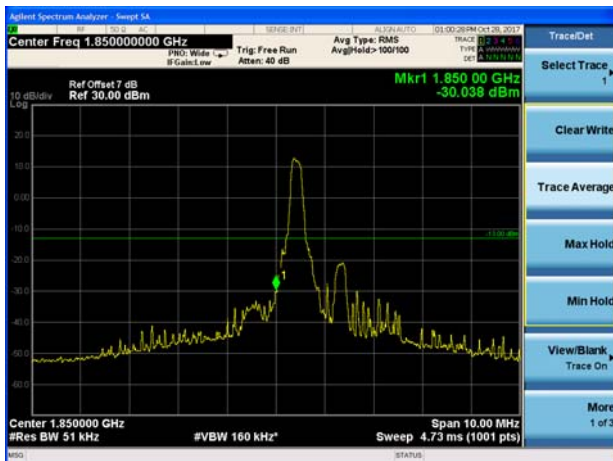

LTE Band 2 3MHz QPSK 1RB CH-High

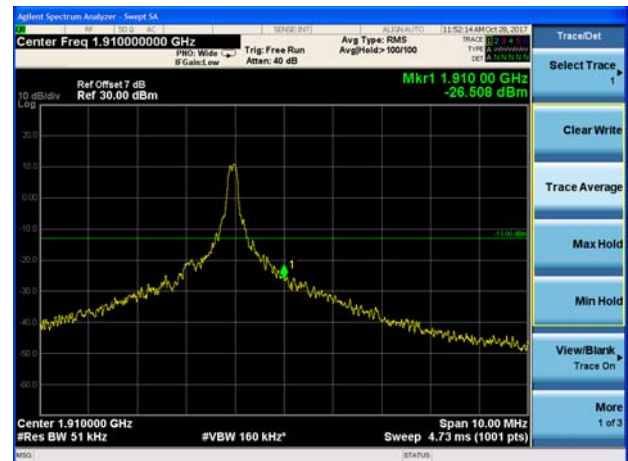

LTE Band 2 3MHz QPSK 100%RB CH-Low



LTE Band 2 3MHz QPSK 100%RB CH-High

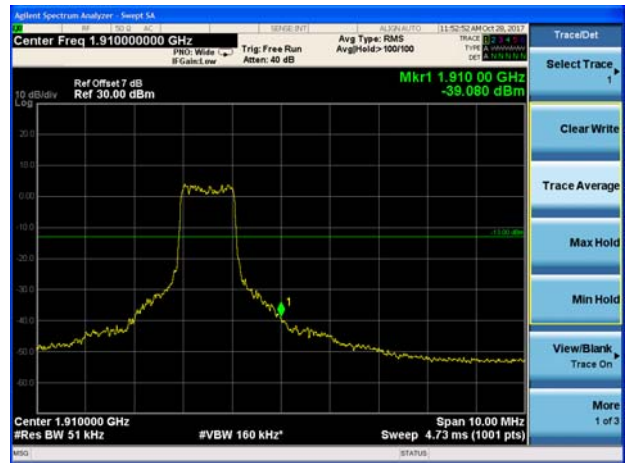

LTE Band 2 5MHz QPSK 1RB CH-Low

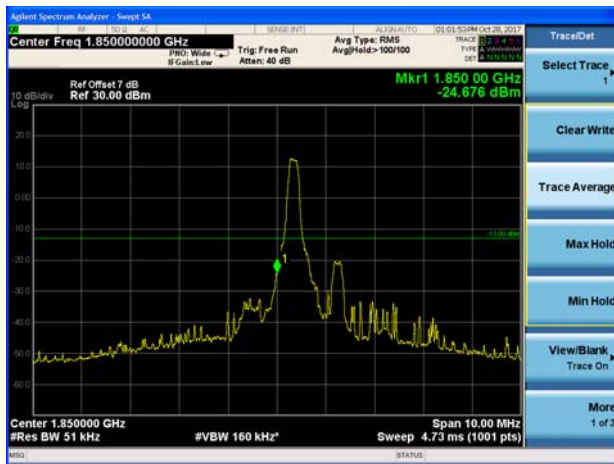

LTE Band 2 5MHz QPSK 1RB CH-High

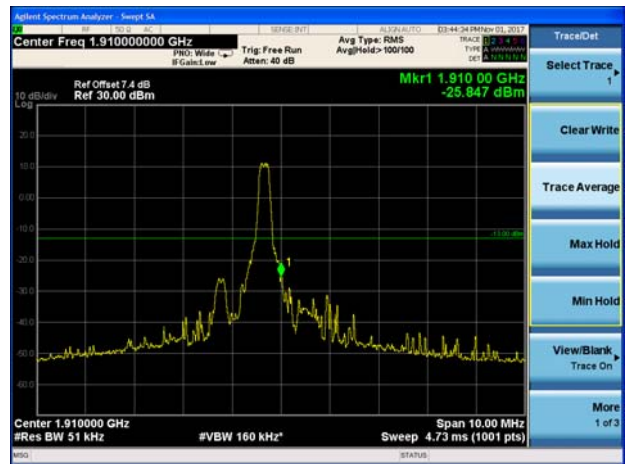

LTE Band 2 5MHz QPSK 100%RB CH-Low

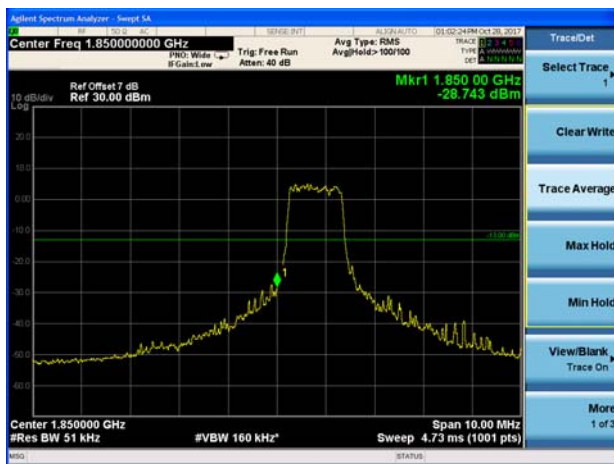

LTE Band 2 5MHz QPSK 100%RB CH-High

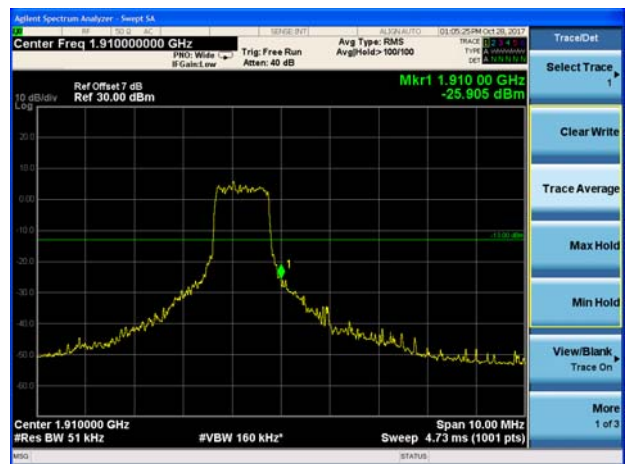

LTE Band 2 10MHz QPSK 1RB CH-Low

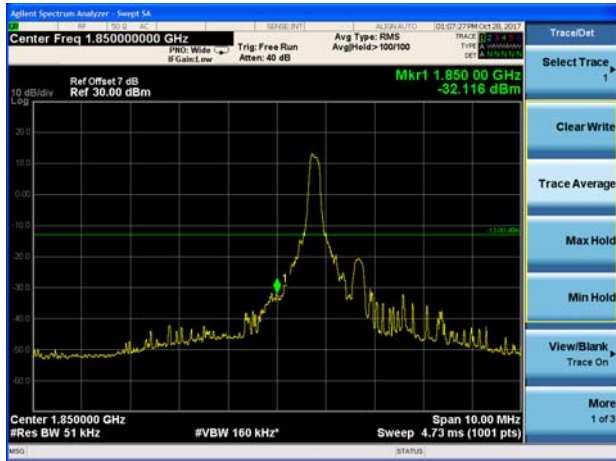

LTE Band 2 10MHz QPSK 1RB CH-High

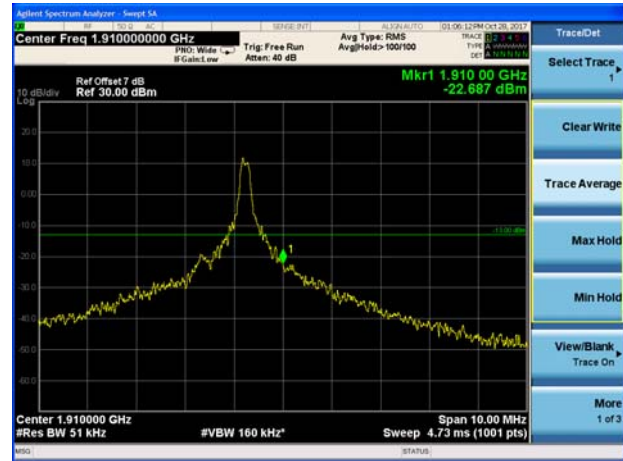

LTE Band 2 10MHz QPSK 100%RB CH-Low

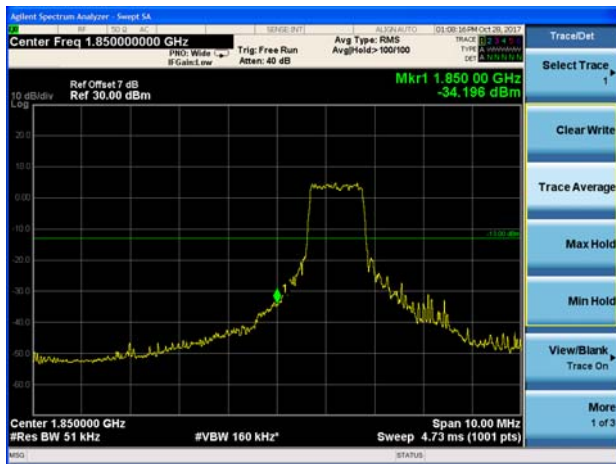

LTE Band 2 10MHz QPSK 100%RB CH-High



LTE Band 2 15MHz QPSK 1RB CH-Low

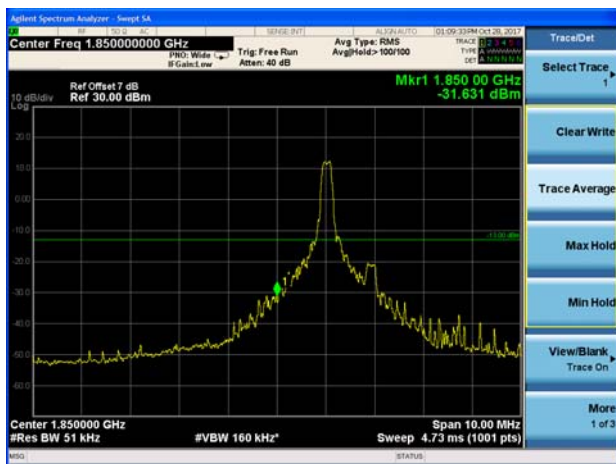

LTE Band 2 15MHz QPSK 1RB CH-High

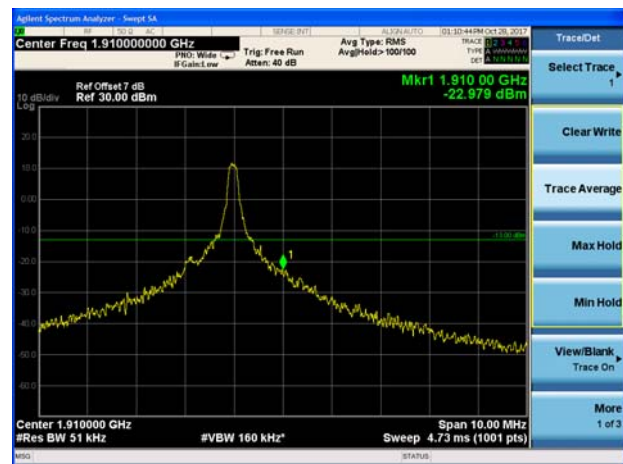

LTE Band 2 15MHz QPSK 100%RB CH-Low

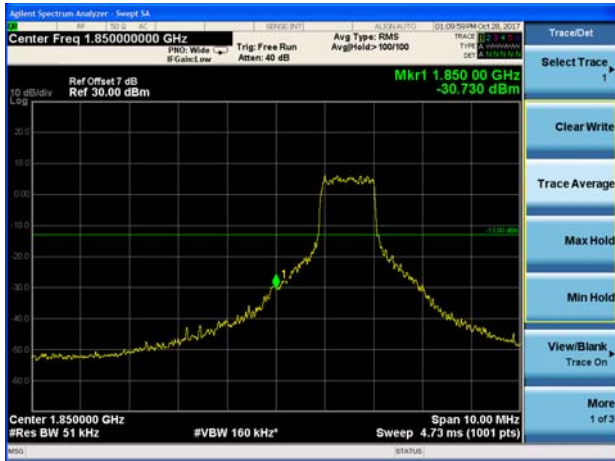

LTE Band 2 15MHz QPSK 100%RB CH-High

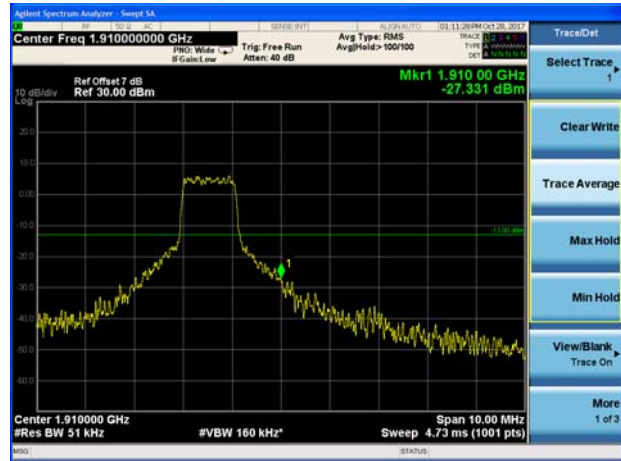

LTE Band 2 20MHz QPSK 1RB CH-Low

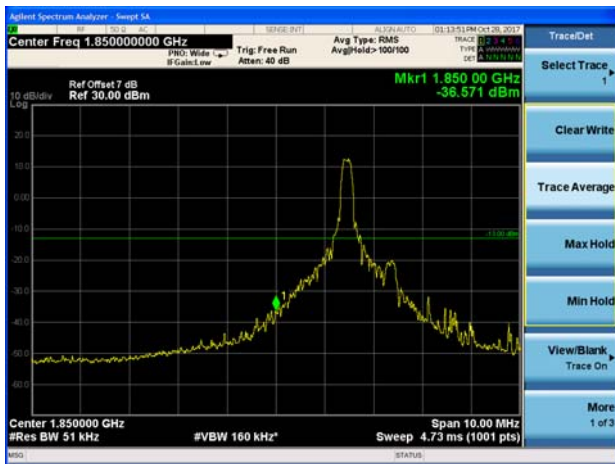

LTE Band 2 20MHz QPSK 1RB CH-High

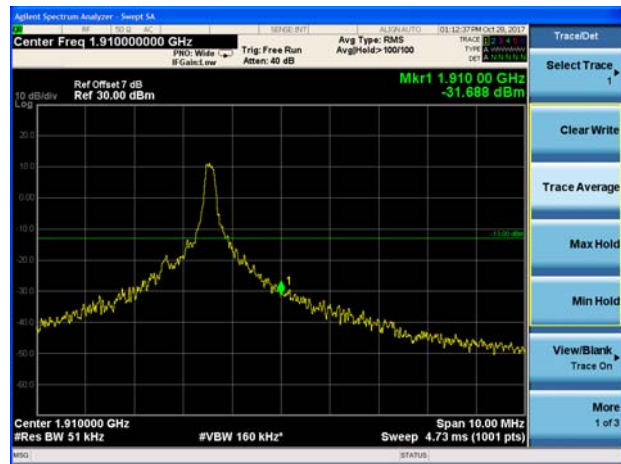

LTE Band 2 20MHz QPSK 100%RB CH-Low

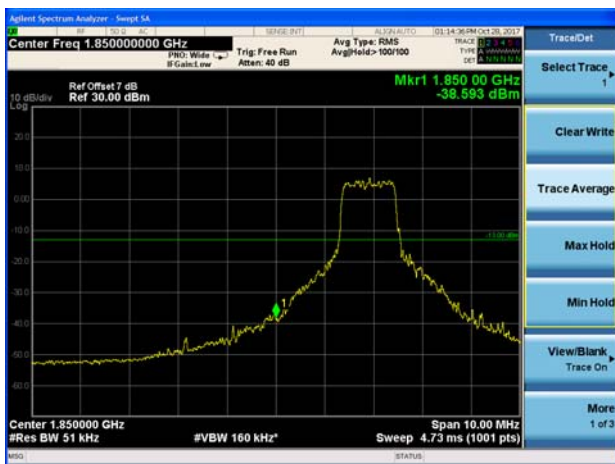

LTE Band 2 20MHz QPSK 100%RB CH-High

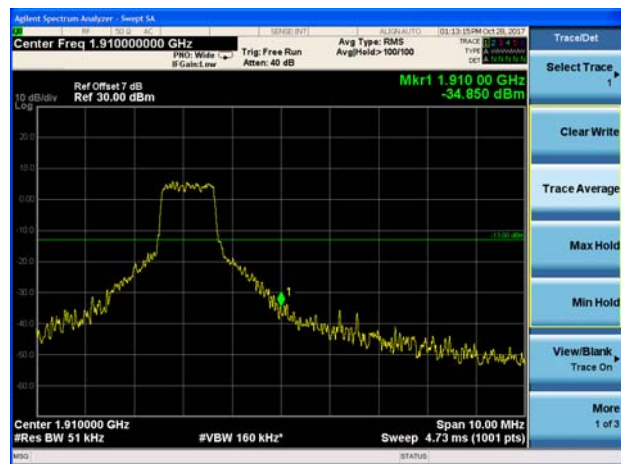

LTE Band 2 1.4MHz 16QAM 1RB CH-Low

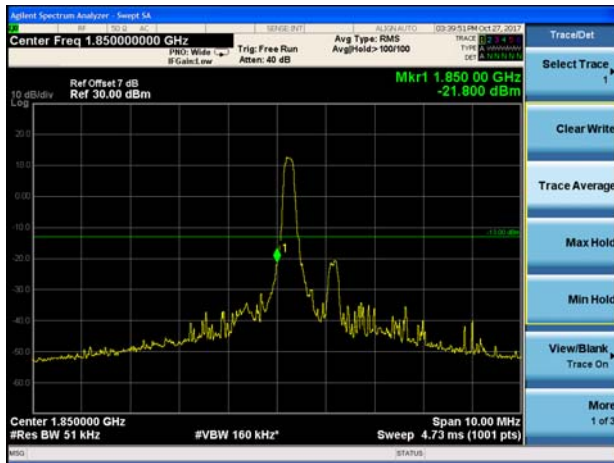

LTE Band 2 1.4MHz 16QAM 1RB CH-High

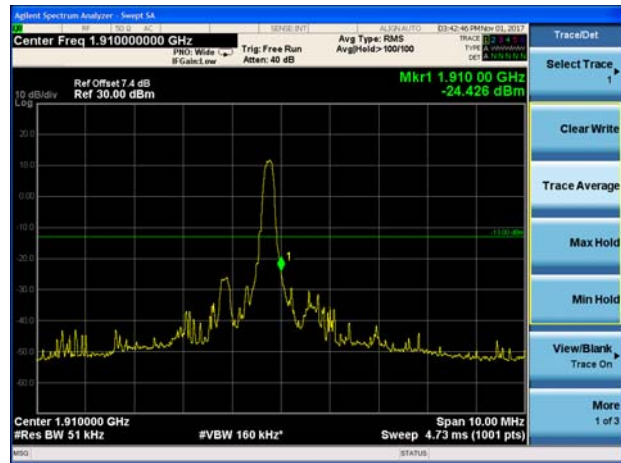

LTE Band 2 1.4MHz 16QAM 100%RB CH-Low

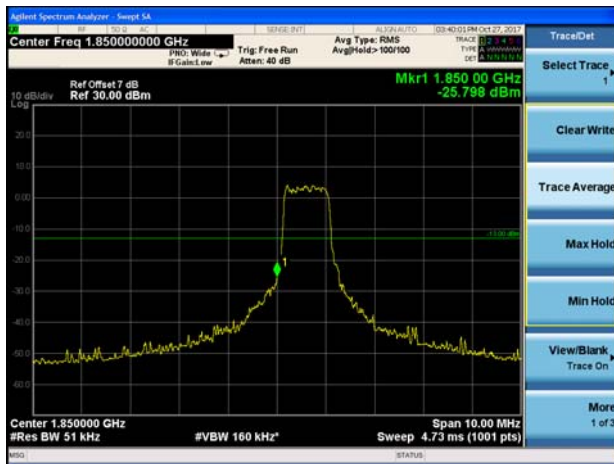

LTE Band 2 1.4MHz 16QAM 100%RB CH-High

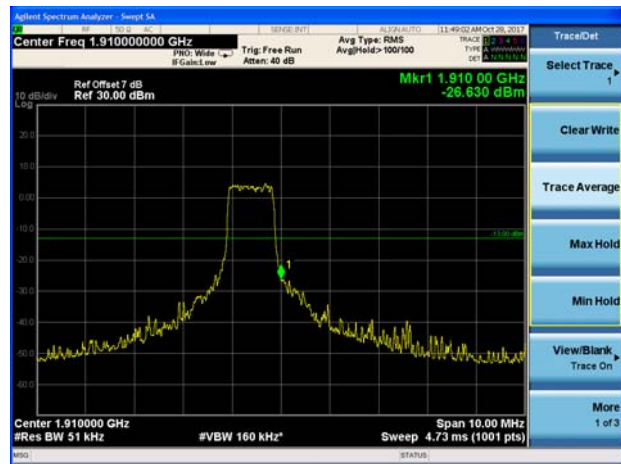

LTE Band 2 3MHz 16QAM 1RB CH-Low

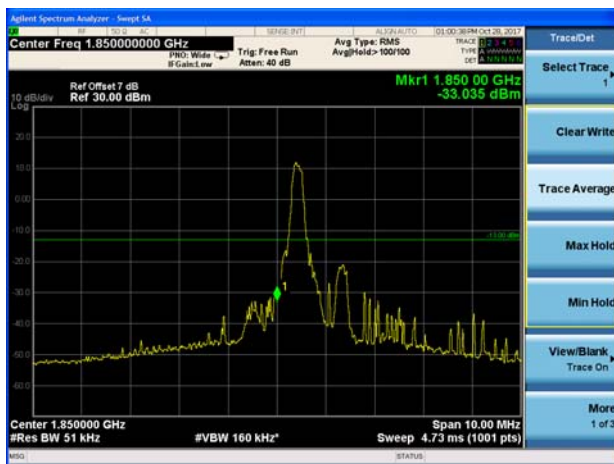

LTE Band 2 3MHz 16QAM 1RB CH-High

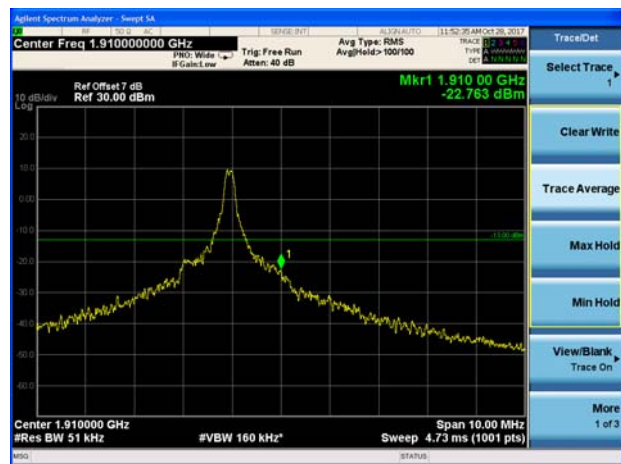

LTE Band 2 3MHz 16QAM 100%RB CH-Low

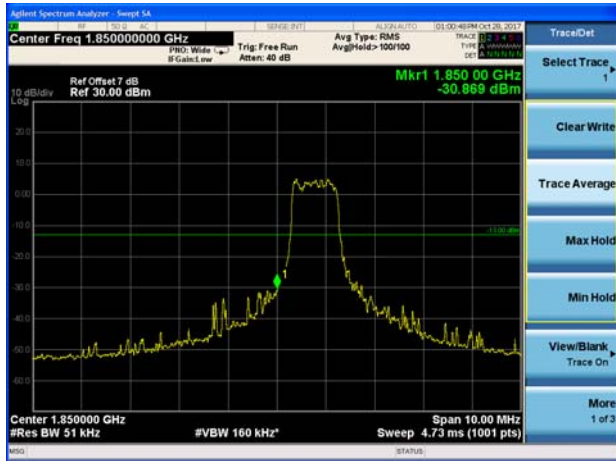

LTE Band 2 3MHz 16QAM 100%RB CH-High

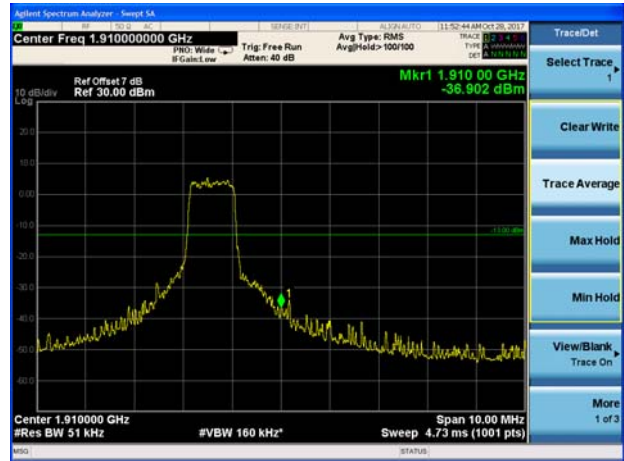

LTE Band 2 5MHz 16QAM 1RB CH-Low

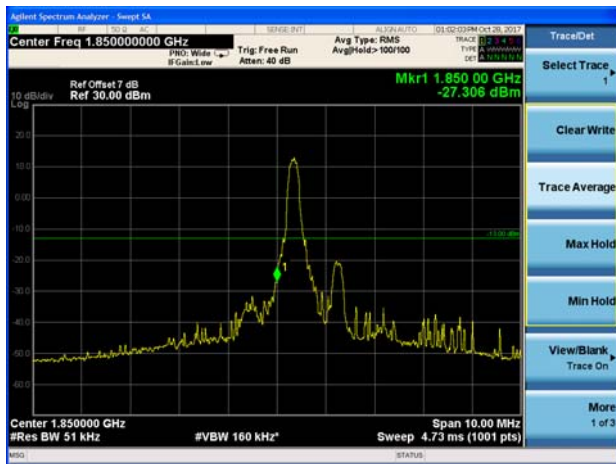

LTE Band 2 5MHz 16QAM 1RB CH-High

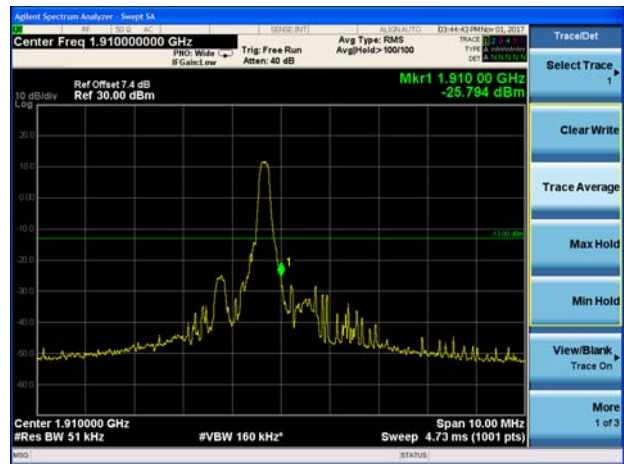

LTE Band 2 5MHz 16QAM 100%RB CH-Low

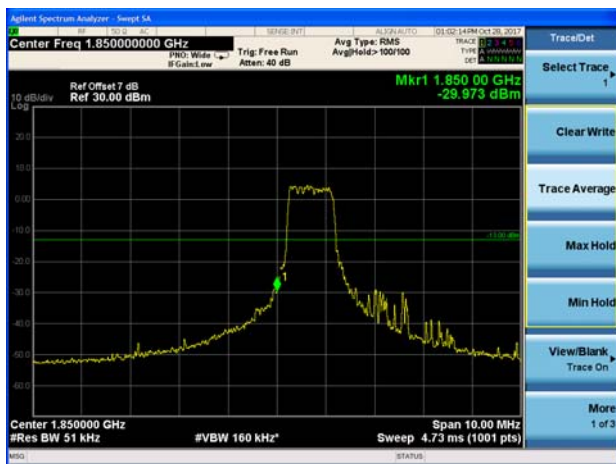

LTE Band 2 5MHz 16QAM 100%RB CH-High

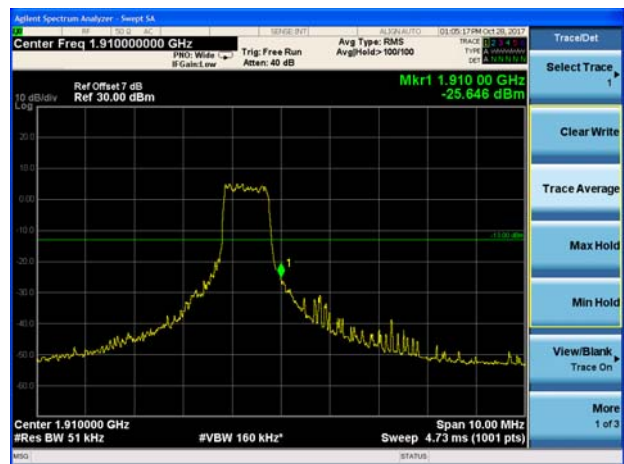

LTE Band 2 10MHz 16QAM 1RB CH-Low

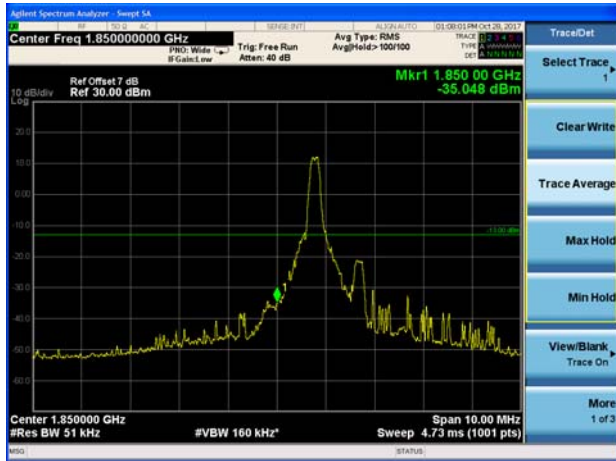

LTE Band 2 10MHz 16QAM 1RB CH-High

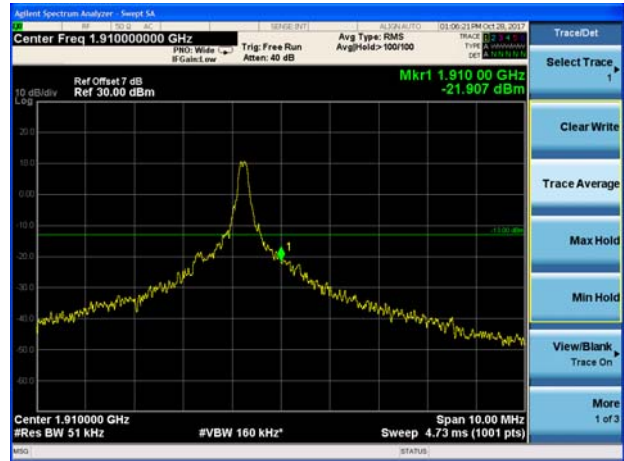

LTE Band 2 10MHz 16QAM 100%RB CH-Low

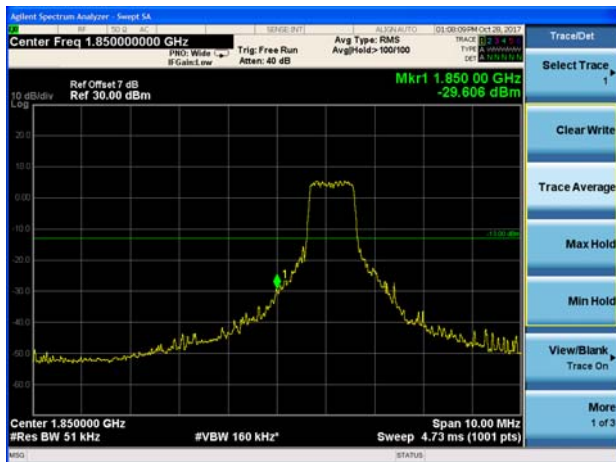

LTE Band 2 10MHz 16QAM 100%RB CH-High

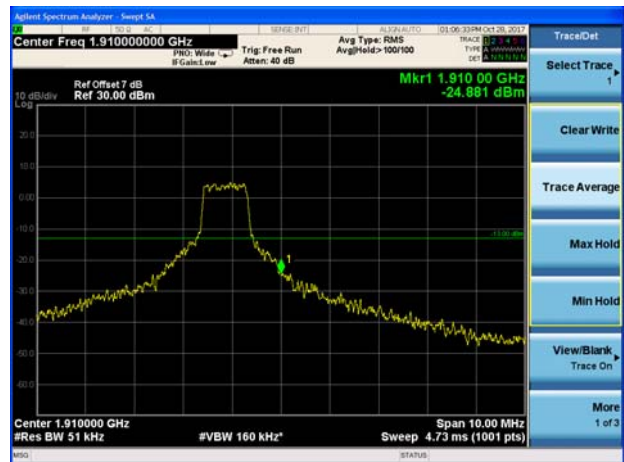

LTE Band 2 15MHz 16QAM 1RB CH-Low

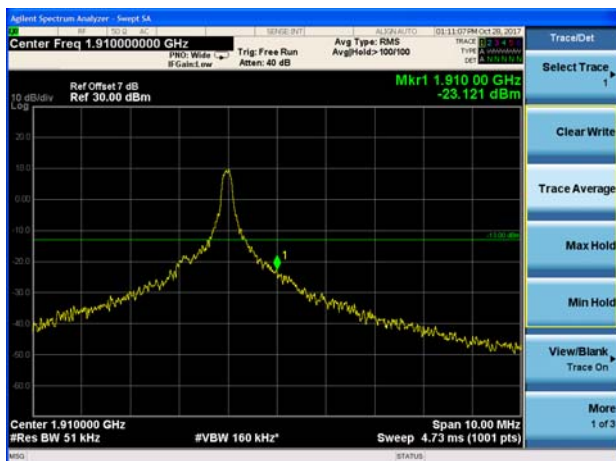

LTE Band 2 15MHz 16QAM 1RB CH-High

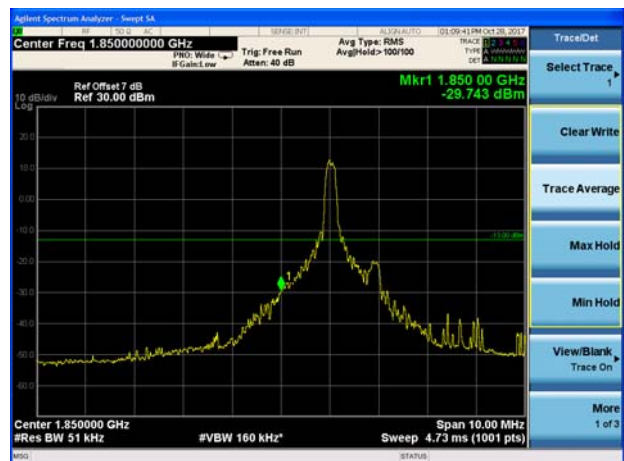

LTE Band 2 15MHz 16QAM 100%RB CH-Low



LTE Band 2 15MHz 16QAM 100%RB CH-High

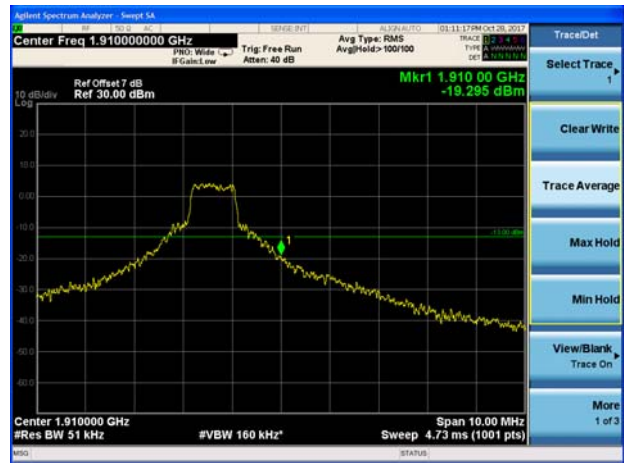

LTE Band 2 20MHz 16QAM 1RB CH-Low

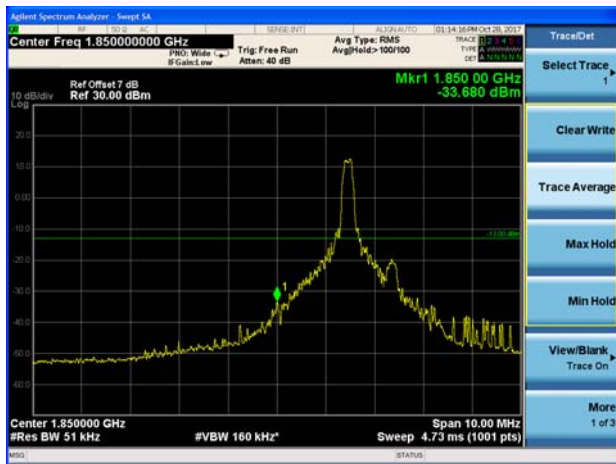

LTE Band 2 20MHz 16QAM 1RB CH-High

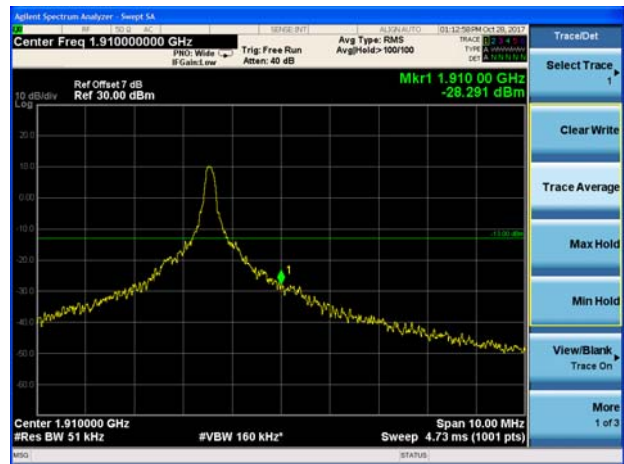

LTE Band 2 20MHz 16QAM 100%RB CH-Low

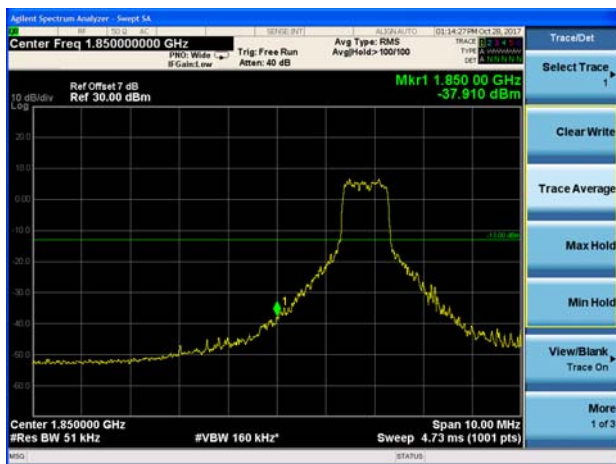

LTE Band 2 20MHz 16QAM 100%RB CH-High



5.5. Peak-to-Average Power Ratio (PAPR)

Ambient condition

Temperature	Relative humidity	Pressure
23°C ~25°C	45%~50%	101.5kPa

Methods of Measurement

Measure the total peak power and record as PPk. And measure the total average power and record as PAvg. Both the peak and average power levels must be expressed in the same logarithmic units (e.g., dBm). Determine the PAPR from:

$$PAPR (dB) = PPk (dBm) - PAvg (dBm).$$

Test Setup

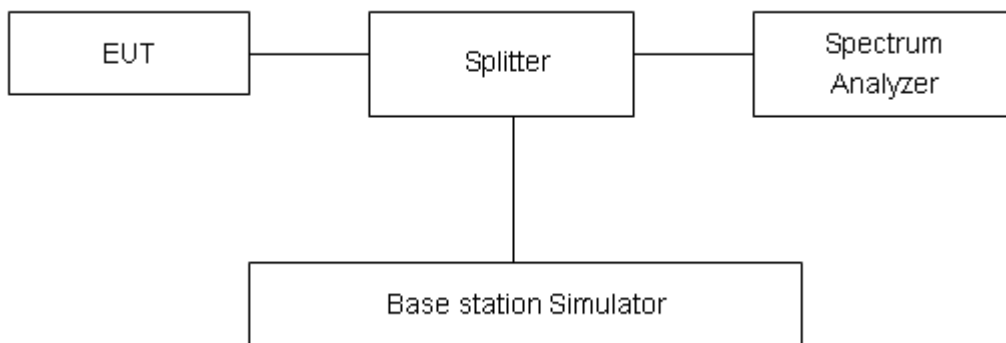

Limits

In measuring transmissions in this band using an average power technique, the peak-to-average ratio (PAR) of the transmission may not exceed 13 dB in 24.232(d).

Measurement Uncertainty

The assessed measurement uncertainty to ensure 95% confidence level for the normal distribution is with the coverage factor $k = 2$, $U = 0.4$ dB.

**Test Results**

Mode	Bandwidth	Modulation	Channel/ Frequency(MHz)	Peak-to-Average Power Ratio (PAPR)		
				Peak(dBm)	Avg(dBm)	PAPR(dB)
Band2	1.4MHz	QPSK	18900/1880	31.16	22.56	8.60
		16QAM	18900/1880	30.69	21.20	9.49
	3MHz	QPSK	18900/1880	32.50	22.30	10.20
		16QAM	18900/1880	32.87	21.81	11.06
	5MHz	QPSK	18900/1880	30.71	22.37	8.34
		16QAM	18900/1880	31.61	21.99	9.62
	10MHz	QPSK	18900/1880	30.74	22.26	8.48
		16QAM	18900/1880	31.11	22.13	8.98
	15MHz	QPSK	18900/1880	30.89	22.30	8.59
		16QAM	18900/1880	31.51	22.14	9.37
	20MHz	QPSK	18900/1880	31.49	22.61	8.88
		16QAM	18900/1880	31.62	22.46	9.16

5.6. Frequency Stability

Ambient condition

Temperature	Relative humidity	Pressure
23°C ~25°C	45%~50%	101.5kPa

Method of Measurement

1. Frequency Stability (Temperature Variation)

The temperature inside the climate chamber is varied from -40°C to +85°C in 10°C step size,

(1) With all power removed, the temperature was decreased to 0°C and permitted to stabilize for three hours.

(2) Measure the carrier frequency with the test equipment in a “call mode”. These measurements should be made within 1 minute of powering up the mobile station, to prevent significant self warming.

(3) Repeat the above measurements at 10°C increments from -40°C to +85°C. Allow at least 1.5 hours at each temperature, un-powered, before making measurements.

2. Frequency Stability (Voltage Variation)

The frequency stability shall be measured with variation of primary supply voltage as follows:

(1) Vary primary supply voltage from 85 to 115 percent of the nominal value for other than hand carried battery equipment.

(2) For hand carried, battery powered equipment, reduce primary supply voltage to the battery-operating end point which shall be specified by the manufacturer.

This transceiver is specified to operate with an input voltage of between 3.4 V and 4.2 V, with a nominal voltage of 3.8V.

Test setup

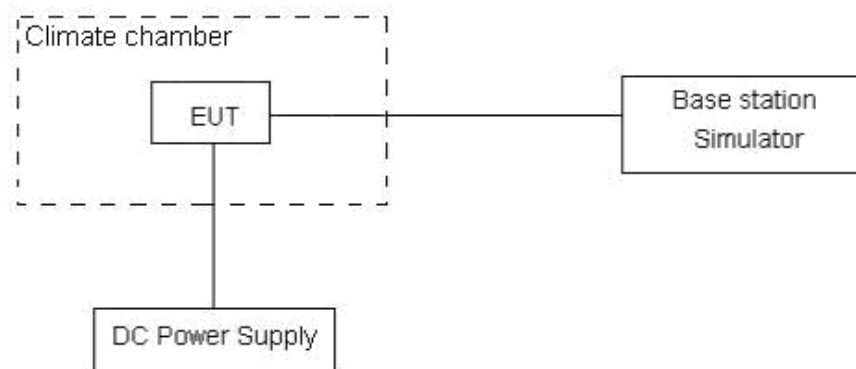

Limits

No specific frequency stability requirements in part 24.235

Measurement Uncertainty

The assessed measurement uncertainty to ensure 99.75% confidence level for the normal distribution is with the coverage factor $k = 3$, $U = 0.01\text{ppm}$.

Test Result

Mode	Bandwidth	Channel/ Frequency(MHz)	Test status	Frequency Stability (ppm)		
				QPSK	16QAM	
Band 2	1.4MHz	18900/1880	-40°C/Normal Voltage	-0.00042	-0.00021	
		18900/1880	-30°C/Normal Voltage	-0.00166	-0.00350	
		18900/1880	-20°C/Normal Voltage	-0.00224	-0.00180	
		18900/1880	-10°C/Normal Voltage	-0.00280	-0.00228	
		18900/1880	0°C/Normal Voltage	-0.00185	0.00029	
		18900/1880	10°C/Normal Voltage	0.00022	-0.00046	
		18900/1880	20°C/Normal Voltage	0.00052	-0.00237	
		18900/1880	30°C/Normal Voltage	-0.00327	-0.00096	
		18900/1880	40°C/Normal Voltage	-0.00087	-0.00224	
		18900/1880	50°C/Normal Voltage	-0.00228	-0.00097	
		18900/1880	60°C/Normal Voltage	0.00010	-0.00014	
		18900/1880	70°C/Normal Voltage	-0.00124	0.00226	
		18900/1880	80°C/Normal Voltage	0.00142	-0.00067	
		18900/1880	85°C/Normal Voltage	-0.00051	-0.00098	
		18900/1880	20°C/Maximum Voltage	-0.00138	-0.00168	
		18900/1880	20°C/Maximum Voltage	-0.00274	-0.00374	
	18900/1880	3MHz	18900/1880	-40°C/Normal Voltage	-0.00148	-0.00238
	18900/1880		-30°C/Normal Voltage	-0.00132	-0.00139	
	18900/1880		-20°C/Normal Voltage	-0.00285	-0.00219	
	18900/1880		-10°C/Normal Voltage	-0.00266	-0.00037	
	18900/1880		0°C/Normal Voltage	-0.00494	-0.00133	
	18900/1880		10°C/Normal Voltage	-0.00122	-0.00160	
	18900/1880		20°C/Normal Voltage	-0.00244	-0.00274	
	18900/1880		30°C/Normal Voltage	-0.00155	-0.00031	
	18900/1880		40°C/Normal Voltage	-0.00166	-0.00010	
	18900/1880		50°C/Normal Voltage	-0.00368	-0.00041	
	18900/1880		60°C/Normal Voltage	-0.00084	-0.00158	
	18900/1880		70°C/Normal Voltage	-0.00036	-0.00045	
	18900/1880		80°C/Normal Voltage	-0.00006	-0.00116	
	18900/1880		85°C/Normal Voltage	-0.00020	-0.00140	
	18900/1880		20°C/Minimum Voltage	-0.00271	-0.00232	
	18900/1880		20°C/Maximum Voltage	-0.00225	-0.00126	
	18900/1880	5MHz	18900/1880	-40°C/Normal Voltage	-0.00263	-0.00203
	18900/1880		-30°C/Normal Voltage	-0.00188	-0.00488	
	18900/1880		-20°C/Normal Voltage	-0.00076	-0.00509	
	18900/1880		-10°C/Normal Voltage	-0.00143	0.00178	
18900/1880	0°C/Normal Voltage		-0.00045	-0.00099		
18900/1880	10°C/Normal Voltage		-0.00343	-0.00439		



		18900/1880	20°C/Normal Voltage	-0.00064	-0.00038	
		18900/1880	30°C/Normal Voltage	0.00106	-0.00089	
		18900/1880	40°C/Normal Voltage	-0.00287	-0.00361	
		18900/1880	50°C/Normal Voltage	-0.00016	-0.00330	
		18900/1880	60°C/Normal Voltage	-0.00011	-0.00258	
		18900/1880	70°C/Normal Voltage	-0.00174	-0.00210	
		18900/1880	80°C/Normal Voltage	-0.00112	-0.00151	
		18900/1880	85°C/Normal Voltage	-0.00205	-0.00174	
		18900/1880	20°C/Minimum Voltage	0.00053	-0.00569	
		18900/1880	20°C/Maximum Voltage	0.00019	-0.00165	
	10MHz	18900/1880	-40°C/Normal Voltage	0.00026	0.00053	
		18900/1880	-30°C/Normal Voltage	-0.00359	0.00011	
		18900/1880	-20°C/Normal Voltage	-0.00544	-0.00438	
		18900/1880	-10°C/Normal Voltage	-0.00308	-0.00307	
		18900/1880	0°C/Normal Voltage	-0.00084	-0.00616	
		18900/1880	10°C/Normal Voltage	-0.00345	-0.00610	
		18900/1880	20°C/Normal Voltage	-0.00327	-0.00194	
		18900/1880	30°C/Normal Voltage	-0.00044	-0.00405	
		18900/1880	40°C/Normal Voltage	0.00014	-0.00495	
		18900/1880	50°C/Normal Voltage	-0.00097	-0.00173	
		18900/1880	60°C/Normal Voltage	-0.00170	-0.00110	
		18900/1880	70°C/Normal Voltage	-0.00056	-0.00156	
		18900/1880	80°C/Normal Voltage	0.00109	-0.00103	
		18900/1880	85°C/Normal Voltage	-0.00140	-0.00153	
		18900/1880	20°C/Minimum Voltage	-0.00243	-0.00114	
		18900/1880	20°C/Maximum Voltage	-0.00178	-0.00159	
		15MHz	18900/1880	-40°C/Normal Voltage	-0.00191	-0.01311
			18900/1880	-30°C/Normal Voltage	-0.00261	-0.00380
	18900/1880		-20°C/Normal Voltage	-0.00679	-0.02143	
	18900/1880		-10°C/Normal Voltage	-0.00220	-0.00245	
	18900/1880		0°C/Normal Voltage	-0.00364	-0.00101	
	18900/1880		10°C/Normal Voltage	-0.00002	-0.00170	
	18900/1880		20°C/Normal Voltage	-0.00134	-0.01294	
	18900/1880		30°C/Normal Voltage	-0.00095	-0.01999	
	18900/1880		40°C/Normal Voltage	-0.00190	-0.00136	
18900/1880	50°C/Normal Voltage		-0.00428	-0.00381		
18900/1880	60°C/Normal Voltage		-0.00105	-0.00139		
18900/1880	70°C/Normal Voltage		-0.00073	-0.00103		
18900/1880	80°C/Normal Voltage		-0.00063	-0.00040		
18900/1880	85°C/Normal Voltage		-0.00050	-0.00009		
18900/1880	20°C/Minimum Voltage		-0.00532	-0.00069		
18900/1880	20°C/Maximum Voltage	0.00289	-0.01901			
20MHz	18900/1880	-40°C/Normal Voltage	-0.00218	-0.02119		



	18900/1880	-30°C/Normal Voltage	-0.00020	-0.00286
	18900/1880	-20°C/Normal Voltage	0.00442	-0.00344
	18900/1880	-10°C/Normal Voltage	0.00863	-0.00287
	18900/1880	0°C/Normal Voltage	-0.00034	-0.02299
	18900/1880	10°C/Normal Voltage	-0.00420	-0.02372
	18900/1880	20°C/Normal Voltage	-0.00105	-0.01876
	18900/1880	30°C/Normal Voltage	-0.00031	-0.00026
	18900/1880	40°C/Normal Voltage	0.00278	-0.00364
	18900/1880	50°C/Normal Voltage	-0.00087	-0.00468
	18900/1880	60°C/Normal Voltage	-0.00180	-0.00185
	18900/1880	70°C/Normal Voltage	-0.00155	-0.00086
	18900/1880	80°C/Normal Voltage	-0.00527	-0.00014
	18900/1880	85°C/Normal Voltage	-0.00436	-0.00156
	18900/1880	20°C/Minimum Voltage	-0.00122	-0.00290
	18900/1880	20°C/Maximum Voltage	0.00126	-0.01399

5.7. Spurious Emissions at Antenna Terminals

Ambient condition

Temperature	Relative humidity	Pressure
23°C ~25°C	45%~50%	101.5kPa

Method of Measurement

The EUT was connected to Spectrum Analyzer and Base Station Simulator via power Splitter. The measurement is carried out using a spectrum analyzer. The spectrum analyzer scans from 9kHz to the 10th harmonic of the carrier. The peak detector is used.set RBW 1MHz and VBW is 3MHz, Sweep is set to ATUO.

Test setup

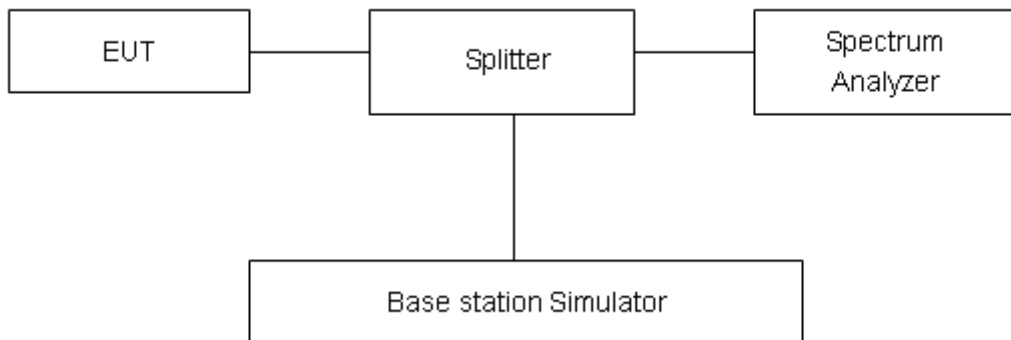

Limits

Rule Part 24.238(a) specifies that “on any frequency outside a licensee’s frequency block, the power of any emission shall be attenuated below the transmitter power (P) by at least 43 + 10 log₁₀ (P) dB.”

Limit	-13 dBm

Measurement Uncertainty

The assessed measurement uncertainty to ensure 99.75% confidence level for the normal distribution is with the coverage factor $k = 1.96$.

Frequency	Uncertainty
100kHz-2GHz	0.684 dB
2GHz-18GHz	1.407 dB



Test Result

Sweep from 9 kHz to 30MHz, and the emissions more than 20 dB below the permissible value are not reported.

If disturbances were found more than 20dB below limit line, the mark is not required for the EUT.

The signal beyond the limit is carrier.

Test Data File Name	Frequency (MHz)	Peak (dBm)	Limit (dBm)	Margin (dB)
LTE B2_CHLOW_1.4M_RB1_3-18GHz	9251.0	-24.15	-13.00	11.15
LTE B2_CHMID_1.4M_RB1_0.03-18GHz	9397.5	-26.49	-13.00	13.49
LTE B2_CHHIGH_1.4M_RB1_0.03-18GHz	5728.1	-20.01	-13.00	7.01
LTE B2_CHHIGH_3M_RB1_0.03-18GHz	5728.1	-19.16	-13.00	6.16
LTE B2_CHHIGH_5M_RB1_0.03-18GHz	9526.9	-25.97	-13.00	12.97
LTE B2_CHHIGH_10M_RB1_0.03-18GHz	9504.4	-26.20	-13.00	13.20
LTE B2_CHLOW_15M_RB1_0.03-18GHz	5591.3	-17.24	-13.00	4.24
LTE B2_CHHIGH_15M_RB1_0.03-18GHz	5726.5	-20.67	-13.00	7.67
LTE B2_CHLOW_20M_RB1_0.03-18GHz	6667.5	-28.40	-13.00	15.40
LTE B2_CHHIGH_20M_RB1_0.03-18GHz	5673.8	-18.58	-13.00	5.58

LTE Band 2 1.4MHz CH-Low 30MHz~3GHz

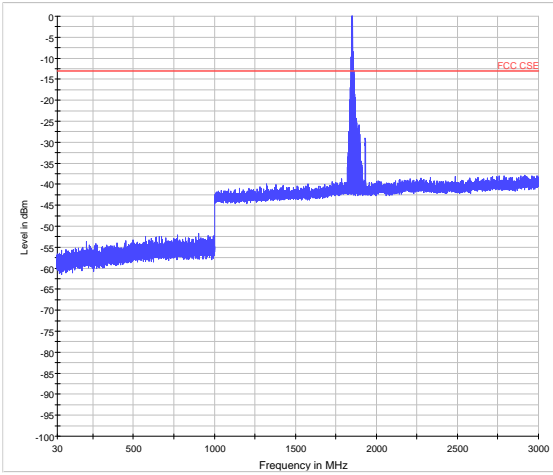

LTE Band 2 1.4MHz CH-Low 3GHz~18GHz

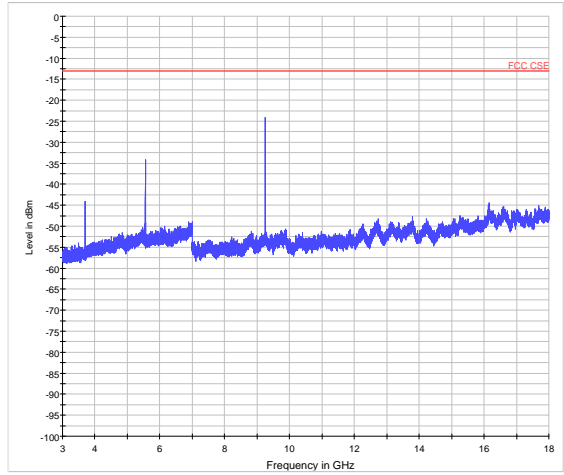

LTE Band 2 1.4MHz CH-Low 18GHz~20GHz

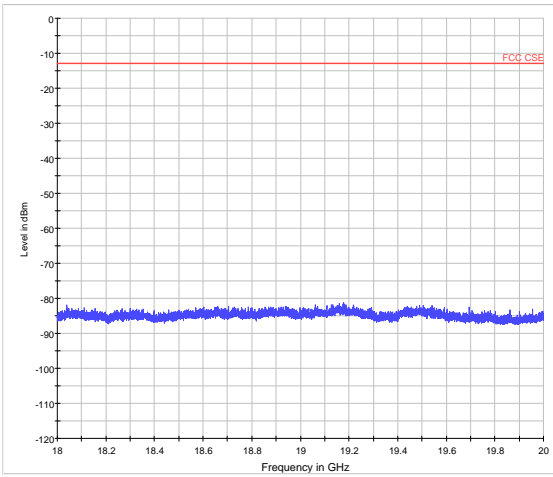

LTE Band 2 1.4MHz CH-Middle 30MHz~18GHz

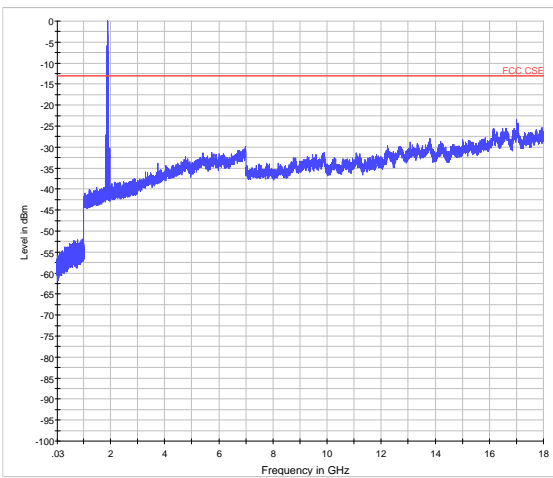

LTE Band 2 1.4MHz CH-Middle 18GHz~20GHz

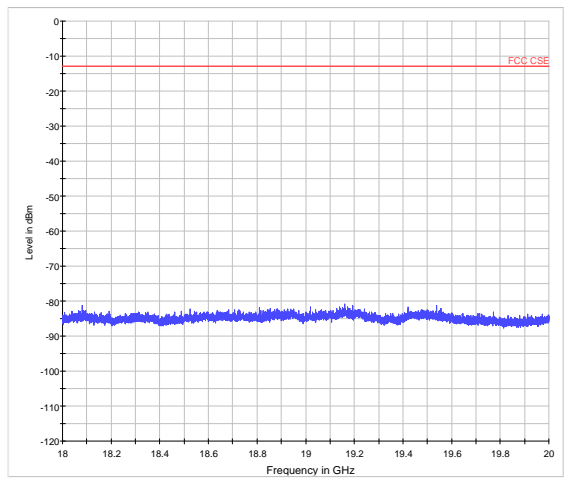



LTE Band 2 1.4MHz CH-High 30MHz~18GHz

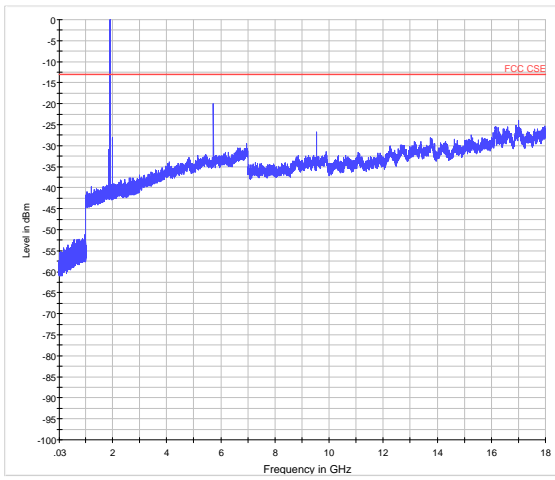

LTE Band 2 1.4MHz CH-High 18GHz~20GHz

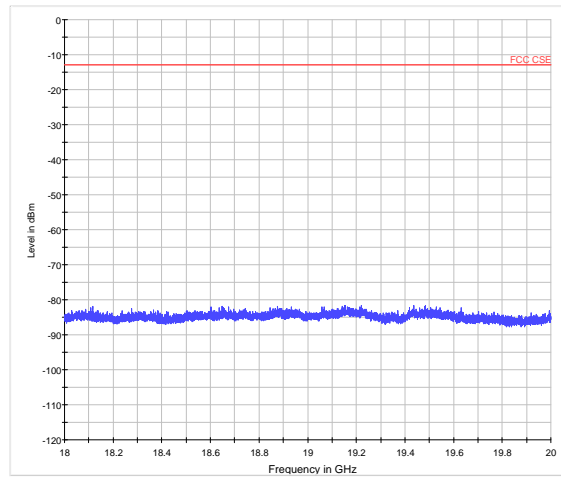

LTE Band 2 3MHz CH-Low 30MHz~18GHz

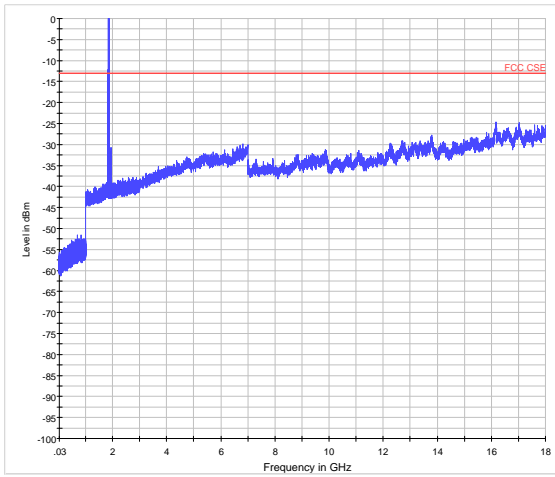

LTE Band 2 3MHz CH-Low 18GHz~20GHz

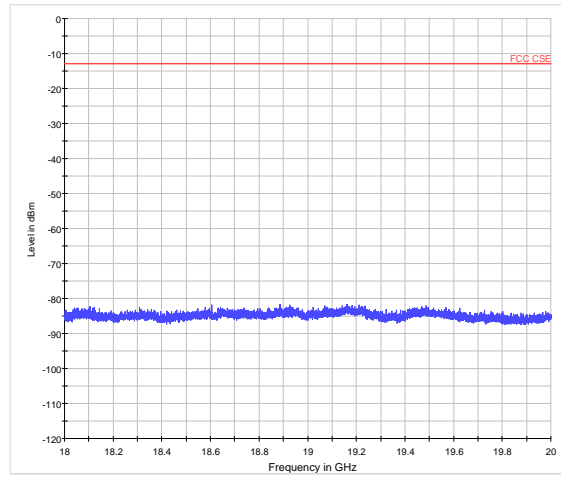

LTE Band 2 3MHz CH-Middle 30MHz~18GHz

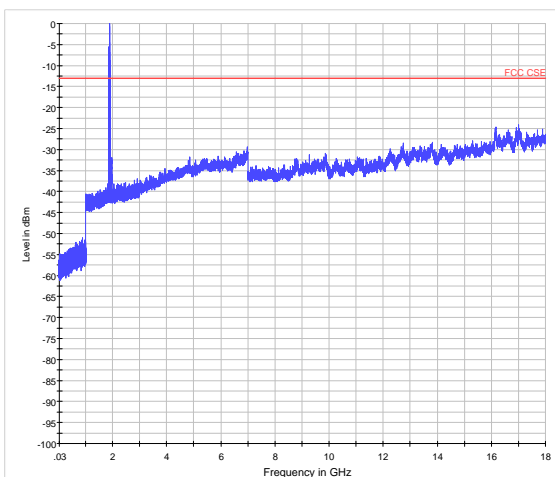

LTE Band 2 3MHz CH-Middle 18GHz~20GHz

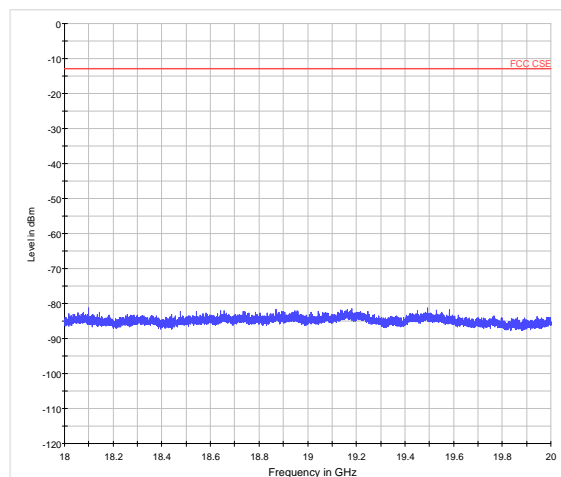

LTE Band 2 3MHz CH-High 30MHz~18GHz

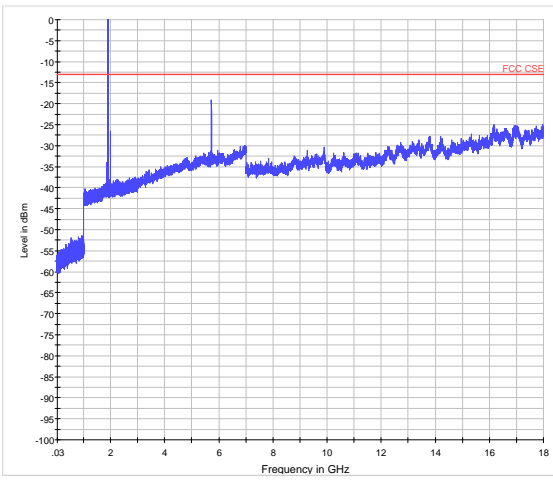

LTE Band 2 3MHz CH-High 18GHz~20GHz

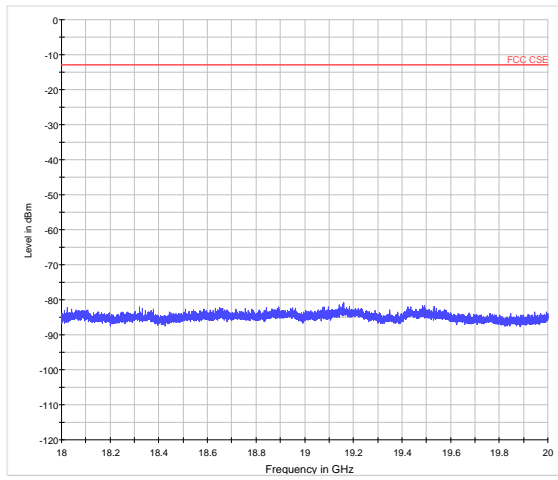

LTE Band 2 5MHz CH-Low 30MHz~18GHz

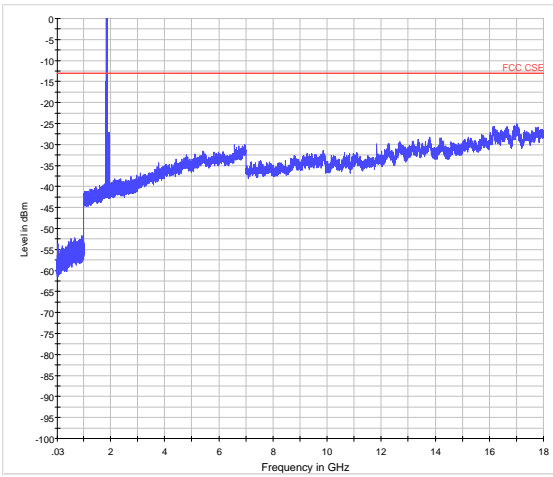

LTE Band 2 5MHz CH-Low 18GHz~20GHz

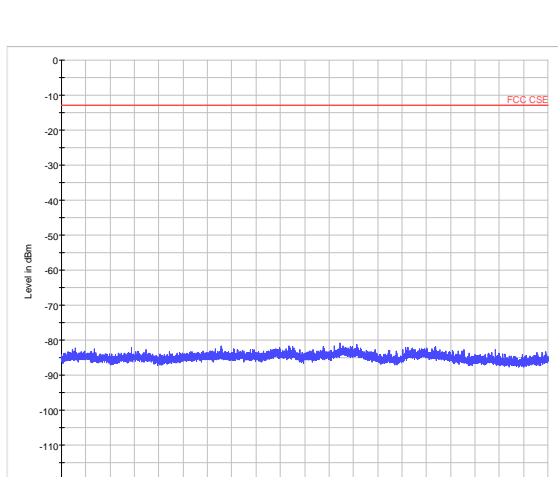

LTE Band 2 5MHz CH-Middle 30MHz~18GHz

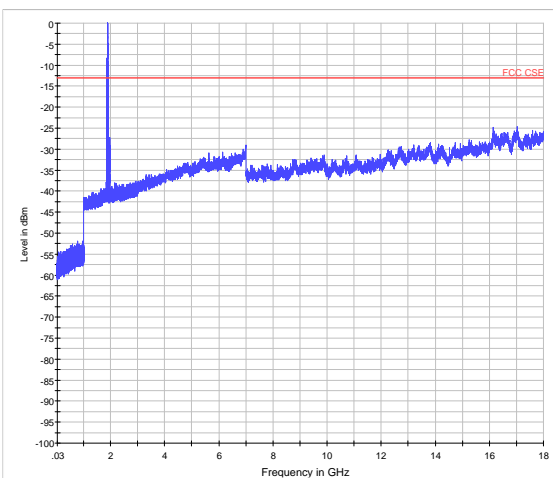

LTE Band 2 5MHz CH-Middle 18GHz~20GHz

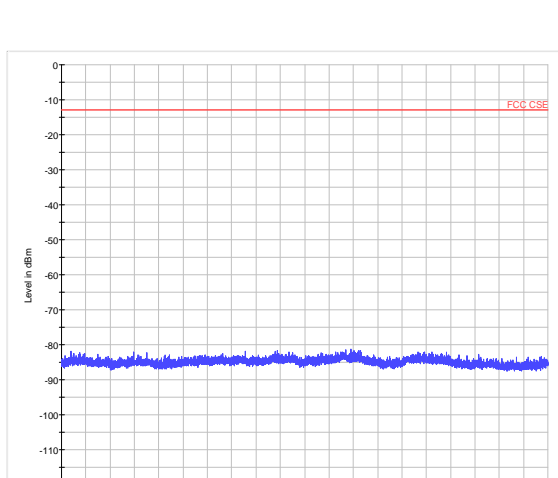



LTE Band 2 5MHz CH-High 30MHz~18GHz

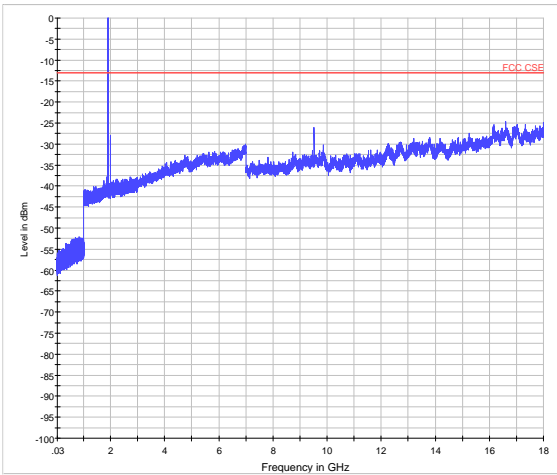

LTE Band 2 5MHz CH-High 18GHz~20GHz

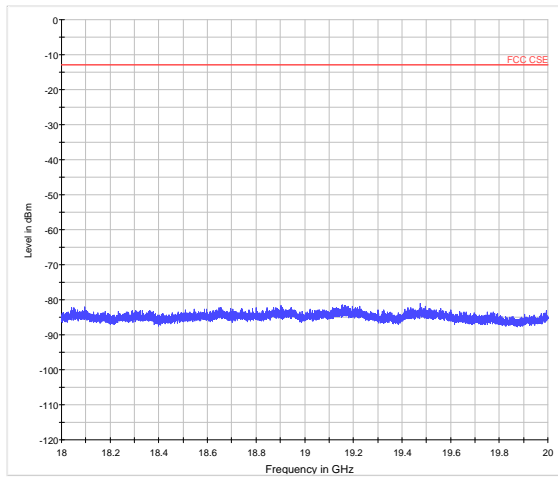

LTE Band 2 10MHz CH-Low 30MHz~18GHz

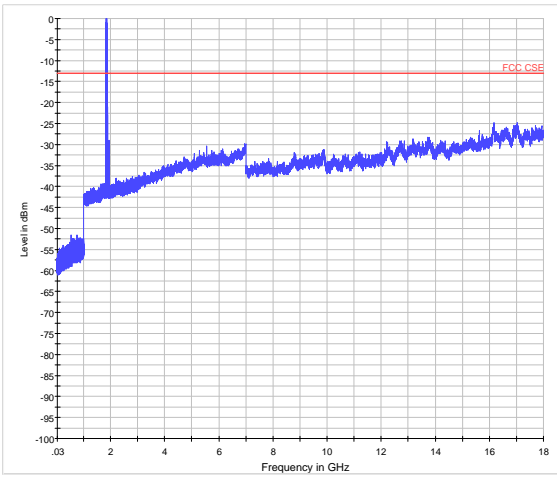

LTE Band 2 10MHz CH-Low 18GHz~20GHz

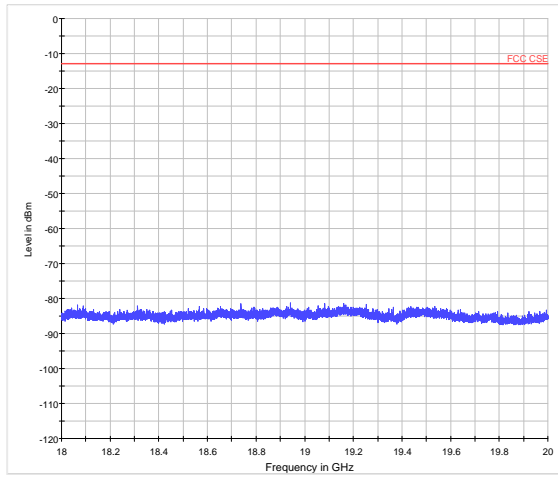

LTE Band 2 10MHz CH-Middle 30MHz~18GHz

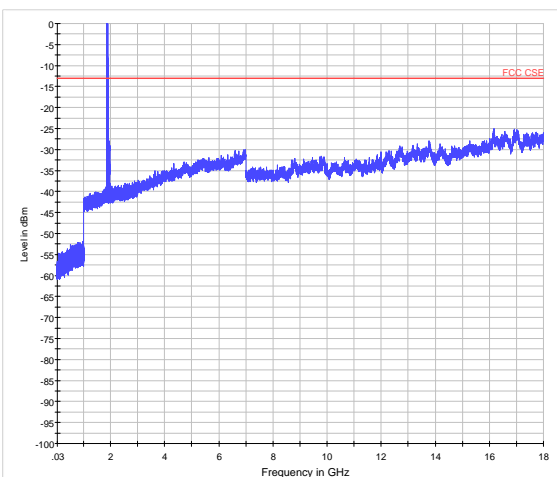

LTE Band 2 10MHz CH-Middle 18GHz~20GHz

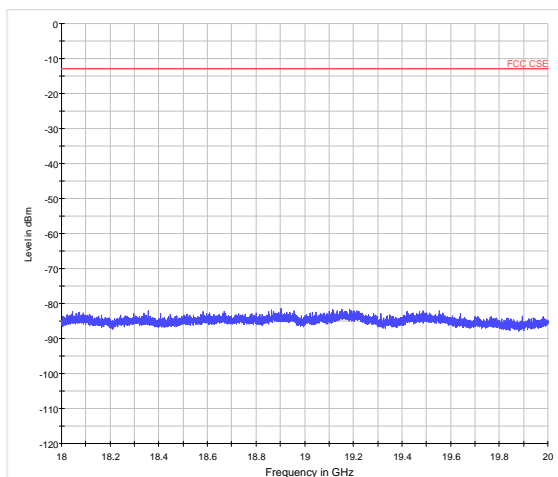



LTE Band 2 10MHz CH-High 30MHz~18GHz

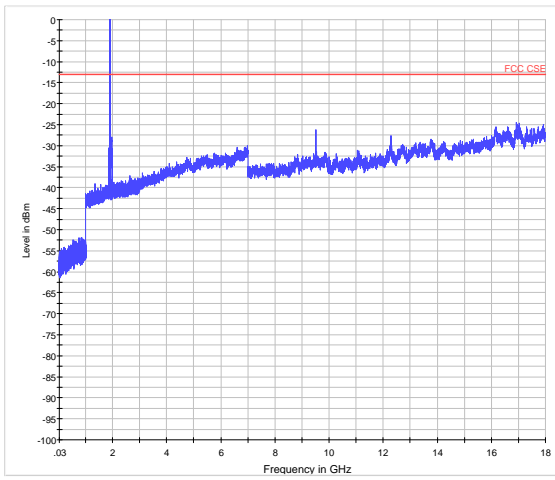

LTE Band 2 10MHz CH-High 18GHz~20GHz

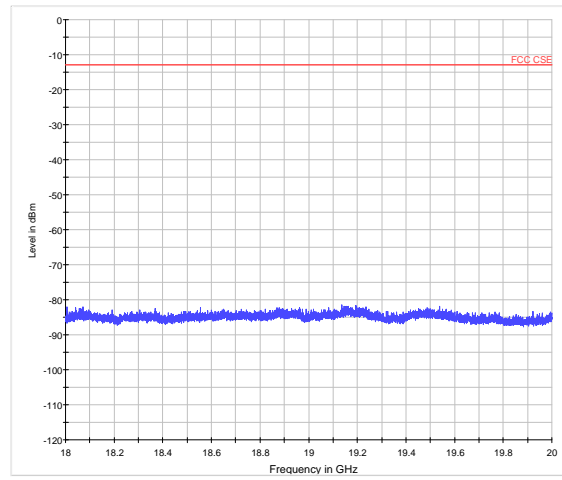

LTE Band 2 15MHz CH-Low 30MHz~18GHz

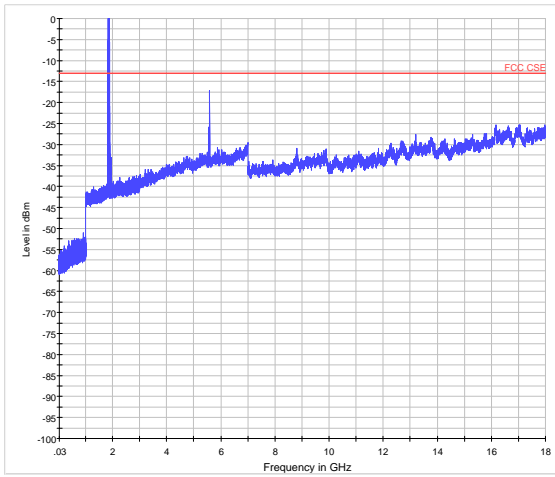

LTE Band 2 15MHz CH-Low 18GHz~20GHz

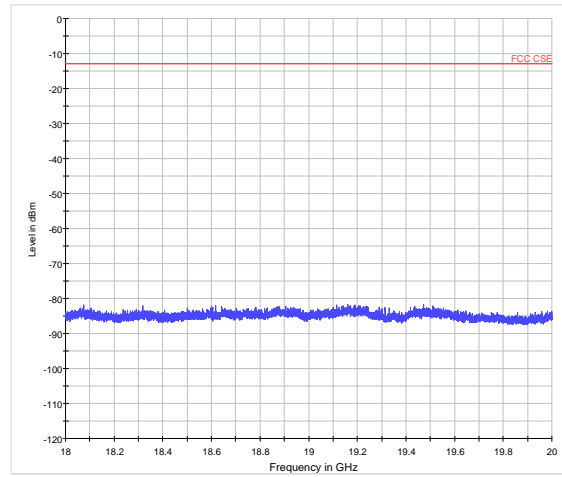

LTE Band 2 15MHz CH-Middle 30MHz~18GHz

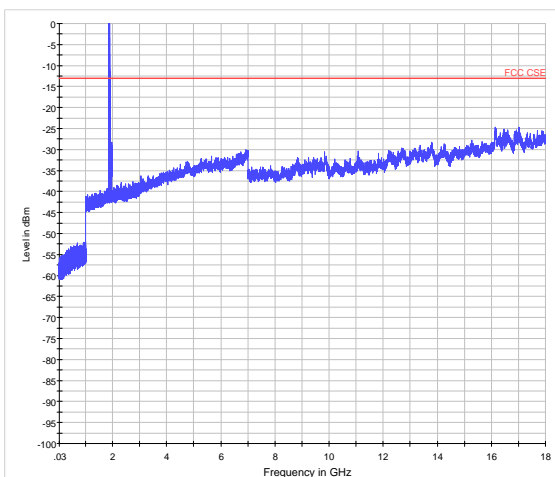

LTE Band 2 15MHz CH-Middle 18GHz~20GHz

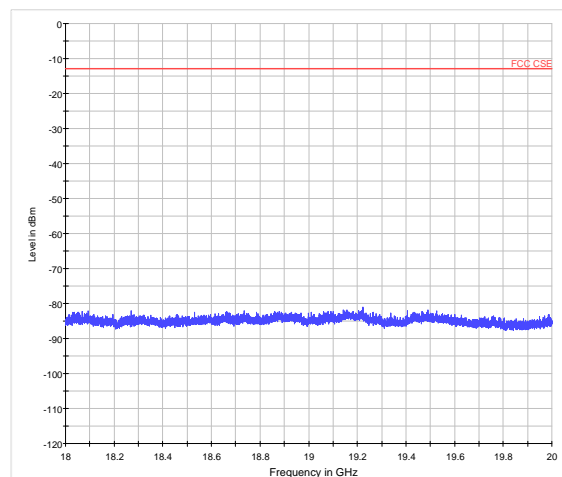



LTE Band 2 15MHz CH-High 30MHz~18GHz

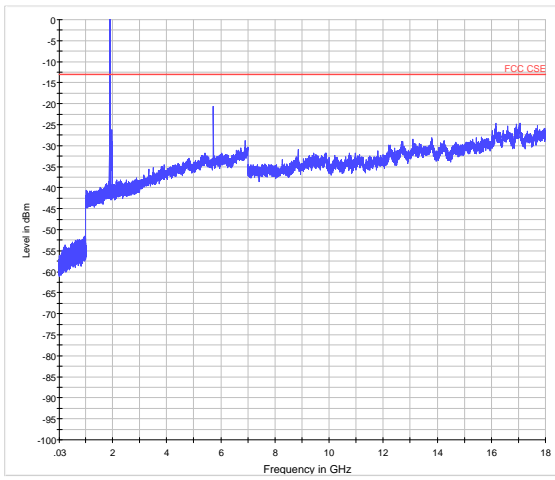

LTE Band 2 15MHz CH-High 18GHz~20GHz

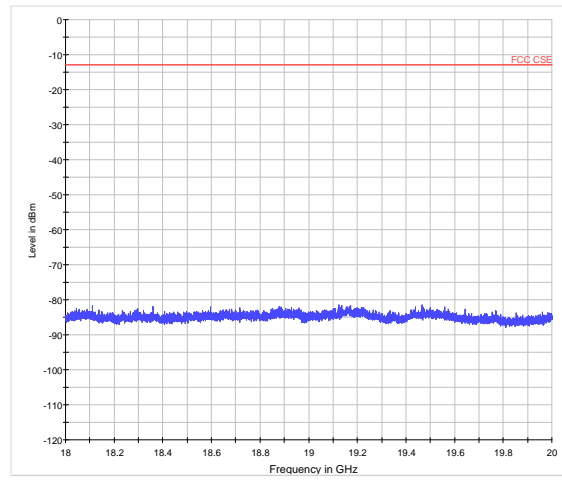

LTE Band 2 20MHz CH-Low 30MHz~18GHz

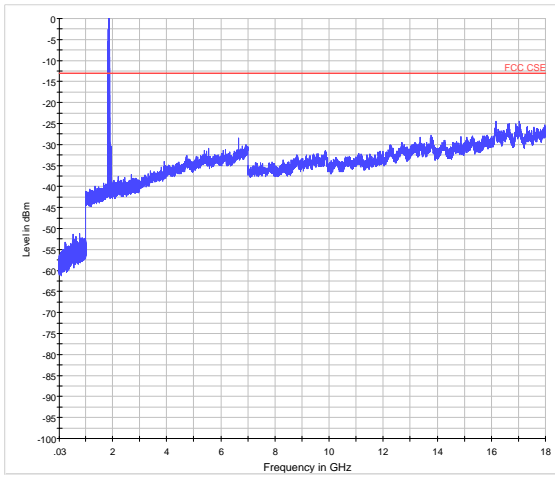

LTE Band 2 20MHz CH-Low 18GHz~20GHz

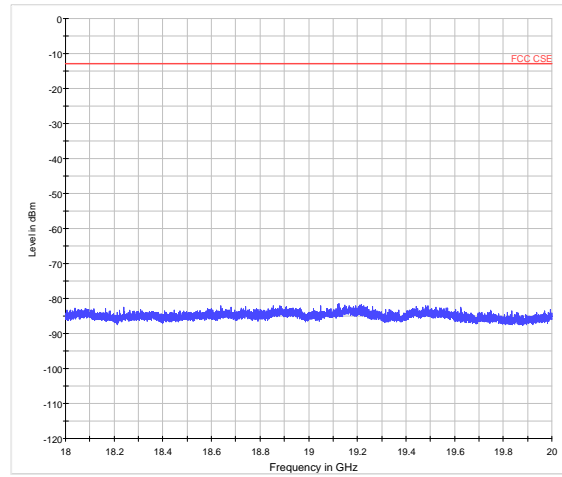

LTE Band 2 20MHz CH-Middle 30MHz~18GHz

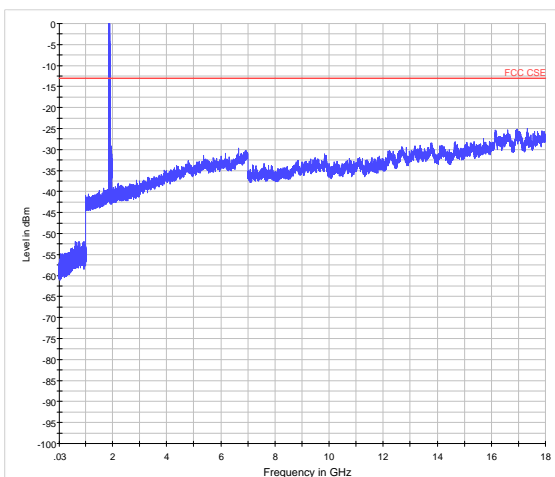

LTE Band 2 20MHz CH-Middle 18GHz~20GHz

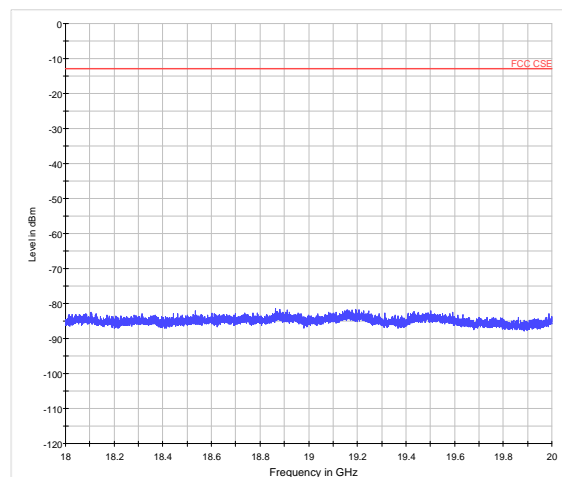



LTE Band 2 20MHz CH-High 30MHz~18GHz

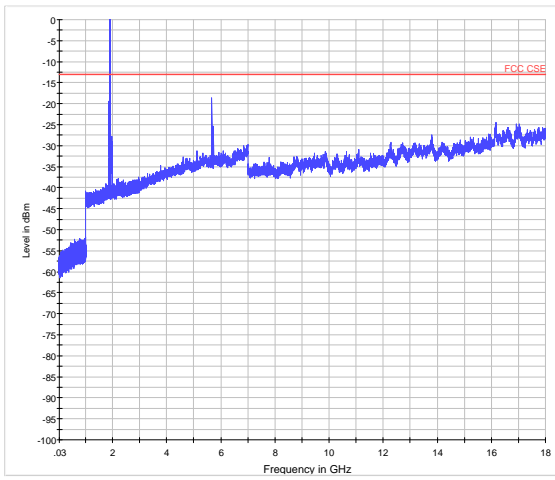

LTE Band 2 20MHz CH-High 18GHz~20GHz

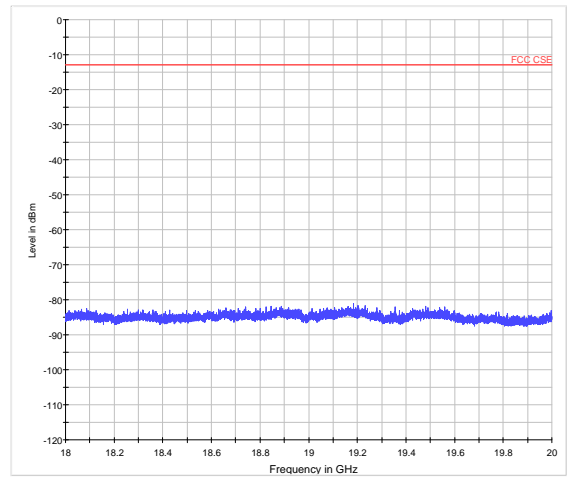

5.8. Radiates Spurious Emission

Ambient condition

Temperature	Relative humidity	Pressure
23°C ~25°C	45%~50%	101.5kPa

Method of Measurement

1. The testing follows FCC KDB 971168 v02r02 Section 5.8 and ANSI/TIA-603-D-2010.
2. The EUT is placed on a turntable 0.8 meters above the ground in the chamber, 3 meter away from the antenna. The maximal emission value is acquired by adjusting the antenna height, polarisation and turntable azimuth. Normally, the height range of antenna is 1 m to 4 m, the azimuth range of turntable is 0° to 360°, and the receive antenna has two polarizations Vertical (V) and Horizontal (H).
3. A log-periodic antenna or double-ridged waveguide horn antenna shall be substituted in place of the EUT. The log-periodic antenna will be driven by a signal generator and the level will be adjusted till the same power value on the spectrum analyzer or receiver. The level of the spurious emissions can be calculated through the level of the signal generator, cable loss, the gain of the substitution antenna and the reading of the spectrum analyzer or receiver.
4. The EUT is then put into continuously transmitting mode at its maximum power level during the test. Set Test Receiver or Spectrum RBW=1MHz, VBW=3MHz, And the maximum value of the receiver should be recorded as (Pr).
5. The EUT shall be replaced by a substitution antenna. In the chamber, an substitution antenna for the frequency band of interest is placed at the reference point of the chamber. An RF Signal source for the frequency band of interest is connected to the substitution antenna with a cable that has been constructed to not interfere with the radiation pattern of the antenna. A power (PMea) is applied to the input of the substitution antenna, and adjust the level of the signal generator output until the value of the receiver reach the previously recorded (Pr). The power of signal source (PMea) is recorded. The test should be performed by rotating the test item and adjusting the receiving antenna polarization.
6. A amplifier should be connected to the Signal Source output port. And the cable should be connect between the Amplifier and the Substitution Antenna. The cable loss (Pcl) ,the Substitution Antenna Gain (Ga) and the Amplifier Gain (PAg) should be recorded after test.
7. The measurement results are obtained as described below:
Power(EIRP)=PMea- PAg - Pcl + Ga
The measurement results are amend as described below:
Power(EIRP)=PMea- Pcl + Ga
8. This value is EIRP since the measurement is calibrated using an antenna of known gain (2.15 dBi) and known input power. ERP can be calculated from EIRP by subtracting the gain of the dipole, ERP = EIRP-2.15dBi.

Test setup

30MHz~~~ 1GHz

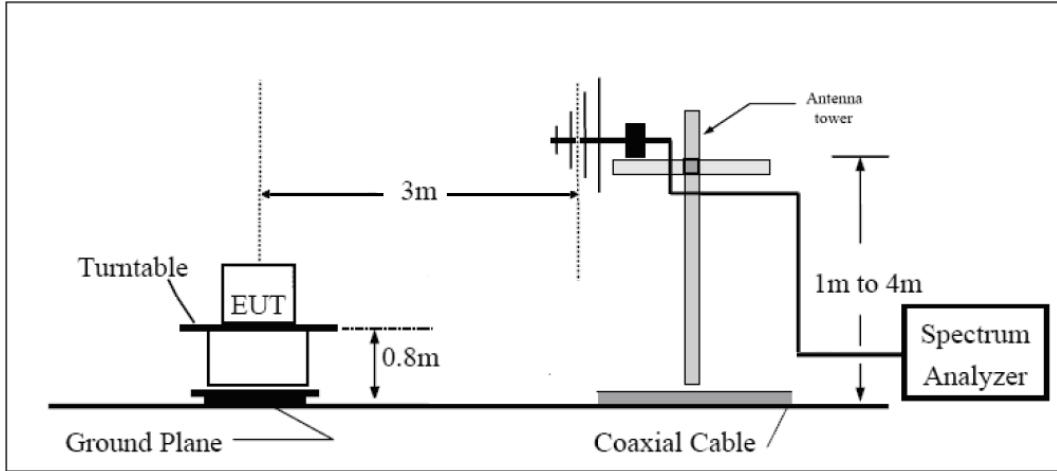

Above 1GHz

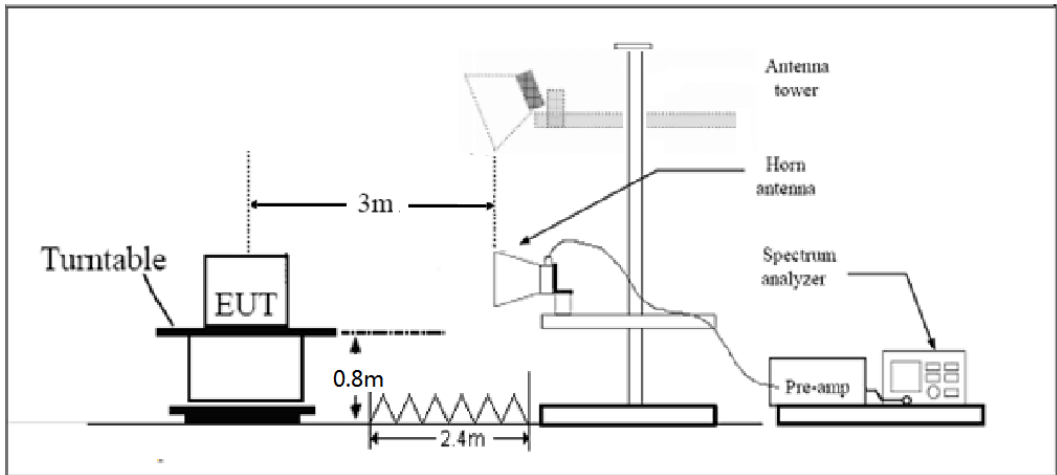

Note: Area side: 2.4mX3.6m

The radiated emission was measured in the following position: EUT stand-up position (Z axis), lie-down position (X, Y axis). The worst emission was found in stand-up position (Z axis) and the worst case was recorded.

Limits

Rule Part 24.238(a) specifies that “on any frequency outside a licensee's frequency block, the power of any emission shall be attenuated below the transmitter power (P) by at least $43 + 10 \log_{10} (P)$ dB.”

Limit	-13 dBm
-------	---------

Measurement Uncertainty

The assessed measurement uncertainty to ensure 95% confidence level for the normal distribution is with the coverage factor $k = 1.96$, $U = 3.55$ dB.

Test Result

LTE Band 2 1.4MHz CH-Low

Harmonic	Frequency (MHz)	SG (dBm)	Cable Loss (dB)	Gain (dBi)	Antenna Polarization	EIRP Level (dBm)	Limit (dBm)	Margin (dB)	Azimuth (deg)
2	3700.9	-51.85	5.1	11.05	Horizontal	-45.9	-13	32.9	225
3	5552.1	-53.33	5.42	12.65	Horizontal	-46.1	-13	33.1	45
4	7402.8	-48.75	6.7	13.85	Horizontal	-41.6	-13	28.6	315
5	9253.5	-48.14	7.01	14.75	Horizontal	-40.4	-13	27.4	135
6	11104.2	-46.47	7.48	15.95	Horizontal	-38.0	-13	25.0	90
7	12954.9	-45.54	7.51	16.55	Horizontal	-36.5	-13	23.5	225
8	14805.6	-41.41	8.24	15.35	Horizontal	-34.3	-13	21.3	180
9	16656.3	-42.54	8.41	14.95	Horizontal	-36.0	-13	23.0	315
10	18507.0	-42.71	8.54	15.45	Horizontal	-35.8	-13	22.8	45

Note: 1.The other Spurious RF Radiated emissions level is no more than noise floor.
 2.The worst emission was found in the antenna is Horizontal position.

LTE Band 2 1.4MHz CH-Middle

Harmonic	Frequency (MHz)	SG (dBm)	Cable Loss (dB)	Gain (dBi)	Antenna Polarization	EIRP Level (dBm)	Limit (dBm)	Margin (dB)	Azimuth (deg)
2	3959.0	-50.45	5.10	11.05	Horizontal	-44.5	-13	31.5	135
3	5638.9	-47.13	5.42	12.65	Horizontal	-39.9	-13	26.9	90
4	7520.0	-48.55	6.70	13.85	Horizontal	-41.4	-13	28.4	180
5	9400.0	-47.34	7.01	14.75	Horizontal	-39.6	-13	26.6	225
6	11280.0	-46.17	7.48	15.95	Horizontal	-37.7	-13	24.7	45
7	13160.0	-47.84	7.51	16.55	Horizontal	-38.8	-13	25.8	315
8	15040.0	-45.11	8.24	15.35	Horizontal	-38.0	-13	25.0	135
9	16920.0	-42.04	8.41	14.95	Horizontal	-35.5	-13	22.5	90
10	18800.0	-42.11	8.54	15.45	Horizontal	-35.2	-13	22.2	225

Note: 1.The other Spurious RF Radiated emissions level is no more than noise floor.
 2.The worst emission was found in the antenna is Horizontal position.

LTE Band 2 1.4MHz CH-High

Harmonic	Frequency (MHz)	SG (dBm)	Cable Loss (dB)	Gain (dBi)	Antenna Polarization	EIRP Level (dBm)	Limit (dBm)	Margin (dB)	Azimuth (deg)
2	3818.5	-49.15	5.10	11.05	Horizontal	-43.2	-13	30.2	180
3	5726.6	-40.93	5.42	12.65	Horizontal	-33.7	-13	20.7	315
4	7637.2	-48.25	6.70	13.85	Horizontal	-41.1	-13	28.1	45
5	9546.5	-48.24	7.01	14.75	Horizontal	-40.5	-13	27.5	180
6	11455.8	-44.67	7.48	15.95	Horizontal	-36.2	-13	23.2	225
7	13365.1	-44.94	7.51	16.55	Horizontal	-35.9	-13	22.9	45
8	15274.4	-44.01	8.24	15.35	Horizontal	-36.9	-13	23.9	315
9	17183.7	-42.84	8.41	14.95	Horizontal	-36.3	-13	23.3	135
10	19093.0	-42.01	8.54	15.45	Horizontal	-35.1	-13	22.1	90

Note: 1.The other Spurious RF Radiated emissions level is no more than noise floor.
 2.The worst emission was found in the antenna is Horizontal position.

LTE Band 2 3MHz CH-Low

Harmonic	Frequency (MHz)	SG (dBm)	Cable Loss (dB)	Gain (dBi)	Antenna Polarization	EIRP Level (dBm)	Limit (dBm)	Margin (dB)	Azimuth (deg)
2	3701.6	-52.65	5.10	11.05	Horizontal	-46.7	-13	33.7	135
3	5554.5	-54.23	5.42	12.65	Horizontal	-47.0	-13	34.0	90
4	7406.0	-48.35	6.70	13.85	Horizontal	-41.2	-13	28.2	225
5	9257.5	-45.94	7.01	14.75	Horizontal	-38.2	-13	25.2	180
6	11109.0	-45.57	7.48	15.95	Horizontal	-37.1	-13	24.1	315
7	12960.5	-45.74	7.51	16.55	Horizontal	-36.7	-13	23.7	45
8	14812.0	-41.21	8.24	15.35	Horizontal	-34.1	-13	21.1	180
9	16663.5	-43.34	8.41	14.95	Horizontal	-36.8	-13	23.8	225
10	18515.0	-42.61	8.54	15.45	Horizontal	-35.7	-13	22.7	45

Note: 1.The other Spurious RF Radiated emissions level is no more than noise floor.
 2.The worst emission was found in the antenna is Horizontal position.



LTE Band 2 3MHz CH-Middle

Harmonic	Frequency (MHz)	SG (dBm)	Cable Loss (dB)	Gain (dBi)	Antenna Polarization	EIRP Level (dBm)	Limit (dBm)	Margin (dB)	Azimuth (deg)
2	3757.9	-50.35	5.10	11.05	Horizontal	-44.4	-13	31.4	315
3	5637.0	-42.73	5.42	12.65	Horizontal	-35.5	-13	22.5	135
4	7520.0	-48.75	6.70	13.85	Horizontal	-41.6	-13	28.6	90
5	9400.0	-45.84	7.01	14.75	Horizontal	-38.1	-13	25.1	135
6	11280.0	-46.47	7.48	15.95	Horizontal	-38.0	-13	25.0	90
7	13160.0	-46.94	7.51	16.55	Horizontal	-37.9	-13	24.9	225
8	15040.0	-45.71	8.24	15.35	Horizontal	-38.6	-13	25.6	180
9	16920.0	-43.04	8.41	14.95	Horizontal	-36.5	-13	23.5	315
10	18800.0	-42.21	8.54	15.45	Horizontal	-35.3	-13	22.3	45

Note: 1.The other Spurious RF Radiated emissions level is no more than noise floor.

2.The worst emission was found in the antenna is Horizontal position.

LTE Band 2 3MHz CH-High

Harmonic	Frequency (MHz)	SG (dBm)	Cable Loss (dB)	Gain (dBi)	Antenna Polarization	EIRP Level (dBm)	Limit (dBm)	Margin (dB)	Azimuth (deg)
2	3814.9	-49.05	5.10	11.05	Horizontal	-43.1	-13	30.1	45
3	5722.1	-40.63	5.42	12.65	Horizontal	-33.4	-13	20.4	315
4	7634.0	-48.55	6.70	13.85	Horizontal	-41.4	-13	28.4	135
5	9542.5	-49.24	7.01	14.75	Horizontal	-41.5	-13	28.5	90
6	11451.0	-44.67	7.48	15.95	Horizontal	-36.2	-13	23.2	135
7	13359.5	-44.94	7.51	16.55	Horizontal	-35.9	-13	22.9	90
8	15268.0	-44.21	8.24	15.35	Horizontal	-37.1	-13	24.1	225
9	17176.5	-42.14	8.41	14.95	Horizontal	-35.6	-13	22.6	180
10	19085.0	-41.81	8.54	15.45	Horizontal	-34.9	-13	21.9	315

Note: 1.The other Spurious RF Radiated emissions level is no more than noise floor.

2.The worst emission was found in the antenna is Horizontal position.



LTE Band 2 5MHz CH-Low

Harmonic	Frequency (MHz)	SG (dBm)	Cable Loss (dB)	Gain (dBi)	Antenna Polarization	EIRP Level (dBm)	Limit (dBm)	Margin (dB)	Azimuth (deg)
2	3705.0	-50.75	5.10	11.05	Horizontal	-44.8	-13	31.8	90
3	5557.5	-52.43	5.42	12.65	Horizontal	-45.2	-13	32.2	225
4	7410.0	-48.55	6.70	13.85	Horizontal	-41.4	-13	28.4	180
5	9262.5	-48.04	7.01	14.75	Horizontal	-40.3	-13	27.3	315
6	11115.0	-46.87	7.48	15.95	Horizontal	-38.4	-13	25.4	45
7	12967.5	-46.24	7.51	16.55	Horizontal	-37.2	-13	24.2	180
8	14820.0	-41.21	8.24	15.35	Horizontal	-34.1	-13	21.1	225
9	16672.5	-42.64	8.41	14.95	Horizontal	-36.1	-13	23.1	45
10	18525.0	-41.21	8.54	15.45	Horizontal	-34.3	-13	21.3	315

Note: 1.The other Spurious RF Radiated emissions level is no more than noise floor.
2.The worst emission was found in the antenna is Horizontal position.

LTE Band 2 5MHz CH-Middle

Harmonic	Frequency (MHz)	SG (dBm)	Cable Loss (dB)	Gain (dBi)	Antenna Polarization	EIRP Level (dBm)	Limit (dBm)	Margin (dB)	Azimuth (deg)
2	3755.3	-52.05	5.10	11.05	Horizontal	-46.1	-13	33.1	135
3	5633.6	-44.63	5.42	12.65	Horizontal	-37.4	-13	24.4	90
4	7520.0	-48.85	6.70	13.85	Horizontal	-41.7	-13	28.7	225
5	9400.0	-46.74	7.01	14.75	Horizontal	-39.0	-13	26.0	180
6	11280.0	-45.87	7.48	15.95	Horizontal	-37.4	-13	24.4	315
7	13160.0	-47.54	7.51	16.55	Horizontal	-38.5	-13	25.5	45
8	15040.0	-44.61	8.24	15.35	Horizontal	-37.5	-13	24.5	270
9	16920.0	-41.94	8.41	14.95	Horizontal	-35.4	-13	22.4	135
10	18800.0	-43.01	8.54	15.45	Horizontal	-36.1	-13	23.1	90

Note: 1.The other Spurious RF Radiated emissions level is no more than noise floor.
2.The worst emission was found in the antenna is Horizontal position.



LTE Band 2 5MHz CH-High

Harmonic	Frequency (MHz)	SG (dBm)	Cable Loss (dB)	Gain (dBi)	Antenna Polarization	EIRP Level (dBm)	Limit (dBm)	Margin (dB)	Azimuth (deg)
2	3810.4	-49.35	5.10	11.05	Horizontal	-43.4	-13	30.4	180
3	5716.5	-40.53	5.42	12.65	Horizontal	-33.3	-13	20.3	225
4	7630.0	-48.45	6.70	13.85	Horizontal	-41.3	-13	28.3	45
5	9526.5	-45.14	7.01	14.75	Horizontal	-37.4	-13	24.4	315
6	11445.0	-44.87	7.48	15.95	Horizontal	-36.4	-13	23.4	135
7	13352.5	-46.14	7.51	16.55	Horizontal	-37.1	-13	24.1	90
8	15260.0	-43.31	8.24	15.35	Horizontal	-36.2	-13	23.2	225
9	17167.5	-43.04	8.41	14.95	Horizontal	-36.5	-13	23.5	180
10	19075.0	-41.41	8.54	15.45	Horizontal	-34.5	-13	21.5	315

Note: 1.The other Spurious RF Radiated emissions level is no more than noise floor.
2.The worst emission was found in the antenna is Horizontal position.

LTE Band 2 10MHz CH-Low

Harmonic	Frequency (MHz)	SG (dBm)	Cable Loss (dB)	Gain (dBi)	Antenna Polarization	EIRP Level (dBm)	Limit (dBm)	Margin (dB)	Azimuth (deg)
2	3701.3	-50.65	5.10	11.05	Horizontal	-44.7	-13	31.7	225
3	5552.3	-35.23	5.42	12.65	Horizontal	-28.0	-13	15.0	180
4	7420.0	-47.95	6.70	13.85	Horizontal	-40.8	-13	27.8	315
5	9275.0	-47.14	7.01	14.75	Horizontal	-39.4	-13	26.4	45
6	11130.0	-45.77	7.48	15.95	Horizontal	-37.3	-13	24.3	270
7	12985.0	-46.74	7.51	16.55	Horizontal	-37.7	-13	24.7	135
8	14840.0	-40.91	8.24	15.35	Horizontal	-33.8	-13	20.8	90
9	16695.0	-43.74	8.41	14.95	Horizontal	-37.2	-13	24.2	180
10	18550.0	-42.11	8.54	15.45	Horizontal	-35.2	-13	22.2	225

Note: 1.The other Spurious RF Radiated emissions level is no more than noise floor.
2.The worst emission was found in the antenna is Horizontal position.



LTE Band 2 10MHz CH-Middle

Harmonic	Frequency (MHz)	SG (dBm)	Cable Loss (dB)	Gain (dBi)	Antenna Polarization	EIRP Level (dBm)	Limit (dBm)	Margin (dB)	Azimuth (deg)
2	3751.5	-51.35	5.10	11.05	Horizontal	-45.4	-13	32.4	180
3	5629.1	-46.13	5.42	12.65	Horizontal	-38.9	-13	25.9	315
4	7520.0	-48.85	6.70	13.85	Horizontal	-41.7	-13	28.7	225
5	9400.0	-45.94	7.01	14.75	Horizontal	-38.2	-13	25.2	180
6	11280.0	-45.47	7.48	15.95	Horizontal	-37.0	-13	24.0	315
7	13160.0	-47.74	7.51	16.55	Horizontal	-38.7	-13	25.7	45
8	15040.0	-44.21	8.24	15.35	Horizontal	-37.1	-13	24.1	270
9	16920.0	-42.54	8.41	14.95	Horizontal	-36.0	-13	23.0	135
10	18800.0	-41.81	8.54	15.45	Horizontal	-34.9	-13	21.9	90

Note: 1.The other Spurious RF Radiated emissions level is no more than noise floor.
2.The worst emission was found in the antenna is Horizontal position.

LTE Band 2 10MHz CH-High

Harmonic	Frequency (MHz)	SG (dBm)	Cable Loss (dB)	Gain (dBi)	Antenna Polarization	EIRP Level (dBm)	Limit (dBm)	Margin (dB)	Azimuth (deg)
2	3801.4	-48.85	5.10	11.05	Horizontal	-42.9	-13	29.9	270
3	5702.3	-41.23	5.42	12.65	Horizontal	-34.0	-13	21.0	135
4	7620.0	-48.95	6.70	13.85	Horizontal	-41.8	-13	28.8	90
5	9525.0	-48.54	7.01	14.75	Horizontal	-40.8	-13	27.8	0
6	11430.0	-44.37	7.48	15.95	Horizontal	-35.9	-13	22.9	225
7	13335.0	-45.34	7.51	16.55	Horizontal	-36.3	-13	23.3	180
8	15240.0	-44.31	8.24	15.35	Horizontal	-37.2	-13	24.2	315
9	17145.0	-42.44	8.41	14.95	Horizontal	-35.9	-13	22.9	225
10	19050.0	-41.61	8.54	15.45	Horizontal	-34.7	-13	21.7	180

Note: 1.The other Spurious RF Radiated emissions level is no more than noise floor.
2.The worst emission was found in the antenna is Horizontal position.

LTE Band 2 15MHz CH-Low

Harmonic	Frequency (MHz)	SG (dBm)	Cable Loss (dB)	Gain (dBi)	Antenna Polarization	EIRP Level (dBm)	Limit (dBm)	Margin (dB)	Azimuth (deg)
2	3702.4	-49.95	5.10	11.05	Horizontal	-44.0	-13	31.0	90
3	5553.8	-41.13	5.42	12.65	Horizontal	-33.9	-13	20.9	45
4	7435.9	-46.45	6.70	13.85	Horizontal	-39.3	-13	26.3	135
5	9287.5	-47.74	7.01	14.75	Horizontal	-40.0	-13	27.0	90
6	11145.0	-46.57	7.48	15.95	Horizontal	-38.1	-13	25.1	270
7	13002.5	-46.84	7.51	16.55	Horizontal	-37.8	-13	24.8	135
8	14860.0	-41.51	8.24	15.35	Horizontal	-34.4	-13	21.4	90
9	16717.5	-43.54	8.41	14.95	Horizontal	-37.0	-13	24.0	0
10	18575.0	-41.61	8.54	15.45	Horizontal	-34.7	-13	21.7	225

Note: 1.The other Spurious RF Radiated emissions level is no more than noise floor.
 2.The worst emission was found in the antenna is Horizontal position.

LTE Band 2 15MHz CH-Middle

Harmonic	Frequency (MHz)	SG (dBm)	Cable Loss (dB)	Gain (dBi)	Antenna Polarization	EIRP Level (dBm)	Limit (dBm)	Margin (dB)	Azimuth (deg)
2	3747.4	-52.75	5.10	11.05	Horizontal	-46.8	-13	33.8	315
3	5621.3	-40.63	5.42	12.65	Horizontal	-33.4	-13	20.4	225
4	7520.0	-49.45	6.70	13.85	Horizontal	-42.3	-13	29.3	180
5	9400.0	-45.44	7.01	14.75	Horizontal	-37.7	-13	24.7	45
6	11280.0	-46.47	7.48	15.95	Horizontal	-38.0	-13	25.0	270
7	13160.0	-47.04	7.51	16.55	Horizontal	-38.0	-13	25.0	135
8	15040.0	-44.41	8.24	15.35	Horizontal	-37.3	-13	24.3	90
9	16920.0	-42.54	8.41	14.95	Horizontal	-36.0	-13	23.0	270
10	18800.0	-41.81	8.54	15.45	Horizontal	-34.9	-13	21.9	135

Note: 1.The other Spurious RF Radiated emissions level is no more than noise floor.
 2.The worst emission was found in the antenna is Horizontal position.



LTE Band 2 15MHz CH-High

Harmonic	Frequency (MHz)	SG (dBm)	Cable Loss (dB)	Gain (dBi)	Antenna Polarization	EIRP Level (dBm)	Limit (dBm)	Margin (dB)	Azimuth (deg)
2	3792.0	-49.75	5.10	11.05	Horizontal	-43.8	-13	30.8	135
3	5688.4	-41.93	5.42	12.65	Horizontal	-34.7	-13	21.7	90
4	7610.0	-49.55	6.70	13.85	Horizontal	-42.4	-13	29.4	0
5	9512.5	-48.14	7.01	14.75	Horizontal	-40.4	-13	27.4	225
6	11415.0	-44.97	7.48	15.95	Horizontal	-36.5	-13	23.5	315
7	13317.5	-45.84	7.51	16.55	Horizontal	-36.8	-13	23.8	225
8	15220.0	-43.41	8.24	15.35	Horizontal	-36.3	-13	23.3	180
9	17122.5	-42.84	8.41	14.95	Horizontal	-36.3	-13	23.3	45
10	19025.0	-43.21	8.54	15.45	Horizontal	-36.3	-13	23.3	270

Note: 1.The other Spurious RF Radiated emissions level is no more than noise floor.
2.The worst emission was found in the antenna is Horizontal position.

LTE Band 2 20MHz CH-Low

Harmonic	Frequency (MHz)	SG (dBm)	Cable Loss (dB)	Gain (dBi)	Antenna Polarization	EIRP Level (dBm)	Limit (dBm)	Margin (dB)	Azimuth (deg)
2	3702.8	-49.85	5.10	11.05	Horizontal	-43.9	-13	30.9	0
3	5555.3	-44.33	5.42	12.65	Horizontal	-37.1	-13	24.1	45
4	7440.0	-48.15	6.70	13.85	Horizontal	-41.0	-13	28.0	135
5	9300.0	-46.44	7.01	14.75	Horizontal	-38.7	-13	25.7	270
6	11160.0	-46.57	7.48	15.95	Horizontal	-38.1	-13	25.1	90
7	13020.0	-45.74	7.51	16.55	Horizontal	-36.7	-13	23.7	0
8	14880.0	-41.21	8.24	15.35	Horizontal	-34.1	-13	21.1	225
9	16740.0	-42.94	8.41	14.95	Horizontal	-36.4	-13	23.4	315
10	18600.0	-41.61	8.54	15.45	Horizontal	-34.7	-13	21.7	225

Note: 1.The other Spurious RF Radiated emissions level is no more than noise floor.
2.The worst emission was found in the antenna is Horizontal position.



LTE Band 2 20MHz CH-Middle

Harmonic	Frequency (MHz)	SG (dBm)	Cable Loss (dB)	Gain (dBi)	Antenna Polarization	EIRP Level (dBm)	Limit (dBm)	Margin (dB)	Azimuth (deg)
2	3742.9	-52.35	5.10	11.05	Horizontal	-46.4	-13	33.4	45
3	5614.5	-37.63	5.42	12.65	Horizontal	-30.4	-13	17.4	270
4	7520.0	-49.15	6.70	13.85	Horizontal	-42.0	-13	29.0	90
5	9356.6	-44.04	7.01	14.75	Horizontal	-36.3	-13	23.3	270
6	11280.0	-44.97	7.48	15.95	Horizontal	-36.5	-13	23.5	135
7	13160.0	-47.14	7.51	16.55	Horizontal	-38.1	-13	25.1	135
8	15040.0	-44.81	8.24	15.35	Horizontal	-37.7	-13	24.7	90
9	16920.0	-42.34	8.41	14.95	Horizontal	-35.8	-13	22.8	0
10	18800.0	-42.41	8.54	15.45	Horizontal	-35.5	-13	22.5	225

Note: 1.The other Spurious RF Radiated emissions level is no more than noise floor.
2.The worst emission was found in the antenna is Horizontal position.

LTE Band 2 20MHz CH-High

Harmonic	Frequency (MHz)	SG (dBm)	Cable Loss (dB)	Gain (dBi)	Antenna Polarization	EIRP Level (dBm)	Limit (dBm)	Margin (dB)	Azimuth (deg)
2	3783.0	-50.35	5.10	11.05	Horizontal	-44.4	-13	31.4	90
3	5674.5	-38.43	5.42	12.65	Horizontal	-31.2	-13	18.2	0
4	7600.0	-49.75	6.70	13.85	Horizontal	-42.6	-13	29.6	315
5	9500.0	-49.74	7.01	14.75	Horizontal	-42.0	-13	29.0	225
6	11400.0	-44.17	7.48	15.95	Horizontal	-35.7	-13	22.7	180
7	13300.0	-44.54	7.51	16.55	Horizontal	-35.5	-13	22.5	45
8	15200.0	-44.41	8.24	15.35	Horizontal	-37.3	-13	24.3	270
9	17100.0	-42.94	8.41	14.95	Horizontal	-36.4	-13	23.4	135
10	19000.0	28.19	8.54	15.45	Horizontal	35.1	-13	-48.1	90

Note: 1.The other Spurious RF Radiated emissions level is no more than noise floor.
2.The worst emission was found in the antenna is Horizontal position.

6. Main Test Instruments

Name	Manufacturer	Type	Serial Number	Calibration Date	Expiration Time
Base Station Simulator	R&S	CMU200	118133	2017-05-14	2018-05-13
Power Splitter	Hua Xiang	SHX-GF2-2-13	10120101	2017-05-14	2018-05-13
Spectrum Analyzer	Agilent	N9010A	MY47191109	2017-05-20	2018-05-19
Universal Radio Communication Tester	Agilent	E5515C	MY48367192	2017-05-20	2018-05-19
Signal Analyzer	R&S	FSV30	100815	2016-12-16	2017-12-15
EMI Test Receiver	R&S	ESCI	100948	2017-05-20	2018-05-19
Signal generator	R&S	SMB 100A	102594	2017-05-14	2018-05-13
Signal generator	R&S	SMR27	100365	2017-05-14	2018-05-13
Trilog Antenna	SCHWARZBECK	VUBL 9163	9163-201	2014-12-06	2017-12-05
Horn Antenna	R&S	HF907	100126	2014-12-06	2017-12-05
Climatic Chamber	Re Ce	PT-30B	20101891	2015-07-18	2018-07-17
Horn Antenna	ETS-Lindgren	3160-09	00102644	2015-01-30	2018-01-29
RF Cable	Agilent	SMA 15cm	0001	2017-08-04	2018-02-03
Preampflier	R&S	SCU18	102327	2017-06-18	2018-06-17

*****END OF REPORT *****

ANNEX A: EUT Appearance and Test Setup

A.1 EUT Appearance

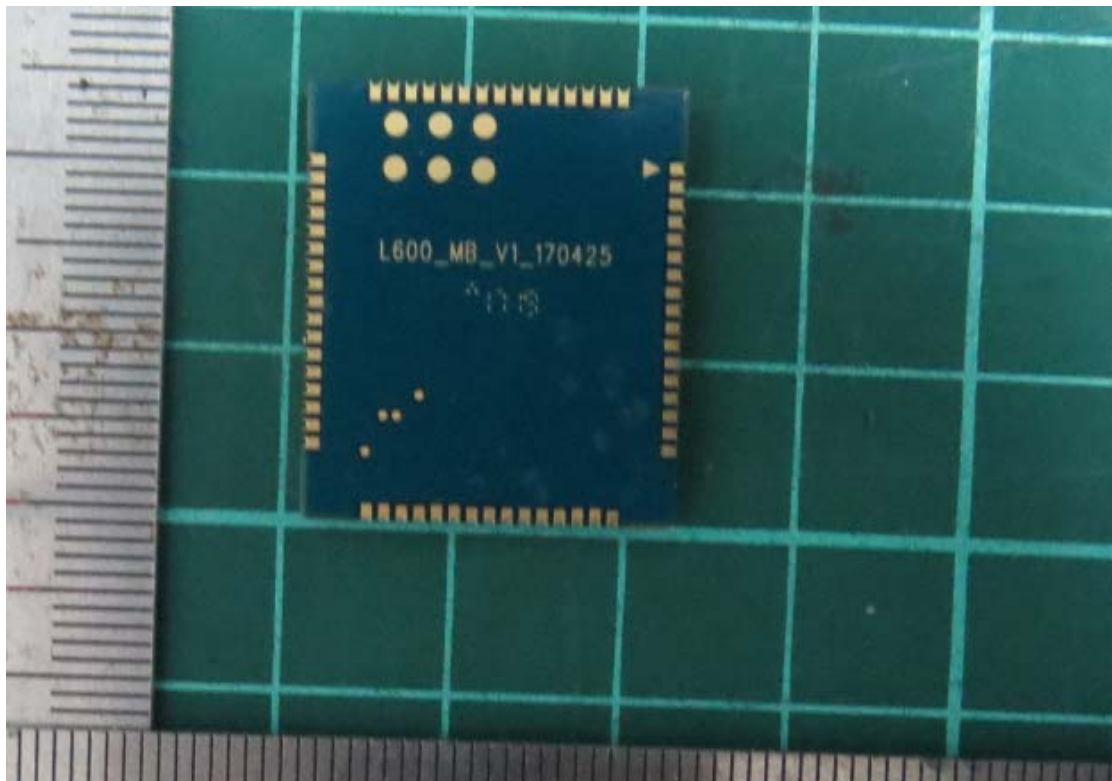

Picture 1 EUT

A.2 Test Setup

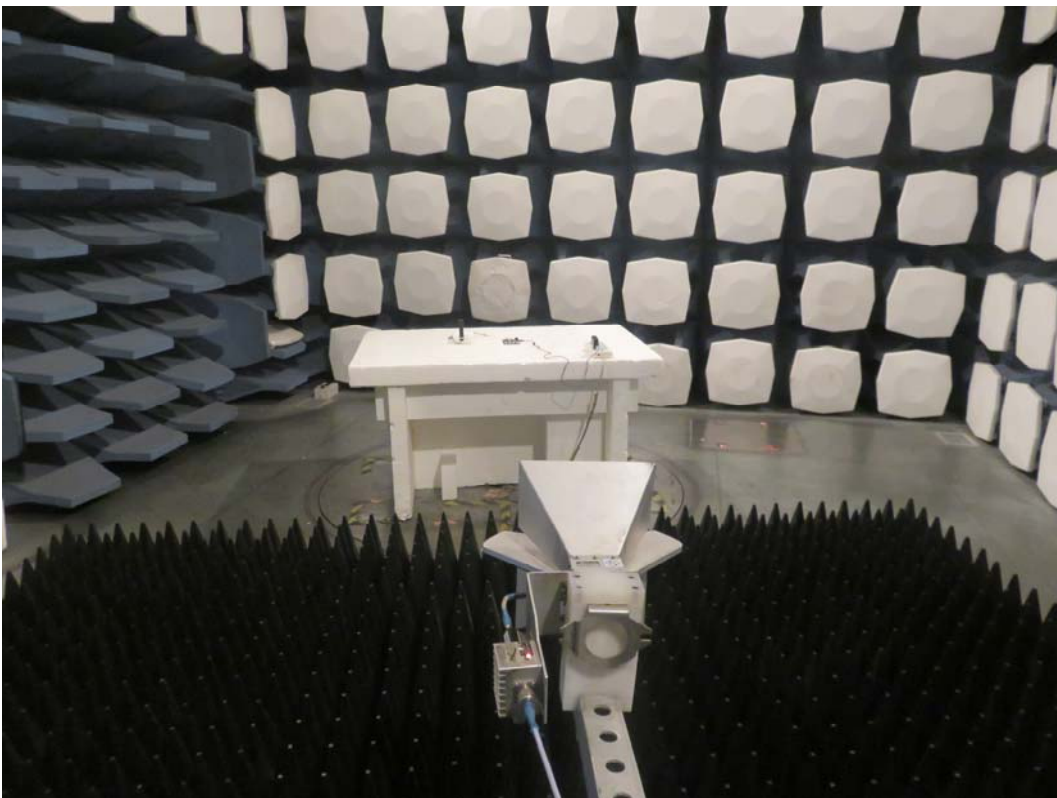
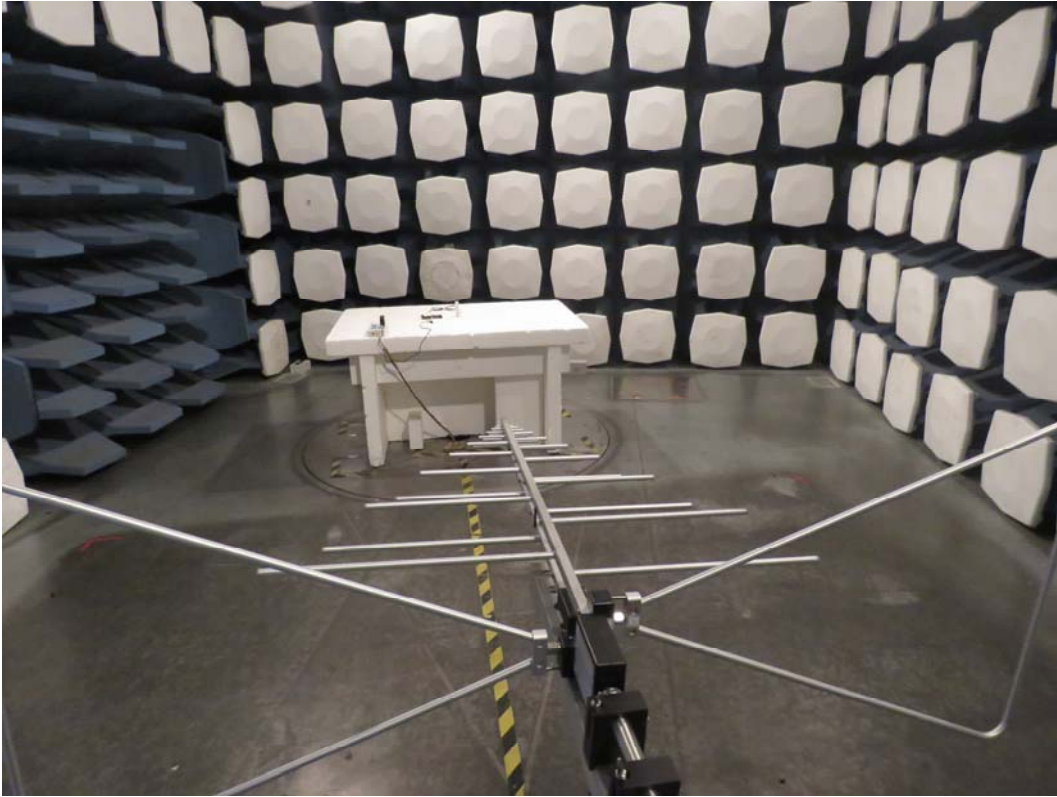

Picture 2: Radiated Spurious Emissions Test setup