



MEASUREMENT REPORT

Test Report

1

Applicant: SHENZHEN UNICHAIN TECHNOLOGY CO., LTD

Address of Applicant: 3 Floor, HongXiangJia electronic commerce Pioneer Park, Shenzhen, China

Manufacturer: SHENZHEN SECURI ELECTRONICSCO., LTD

Address of Manufacturer: B1 Building, Xinhaosheng Industrial Zone, Yonghe Road, Qiaotou, Fuyong Sub district, Bao'an, Shenzhen, China

Equipment Under Test (EUT):

Product: Wireless Doorbell

Model No.: WA818, WA838, WA848

Test Model No.: WA818

Brand Name: N/A

FCC ID: 2AK8Q-WA818

Standards: 47 CFR Part 15, Subpart C

Date of Test: 2016-11-15 to 2016-12-10

Date of Issue: 2016-12-10

Test Result : PASS*

Reviewed By: _____

(Aaron Ma)

Approved By: _____

(Owen Zhou)



2 Version

Revision History Of Report

Report No.	Version	Description	Issue Date
CQASZ161101310E-01	Rev.01	Initial report	2016-12-10

3 Test Summary

Test Item	Test Requirement	Test method	Result
Antenna Requirement	47 CFR Part 15, Subpart C Section 15.203	ANSI C63.10 (2013)	PASS
Field Strength of the Fundamental Signal	47 CFR Part 15, Subpart C Section 15.231 (b)	ANSI C63.10 (2013)	PASS
Spurious Emissions	47 CFR Part 15, Subpart C Section 15.231 (b)/15.209	ANSI C63.10 (2013)	PASS
20dB Bandwidth	47 CFR Part 15, Subpart C Section 15.231 (c)	ANSI C63.10 (2013)	PASS
Dwell Time	47 CFR Part 15, Subpart C Section 15.231 (a)	ANSI C63.10 (2013)	PASS

Remark:

Model No.: WA818, WA838, WA848

Only the Model WA818 was tested, since the electrical circuit design, layout, components used and internal are same, wiring were identical for all above models. Only different on color of appearance and model name.

4 Contents

	Page
1 COVER PAGE.....	1
2 VERSION	2
3 TEST SUMMARY	3
4 CONTENTS	4
5 GENERAL INFORMATION.....	5
5.1 CLIENT INFORMATION	5
5.2 GENERAL DESCRIPTION OF EUT	5
5.3 TEST ENVIRONMENT AND MODE	6
5.4 DESCRIPTION OF SUPPORT UNITS	6
5.5 TEST LOCATION	6
5.6 TEST FACILITY	6
5.7 STATEMENT OF THE MEASUREMENT UNCERTAINTY.....	6
5.8 DEVIATION FROM STANDARDS	7
5.9 ABNORMALITIES FROM STANDARD CONDITIONS	7
5.10 OTHER INFORMATION REQUESTED BY THE CUSTOMER.....	7
5.11 EQUIPMENT LIST	8
6 TEST RESULTS AND MEASUREMENT DATA.....	9
6.1 ANTENNA REQUIREMENT	9
6.2 SPURIOUS EMISSIONS	10
6.2.1 <i>Duty Cycle</i>	10
6.2.2 <i>Spurious Emissions</i>	13
6.3 20dB BANDWIDTH	20
6.4 DWELL TIME	22
7 PHOTOGRAPHS - EUT TEST SETUP	24
7.1 RADIATED EMISSION.....	24
8 PHOTOGRAPHS - EUT CONSTRUCTIONAL DETAILS	25

5 General Information

5.1 Client Information

Applicant:	SHENZHEN UNICHAIN TECHNOLOGY CO., LTD
Address of Applicant:	3 Floor, HongXiangJia electronic commerce Pioneer Park, Shenzhen, China
Manufacturer:	SHENZHEN SECRUI ELECTRONICSCO., LTD
Address of Manufacturer:	B1 Building, Xinhaosheng Industrial Zone, Yonghe Road, Qiaotou, Fuyong Sub district, Bao'an, Shenzhen, China

5.2 General Description of EUT

Name:	Wireless Doorbell
Model No.:	WA818, WA838, WA848
Test Model No.:	WA818
Trade Mark:	N/A
Hardware Version:	KF-F53-B
Software Version:	V1.0
Sample Type:	Fixed production
Operation Frequency:	433.92MHz
Channel Numbers:	1
Modulation Type:	ASK
Antenna Type:	Integral antenna
Antenna Gain:	1.0dBi
Power Supply:	Battery: DC12V

Note: Using the new battery for testing.

5.3 Test Environment and Mode

Operating Environment:	
Temperature:	24.0 °C
Humidity:	52 % RH
Atmospheric Pressure:	1008 mbar
Test mode:	
Transmitting mode:	Keep the EUT in transmitting mode with modulation.

5.4 Description of Support Units

The EUT has been tested independent unit.

5.5 Test Location

All tests were performed at:

Shenzhen Tongce Testing Lab,
1F, Leinuo Watch Building, Fuyong Town, Baoan Dist, Shenzhen, China

5.6 Test Facility

The test facility is recognized, certified, or accredited by the following organizations:

FCC – Registration No.: 572331

Shenzhen Tongce Testing Lab has been registered and fully described in a report filed with the (FCC) Federal Communications Commission. The acceptance letter from the FCC is maintained in our files. Registration 572331

5.7 Statement of the measurement uncertainty

The data and results referenced in this document are true and accurate.

The reader is cautioned that there may be errors within the calibration limits of the equipment and facilities.

The measurement uncertainty was calculated for all measurements listed in this test report acc. to CISPR 16 - 4 „Specification for radio disturbance and immunity measuring apparatus and methods – Part 4: Uncertainty in EMC Measurements“ and is documented in the Shenzhen Tongce Testing Lab quality system acc. to DIN EN ISO/IEC 17025.

Furthermore, component and process variability of devices similar to that tested may result in additional deviation. The manufacturer has the sole responsibility of continued compliance of the device.

Hereafter the best measurement capability for TCT laboratory is reported:

Test	Range	Uncertainty	Notes
Radiated Emission	Below 1GHz	±3.92dB	(1)
Radiated Emission	Above 1GHz	±4.28dB	(1)
Conducted Disturbance	0.15~30MHz	±2.56dB	(1)

(1) This uncertainty represents an expanded uncertainty expressed at approximately the 95% confidence level using a coverage factor of k=2.

5.8 Deviation from Standards

None.

5.9 Abnormalities from Standard Conditions

None.

5.10 Other Information Requested by the Customer

None.

5.11 Equipment List

Item	Test Equipment	Manufacturer	Model No.	Serial No.	Calibration Due Date
1	ESPI Test Receiver	R&S	ESVD	100008	2017/08/11
2	Spectrum Analyzer	R&S	FSEM	848597/001	2017/08/11
3	Spectrum Analyzer	Agilent	N9020A	MY49100060	2017/08/12
4	Pre-amplifier	EM Electronics Corporation CO.,LTD	EM30265	07032613	2017/08/11
5	Pre-amplifier	HP	8447D	2727A05017	2017/08/11
6	Loop antenna	ZHINAN	ZN30900A	12024	2017/08/13
7	Broadband Antenna	R&S	VULB9163	340	2017/08/13
8	Horn Antenna	R&S	BBHA 9120D	631	2017/08/13
9	Antenna Mast	CCS	CC-A-4M	N/A	N/A
10	Coax cable (9KHz~40GHz)	TCT	RE-low-01	N/A	2017/08/11
11	Coax cable (9KHz~40GHz)	TCT	RE-high-02	N/A	2017/08/11
12	Spectrum Analyzer	R&S	FSU	200054	2017/08/11
13	Antenna Connector	TCT	RFC-01	N/A	2017/08/12
14	RF cable(9KHz~40GHz)	TCT	RE-06	N/A	2017/08/12

Note:

The temporary antenna connector is soldered on the PCB board in order to perform conducted tests and this temporary antenna connector is listed in the equipment list.

6 Test results and Measurement Data

6.1 Antenna Requirement

Standard requirement:	47 CFR Part 15C Section 15.203
<p>15.203 requirement:</p> <p>An intentional radiator shall be designed to ensure that no antenna other than that furnished by the responsible party shall be used with the device. The use of a permanently attached antenna or of an antenna that uses a unique coupling to the intentional radiator, the manufacturer may design the unit so that a broken antenna can be replaced by the user, but the use of a standard antenna jack or electrical connector is prohibited.</p>	
EUT Antenna:	
<p>The antenna is integrated on the main PCB and no consideration of replacement. The best case gain of the antenna is 1.0dBi.</p>	

6.2 Spurious Emissions

6.2.1 Duty Cycle

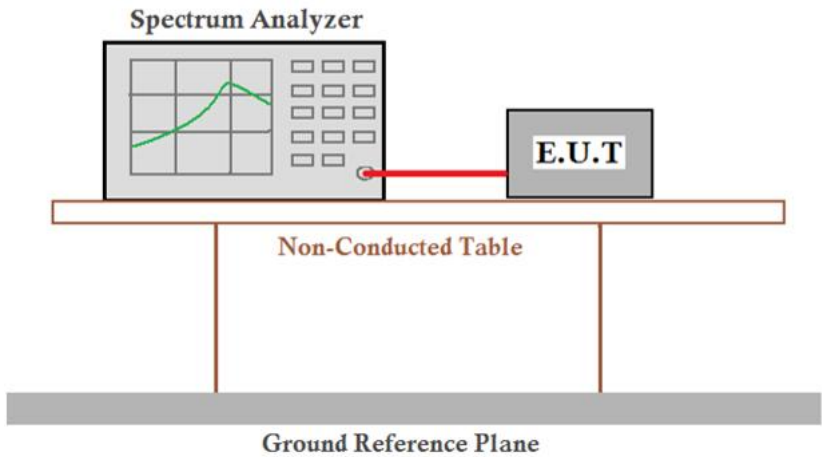
Test Requirement:	47 CFR Part 15C Section 15.35 (c)
Test Method:	ANSI C63.10:2013
Test Setup:	
Limit:	N/A
Test Mode:	Transmitting mode
Instruments Used:	Refer to section 5.10 for details
Test Results:	Pass

Duty cycle numbers	T period (ms)	T on time (ms)	Duty cycle
25	36.66	14.846	0.405

Note: $T \text{ on time} = 0.803 \times 16 + 0.222 \times 9 = 14.846 \text{ms}$,

$\text{Duty cycle} = T \text{ on time} / T \text{ period}$

Test plot as follows:
Duty cycle numbers

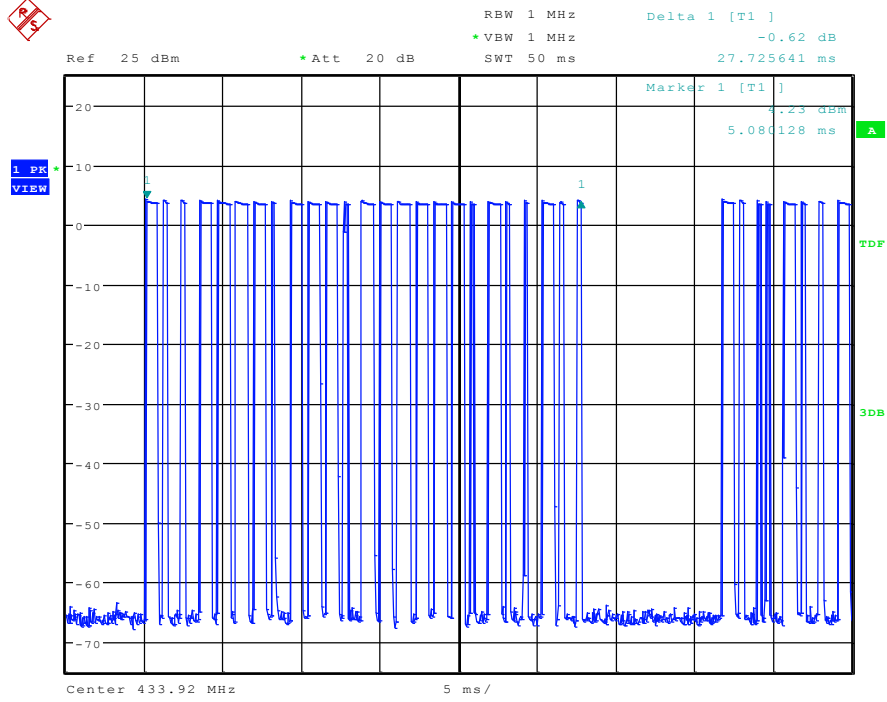

T period:

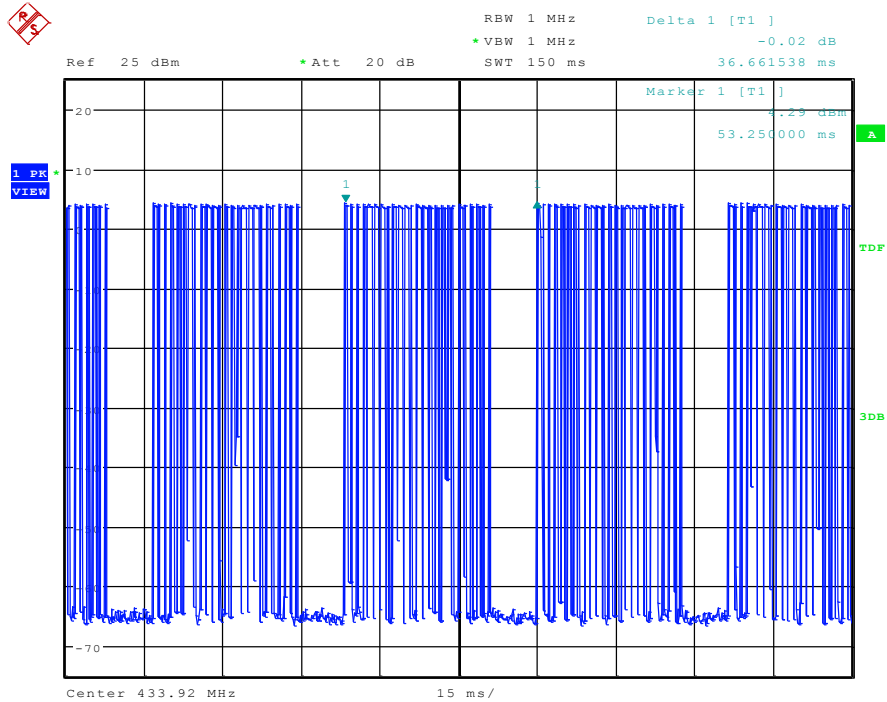

T on time:

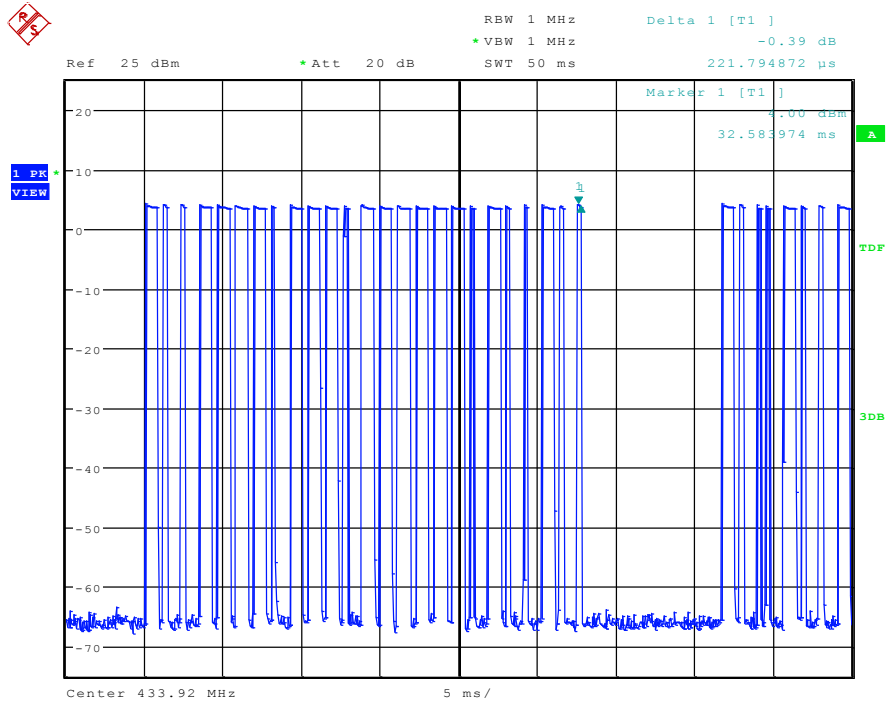

T on time:

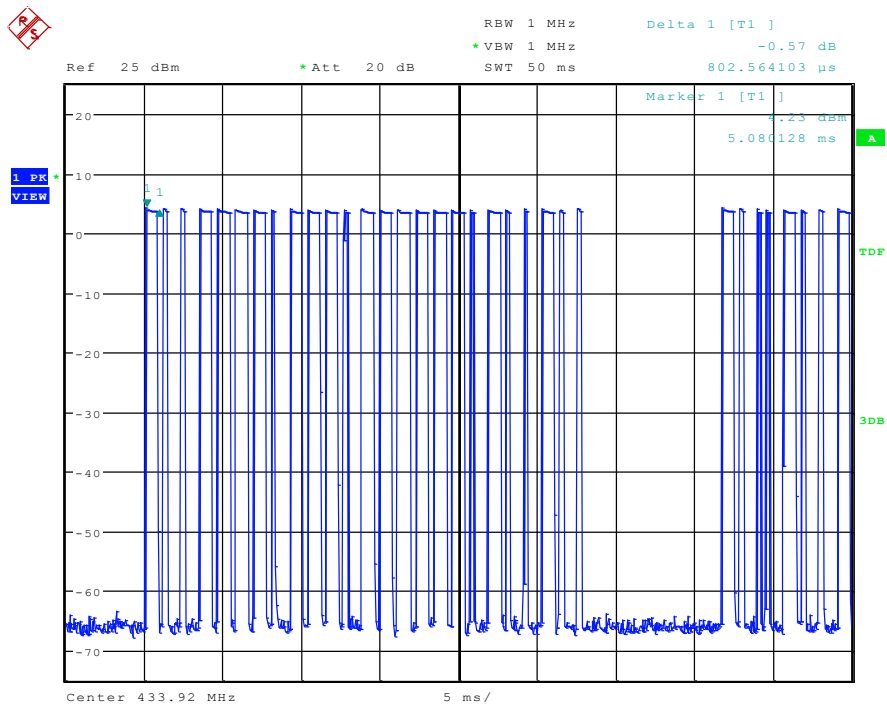

6.2.2 Spurious Emissions

Test Requirement:	47 CFR Part 15C Section 15.231(b) and 15.209				
Test Method:	ANSI C63.10: 2013				
Test Site:	Measurement Distance: 3m (Semi-Anechoic Chamber)				
Receiver Setup:	Frequency	Detector	RBW	VBW	Remark
	0.009MHz-0.090MHz	Peak	10kHz	30kHz	Peak
	0.009MHz-0.090MHz	Average	10kHz	30kHz	Average
	0.090MHz-0.110MHz	Quasi-peak	10kHz	30kHz	Quasi-peak
	0.110MHz-0.490MHz	Peak	10kHz	30kHz	Peak
	0.110MHz-0.490MHz	Average	10kHz	30kHz	Average
	0.490MHz -30MHz	Quasi-peak	10kHz	30kHz	Quasi-peak
	30MHz-1GHz	Quasi-peak	100 kHz	300kHz	Quasi-peak
	Above 1GHz	Peak	1MHz	3MHz	Peak
Peak		1MHz	10Hz	Average	
Limit: (Spurious Emissions)	Frequency	Field strength (microvolt/meter)	Limit (dBuV/m)	Remark	Measurement distance (m)
	0.009MHz-0.490MHz	2400/F(kHz)	-	-	300
	0.490MHz-1.705MHz	24000/F(kHz)	-	-	30
	1.705MHz-30MHz	30	-	-	30
	30MHz-88MHz	100	40.0	Quasi-peak	3
	88MHz-216MHz	150	43.5	Quasi-peak	3
	216MHz-960MHz	200	46.0	Quasi-peak	3
	960MHz-1GHz	500	54.0	Quasi-peak	3
	Above 1GHz	500	54.0	Average	3
Note: 15.35(b), Unless otherwise specified, the limit on peak radio frequency emissions is 20dB above the maximum permitted average emission limit applicable to the equipment under test. This peak limit applies to the total peak emission level radiated by the device.					
Limit: (Field strength of the fundamental signal)	Frequency	Limit (dBuV/m @3m)		Remark	
	433.92MHz	80.8		Average Value	
		100.8		Peak Value	
Test Procedure:	a. 1) Below 1G: The EUT was placed on the top of a rotating table 0.8 meters above the ground at a 3 meter semi-anechoic chamber. The table was rotated 360 degrees to determine the position of the highest radiation. 2) Above 1G: The EUT was placed on the top of a rotating table 1.5 meters above the ground at a 3 meter semi-anechoic chamber. The table was rotated 360 degrees to determine the position of the highest radiation. Note: For the radiated emission test above 1GHz:				

Place the measurement antenna away from each area of the EUT determined to be a source of emissions at the specified measurement distance, while keeping the measurement antenna aimed at the source of emissions at each frequency of significant emissions, with polarization oriented for maximum response. The measurement antenna may have to be higher or lower than the EUT, depending on the radiation pattern of the emission and staying aimed at the emission source for receiving the maximum signal. The final measurement antenna elevation shall be that which maximizes the emissions. The measurement antenna elevation for maximum emissions shall be restricted to a range of heights of from 1 m to 4 m above the ground or reference ground plane.

- b. The EUT was set 3 meters away from the interference-receiving antenna, which was mounted on the top of a variable-height antenna tower.
- c. The antenna height is varied from one meter to four meters above the ground to determine the maximum value of the field strength. Both horizontal and vertical polarizations of the antenna are set to make the measurement.
- d. For each suspected emission, the EUT was arranged to its worst case and then the antenna was tuned to heights from 1 meter to 4 meters (for the test frequency of below 30MHz, the antenna was tuned to heights 1 meter) and the rotatable table was turned from 0 degrees to 360 degrees to find the maximum reading.
- e. The test-receiver system was set to Peak Detect Function and Specified Bandwidth with Maximum Hold Mode.
- f. If the emission level of the EUT in peak mode was 10dB lower than the limit specified, then testing could be stopped and the peak values of the EUT would be reported. Otherwise the emissions that did not have 10dB margin would be re-tested one by one using peak, quasi-peak or average method as specified and then reported in a data sheet.
- g. The radiation measurements are performed in X, Y, Z axis positioning. And found the Z axis positioning which it is worse case, Only the test worst case mode is recorded in the report.

Test Setup:

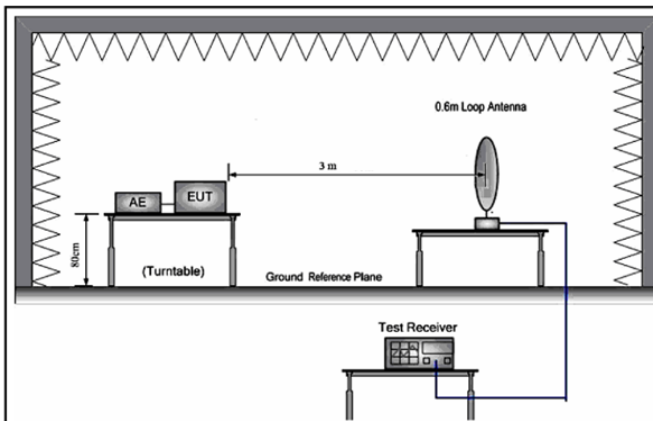

Figure 1. Below 30MHz

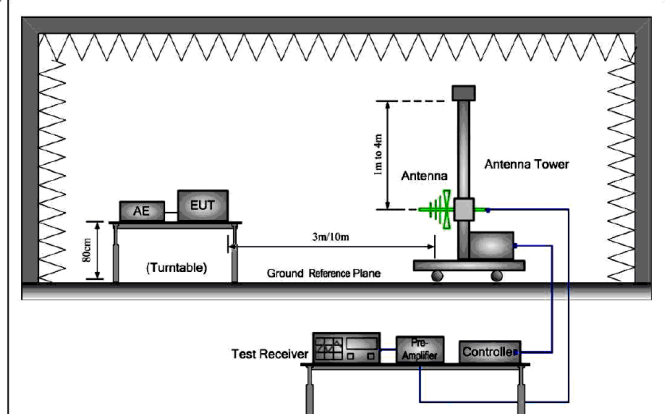

Figure 2. 30MHz to 1GHz

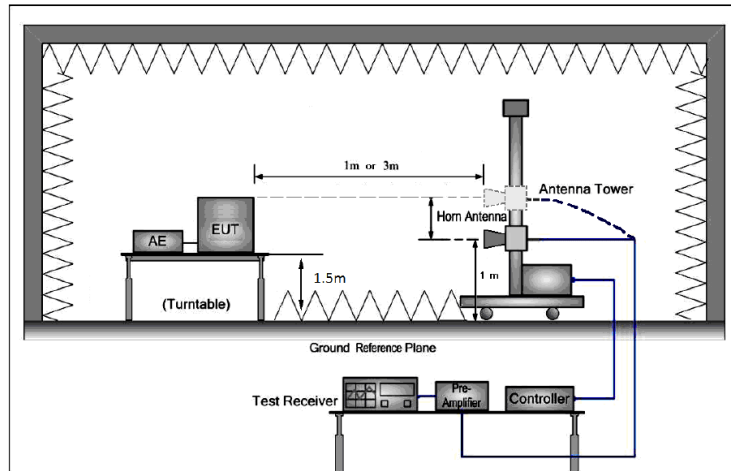

Figure 3. Above 1 GHz

Test Mode:	Transmitting mode
Instruments Used:	Refer to section 5.10 for details
Test Results:	Pass

Measurement Data
6.2.2.1 Field Strength Of The Fundamental Signal

Average value:	
Calculate Formula:	Average value=Peak value + PDCF
	PDCF=20 log(Duty cycle)
	Duty cycle= T on time / T period
Test data:	T on time =14.846ms
	T period =36.66ms
	PDCF=-7.85

Antenna polarization: Horizontal						
Frequency (MHz)	Read Level (dBuV)	Factor (dB)	Level (dBuV/m)	Limit Line (dBuV/m)	Over Limit (dB)	Polarization
433.92	59.39	15.16	74.55	108.8	-34.25	Peak
433.92	-	-	66.70	80.8	-14.10	Average

Antenna polarization: Vertical						
Frequency (MHz)	Read Level (dBuV)	Factor (dB)	Level (dBuV/m)	Limit Line (dBuV/m)	Over Limit (dB)	Polarization
433.92	54.24	15.16	69.40	108.8	-39.40	Peak
433.92	-	-	61.55	80.8	-19.25	Average

Remark:

The field strength is calculated by adding the Antenna Factor, Cable Factor & Preamplifier. The basic equation with a sample calculation is as follows:

Final Test Level =Receiver Reading + Antenna Factor + Cable Factor – Preamplifier Factor

6.2.2.2 Spurious Emissions

9KHz-30MHz

9 kHz~30 MHz Field Strength of Unwanted Emissions. Quasi-Peak Measurement

The measurements with active loop antenna were greater than 20dB below the limit, so the test data were not recorded in the test report.

Below 1GHz (30MHz to 1GHz)

Horizontal

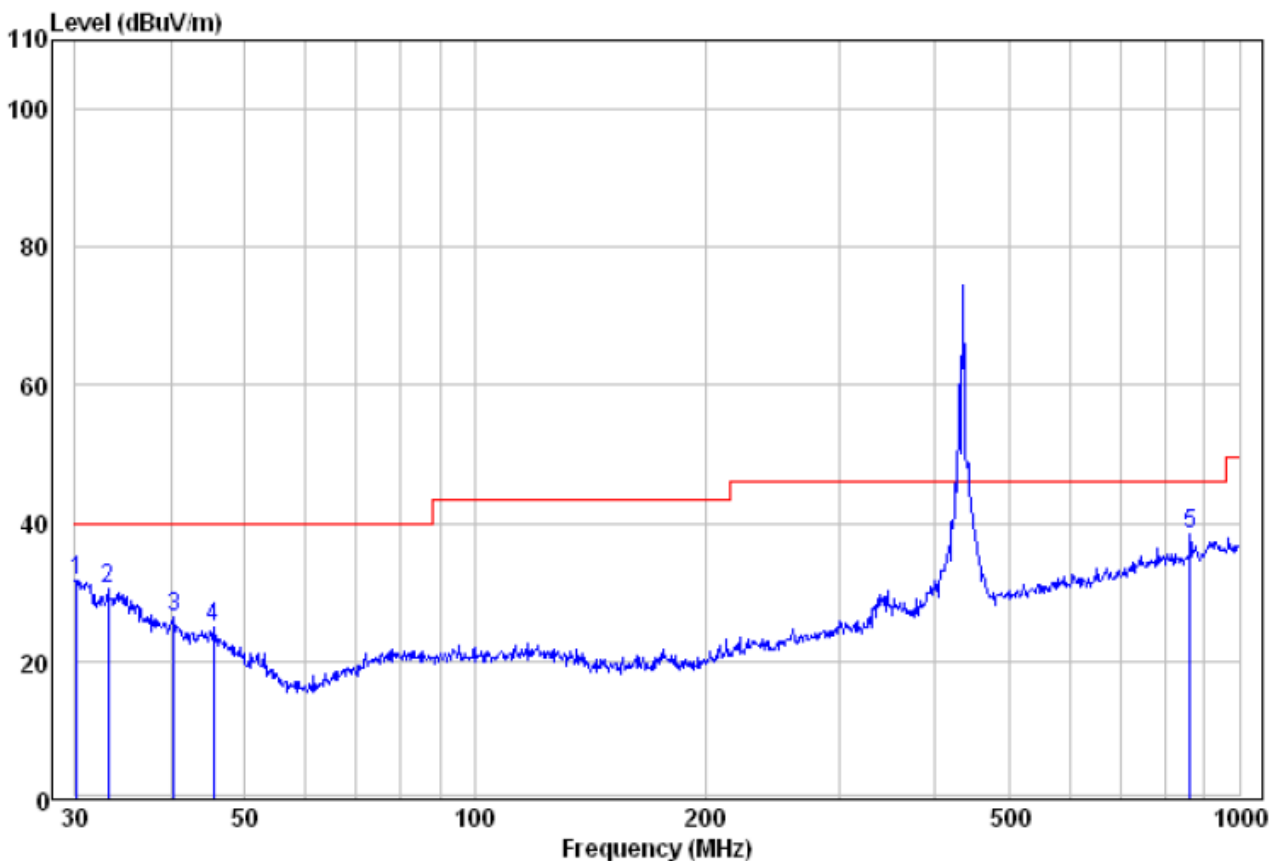

	Freq	Read Level	Factor	Level	Limit Line	Over Limit	Remark	Pol/Phase
	MHz	dBuV	dB/m	dBuV/m	dBuV/m	dB		
1	30.11	12.85	18.90	31.75	40.00	-8.25	Peak	HORIZONTAL
2	33.09	11.82	18.66	30.48	40.00	-9.52	Peak	HORIZONTAL
3	40.42	11.64	14.74	26.38	40.00	-13.62	Peak	HORIZONTAL
4	45.53	13.38	11.62	25.00	40.00	-15.00	Peak	HORIZONTAL
5 pp	863.06	17.90	20.47	38.37	46.00	-7.63	Peak	HORIZONTAL

Vertical

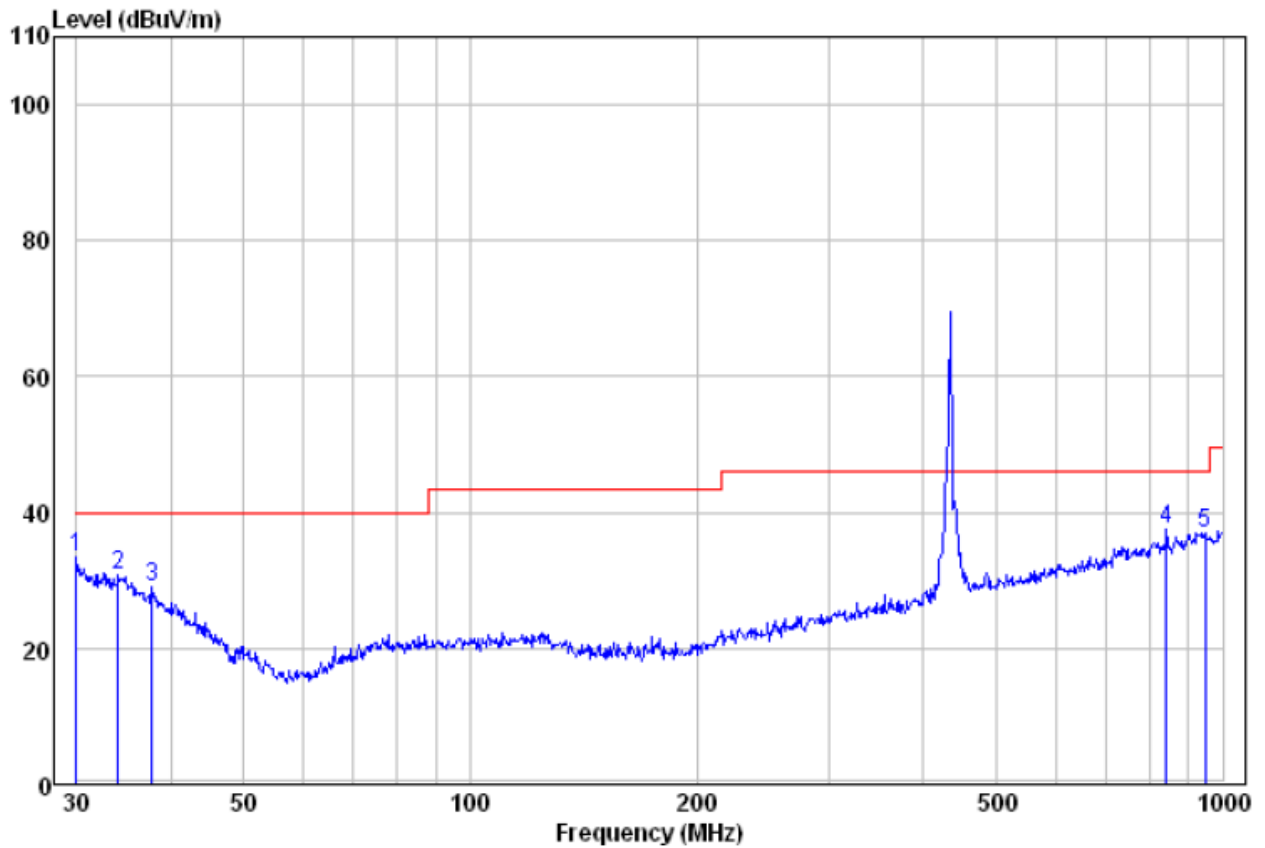

	Freq	Read Level	Factor	Level	Limit Line	Over Limit	Remark	Pol/Phase
	MHz	dBuV	dB/m	dBuV/m	dBuV/m	dB		
1	pp	30.00	14.53	18.91	33.44	40.00	-6.56 Peak	VERTICAL
2		34.04	12.10	18.59	30.69	40.00	-9.31 Peak	VERTICAL
3		37.81	12.65	16.53	29.18	40.00	-10.82 Peak	VERTICAL
4		842.13	17.12	20.50	37.62	46.00	-8.38 Peak	VERTICAL
5		948.76	15.67	21.37	37.04	46.00	-8.96 Peak	VERTICAL

Above 1GHz(1GHz to 6GHz)

Frequency (MHz)	Meter Reading (dB μ V)	Factor (dB)	Emission Level (dB μ V/m)	Limits (dB μ V/m)	Over (dB)	Detector Type	Ant. Pol. H/V
1305.846	48.92	-6.15	42.77	74	-31.23	peak	H
1786.940	50.44	-5.84	44.60	74	-29.40	peak	H
2218.428	52.66	-5.06	47.60	74	-26.40	peak	H
3173.574	54.80	-4.85	49.95	74	-24.05	peak	H
1305.749	49.37	-6.15	43.22	74	-30.78	peak	V
1787.678	50.25	-5.84	44.41	74	-29.59	peak	V
2219.002	52.03	-5.06	46.97	74	-27.03	peak	V
3173.387	54.67	-4.85	49.82	74	-24.18	peak	V

Remark:

- 1) The field strength is calculated by adding the Antenna Factor, Cable Factor & Preamplifier. The basic equation with a sample calculation is as follows:
 Final Test Level = Receiver Reading + Antenna Factor + Cable Factor – Preamplifier Factor
- 2) The disturbance above 4GHz and below 1GHz was very low, and the above harmonics were the highest point could be found when testing, so only the above harmonics had been displayed.
- 3) As shown in this section, for frequencies above 1GHz, the field the strength limits are based on average limits. However, the peak field strength of any emission shall not exceed the maximum permitted aver average limits. Specified above by more than 20dB under any condition of modulation. So, only the peak measurements were show in the report.

6.3 20dB Bandwidth

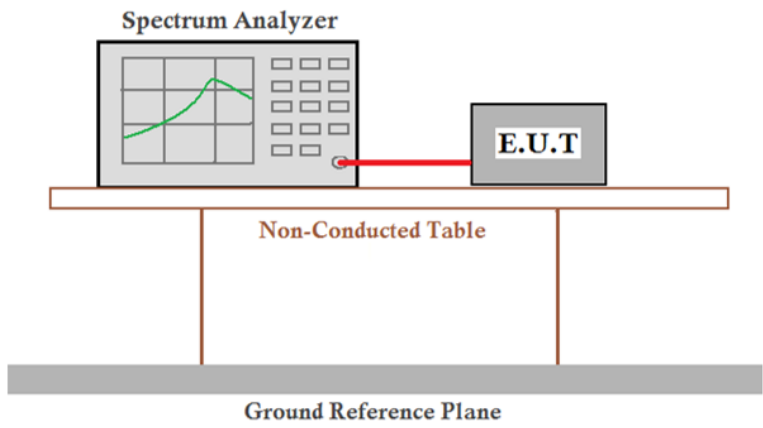
Test Requirement:	47 CFR Part 15C Section 15.231 (c)
Test Method:	ANSI C63.10:2013
Limit:	The bandwidth of the emission shall be no wider than 0.25% of the center frequency for devices operating above 70 MHz and below 900 MHz. For devices operating above 900 MHz, the emission shall be no wider than 0.5% of the center frequency. Bandwidth is determined at the points 20 dB down from the modulated carrier.
Test Setup:	 <p>The diagram illustrates the test setup. A Spectrum Analyzer is connected via a red cable to an E.U.T. (Equipment Under Test). Both are placed on a Non-Conducted Table. Below the table is a Ground Reference Plane.</p>
Test Mode:	Transmitting mode
Instruments Used:	Refer to section 5.10 for details
Test Results:	Pass

Measurement Data

20dB bandwidth (MHz)	Limit (MHz)	Results
0.189	1.0849	PASS

Test plot as follows:

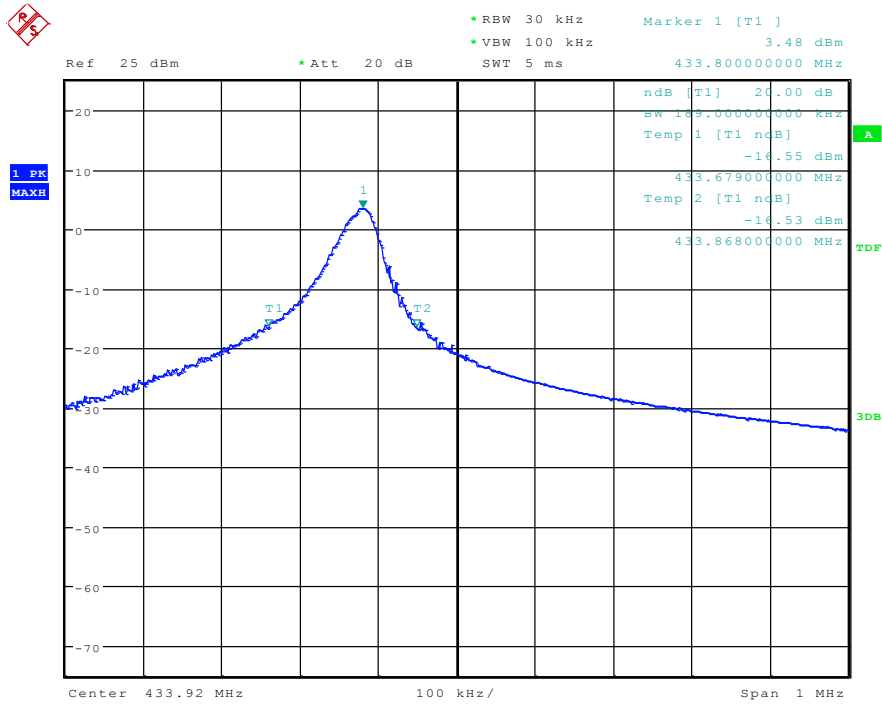

6.4 Dwell time

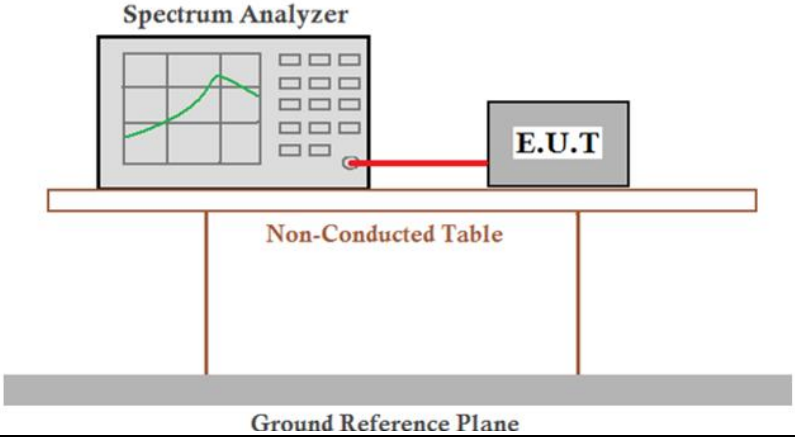
Test Requirement:	47 CFR Part 15C Section 15.231 (a)
Test Method:	ANSI C63.10:2013
Test Setup:	
Limit:	Not more than 5 seconds
Test Mode:	Transmitting mode
Instruments Used:	Refer to section 5.10 for details
Test Results:	Pass

Requirements:

1. Regulation 15.231 (a) The provisions of this Section are restricted to periodic operation within the band 40.66~40.70 MHz and above 70 MHz. Except as shown in paragraph (e) of this Section, the intentional radiator is restricted to the transmission of a control signal such as those used with alarm systems, door openers, remote switches, etc. Radio control of toys is not permitted. Continuous transmissions, such as voice or video, and data transmissions are not permitted. The prohibition against data transmissions does not preclude the use of recognition codes. Those codes are used to identify the sensor that is activated or to identify the particular component as being part of the system.

Result:

The EUT is a remote switch without audio or video transmitted.

The EUT meets the requirements of this section.

2. Regulation 15.231 (a1) A manually operated transmitter shall employ a switch that will automatically deactivate the transmitter within not more than 5 seconds of being released.

Result:

Test item	Limit (MHz)	Results
Transmitting time	≤5S	1.554487S

Test plot as follows:

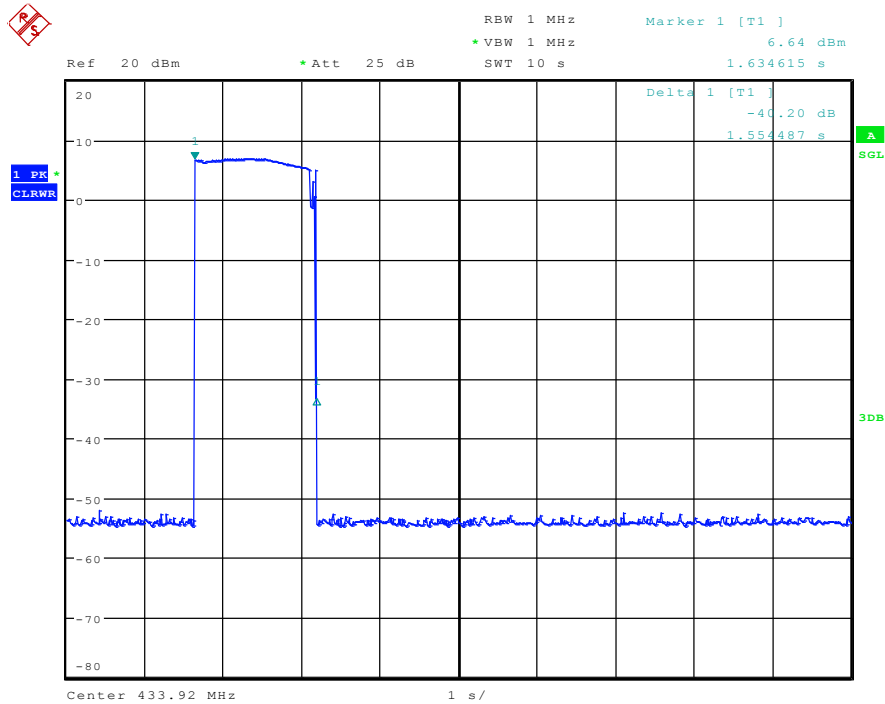

3. Regulation 15.231 (a2) A transmitter activated automatically shall cease transmission within 5 seconds after activation.

Result:

The EUT does not have automatic transmission.

4. Regulation 15.231 (a3) Periodic transmissions at regular predetermined intervals are not permitted. However, polling or supervision transmissions to determine system integrity of transmitters used in security or safety applications are allowed if the periodic rate of transmission does not exceed one transmission of not more than one second duration per hour for each transmitter.

Result:

The EUT does not employ periodic transmission.

5. Regulation 15.231 (a4) Intentional radiators which are employed for radio control purposes during emergencies involving fire, security, and safety of life, when activated to signal an alarm, may operate during the pendency of the alarm condition.

Result:

This section is not applicable to the EUT.

7 Photographs - EUT Test Setup

7.1 Radiated Emission

Below 1GHz:

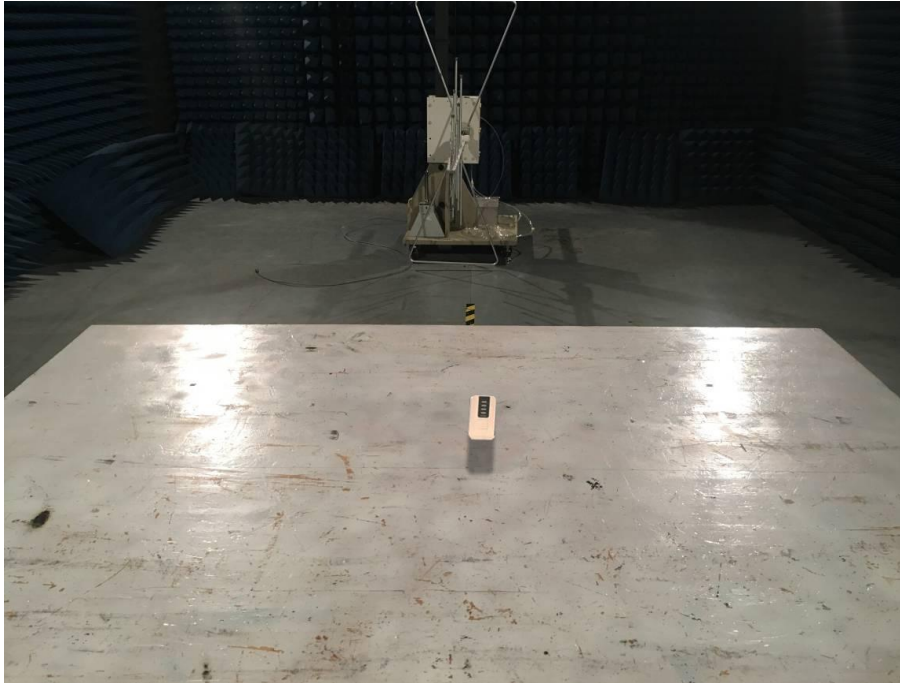

Below 1GHz: The EUT is placed in the 0.8 m high test table

Above 1GHz:



Above 1GHz: Test height 1.5m, the styrofoam block placed in the 0.8 m high test table

8 Photographs - EUT Constructional Details

Test model No.: WA818

