

# FCC Radio Test Report

**FCC ID: 2AK8Q-BM307**

**FCC 47 CFR Part 15 Subpart C**

**RSS 247 Issue 1:2016**

<b>Product</b>	:	Wireless mouse
<b>Trade Name</b>	:	TECKNET
<b>Model No.</b>	:	BM307
<b>Series Model No.</b>	:	N/A

#### Issued for

SHENZHEN UNICHAIN TECHNOLOGY CO., LTD

3 Floor, HongXiangJia electronic commerce Pioneer Park, Yang Mei, BanTian  
Street, Shenzhen City, China

#### Issued by

Shenzhen ATL Testing Technology Co., Ltd.

F/4, Building 10, Dayuan Industrial Zone, Xili Town, Nanshan District, Shenzhen,  
China

Tel.: +86-0755-26909822 Fax.: +86-0755-61605504

Website: [www.atllab.org](http://www.atllab.org)

*Note: This report shall not be reproduced except in full, without the written approval of Shenzhen ATL Testing Technology Co., Ltd.. This document may be altered or revised by Shenzhen ATL Testing Technology Co., Ltd. personnel only, and shall be noted in the revision section of the document. The test results in the report only apply to the tested sample*

**TEST RESULT CERTIFICATION**

**Product** ..... : Wireless mouse  
**Applicant** ..... : SHENZHEN UNICHAIN TECHNOLOGY CO., LTD  
**Address** ..... : 3 Floor, HongXiangJia electronic commerce Pioneer Park, Yang Mei, BanTian Street, Shenzhen City, China  
**Manufacturer** ..... : DONGGUAN TOGRAN ELECTRONICS TECHNOLOGY CO.,LTD  
**Address** ..... : 262 Shidan Rd the 3rd Industrial of Juzhou Shijie Town Dongguan Guangdong China  
**Model No.**..... : BM307  
**Standards** ..... : FCC Part 15 Subpart C (15.247)  
RSS 247 Issue 1: 2016  
**Test Method**..... : ANSI C63.10: 2013

The above equipment has been tested by Shenzhen ATL Testing Technology Co., Ltd. and found compliance with the requirements set forth in the technical standards mentioned above. The results of testing in this report apply only to the product/system, which was tested. Other similar equipment will not necessarily produce the same results due to production tolerance and measurement uncertainties.

**Test**..... :

**Date of receipt of test item** ..... 2017-06-23

**Date(s) of performance of test**..... 2017-06-24 to 2017-06-30

**Test Result** ..... : **Pass**

**Testing by** : *Si feifei* **Date** : 2017-06-24  
(Si feifei)

**Check by** : *Xie Lingling* **Date** : 2017-06-29  
(Xie Lingling)

**Approved by** : *Xu Peng* **Date** : 2017-06-30  
(Xu Peng)

<b>Table of Contents</b>	<b>Page</b>
<b>1 . TEST SUMMARY</b>	<b>6</b>
1.1 TEST FACILITY	7
1.2 MEASUREMENT UNCERTAINTY	7
<b>2 . GENERAL INFORMATION</b>	<b>8</b>
2.1 GENERAL DESCRIPTION OF EUT	8
2.2 DESCRIPTION OF TEST MODES	10
2.3 DESCRIPTION OF TEST SETUP	11
2.4 DESCRIPTION TEST PERIPHERAL AND EUT PERIPHERAL	12
2.5 EUT Exercise Software	12
<b>3 . CONDUCTED EMISSION TEST</b>	<b>13</b>
3.1 CONDUCTED EMISSION MEASUREMENT (Frequency Range 150KHz-30MHz)	13
3.2 TEST PROCEDURE	13
3.3 TEST SETUP	14
3.4 TEST INSTRUMENTS	14
3.5 EUT OPERATING CONDITIONS	14
3.6 TEST RESULTS	14
<b>4 . RADIATED EMISSION MEASUREMENT</b>	<b>15</b>
4.1 RADIATED EMISSION LIMIT (Frequency Range 9KHz-1000MHz)	15
4.2 TEST PROCEDURE	15
4.3 TEST SETUP	16
4.4 TEST INSTRUMENTS	17
4.5 EUT OPERATING CONDITIONS	17
4.6 TEST RESULTS	18
<b>5 . CONDUCTED OUTPUT POWER MEASUREMENT</b>	<b>26</b>
5.1 LIMITS	26
5.2 TEST PROCEDURE	26
5.3 TEST SETUP	26
5.4 TEST INSTRUMENTS	26
5.5 EUT OPERATING CONDITIONS	26
5.6 TEST RESULTS	26

<b>Table of Contents</b>	<b>Page</b>
<b>6 . OCCUPIED BANDWIDTH MEASUREMENT</b>	<b>33</b>
6.1 LIMITS	33
6.2 TEST PROCEDURE	33
6.3 TEST SETUP	33
6.4 TEST INSTRUMENTS	33
6.5 EUT OPERATING CONDITIONS	33
6.6 TEST RESULTS	33
<b>7 . CARRIER FREQUENCY SEPARATION MEASUREMENT</b>	<b>38</b>
7.1 LIMITS	38
7.2 TEST PROCEDURE	38
7.3 TEST SETUP	38
7.4 TEST INSTRUMENTS	38
7.5 EUT OPERATING CONDITIONS	38
7.6 TEST RESULTS	38
<b>8 . NUMBER OF HOPPING</b>	<b>43</b>
8.1 LIMITS	43
8.2 TEST PROCEDURE	43
8.3 TEST SETUP	43
8.4 TEST INSTRUMENTS	43
8.5 EUT OPERATING CONDITIONS	43
8.6 TEST RESULTS	43
<b>9 . DWELL TIME</b>	<b>46</b>
9.1 LIMITS	46
9.2 TEST PROCEDURE	46
9.3 TEST SETUP	46
9.4 TEST INSTRUMENTS	46
9.5 EUT OPERATING CONDITIONS	46
9.6 TEST RESULTS	46
<b>10 . BAND EDGES MEASUREMENT</b>	<b>51</b>
10.1 LIMITS	51
10.2 TEST PROCEDURE	51

<b>Table of Contents</b>	<b>Page</b>
10.3 TEST SETUP	51
10.4 TEST INSTRUMENTS	51
10.5 EUT OPERATING CONDITIONS	52
10.6 TEST RESULTS	52
<b>11. FREQUENCY HOPPING SYSTEM</b>	<b>59</b>
11.1 STANDARD APPLICABLE	59
11.2 FREQUENCY HOPPING SYSTEM	59
11.3 EUT PSEUDORANDOM FREQUENCY HOPPING SEQUENCE	60
<b>12. ANTENNA REQUIREMENT</b>	<b>61</b>
12.1 REQUIREMENT	61
12.2 ANTENNA CONNECTOR CONSTRUCTION	61

**1. TEST SUMMARY**

Test procedures according to the technical standards:

FCC Part 15 Subpart C (15.247)				
Standard Section		Test Item	Judgment	Remark
15.207	RSS Gen 7.2.4	AC Power Conducted Emission	N/A	
15.247(c)	RSS 247 5.5	Transmitter Radiated Emissions	PASS	
15.247(b)(1)	RSS 247 5.1	Output Power	PASS	
15.247(a)(1)	RSS 247 5.1	20dB RF Bandwidth	PASS	
15.247(a)(1)(iii)	RSS 247 5.1	Carrier Frequency Separation	PASS	
15.247(a)(1)(iii)	RSS 247 5.1	Hopping Number	PASS	
15.247(a)(1)(iii)	RSS 247 5.1	Dwell Time	PASS	
15.247(c)	RSS 247 5.1	Occupied Bandwidth Measurement	PASS	
15.247(d)	RSS 247 5.5	Band Edge (Out of Band Emissions)	PASS	
15.247(g)&(h)	----	Frequency Hopping System	PASS	
15.203		Antenna Requirement	PASS	

**NOTE:**

(1) "N/A" denotes test is not applicable in this Test Report

(2) The test results of this report relate only to the tested sample(s) identified in this report.

## 1.1 TEST FACILITY

Shenzhen ATL Testing Technology Co., Ltd.

Add. : F/4, Building 10, Dayuan Industrial Zone, Xili Town, Nanshan District, Shenzhen, China

## 1.2 MEASUREMENT UNCERTAINTY

The reported uncertainty of measurement  $y \pm U$ , where expanded uncertainty  $U$  is based on a standard uncertainty multiplied by a coverage factor of  $k=2$ , providing a level of confidence of approximately **95** %.

### A. Conducted Emission :

The measurement uncertainty is evaluated as  $\pm 3.2$  dB.

### B. Radiated Measurement :

The measurement uncertainty is evaluated as  $\pm 3.7$  dB.

## 2. GENERAL INFORMATION

### 2.1 GENERAL DESCRIPTION OF EUT

<b>Equipment</b>	Wireless mouse
<b>Model Name</b>	BM307
<b>Additional Model Number(s)</b>	N/A
<b>Model Difference</b>	N/A
<b>Frequency Range</b>	Bluetooth 3.0: 2402~2480 MHz
<b>Number of Channel:</b>	79 Channels
<b>Modulation Type</b>	Bluetooth: GFSK/ $\pi$ /4-DQPSK/8-DPSK
<b>RF Output Power</b>	Max: 3.699 dBm(GFSK)
<b>Antenna Type</b>	PCB Antenna (Gain: 0dBi)
<b>Power Source</b>	DC Powered by Battery .
<b>Power Rating</b>	DC 3.0V from 2*AA Battery.
<b>Remark</b>	More details EUT technical specifications, please refer to the User's Manual.

**Note:**

This Test Report is FCC Part 15 Subpart C, 15.247 for Bluetooth. And the Test procedure follows the FCC Public Notice DA 00-705-Filing and Measurement Guidance for Frequency Hopping Spectrum Systems.



(1) Channel List:

Channel	Frequency (MHz)	Channel	Frequency (MHz)	Channel	Frequency (MHz)
00	2402	27	2429	54	2456
01	2403	28	2430	55	2457
02	2404	29	2431	56	2458
03	2405	30	2432	57	2459
04	2406	31	2433	58	2460
05	2407	32	2434	59	2461
06	2408	33	2435	60	2462
07	2409	34	2436	61	2463
08	2410	35	2437	62	2464
09	2411	36	2438	63	2465
10	2412	37	2439	64	2466
11	2413	38	2440	65	2467
12	2414	39	2441	66	2468
13	2415	40	2442	67	2469
14	2416	41	2443	68	2470
15	2417	42	2444	69	2471
16	2418	43	2445	70	2472
17	2419	44	2446	71	2473
18	2420	45	2447	72	2474
19	2421	46	2448	73	2475
20	2422	47	2449	74	2476
21	2423	48	2450	75	2477
22	2424	49	2451	76	2478
23	2425	50	2452	77	2479
24	2426	51	2453	78	2480
25	2427	52	2454		
26	2428	53	2455		

(2) Transmitting mode with antennas

Mode	TX Antenna (s)
Bluetooth	1

## 2.2 DESCRIPTION OF TEST MODES

To investigate the maximum EMI emission characteristics generates from EUT, the test system was pre-scanning tested base on the consideration of following EUT operation mode or test configuration mode which possible have effect on EMI emission level. Each of these EUT operation mode(s) or test configuration mode(s) mentioned above was evaluated respectively.

Pretest Mode	Description
Mode 1	BT TX(GFSK) Mode
Mode 2	BT TX( $\pi$ /4-DQPSK) Mode
Mode 3	BT TX(8-DPSK) Mode

For Conducted Test	
Final Test Mode	Description
Mode 1	N/A

For Radiated Test	
Final Test Mode	Description
Mode 1	BT TX(GFSK) Mode
Mode 2	BT TX(8-DPSK) Mode

**Note:**

- (1) Software used to control the EUT for staying in continuous transmitting mode was programmed. After verification, all tests were carried out with the worst case test modes as shown below.
- (2) GFSK Mode:  
Channel (2402/2441/2480 MHz) with DH1 data packet were chosen for full testing.
- (3) 8-DPSK Mode:  
Channel (2402/2441/2480 MHz) with 3DH1 data packet were chosen for full testing.
- (4) By preliminary testing and verifying three axis (X, Y and Z) position of EUT transmitted status, it was found that "X axis" position was the worst, then the final test was executed the worst condition and test data were recorded in this report.

### 2.3 DESCRIPTION OF TEST SETUP

Radiated Emission

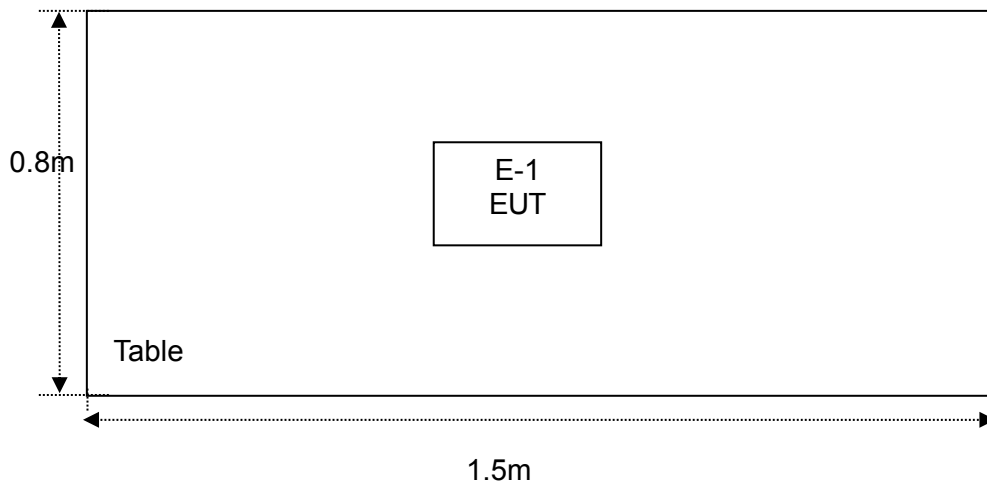

2.4 DESCRIPTION TEST PERIPHERAL AND EUT PERIPHERAL

The EUT has been tested as an independent unit together with other necessary accessories or support units. The following support units or accessories were used to form a representative test configuration during the tests.

Item	Equipment	Mfr/Brand	Model/Type No.	VOC/DOC	Note
E-1	Wireless mouse	TECKNET	BM307	/	EUT

Item	Shielded Type	Ferrite Core	Length	Note

Note:

- (1) The support equipment was authorized by Verification of Confirmation.
- (2) For detachable type I/O cable should be specified the length in cm in 『Length』 column.
- (3) “YES” means “shielded” “with core”; “NO” means “unshielded” “without core”.

2.5 EUT Exercise Software

Test Software	N/A
GFSK: The command set for RF power-DEF 8-DPSK: The command set for RF power-DEF	

### 3. CONDUCTED EMISSION TEST

#### 3.1 CONDUCTED EMISSION MEASUREMENT (Frequency Range 150KHz-30MHz)

FREQUENCY (MHz)	Quasi-peak	Average
	dBuV	dBuV
0.15 -0.5	66 - 56 *	56 - 46 *
0.50 -5.0	56.00	46.00
5.0 -30.0	60.00	50.00

Note:

- (1) The tighter limit applies at the band edges.
- (2) The limit of " \* " marked band means the limitation decreases linearly with the logarithm of the frequency in the range.

The following table is the setting of the receiver

Receiver Parameters	Setting
Attenuation	10 dB
Start Frequency	0.15 MHz
Stop Frequency	30 MHz
IF Bandwidth	9 kHz

#### 3.2 TEST PROCEDURE

- a. The EUT was placed 0.8 meters from the horizontal ground plane with EUT being connected to the power mains through a line impedance stabilization network (LISN). All other support equipments powered from additional LISN(s). The LISN provide 50 Ohm/ 50uH of coupling impedance for the measuring instrument.
- b. Interconnecting cables that hang closer than 40 cm to the ground plane shall be folded back and forth in the center forming a bundle 30 to 40 cm long.
- c. I/O cables that are not connected to a peripheral shall be bundled in the center. The end of the cable may be terminated, if required, using the correct terminating impedance. The overall length shall not exceed 1 m.
- d. LISN at least 80 cm from nearest part of EUT chassis.
- e. For the actual test configuration, please refer to the related Item –EUT Test Photos.

### 3.3 TEST SETUP

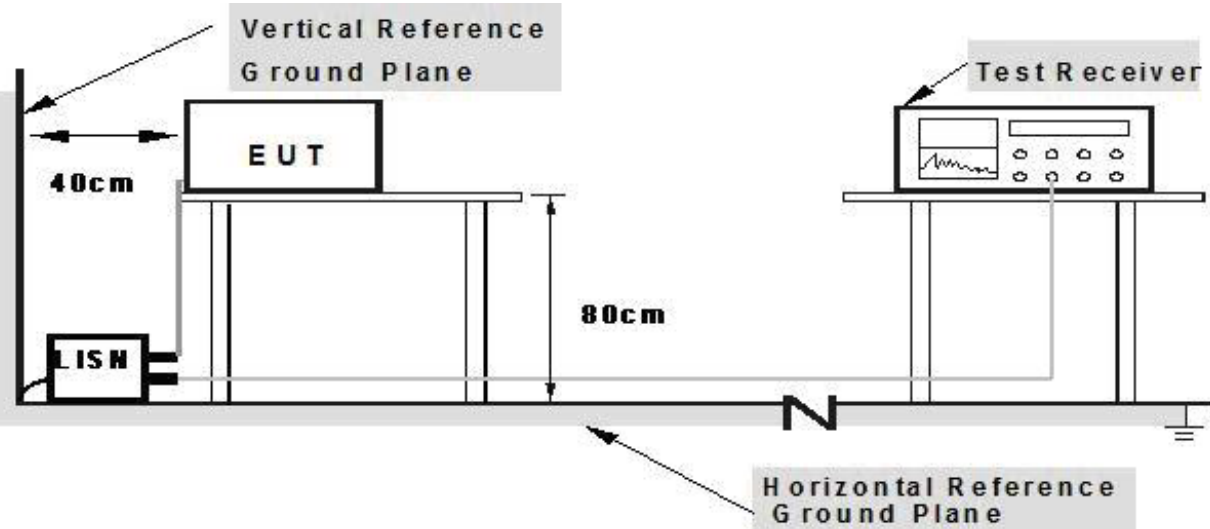

- Note: 1. Support units were connected to second LISN.**  
**2. Both of LISNs (AMN) are 80 cm from EUT and at least 80 cm from other units and other metal planes**

### 3.4 TEST INSTRUMENTS

Equipment	Manufacturer	Type No.	Serial No.	Last calibration	Calibrated until	Calibration period
LISN	R&S	NSLK81	8126466	Jul. 04, 2016	Jul. 03. 2017	1 year
LISN	R&S	NSLK81	8126487	Jul. 04, 2016	Jul. 03. 2017	1 year
50Ω Switch	ANRITSU CORP	MP59B	6200983704	Jul. 04, 2016	Jul. 03. 2017	1 year
Test Cable	N/A	C01	N/A	Jul. 04, 2016	Jul. 03. 2017	1 year
Test Cable	N/A	C02	N/A	Jul. 04, 2016	Jul. 03. 2017	1 year
Test Cable	N/A	C03	N/A	Jul. 04, 2016	Jul. 03. 2017	1 year
EMI Test Receiver	R&S	ESCI	1166.595	Jul. 04, 2016	Jul. 03. 2017	1 year
Passive Voltage Probe	ESH2-Z3	R&S	100196	Jul. 04, 2016	Jul. 03. 2017	1 year

### 3.5 EUT OPERATING CONDITIONS

The EUT tested system was configured as the statements of 2.3 Unless otherwise a special operating condition is specified in the follows during the testing.

### 3.6 TEST RESULTS

The EUT is powered by battery, so no requirement for this test item.

#### 4. RADIATED EMISSION MEASUREMENT

##### 4.1 RADIATED EMISSION LIMIT (Frequency Range 9KHz-1000MHz)

20 dBc in any 100 kHz bandwidth outside the operating frequency band. In case the emission fall within the restricted band specified on 15.205(a), then the 15.209(a) limit in the table bellow has to be followed.

FREQUENCY (MHz)	Field Strength (uV/m at meter)	Measurement Distance (meters)
0.009 -0.490	2400/F(KHz)	300
0.490 -1.705	24000/F(KHz)	30
1.705 -30.0	30	30
30 -88	100	3
88 -216	150	3
216~960	200	3
Above 960	500	3

##### RADIATED EMISSION LIMITS (Above 1000MHz)

FREQUENCY (MHz)	Distance of 3 M (dBuV/m)	
	Peak	Average
Above 1000	74	54

Note:

- (1) The limit for radiated test was performed according to FCC PART 15C.
- (2) The tighter limit applies at the band edges.
- (2) Emission Level(dBuV/m)=20log Emission Level(uV/m)

The following table is the setting of the receiver

Receiver Parameter	Setting
Attenuation	Auto
Start Frequency~ Stop Frequency	9kHz~150kHz/ RB 200Hz for QP
Start Frequency~ Stop Frequency	150kHz~30MHz/ RB 9kHz for QP
Start Frequency~ Stop Frequency	30MHz~1000MHz/ RB120kHz for QP

The following table is the setting of the spectrum

Spectrum Parameter	Setting
Attenuation	Auto
Start Frequency	1000 MHz
Stop Frequency	10 <sup>th</sup> carrier harmonic
RB/ VB (emission in restricted band)	1MHz/ 3 MHz for Peak, 1MHz/ 10Hz for Average

##### 4.2 TEST PROCEDURE

- a. The measuring distance of at 3 m shall be used for measurements at frequency up to 1GHz. For frequencies above 1GHz, any suitable measuring distance may be used.

- b. The EUT was placed on the top of a rotating table 0.8 meters above the ground at a 3 meter open area test site. The table was rotated 360 degrees to determine the position of the highest radiation.
- c. The height of the equipment or of the substitution antenna shall be 0.8 m; the height of the test antenna shall vary between 1 m to 4 m. Both horizontal and vertical polarizations of the antenna are set to make the measurement.
- d. The initial step in collecting conducted emission data is a spectrum analyzer peak detector mode pre-scanning the measurement frequency range. Significant peaks are then marked and then Quasi Peak detector mode re-measured, above 1G Average detector mode will be instead.
- e. If the Peak Mode measured value compliance with and lower than Quasi Peak Mode Limit, the EUT shall be deemed to meet QP Limits and then no additional QP Mode measurement performed.
- f. For the actual test configuration, please refer to the related Item –EUT Test Photos.

Note:

Both horizontal and vertical antenna polarities were tested.

And performed pretest to three orthogonal axis. The worst case emissions were reported.

### 4.3 TEST SETUP

#### (A) Radiated Emission Test Set-Up Frequency 9KHz~30MHz

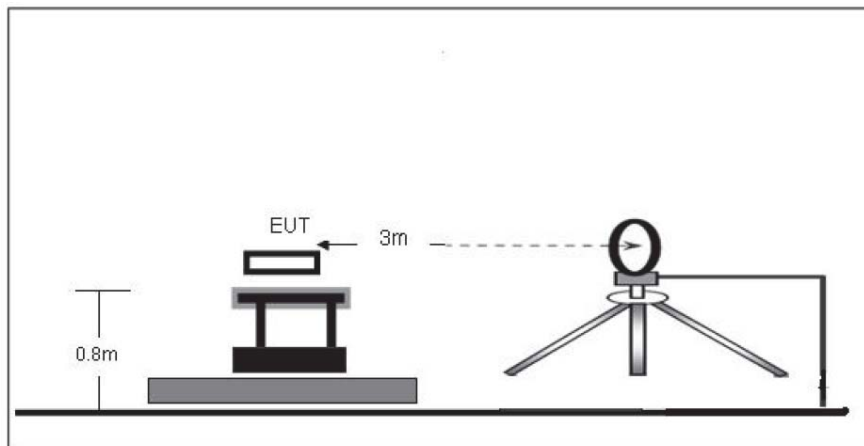

#### (B) Radiated Emission Test Set-Up Frequency Below 1 GHz

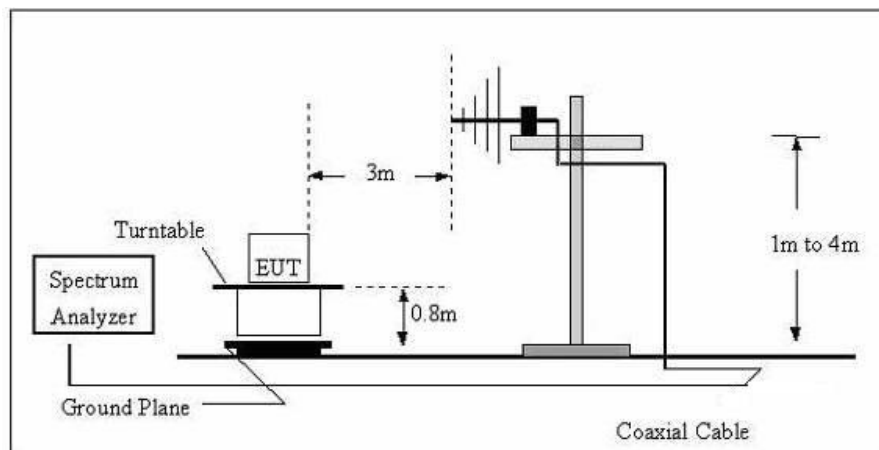



(B) Radiated Emission Test Set-Up Frequency Above 1GHz

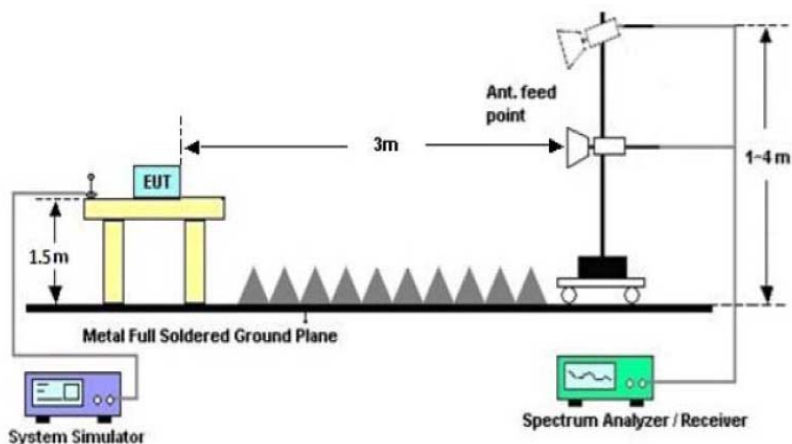

4.4 TEST INSTRUMENTS

Equipment	Manufacturer	Type No.	Serial No.	Last calibration	Calibrated until	Calibration period
Broadband Antenna	R&S	VULB 9168	VULB 9168-456	Jul. 04, 2016	Jul. 03. 2017	1 year
Test Cable	N/A	R-01	N/A	Jul. 04, 2016	Jul. 03. 2017	1 year
Test Cable	N/A	R-02	N/A	Jul. 04, 2016	Jul. 03. 2017	1 year
EMI Test Receiver	R&S	ESCI	101324	Jul. 04, 2016	Jul. 03. 2017	1 year
Antenna Mast	EM	SC100_1	N/A	N/A	N/A	N/A
Turn Table	EM	SC100	060531	N/A	N/A	N/A
50Ω Switch	Anritsu Corp	MP59B	6200983705	Jul. 04, 2016	Jul. 03. 2017	1 year
Spectrum Analyzer	R&S	FSP40	100154	Jul. 04, 2016	Jul. 03. 2017	1 year
Horn Antenna	R&S	HBM30706	10029	Jul. 04, 2016	Jul. 03. 2017	1 year
Amplifier	EM	EM-30180	060538	Jul. 04, 2016	Jul. 03. 2017	1 year

4.5 EUT OPERATING CONDITIONS

The EUT tested system was configured as the statements of 2.3 Unless otherwise a special operating condition is specified in the follows during the testing.

### 4.6 TEST RESULTS

#### 4.6.1 TEST RESULTS (Bellow 1GHz)

EUT :	Wireless mouse	Model Name. :	BM307
Temperature :	26 °C	Relative Humidity :	56%
Pressure :	1010 hPa	Test Date :	2017-06-25
Test Mode :	BT TX Mode	Polarization :	Horizontal
Test Power :	DC 3.0V		

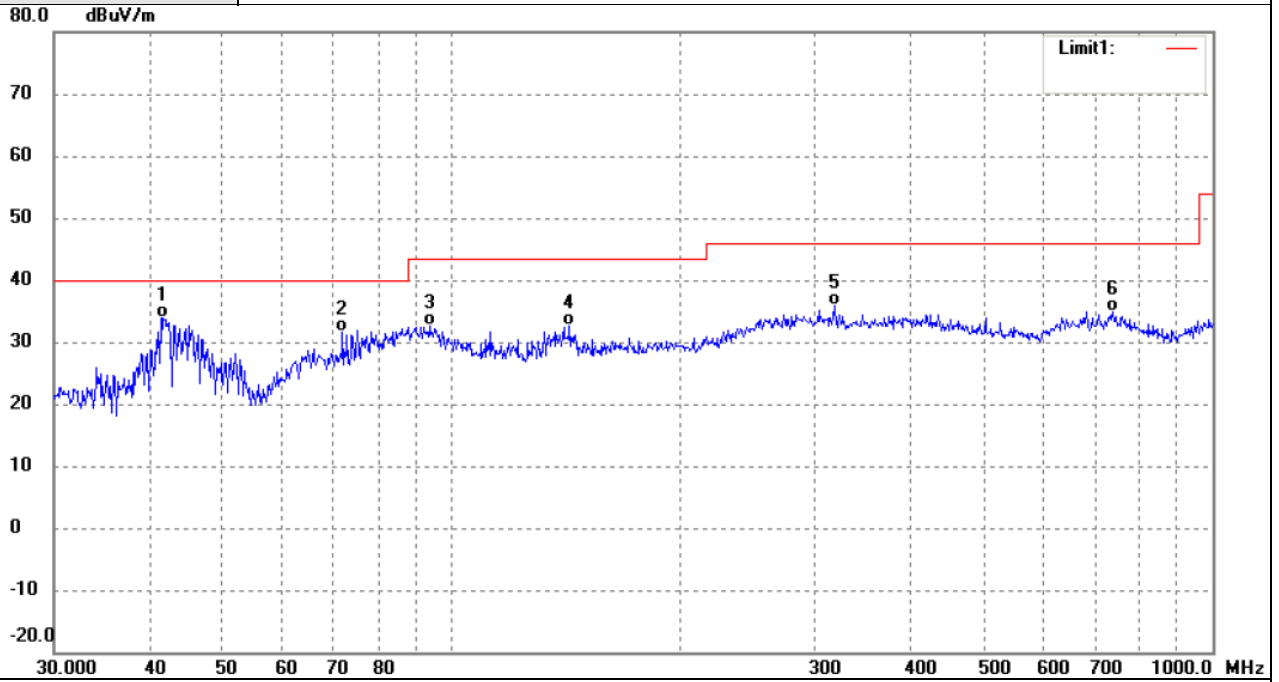

No.	Frequency (MHz)	Reading (dBuV/m)	Correct (dB/m)	Result (dBuV/m)	Limit (dBuV/m)	Margin (dB)	Degree ( )	Height (cm)	Remark
1	41.7130	28.97	4.93	33.90	40.00	-6.10	154	100	peak
2	71.8320	28.91	2.65	31.56	40.00	-8.44	170	100	peak
3	93.4402	28.64	3.96	32.60	43.50	-10.90	56	100	peak
4	142.8244	29.68	3.04	32.72	43.50	-10.78	127	100	peak
5	318.8170	23.89	11.95	35.84	46.00	-10.16	132	100	peak
6	739.6605	15.96	19.00	34.96	46.00	-11.04	337	100	peak

Remark:

Factor = Antenna Factor + Cable Loss.

EUT :	Wireless mouse	Model Name. :	BM307
Temperature :	26 °C	Relative Humidity :	56%
Pressure :	1010 hPa	Test Date :	2017-06-25
Test Mode :	BT TX Mode	Polarization :	Vertical
Test Power :	DC 3.0V		

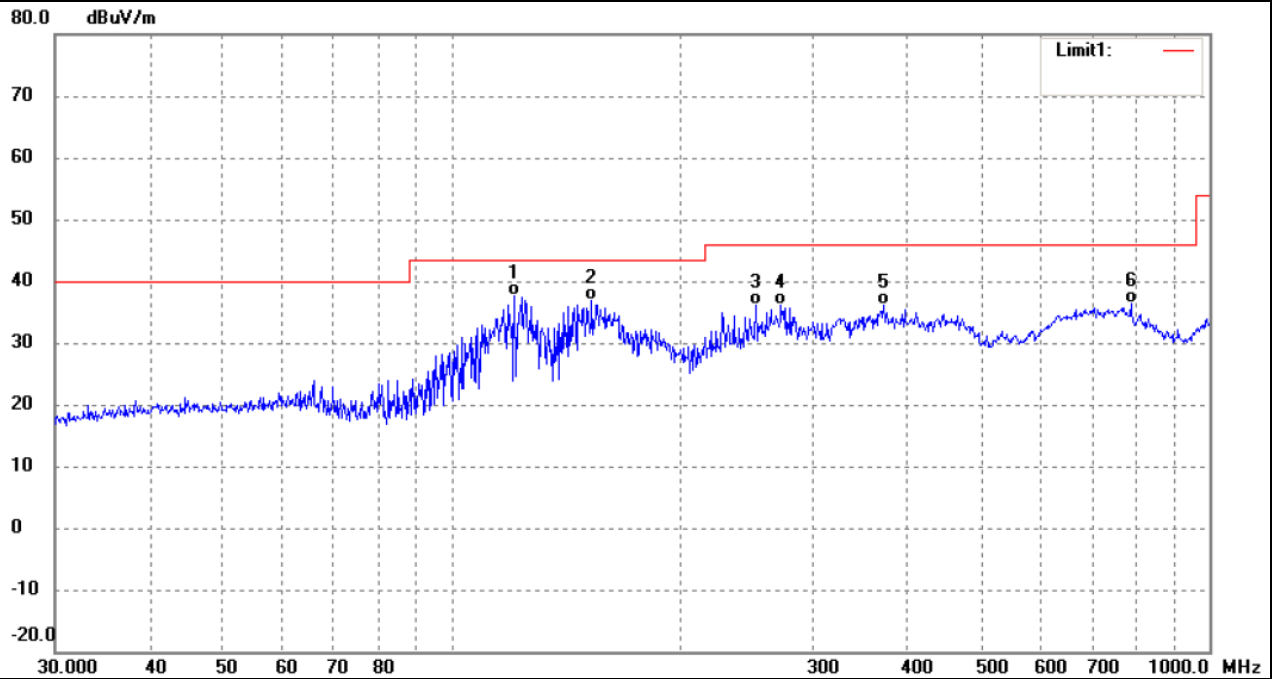

No.	Frequency (MHz)	Reading (dBuV/m)	Correct (dB/m)	Result (dBuV/m)	Limit (dBuV/m)	Margin (dB)	Degree ( )	Height (cm)	Remark
1	121.1231	32.86	4.72	37.58	43.50	-5.92	72	100	peak
2	153.2004	34.23	2.64	36.87	43.50	-6.63	106	100	peak
3	252.0627	26.83	9.38	36.21	46.00	-9.79	86	100	peak
4	272.2776	25.43	10.58	36.01	46.00	-9.99	136	100	peak
5	372.0045	24.17	11.84	36.01	46.00	-9.99	166	100	peak
6	787.8513	19.86	16.59	36.45	46.00	-9.55	282	100	peak

Remark:  
Factor = Antenna Factor + Cable Loss.

4.6.2 TEST RESULTS (Above 1GHz)

<b>EUT :</b>	Wireless mouse			<b>Model Name. :</b>	BM307		
<b>Temperature :</b>	26 °C			<b>Relative Humidity :</b>	56%		
<b>Test Power :</b>	DC 3.0V			<b>Pressure :</b>	1010 hPa		
<b>Test Mode :</b>	GFSK TX 2402MHz			<b>Test Date :</b>	2017-06-25		
<b>Freq.</b>	<b>Deceiver Reading</b>	<b>Detector</b>	<b>Polar</b>	<b>Corrected Factor</b>	<b>Emission Level</b>	<b>Limit</b>	<b>Margin</b>
<b>MHz</b>	<b>dBuV</b>	<b>Peak/Avg</b>	<b>H/V</b>	<b>dB</b>	<b>dBuV /m</b>	<b>dBuV /m</b>	<b>dB</b>
4804	63.96	Peak	H	-3.59	60.37	74	-13.63
4804	50.76	Avg	H	-3.59	47.17	54	-6.83
7206	57.68	Peak	H	-0.52	57.16	74	-16.84
7206	45.16	Avg	H	-0.52	44.64	54	-9.36
---	---	Peak	H			74	
---	---	Avg	H			54	
4804	63.24	Peak	V	-3.59	59.65	74	-14.35
4804	50.36	Avg	V	-3.59	46.77	54	-7.23
7206	56.31	Peak	V	-0.52	55.79	74	-18.21
7206	44.39	Avg	V	-0.52	43.87	54	-10.13
---	---	Peak	V			74	
---	---	Avg	V			54	

Remark:

Emission Level= Read Level+ Correct Factor

Margin= Emission Level-Limit

The testing has been conformed to 10<sup>th</sup> harmonics(1G~25G)

Other harmonics emission are lower then 20dB below the allowable Limit

<b>EUT :</b>	Wireless mouse			<b>Model Name. :</b>	BM307		
<b>Temperature :</b>	26 °C			<b>Relative Humidity :</b>	56%		
<b>Test Power :</b>	DC 3.0V			<b>Pressure :</b>	1010 hPa		
<b>Test Mode :</b>	GFSK TX 2441MHz			<b>Test Date :</b>	2017-06-25		
<b>Freq.</b>	<b>Deceiver Reading</b>	<b>Detector</b>	<b>Polar</b>	<b>Corrected Factor</b>	<b>Emission Level</b>	<b>Limit</b>	<b>Margin</b>
<b>MHz</b>	<b>dBuV</b>	<b>Peak/Avg</b>	<b>H/V</b>	<b>dB</b>	<b>dBuV /m</b>	<b>dBuV /m</b>	<b>dB</b>
4882	63.46	Peak	H	-3.49	59.97	74	-14.03
4882	50.60	Avg	H	-3.49	47.11	54	-6.89
7323	56.13	Peak	H	-0.47	55.66	74	-18.34
7323	45.24	Avg	H	-0.47	44.77	54	-9.23
---	---	Peak	H			74	
---	---	Avg	H			54	
4882	63.95	Peak	V	-3.49	60.46	74	-13.54
4882	50.34	Avg	V	-3.49	46.85	54	-7.15
7323	56.61	Peak	V	-0.47	56.14	74	-17.86
7323	45.52	Avg	V	-0.47	45.05	54	-8.95
---	---	Peak	V			74	
---	---	Avg	V			54	

**Remark:**

Emission Level= Read Level+ Correct Factor

Margin= Emission Level-Limit

The testing has been conformed to 10<sup>th</sup> harmonics(1G~25G)

Other harmonics emission are lower then 20dB below the allowable Limit

<b>EUT :</b>	Wireless mouse			<b>Model Name. :</b>	BM307		
<b>Temperature :</b>	26 °C			<b>Relative Humidity :</b>	56%		
<b>Test Power :</b>	DC 3.0V			<b>Pressure :</b>	1010 hPa		
<b>Test Mode :</b>	GFSK TX 2480MHz			<b>Test Date :</b>	2017-06-25		
<b>Freq.</b>	<b>Deceiver Reading</b>	<b>Detector</b>	<b>Polar</b>	<b>Corrected Factor</b>	<b>Emission Level</b>	<b>Limit</b>	<b>Margin</b>
<b>MHz</b>	<b>dBuV</b>	<b>Peak/Avg</b>	<b>H/V</b>	<b>dB</b>	<b>dBuV /m</b>	<b>dBuV /m</b>	<b>dB</b>
4960	63.98	Peak	H	-3.41	60.57	74	-13.43
4960	50.37	Avg	H	-3.41	46.96	54	-7.04
7440	56.48	Peak	H	-0.42	56.06	74	-17.94
7440	45.21	Avg	H	-0.42	44.79	54	-9.21
---	---	Peak	H			74	
---	---	Avg	H			54	
4960	63.09	Peak	V	-3.41	59.68	74	-14.32
4960	50.54	Avg	V	-3.41	47.13	54	-6.87
7440	57.20	Peak	V	-0.42	56.78	74	-17.22
7440	45.50	Avg	V	-0.42	45.08	54	-8.92
---	---	Peak	V			74	
---	---	Avg	V			54	

**Remark:**

Emission Level= Read Level+ Correct Factor

Margin= Emission Level-Limit

The testing has been conformed to 10<sup>th</sup> harmonics(1G~25G)

Other harmonics emission are lower then 20dB below the allowable Limit

<b>EUT :</b>	Wireless mouse			<b>Model Name. :</b>	BM307		
<b>Temperature :</b>	26 °C			<b>Relative Humidity :</b>	56%		
<b>Test Power :</b>	DC 3.0V			<b>Pressure :</b>	1010 hPa		
<b>Test Mode :</b>	8-DPSK TX 2402MHz			<b>Test Date :</b>	2017-06-25		
Freq.	Deceiver Reading	Detector	Polar	Corrected Factor	Emission Level	Limit	Margin
MHz	dBuV	Peak/Avg	H/V	dB	dBuV /m	dBuV /m	dB
4804	62.75	Peak	H	-3.59	59.16	74	-14.84
4804	51.61	Avg	H	-3.59	48.02	54	-5.98
7206	58.03	Peak	H	-0.52	57.51	74	-16.49
7206	45.18	Avg	H	-0.52	44.66	54	-9.34
---	---	Peak	H			74	
---	---	Avg	H			54	
4804	62.73	Peak	V	-3.59	59.14	74	-14.86
4804	51.36	Avg	V	-3.59	47.77	54	-6.23
7206	56.94	Peak	V	-0.52	56.42	74	-17.58
7206	44.18	Avg	V	-0.52	43.66	54	-10.34
---	---	Peak	V			74	
---	---	Avg	V			54	

**Remark:**

Emission Level= Read Level+ Correct Factor

Margin= Emission Level-Limit

The testing has been conformed to 10<sup>th</sup> harmonics(1G~25G)

Other harmonics emission are lower then 20dB below the allowable Limit

<b>EUT :</b>	Wireless mouse			<b>Model Name. :</b>	BM307		
<b>Temperature :</b>	26 °C			<b>Relative Humidity :</b>	56%		
<b>Test Power :</b>	DC 3.0V			<b>Pressure :</b>	1010 hPa		
<b>Test Mode :</b>	8-DPSK TX 2441MHz			<b>Test Date :</b>	2017-06-25		
Freq.	Deceiver Reading	Detector	Polar	Corrected Factor	Emission Level	Limit	Margin
MHz	dBuV	Peak/Avg	H/V	dB	dBuV /m	dBuV /m	dB
4882	65.45	Peak	H	-3.49	61.96	74	-12.04
4882	53.12	Avg	H	-3.49	49.63	54	-4.37
7323	59.39	Peak	H	-0.47	58.92	74	-15.08
7323	46.15	Avg	H	-0.47	45.68	54	-8.32
---	---	Peak	H			74	
---	---	Avg	H			54	
4882	65.46	Peak	V	-3.49	61.97	74	-12.03
4882	52.77	Avg	V	-3.49	49.28	54	-4.72
7323	58.51	Peak	V	-0.47	58.04	74	-15.96
7323	45.64	Avg	V	-0.47	45.17	54	-8.83
---		Peak	V			74	
---		Avg	V			54	

Remark:

Emission Level= Read Level+ Correct Factor

Margin= Emission Level-Limit

The testing has been conformed to 10<sup>th</sup> harmonics(1G~25G)

Other harmonics emission are lower then 20dB below the allowable Limit



<b>EUT :</b>	Wireless mouse			<b>Model Name. :</b>	BM307		
<b>Temperature :</b>	26 °C			<b>Relative Humidity :</b>	56%		
<b>Test Power :</b>	DC 3.0V			<b>Pressure :</b>	1010 hPa		
<b>Test Mode :</b>	8-DPSK TX 2480MHz			<b>Test Date :</b>	2017-06-25		
Freq.	Deceiver Reading	Detector	Polar	Corrected Factor	Emission Level	Limit	Margin
MHz	dBuV	Peak/Avg	H/V	dB	dBuV /m	dBuV /m	dB
4960	65.96	Peak	H	-3.41	62.55	74	-11.45
4960	53.9	Avg	H	-3.41	50.49	54	-3.51
7440	57.94	Peak	H	-0.42	57.52	74	-16.48
7440	46.70	Avg	H	-0.42	46.28	54	-7.72
---	---	Peak	H			74	
---	---	Avg	H			54	
4960	64.85	Peak	V	-3.41	61.44	74	-12.56
4960	53.46	Avg	V	-3.41	50.05	54	-3.95
7440	58.43	Peak	V	-0.42	58.01	74	-15.99
7440	47.05	Avg	V	-0.42	46.63	54	-7.37
---		Peak	V			74	
---		Avg	V			54	

Remark:

Emission Level= Read Level+ Correct Factor

Margin= Emission Level-Limit

The testing has been conformed to 10<sup>th</sup> harmonics(1G~25G)

Other harmonics emission are lower then 20dB below the allowable Limit

## 5. CONDUCTED OUTPUT POWER MEASUREMENT

### 5.1 LIMITS

Peak Output Power	Hopping Channels>75 Power<1W(30dBm) Other <125 mW(21dBm)
-------------------	---

### 5.2 TEST PROCEDURE

The EUT was directly connected to the spectrum analyzer and antenna output port as show in the block diagram above.

Spectrum Setting:

Peak Detector: RBW=1 MHz, VBW=3 MHz for bandwidth less than 1MHz.  
RBW=3 MHz, VBW=3 MHz for bandwidth more than 1MHz.

### 5.3 TEST SETUP

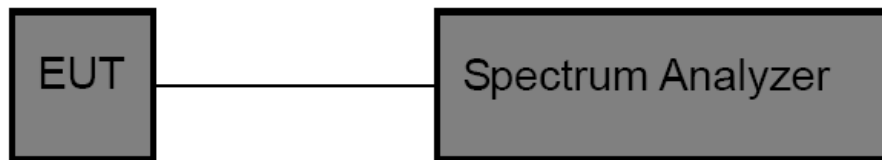

### 5.4 TEST INSTRUMENTS

Equipment	Manufacturer	Type No.	Serial No.	Last calibration	Calibrated until	Calibration period
Spectrum Analyzer	R&S	FSP40	100154	Jul. 04, 2016	Jul. 03. 2017	1 year
Spectrum Analyzer	Agilent	E4407B	MY41440432	Jul. 04, 2016	Jul. 03. 2017	1 year

### 5.5 EUT OPERATING CONDITIONS

The EUT was set to continuously transmitting in the maximum power during the test.

### 5.6 TEST RESULTS

GFSK (1Mbps)		
Frequency (MHz)	Peak Output Power (dBm)	Limit (dBm)
2402	3.582	<30
2441	3.699	
2480	3.582	

2402 MHz

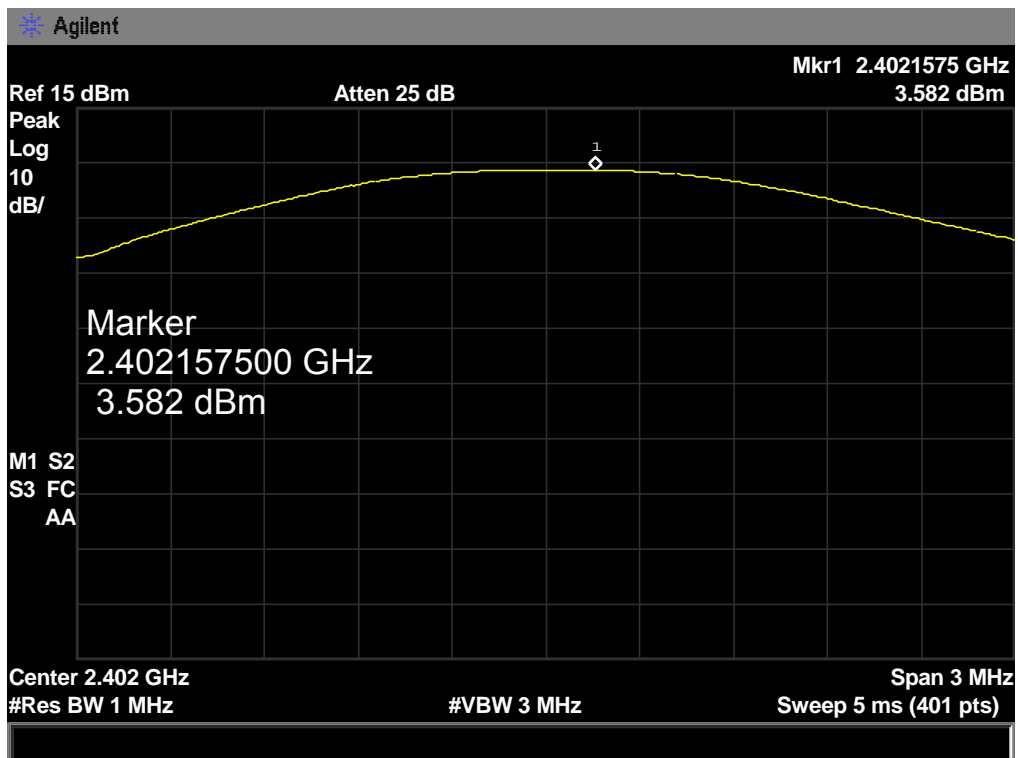

### 2441 MHz

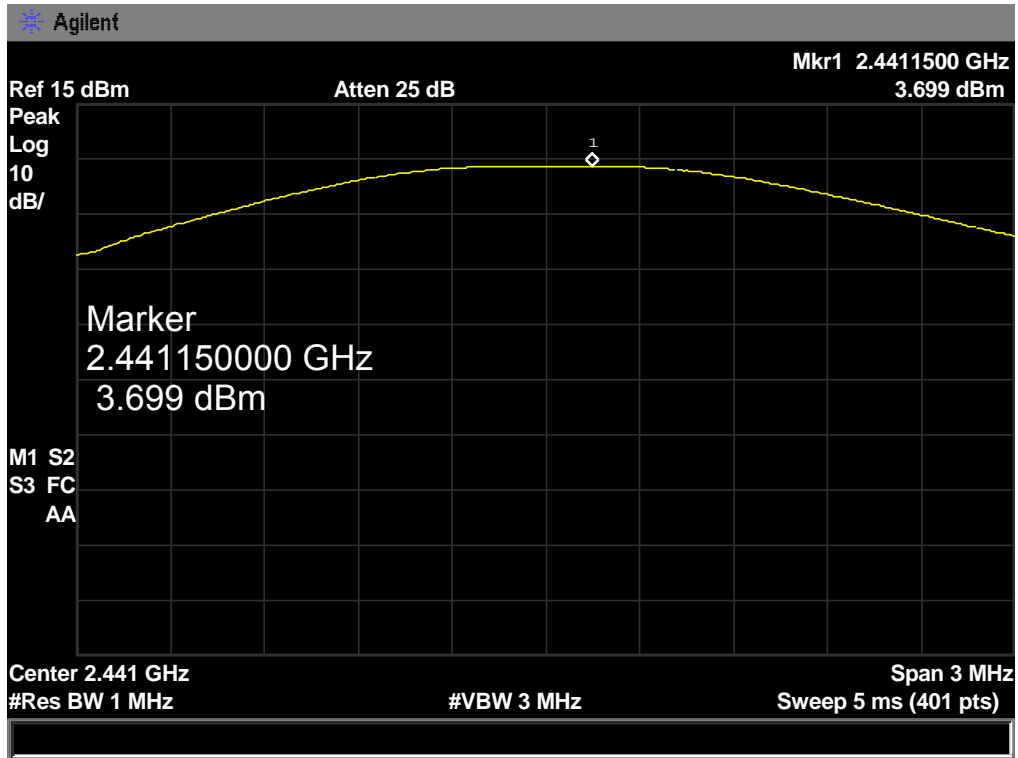

### 2480 MHz

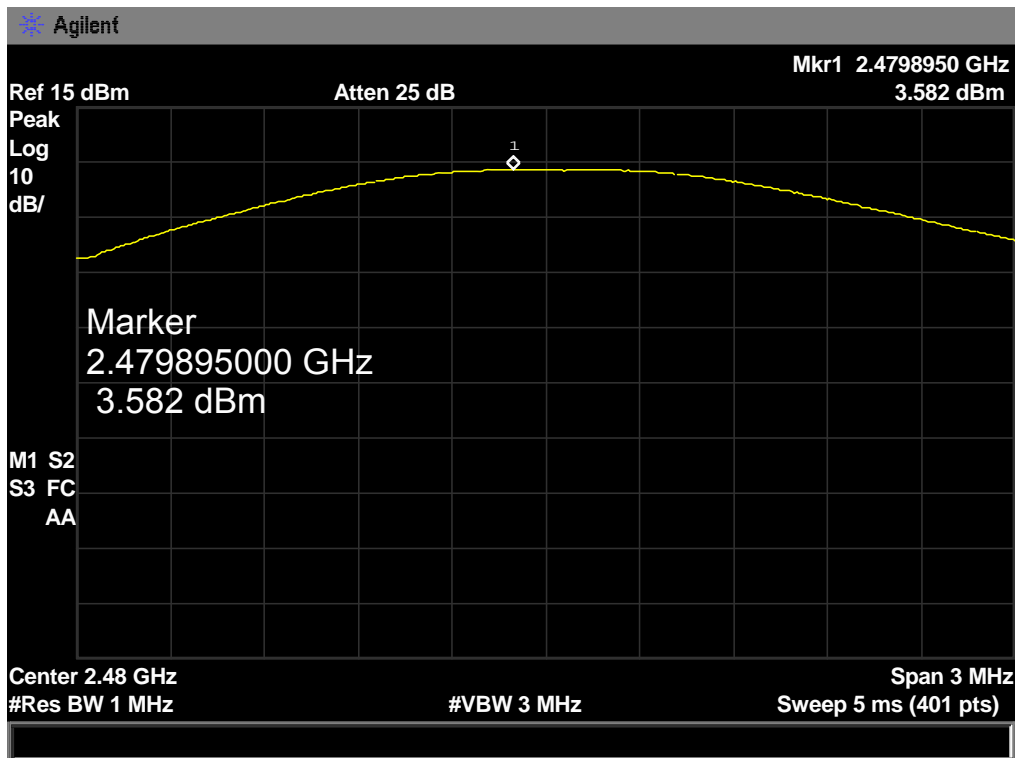

$\pi/4$ -DQPSK (2Mbps)		
Frequency (MHz)	Peak Output Power (dBm)	Limit (dBm)
2402	2.213	<21
2441	2.389	
2480	2.273	

2402 MHz

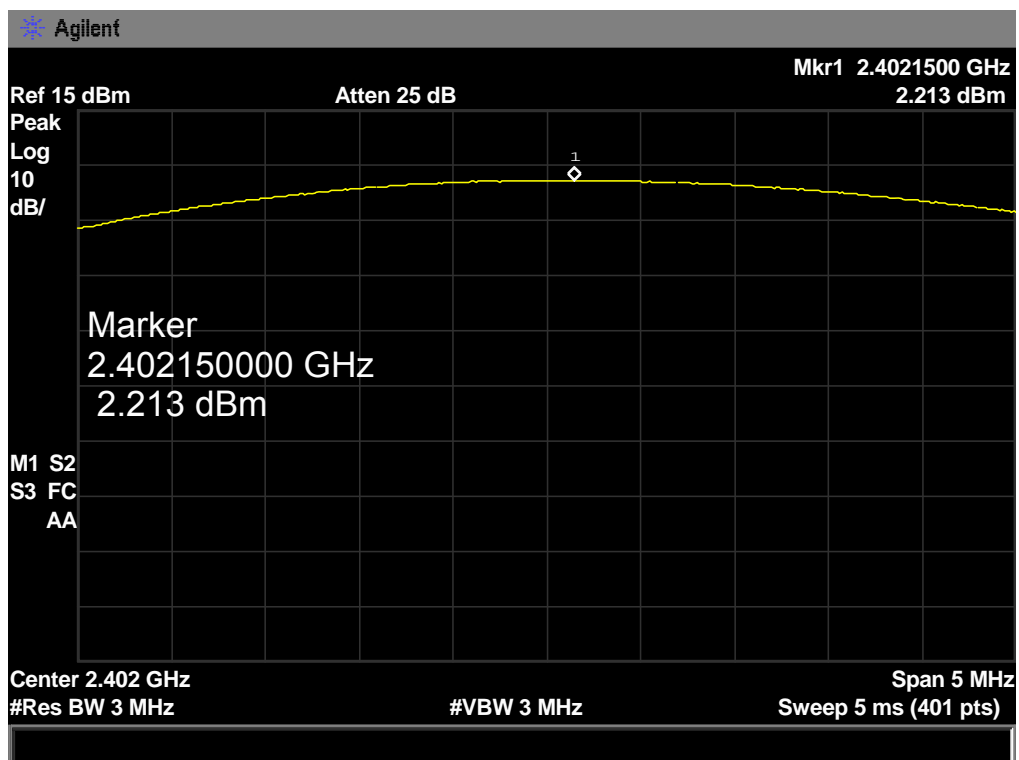

2441 MHz

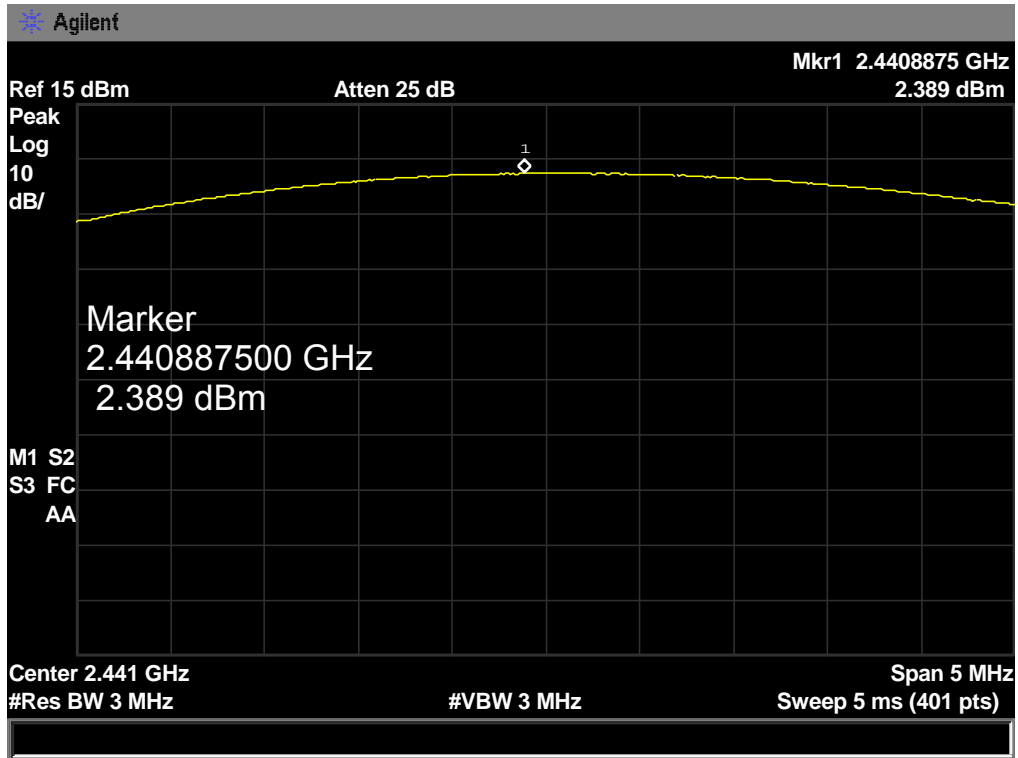

2480 MHz

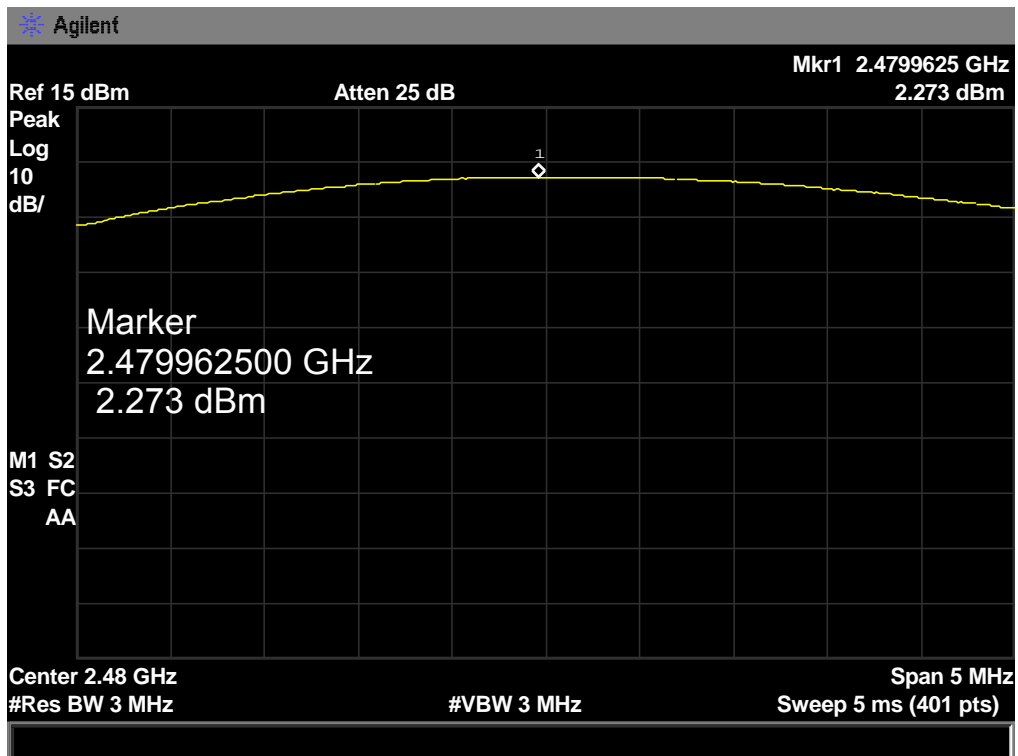

8-DPSK (3Mbps)		
Frequency (MHz)	Peak Output Power (dBm)	Limit (dBm)
2402	2.357	<21
2441	2.521	
2480	2.395	

2402 MHz

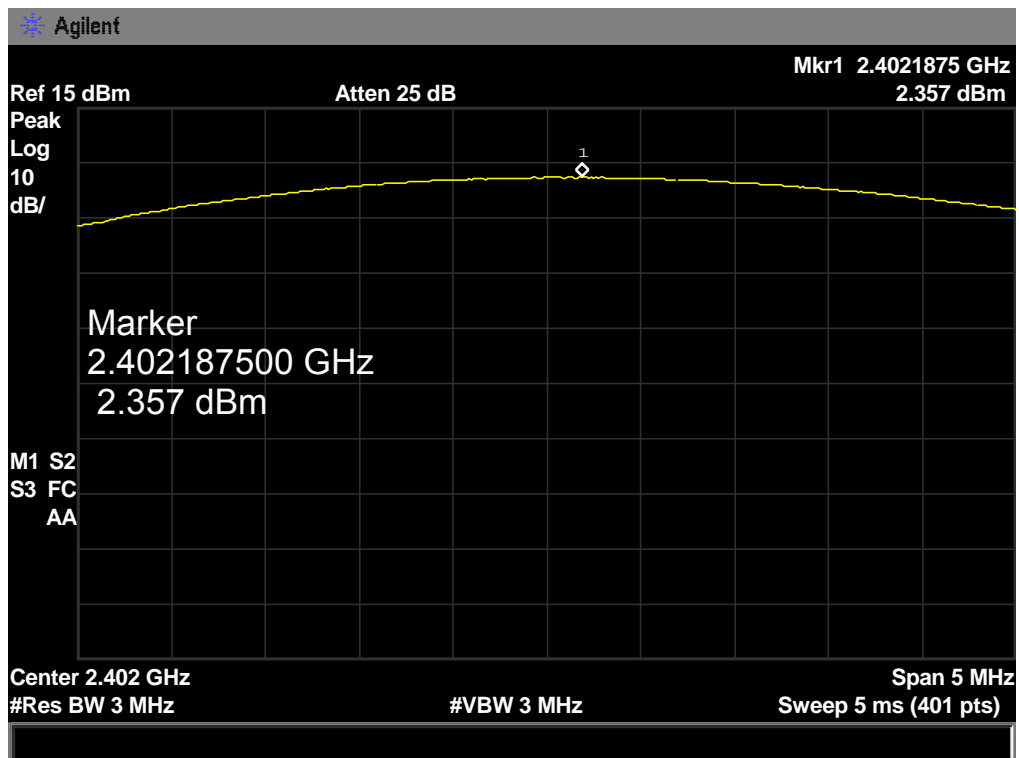

### 2441 MHz

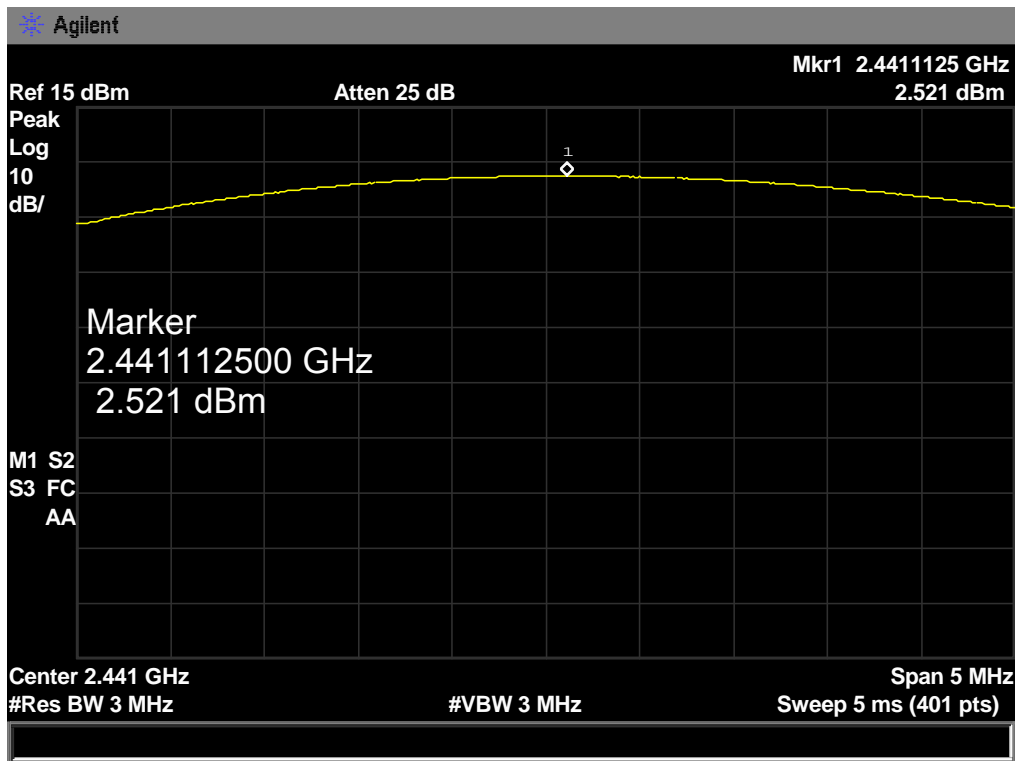

### 2480 MHz

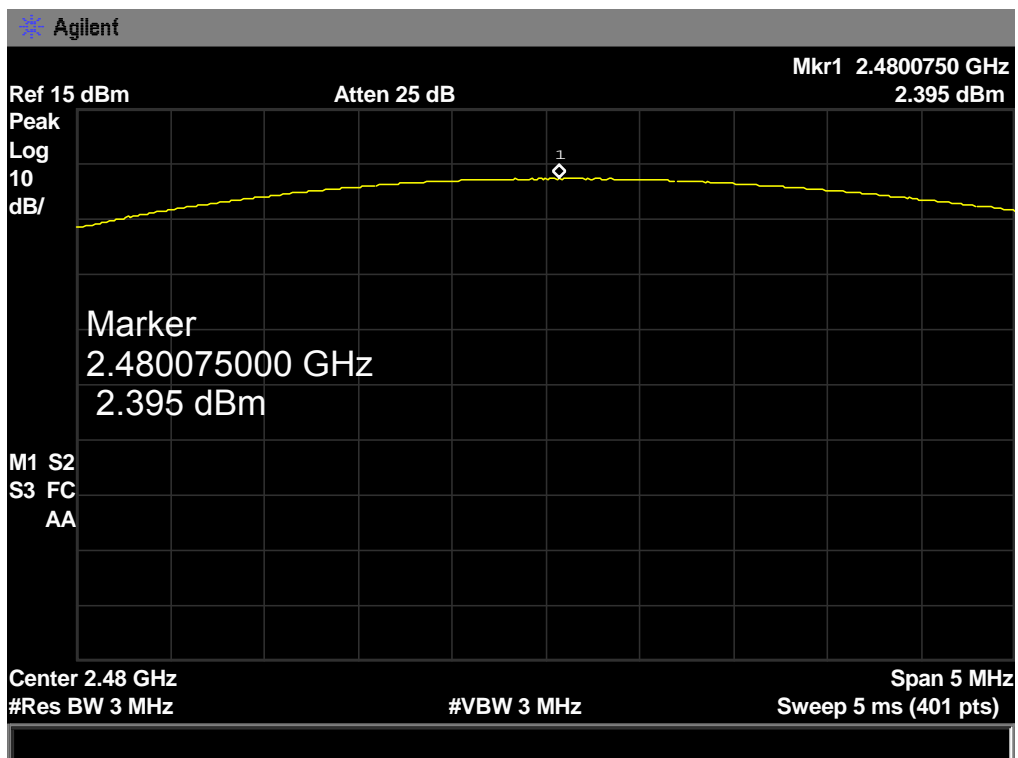



## 6. OCCUPIED BANDWIDTH MEASUREMENT

### 6.1 LIMITS

Test Item	Limit	Frequency Range(MHz)
Bandwidth	$\leq 1$ MHz (20dB bandwidth)	2400~2483.5
Channel Separation	$>25$ KHz or $>$ two-thirds of the 20 dB bandwidth Which is greater	2400~2483.5

### 6.2 TEST PROCEDURE

The EUT was directly connected to the Spectrum analyzer and antenna output port as show in the block diagram as bellow.

### 6.3 TEST SETUP

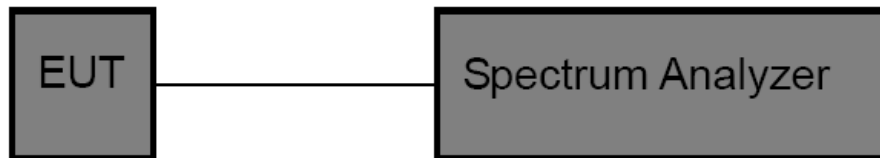

### 6.4 TEST INSTRUMENTS

Equipment	Manufacturer	Type No.	Serial No.	Last calibration	Calibrated until	Calibration period
Spectrum Analyzer	R&S	FSP40	100154	Jul. 04, 2016	Jul. 03. 2017	1 year
Spectrum Analyzer	Agilent	E4407B	MY41440432	Jul. 04, 2016	Jul. 03. 2017	1 year

### 6.5 EUT OPERATING CONDITIONS

The EUT was set to continuously transmitting in the maximum power during the test.

### 6.6 TEST RESULTS

GFSK Mode (1Mbps)			
Frequency (MHz)	20dB Bandwidth (kHz)	99% OBW (kHz)	20dB Bandwidth *2/3 (kHz)
2402	856.582	840.6225	
2441	861.276	838.7580	
2480	922.500	837.7272	

**Note:** Test plots please refer following pages.

**2402 MHz(GFSK) Bandwidth**

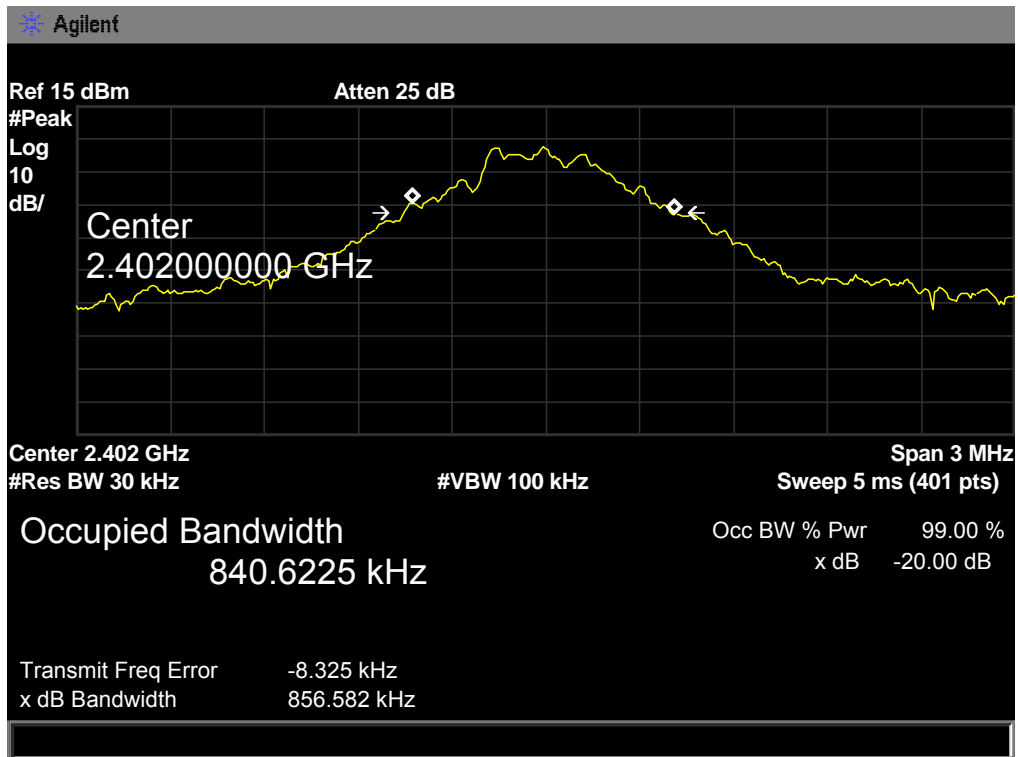

### 2441 MHz(GFSK) Bandwidth

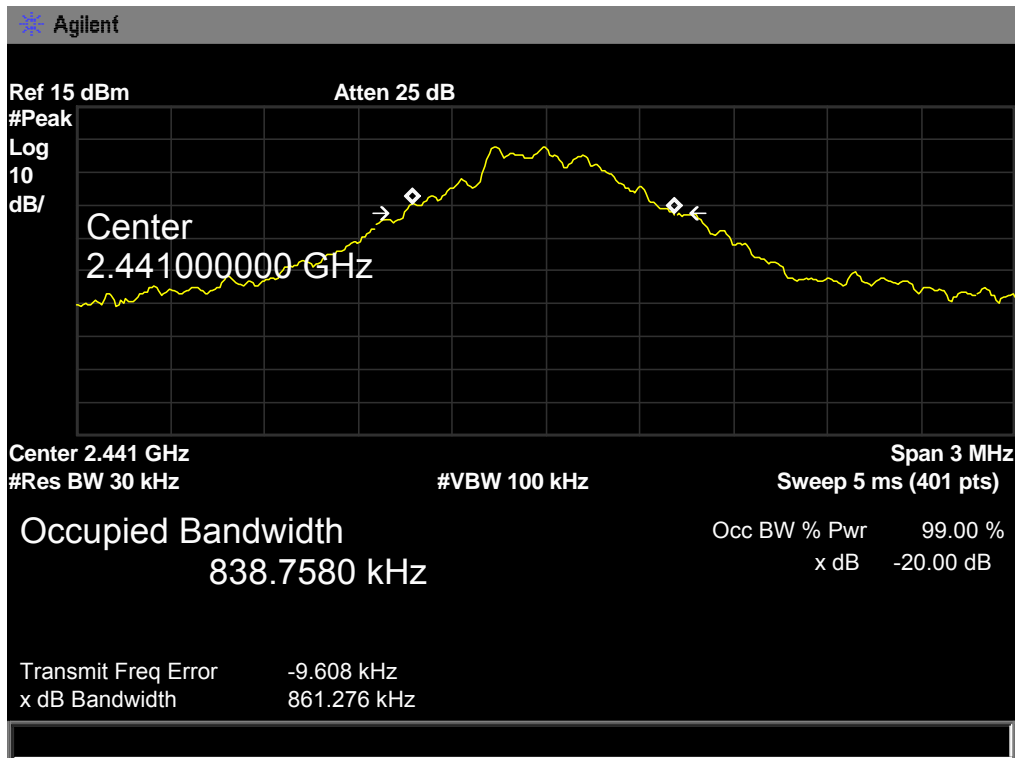

### 2480 MHz(GFSK) Bandwidth

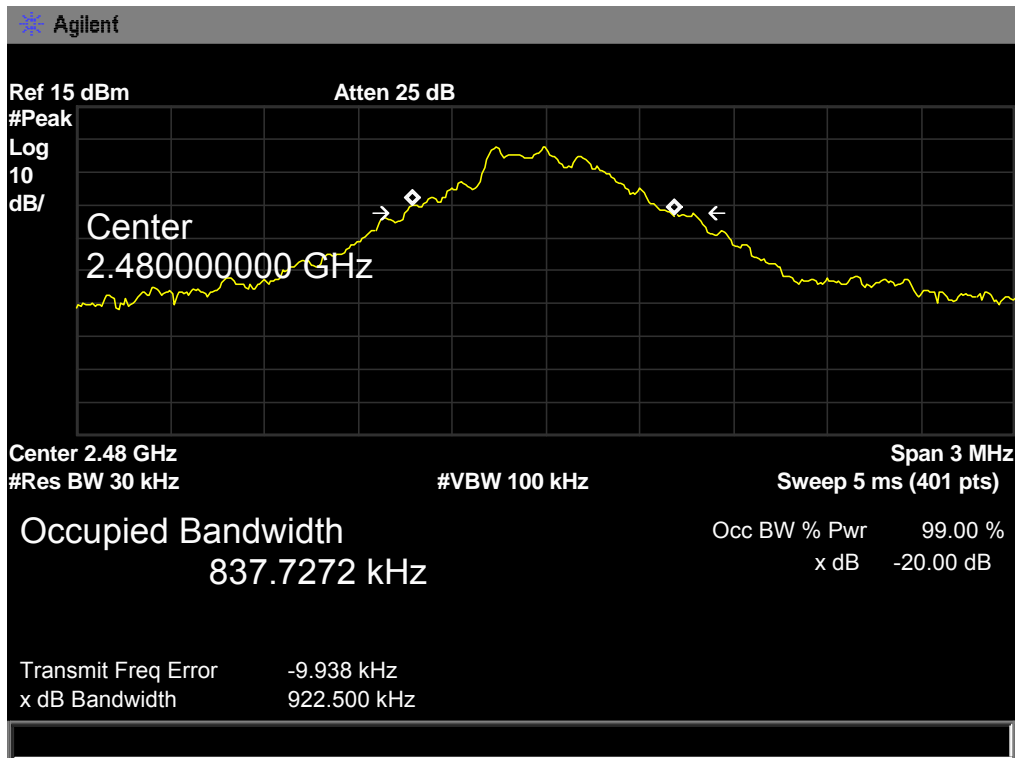

8-DPSK Mode (3Mbps)			
Frequency (MHz)	20dB Bandwidth (kHz)	99% OBW (kHz)	20dB Bandwidth *2/3 (kHz)
2402	1242.00	1148.500	828.00
2441	1208.00	1148.200	805.33
2480	1216.00	1151.200	810.67

**Note:** Test plots please refer following pages.

2402 MHz(8-DPSK) Bandwidth

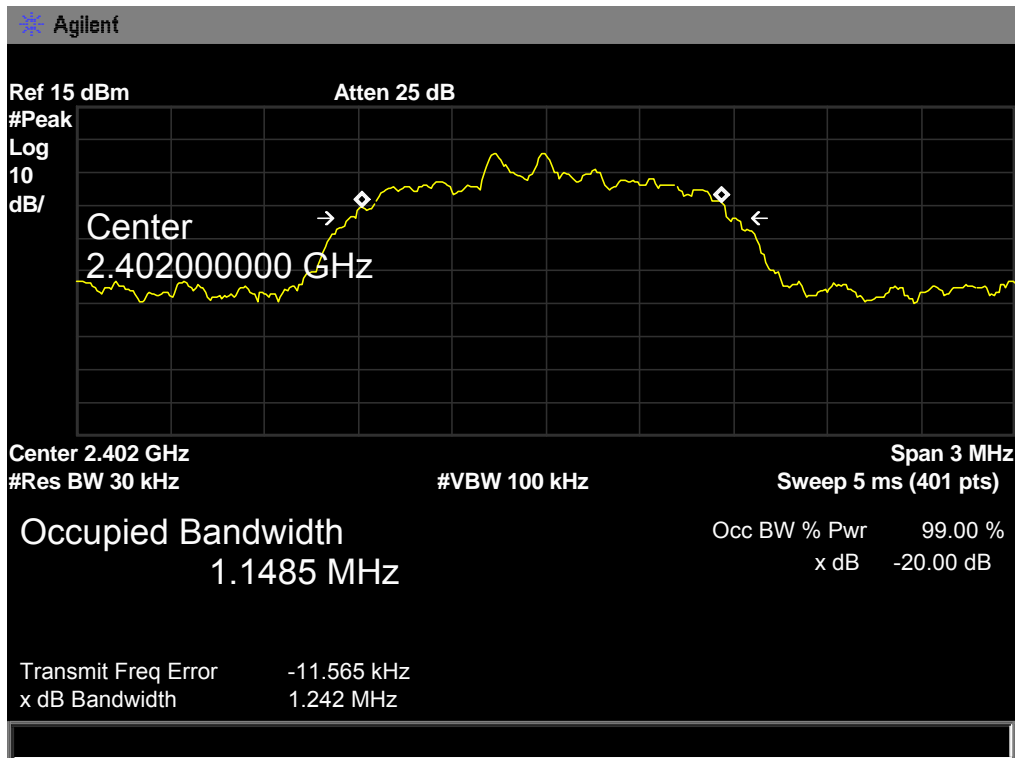

### 2441 MHz(8-DPSK) Bandwidth

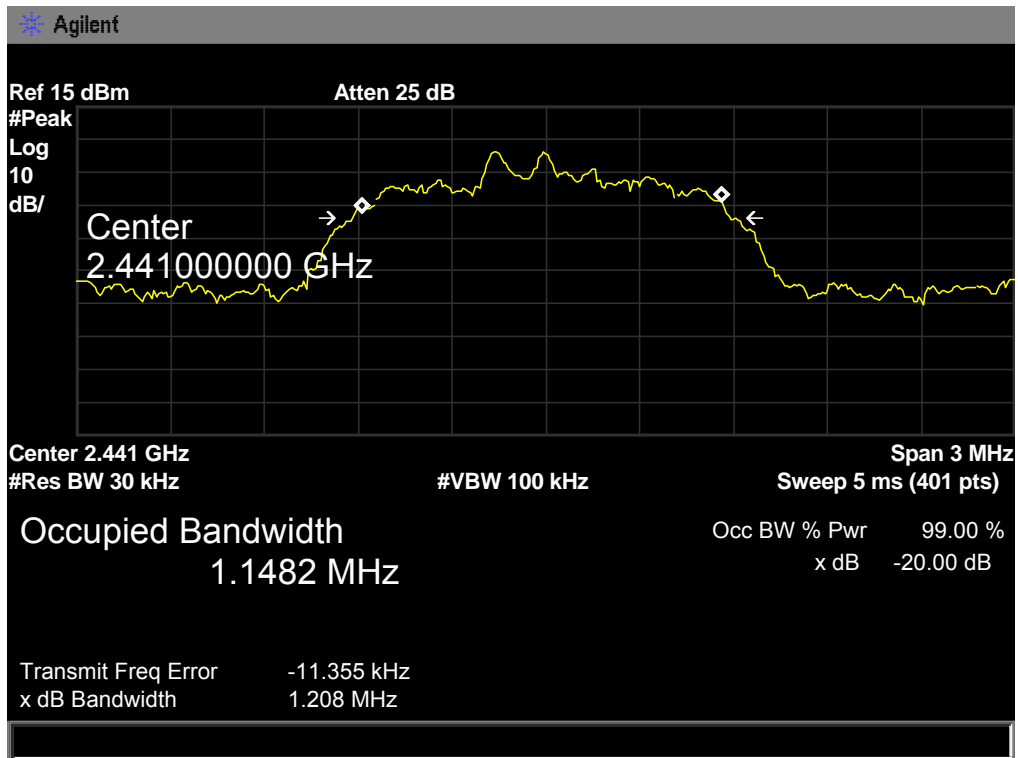

### 2480 MHz(8-DPSK) Bandwidth

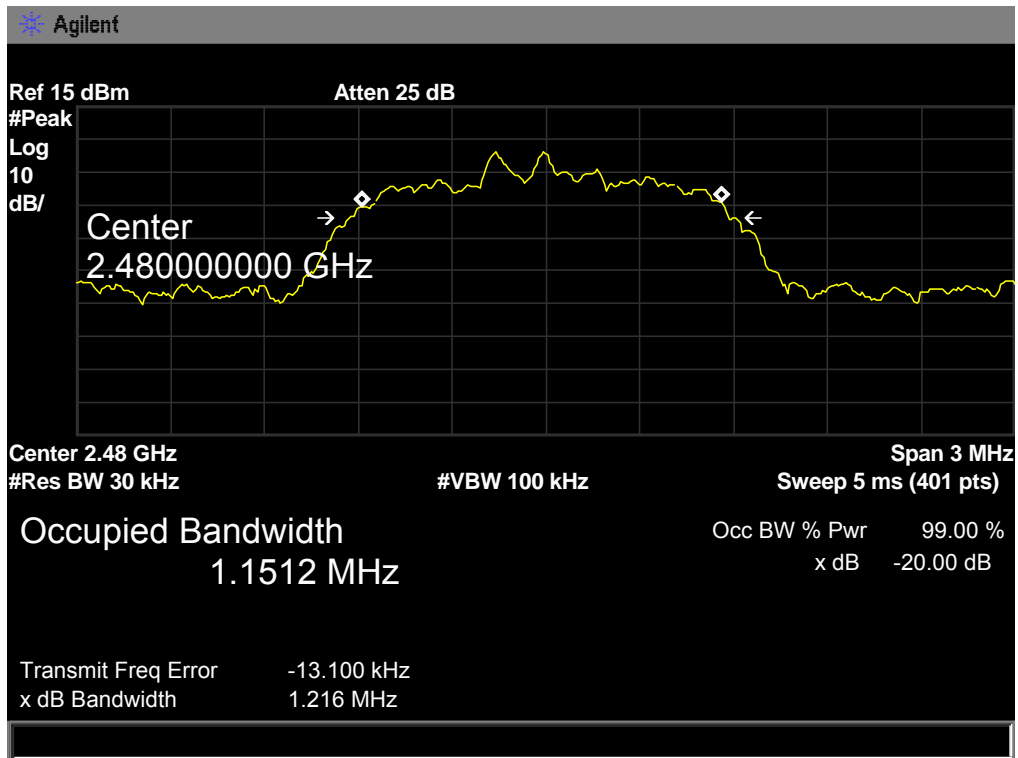

## 7. CARRIER FREQUENCY SEPARATION MEASUREMENT

### 7.1 LIMITS

Frequency Separation	The channel spacing shall be a minimum of 25 kHz or two-thirds of the 20 dB Bandwidth
----------------------	---

### 7.2 TEST PROCEDURE

The EUT was directly connected to the Spectrum analyzer and antenna output port as show in the block diagram as bellow.

- a. Set span= wide enough to capture the peaks of two adjacent channels.
- b. Set the RBW  $\geq$  1% of the span
- c. Set the VBW  $\geq$  3 RBW (30kHz/ 100kHz)
- d. Detector= Peak.
- e. Sweep time= auto couple
- f. Trace mode= max hold.
- g. Allow trace to fully stabilize.
- h. Use the marker-delta function to determine the separation between the peaks of the adjacent channels.

### 7.3 TEST SETUP

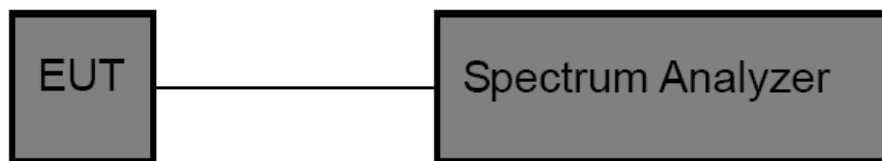

### 7.4 TEST INSTRUMENTS

Equipment	Manufacturer	Type No.	Serial No.	Last calibration	Calibrated until	Calibration period
Spectrum Analyzer	R&S	FSP40	100154	Jul. 04, 2016	Jul. 03. 2017	1 year
Spectrum Analyzer	Agilent	E4407B	MY41440432	Jul. 04, 2016	Jul. 03. 2017	1 year

### 7.5 EUT OPERATING CONDITIONS

The EUT was set to continuously transmitting in the maximum power during the test.

### 7.6 TEST RESULTS

GFSK Mode (1Mbps)		
Frequency (MHz)	Channel Separation (kHz)	Limit (kHz)
2402	1005.00	856.582
2441	1005.00	861.276
2480	1005.00	922.500

**Note:** Test plots please refer following pages.

**2402 MHz(GFSK)-Channel Separation**

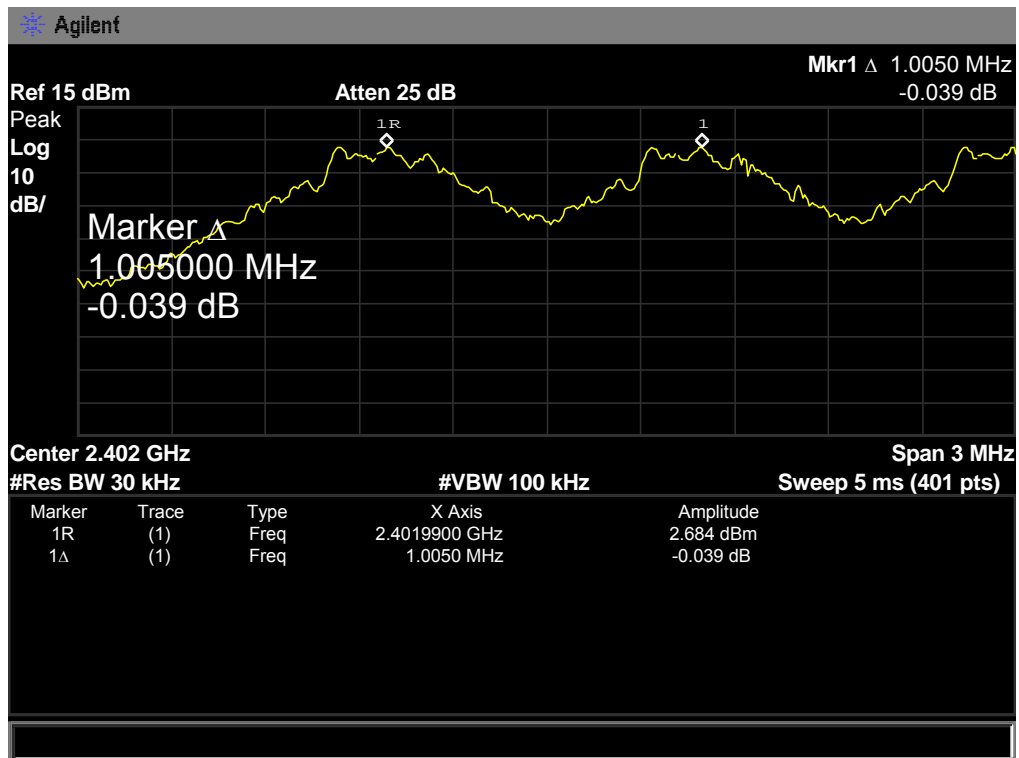

### 2441 MHz(GFSK)-Channel Separation

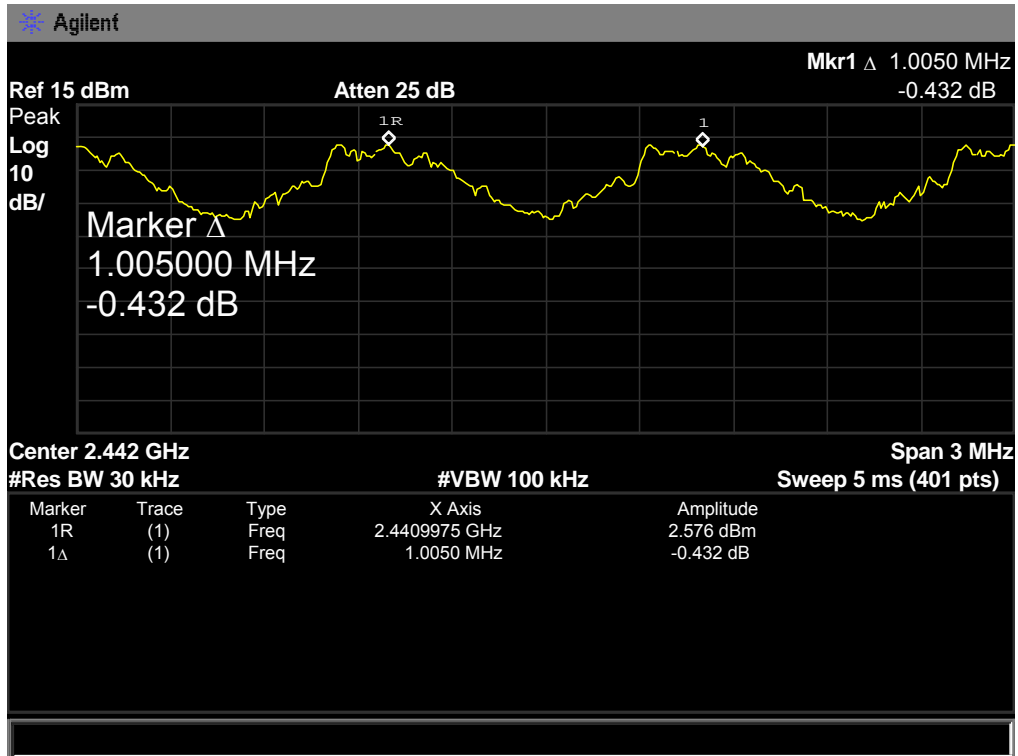

### 2480 MHz(GFSK)-Channel Separation

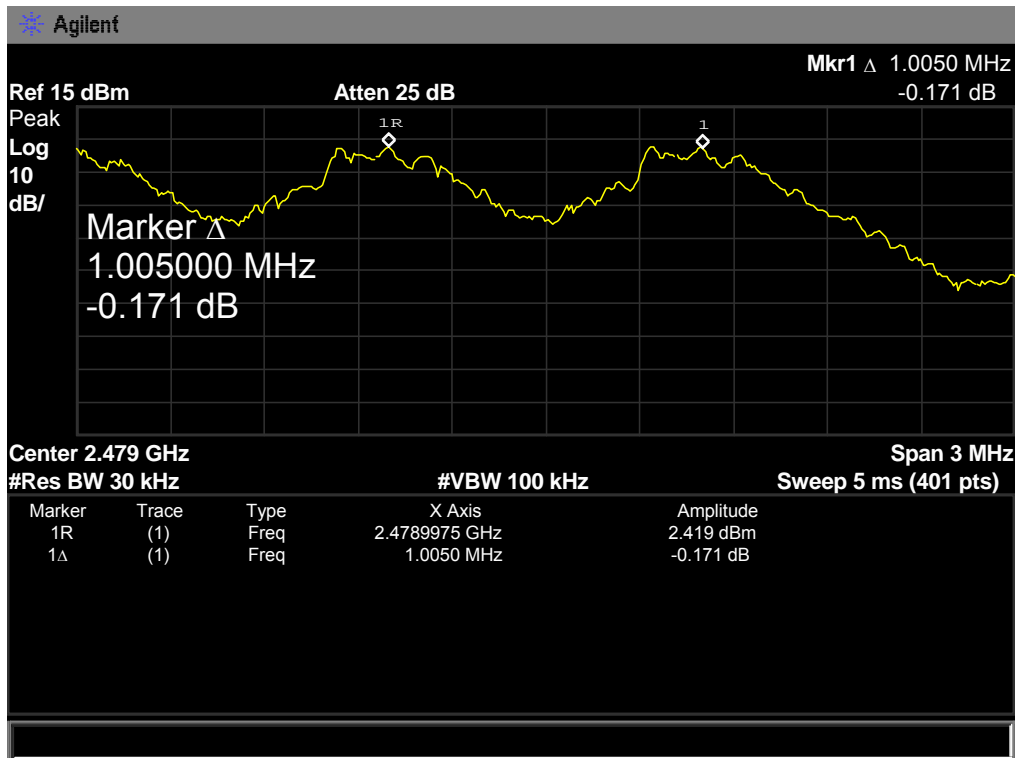



8-DPSK Mode (3Mbps)		
Frequency (MHz)	Channel Separation (kHz)	Limit (kHz)
2402	1005.00	828.00
2441	1005.00	805.33
2480	1005.00	810.67

**Note:** Test plots please refer following pages.

2402 MHz(8-DPSK)-Channel Separation

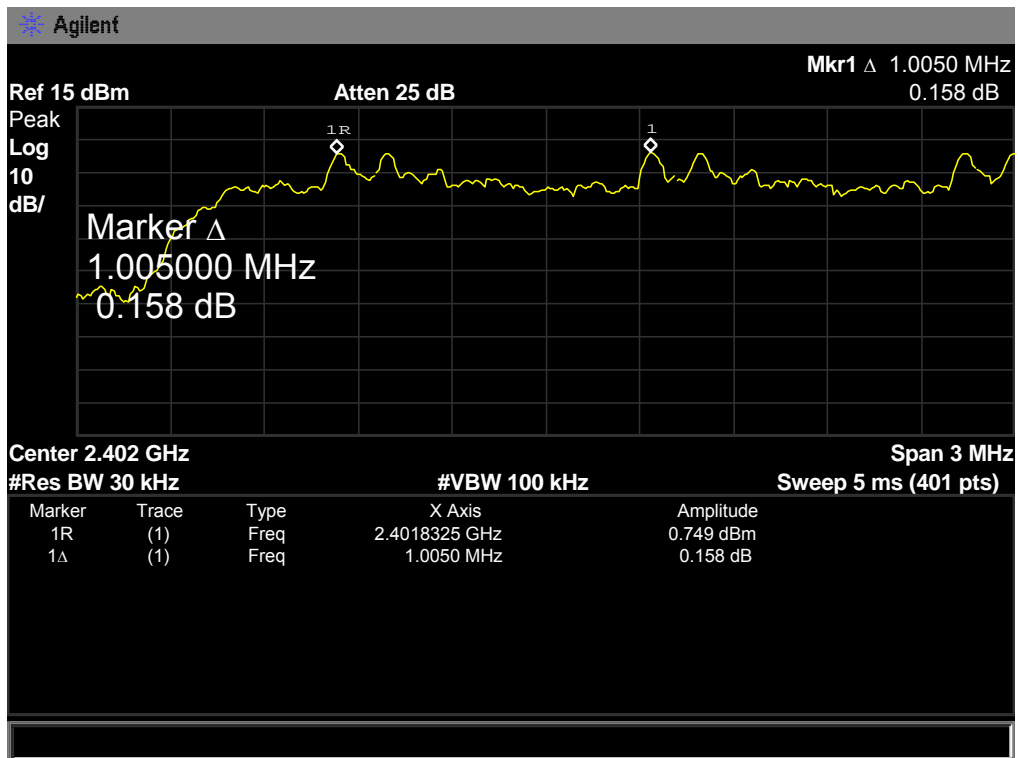

### 2441 MHz(8-DPSK)-Channel Separation

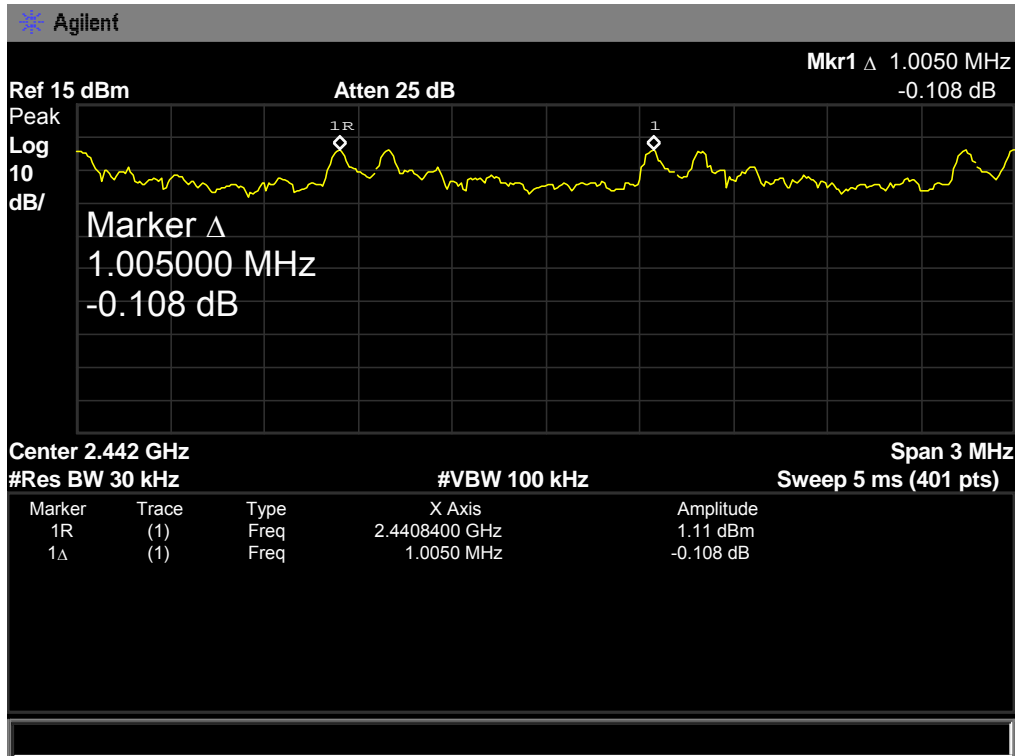

### 2480 MHz(8-DPSK)-Channel Separation

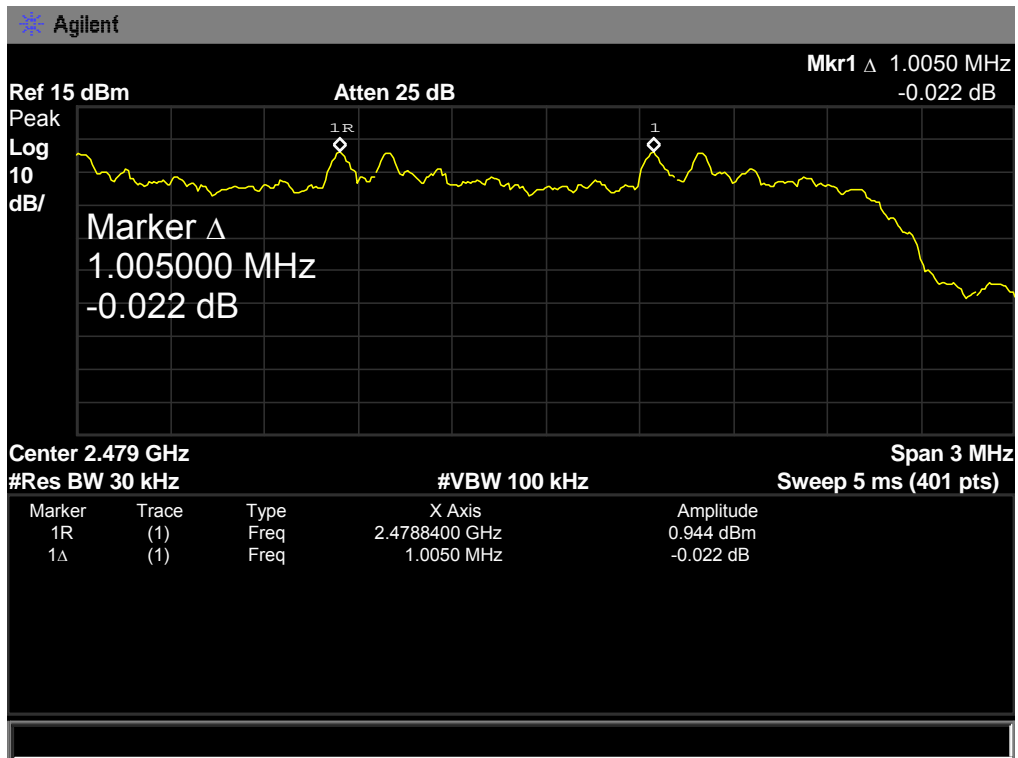

## 8. NUMBER OF HOPPING

### 8.1 LIMITS

Hopping Number	Frequency hopping systems in 2400-2483.5 MHz band shall use at least 15 channels.
----------------	---

### 8.2 TEST PROCEDURE

The EUT was directly connected to the Spectrum analyzer and antenna output port as show in the block diagram as bellow.

- a. Set span= the frequency band of operation.
- b. Set the RBW  $\geq$  1% of the span
- c. Set the VBW  $\geq$  3 RBW (100kHz/ 300kHz)
- d. Detector= Peak.
- e. Sweep time= auto couple
- f. Trace mode= max hold.
- g. Allow trace to fully stabilize.

### 8.3 TEST SETUP

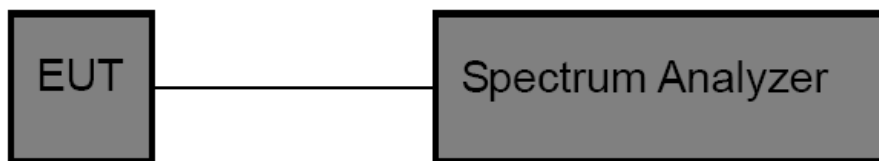

### 8.4 TEST INSTRUMENTS

Equipment	Manufacturer	Type No.	Serial No.	Last calibration	Calibrated until	Calibration period
Spectrum Analyzer	R&S	FSP40	100154	Jul. 04, 2016	Jul. 03. 2017	1 year
Spectrum Analyzer	Agilent	E4407B	MY41440432	Jul. 04, 2016	Jul. 03. 2017	1 year

### 8.5 EUT OPERATING CONDITIONS

The EUT was set to continuously transmitting in the maximum power during the test.

### 8.6 TEST RESULTS

GFSK Mode (1Mbps)	
Measurement Number	Limit
79	>15

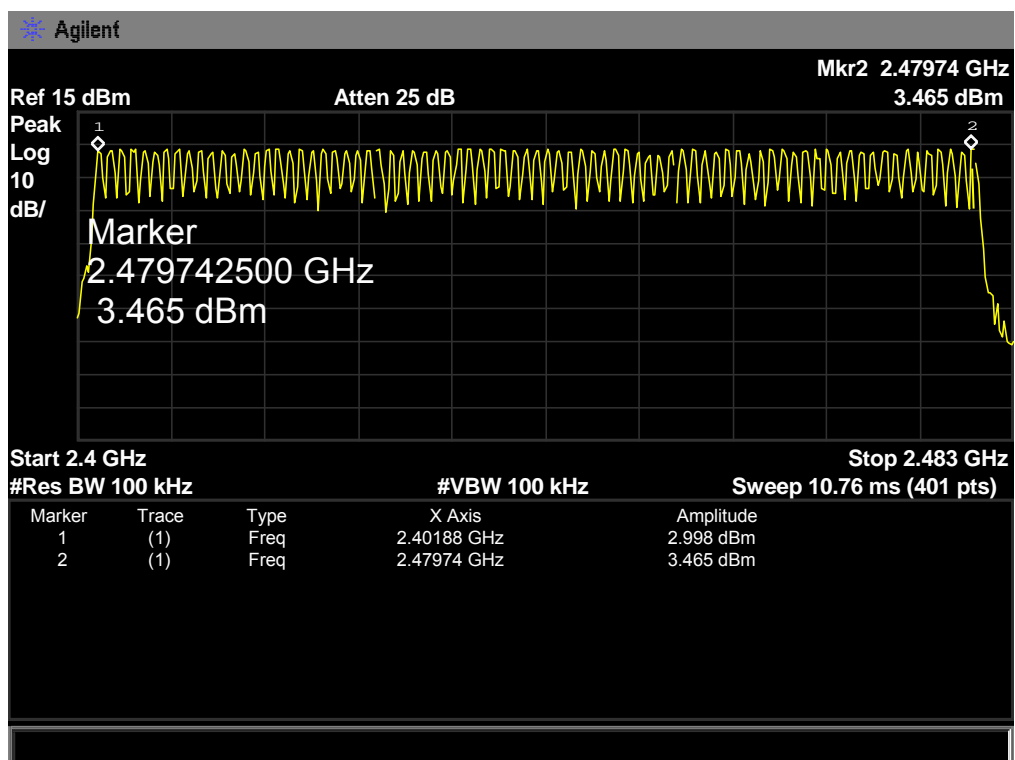

GFSK Mode (3Mbps)	
Measurement Number	Limit
79	>15

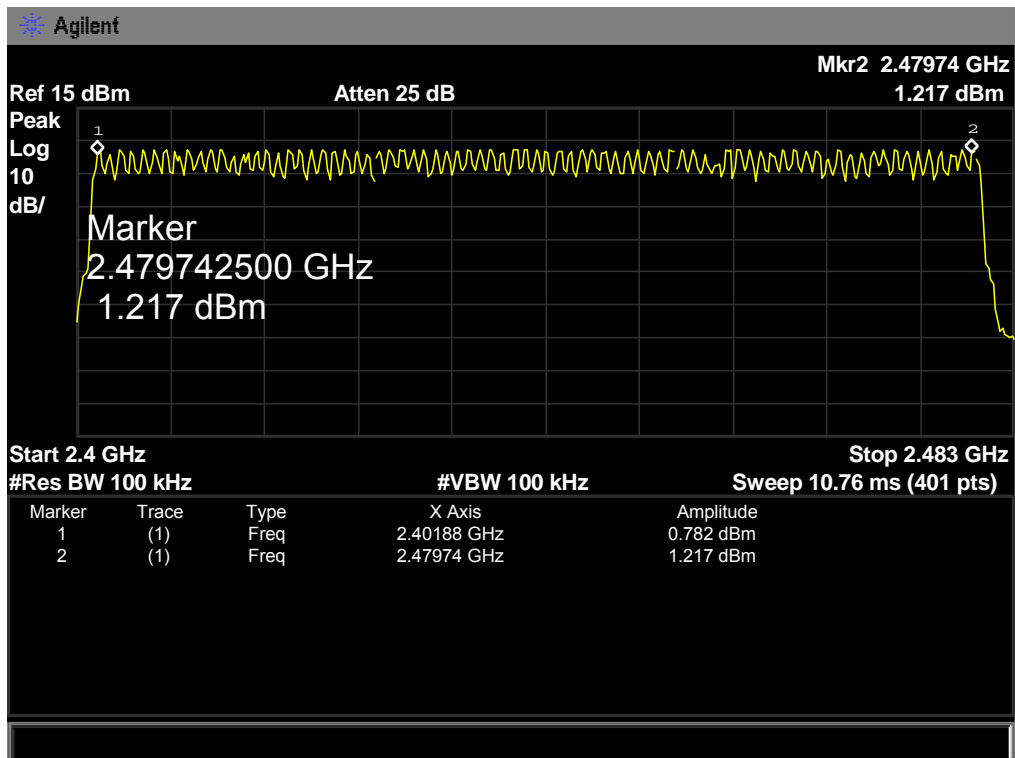

## 9. DWELL TIME

### 9.1 LIMITS

Dwell Time	The average time of occupancy on any channel shall not be greater than 0.4 seconds within a period of 0.4 seconds multiplied the number of hopping channels employed.
------------	---

### 9.2 TEST PROCEDURE

The EUT was directly connected to the Spectrum analyzer and antenna output port as show in the block diagram as bellow.

- a. Set span= zero
- b. Set the RBW= 1 MHz
- c. Set the VBW  $\geq$  RBW
- d. Detector= Peak.
- e. Sweep time= as necessary to capture the entire dwell time per hopping channel
- f. Trace mode= max hold
- g. Use the marker-delta function to determine the dwell time
- h. Set the EUT for DH5, DH3 and DH1 packet transmitting.
- i. Measure the maximum time duration of one single pulse.
- j. A Period Time = (channel number)\*0.4

DH1 Time Slot: Reading \* (1600/2)\*31.6/(channel number)

DH3 Time Slot: Reading \* (1600/4)\*31.6/(channel number)

DH5 Time Slot: Reading \* (1600/6)\*31.6/(channel number)

### 9.3 TEST SETUP

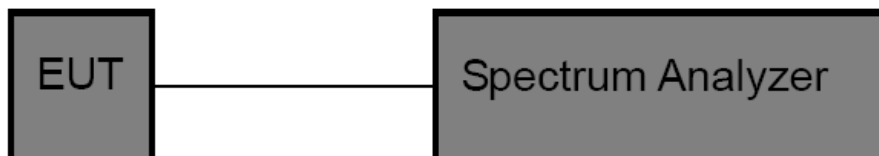

### 9.4 TEST INSTRUMENTS

Equipment	Manufacturer	Type No.	Serial No.	Last calibration	Calibrated until	Calibration period
Spectrum Analyzer	R&S	FSP40	100154	Jul. 04, 2016	Jul. 03. 2017	1 year
Spectrum Analyzer	Agilent	E4407B	MY41440432	Jul. 04, 2016	Jul. 03. 2017	1 year

### 9.5 EUT OPERATING CONDITIONS

The EUT was set to continuously transmitting in the maximum power during the test.

### 9.6 TEST RESULTS

Hopping Mode				
GFSK(1Mbps) 2441MHz				
Frequency (MHz)	Pulse Time (ms)	Total of Dwell (ms)	Period Time (s)	Limit (ms)
1DH1	0.430	137.60	31.60	<400
1DH3	1.700	272.00	31.60	
1DH5	3.000	320.00	31.60	

*DH1 Total of Dwell= Pulse Time\*(1600/2)\*31.6/79*  
*DH3 Total of Dwell= Pulse Time\*(1600/4)\*31.6/79*  
*DH5 Total of Dwell= Pulse Time\*(1600/6)\*31.6/79*

**Note:** Test plots please refer following pages.

2441 MHz (GFSK 1DH1)- Pulse Time

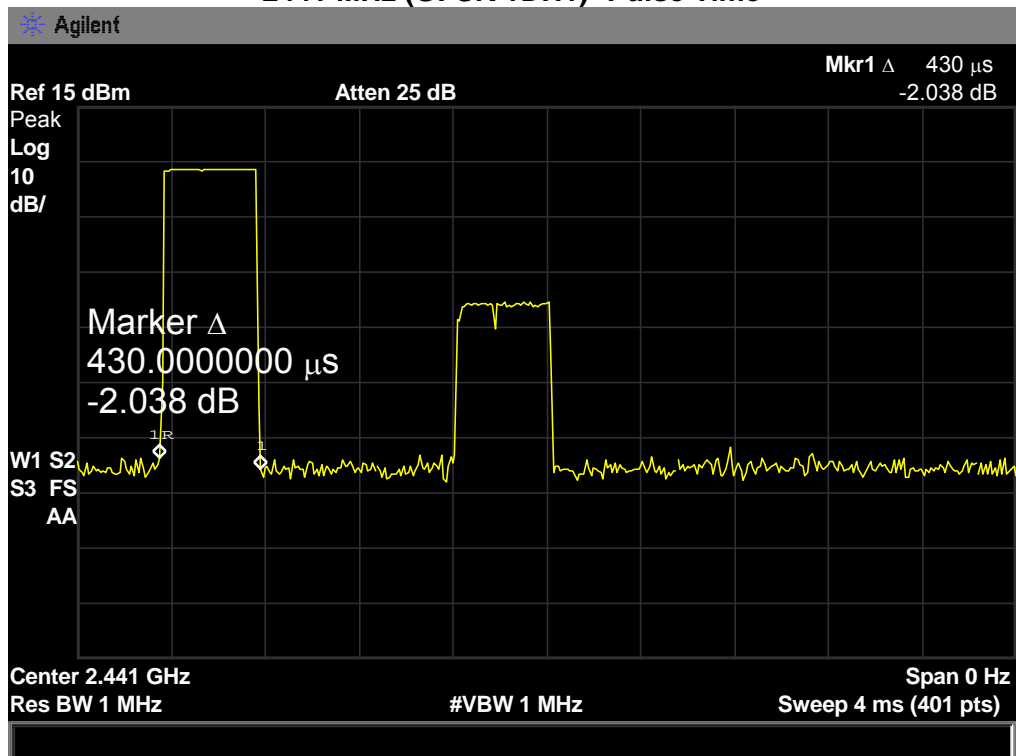

### 2441 MHz (GFSK 1DH3)- Pulse Time

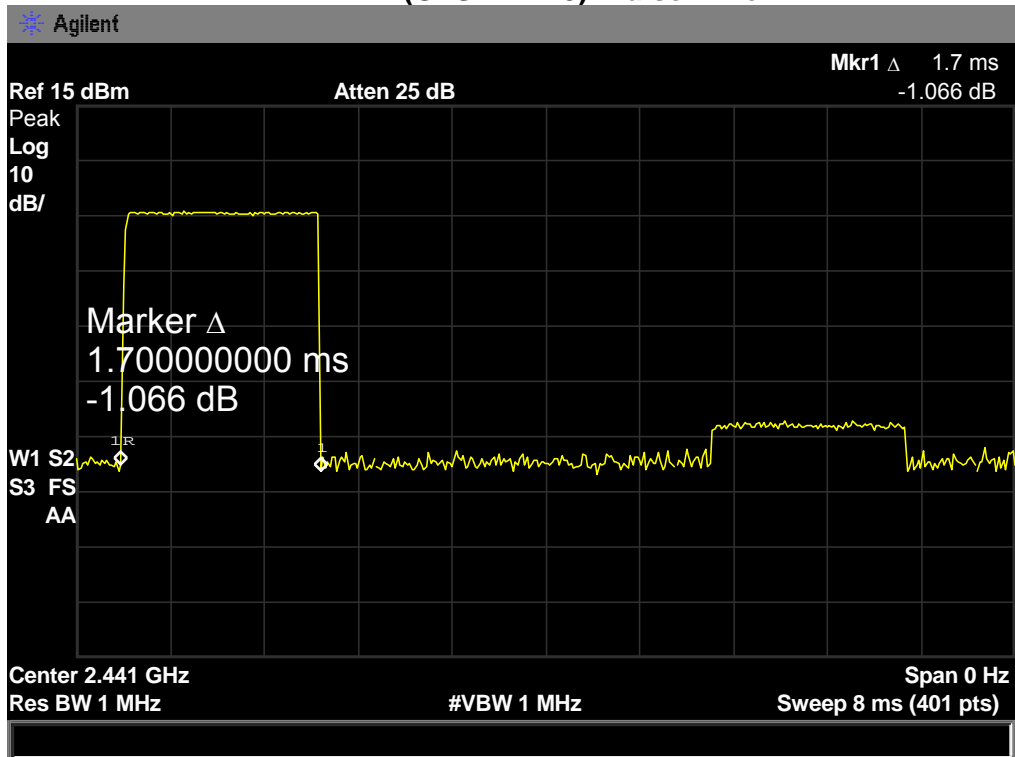

### 2441 MHz (GFSK 1DH5)- Pulse Time

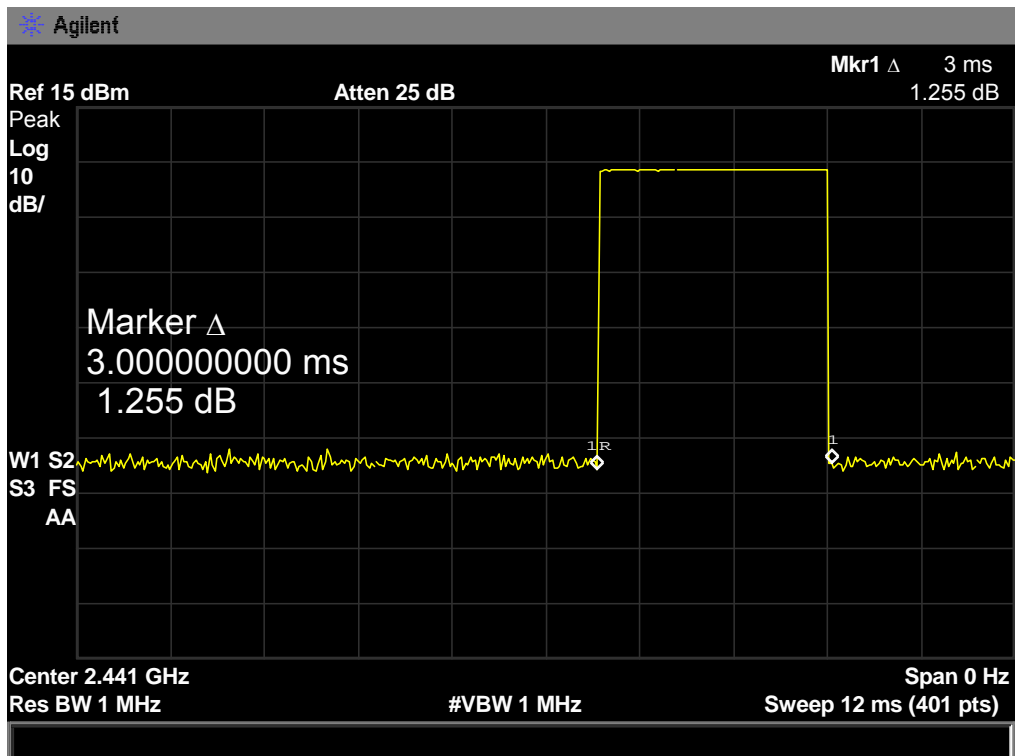



Hopping Mode				
8-DPSK(3Mbps) 2441MHz				
Frequency (MHz)	Pulse Time (ms)	Total of Dwell (ms)	Period Time (s)	Limit (ms)
3DH1	0.440	140.80	31.60	<400
3DH3	1.740	278.40	31.60	
3DH5	3.030	323.20	31.60	

*DH1 Total of Dwell= Pulse Time\*(1600/2)\*31.6/79*  
*DH3 Total of Dwell= Pulse Time\*(1600/4)\*31.6/79*  
*DH5 Total of Dwell= Pulse Time\*(1600/6)\*31.6/79*

**Note:** Test plots please refer following pages.

2441 MHz (DPSK 3DH1)- Pulse Time

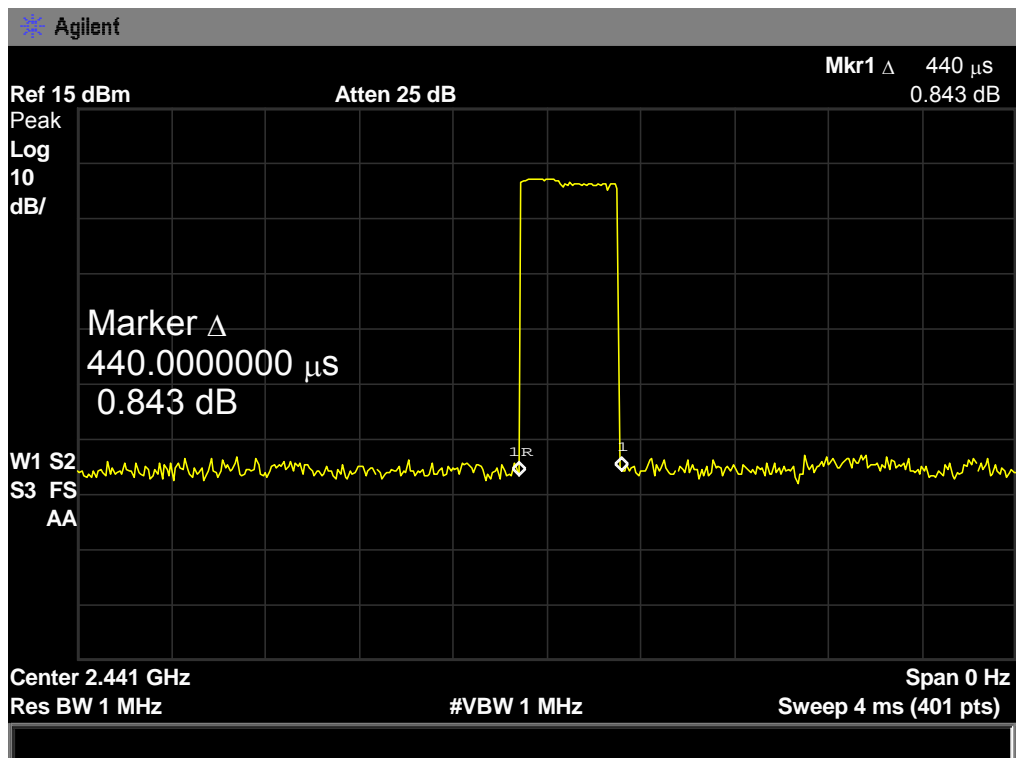

### 2441 MHz (DPSK 3DH3)- Pulse Time

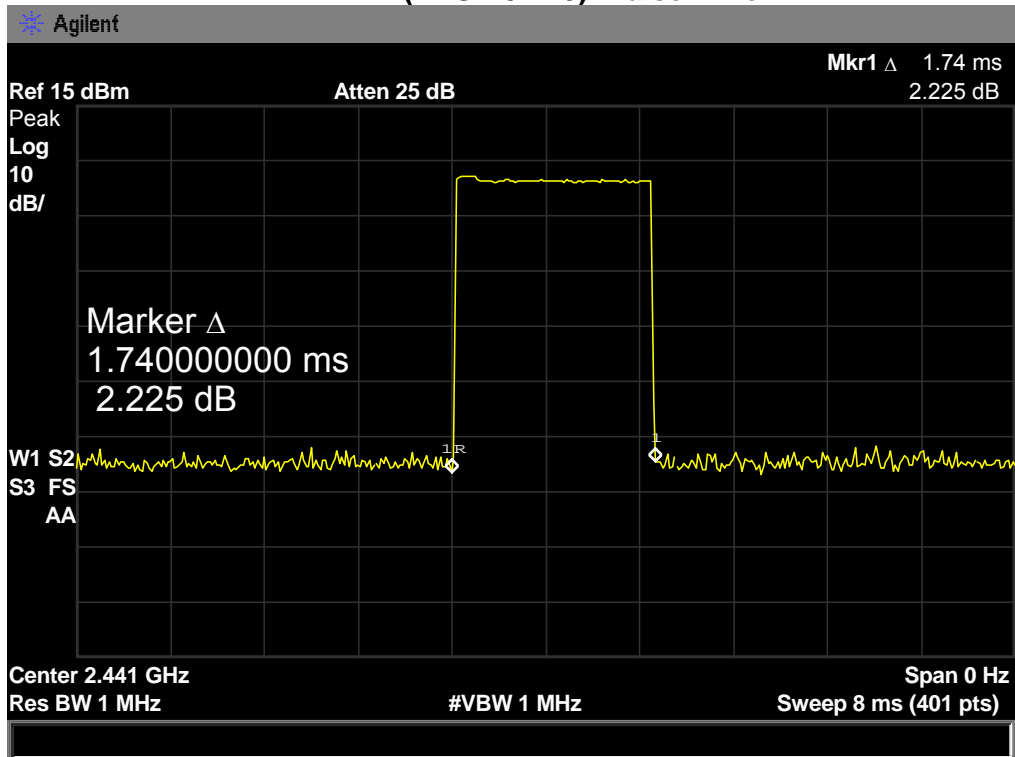

### 2441 MHz (8-DPSK 3DH5)- Pulse Time

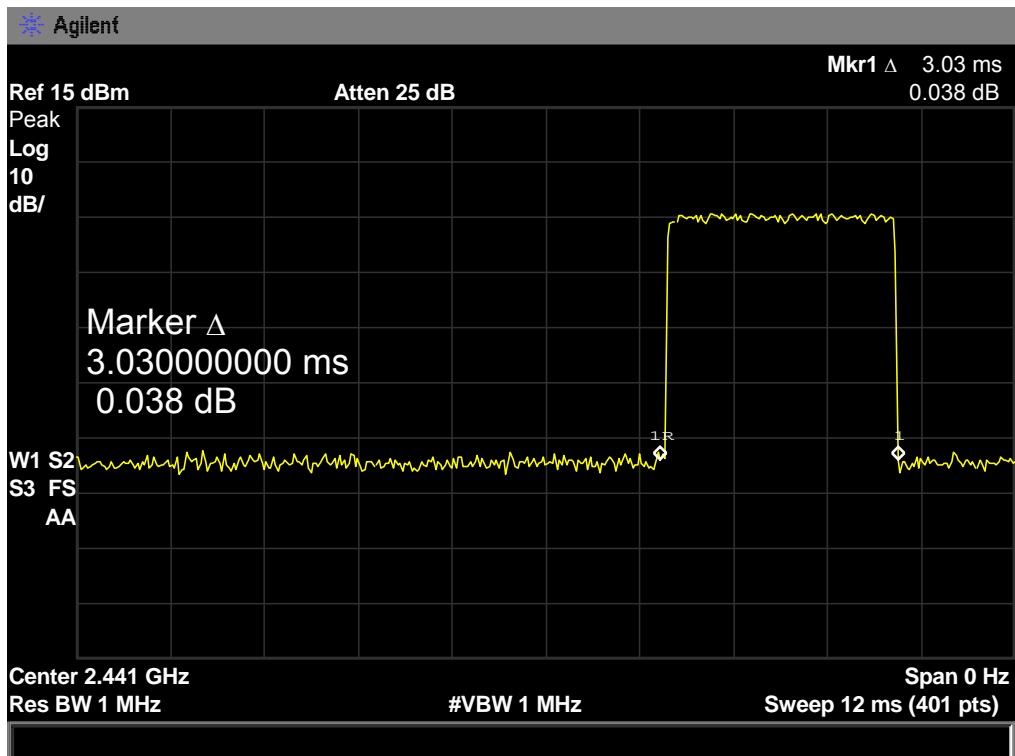

## 10. BAND EDGES MEASUREMENT

### 10.1 LIMITS

Band Edges Requirement	In any 100 kHz bandwidth outside the intentional radiation frequency band, the radio frequency power shall be at least 20 dB below the highest level of the radiated power. In addition, radiated emissions which fall in the restricted bands must also comply with the radiated emission limits.
------------------------	--

### 10.2 TEST PROCEDURE

The EUT was directly connected to the Spectrum analyzer and antenna output port as show in the block diagram as bellow.

- Set frequency range to capture low band-edge from 2310 MHz up to 2390 MHz, and for up band-edge from 2483.5 MHz up to 2500 MHz
- For low band-edge set the equipment transmit at the lowest channel, and for up band-edge set the equipment transmit at the highest channel
- Set the VBW  $\geq 3$  RBW (100kHz/ 300kHz) for conducted measurement
- For radiated measurements the RBW set to 1 MHz, and the VBW set to 1 MHz for peak measurements and 10 Hz for average measurement

### 10.3 TEST SETUP

#### (A) Radiated Emission Test Set-Up

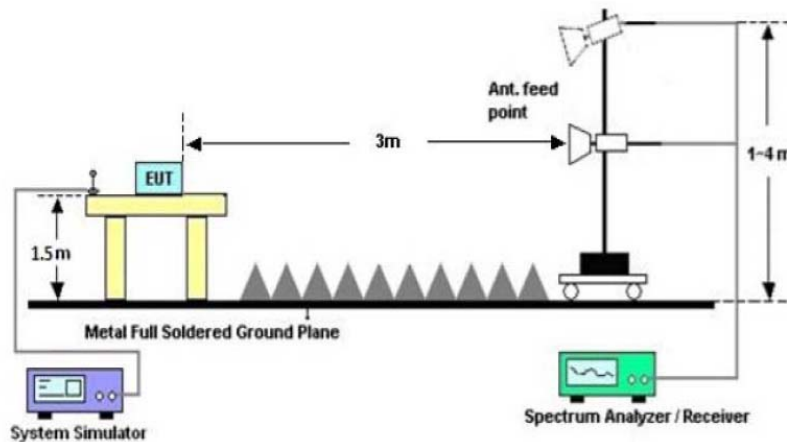

#### (B) Conducted Emission Test Setup

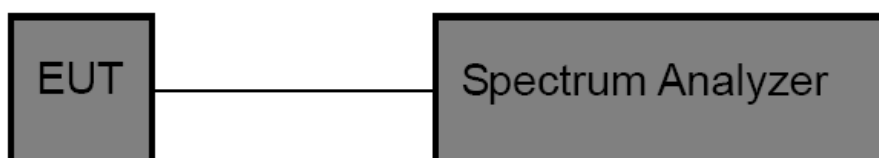

### 10.4 TEST INSTRUMENTS

Equipment	Manufacturer	Type No.	Serial No.	Last calibration	Calibrated until	Calibration period
Broadband Antenna	R&S	VULB 9168	VULB 9168-456	Jul. 04, 2016	Jul. 03. 2017	1 year
Test Cable	N/A	R-01	N/A	Jul. 04, 2016	Jul. 03. 2017	1 year
Test Cable	N/A	R-02	N/A	Jul. 04, 2016	Jul. 03. 2017	1 year
EMI Test Receiver	R&S	ESCI	101324	Jul. 04, 2016	Jul. 03. 2017	1 year
Spectrum Analyzer	Agilent	E4407B	MY41440432	Jul. 04, 2016	Jul. 03. 2017	1 year
Antenna Mast	EM	SC100_1	N/A	N/A	N/A	N/A
Turn Table	EM	SC100	060531	N/A	N/A	N/A
50Ω Switch	Anritsu Corp	MP59B	6200983705	Jul. 04, 2016	Jul. 03. 2017	1 year
Spectrum Analyzer	R&S	FSP40	100154	Jul. 04, 2016	Jul. 03. 2017	1 year
Horn Antenna	R&S	HBM30706	10029	Jul. 04, 2016	Jul. 03. 2017	1 year
Amplifier	EM	EM-30180	060538	Jul. 04, 2016	Jul. 03. 2017	1 year

10.5 EUT OPERATING CONDITIONS

The EUT was set to continuously transmitting in the maximum power during the test.

10.6 TEST RESULTS

**Bandedge(Radiated Emission)- Only show the worst Case DH1.**

<b>EUT :</b>	Wireless mouse	<b>Model Name. :</b>	BM307
<b>Temperature :</b>	26 °C	<b>Relative Humidity :</b>	56%
<b>Test Power :</b>	DC 3.0V	<b>Pressure :</b>	1010 hPa
<b>Test Mode :</b>	TX GFSK Mode 2402MHz	<b>Test Date :</b>	2017-06-25
<b>Polarity :</b>	Horizontal		
<b>Remark :</b>	Only show the worst polarity		

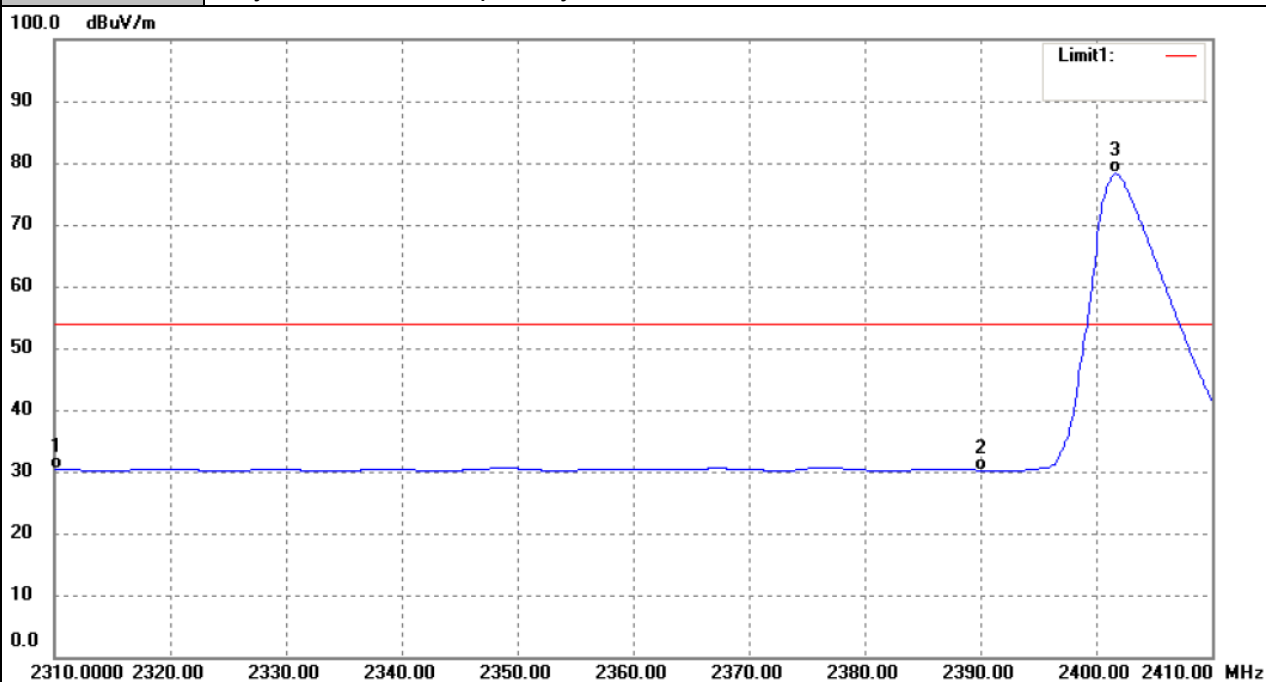

No.	Frequency (MHz)	Reading (dBuV/m)	Correct Factor(dB)	Result (dBuV/m)	Limit (dBuV/m)	Margin (dB)	Remark
1	2310.000	34.10	-3.69	30.41	54.00	-23.59	Average Detector
	2310.000	46.67	-3.69	42.98	74.00	-31.02	Peak Detector
2	2390.000	33.71	-3.49	30.22	54.00	-23.78	Average Detector
	2390.000	46.35	-3.49	42.86	74.00	-31.14	Peak Detector
3	2401.600	82.14	-3.46	78.68	/	/	Average Detector
	2401.600	103.02	-3.46	99.56	/	/	Peak Detector

**Remark:**

Emission Level= Read Level+ Correct Factor

Margin= Emission Level-Limit

No report for the emission which more than 10 dB below the prescribed limit.

<b>EUT :</b>	Wireless mouse	<b>Model Name. :</b>	BM307
<b>Temperature :</b>	26 °C	<b>Relative Humidity :</b>	56%
<b>Test Power :</b>	DC 3.0V	<b>Pressure :</b>	1010 hPa
<b>Test Mode :</b>	TX GFSK Mode 2480MHz	<b>Test Date :</b>	2017-06-25
<b>Polarity :</b>	Horizontal		
<b>Remark :</b>	Only show the worst polarity		

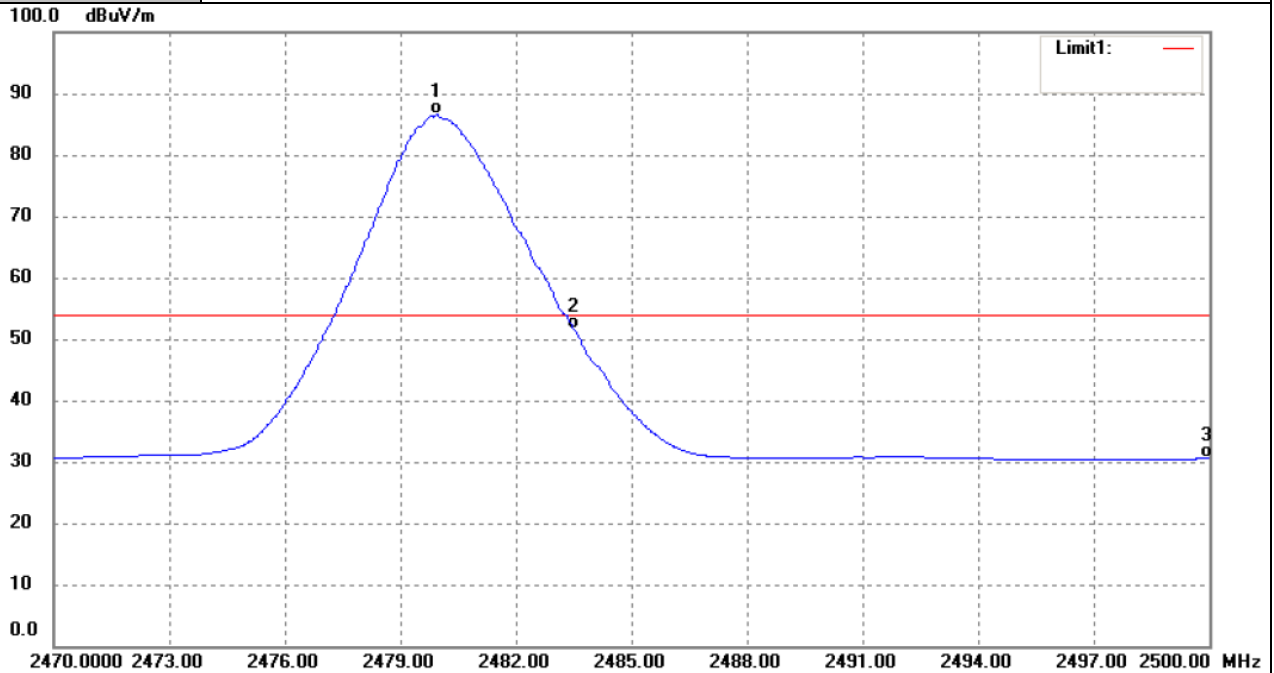

No.	Frequency (MHz)	Reading (dBuV/m)	Correct Factor(dB)	Result (dBuV/m)	Limit (dBuV/m)	Margin (dB)	Remark
1	2479.93	89.80	-3.25	86.55	/	/	Average Detector
	2479.84	97.97	-7.53	90.44	/	/	Peak Detector
2	2483.50	54.90	-3.25	51.65	54.00	-2.35	Average Detector
	2483.50	59.21	-7.53	51.68	74.00	-22.32	Peak Detector
3	2500.00	33.74	-3.20	30.54	54.00	-23.46	Average Detector
	2500.00	45.14	-7.50	37.64	74.00	-36.36	Peak Detector

Remark:

Emission Level= Read Level+ Correct Factor

Margin= Emission Level-Limit

No report for the emission which more than 10 dB below the prescribed limit.

**Bandedge(Conducted Emission)**

**Fixed GFSK Mode Low**

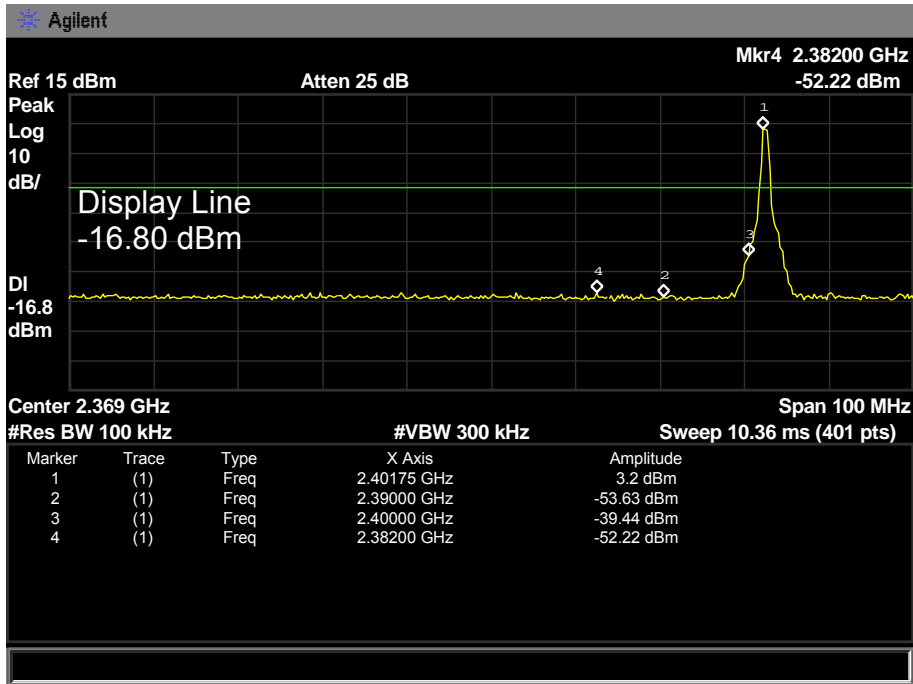

**Fixed GFSK Mode Up**

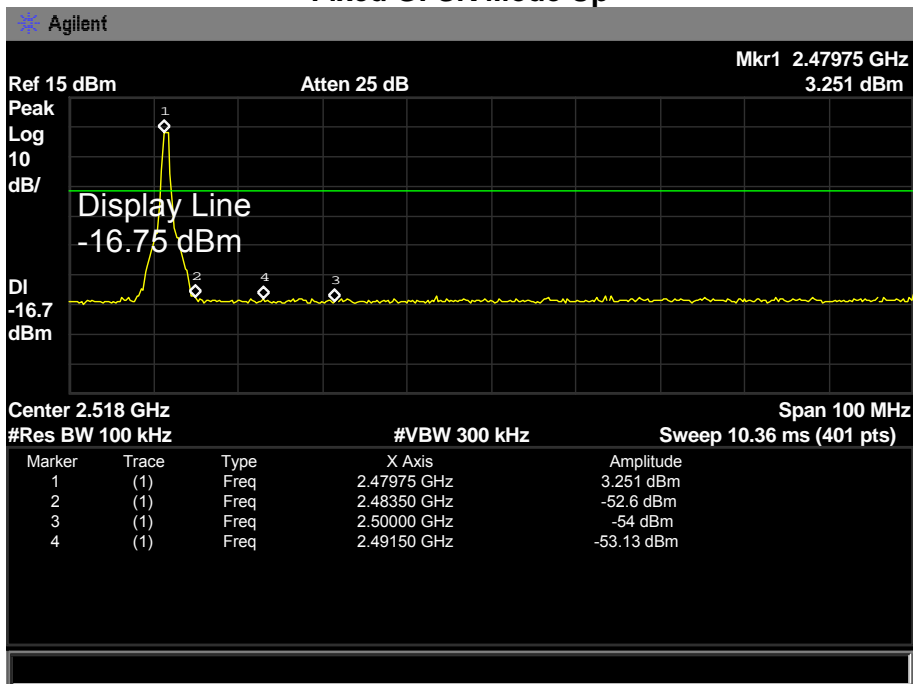

### Hopping GFSK Mode Low

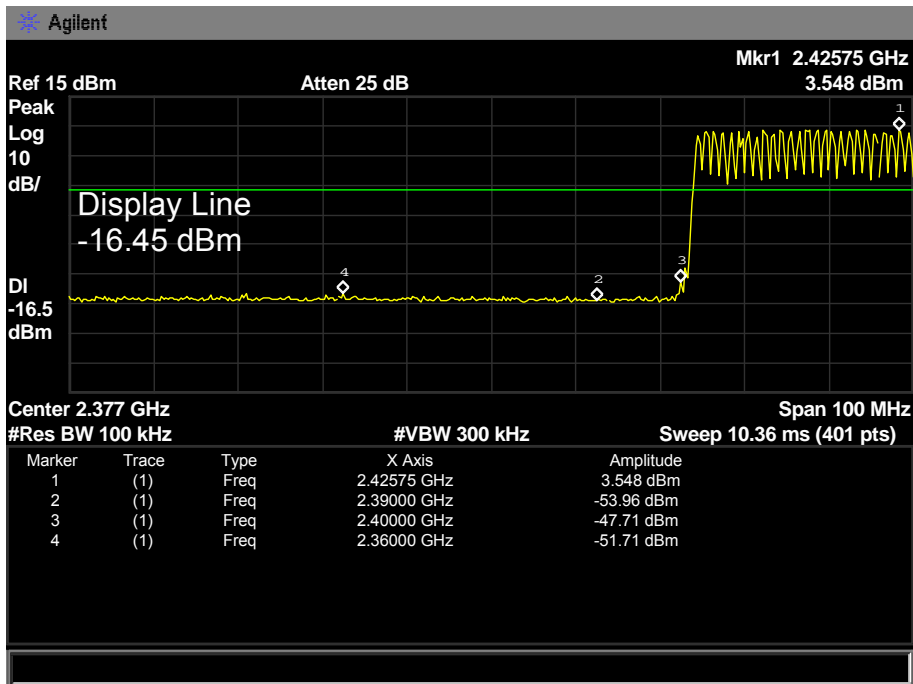

### Hopping GFSK Mode Up

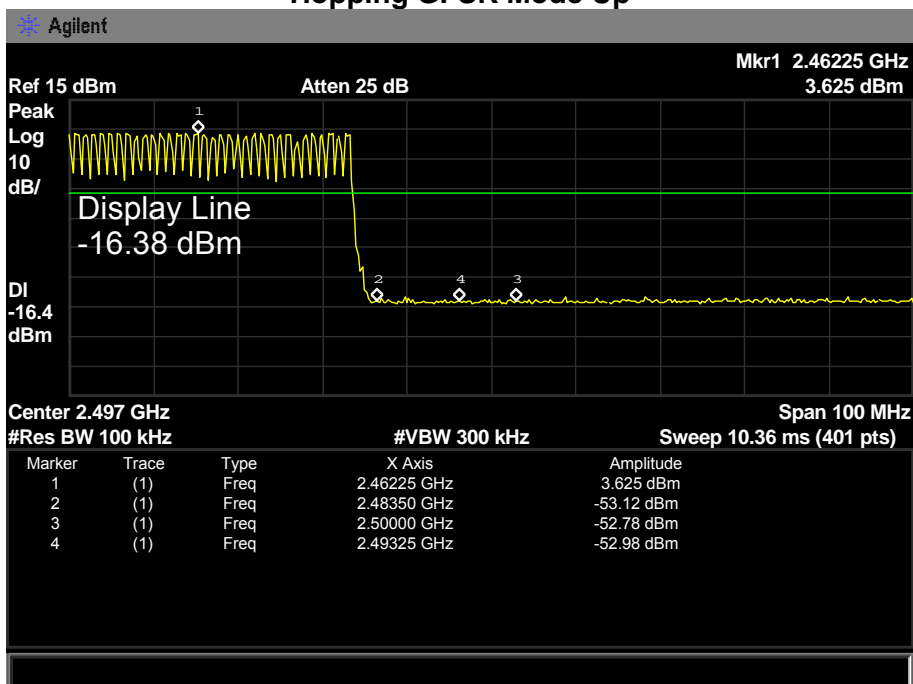



### Fixed 8-DPSK Mode Low

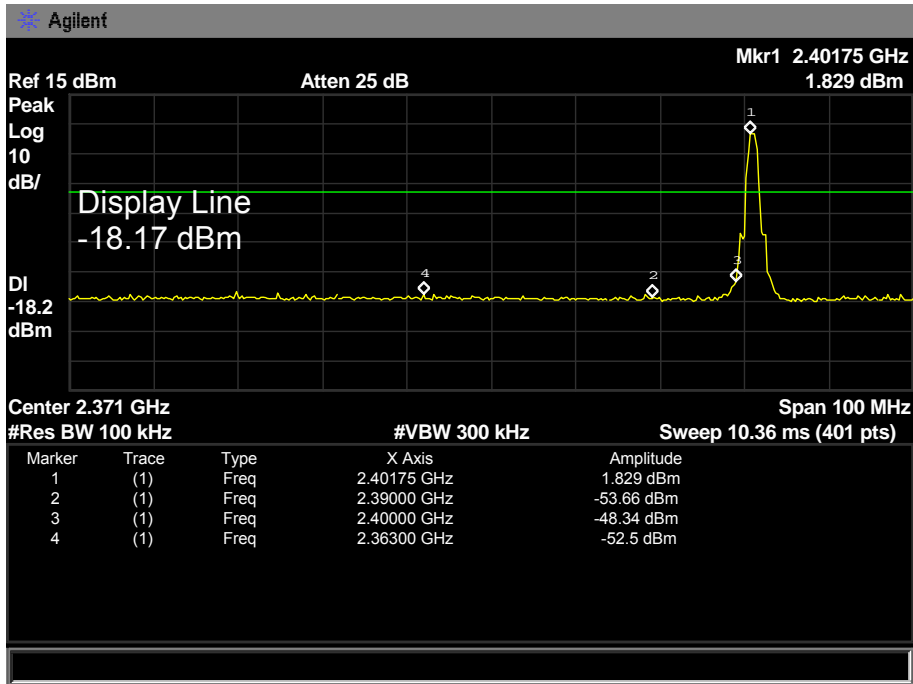

### Fixed 8-DPSK Mode Up

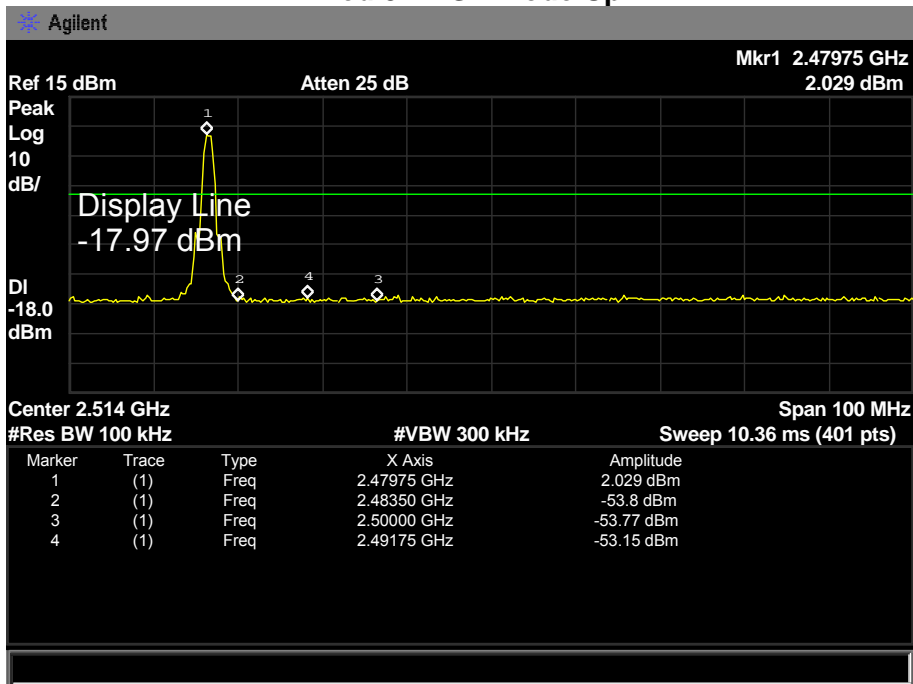

### Hopping 8-DPSK Mode Low

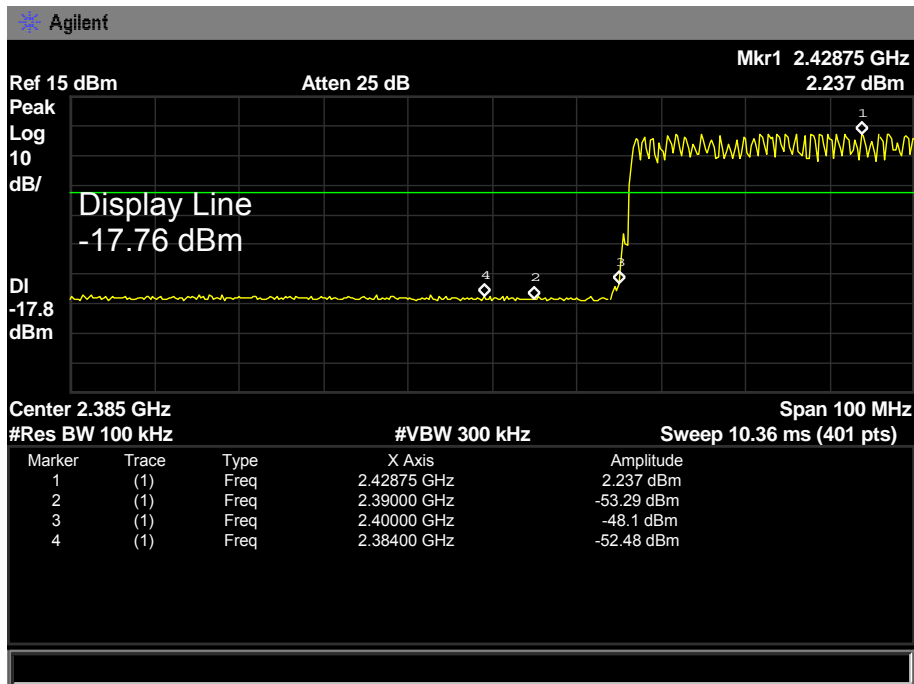

### Hopping 8-DPSK Mode Up

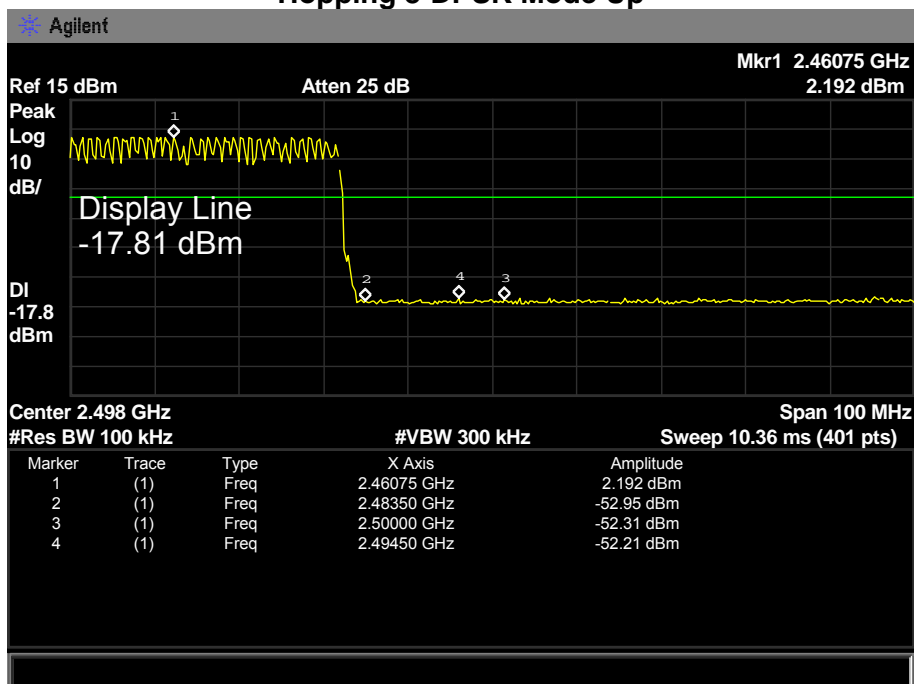

## 11. FREQUENCY HOPPING SYSTEM

### 11.1 STANDARD APPLICABLE

According to FCC Part 15.247(a)(1) The system shall hop to channel frequencies that are selected at the system hopping rate from a pseudo randomly ordered list of hopping frequencies. Each frequency must be used equally on the average by each transmitter. The system receivers shall have input bandwidths that match the hopping channel bandwidths of their corresponding transmitters and shall shift frequencies in synchronization with the transmitted signals.

g) Frequency hopping spread spectrum systems are not required to employ all available hopping channels during each transmission. However, the system, consisting of both the transmitter and the receiver, must be designed to comply with all of the regulations in this section should the transmitter be presented with a continuous data (or information) stream. In addition, a system employing short transmission bursts must comply with the definition of a frequency hopping system and must distribute its transmissions over the minimum number of hopping channels specified in this section.

(h) The incorporation of intelligence within a frequency hopping spread spectrum system that permits the system to recognize other users within the spectrum band so that it individually and independently chooses and adapts its hopsets to avoid hopping on occupied channels is permitted. The coordination of frequency hopping systems in any other manner for the express purpose of avoiding the simultaneous occupancy of individual hopping frequencies by multiple transmitters is not permitted.

### 11.2 FREQUENCY HOPPING SYSTEM

This transmitter device is frequency hopping device, and complies with FCC part 15.247 rule.

This device uses Bluetooth radio which operates in 2400-2483.5 MHz band. Bluetooth uses a radio technology called frequency-hopping spread spectrum, which chops up the data being sent and transmits chunks of it on up to 79 bands (1 MHz each; centred from 2402 to 2480 MHz) in the range 2,400-2,483.5 MHz. The transmitter switches hop frequencies 1,600 times per second to assure a high degree of data security. All Bluetooth devices participating in a given piconet are synchronized to the frequency-hopping channel for the piconet. The frequency hopping sequence is determined by the master's device address and the phase of the hopping sequence (the frequency to hop at a specific time) is determined by the master's internal clock. Therefore, all slaves in a piconet must know the master's device address and must synchronize their clocks with the master's clock.

Adaptive Frequency Hopping (AFH) was introduced in the Bluetooth specification to provide an effective way for a Bluetooth radio to counteract normal interference. AFH identifies "bad" channels, where either other wireless devices are interfering with the Bluetooth signal or the Bluetooth signal is interfering with another device. The AFH-enabled Bluetooth device will then communicate with other devices within its piconet to share details of any identified bad channels. The devices will then switch to alternative available "good" channels, away from the areas of interference, thus having no impact on the bandwidth used.

This device was tested with an bluetooth system receiver to check that the device maintained hopping synchronization, and the device complied with these requirements for DA 00-705 and FCC Part 15.247 rule.

### 11.3 EUT PSEUDORANDOM FREQUENCY HOPPING SEQUENCE

Pseudorandom Frequency Hopping Sequence Table as below:

Channel: 17, 30, 02, 18, 78, 66, 19, 31, 32, 41, 50, 44, 73, 75, 51, 59, 49, 23, 29, 05, 63, 64, 42, 76, 70, 37, 71, 72, 20, 10, 60, 77, 25, 40, 51, 59, 73, 55, 69, 65, 48, 00, 12, 26, 01, 34, 15, 21, 56, 23, 07, 08, 11, 36, 21, 22, 68, 29, 06, 01, 34, 16, 03, 05, 68, 15, 46, 74, 14, 45, 28, etc.

The system receiver have input bandwidths that match the hopping channel bandwidths of their corresponding transmitters and shift frequencies in synchronization with the transmitted signals.

## 12. ANTENNA REQUIREMENT

### 12.1 REQUIREMENT

Antenna Requirement (15.203)	An intentional radiator shall be designed to ensure that no antenna other than that furnished by the responsible party shall be used with the device. The use of a permanently attached antenna or of an antenna that uses a unique coupling to the intentional radiator shall be considered sufficient to comply with the provisions of this Section. The manufacturer may design the unit so that a broken antenna can be replaced by the user, but the use of a standard antenna jack or electrical connector is prohibited.
Antenna Requirement (15.247)	If transmitting antennas of directional gain greater than 6 dBi are used, the power shall be reduced by the amount in dB that the directional gain of the antenna exceeds 6 dBi.

### 12.2 ANTENNA CONNECTOR CONSTRUCTION

The EUT antenna is a PCB Antenna. And the maximum gain of this antenna is 0dBi. It complies with the standard requirement.

\*\*\*\*\*END OF REPORT\*\*\*\*\*