



# FCC RADIO TEST REPORT

## FCC ID: 2AK7UFM2000

**Product :** 5.8GHz/2.4GH wireless local  
area network equipment

**Trade Name :** FEIMA  
ROBOTICS 

**Model Name:** FM2000

**Serial Model :** N/A

**Report No. :** POCE- 20170203217R2

### Prepared for

Shen Zhen Feima Robotics Co.,Ltd  
1st floor,16 Buiding,Zhiheng Industrial Park Guankou 2nd  
Road,Nantou,Nanshan District,Shenzhen,China

### Prepared by

Shenzhen POCE Technology Co.,Ltd.  
Room 502, Bldg. 1, Xinghua Garden, Baoan Road Xixiang,  
Baoan District,Shenzhen, China

## TEST RESULT CERTIFICATION

**Applicant's name** ..... : Shen Zhen Feima Robotics Co.,Ltd  
**Address** ..... : 1st floor,16 Buiding,Zhiheng Industrial Park Guankou 2nd  
Road,Nantou,Nanshan District,Shenzhen,China

**Manufacture's Name**..... : Shen Zhen Feima Robotics Co.,Ltd  
**Address** ..... : 1st floor,16 Buiding,Zhiheng Industrial Park Guankou 2nd  
Road,Nantou,Nanshan District,Shenzhen,China

### Product description

**Product name** ..... : 5.8GHz/2.4GH wireless local  
area network equipment

**Model and/or type reference** : FM2000

**Serial Model** ..... : N/A

**Standards** ..... : FCC Part15.407

**Test procedure** ..... ANSI C63.10-2013

This device described above has been tested by POCE, and the test results show that the equipment under test (EUT) is in compliance with the FCC requirements. And it is applicable only to the tested sample identified in the report.

This report shall not be reproduced except in full, without the written approval of POCE, this document may be altered or revised by POCE, personal only, and shall be noted in the revision of the document.

**Date of Test** ..... :

**Date (s) of performance of tests** ..... : 01 Feb. 2017 ~19 Feb. 2017

**Date of Issue**..... : 19 Feb. 2017

**Test Result**..... : **Pass**

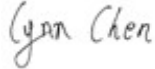
**Testing Engineer** :   
(Lynn Chen)

**Technical Manager** :   
(Carlen Liu)

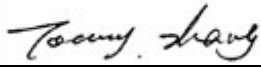
**Authorized Signatory** :   
(Tommy Zhang)

**Table of Contents**

	<b>Page</b>
<b>1. SUMMARY OF TEST RESULTS</b>	<b>5</b>
<b>2. TEST FACILITY</b>	<b>6</b>
<b>3. MEASUREMENT UNCERTAINTY</b>	<b>6</b>
<b>4. GENERAL INFORMATION</b>	<b>7</b>
<b>5. DESCRIPTION OF TEST MODES</b>	<b>9</b>
<b>6. BLOCK DIGRAM SHOWING THE CONFIGURATION OF SYSTEM TESTED</b>	<b>10</b>
<b>7. DESCRIPTION OF SUPPORT UNITS(CONDUCTED MODE)</b>	<b>10</b>
<b>8. EQUIPMENTS LIST FOR ALL TEST ITEMS</b>	<b>11</b>
<b>9. EMC EMISSION TEST</b>	<b>12</b>
<b>9.1 CONDUCTED EMISSION MEASUREMENT</b>	<b>12</b>
<b>POWER LINE CONDUCTED EMISSION LIMITS</b>	<b>12</b>
<b>9.2 TEST PROCEDURE</b>	<b>13</b>
<b>9.3 DEVIATION FROM TEST STANDARD</b>	<b>13</b>
<b>TEST SETUP</b>	<b>13</b>
<b>9.4 EUT OPERATING CONDITIONS</b>	<b>13</b>
<b>10 RADIATED EMISSION MEASUREMENT</b>	<b>15</b>
<b>10.1 APPLICABLE STANDARD</b>	<b>15</b>
<b>10.2 CONFORMANCE LIMIT</b>	<b>15</b>
<b>10.3 MEASURING INSTRUMENTS</b>	<b>16</b>
<b>10.4 TEST CONFIGURATION</b>	<b>16</b>
<b>10.5 TEST PROCEDURE</b>	<b>17</b>
<b>10.6 TEST RESULTS (BETWEEN 9KHZ – 30 MHZ)</b>	<b>19</b>
<b>10.7 TEST RESULTS (BETWEEN 30MHZ - 1GHZ)</b>	<b>20</b>
<b>3.2.8 TEST RESULTS (1GHZ-18GHZ)</b>	<b>24</b>
<b>11. POWER SPECTRAL DENSITY TEST</b>	<b>27</b>
<b>11.1 APPLIED PROCEDURES / LIMIT</b>	<b>27</b>
<b>11.2 TEST PROCEDURE</b>	<b>28</b>
<b>11.3 DEVIATION FROM STANDARD</b>	<b>28</b>
<b>11.4 TEST SETUP</b>	<b>28</b>
<b>11.5 EUT OPERATION CONDITIONS</b>	<b>28</b>
<b>11.6 TEST RESULTS</b>	<b>29</b>
<b>12. 26 DB &amp; 99% EMISSION BANDWIDTH</b>	<b>32</b>
<b>12.1 APPLIED PROCEDURES / LIMIT</b>	<b>32</b>
<b>12.2 TEST PROCEDURE</b>	<b>32</b>
<b>12.3 EUT OPERATION CONDITIONS</b>	<b>33</b>
<b>1 2.4 TEST RESULTS</b>	<b>34</b>
<b>13. MINIMUM 6 DB BANDWIDTH</b>	<b>37</b>

**Table of Contents**

	<b>Page</b>
<b>13.1 APPLIED PROCEDURES / LIMIT</b>	<b>37</b>
<b>13.2 TEST PROCEDURE</b>	<b>37</b>
<b>13.3 DEVIATION FROM STANDARD</b>	<b>37</b>
<b>13.4 TEST SETUP</b>	<b>37</b>
<b>13.5 EUT OPERATION CONDITIONS</b>	<b>37</b>
<b>13.6 TEST RESULTS</b>	<b>38</b>
<b>14. MAXIMUM CONDUCTED OUTPUT POWER</b>	<b>41</b>
<b>14.1 PPLIED PROCEDURES / LIMIT</b>	<b>41</b>
<b>14.2 TEST PROCEDURE</b>	<b>41</b>
<b>14.3 DEVIATION FROM STANDARD</b>	<b>41</b>
<b>14.4 TEST SETUP</b>	<b>41</b>
<b>14.6 TEST RESULTS</b>	<b>42</b>
<b>15. OUT OF BAND EMISSIONS</b>	<b>43</b>
<b>15.1 APPLICABLE STANDARD</b>	<b>43</b>
<b>15.2 TEST PROCEDURE</b>	<b>43</b>
<b>15.3 DEVIATION FROM STANDARD</b>	<b>43</b>
<b>15.4 TEST SETUP</b>	<b>43</b>
<b>15.5 EUT OPERATION CONDITIONS</b>	<b>44</b>
<b>15.6 TEST RESULTS</b>	<b>44</b>
<b>16. FREQUENCY STABILITY MEASUREMENT</b>	<b>47</b>
<b>16.1 LIMIT</b>	<b>47</b>
<b>16.2 TEST PROCEDURES</b>	<b>47</b>
<b>16.3 TEST SETUP LAYOUT</b>	<b>47</b>
<b>16.4 EUT OPERATION DURING TEST</b>	<b>47</b>
<b>16.5 TEST RESULTS</b>	<b>48</b>
<b>17. ANTENNA REQUIREMENT</b>	<b>51</b>
<b>17.1 STANDARD REQUIREMENT</b>	<b>51</b>
<b>17.2 EUT ANTENNA</b>	<b>51</b>
<b>18. EUT TEST PHOTO</b>	<b>52</b>
<b>APPENDIX-PHOTOGRAPHS OF EUT CONSTRUCTIONAL DETAILS</b>	

### 1. SUMMARY OF TEST RESULTS

Test procedures according to the technical standards:

FCC Part15 (15.407) , Subpart E			
Standard Section	Test Item	Judgment	Remark
15.207	AC Power Line Conducted Emissions	PASS	
15.209(a), 15.407 (b)(1) 15.407 (b)(4) 15.407 (b)(6)	Spurious Radiated Emissions	PASS	
15.407 (a)(1) 15.407 (a)(3) 15.1049	26 dB and 99% Emission Bandwidth	PASS	
15.407(e)	Minimum 6 dB bandwidth	PASS	
15.407 (a)(1) 15.407 (a)(3)	Maximum Conducted Output Power	PASS	
2.1051, 15.407(b)(1) 15.407(b)(4)	Band Edges	PASS	
15.407 (a)(1) 15.407 (a)(3)	Power Spectral Density	PASS	
15.407(g)	Frequency Stability	PASS	
15.203	Antenna Requirement	PASS	

NOTE:

(1) " N/A " denotes test is not applicable in this Test Report

## 2. TEST FACILITY

Shenzhen POCE Technology Co.,Ltd.

Add. : Room 502, Bldg. 1, Xinghua Garden, Baoan Road Xixiang, Baoan District, Shenzhen, China

FCC Registered No.: 222278

## 3. MEASUREMENT UNCERTAINTY

The reported uncertainty of measurement  $y \pm U$ , where expanded uncertainty  $U$  is based on standard uncertainty multiplied by a coverage factor of  $k=2$ , providing a level of confidence approximately 95 %.

No.	Item	Uncertainty
1	Conducted Emission Test	$\pm 1.38\text{dB}$
2	RF power,conducted	$\pm 0.16\text{dB}$
3	Spurious emissions,conducted	$\pm 0.21\text{dB}$
4	All emissions,radiated(<1G)	$\pm 4.68\text{dB}$
5	All emissions,radiated(>1G)	$\pm 4.89\text{dB}$
6	Temperature	$\pm 0.5^{\circ}\text{C}$
7	Humidity	$\pm 2\%$

**4. GENERAL INFORMATION**  
GENERAL DESCRIPTION OF EUT

Equipment	5.8GHz/2.4GH wireless local area network equipment	
Trade Name		
Model Name	FM2000	
Serial Model	N/A	
Model Difference	N/A	
	IEEE 802.11 WLAN Mode Supported	<input checked="" type="checkbox"/> 802.11a(20MHz channel bandwidth) <input checked="" type="checkbox"/> 802.11n(20MHz channel bandwidth) <input checked="" type="checkbox"/> 802.11n(40MHz channel bandwidth)
	Data Rate	802.11 a: 6,9,12,18,24,36,48,54Mbps; 802.11n(HT20):MCS0-MCS15; 802.11n(HT40):MCS0-MCS15;
	Modulation	OFDM with BPSK/QPSK/16QAM/64QAM/256QAM for 802.11a/n
	Operating Frequency Range	<input checked="" type="checkbox"/> 5745-5825 MHz for 802.11a/n(HT20); 5755-5795 MHz for 802.11a/n(HT40);
	Number of Channels	<input checked="" type="checkbox"/> 5 channels for 802.11a/N20 in the 5745-5825MHz band ; 2 channels for 802.11 N40 in the 5755-5795MHz band ;
	Antenna Type	Integrated antenna
	Antenna Gain	See Table for Filed Antenna
Product Description	Based on the application, features, or specification exhibited in User's Manual, More details of EUT technical specification, please refer to the User's Manual.	
Channel List	Please refer to the Note 2.	
Power Source	DC 3.7V	
Adapter	N/A	
hardware version	N/A	
Software version	N/A	

Note:

1. For a more detailed features description, please refer to the manufacturer's specifications or the User's Manual.

2.

Frequency and Channel list for 802.11a/n(20 MHz) band III (5745-5825MHz):

802.11a/n( 20 MHz) Carrier Frequency Channel							
Channel	Frequen cy (MHz)	Channel	Frequen cy (MHz)	Channel	Frequen cy (MHz)	Channel	Frequen cy (MHz)
149	5745	153	5765	157	5785	161	5805
165	5825	-	-	-	-	-	-

Frequency and Channel list for 802.11n(40MHz) band III (5755-5795MHz):

802.11n 40MHz Carrier Frequency Channel					
Channel	Frequency (MHz)	Channel	Frequency (MHz)	Channel	Frequency (MHz)
151	5755	159	5795	-	-

3. Table for Filed Antenna

Ant.	Brand	Model Name	Antenna Type	Gain (dBi)	NOTE
2	N/A	N/A	Integrated antenna	1.7dBi	

**5. DESCRIPTION OF TEST MODES**

To investigate the maximum EMI emission characteristics generates from EUT, the test system was pre-scanning tested base on the consideration of following EUT operation mode or test configuration mode which possible have effect on EMI emission level. Each of these EUT operation mode(s) or test configuration mode(s) mentioned above was evaluated respectively.

Pretest Mode	Description
Mode 1	802.11a /n 20M CH149/ CH157/ CH 165
Mode 2	802.11n 40M CH 151 / CH 159
Mode 3	Link Mode
<b>For Radiated Emission</b>	
Final Test Mode	Description
Mode 1	802.11a /n 20M CH149/ CH157/ CH 165
Mode 2	802.11n 40M CH 151 / CH 159
Mode 3	Link Mode

**6. BLOCK DIGRAM SHOWING THE CONFIGURATION OF SYSTEM TESTED**

Conducted/Radiated Spurious Emission Test

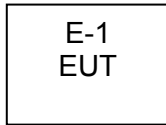

**7. DESCRIPTION OF SUPPORT UNITS(CONDUCTED MODE)**

The EUT has been tested as an independent unit together with other necessary accessories or support units. The following support units or accessories were used to form a representative test configuration during the tests.

Item	Equipment	Mfr/Brand	Model/Type No.	Series No.	Note
E-1	5.8GHz/2.4GH wireless local area network equipment		FM2000	N/A	EUT

Item	Shielded Type	Ferrite Core	Length	Note

Note:

- (1) The support equipment was authorized by Declaration of Confirmation.
- (2) For detachable type I/O cable should be specified the length in cm in 『Length』 column.

### 8. EQUIPMENTS LIST FOR ALL TEST ITEMS

Radiation Test equipment

Item	Kind of Equipment	Manufacturer	Type No.	Serial No.	Last calibration	Calibrated until	Calibration period
1	Spectrum Analyzer	Agilent	E4407B	MY45108040	2016.07.06	2017.07.05	1 year
2	Test Receiver	R&S	ESPI	101318	2016.06.07	2017.06.06	1 year
3	Bilog Antenna	TESEQ	CBL6111D	31216	2016.07.06	2017.07.05	1 year
4	50Ω Coaxial Switch	Anritsu	MP59B	6200264416	2016.06.07	2017.06.06	1 year
5	Spectrum Analyzer	ADVANTEST	R3132	150900201	2016.06.07	2017.06.06	1 year
6	Horn Antenna	EM	EM-AH-10180	2011071402	2016.07.06	2017.07.05	1 year
7	Horn Ant	Schwarzbeck	BBHA 9170	9170-181	2016.07.06	2017.07.05	1 year
8	Amplifier	EM	EM-30180	060538	2016.12.22	2017.12.21	1 year
9	Loop Antenna	ARA	PLA-1030/B	1029	2016.06.08	2017.06.07	1 year
10	Power Meter	DARE	RPR3006W	100696	2016.12.02	2017.12.01	1 year

Conduction Test equipment

Item	Kind of Equipment	Manufacturer	Type No.	Serial No.	Last calibration	Calibrated until	Calibration period
1	Test Receiver	R&S	ESCI	101160	2016.06.06	2017.06.05	1 year
2	LISN	R&S	ENV216	101313	2016.08.24	2017.08.23	1 year
3	LISN	EMCO	3816/2	00042990	2016.08.24	2017.08.23	1 year
4	50Ω Coaxial Switch	Anritsu	MP59B	6200264417	2016.06.07	2017.06.06	1 year
5	Passive Voltage Probe	R&S	ESH2-Z3	100196	2016.06.07	2017.06.06	1 year
6	Absorbing clamp	R&S	MOS-21	100423	2016.06.08	2017.06.07	1 year

**9. EMC EMISSION TEST**

**9.1 CONDUCTED EMISSION MEASUREMENT**

**POWER LINE CONDUCTED EMISSION Limits (Frequency Range 150KHz-30MHz)**

FREQUENCY (MHz)	Class B (dBuV)		Standard
	Quasi-peak	Average	
0.15 -0.5	66 - 56 *	56 - 46 *	CISPR
0.50 -5.0	56.00	46.00	CISPR
5.0 -30.0	60.00	50.00	CISPR

0.15 -0.5	66 - 56 *	56 - 46 *	FCC/ RSS-247
0.50 -5.0	56.00	46.00	FCC/ RSS-247
5.0 -30.0	60.00	50.00	FCC/ RSS-247

Note:

- (1) The tighter limit applies at the band edges.
- (2) The limit of " \* " marked band means the limitation decreases linearly with the logarithm of the frequency in the range.

The following table is the setting of the receiver

Receiver Parameters	Setting
Attenuation	10 dB
Start Frequency	0.15 MHz
Stop Frequency	30 MHz
IF Bandwidth	9 kHz

**9.2 TEST PROCEDURE**

- a. The EUT was placed 0.8 meters from the horizontal ground plane with EUT being connected to the power mains through a line impedance stabilization network (LISN). All other support equipments powered from additional LISN(s). The LISN provide 50 Ohm/ 50uH of coupling impedance for the measuring instrument.
- b. Interconnecting cables that hang closer than 40 cm to the ground plane shall be folded back and forth in the center forming a bundle 30 to 40 cm long.
- c. I/O cables that are not connected to a peripheral shall be bundled in the center. The end of the cable may be terminated, if required, using the correct terminating impedance. The overall length shall not exceed 1 m.
- d. LISN at least 80 cm from nearest part of EUT chassis.
- e. For the actual test configuration, please refer to the related Item –EUT Test Photos.

**9.3 DEVIATION FROM TEST STANDARD**

No deviation

**TEST SETUP**

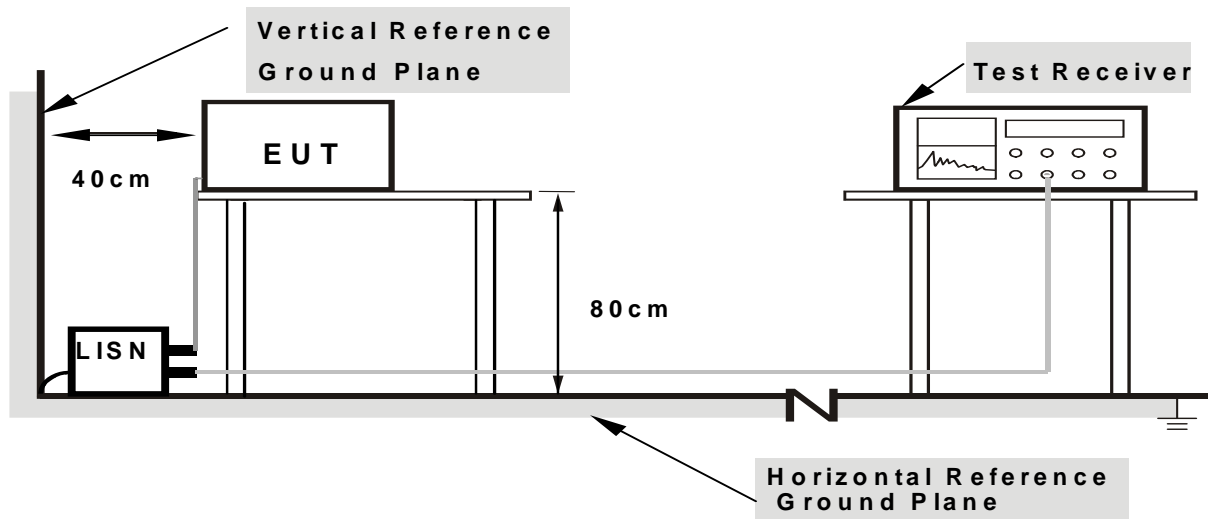

- Note:**
- 1. Support units were connected to second LISN.
  - 2. Both of LISNs (AMN) are 80 cm from EUT and at least 80 from other units and other metal planes

**9.4 EUT OPERATING CONDITIONS**

The EUT was configured for testing in a typical fashion (as a customer would normally use it). The EUT has been programmed to continuously transmit during test. This operating condition was tested and used to collect the included data.

**9.5 TEST RESULT:**

N/A

## 10 RADIATED EMISSION MEASUREMENT

### 10.1 APPLICABLE STANDARD

According to FCC Part 15.407(d) and 15.209

### 10.2 CONFORMANCE LIMIT

According to FCC Part 15.407(b)(7): radiated emissions which fall in the restricted bands, as defined in §15.205(a), must also comply with the radiated emission limits specified in §15.209(a) (see §15.205(c)).  
According to FCC Part 15.205, Restricted bands

MHz	MHz	MHz	GHz
0.090-0.110	16.42-16.423	399.9-410	4.5-5.15
10.495-0.505	16.69475-16.69525	608-614	5.35-5.46
2.1735-2.1905	16.80425-16.80475	960-1240	7.25-7.75
4.125-4.128	25.5-25.67	1300-1427	8.025-8.5
4.17725-4.17775	37.5-38.25	1435-1626.5	9.0-9.2
4.20725-4.20775	73-74.6	1645.5-1646.5	9.3-9.5
6.215-6.218	74.8-75.2	1660-1710	10.6-12.7
6.26775-6.26825	123-138	2200-2300	14.47-14.5
8.291-8.294	149.9-150.05	2310-2390	15.35-16.2
8.362-8.366	156.52475-156.52525	2483.5-2500	17.7-21.4
8.37625-8.38675	156.7-156.9	2690-2900	22.01-23.12
8.41425-8.41475	162.0125-167.17	3260-3267	23.6-24.0
12.29-12.293	167.72-173.2	3332-3339	31.2-31.8
12.51975-12.52025	240-285	3345.8-3358	36.43-36.5
12.57675-12.57725	322-335.4	3600-4400	(2)
13.36-13.41			

20dBc in any 100 kHz bandwidth outside the operating frequency band. In case the emission fall within the restricted band specified on 15.205(a), then the 15.209(a) limit in the table below has to be followed.

Restricted Frequency(MHz)	Field Strength ( $\mu\text{V}/\text{m}$ )	Field Strength ( $\text{dB}\mu\text{V}/\text{m}$ )	Measurement Distance
0.009-0.490	2400/F(KHz)	20 log ( $\mu\text{V}/\text{m}$ )	300
0.490-1.705	2400/F(KHz)	20 log ( $\mu\text{V}/\text{m}$ )	30
1.705-30.0	30	29.5	30
30-88	100	40	3
88-216	150	43.5	3
216-960	200	46	3
Above 960	500	54	3

#### Limits of Radiated Emission Measurement(Above 1000MHz)

Frequency(MHz)	Class B ( $\text{dB}\mu\text{V}/\text{m}$ ) (at 3M)	
	PEAK	AVERAGE
Above 1000	74	54

- Remark :1. Emission level in  $\text{dB}\mu\text{V}/\text{m}=20 \log (\mu\text{V}/\text{m})$   
 2. Measurement was performed at an antenna to the closed point of EUT distance of meters.  
 3. Distance extrapolation factor = $40\log(\text{Specific distance}/ \text{test distance})(\text{dB})$ ;  
 Limit line=Specific limits( $\text{dB}\mu\text{V}$ ) + distance extrapolation factor.

### 10.3 MEASURING INSTRUMENTS

The Measuring equipment is listed in the section 6.3 of this test report.

### 10.4 TEST CONFIGURATION

(a) For radiated emissions below 30MHz

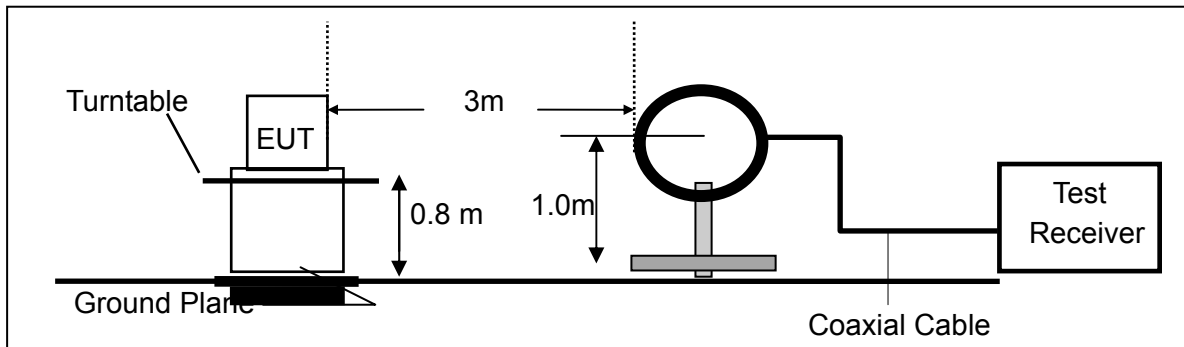

(b) For radiated emissions from 30MHz to 1000MHz

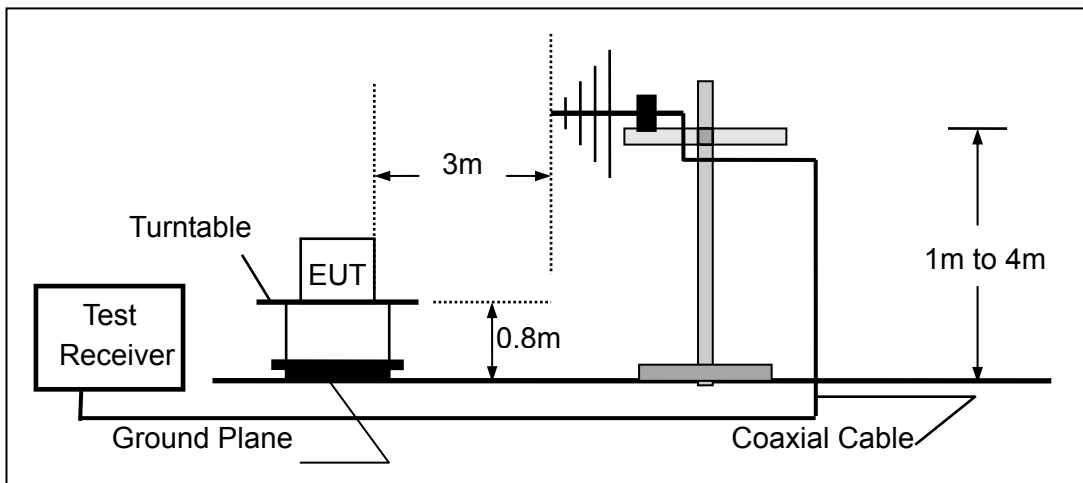

(c) For radiated emissions above 1000MHz

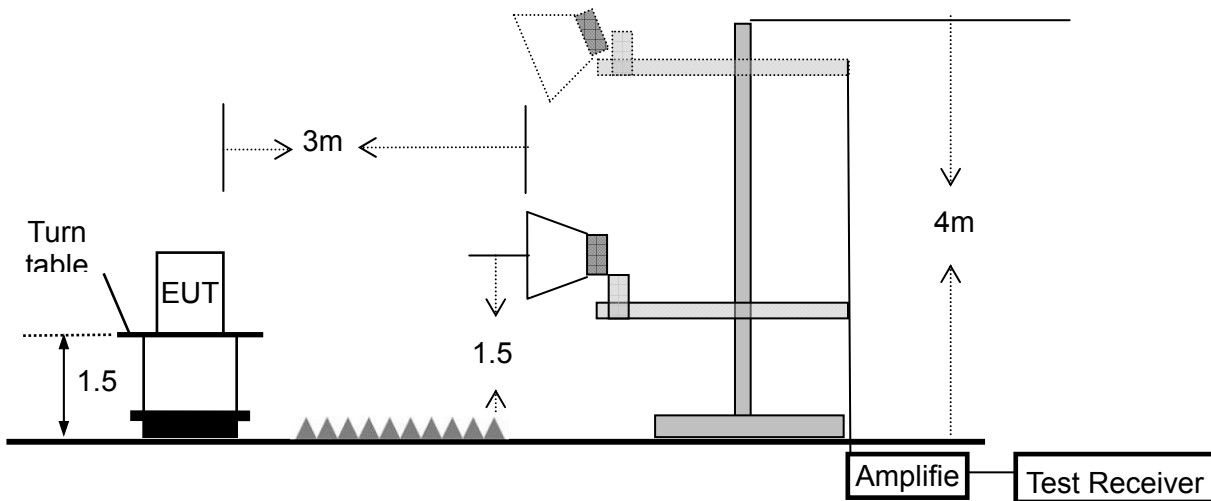

### 10.5 TEST PROCEDURE

The test site semi-anechoic chamber has met the requirement of NSA tolerance 4 dB according to the standards: ANSI C63.10-2013. The test distance is 3m. The setup is according to the requirements in Section 13.1.4.1 of ANSI C63.10-2013 and CAN/CSA-CEI/IEC CISPR 22.

This test is required for any spurious emission that falls in a Restricted Band, as defined in Section 15.205. It must be performed with the highest gain of each type of antenna proposed for use with the EUT.

Use the following spectrum analyzer settings:

Spectrum Parameter	Setting
Attenuation	Auto
Start Frequency	1000 MHz
Stop Frequency	10th carrier harmonic
RB / VB (emission in restricted band)	1 MHz / 1 MHz for Peak, 1 MHz / 10Hz for Average

Receiver Parameter	Setting
Attenuation	Auto
Start ~ Stop Frequency	9kHz~150kHz / RB 200Hz for QP
Start ~ Stop Frequency	150kHz~30MHz / RB 9kHz for QP
Start ~ Stop Frequency	30MHz~1000MHz / RB 120kHz for QP

- The measuring distance of at 3 m shall be used for measurements at frequency up to 1GHz and frequencies above 1GHz,
- The EUT was placed on the top of a rotating table 0.8 m for below 1GHz and 1.5m for above 1GHz the ground at a 3 meter. The table was rotated 360 degrees to determine the position of the highest radiation.
- The height of the equipment or of the substitution antenna shall be 0.8 m for below 1GHz and 1.5m for above 1GHz; the height of the test antenna shall vary between 1 m to 4 m. Both horizontal and vertical polarizations of the antenna are set to make the measurement.
- For the radiated emission test above 1GHz:
  - Place the measurement antenna away from each area of the EUT determined to be a source of emissions at the specified measurement distance, while keeping the measurement antenna aimed at the source of emissions at each frequency of significant emissions, with polarization oriented for maximum response. The measurement antenna may have to be higher or lower than the EUT, depending on the radiation pattern of the emission and staying aimed at the emission source for receiving the maximum signal. The final measurement antenna elevation shall be that which maximizes the emissions. The measurement antenna elevation for maximum emissions shall be restricted to a range of heights of from 1 m to 4 m above the ground or reference ground plane.
- The initial step in collecting conducted emission data is a spectrum analyzer peak detector mode pre-scanning the measurement frequency range. Significant peaks are then marked and then Quasi Peak detector mode re-measured.

- f. If the Peak Mode measured value compliance with and lower than Quasi Peak Mode Limit, the EUT shall be deemed to meet QP Limits and then no additional QP Mode measurement performed.
- g For the actual test configuration, please refer to the related Item –EUT Test Photos.

Note:

Both horizontal and vertical antenna polarities were tested and performed pretest to three orthogonal axis. The worst case emissions were reported

During the radiated emission test, the Spectrum Analyzer was set with the following configurations:

Frequency Band (MHz)	Function	Resolution bandwidth	Video Bandwidth
30 to 1000	QP	120 kHz	300 kHz
Above 1000	Peak	1 MHz	1 MHz
	Average	1 MHz	10 Hz

Note: for the frequency ranges below 30 MHz, a narrower RBW is used for these ranges but the measured value should add a RBW correction factor (RBWCF) where  $RBWCF [dB] = 10 \cdot \lg(100 [kHz] / \text{narrower RBW [kHz]})$ . , the narrower RBW is 1 kHz and RBWCF is 20 dB for the frequency 9 kHz to 150 kHz, and the narrower RBW is 10 kHz and RBWCF is 10 dB for the frequency 150 kHz to 30 MHz.

**10.6 TEST RESULTS (BETWEEN 9KHZ – 30 MHZ)**

Temperature:	20 °C	Relative Humidity:	48%
Pressure:	1010 hPa	Test Voltage :	DC 3.7V
Test Mode :	TX	Polarization :	--

Freq. (MHz)	Reading (dBuV/m)	Limit (dBuV/m)	Margin (dB)	State P/F
--	--	--	--	N/A
--	--	--	--	N/A

**NOTE:**

The amplitude of spurious emissions which are attenuated by more than 20dB below the permissible value has no need to be reported.

Distance extrapolation factor =  $40 \log (\text{specific distance}/\text{test distance})(\text{dB})$ ;

Limit line = specific limits(dBuv) + distance extrapolation factor.

### 10.7 TEST RESULTS (BETWEEN 30MHZ - 1GHZ)

■ Spurious Emission below 1GHz (30MHz to 1GHz)

Temperature :	20 °C	Relative Humidity :	48%
Pressure :	1010 hPa	Test Voltage :	DC 3.7V
Test Mode :	TX (802.11a)		

All the modulation modes have been tested, and the worst result was report as below:

Polar (H/V)	Frequency	Meter Reading	Factor	Emission Level	Limits	Margin	Remark
	(MHz)	(dBuV)	(dB)	(dBuV/m)	(dBuV/m)	(dB)	
V	42.8997	14.58	13.79	28.37	40.00	-11.63	QP
V	82.6482	18.74	10.08	28.82	40.00	-11.18	QP
V	119.4361	14.02	11.57	25.59	43.50	-17.91	QP
V	327.8873	14.99	14.83	29.82	46.00	-16.18	QP
V	470.5230	15.16	17.73	32.89	46.00	-13.11	QP
V	528.2458	14.83	18.86	33.69	46.00	-12.31	QP
V	938.8324	9.39	27.44	36.83	46.00	-9.17	QP

**Remark:**

Absolute Level= ReadingLevel+ Factor, Margin= Absolute Level - Limit

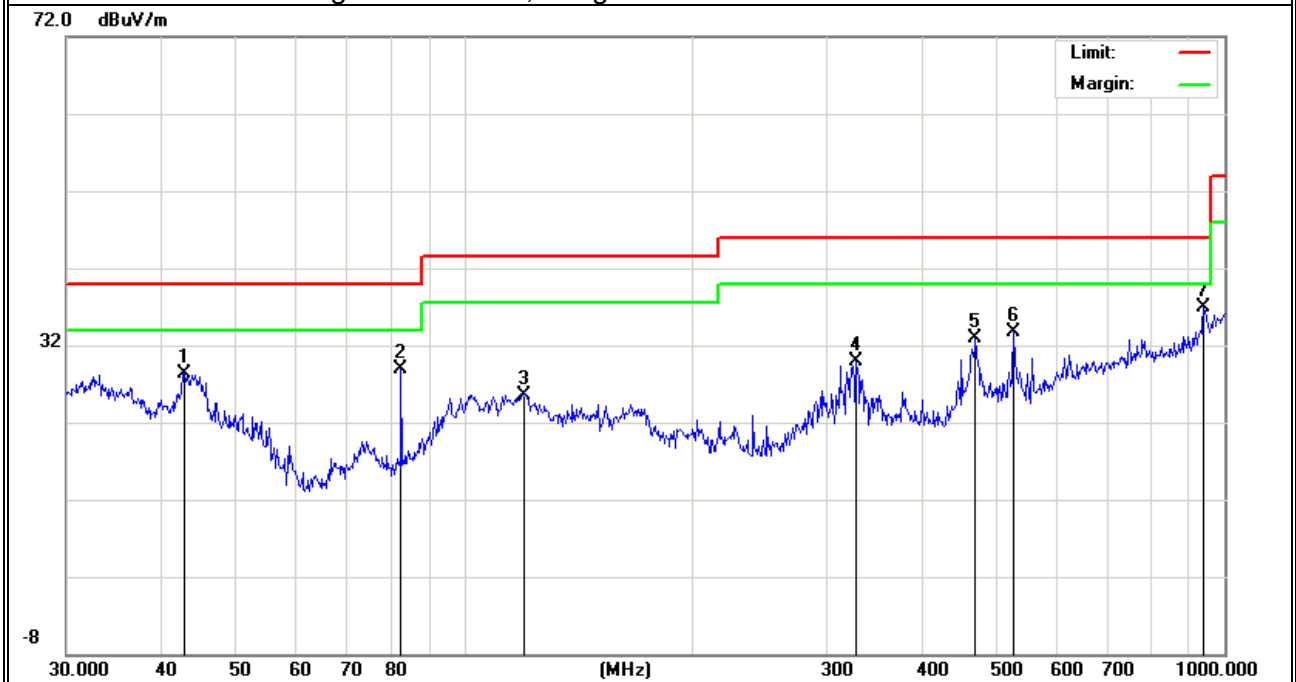

Polar (H/V)	Frequency	Meter Reading	Factor	Emission Level	Limits	Margin	Remark
	(MHz)	(dBUV)	(dB)	(dBUV/m)	(dBUV/m)	(dB)	
H	250.3010	13.11	12.12	25.23	46.00	-20.77	QP
H	299.3158	17.66	13.82	31.48	46.00	-14.52	QP
H	528.2458	14.48	18.86	33.34	46.00	-12.66	QP
H	651.9417	13.31	21.63	34.94	46.00	-11.06	QP
H	801.7862	11.38	24.04	35.42	46.00	-10.58	QP
H	942.1304	8.82	27.55	36.37	46.00	-9.63	QP

**Remark:**

Absolute Level= ReadingLevel+ Factor, Margin= Absolute Level - Limit

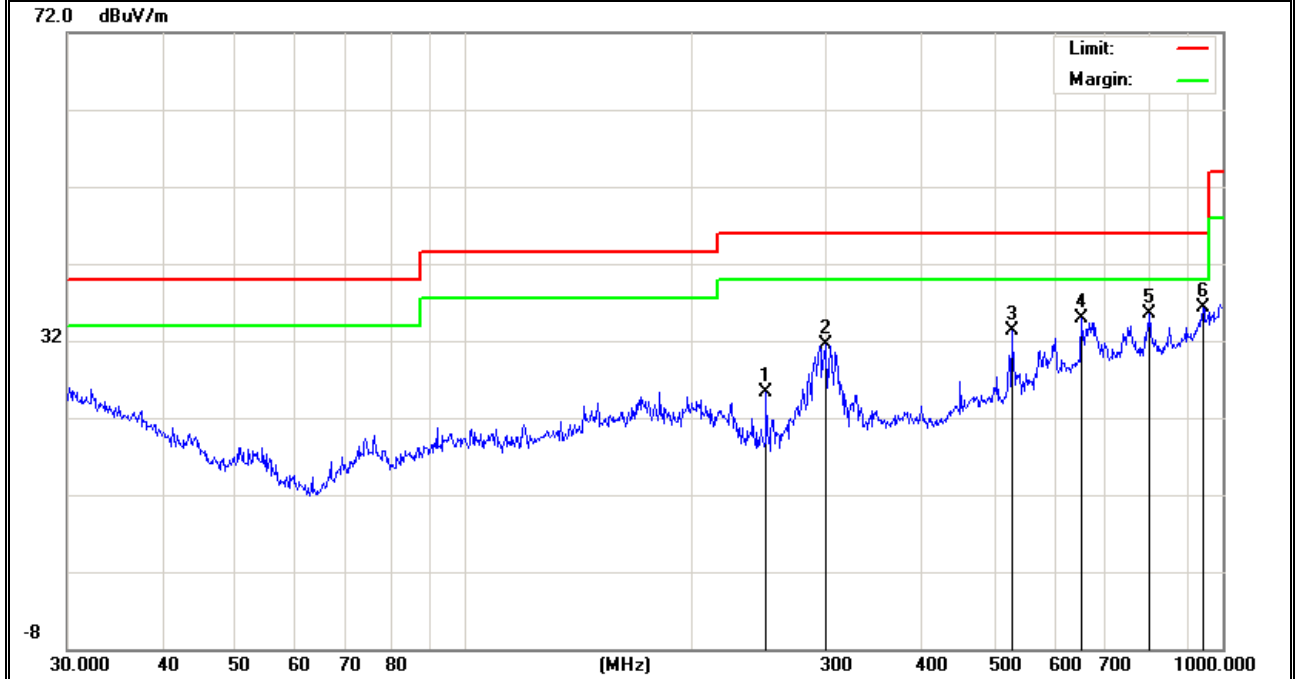

Temperature :	20 °C	Relative Humidity :	48%
Pressure :	1010 hPa	Test Voltage :	DC 3.7V
Test Mode :	TX (802.11n)		

All the modulation modes have been tested, and the worst result was report as below:

Polar (H/V)	Frequency	Meter Reading	Factor	Emission Level	Limits	Margin	Remark
	(MHz)	(dBuV)	(dB)	(dBuV/m)	(dBuV/m)	(dB)	
V	34.6385	18.36	18.04	36.40	40.00	-3.60	QP
V	38.8878	20.35	15.85	36.20	40.00	-3.80	QP
V	52.9453	26.13	9.17	35.30	40.00	-4.70	QP
V	150.0107	17.78	12.83	30.61	43.50	-12.89	QP
V	446.4141	17.95	17.27	35.22	46.00	-10.78	QP
V	625.0778	13.64	21.13	34.77	46.00	-11.23	QP
V	938.8324	9.54	27.44	36.98	46.00	-9.02	QP

**Remark:**

Absolute Level= ReadingLevel+ Factor, Margin= Absolute Level - Limit

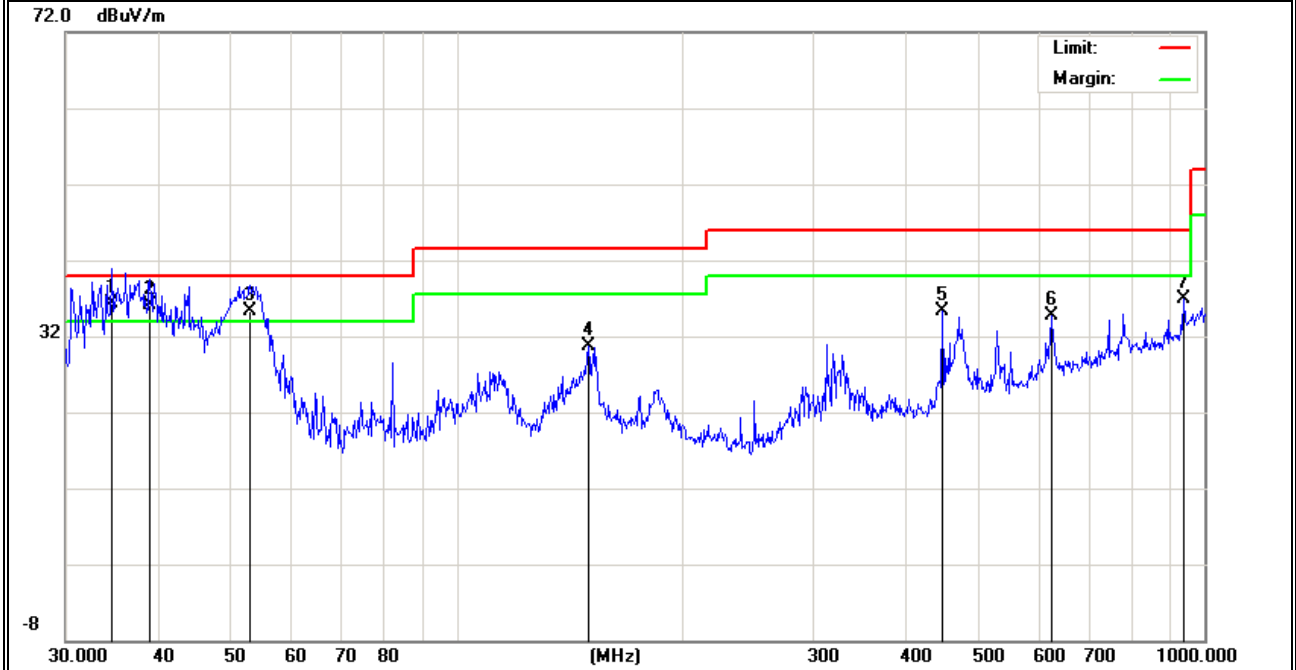

Polar (H/V)	Frequency	Meter Reading	Factor	Emission Level	Limits	Margin	Remark
	(MHz)	(dBuV)	(dB)	(dBuV/m)	(dBuV/m)	(dB)	
H	53.6932	21.25	8.85	30.10	40.00	-9.90	QP
H	148.4410	16.53	12.69	29.22	43.50	-14.28	QP
H	308.9126	18.55	14.22	32.77	46.00	-13.23	QP
H	446.4141	10.34	17.27	27.61	46.00	-18.39	QP
H	531.9633	12.64	18.97	31.61	46.00	-14.39	QP
H	750.1082	10.20	23.42	33.62	46.00	-12.38	QP

**Remark:**

Absolute Level= ReadingLevel+ Factor, Margin= Absolute Level - Limit

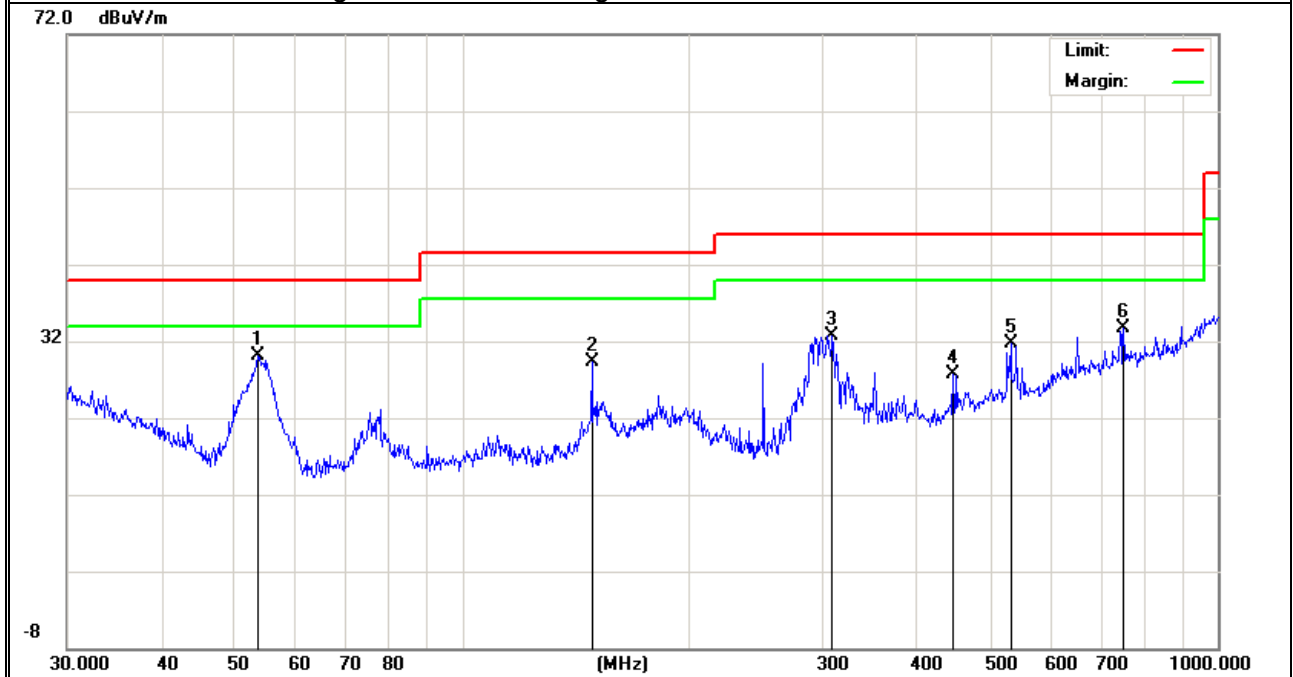

### 3.2.8 TEST RESULTS (1GHZ-18GHZ)

Temperature :	20 °C	Relative Humidity :	48%
Pressure :	1010 hPa	Test Voltage :	DC 3.7V
Test Mode :	TX (5.8G)-802.11a 5745-5825MHz		

All the modulation modes have been tested, and the worst result was report as below:

Polar	Frequency	Meter Reading	Cable loss	Antenna Factor	Preamp Factor	Emission Level	Limits	Margin	Detector Type
(H/V)	(MHz)	(dBuV)	(dB)	dB/m	(dB)	(dBuV/m)	(dBuV/m)	(dB)	
Low Channel (5745 MHz)-Above 1G									
Vertical	4679.234	52.13	5.94	35.40	44.00	49.47	74.00	-24.53	Pk
Vertical	4679.234	45.59	5.94	35.40	44.00	42.93	54.00	-11.07	AV
Vertical	11490.227	60.67	8.46	39.75	44.50	64.38	74.00	-9.62	Pk
Vertical	11490.227	44.15	8.46	39.75	44.50	47.86	54.00	-6.14	AV
Vertical	17235.265	56.84	10.12	38.80	44.10	61.66	74.00	-12.34	Pk
Vertical	17235.154	40.26	10.12	38.80	42.70	46.48	54.00	-7.52	AV
Horizontal	4679.639	57.51	5.94	35.18	44.00	54.63	74.00	-19.37	Pk
Horizontal	4679.639	44.18	5.94	35.18	44.00	41.3	54.00	-12.7	AV
Horizontal	11490.128	59.86	8.46	38.71	44.50	62.53	74.00	-11.47	Pk
Horizontal	10360.605	44.31	8.46	38.71	44.50	46.98	54.00	-7.02	AV
Horizontal	17235.111	58.16	10.12	38.38	44.10	62.56	74.00	-11.44	Pk
Horizontal	17235.109	42.86	10.12	38.38	44.10	47.26	54.00	-6.74	AV
middle Channel (5785 MHz)-Above 1G									
Vertical	4592.256	58.64	6.48	36.35	44.05	57.42	74.00	-16.58	Pk
Vertical	4592.256	43.18	6.48	36.35	44.05	41.96	54.00	-12.04	AV
Vertical	11570.199	59.85	8.47	37.88	44.51	61.69	74.00	-12.31	Pk
Vertical	11570.199	43.85	8.47	37.88	44.51	45.69	54.00	-8.31	AV
Vertical	17355.128	57.18	10.12	38.8	44.10	62	74.00	-12	Pk
Vertical	17355.128	40.16	10.12	38.8	42.70	46.38	54.00	-7.62	AV
Horizontal	4592.535	59.88	6.48	36.37	44.05	58.68	74.00	-15.32	Pk
Horizontal	4592.535	43.27	6.48	36.37	44.05	42.07	54.00	-11.93	AV
Horizontal	11570.271	60.56	8.47	38.64	44.50	63.17	74.00	-10.83	Pk
Horizontal	11570.271	46.26	8.47	38.64	44.50	48.87	54.00	-5.13	AV
Horizontal	17355.247	59.86	10.12	38.38	44.10	64.26	74.00	-9.74	Pk
Horizontal	17356.721	44.31	10.12	38.38	44.10	48.71	54.00	-5.29	AV
High Channel (5825 MHz)-Above 1G									
Vertical	6039.235	58.96	7.10	37.24	43.50	59.8	74.00	-14.2	Pk
Vertical	6039.235	46.62	7.10	37.24	43.50	47.46	54.00	-6.54	AV
Vertical	11652.838	55.53	8.46	37.68	44.50	57.17	74.00	-16.83	Pk
Vertical	11652.838	42.27	8.46	37.68	44.50	43.91	54.00	-10.09	AV
Vertical	17473.128	59.86	10.12	38.8	44.10	64.68	74.00	-9.32	Pk
Vertical	17473.107	39.97	10.12	38.8	42.70	46.19	54.00	-7.81	AV
Horizontal	6039.101	66.69	7.10	37.24	43.50	67.53	74.00	-6.47	Pk
Horizontal	6039.101	42.2	7.10	37.24	43.50	43.04	54.00	-10.96	AV
Horizontal	11652.283	56.63	8.46	38.57	44.50	59.16	74.00	-14.84	Pk
Horizontal	11652.283	43.77	8.46	38.57	44.50	46.3	54.00	-7.7	AV
Horizontal	17474.247	59.86	10.12	38.38	44.10	64.26	74.00	-9.74	Pk
Horizontal	17474.721	44.31	10.12	38.38	44.10	48.71	54.00	-5.29	AV

Note: "802.11a (5G)" mode is the worst mode. PK value is lower than the Average value limit, So average didn't record.

The amplitude of spurious emissions that are attenuated by more than 20dB below the permissible value has no need to be reported.

Emission level (dBuV/m) = 20 log Emission level (uV/m).

Corrected Reading: Antenna Factor + Cable Loss + Read Level - Preamp Factor = Level.

**TEST RESULTS (18GHz-40GHz)**

Temperature :	20 °C	Relative Humidity :	48%
Pressure :	1010 hPa	Test Voltage :	DC 3.7V
Test Mode :	TX (5.8G) -802.11N(20) 5745MHz~5825MHz		

All the modulation modes have been tested, and the worst result was report as below:  
 Low Channel (802.11N(20) 5180 MHz)-Above 1G

Horizontal

FCC Electric Field Strength 18-26.5GHz

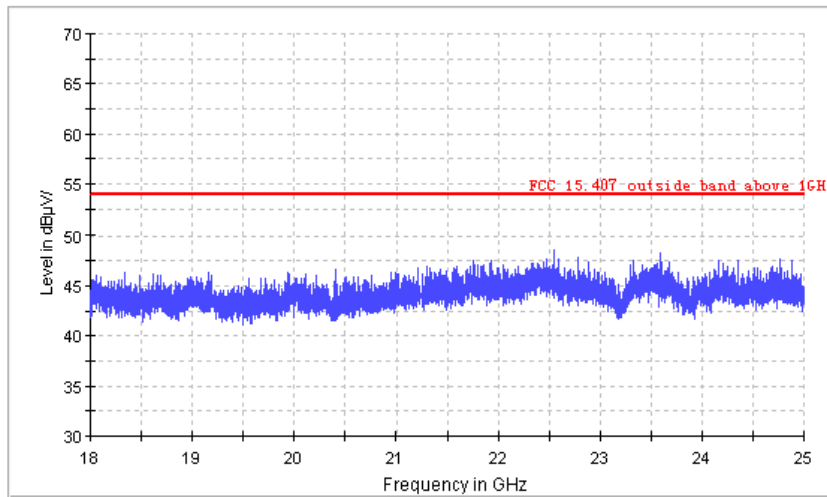

Vertical

FCC Electric Field Strength 18-26.5GHz

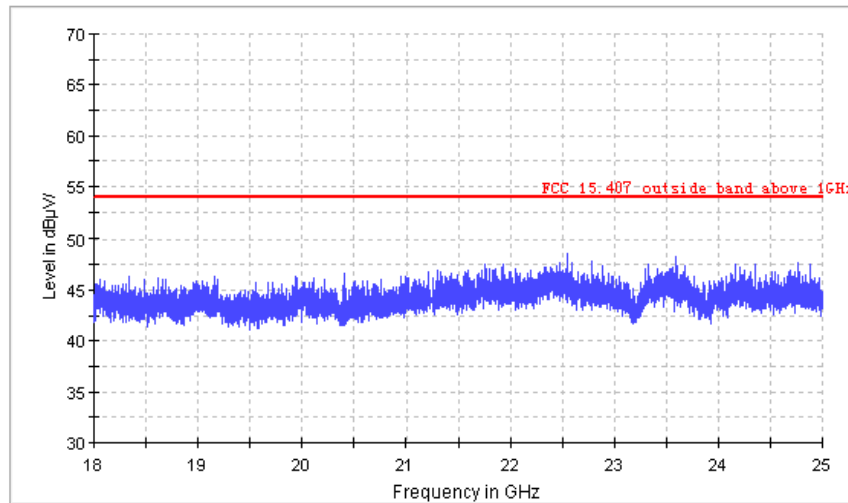

Horizontal

FCC Electric Field Strength 26.5-40GHz

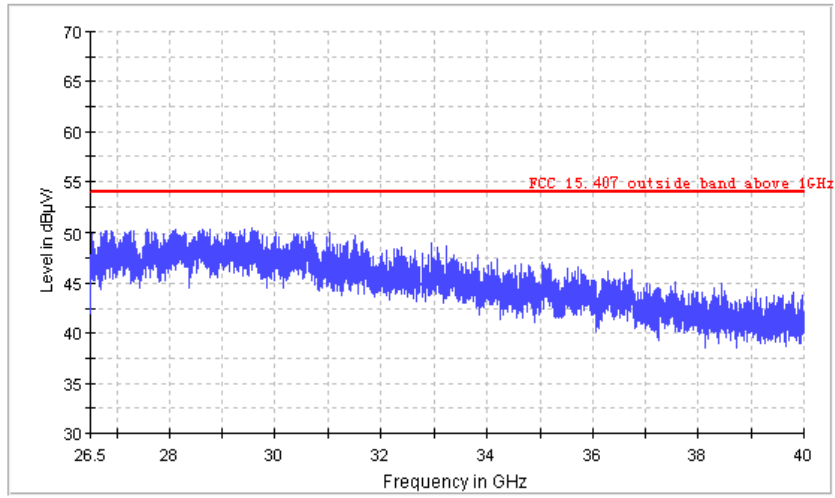

Vertical

FCC Electric Field Strength 26.5-40GHz

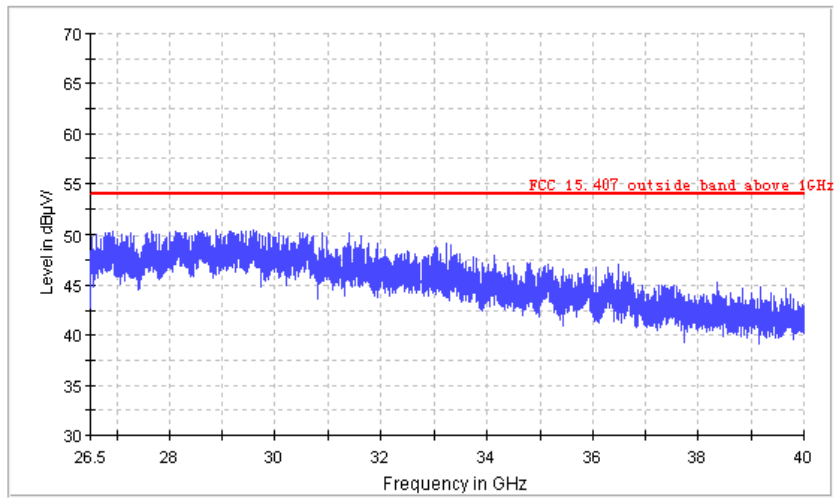

## 11. POWER SPECTRAL DENSITY TEST

### 11.1 APPLIED PROCEDURES / LIMIT

#### According to FCC §15.407(a)(3)

For the band 5.15-5.25 GHz,

- (i) For an outdoor access point operating in the band 5.15-5.25 GHz, the maximum power spectral density shall not exceed 17 dBm in any 1 megahertz band. If transmitting antennas of directional gain greater than 6 dBi are used, both the maximum conducted output power and the maximum power spectral density shall be reduced by the amount in dB that the directional gain of the antenna exceeds 6 dBi. The maximum e.i.r.p. at any elevation angle above 30 degrees as measured from the horizon must not exceed 125 mW (21 dBm).
- (ii) For an indoor access point operating in the band 5.15-5.25 GHz, the maximum power spectral density shall not exceed 17 dBm in any 1 megahertz band. If transmitting antennas of directional gain greater than 6 dBi are used, both the maximum conducted output power and the maximum power spectral density shall be reduced by the amount in dB that the directional gain of the antenna exceeds 6 dBi.
- (iii) For fixed point-to-point access points operating in the band 5.15-5.25 GHz, the maximum power spectral density shall not exceed 17 dBm in any 1 megahertz band. Fixed point-to-point U-NII devices may employ antennas with directional gain up to 23 dBi without any corresponding reduction in the maximum conducted output power or maximum power spectral density. For fixed point-to-point transmitters that employ a directional antenna gain greater than 23 dBi, a 1 dB reduction in maximum conducted output power and maximum power spectral density is required for each 1 dB of antenna gain in excess of 23 dBi. Fixed, point-to-point operations exclude the use of point-to-multipoint systems, omnidirectional applications, and multiple collocated transmitters transmitting the same information. The operator of the U-NII device, or if the equipment is professionally installed, the installer, is responsible for ensuring that systems employing high gain directional antennas are used exclusively for fixed, point-to-point operations.
- (iv) For mobile and portable client devices in the 5.15-5.25 GHz band, the maximum power spectral density shall not exceed 11 dBm in any 1 megahertz band. If transmitting antennas of directional gain greater than 6 dBi are used, both the maximum conducted output power and the maximum power spectral density shall be reduced by the amount in dB that the directional gain of the antenna exceeds 6 dBi.

For the band 5.725-5.85 GHz

- (3) For the band 5.725-5.85 GHz, the maximum power spectral density shall not exceed 30 dBm in any 500-kHz band. If transmitting antennas of directional gain greater than 6 dBi are used, both the maximum conducted output power and the maximum power spectral density shall be reduced by the amount in dB that the directional gain of the antenna exceeds 6 dBi.

## 11.2 TEST PROCEDURE

For devices operating in the bands 5.15-5.25 GHz, 5.25-5.35 GHz, and 5.47-5.725 GHz, the above procedures make use of 1 MHz RBW to satisfy directly the 1 MHz reference bandwidth specified in § 15.407(a)(5). For devices operating in the band 5.725-5.85 GHz, the rules specify a measurement bandwidth of 500 kHz. Many spectrum analyzers do not have 500 kHz RBW, thus a narrower RBW may need to be used. The rules permit the use of a RBWs less than 1 MHz, or 500 kHz, “provided that the measured power is integrated over the full reference bandwidth” to show the total power over the specified measurement bandwidth (i.e., 1 MHz, or 500 kHz). If measurements are performed using a reduced resolution bandwidth (< 1 MHz, or < 500 kHz) and integrated over 1 MHz, or 500 KHz bandwidth, the following adjustments to the procedures apply:

- a) Set  $RBW \geq 1/T$ , where T is defined in section II.B.I.a).
- b) Set  $VBW \geq 3 RBW$ .
- c) If measurement bandwidth of Maximum PSD is specified in 500 kHz, add  $10\log(500\text{kHz}/RBW)$  to the measured result, whereas RBW (< 500 KHz) is the reduced resolution bandwidth of the spectrum analyzer set during measurement.
- d) If measurement bandwidth of Maximum PSD is specified in 1 MHz, add  $10\log(1\text{MHz}/RBW)$  to the measured result, whereas RBW (< 1 MHz) is the reduced resolution bandwidth of spectrum analyzer set during measurement.
- e) Care must be taken to ensure that the measurements are performed during a period of continuous transmission or are corrected upward for duty cycle.

Note: As a practical matter, it is recommended to use reduced RBW of 100 KHz for the sections 5.c) and 5.d) above, since RBW=100 KHz is available on nearly all spectrum analyzers.

## 11.3 DEVIATION FROM STANDARD

No deviation.

## 11.4 TEST SETUP

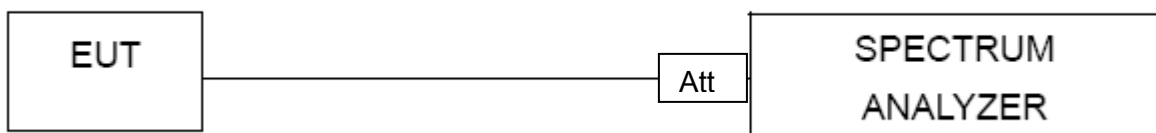

## 11.5 EUT OPERATION CONDITIONS

The EUT tested system was configured as the statements of 2.1 Unless otherwise a special operating condition is specified in the follows during the testing.

**11.6 TEST RESULTS**

Temperature :	25 °C	Relative Humidity :	56%
Pressure :	1015 hPa	Test Voltage :	DC 3.7V
Test Mode :	TX Frequency Band III (5725-5825MHz)		

Mode	Frequency	Measured Power Density	Limit (dBm)	Result
		(dBm)		
802.11 a	5745 MHz	1.662	30	PASS
	5785 MHz	0.727	30	PASS
	5825 MHz	-0.121	30	PASS
802.11 n20	5745 MHz	1.568	30	PASS
	5785 MHz	1.029	30	PASS
	5825 MHz	0.071	30	PASS
802.11 n40	5755 MHz	-3.637	30	PASS
	5795 MHz	-4.17	30	PASS

(802.11a) PSD plot on channel 149



(802.11n20) PSD plot on channel 149

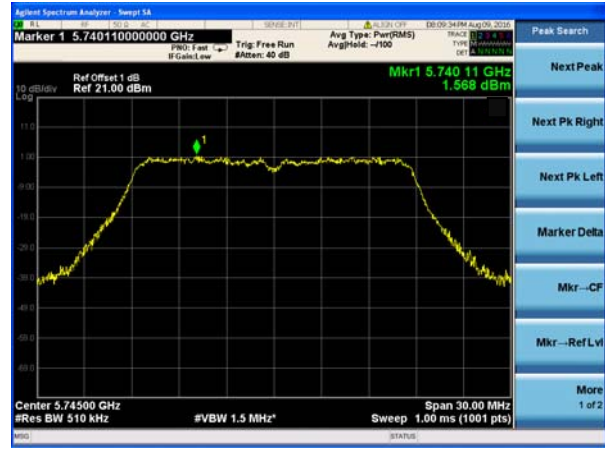

(802.11a) PSD plot on channel 157



(802.11n20) PSD plot on channel 157

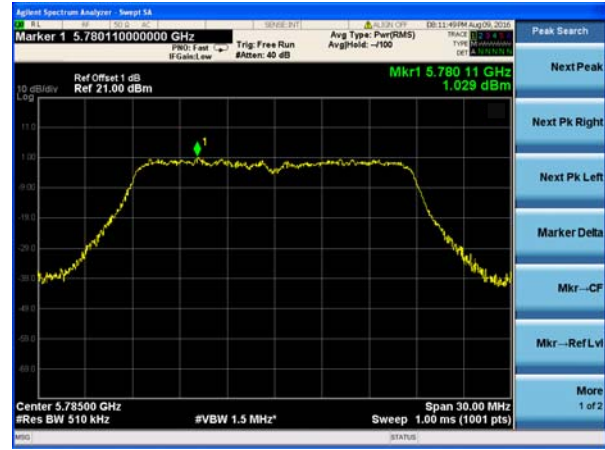

(802.11a) PSD plot on channel 165



(802.11n20) PSD plot on channel 165

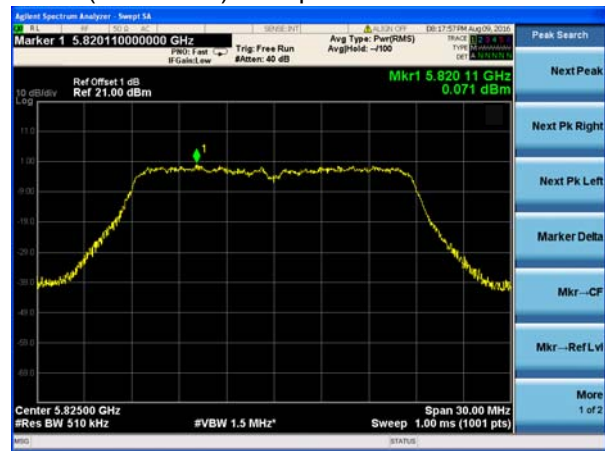

(802.11n40) PSD plot on channel 151



(802.11n40) PSD plot on channel 159



## **12. 26 DB & 99% EMISSION BANDWIDTH**

### **12.1 APPLIED PROCEDURES / LIMIT**

The maximum power spectral density is measured as a conducted emission by direct connection of a calibrated test instrument to the equipment under test. If the device cannot be connected directly, alternative techniques acceptable to the Commission may be used. Measurements in the 5.725-5.85 GHz band are made over a reference bandwidth of 500 kHz or the 26 dB emission bandwidth of the device, whichever is less. Measurements in the 5.15-5.25 GHz, 5.25-5.35 GHz, and the 5.47-5.725 GHz bands are made over a bandwidth of 1 MHz or the 26 dB emission bandwidth of the device, whichever is less. A narrower resolution bandwidth can be used, provided that the measured power is integrated over the full reference bandwidth.

### **12.2 TEST PROCEDURE**

- a) Set RBW = approximately 1% of the emission bandwidth.
- b) Set the VBW > RBW.
- c) Detector = Peak.
- d) Trace mode = max hold.
- e) Measure the maximum width of the emission that is 26 dB down from the maximum of the emission. Compare this with the RBW setting of the analyzer. Readjust RBW and repeat measurement as needed until the RBW/EBW ratio is approximately 1%.

The following procedure shall be used for measuring (99 %) power bandwidth:

1. Set center frequency to the nominal EUT channel center frequency.
2. Set span = 1.5 times to 5.0 times the OBW.
3. Set RBW = 1 % to 5 % of the OBW
4. Set VBW  $\geq 3 \cdot$  RBW
5. Video averaging is not permitted. Where practical, a sample detection and single sweep mode shall be used. Otherwise, peak detection and max hold mode (until the trace stabilizes) shall be used.
6. Use the 99 % power bandwidth function of the instrument (if available).
7. If the instrument does not have a 99 % power bandwidth function, the trace data points are recovered and directly summed in power units. The recovered amplitude data points, beginning at the lowest frequency, are placed in a running sum until 0.5 % of the total is reached; that frequency is recorded as the lower frequency. The process is repeated until 99.5 % of the total is reached; that frequency is recorded as the upper frequency. The 99% occupied bandwidth is the difference between these two frequencies.

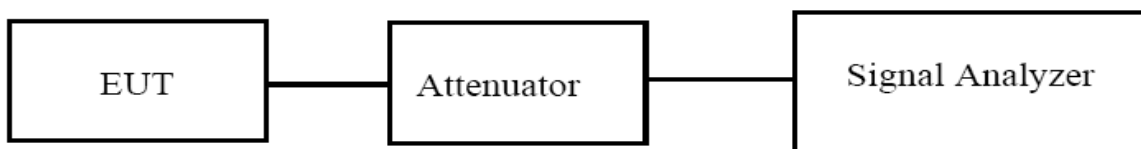

### 12.3 EUT OPERATION CONDITIONS

The EUT tested system was configured as the statements of 2.4 Unless otherwise a special operating condition is specified in the follows during the testing.

**12.4 TEST RESULTS**

Temperature :	25 °C	Relative Humidity :	56%
Pressure :	1012 hPa	Test Voltage :	DC 3.7V
Test Mode :	TX Frequency Band III (5745-5850MHz)		

Mode	Channel	Frequency (MHz)	26dB bandwidth	99% bandwidth	P/F
802.11a	CH149	5745	16.775	21.22	Pass
	CH157	5785	16.776	21.10	Pass
	CH165	5825	16.758	21.03	Pass
802.11 n20	CH149	5745	17.808	21.69	Pass
	CH157	5785	17.810	21.60	Pass
	CH165	5825	17.820	21.81	Pass
802.11 n40	CH 151	5755	36.207	42.21	Pass
	CH 159	5795	36.199	42.42	Pass

(802.11a) -26dB&99% Bandwidth plot on channel 149

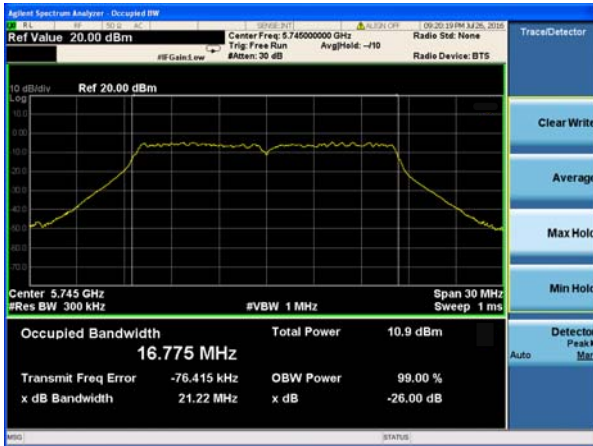

(802.11n20) -26dB&99% Bandwidth plot on channel 149

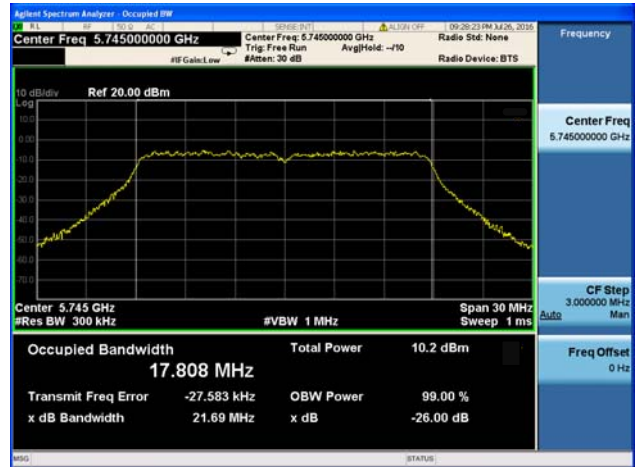

(802.11a) -26dB&99% Bandwidth plot on channel 157

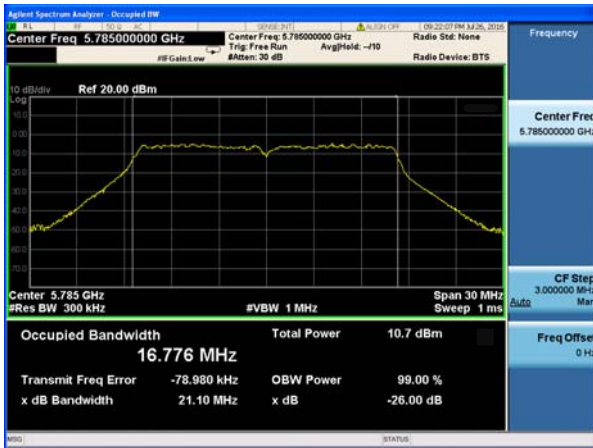

(802.11n20) -26dB&99% Bandwidth plot on channel 157

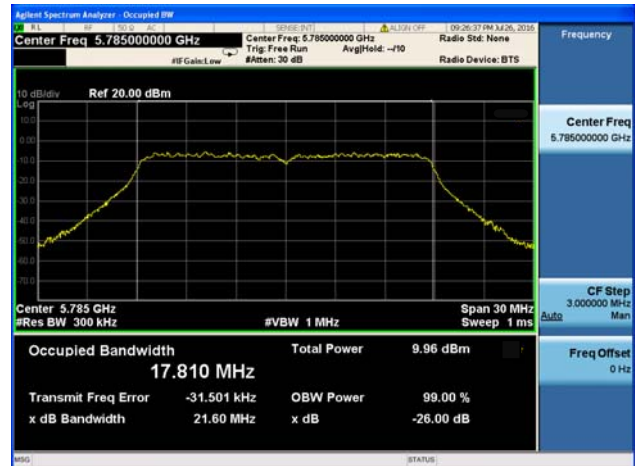

(802.11a) -26dB&99% Bandwidth plot on channel 165



(802.11n20) -26dB&99% Bandwidth plot on channel 165

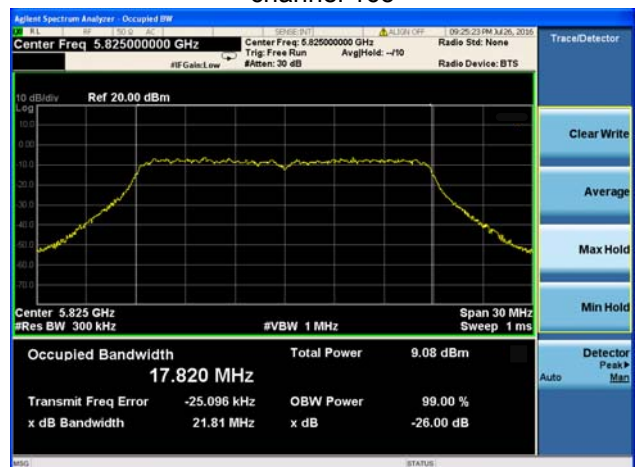

(802.11n40) -26dB&99% Bandwidth plot on channel 151



(802.11n40) -26dB&99% Bandwidth plot on channel 159

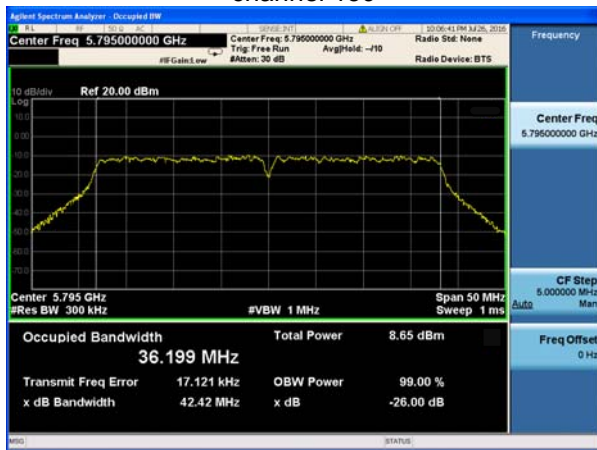

### 13. MINIMUM 6 DB BANDWIDTH

#### 13.1 APPLIED PROCEDURES / LIMIT

##### According to FCC §15.407(e)

(e) Within the 5.725-5.85 GHz band, the minimum 6 dB bandwidth of U-NII devices shall be at least 500 kHz.

#### 13.2 TEST PROCEDURE

Section 15.407(e) specifies the minimum 6 dB emission bandwidth of at least 500 KHz for the band 5.715-5.85 GHz. The following procedure shall be used for measuring this bandwidth:

- a) Set RBW = 100 kHz.
- b) Set the video bandwidth (VBW)  $\geq 3 \times$  RBW.
- c) Detector = Peak.
- d) Trace mode = max hold.
- e) Sweep = auto couple.
- f) Allow the trace to stabilize.
- g) Measure the maximum width of the emission that is constrained by the frequencies associated with the two outermost amplitude points (upper and lower frequencies) that are attenuated by 6 dB relative to the maximum level measured in the fundamental emission.

#### 13.3 DEVIATION FROM STANDARD

No deviation.

#### 13.4 TEST SETUP

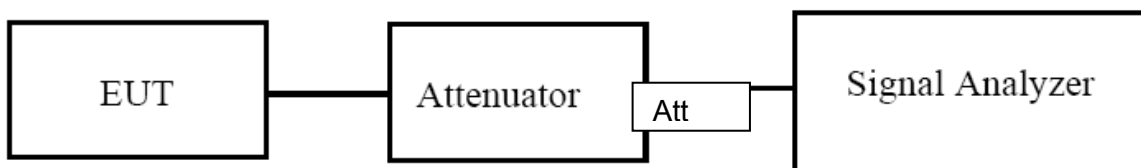

#### 13.5 EUT OPERATION CONDITIONS

The EUT tested system was configured as the statements of 2.4 Unless otherwise a special operating condition is specified in the follows during the testing.

13.6 TEST RESULTS

Temperature :	25 °C	Relative Humidity :	60%
Pressure :	1012 hPa	Test Voltage :	DC 3.7V
Test Mode :	TX (5G) Mode Frequency Band III (5725-5825MHz)		

Mode	Channel	Frequency (MHz)	6dB Bandwidth	Limit (KHz)	Result
802.11a	149	5745	16.57	500	Pass
	157	5785	16.57	500	Pass
	165	5825	16.57	500	Pass
802.11 n20	149	5745	17.78	500	Pass
	157	5785	17.76	500	Pass
	165	5825	17.80	500	Pass
802.11 n40	151	5755	36.47	500	Pass
	159	5795	36.48	500	Pass

(802.11a) -6dB Bandwidth plot on channel 149

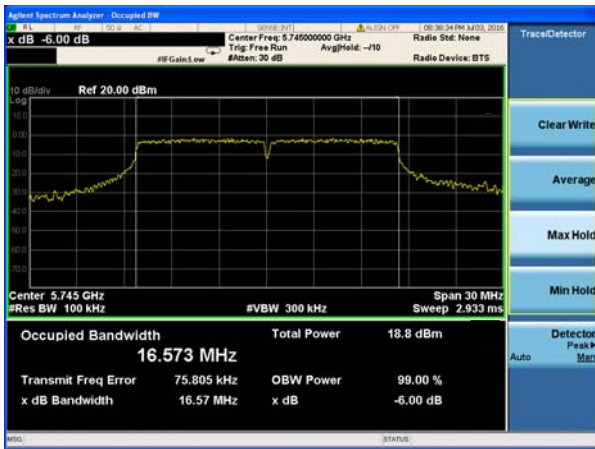

(802.11n20) -6dB Bandwidth plot on channel 149

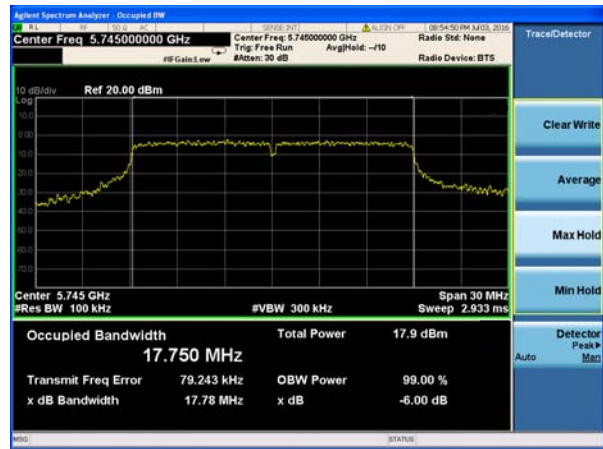

(802.11a) -6dB Bandwidth plot on channel 157

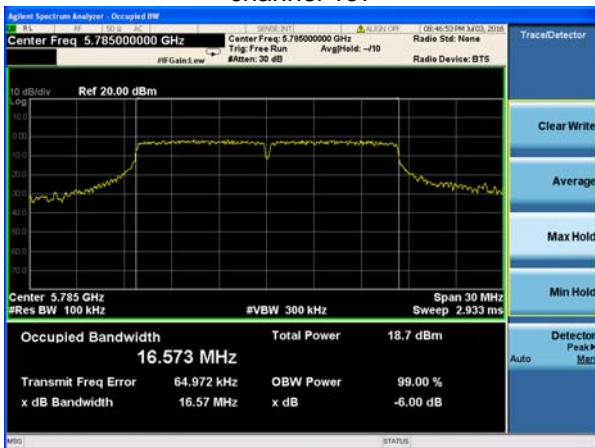

(802.11n20) -6dB Bandwidth plot on channel 157



(802.11a) -6dB Bandwidth plot on channel 165



(802.11n20) -6dB Bandwidth plot on channel 165

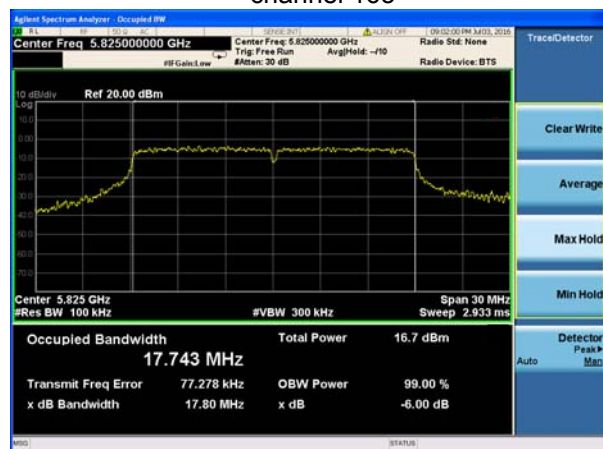

(802.11n40) -6dB Bandwidth plot on channel 151

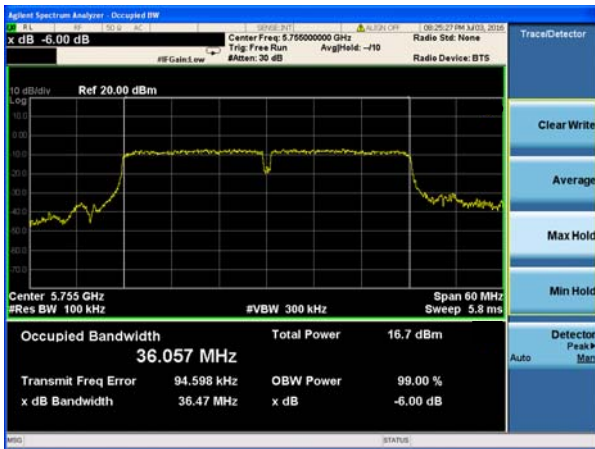

(802.11n40) -6dB Bandwidth plot on channel 159

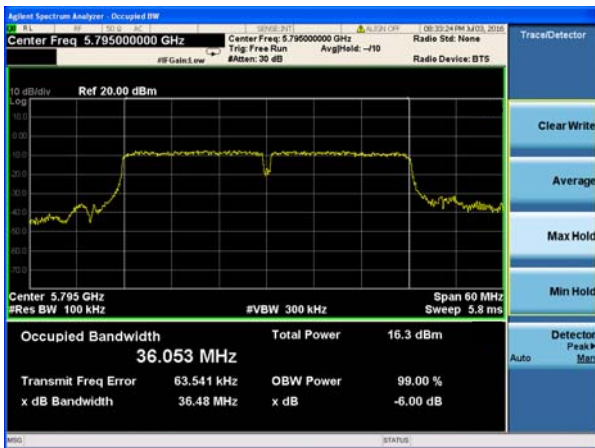

## 14. MAXIMUM CONDUCTED OUTPUT POWER

### 14.1 PPLIED PROCEDURES / LIMIT

#### According to FCC §15.407

The maximum conducted output power should not exceed:

Frequency Band		Limit
5.725-5.85 GHz		
X	client devices	maximum conducted output power over the frequency band of operation shall not exceed 1 W. In addition, the maximum power spectral density shall not exceed 30 dBm in any 500-kHz band. If transmitting antennas of directional gain greater than 6 dBi are used, both the maximum conducted output power and the maximum power spectral density shall be reduced by the amount in dB that the directional gain of the antenna exceeds 6 dBi. However, fixed point-to-point U-NII devices operating in this band may employ transmitting antennas with directional gain greater than 6 dBi without any corresponding reduction in transmitter conducted power. Fixed, point-to-point operations exclude the use of point-to-multipoint systems, omnidirectional applications, and multiple collocated transmitters transmitting the same information. The operator of the U-NII device, or if the equipment is professionally installed, the installer, is responsible for ensuring that systems employing high gain directional antennas are used exclusively for fixed, point-to-point operations.

### 14.2 TEST PROCEDURE

1. The transmitter output (antenna port) was connected to the power meter.
2. Test was performed in accordance with KDB789033 D02 v01r02 for Compliance Testing of Unlicensed National Information Infrastructure (U-NII) Devices - section (E) Maximum conducted output power =>3. Measurement using a Power Meter (PM) =>b) Method PM-G (Measurement using a gated RF average power meter).
3. Multiple antenna systems was performed in accordance with KDB662911 D01 v02r01 Emissions Testing of Transmitters with Multiple Outputs in the Same Band.
4. When measuring maximum conducted output power with multiple antenna systems, add every result of the values by mathematic formula.

### 14.3 DEVIATION FROM STANDARD

No deviation.

### 14.4 TEST SETUP

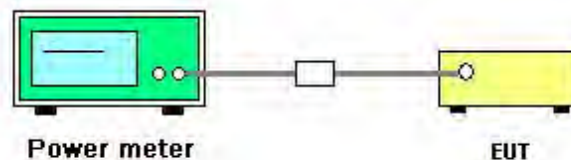

### 14.5 EUT OPERATION DURING TEST

The EUT was programmed to be in continuously transmitting mode.

**14.6 TEST RESULTS**

Temperature :	25 °C	Relative Humidity :	60%
Pressure :	1012 hPa	Test Voltage :	DC 3.7V
Test Mode :	TX (5G) Mode Frequency Band III (5725-5825MHz)		

Test Channel	Frequency (MHz)	Maximum	LIMIT
		(dBm)	dBm
<b>TX 802.11a Mode</b>			
CH 149	5745	17.15	30
CH 157	5785	17.29	30
CH 165	5825	17.38	30
<b>TX 802.11 n20M Mode</b>			
CH 149	5745	17.31	30
CH 157	5785	17.37	30
CH 165	5825	17.22	30
<b>TX 802.11 n40M Mode</b>			
CH 151	5755	17.28	30
CH 159	5795	17.16	30

## 15. OUT OF BAND EMISSIONS

### 15.1 APPLICABLE STANDARD

#### According to FCC §15.407(b)

Undesirable emission limits. Except as shown in paragraph (b)(7) of this section, the maximum emissions outside of the frequency bands of operation shall be attenuated in accordance with the following limits:

(1) For transmitters operating in the 5.15-5.25 GHz band: All emissions outside of the 5.15-5.35 GHz band shall not exceed an e.i.r.p. of  $-27$  dBm/MHz.

(2) For transmitters operating in the 5.725-5.85 GHz band: All emissions shall be limited to a level of  $-27$  dBm/MHz at 75 MHz or more above or below the band edge increasing linearly to 10 dBm/MHz at 25 MHz above or below the band edge, and from 25 MHz above or below the band edge increasing linearly to a level of 15.6 dBm/MHz at 5 MHz above or below the band edge, and from 5 MHz above or below the band edge increasing linearly to a level of 27 dBm/MHz at the band edge.

### 15.2 TEST PROCEDURE

1. Check the calibration of the measuring instrument using either an internal calibrator or a known signal from an external generator.
2. Position the EUT without connection to measurement instrument. Turn on the EUT and connect its antenna terminal to measurement instrument via a low loss cable. Then set it to any one measured frequency within its operating range, and make sure the instrument is operated in its linear range.
3. Set RBW of spectrum analyzer to 1 MHz with a convenient frequency span.
4. Measure the highest amplitude appearing on spectral display and set it as a reference level. Plot the graph with marking the highest point and edge frequency.
5. Repeat above procedures until all measured frequencies were complete.
6. Catch the final spectrum test results by software.

### 15.3 DEVIATION FROM STANDARD

No deviation.

### 15.4 TEST SETUP

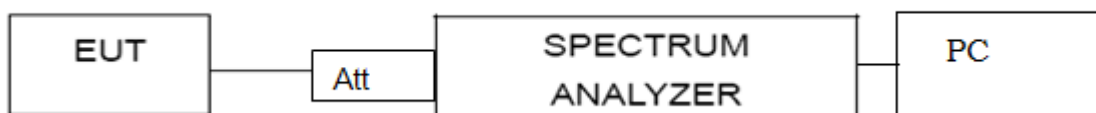

### 15.5 EUT OPERATION CONDITIONS

The EUT tested system was configured as the statements of 2.4 Unless otherwise a special operating condition is specified in the follows during the testing.

### 15.6 TEST RESULTS

#### 5.725-5.85 GHz

(802.11a) Band Edge, Left Side

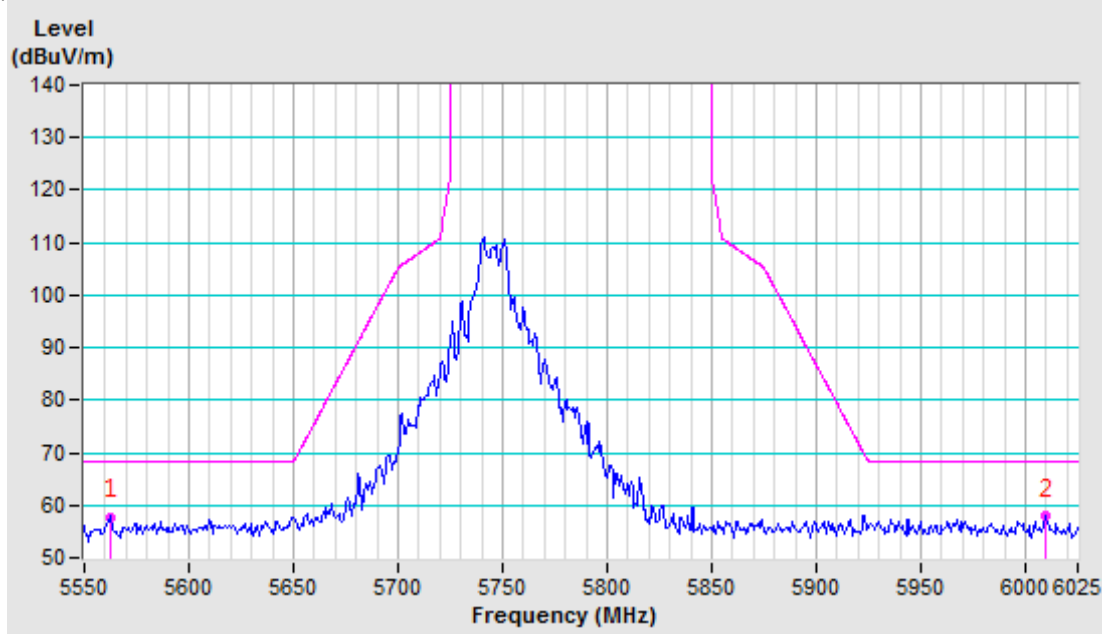

(802.11a) Band Edge, Right Side

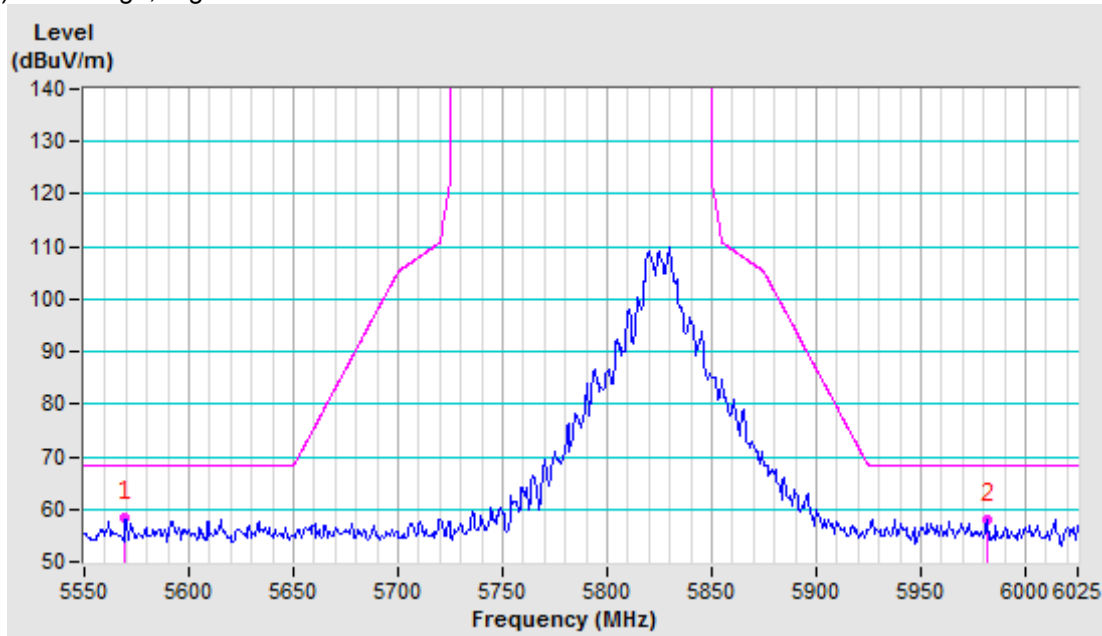

(802.11n20) Band Edge, Left Side:

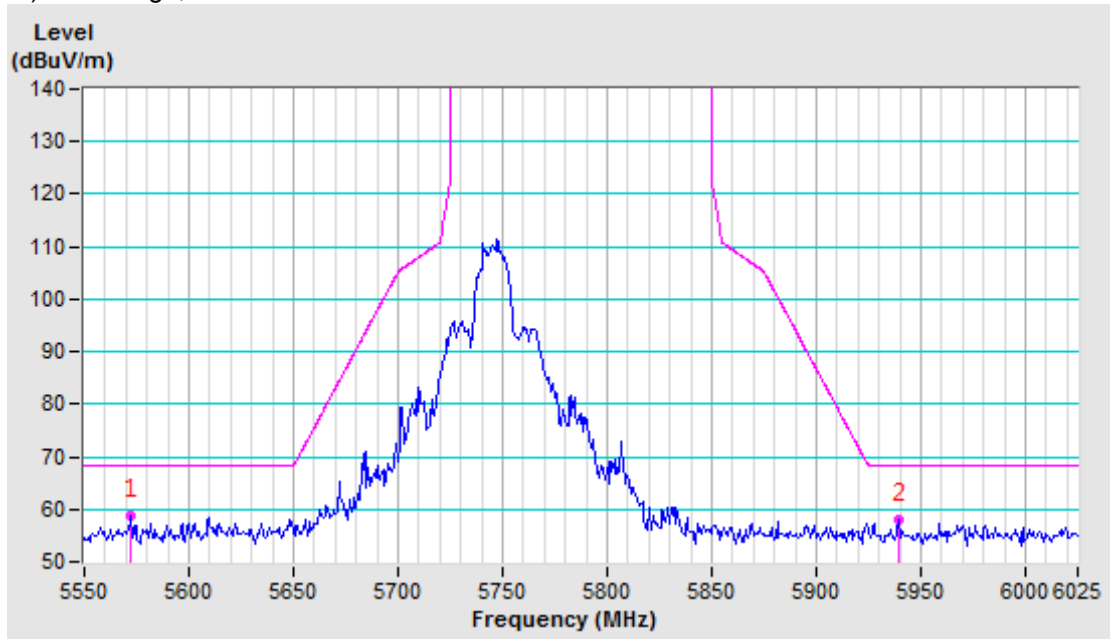

(802.11n20) Band Edge, Right Side

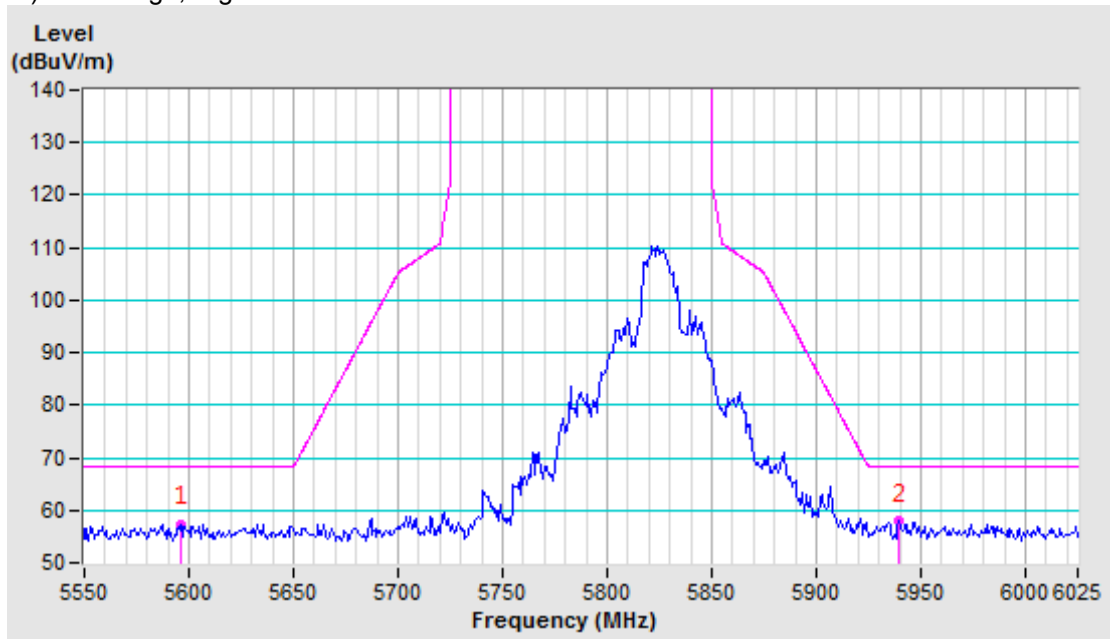

(802.11n40) Band Edge, Left Side

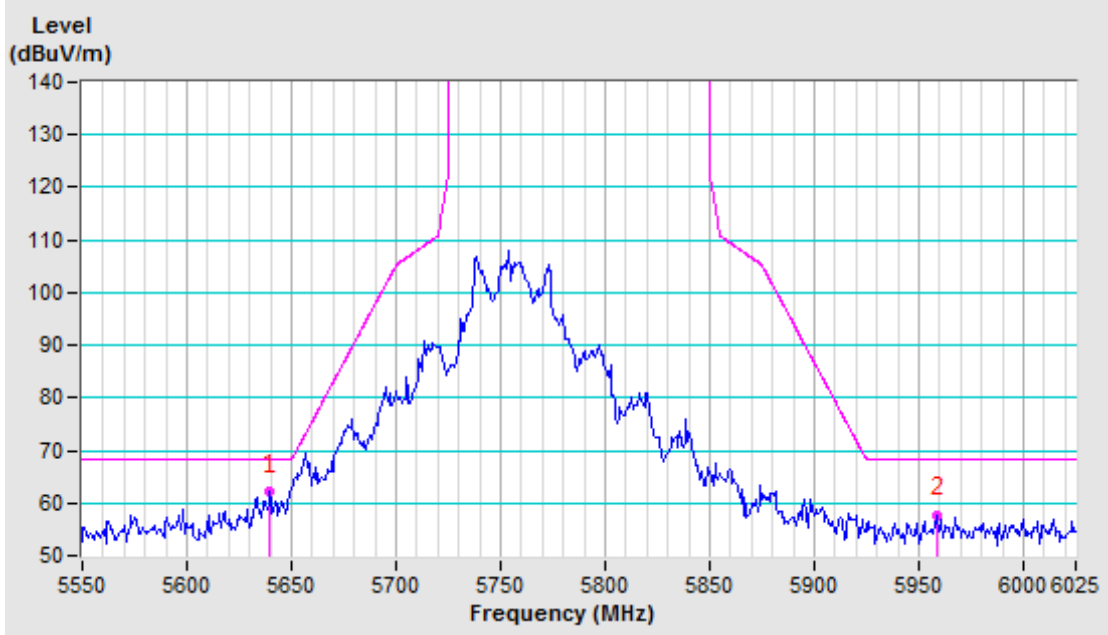

(802.11n40) Band Edge, Right Side

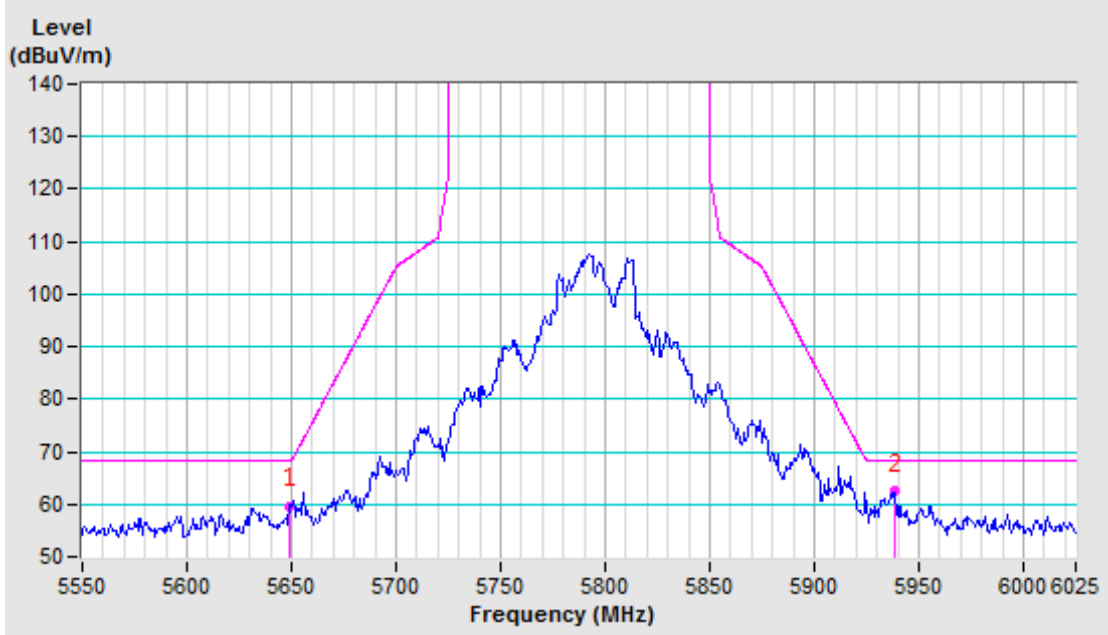

## 16. Frequency Stability Measurement

### 16.1 LIMIT

Manufacturers of U-NII devices are responsible for ensuring frequency stability such that an emission is maintained within the band of operation under all conditions of normal operation as specified in the user's manual.

The transmitter center frequency tolerance shall be  $\pm 20$  ppm maximum for the 5 GHz band (IEEE 802.11n specification).

### 16.2 TEST PROCEDURES

1. The transmitter output (antenna port) was connected to the spectrum analyzer.
2. EUT have transmitted absence of modulation signal and fixed channelize.
3. Set the spectrum analyzer span to view the entire absence of modulation emissions bandwidth.
4. Set RBW = 10 kHz, VBW = 10 kHz with peak detector and maxhold settings.
5.  $f_c$  is declaring of channel frequency. Then the frequency error formula is  $(f_c - f) / f_c \times 10^6$  ppm and the limit is less than  $\pm 20$  ppm (IEEE 802.11n specification).
6. The test extreme voltage is to change the primary supply voltage from 85 to 115 percent of the nominal value
7. Extreme temperature is  $-20^\circ\text{C} \sim 70^\circ\text{C}$ .

### 16.3 TEST SETUP LAYOUT

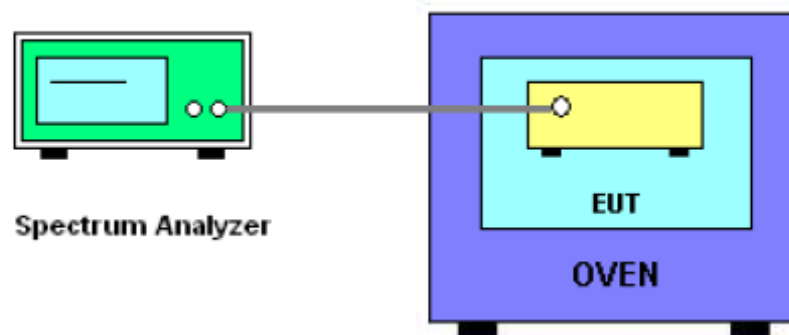

### 16.4 EUT OPERATION DURING TEST

The EUT was programmed to be in continuously un-modulation transmitting mode.

**16.5 TEST RESULTS**

Temperature :	25 °C	Relative Humidity :	56%
Pressure :	1015 hPa	Test Voltage :	DC 3.7V
Test Mode :	TX (5G) Mode Frequency Band III (5725-5825MHz)		

Voltage vs. Frequency Stability:

TEST CONDITIONS				Reference Frequency : 5745MHz			
				F	Fc	Max. Deviation (MHz)	Max. Deviation (ppm)
T nom (°C)	20°C	V nom (V)	3.7V	5745.0123	5745	0.0123	2.141
		V max (V)	4.2V	5745.0146	5745	0.0146	2.541
		V min (V)	3.3V	5745.0133	5745	0.0133	2.315
Limits				+- 20 ppm			
Result				Complies			

Temperature vs. Frequency Stability:

TEST CONDITIONS				Reference Frequency : 5745MHz			
				F	Fc	Max. Deviation (MHz)	Max. Deviation (ppm)
V nom (V)	3.7V	T (°C)	-20	5745.0113	5745	0.0113	1.967
		T (°C)	-10	5745.0116	5745	0.0116	2.019
		T (°C)	0	5745.0113	5745	0.0113	1.967
		T (°C)	10	5745.0132	5745	0.0132	2.298
		T (°C)	20	5745.0123	5745	0.0123	2.141
		T (°C)	30	5745.0142	5745	0.0142	2.472
		T (°C)	40	5745.0153	5745	0.0153	2.663
Limits				+- 20 ppm			
Result				Complies			

Voltage vs. Frequency Stability:

TEST CONDITIONS				Reference Frequency : 5785MHz			
				F	Fc	Max. Deviation (MHz)	Max. Deviation (ppm)
T nom (°C)	20°C	V nom (V)	3.7V	5785.0149	5785	0.0149	2.576
		V max (V)	4.2V	5785.0189	5785	0.0189	3.267
		V min (V)	3.3V	5785.0169	5785	0.0169	2.921
Limits				+- 20 ppm			
Result				Complies			

Temperature vs. Frequency Stability:

TEST CONDITIONS				Reference Frequency : 5785MHz			
				F	Fc	Max. Deviation (MHz)	Max. Deviation (ppm)
V nom (V)	3.7V	T (°C)	-20	5785.0153	5785	0.0153	2.645
		T (°C)	-10	5785.0121	5785	0.0121	2.092
		T (°C)	0	5785.0111	5785	0.0111	1.919
		T (°C)	10	5785.0131	5785	0.0131	2.264
		T (°C)	20	5785.0149	5785	0.0149	2.576
		T (°C)	30	5785.0122	5785	0.0122	2.109
		T (°C)	40	5785.0121	5785	0.0121	2.092
Limits				+- 20 ppm			
Result				Complies			

Voltage vs. Frequency Stability:

TEST CONDITIONS				Reference Frequency : 5825MHz			
				F	Fc	Max. Deviation (MHz)	Max. Deviation (ppm)
T nom (°C)	20°C	V nom (V)	3.7V	5825.0133	5825	0.0133	2.283
		V max (V)	4.2V	5825.0132	5825	0.0132	2.266
		V min (V)	3.3V	5825.0123	5825	0.0123	2.112
Limits				+- 20 ppm			
Result				Complies			

Temperature vs. Frequency Stability:

TEST CONDITIONS				Reference Frequency : 5825MHz			
				F	Fc	Max. Deviation (MHz)	Max. Deviation (ppm)
V nom (V)	3.7V	T (°C)	-20	5825.0143	5825	0.0143	2.455
		T (°C)	-10	5825.0112	5825	0.0112	1.923
		T (°C)	0	5825.0123	5825	0.0123	2.112
		T (°C)	10	5825.0131	5825	0.0131	2.249
		T (°C)	20	5825.0133	5825	0.0133	2.283
		T (°C)	30	5825.0141	5825	0.0141	2.421
		T (°C)	40	5825.0121	5825	0.0121	2.077
Limits				+- 20 ppm			

## **17. ANTENNA REQUIREMENT**

### **17.1 STANDARD REQUIREMENT**

15.203 requirement: For intentional device, according to 15.203: an intentional radiator shall be designed to ensure that no antenna other than that furnished by the responsible party shall be used with the device.

### **17.2 EUT ANTENNA**

The EUT antenna is Integrated antenna, It comply with the standard requirement.

## 18. EUT TEST PHOTO

### Radiated Measurement Photos

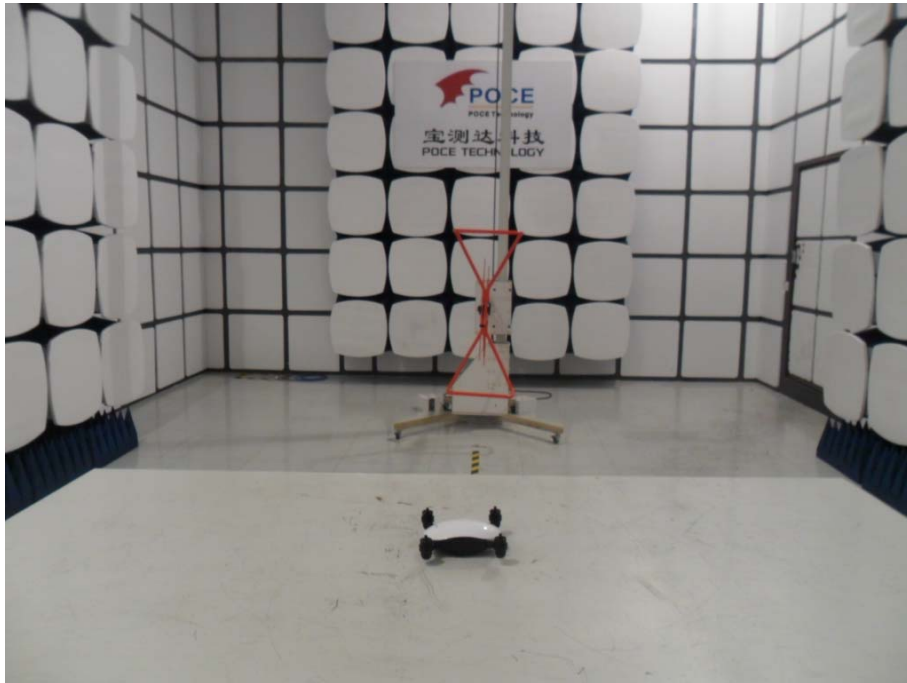

### Radiated Measurement Photos

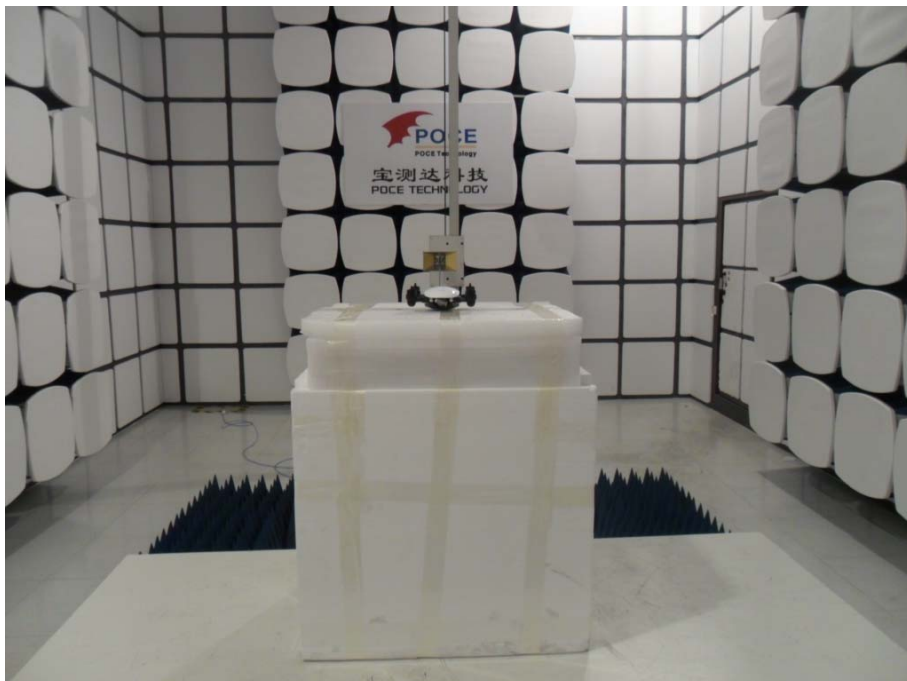

\*\*\*\*\* END OF REPORT \*\*\*\*\*