

TEST REPORT

Product Name : Wireless Video Doorbell PRO
Model Number : TVDP05GR, TVDP05GR-EF, TVDP05GR-ML
FCC ID : 2AK7ELVD05
IC : 22430-LVD05

Prepared for : VuPoint Solutions Inc.
Address : 710 Nogales St., City of Industry, CA 91748

Prepared by : EMTEK (SHENZHEN) CO., LTD.
Address : Building 69, Majialong Industry Zone, Nanshan District,
Shenzhen, Guangdong, China

Tel: (0755) 26954280
Fax: (0755) 26954282

Report Number : ENS2205310037W00101R
Date(s) of Tests : May 31, 2022 to July 29, 2022
Date of issue : July 30, 2022

Table of Contents

1	TEST RESULT CERTIFICATION	3
2	EUT TECHNICAL DESCRIPTION	5
3	SUMMARY OF TEST RESULT	6
4	TEST METHODOLOGY	7
4.1	GENERAL DESCRIPTION OF APPLIED STANDARDS	7
4.2	MEASUREMENT EQUIPMENT USED	7
4.3	DESCRIPTION OF TEST MODES	8
5	FACILITIES AND ACCREDITATIONS	9
5.1	FACILITIES	9
5.2	EQUIPMENT	9
5.3	LABORATORY ACCREDITATIONS AND LISTINGS	9
6	TEST SYSTEM UNCERTAINTY	10
7	SETUP OF EQUIPMENT UNDER TEST	11
7.1	RADIO FREQUENCY TEST SETUP 1	11
7.2	RADIO FREQUENCY TEST SETUP 2	11
7.3	CONDUCTED EMISSION TEST SETUP	14
7.4	BLOCK DIAGRAM CONFIGURATION OF TEST SYSTEM	15
7.5	SUPPORT EQUIPMENT	15
8	TEST REQUIREMENTS	16
8.1	ON TIME AND DUTY CYCLE	16
8.2	DTS 6DB BANDWIDTH	18
8.3	DTS 99% BANDWIDTH	20
8.4	MAXIMUM PEAK CONDUCTED OUTPUT POWER	22
8.5	MAXIMUM POWER SPECTRAL DENSITY	25
8.6	UNWANTED EMISSIONS IN NON-RESTRICTED FREQUENCY BANDS	27
8.7	RADIATED SPURIOUS EMISSION	33
8.8	CONDUCTED EMISSIONS TEST	46
8.9	ANTENNA APPLICATION	49

1 TEST RESULT CERTIFICATION

Applicant : VuPoint Solutions Inc.
 Address : 710 Nogales St., City of Industry, CA 91748
 Manufacturer : VuPoint Solutions Inc.
 Address : 710 Nogales St., City of Industry, CA 91748
 EUT : Wireless Video Doorbell PRO
 Model Name : TVDP05GR, TVDP05GR-EF, TVDP05GR-ML
 Trademark : TOUCAN

Measurement Procedure Used:

APPLICABLE STANDARDS	
STANDARD	TEST RESULT
FCC 47 CFR Part 2 , Subpart J FCC 47 CFR Part 15, Subpart C	PASS
IC RSS-GEN, Issue 5(04-2018)+A1(03-2019)+A2(02-2021) IC RSS-247 Issue 2(02-2017)	PASS

The above equipment was tested by EMTEK(SHENZHEN) CO., LTD. The test data, data evaluation, test procedures, and equipment configurations shown in this report were made in accordance with the procedures given in ANSI C63.10 (2013) and the energy emitted by the sample EUT tested as described in this report is in compliance with the requirements of FCC Rules Part 2, Part 15.247, IC RSS-247 Issue 2 and IC RSS-GEN, Issue 5.

The test results of this report relate only to the tested sample identified in this report.

Date of Test : May 31, 2022 to July 29, 2022

Prepared by : 
 Una Yu /Editor

Reviewer : 
 Joe Xia/Supervisor

Approve & Authorized Signer : 
 Lisa Wang/Manager



Modified History

Version	Report No.	Revision Date	Summary
V1.0	ENS2205310037W00101R	/	Original Report



2 EUT TECHNICAL DESCRIPTION

Product:	Wireless Video Doorbell PRO
Model Number:	TVDP05GR, TVDP05GR-EF, TVDP05GR-ML
Sample number:	2#
Device Type:	Bluetooth V5.0
Data Rate :	1Mbps
Modulation:	GFSK
Operating Frequency Range:	2402-2480MHz
Number of Channels:	40 Channels
Transmit Power Max:	6.79 dBm
Antenna Type:	Internal Antenna
Antenna Gain:	2.5 dBi
Power Supply:	AC13-30V,50/60HZ,0.5A DC 12V/1A from Adapter DC 5V/2A from USB Port
Date of Received:	May 31, 2022
Temperature Range:	0°C ~ +45°C

Note: for more details, please refer to the User's manual of the EUT.

3 SUMMARY OF TEST RESULT

FCC Part Clause	IC Part Clause	Test Parameter	Verdict	Remark
15.247(a)(2)	RSS-247 5.2(a) RSS-Gen 6.7	Emission Bandwidth	PASS	
15.247(b)(3)	RSS-247 5.4(d) RSS-Gen 6.12	Maximum Peak Conducted Output Power	PASS	
15.247(e)	RSS-247 5.2(b) RSS-Gen 6.12	Maximum Power Spectral Density Level	PASS	
15.247(d)	RSS-247 5.5	Unwanted Emission Into Non-Restricted Frequency Bands	PASS	
15.247(d)	RSS-247 5.5	Unwanted Emission Into Restricted Frequency Bands (conducted)	PASS	
15.247(d) 15.209 15.205	RSS-Gen 8.9 RSS-Gen 8.10 RSS-Gen 6.13 RSS-247 3.3 RSS-247 5.5	Radiated Spurious Emission	PASS	
15.207	RSS-Gen 8.8	Conducted Emission Test	PASS	
15.203 15.247(b)	RSS-Gen 6.8 RSS-247 5.4	Antenna Application	PASS	
NOTE1: N/A (Not Applicable)				
NOTE2: According to FCC OET KDB 558074, the report use radiated measurements in the restricted frequency bands. In addition, the radiated test is also performed to ensure the emissions emanating from the device cabinet also comply with the applicable limits.				

RELATED SUBMITTAL(S)/GRANT(S):

This submittal(s) (test report) is intended for **FCC ID: 2AK7ELVD05** filing to comply with Section 15.247 of the FCC Part 15, Subpart C Rules.

This submittal(s) (test report) is intended for **IC: 22430-LVD05** filing to comply with RSS-247 Rules.

4 TEST METHODOLOGY

4.1 GENERAL DESCRIPTION OF APPLIED STANDARDS

According to its specifications, the EUT must comply with the requirements of the following standards:

FCC 47 CFR Part 2, Subpart J

FCC 47 CFR Part 15, Subpart C

IC RSS-GEN, Issue 5(04-2018)+A1(03-2019)+A2(02-2021)

IC RSS-247 Issue 2(02-2017)

FCC KDB 558074 D01 15.247 Meas Guidance v05r02

4.2 MEASUREMENT EQUIPMENT USED

Conducted Emission Test Equipment

Equipment	Manufacturer	Model No.	Serial No.	Last Cal.	Cal. Interval
Test Receiver	Rohde & Schwarz	ESCI	101384	May 14, 2022	1 Year
L.I.S.N.	Rohde & Schwarz	ENV216	5	May 14, 2022	1 Year
L.I.S.N.	Kyoritsu	KNW-407	8-1492-9	May 15, 2022	1 Year

For Spurious Emissions Test

Equipment	Manufacturer	Model No.	Serial No.	Last Cal.	Cal. Interval
EMI Test Receiver	Rohde & Schwarz	ESU 26	100154	May 14, 2022	1 Year
Pre-Amplifier	Lunar EM	LNA30M3G-25	J10100000070	May 14, 2022	1 Year
Bilog Antenna	Schwarzbeck	VULB9163	661	Jun. 12, 2021	2 Year
Horn antenna	Schwarzbeck	BBHA9120D	9120D-1177	Jun. 12, 2021	2 Year
Pre-Amplifier	SKET	LNPA_0118G-45	SK2019051801	May 14, 2022	1 Year
Loop Antenna	Schwarzbeck	FMZB1519	1519-012	Jun. 12, 2021	2 Year
Spectrum Analyzer	Rohde & Schwarz	FSV40	100967	May 14, 2022	1 Year
Horn antenna	Schwarzbeck	BBHA9120D	9120D-1178	Aug. 22, 2021	2 Year
Band reject Filter(50dB)	WI/DE	WRCGV-2400(2400-2485MHz)	2	May 14, 2022	1 Year

For other test items:

Equipment	Manufacturer	Model No.	Serial No.	Last Cal.	Cal. Interval
Wireless Connectivity Tester	R&S	CMW270	102543	Aug. 27, 2021	1Year
Automatic Control Unit	Tonscend	JS0806-2	2118060480	Nov. 18, 2021	1Year
Signal Analyzer	KEYSIGHT	N9010B	MY60242456	Jan. 21, 2022	1Year
Analog Signal Generator	KEYSIGHT	N5173B	MY61252625	Oct. 29, 2021	1Year
UP/DOWN-Converter	R&S	CMW-Z800A	100274	Sep. 14, 2021	1Year
Vector Signal Generator	KEYSIGHT	N5182B	MY61252674	Oct. 28, 2021	1Year
Frequency Extender	KEYSIGHT	N5182BX07	MY59362541	Nov. 23, 2021	1Year
Temperature&Humidity test chamber	ESPEC	EL-02KA	12107166	May 14, 2022	1 Year

4.3 DESCRIPTION OF TEST MODES

The EUT has been tested under its typical operating condition.

The EUT configuration for testing is installed on RF field strength measurement to meet the Commissions requirement and operating in a manner which intends to maximize its emission characteristics in a continuous normal application.

The Transmitter was operated in the normal operating mode. The TX frequency was fixed which was for the purpose of the measurements.

Test of channel included the lowest and middle and highest frequency to perform the test, then record on this report.

Those data rates (Bluetooth DTS :1Mbps, 2Mbps) were used for all test.

Pre-defined engineering program for regulatory testing used to control the EUT for staying in continuous transmitting and receiving mode is programmed.

Frequency and Channel list for Bluetooth DTS:

Channel	Frequency (MHz)	Channel	Frequency (MHz)	Channel	Frequency (MHz)
0	2402	19	2440
1	2404	20	2442	37	2476
2	2406	21	2444	38	2478
...	39	2480

Note: $f_c=2402\text{MHz}+k \times 1\text{MHz}$ $k=1$ to 39

Test Frequency and channel for Bluetooth DTS:

Lowest Frequency		Middle Frequency		Highest Frequency	
Channel	Frequency (MHz)	Channel	Frequency (MHz)	Channel	Frequency (MHz)
0	2402	19	2440	39	2480

5 FACILITIES AND ACCREDITATIONS

5.1 FACILITIES

All measurement facilities used to collect the measurement data are located at:

EMTEK (Shenzhen) Co., Ltd.

Building 69, Majialong Industry Zone District, Nanshan District, Shenzhen, China

The sites are constructed in conformance with the requirements of ANSI C63.7, ANSI C63.4 and CISPR Publication 22.

5.2 EQUIPMENT

Radiated emissions are measured with one or more of the following types of linearly polarized antennas: tuned dipole, biconical, log periodic, bi-log, and/or ridged waveguide, horn. Spectrum analyzers with preselectors and quasi-peak detectors are used to perform radiated measurements.

Conducted emissions are measured with Line Impedance Stabilization Networks and EMI Test Receivers.

Calibrated wideband preamplifiers, coaxial cables, and coaxial attenuators are also used for making measurements.

All receiving equipment conforms to CISPR Publication 16-1, "Radio Interference Measuring Apparatus and Measurement Methods."

5.3 LABORATORY ACCREDITATIONS AND LISTINGS

Site Description	
EMC Lab.	<p>Accredited by CNAS The Certificate Registration Number is L2291. The Laboratory has been assessed and proved to be in compliance with CNAS-CL01 (identical to ISO/IEC 17025:2017)</p> <p>Accredited by FCC Designation Number: CN1204 Test Firm Registration Number: 882943</p> <p>Accredited by A2LA The Certificate Number is 4321.01.</p> <p>Accredited by Industry Canada The Conformity Assessment Body Identifier is CN0008</p>
Name of Firm	: EMTEK (SHENZHEN) CO., LTD.
Site Location	: Building 69, Majialong Industry Zone, Nanshan District, Shenzhen, Guangdong, China

6 TEST SYSTEM UNCERTAINTY

The following measurement uncertainty levels have been estimated for tests performed on the apparatus:

Test Parameter	Measurement Uncertainty
Radio Frequency	$\pm 1 \times 10^{-5}$
Maximum Peak Output Power Test	$\pm 1.0\text{dB}$
Conducted Emissions Test	$\pm 2.0\text{dB}$
Radiated Emission Test	$\pm 2.0\text{dB}$
Power Density	$\pm 2.0\text{dB}$
Occupied Bandwidth Test	$\pm 1.0\text{dB}$
Band Edge Test	$\pm 3\text{dB}$
All emission, radiated	$\pm 3\text{dB}$
Antenna Port Emission	$\pm 3\text{dB}$
Temperature	$\pm 0.5^\circ\text{C}$
Humidity	$\pm 3\%$

Measurement Uncertainty for a level of Confidence of 95%

7 SETUP OF EQUIPMENT UNDER TEST

7.1 RADIO FREQUENCY TEST SETUP 1

The Bluetooth component's antenna ports(s) of the EUT are connected to the measurement instrument per an appropriate attenuator. The EUT is controlled by PC/software to emit the specified signals for the purpose of measurements.

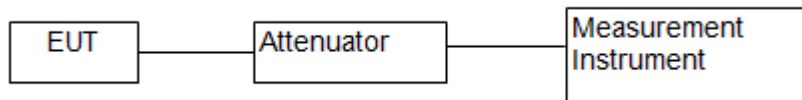

7.2 RADIO FREQUENCY TEST SETUP 2

The test site semi-anechoic chamber has met the requirement of NSA tolerance 4 dB according to the standards: ANSI C63.10. The test distance is 3m. The setup is according to the requirements in Section 13.1.4.1 of ANSI C63.10-2013 and CAN/CSA-CEI/IEC CISPR 22.

The maximal emission value is acquired by adjusting the antenna height, polarisation and turntable azimuth. Normally, the height range of antenna is 1 m to 4 m, the azimuth range of turntable is 0° to 360°, and the receive antenna has two polarizations Vertical (V) and Horizontal (H).

Below 30MHz:

The EUT is placed on a turntable 0.8 meters above the ground in the chamber, 3 meter away from the antenna (loop antenna). The Antenna should be positioned with its plane vertical at the specified distance from the EUT and rotated about its vertical axis for maximum response at each azimuth about the EUT. The center of the loop shall be 1 m above the ground. For certain applications, the loop antenna plane may also need to be positioned horizontally at the specified distance from the EUT.

Above 30MHz:

The EUT is placed on a turntable 0.8 meters above the ground in the chamber, 3 meter away from the antenna. The maximal emission value is acquired by adjusting the antenna height, polarisation and turntable azimuth. Normally, the height range of antenna is 1 m to 4 m, the azimuth range of turntable is 0° to 360°, and the receive antenna has two polarizations Vertical (V) and Horizontal (H).

Above 1GHz:

The EUT is placed on a turntable 1.5 meters above the ground in the chamber, 3 meter away from the antenna. The maximal emission value is acquired by adjusting the antenna height, polarisation and turntable azimuth. Normally, the height range of antenna is 1 m to 4 m, the azimuth range of turntable is 0° to 360°, and the receive antenna has two polarizations Vertical (V) and Horizontal (H).

Measurements shall be taken, using the following steps, at a test site that has been validated using the procedures of ANSI C63.4 or the latest CISPR 16-1-4 for measurements above 1 GHz, so as to simulate a near free-space environment (see RSS-Gen for applicable versions of ANSI and CISPR standards).

(1) Line the ground plane with absorbers between the transmitter and the receive antenna to minimize reflections. The absorbers used should have a minimum-rated attenuation of 20 dB through the measurement frequency range of interest. The absorbers shall be positioned to replicate the layout used when compliance with the applicable acceptability criterion was achieved, as set forth in the aforementioned standards on site validation.

(2) Set the height of the receive antenna to 1.5 m. The receive antenna must be one that was designed and fabricated to operate over the entire frequency range of interest, for example, an appropriate standard gain horn.

(3) The distance between the receive antenna and the radiating source shall be sufficient in order to ensure far-field conditions.

(4) Mount the transmitter at a height of 1.5 m.

(5) Configure the device under test (DUT) to produce the maximum power spectral density as measured while assessing compliance with Section 6.2.2 (i.e. channel frequency, modulation type and data rate). If the DUT is equipped with a detachable antenna and the antenna is intended for remote installation (i.e.

tower-mounted), the DUT may be substituted with a suitable signal generator. The level and frequency settings on the generator shall be set so as to reproduce the maximum power spectral density, measured within a 1 MHz bandwidth, obtained while assessing compliance to Section 6.2.2.

(6) Position the transmitter or the radiating antenna so that elevation pattern measurements can be taken.

(7) Find the 0° reference point in the horizontal plane.

(8) Care should be taken when positioning the receive antenna to avoid cross-polarization. Antennas of known mounting polarization should be assessed with the receive antenna oriented in the same polarity. If the polarization of the transmit antenna is unknown or the transmit antenna can be mounted in either polarization, e.i.r.p. measurements should be performed to find which mounting polarity provides the highest e.i.r.p. value. Testing shall be carried out with the receive antenna and the DUT mounted in each polarity.

(9) The emission shall be centred on the display of the spectrum analyzer with the following settings:

i. If the power spectral density of the DUT was assessed with a peak detector and the antenna cannot be detached from the DUT, the spectrum analyzer shall be set to a peak detector with a resolution bandwidth and video bandwidth of 1 MHz.

ii. If the power spectral density of the DUT was assessed using a sample detector with power averaging and the antenna cannot be detached from the DUT, the spectrum analyzer shall be set to a sample detector, configured to produce 100 power averages and set with a resolution bandwidth, as well as a video bandwidth of 1 MHz.

iii. If the antenna can be detached from the DUT, a continuous wave (CW) signal equal to that of the power spectral density measurement may be used, the spectrum analyzer shall be set to peak detector with a resolution bandwidth and video bandwidth of 1 MHz.

(10) Rotate the turntable 360° recording the field strength at each step. Throughout the main beam of the antenna, the step size shall be kept to a maximum of 1°.

Once outside the main beam of the antenna, the maximum step size shall be as follows, when compared to the requirements of Section 6.2.2:

i. Between 0° and 8°, maximum step size of 2°;

ii. Between 8° and 40°, maximum step size of 4°;

iii. Between 40° and 45°, maximum step size of 1°;

iv. Between 45° and 90°, maximum step size of 5°.

Once the mask reaches 90°, the mask will be inverted and the step size will follow in the same manner as above.

For the purpose of this procedure, the main beam of the antenna is defined as the 3 dB beamwidth.

(11) Convert the measured field strength values in terms of e.i.r.p. density (dBW/1 MHz) using the following equation:

$$\text{e.i.r.p. density (dBW/MHz)} = 10 \log((E \cdot r)^2 / 30)$$

E = field strength in V/m

r = measurement distance in metres

(12) Plot the results against the emission mask with reference to the horizontal plane.

(13) Using the plot, the 0° can be rotated to determine the worst-case installation tilt angle.

(14) Testing shall be performed using the highest gain antenna for every antenna type, if applicable.

(15) Antenna type(s), antenna model number(s), and worst-case tilt angle(s) necessary to remain compliant with the elevation mask requirement set forth in Section 6.2.2(3) of RSS-247 shall be clearly indicated in the user manual.

The following figure is an example of a polar elevation mask measured using the Method 1 reference to dB μ V/m at 3 m.

(a) Radiated Emission Test Set-Up, Frequency Below 30MHz

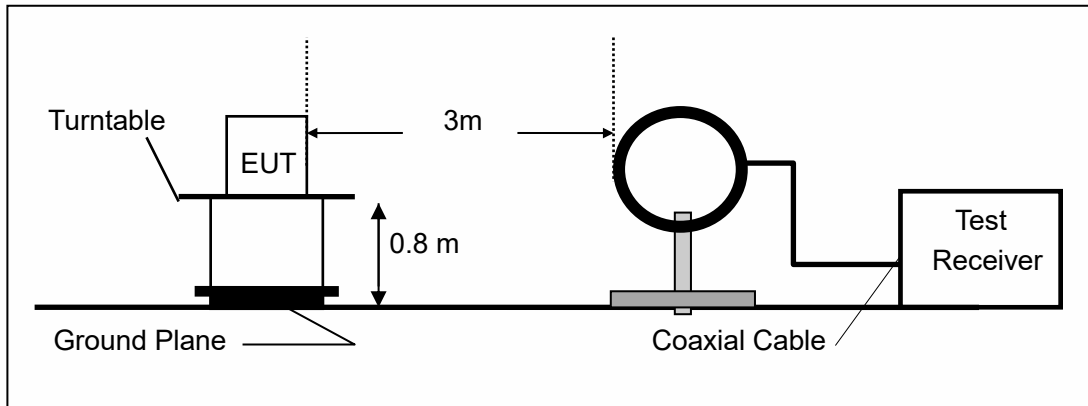

(b) Radiated Emission Test Set-Up, Frequency Below 1000MHz

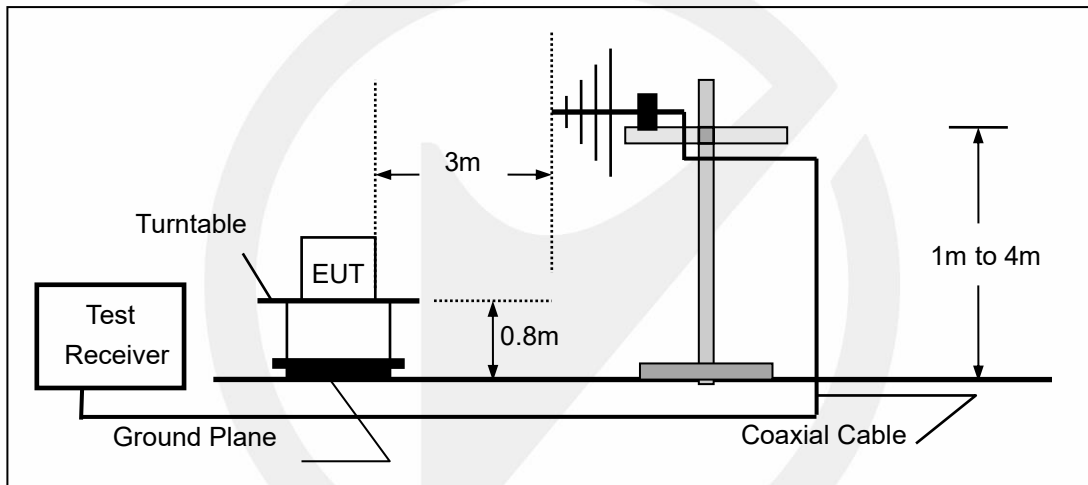

(c) Radiated Emission Test Set-Up, Frequency above 1000MHz

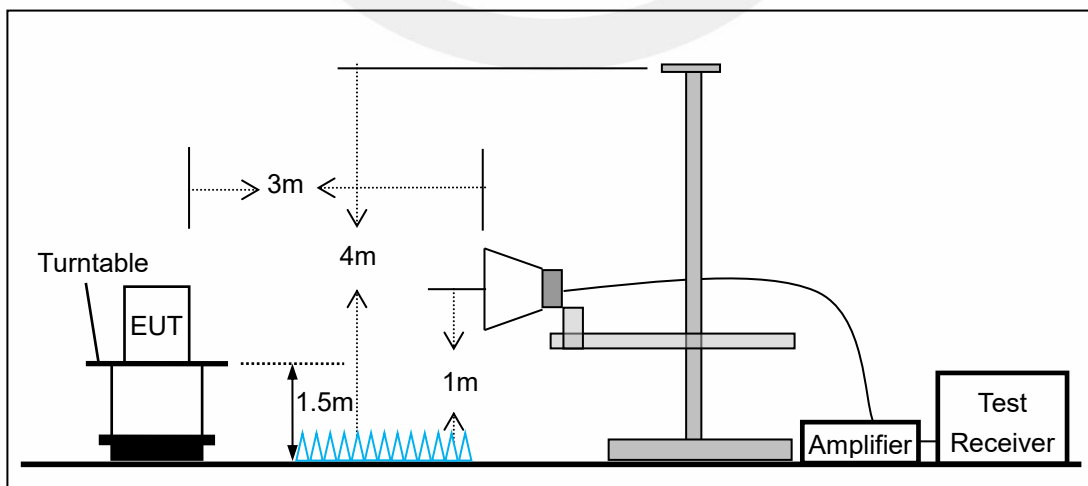

7.3 CONDUCTED EMISSION TEST SETUP

The mains cable of the EUT (maybe per AC/DC Adapter) must be connected to LISN. The LISN shall be placed 0.8 m from the boundary of EUT and bonded to a ground reference plane for LISN mounted on top of the ground reference plane. This distance is between the closest points of the LISN and the EUT. All other units of the EUT and associated equipment shall be at least 0.8m from the LISN.

Ground connections, where required for safety purposes, shall be connected to the reference ground point of the LISN and, where not otherwise provided or specified by the manufacturer, shall be of same length as the mains cable and run parallel to the mains connection at a separation distance of not more than 0.8 m.

According to the requirements in Section 13.1.4.1 of ANSI C63.10-2013 Conducted emissions from the EUT measured in the frequency range between 0.15 MHz and 30 MHz using CISPR Quasi-Peak and average detector mode.

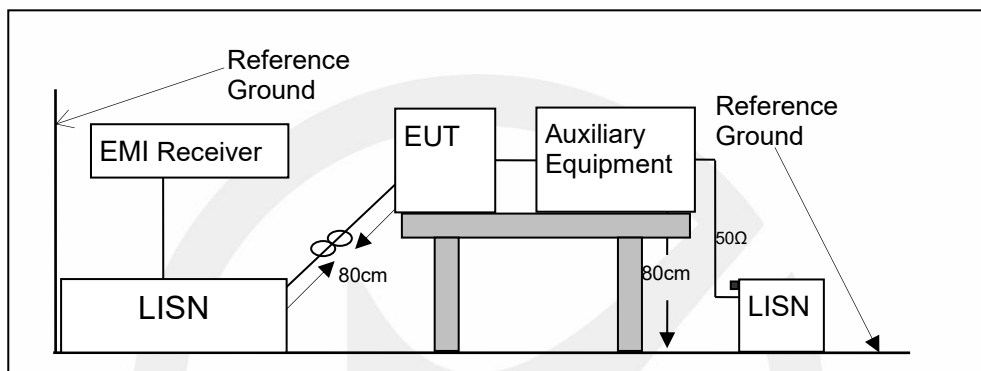

7.4 BLOCK DIAGRAM CONFIGURATION OF TEST SYSTEM

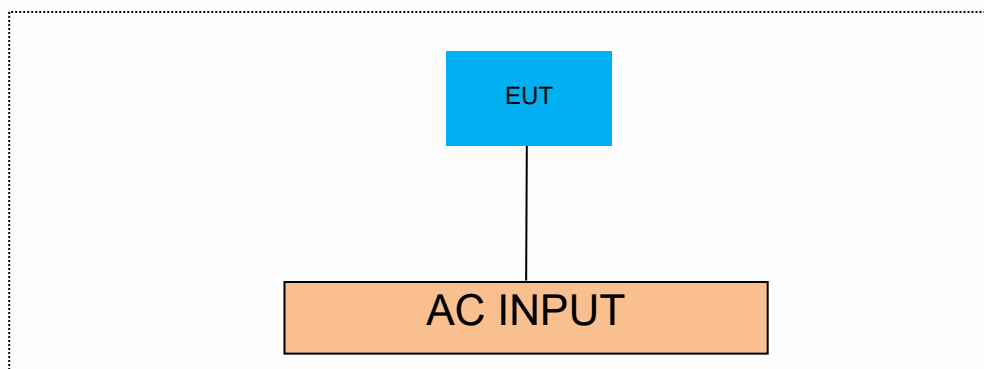

7.5 SUPPORT EQUIPMENT

EUT Cable List and Details			
Cable Description	Length (m)	Shielded/Unshielded	With / Without Ferrite
/	/	/	/

Auxiliary Cable List and Details			
Cable Description	Length (m)	Shielded/Unshielded	With / Without Ferrite
/	/	/	/

Auxiliary Equipment List and Details			
Description	Manufacturer	Model	Serial Number
Adapter	MI	A232-050200U-CN2 Input: 100-240V~, 50/60Hz, 0.35A Output: DC 5V, 2A	AH201123002190

Notes:

1. All the equipment/cables were placed in the worst-case configuration to maximize the emission during the test.
2. Grounding was established in accordance with the manufacturer's requirements and conditions for the intended use.

8 TEST REQUIREMENTS

8.1 ON TIME AND DUTY CYCLE

8.1.1 Applicable Standard

According to 558074 D01 Section 6

8.1.2 Conformance Limit

N/A; for reporting purposes only.

8.1.3 Test Configuration

Test according to clause 7.1 radio frequency test setup.

8.1.4 Test Procedure

The zero-span mode on a spectrum analyzer or EMI receiver, if the response time and spacing between bins on the sweep are sufficient to permit accurate measurements of the on and off times of the transmitted signal. Set the center frequency of the instrument to the center frequency of the transmission. Set RBW \geq EBW if possible; otherwise, set RBW to the largest available value. Set VBW \geq RBW. Set detector = peak or average. The zero-span measurement method shall not be used unless both RBW and VBW are $> 50/T$, where T is the minimum transmission duration over which the transmitter is on and is transmitting at its maximum power control level for the tested mode of operation), and the number of sweep points across duration T exceeds 100. (For example, if VBW and/or RBW are limited to 3 MHz, then the zero-span method of measuring duty cycle shall not be used if $T \leq 16.7$ microseconds.)

8.1.5 Test Results

Temperature:	25°C
Relative Humidity:	45%
ATM Pressure:	1011 mbar

Note: N/A

TestMode	Antenna	Frequency[MHz]	ON Time [ms]	Period [ms]	Duty Cycle [%]	Duty Cycle Factor[dB]
BLE_1M	Ant1	2402	0.39	0.62	62.90	2.01
		2440	0.39	0.63	61.90	2.08
		2480	0.39	0.63	61.90	2.08

BLE 1M_Ant1_2402

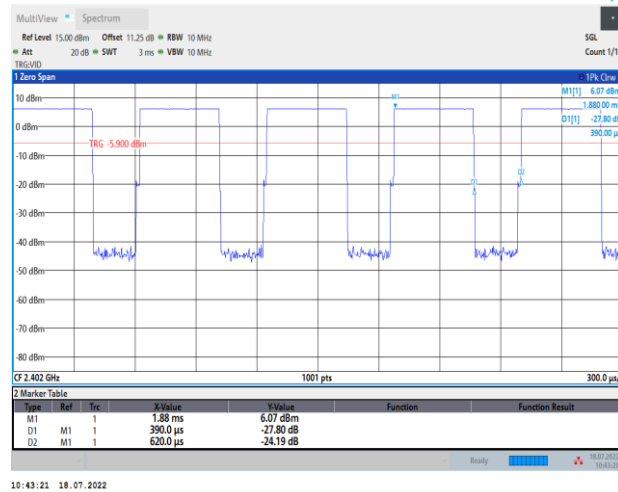

BLE 1M_Ant1_2440

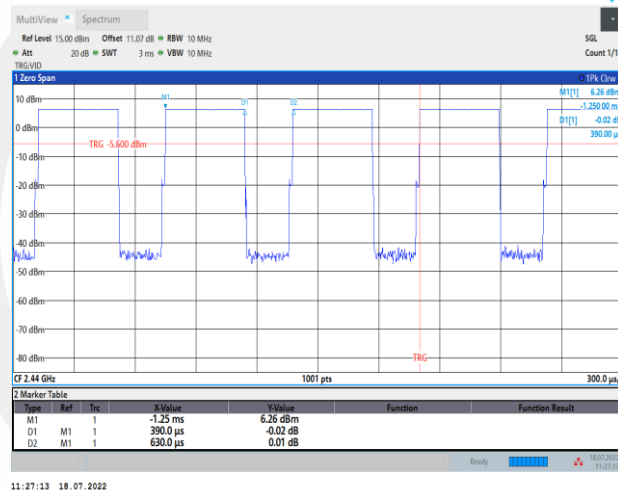

BLE 1M_Ant1_2480

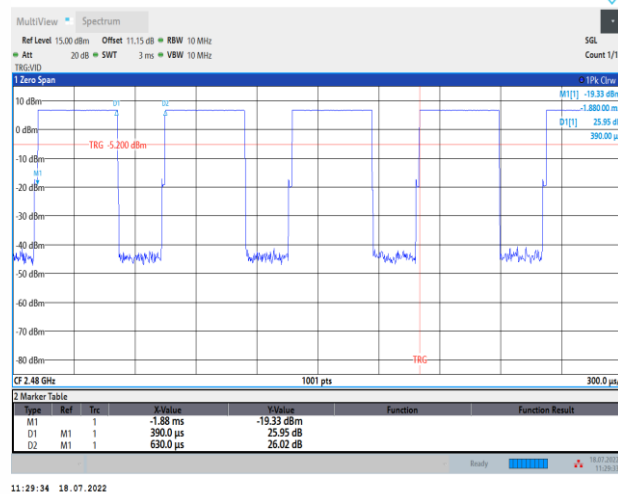

8.2 DTS 6DB BANDWIDTH

8.2.1 Applicable Standard

According to FCC Part15.247 (a)(2)

According to RSS-247 5.2(a)

According to 558074 D01 15.247 Meas Guidance v05r02 Section 8.2

According to ANSI C63.10 Section 11.8

8.2.2 Conformance Limit

The minimum -6 dB bandwidth shall be at least 500 kHz.

8.2.3 Test Configuration

Test according to clause 7.1 radio frequency test setup 1

8.2.4 Test Procedure

The EUT was operating in Bluetooth mode and controlled its channel. Printed out the test result from the spectrum by hard copy function.

The RF output of EUT was connected to the spectrum analyzer by RF cable and attenuator. The path loss was compensated to the results for each measurement.

Set to the maximum power setting and enable the EUT transmit continuously

Set RBW = 100 kHz.

Set the video bandwidth (VBW) =300 kHz.

Set Span=2 times OBW

Set Detector = Peak.

Set Trace mode = max hold.

Set Sweep = auto couple.

Allow the trace to stabilize.

Measure the maximum width of the emission that is constrained by the frequencies associated with the two outermost amplitude points (upper and lower frequencies) that are attenuated by 6 dB relative to the maximum level measured in the fundamental emission.

Measure and record the results in the test report.

Test Results

Temperature:	25°C
Relative Humidity:	45%
ATM Pressure:	1011 mbar

Note: N/A

TestMode	Antenna	Frequency[MHz]	DTS BW [MHz]	FL[MHz]	FH[MHz]	Limit[MHz]	Verdict
BLE_1M	Ant1	2402	0.71	2401.64	2402.35	0.5	PASS
		2440	0.70	2439.64	2440.34	0.5	PASS
		2480	0.71	2479.64	2480.35	0.5	PASS

BLE 1M_Ant1_2402

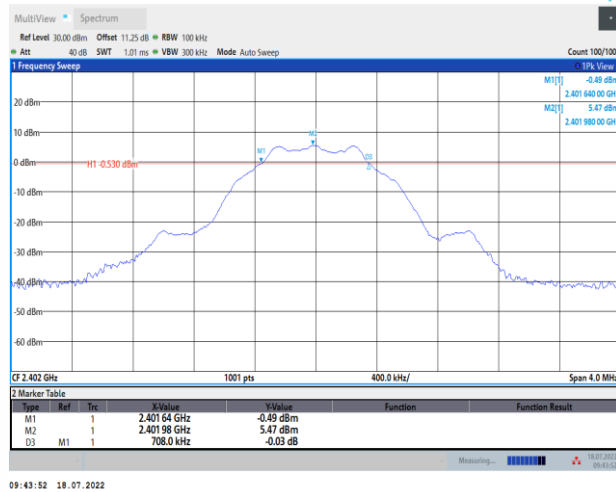

BLE 1M_Ant1_2440

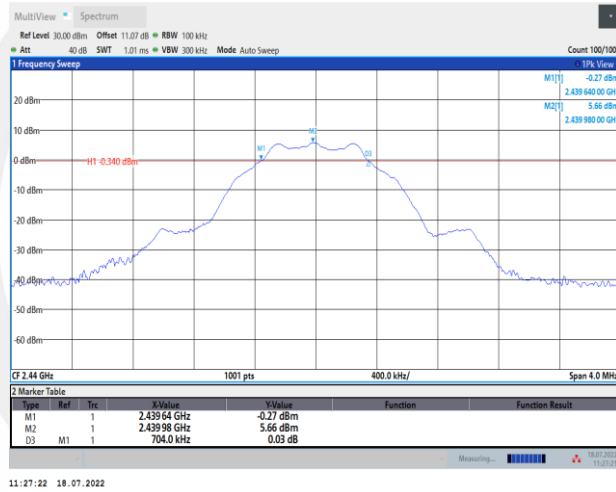

BLE 1M_Ant1_2480



8.3 DTS 99% BANDWIDTH

8.3.1 Applicable Standard

According to RSS-Gen 6.7

8.3.2 Test Configuration

Test according to clause 7.1 radio frequency test setup 1

8.3.3 Test Procedure

The EUT was operating in Bluetooth mode and controlled its channel. Printed out the test result from the spectrum by hard copy function.

The RF output of EUT was connected to the spectrum analyzer by RF cable and attenuator. The path loss was compensated to the results for each measurement.

Set to the maximum power setting and enable the EUT transmit continuously

Set RBW = 1%-5% OBW(43KHz).

Set the video bandwidth (VBW) =130 kHz.

Set Span=4MHz

Set Detector = Peak.

Set Trace mode = max hold.

Set Sweep = auto couple.

Allow the trace to stabilize.

Use the 99 % power bandwidth function of the instrument

Measure the maximum width of the emission.

Measure and record the results in the test report.

8.3.4 Test Results

Temperature:	25°C
Relative Humidity:	45%
ATM Pressure:	1011 mbar

Note: N/A

TestMode	Antenna	Frequency[MHz]	OCB [MHz]	FL[MHz]	FH[MHz]	Limit[MHz]	Verdict
BLE_1M	Ant1	2402	1.064	2401.472	2402.537	---	---
		2440	1.064	2439.471	2440.535	---	---
		2480	1.064	2479.469	2480.533	---	---

BLE 1M_Ant1_2402



09:43:58 18.07.2022

BLE 1M_Ant1_2440



11:27:28 18.07.2022

BLE 1M_Ant1_2480

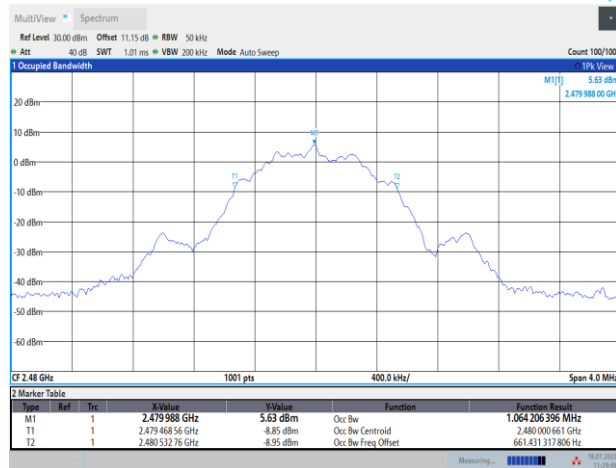

11:29:49 18.07.2022

8.4 MAXIMUM PEAK CONDUCTED OUTPUT POWER

8.4.1 Applicable Standard

According to FCC Part15.247 (b)(3)

According to RSS-247 5.4(d)

According to RSS-Gen 6.12

According to 558074 D01 15.247 Meas Guidance v05r02 Section 8.3.2.2

According to ANSI C63.10 Section 11.9.2.2.4

8.4.2 Conformance Limit

The maximum peak conducted output power of the intentional radiator for systems using digital modulation in the 2400 - 2483.5 MHz bands shall not exceed: 1 Watt (30dBm).

8.4.3 Test Configuration

Test according to clause 7.1 radio frequency test setup 1

8.4.4 Test Procedure

- a) Measure the duty cycle D of the transmitter output signal.
- b) Set span to at least 1.5 times the OBW.
- c) Set RBW = 1% to 5% of the OBW, not to exceed 1 MHz.
- d) Set VBW $\geq [3 \times \text{RBW}]$.
- e) Number of points in sweep $\geq [2 \times \text{span} / \text{RBW}]$. (This gives bin-to-bin spacing $\leq \text{RBW} / 2$, so that narrowband signals are not lost between frequency bins.)
- f) Sweep time = auto.
- g) Detector = RMS (i.e., power averaging), if available. Otherwise, use the sample detector mode.
- h) Do not use sweep triggering. Allow the sweep to “free run.”
- i) Trace average at least 100 traces in power averaging (rms) mode; however, the number of traces to be averaged shall be increased above 100 as needed such that the average accurately represents the true average over the ON and OFF periods of the transmitter.
- j) Compute power by integrating the spectrum across the OBW of the signal using the instrument’s band power measurement function with band limits set equal to the OBW band edges. If the instrument does not have a band power function, then sum the spectrum levels (in power units) at intervals equal to the RBW extending across the entire OBW of the spectrum.
- k) Add $[10 \log (1 / D)]$, where D is the duty cycle, to the measured power to compute the average power during the actual transmission times (because the measurement represents an average over both the ON and OFF times of the transmission). For example, add $[10 \log (1/0.25)] = 6 \text{ dB}$ if the duty cycle is 25%.

■ According to FCC Part 15.247(b)(4):

Conducted output power limit specified in paragraph (b) of this section is based on the use of antennas with directional gains that do not exceed 6 dBi. If transmitting antennas of directional gain greater than 6 dBi are used, the conducted output power from the intentional radiator shall be reduced below the stated values in paragraphs (b)(3) of this section, as appropriate, by the amount in dB that the directional gain of the antenna exceeds 6 dBi.

Note: If antenna Gain exceeds 6 dBi, then Output power Limit=30-(Gain- 6)

8.4.5 Test Results

Temperature:	25 °C
Relative Humidity:	45%
ATM Pressure:	1011 mbar

Note: N/A

TestMode	Antenna	Frequency[MHz]	Conducted Peak Power[dBm]	Conducted Limit[dBm]	EIRP[dBm]	EIRP Limit[dBm]	Verdict
BLE_1M	Ant1	2402	6.26	≤30	8.76	≤36	PASS
		2440	6.38	≤30	8.88	≤36	PASS
		2480	6.79	≤30	9.29	≤36	PASS



BLE 1M_Ant1_2402

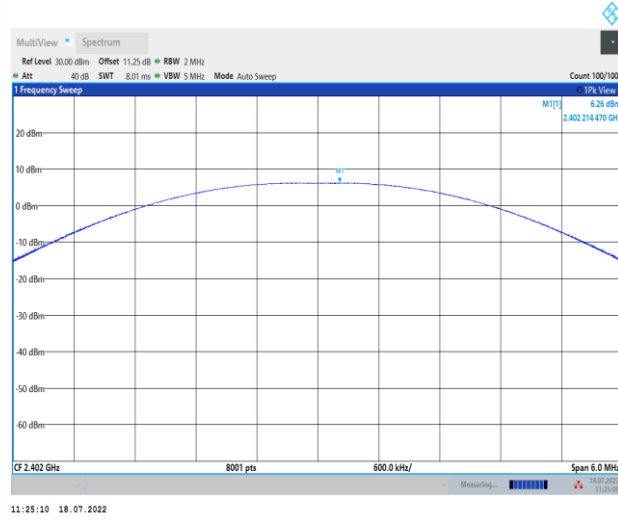

BLE 1M_Ant1_2440

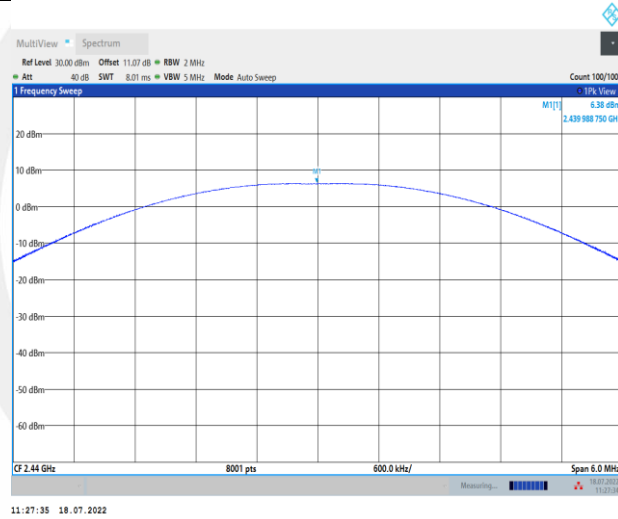

BLE 1M_Ant1_2480

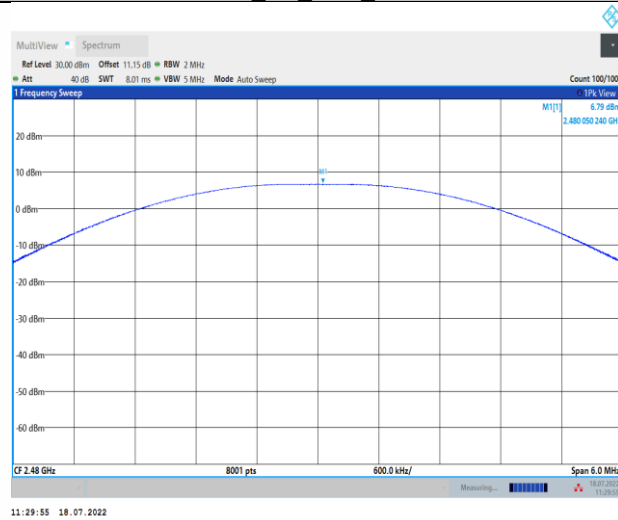

8.5 MAXIMUM POWER SPECTRAL DENSITY

8.5.1 Applicable Standard

According to FCC Part15.247(e)

According to RSS-247 5.2(b)

According to RSS-Gen 6.12

According to 558074 D01 15.247 Meas Guidance v05r02 Section 8.4

According to ANSI C63.10 Section 11.10.5

8.5.2 Conformance Limit

The transmitter power spectral density conducted from the transmitter to the antenna shall not be greater than 8 dBm in any 3 kHz band during any time interval of continuous transmission.

8.5.3 Test Configuration

Test according to clause 7.1 radio frequency test setup 1

8.5.4 Test Procedure

- a) Measure the duty cycle (D) of the transmitter output signal
- b) Set instrument center frequency to DTS channel center frequency.
- c) Set span to at least 1.5 times the OBW.
- d) Set RBW to: $3 \text{ kHz} \leq \text{RBW} \leq 100 \text{ kHz}$.
- e) Set VBW $\geq [3 \times \text{RBW}]$.
- f) Detector = power averaging (rms) or sample detector (when rms not available).
- g) Ensure that the number of measurement points in the sweep $\geq [2 \times \text{span} / \text{RBW}]$.
- h) Sweep time = auto couple.
- i) Do not use sweep triggering; allow sweep to "free run."
- j) Employ trace averaging (rms) mode over a minimum of 100 traces.
- k) Use the peak marker function to determine the maximum amplitude level.
- l) Add $[10 \log (1 / D)]$, where D is the duty cycle measured in step a), to the measured PSD to compute the average PSD during the actual transmission time.
- m) If measured value exceeds requirement specified by regulatory agency, then reduce RBW (but no less than 3 kHz) and repeat (note that this may require zooming in on the emission of interest and reducing the span to meet the minimum measurement point requirement as the RBW is reduced).

8.5.5 Test Results

Temperature:	25 °C
Relative Humidity:	45%
ATM Pressure:	1011 mbar

Note: N/A

TestMode	Antenna	Frequency[MHz]	Result[dBm/3kHz]	Limit[dBm/3kHz]	Verdict
BLE_1M	Ant1	2402	-8.06	≤ 8.00	PASS
		2440	-7.99	≤ 8.00	PASS
		2480	-7.5	≤ 8.00	PASS

BLE_1M_Ant1_2402

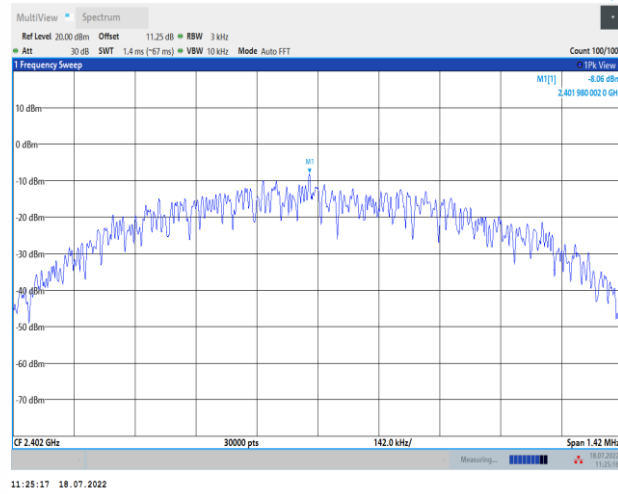

BLE_1M_Ant1_2440

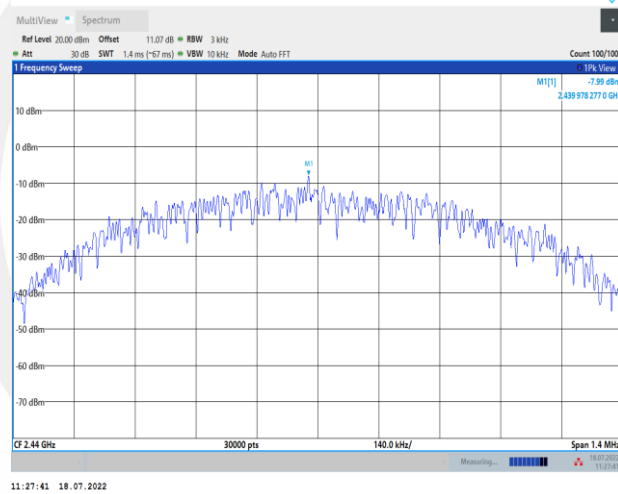

BLE_1M_Ant1_2480

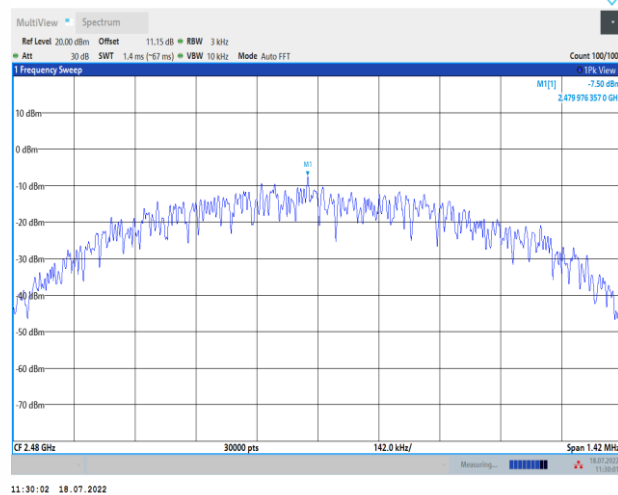

8.6 UNWANTED EMISSIONS IN NON-RESTRICTED FREQUENCY BANDS

8.6.1 Applicable Standard

According to FCC Part15.247(d)

According to RSS-247 5.5

According to 558074 D01 15.247 Meas Guidance v05r02 Section 8.5

According to ANSI C63.10 Section 11.11

8.6.2 Conformance Limit

In any 100 kHz bandwidth outside the frequency band in which the spread spectrum or digitally modulated intentional radiator is operating, the radio frequency power that is produced by the intentional radiator shall be at least 20 dB below that in the 100 kHz bandwidth within the band that contains the highest level of the desired power, based on either an RF conducted or a radiated measurement, provided the transmitter demonstrates compliance with the peak conducted power limits. If the transmitter complies with the conducted power limits based on the use of RMS averaging over a time interval, as permitted under paragraph (b)(3) of this section, the attenuation required under this paragraph shall be 30 dB instead of 20 dB.

8.6.3 Test Configuration

Test according to clause 7.1 radio frequency test setup 1

8.6.4 Test Procedure

The transmitter output (antenna port) was connected to the spectrum analyzer

■ Reference level measurement

Establish a reference level by using the following procedure:

Set instrument center frequency to DTS channel center frequency.

Set the span to = 1.5 times the DTS bandwidth.

Set the RBW = 100 kHz.

Set the VBW $\geq 3 \times$ RBW.

Set Detector = peak.

Set Sweep time = auto couple.

Set Trace mode = max hold.

Allow trace to fully stabilize.

Use the peak marker function to determine the maximum PSD level.

Note that the channel found to contain the maximum PSD level can be used to establish the reference level.

■ Band-edge measurement

Use the following spectrum analyzer settings:

Span = wide enough to capture the peak level of the emission operating on the channel closest to the band-edge, as well as any modulation products which fall outside of the authorized band of operation

Set RBW $\geq 1\%$ of the span=100kHz Set VBW $\geq 3 \times$ RBW

Set Sweep = auto Set Detector function = peak Set Trace = max hold

Allow the trace to stabilize. Set the marker on the emission at the bandedge, or on the highest modulation product outside of the band, if this level is greater than that at the bandedge. Enable the marker-delta function, then use the marker-to-peak function to move the marker to the peak of the in-band emission. The marker-delta value now displayed must comply with the limit specified in this Section.

■ Emission level measurement

Set the center frequency and span to encompass frequency range to be measured.

Set the RBW = 100 kHz.

Set the VBW =300 kHz.

Set Detector = peak

Sweep time = auto couple.

Trace mode = max hold.

Allow trace to fully stabilize.

Use the peak marker function to determine the maximum amplitude level.

Ensure that the amplitude of all unwanted emissions outside of the authorized frequency band (excluding restricted frequency bands) are attenuated by at least the minimum requirements . Report the three highest emissions relative to the limit.

8.6.5 Test Results

Temperature:	25 °C
Relative Humidity:	45%
ATM Pressure:	1011 mbar

Note: N/A

TestMode	Antenna	ChName	Frequency [MHz]	RefLevel[dBm]	Result[dBm]	Limit[dBm]	Verdict
BLE_1M	Ant1	Low	2402	5.39	-49.14	≤-14.61	PASS
		High	2480	5.92	-48.42	≤-14.08	PASS

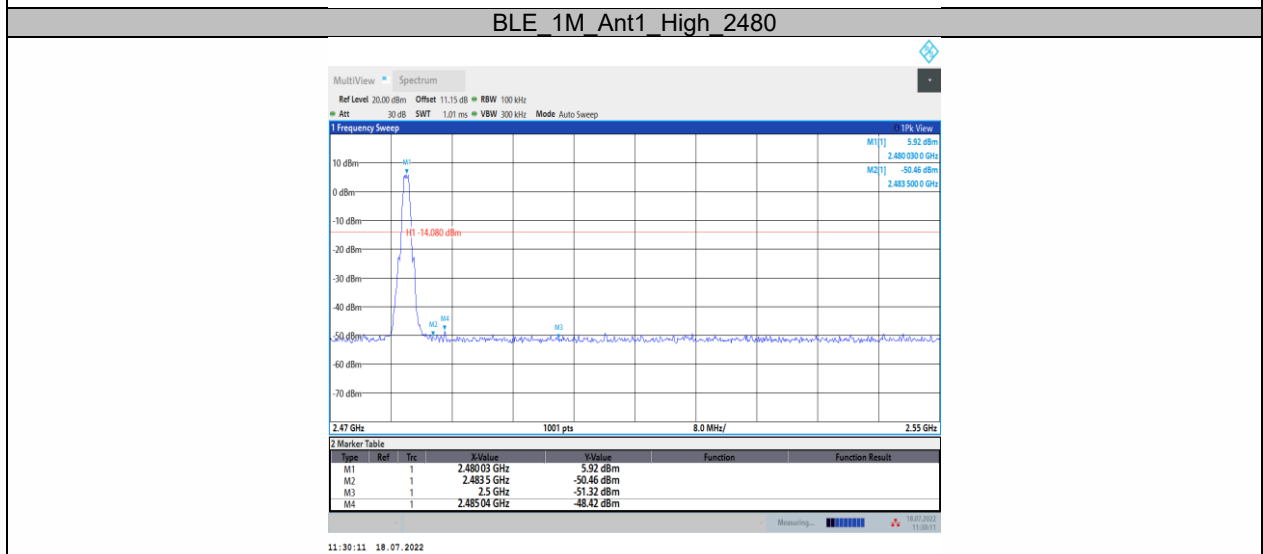
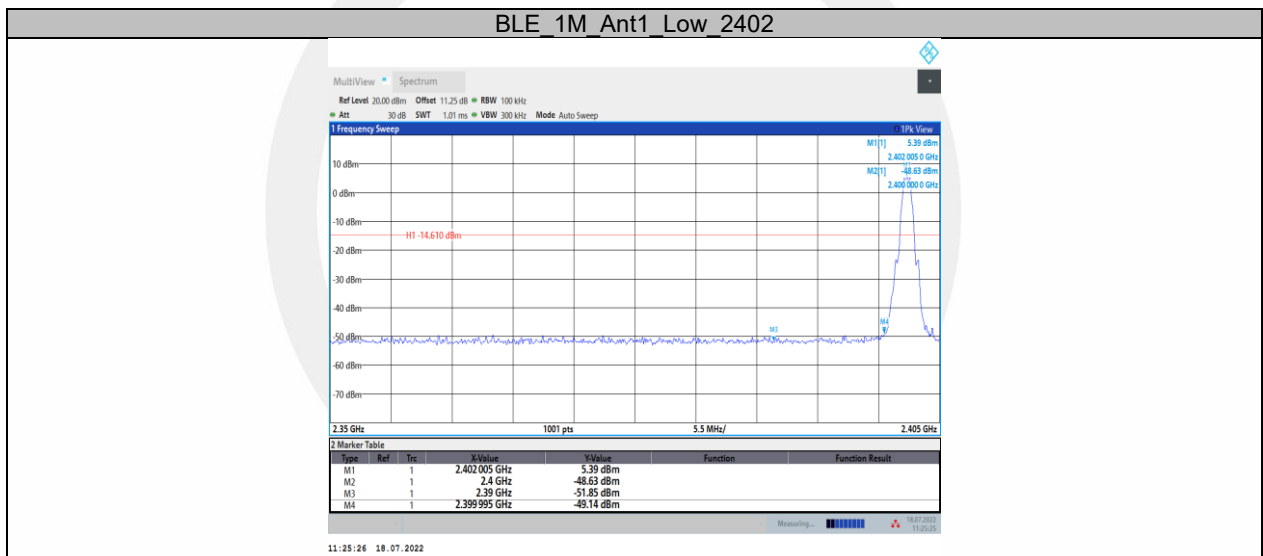

Conducted Spurious Emission

TestMode	Antenna	Frequency[MHz]	FreqRange [MHz]	RefLevel [dBm]	Result[dBm]	Limit[dBm]	Verdict
BLE_1M	Ant1	2402	Reference	5.46	5.46	---	PASS
			30~1000	5.46	-55.9	≤-14.54	PASS
			1000~26500	5.46	-40.95	≤-14.54	PASS
		2440	Reference	5.63	5.63	---	PASS
			30~1000	5.63	-55.55	≤-14.37	PASS
			1000~26500	5.63	-43.59	≤-14.37	PASS
		2480	Reference	6.04	6.04	---	PASS
			30~1000	6.04	-56.7	≤-13.96	PASS
			1000~26500	6.04	-44.81	≤-13.96	PASS



BLE_1M_Ant1_2402_0~Reference

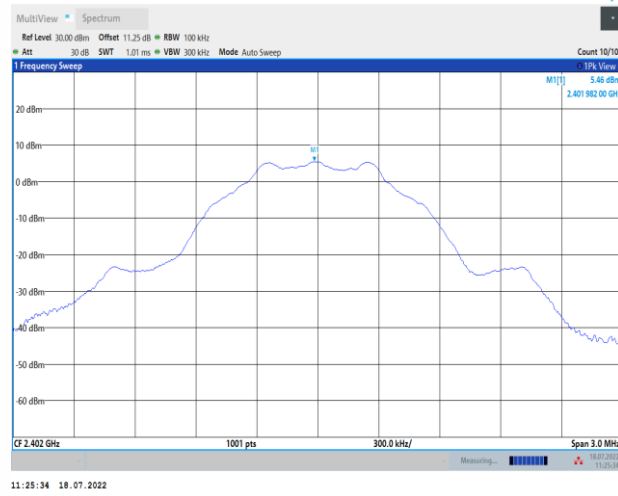

BLE_1M_Ant1_2402_30~1000

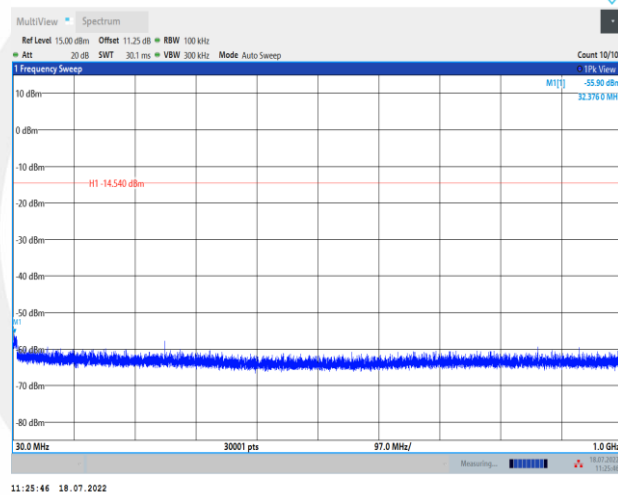

BLE_1M_Ant1_2402_1000~26500

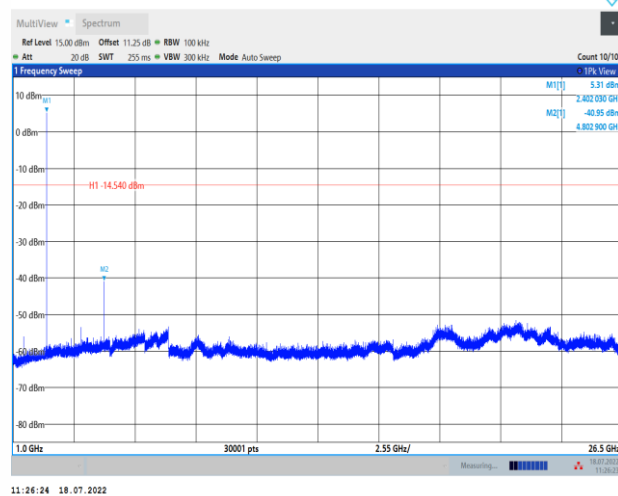

BLE_1M_Ant1_2440_0~Reference

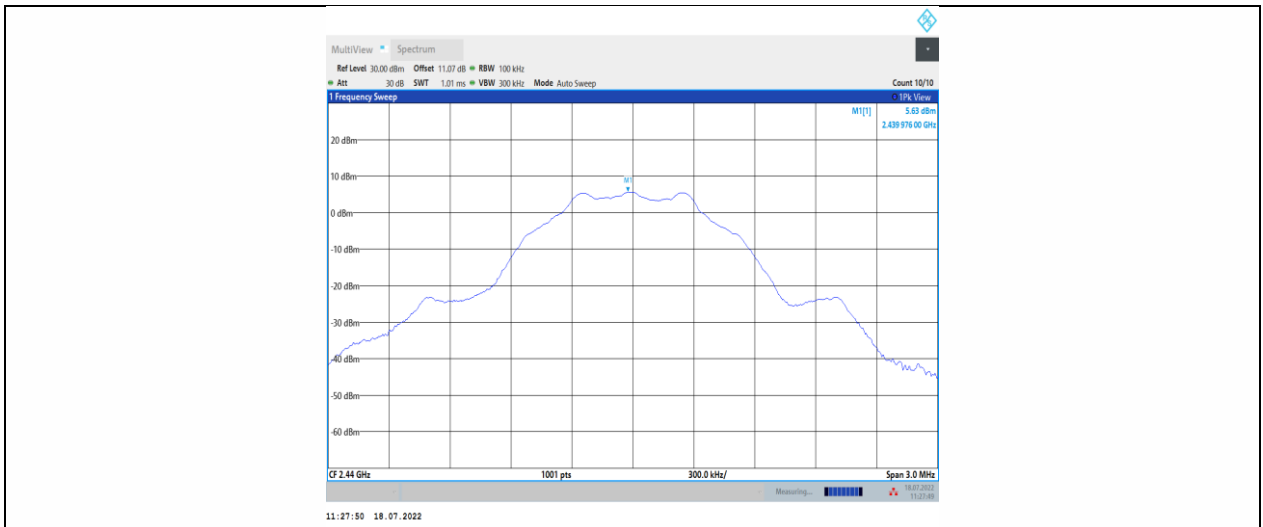

BLE 1M Ant1 2440 30~1000

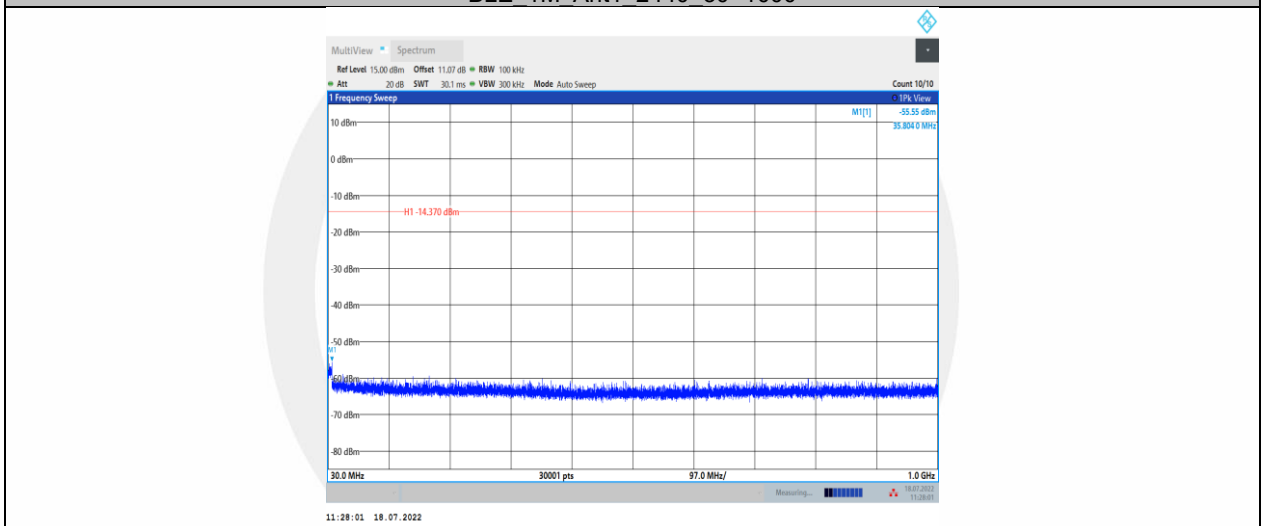

BLE 1M Ant1 2440 1000~26500

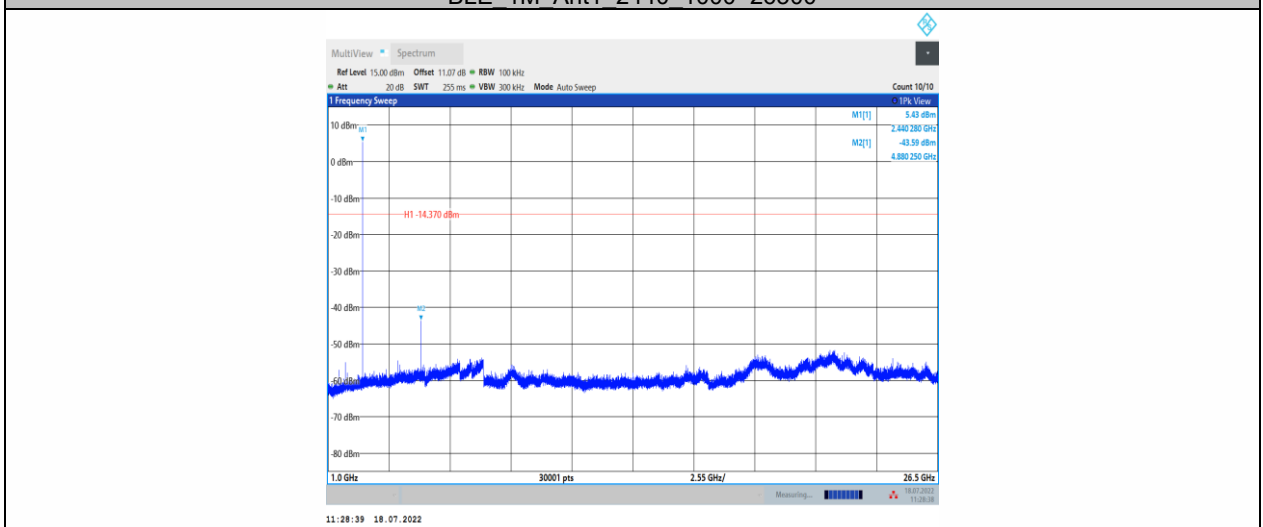

BLE 1M Ant1 2480 0~Reference

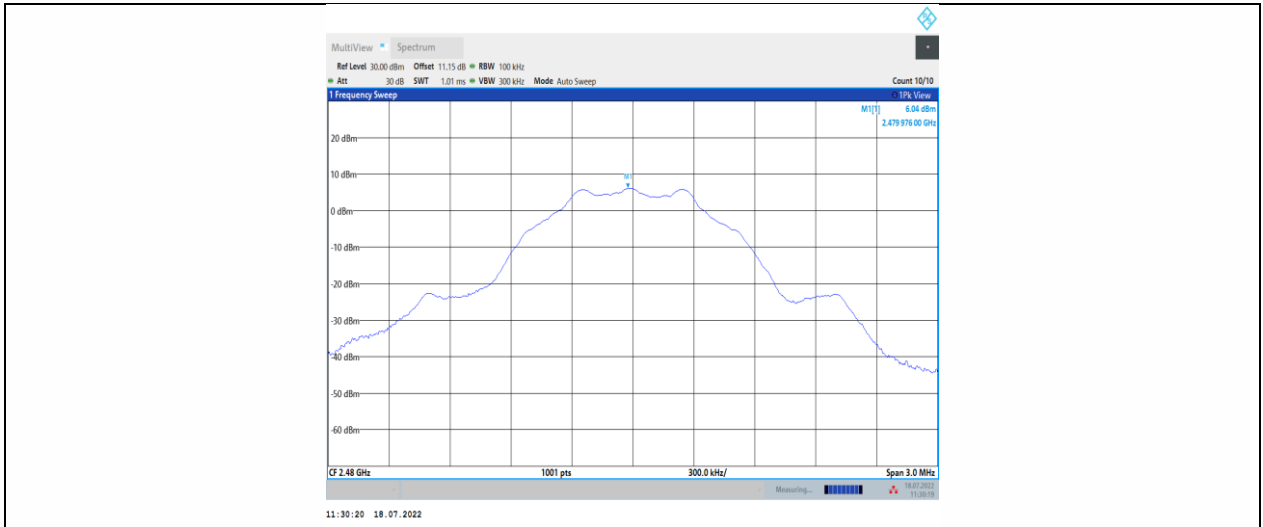

BLE 1M Ant1 2480 30~1000

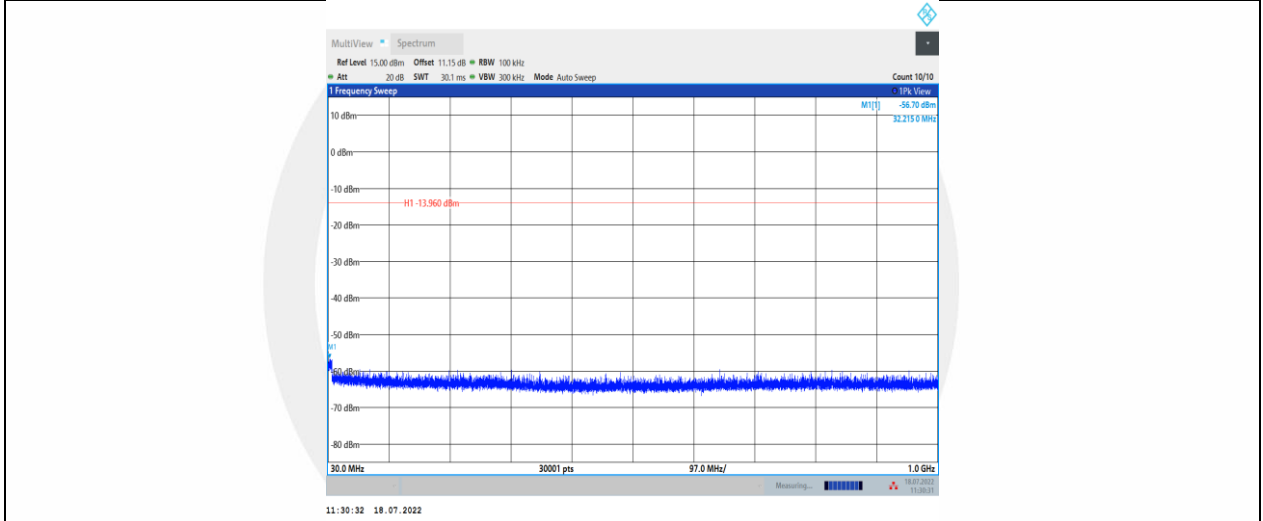

BLE 1M Ant1 2480 1000~26500

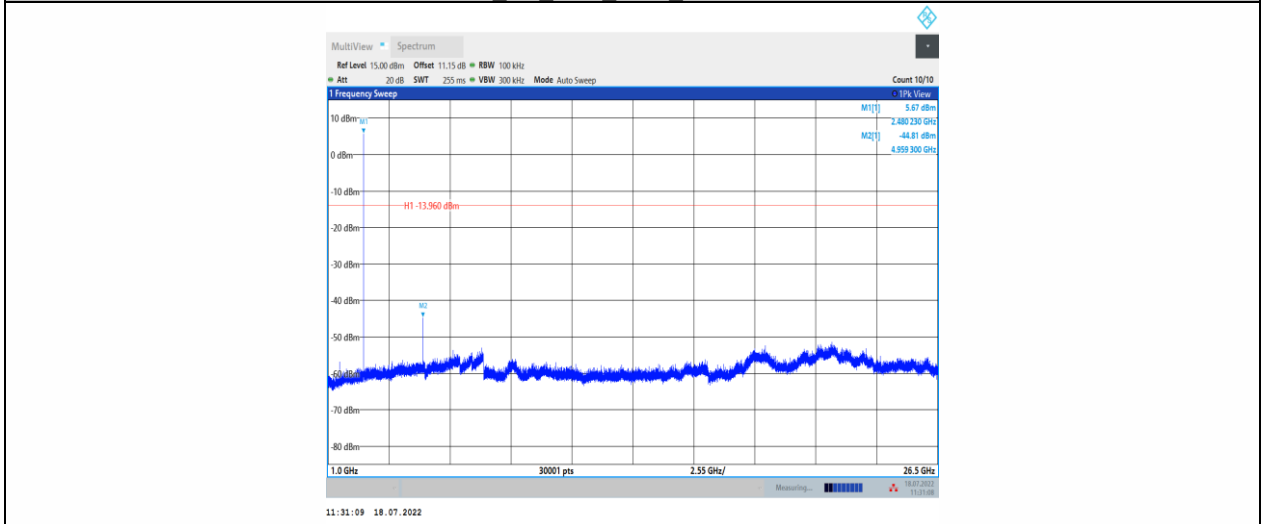

8.7 RADIATED SPURIOUS EMISSION

8.7.1 Applicable Standard

According to FCC Part 15.247(d), 15.205, 15.209

According to RSS-Gen and RSS-247

According to 558074 D01 15.247 Meas Guidance v05r02 Section 8.6

According to ANSI C63.10 Section 11.12

8.7.2 Conformance Limit

According to FCC Part 15.247(d): radiated emissions which fall in the restricted bands, as defined in §15.205(a), must also comply with the radiated emission limits specified in §15.209(a) (see §15.205(c)).

According to FCC Part 15.205, Restricted bands

MHz	MHz	MHz	GHz
0.090-0.110	16.42-16.423	399.9-410	4.5-5.15
0.495-0.505	16.69475-16.69525	608-614	5.35-5.46
2.1735-2.1905	16.80425-16.80475	960-1240	7.25-7.75
4.125-4.128	25.5-25.67	1300-1427	8.025-8.5
4.17725-4.17775	37.5-38.25	1435-1626.5	9.0-9.2
4.20725-4.20775	73-74.6	1645.5-1646.5	9.3-9.5
6.215-6.218	74.8-75.2	1660-1710	10.6-12.7
6.26775-6.26825	123-138	2200-2300	14.47-14.5
8.291-8.294	149.9-150.05	2310-2390	15.35-16.2
8.362-8.366	156.52475-156.52525	2483.5-2500	17.7-21.4
8.37625-8.38675	156.7-156.9	2690-2900	22.01-23.12
8.41425-8.41475	162.0125-167.17	3260-3267	23.6-24.0
12.29-12.293	167.72-173.2	3332-3339	31.2-31.8
12.51975-12.52025	240-285	3345.8-3358	36.43-36.5
12.57675-12.57725	322-335.4	3600-4400	Above 38.6
13.36-13.41			

According to FCC Part 15.205, the level of any transmitter spurious emission in Restricted bands shall not exceed the level of the emission specified in the following table

Restricted Frequency(MHz)	Field Strength (μV/m)	Field Strength (dBμV/m)	Measurement Distance
0.009-0.490	2400/F(KHz)	20 log (uV/m)	300
0.490-1.705	24000/F(KHz)	20 log (uV/m)	30
1.705-30	30	29.5	30
30-88	100	40	3
88-216	150	43.5	3
216-960	200	46	3
Above 960	500	54	3

8.7.3 Test Configuration

Test according to clause 7.2 radio frequency test setup 2

8.7.4 Test Procedure

This test is required for any spurious emission that falls in a Restricted Band, as defined in Section 15.205. It must be performed with the highest gain of each type of antenna proposed for use with the EUT. Use the following spectrum analyzer settings:

Peak power measurement procedures for Above 1GHz:

The EUT was placed on a turn table which is 1.5m above ground plane.

Maximum procedure was performed on the highest emissions to ensure EUT compliance.

Span = wide enough to fully capture the emission being measured

RBW = 1 MHz

VBW \geq RBW

Sweep = auto

Detector function = peak

Trace = max hold

Average power measurement procedures for Above 1GHz:

a) The EUT shall be configured to operate at the maximum achievable duty cycle

b) Measure the duty cycle D of the transmitter output signal.

c) RBW = 1 MHz.

d) VBW \geq [3 \times RBW].

e) Detector = RMS (power averaging), if span / (# of points in sweep) \leq (RBW / 2). Satisfying this condition may require increasing the number of points in the sweep or reducing the span. If this condition cannot be satisfied, then the detector mode shall be set to peak.

f) Averaging type = power (i.e., rms):

g) Sweep time = auto.

h) Perform a trace average of at least 100 traces.

i) A correction factor shall be added to the measurement results prior to comparing with the emission limit to compute the emission level that would have been measured had the test been performed at 100% duty cycle. The correction factor is computed as follows:

1) If power averaging (rms) mode was used in step f), then the applicable correction factor is [10 log (1 / D)], where D is the duty cycle.

2) If linear voltage averaging mode was used in step f), then the applicable correction factor is [20 log (1 / D)], where D is the duty cycle.

3) If a specific emission is demonstrated to be continuous (D \geq 98%) rather than turning ON and OFF with the transmit cycle, then no duty cycle correction is required for that emission.

Reduction of the measured emission amplitude levels to account for operational duty cycle is not permitted. Determining compliance is based on emission levels occurring during transmission; it is not based on an average across ON and OFF times of the transmitter.

For Below 1GHz:

The EUT was placed on a turn table which is 0.8m above ground plane.

Maximum procedure was performed on the highest emissions to ensure EUT compliance.

Span = wide enough to fully capture the emission being measured

RBW = 100 kHz for

VBW \geq RBW

Sweep = auto

Detector function = peak

Trace = max hold

For Below 30MHz:

The EUT was placed on a turn table which is 0.8m above ground plane.

Maximum procedure was performed on the highest emissions to ensure EUT compliance.

Span = wide enough to fully capture the emission being measured

RBW = 9kHz

VBW \geq RBW

Sweep = auto

Detector function = peak

Trace = max hold

For Below 150KHz:

The EUT was placed on a turn table which is 0.8m above ground plane.

Maximum procedure was performed on the highest emissions to ensure EUT compliance.

Span = wide enough to fully capture the emission being measured

RBW = 200Hz

VBW \geq RBW

Sweep = auto

Detector function = peak

Trace = max hold

Follow the guidelines in ANSI C63.10 with respect to maximizing the emission by rotating the EUT, measuring the emission while the EUT is situated in three orthogonal planes (if appropriate), adjusting the measurement antenna height and polarization, etc. A pre-amp and a high pass filter are required for this test, in order to provide the measuring system with sufficient sensitivity. Allow the trace to stabilize. The peak reading of the emission, after being corrected by the antenna factor, cable loss, pre-amp gain, etc., is the peak field strength, which must comply with the limit. Submit this data.

8.7.5 Test Results

Temperature:	25 C
Relative Humidity:	54%
ATM Pressure:	1011 mbar

■ Spurious Emission below 30MHz (9KHz to 30MHz)

Freq. (MHz)	Ant.Pol. H/V	Emission Level(dBuV/m)		Limit 3m(dBuV/m)		Over(dB)	
		PK	AV	PK	AV	PK	AV
--	--	--	--	--	--	--	--

Note: the amplitude of spurious emission that is attenuated by more than 20dB below the permissible limit has no need to be reported.

Distance extrapolation factor = $40\log(\text{Specific distance}/ \text{test distance})$ (dB);

Limit line=Specific limits(dBuV) + distance extrapolation factor

■ Spurious Emission Above 1GHz (1GHz to 25GHz)

Bluetooth (BLE_1M) mode have been tested, and the worst result was report as below:

Test mode: BLE_1M Frequency: Channel 0: 2402MHz

Freq. (MHz)	Ant.Pol.	Emission Level(dBuV/m)		Limit 3m(dBuV/m)		Over(dB)	
	H/V	PK	AV	PK	AV	PK	AV
4803.416	V	51.35	33.29	74	54	-22.65	-20.71
10024.89	V	55.09	38.53	74	54	-18.91	-15.47
17981.80	V	64.03	46.93	74	54	-9.97	-7.07
5476.169	H	45.89	28.93	74	54	-28.11	-25.07
11217.85	H	56.33	38.26	74	54	-17.67	-15.74
17875.56	H	63.78	45.79	74	54	-10.22	-8.21

Test mode: BLE_1M Frequency: Channel 19: 2440MHz

Freq. (MHz)	Ant.Pol.	Emission Level(dBuV/m)		Limit 3m(dBuV/m)		Over(dB)	
	H/V	PK	AV	PK	AV	PK	AV
4804.805	V	50.71	32.66	74	54	-23.29	-21.34
9692.948	V	53.96	35.93	74	54	-20.04	-18.07
17971.40	V	63.89	45.92	74	54	-10.11	-8.08
5476.960	H	44.38	26.44	74	54	-29.62	-27.56
11255.20	H	57.34	40.19	74	54	-16.66	-13.81
17860.07	H	64.53	46.88	74	54	-9.47	-7.12

Test mode: BLE_1M Frequency: Channel 39: 2480MHz

Freq. (MHz)	Ant.Pol.	Emission Level(dBuV/m)		Limit 3m(dBuV/m)		Over(dB)	
	H/V	PK	AV	PK	AV	PK	AV
4803.416	V	51.57	33.52	74	54	-22.43	-20.48
11282.89	V	56.43	38.26	74	54	-17.57	-15.74
17898.83	V	64.07	46.93	74	54	-9.93	-7.07
6180.306	H	45.54	28.34	74	54	-28.46	-25.66
8526.770	H	52.87	34.25	74	54	-21.13	-19.75
17904.00	H	64.37	46.93	74	54	-9.63	-7.07

- Note:**
- (1) All Readings are Peak Value (Detector=Peak) and Average Value (Detector=RMS).
 - (2) Emission Level= Reading Level+Correct Factor.
 - (3) Correct Factor= Ant_F + Cab_L – Preamp
 - (4) The reading of emissions are attenuated more than 20dB below the permissible limits or the field strength is too small to be measured.

■ Spurious Emission in Restricted Band 2310-2390MHz and 2483.5-2500MHz Bluetooth (BLE_1M) mode have been tested, and the worst result was report as below:

Test mode: BLE_1M Frequency: Channel 0: 2402MHz

Frequency (MHz)	Polarity	PK(dBuV/m) (VBW=3MHz)	Limit 3m (dBuV/m)	AV(dBuV/m) (VBW=10Hz)	Limit 3m (dBuV/m)
2387.748	H	49.76	74	31.33	54
2386.300	V	48.95	74	30.29	54

Test mode: BLE_1M Frequency: Channel 39: 2480MHz

Frequency (MHz)	Polarity	PK(dBuV/m) (VBW=3MHz)	Limit 3m (dBuV/m)	AV(dBuV/m) (VBW=10Hz)	Limit 3m (dBuV/m)
2484.366	H	53.90	74	35.26	54
2483.540	V	51.83	74	33.59	54

- Note:**
- (1) All Readings are Peak Value (Detector=Peak) and Average Value (Detector=RMS).
 - (2) Emission Level= Reading Level+Correct Factor.
 - (3) Correct Factor= Ant_F + Cab_L – Preamp
 - (4) The reading of emissions are attenuated more than 20dB below the permissible limits or the field strength is too small to be measured.

Test Model Spurious Emission in Restricted Band 2310-2390MHz
 Channel 0: 2402MHz BLE_1M H

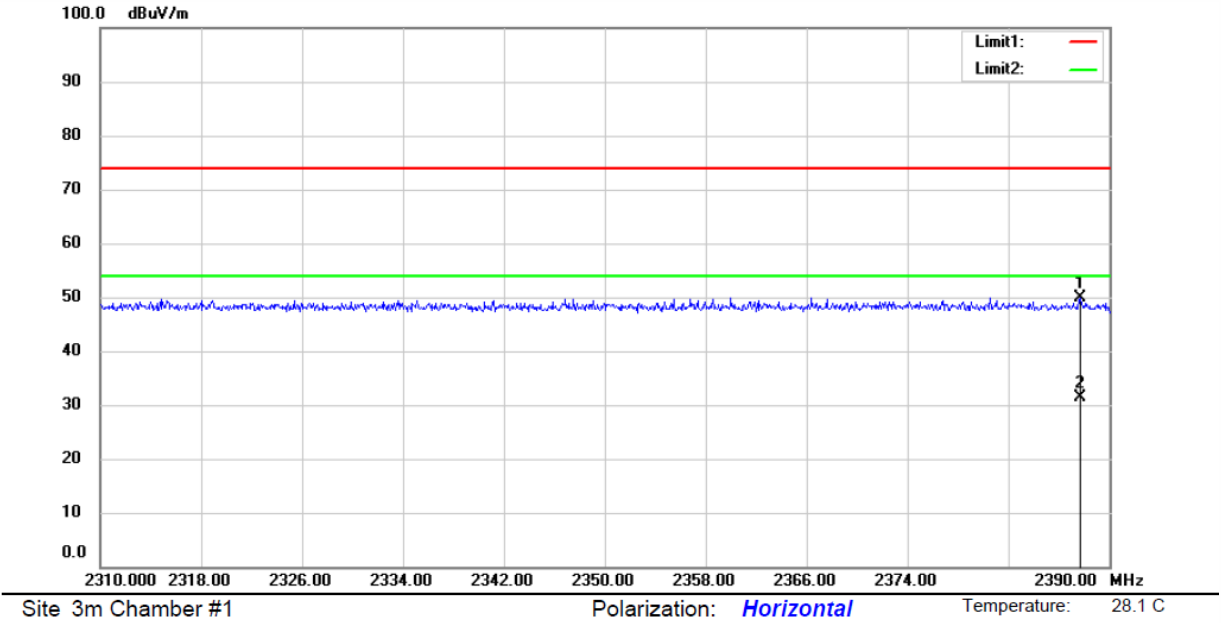

Test Model Spurious Emission in Restricted Band 2310-2390MHz
 Channel 0: 2402MHz BLE_1M V

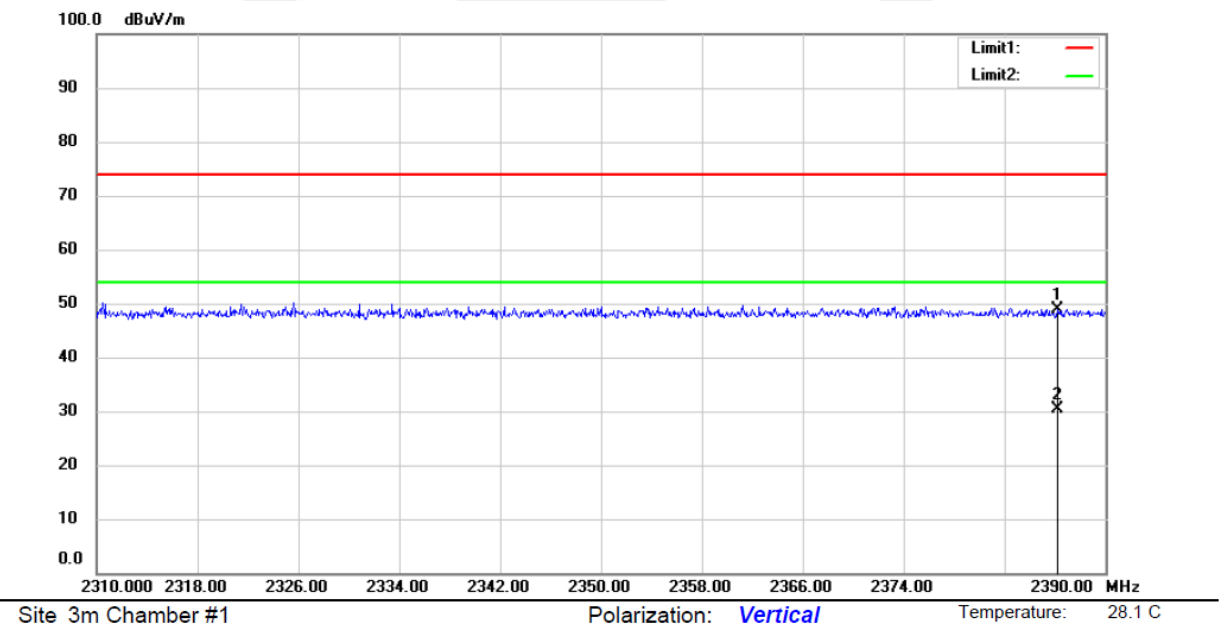

Test Model Spurious Emission in Restricted Band 2483.5-2500MHz
Channel 39: 2480MHz BLE_1M H

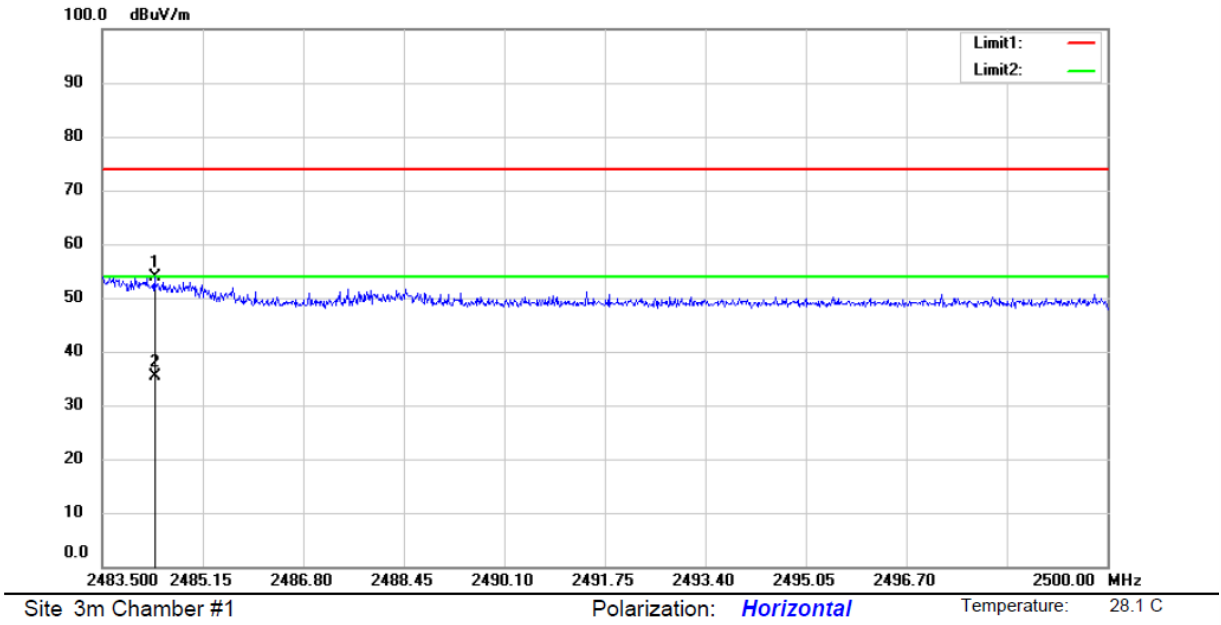

Test Model Spurious Emission in Restricted Band 2483.5-2500MHz
Channel 39: 2480MHz BLE_1M V

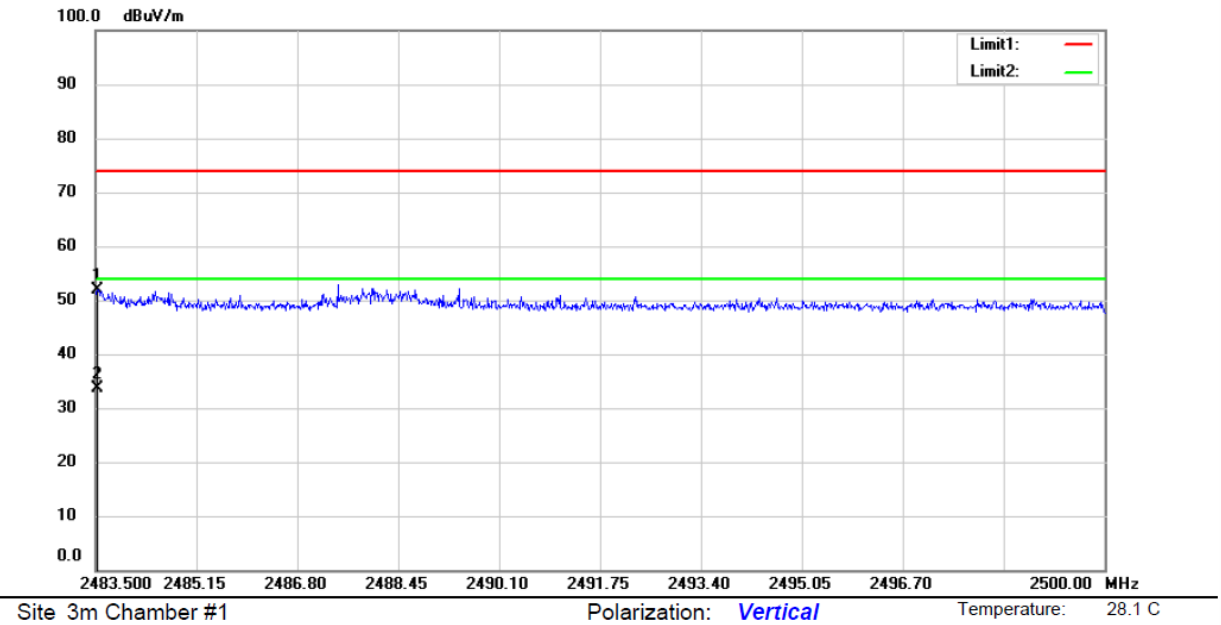

■ Spurious Emission below 1GHz (30MHz to 1GHz)

Bluetooth (BLE_1M, BLE_2M) mode have been tested, and the worst result was report as below:

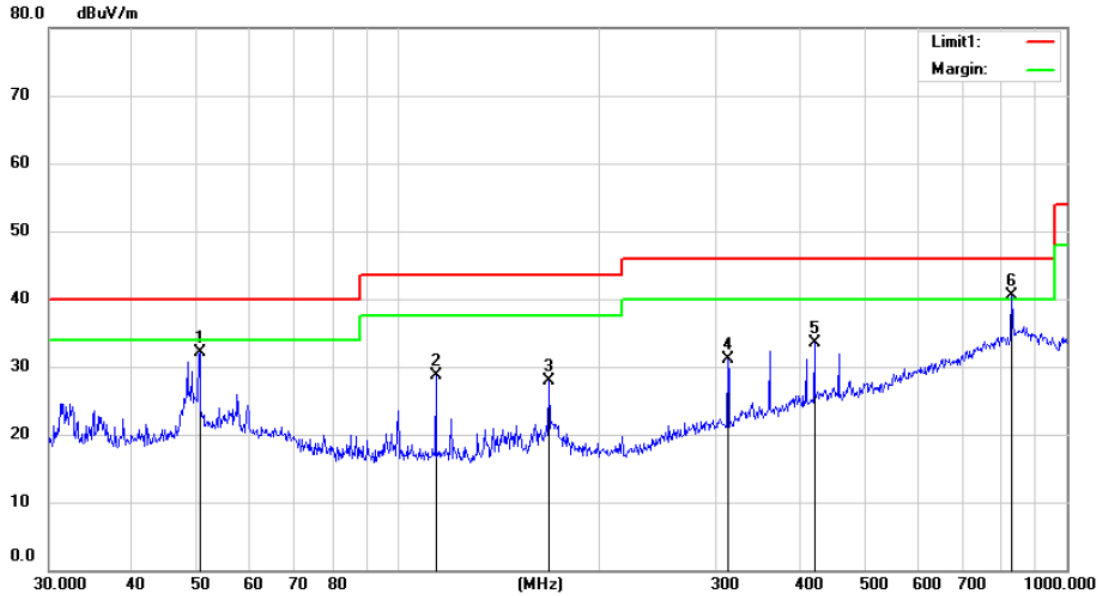

Site 3m Chamber #1 Polarization: *Vertical* Temperature: 28.1 C
 Limit: (RE)FCC PART 15 CLASS B Power: AC 120V/60Hz Humidity: 43 %
 Mode: BLE 2402
 Note:

No.	Mk.	Freq.	Reading Level	Correct Factor	Measurement	Limit	Over	Antenna Height	Table Degree	
		MHz	dBuV	dB	dBuV/m	dBuV/m	dB	cm	degree	Comment
1		50.4310	39.55	-7.49	32.06	40.00	-7.94	QP		
2		113.7143	38.64	-9.96	28.68	43.50	-14.82	QP		
3		168.0451	37.91	-9.94	27.97	43.50	-15.53	QP		
4		312.0426	36.34	-5.17	31.17	46.00	-14.83	QP		
5		420.0276	35.60	-2.16	33.44	46.00	-12.56	QP		
6	*	827.8562	34.21	6.25	40.46	46.00	-5.54	QP		

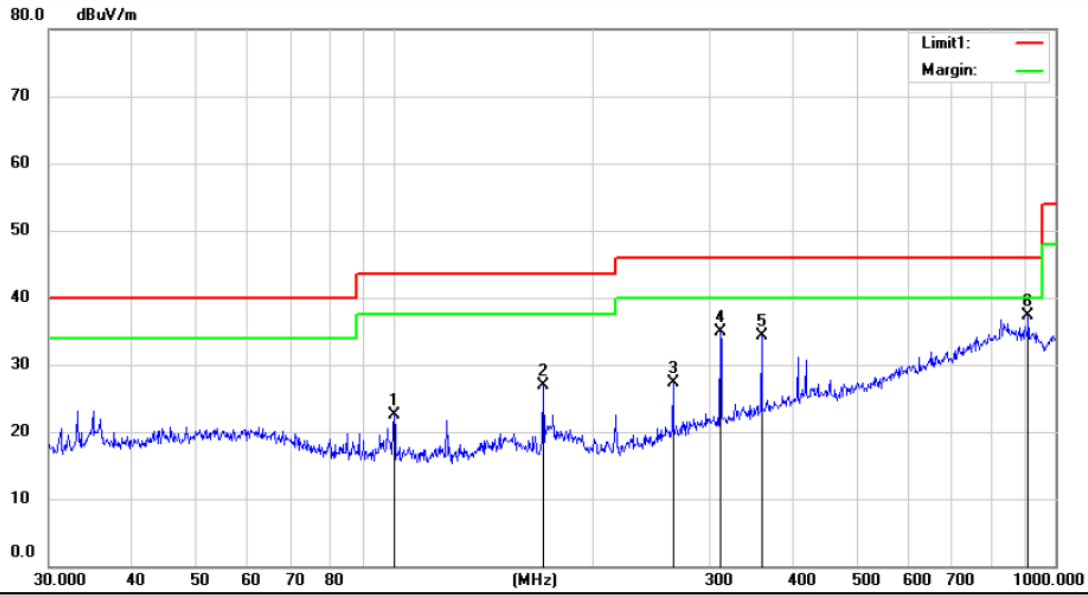

Site 3m Chamber #1 Polarization: **Horizontal** Temperature: 28.1 C
 Limit: (RE)FCC PART 15 CLASS B Power: AC 120V/60Hz Humidity: 43 %
 Mode: BLE 2402
 Note:

No.	Mk.	Freq. MHz	Reading Level dBuV	Correct Factor dB	Measure- ment dBuV/m	Limit dBuV/m	Over dB	Antenna Height cm	Table Degree degree	Detector	Comment
1		99.9653	33.03	-10.43	22.60	43.50	-20.90			QP	
2		168.0451	36.86	-9.94	26.92	43.50	-16.58			QP	
3		264.0504	33.79	-6.56	27.23	46.00	-18.77			QP	
4		312.0426	40.06	-5.17	34.89	46.00	-11.11			QP	
5		360.1320	37.62	-3.37	34.25	46.00	-11.75			QP	
6	*	912.0621	32.01	5.34	37.35	46.00	-8.65			QP	

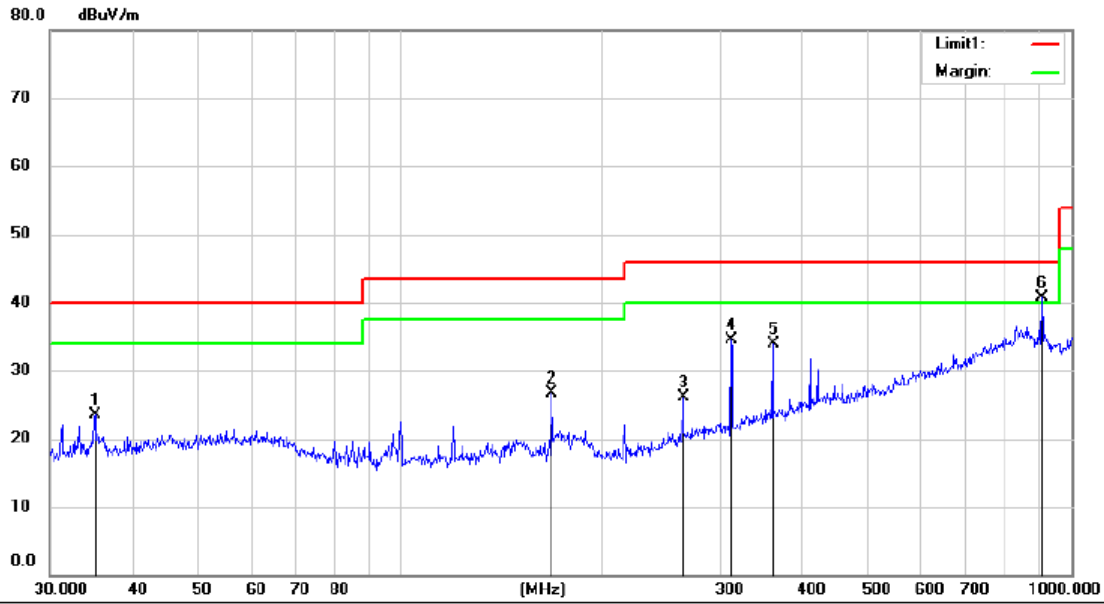

Site 3m Chamber #1 Polarization: **Vertical** Temperature: 28.1 C
 Limit: (RE)FCC PART 15 CLASS B Power: AC 120V/60Hz Humidity: 43 %
 Mode: BLE 2440
 Note:

No.	Mk.	Freq. MHz	Reading Level dBuV	Correct Factor dB	Measure- ment dBuV/m	Limit dBuV/m	Over dB	Antenna Height cm	Table Degree degree	Comment
1		35.0355	32.67	-9.19	23.48	40.00	-16.52	QP		
2		168.0451	36.64	-9.94	26.70	43.50	-16.80	QP		
3		264.0504	32.63	-6.56	26.07	46.00	-19.93	QP		
4		312.0426	39.64	-5.17	34.47	46.00	-11.53	QP		
5		360.1320	37.20	-3.37	33.83	46.00	-12.17	QP		
6	*	904.8945	35.32	5.45	40.77	46.00	-5.23	QP		

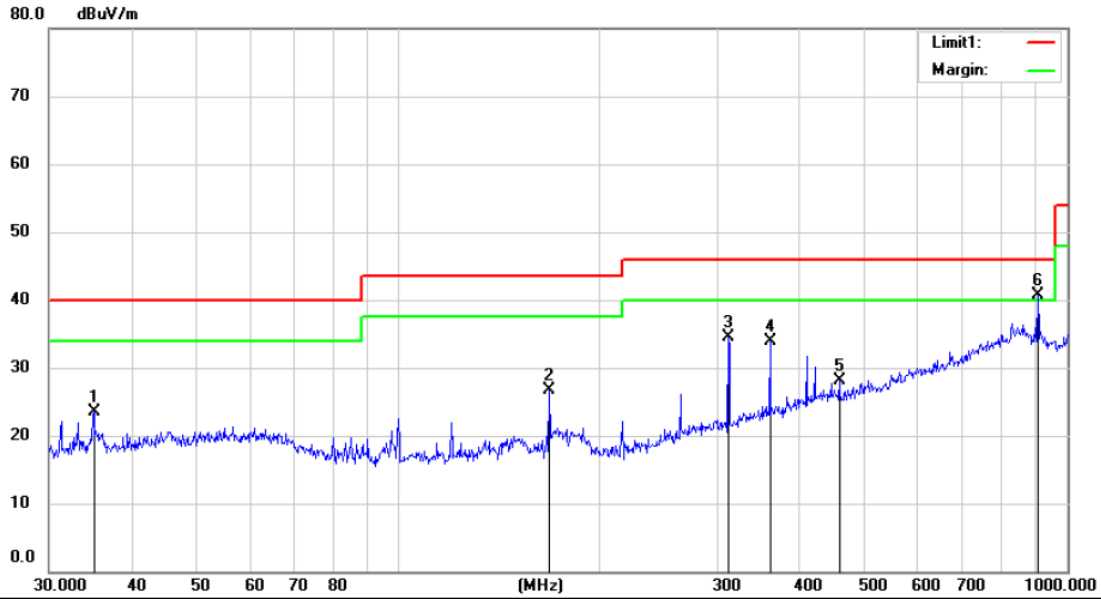

Site 3m Chamber #1 Polarization: **Horizontal** Temperature: 28.1 C
 Limit: (RE)FCC PART 15 CLASS B Power: AC 120V/60Hz Humidity: 43 %
 Mode: BLE 2440
 Note:

No.	Mk.	Freq.	Reading Level	Correct Factor	Measurement	Limit	Over	Antenna Height	Table Degree	
		MHz	dBuV	dB	dBuV/m	dBuV/m	dB	cm	degree	Comment
1		35.0355	32.67	-9.19	23.48	40.00	-16.52	QP		
2		168.0451	36.64	-9.94	26.70	43.50	-16.80	QP		
3		312.0426	39.64	-5.17	34.47	46.00	-11.53	QP		
4		360.1320	37.20	-3.37	33.83	46.00	-12.17	QP		
5		456.1057	30.13	-2.00	28.13	46.00	-17.87	QP		
6	*	904.8945	35.32	5.45	40.77	46.00	-5.23	QP		

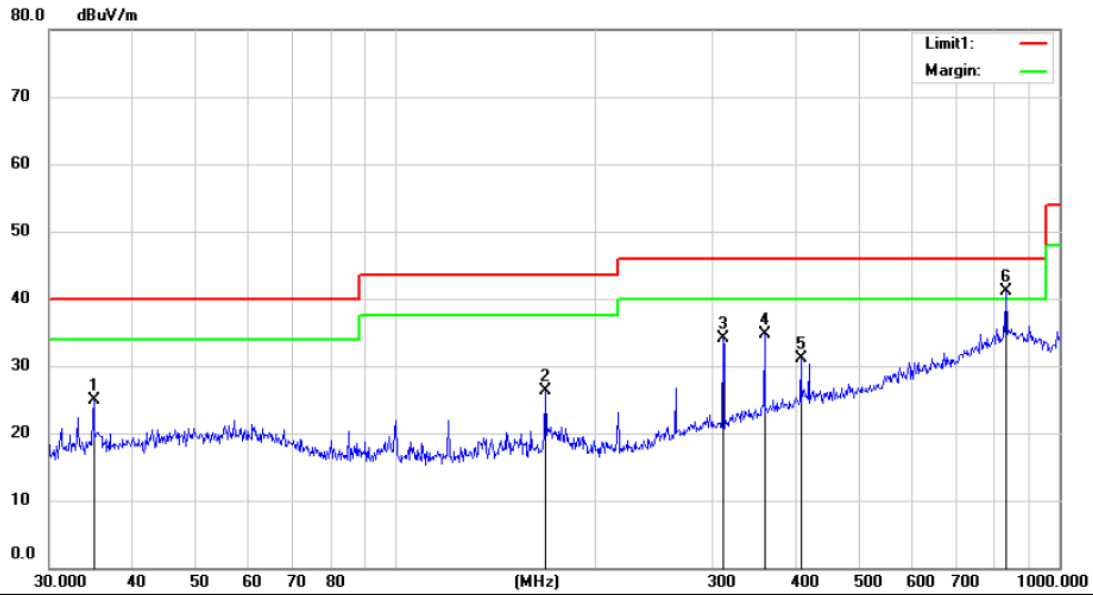

Site: 3m Chamber #1 Polarization: **Horizontal** Temperature: 28.1 C
 Limit: (RE)FCC PART 15 CLASS B Power: AC 120V/60Hz Humidity: 43 %
 Mode: BLE 2480
 Note:

No.	Mk.	Freq.	Reading Level	Correct Factor	Measurement	Limit	Over	Antenna Height	Table Degree
		MHz	dBuV	dB	dBuV/m	dBuV/m	dB	cm	degree
1		35.0202	34.05	-9.19	24.86	40.00	-15.14	QP	
2		168.0451	36.22	-9.94	26.28	43.50	-17.22	QP	
3		312.0426	39.30	-5.17	34.13	46.00	-11.87	QP	
4		360.1320	38.16	-3.37	34.79	46.00	-11.21	QP	
5		408.0507	33.39	-2.34	31.05	46.00	-14.95	QP	
6	*	831.1284	34.77	6.38	41.15	46.00	-4.85	QP	

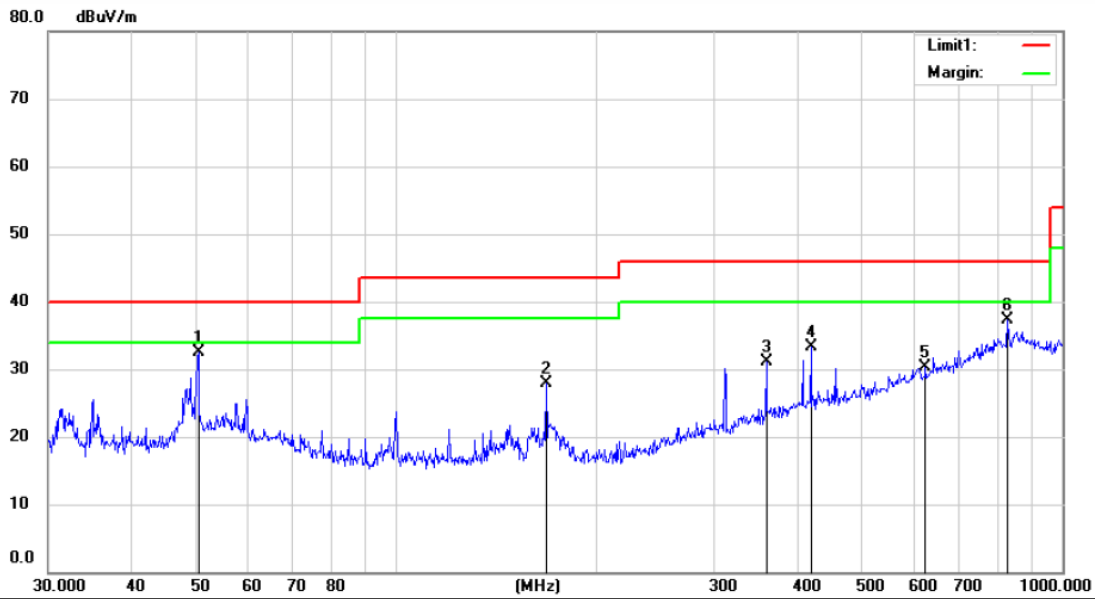

Site 3m Chamber #1 Polarization: **Vertical** Temperature: 28.1 C
 Limit: (RE)FCC PART 15 CLASS B Power: AC 120V/60Hz Humidity: 43 %
 Mode:BLE 2480
 Note:

No.	Mk.	Freq.	Reading Level	Correct Factor	Measurement	Limit	Over	Antenna Height	Table Degree	
		MHz	dBuV	dB	dBuV/m	dBuV/m	dB	cm	degree	Comment
1	*	50.4310	40.00	-7.49	32.51	40.00	-7.49	QP		
2		168.0451	37.86	-9.94	27.92	43.50	-15.58	QP		
3		360.1320	34.49	-3.37	31.12	46.00	-14.88	QP		
4		420.0276	35.51	-2.16	33.35	46.00	-12.65	QP		
5		623.9830	29.13	1.10	30.23	46.00	-15.77	QP		
6		827.8562	30.97	6.25	37.22	46.00	-8.78	QP		

8.8 CONDUCTED EMISSIONS TEST

8.8.1 Applicable Standard

According to FCC Part 15.207(a)
According to IC RSS-Gen 8.8

8.8.2 Conformance Limit

Frequency(MHz)	Conducted Emission Limit	
	Quasi-peak	Average
0.15-0.5	66-56	56-46
0.5-5.0	56	46
5.0-30.0	60	50

Note: 1. The lower limit shall apply at the transition frequencies
2. The limit decreases in line with the logarithm of the frequency in the range of 0.15 to 0.50MHz.

8.8.3 Test Configuration

Test according to clause 7.3 conducted emission test setup

8.8.4 Test Procedure

The EUT was placed on a table which is 0.8m above ground plane.
Maximum procedure was performed on the highest emissions to ensure EUT compliance.
Repeat above procedures until all frequency measured were complete.

8.8.5 Test Results

Pass

The AC120V &240V voltage have been tested, and the worst result recorded was report as below:

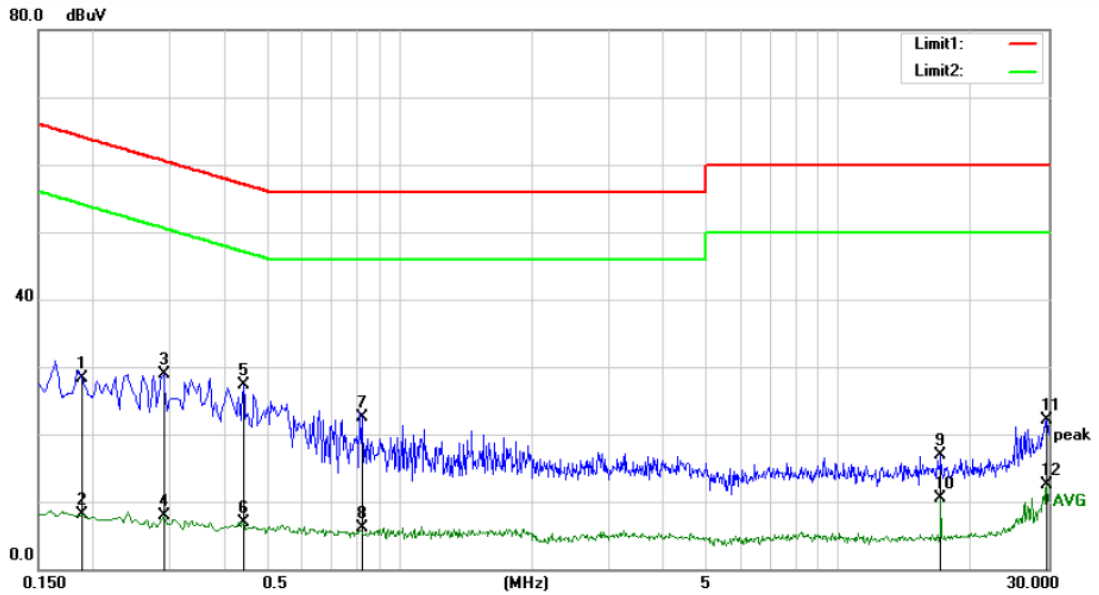

Site Conduction #1 Phase: **L1** Temperature: 22.2
 Limit: (CE)FCC PART 15 class B_QP Power: AC 30V Humidity: 55 %
 Mode: BT mode
 Note:

No.	Mk.	Freq.	Reading Level	Correct Factor	Measurement	Limit	Over	Detector	Comment
		MHz	dBuV	dB	dBuV	dBuV	dB		
1		0.1884	18.85	9.54	28.39	64.11	-35.72	QP	
2		0.1884	-1.38	9.54	8.16	54.11	-45.95	AVG	
3		0.2900	19.40	9.53	28.93	60.52	-31.59	QP	
4		0.2900	-1.71	9.53	7.82	50.52	-42.70	AVG	
5	*	0.4400	17.71	9.53	27.24	57.06	-29.82	QP	
6		0.4400	-2.64	9.53	6.89	47.06	-40.17	AVG	
7		0.8200	13.01	9.54	22.55	56.00	-33.45	QP	
8		0.8200	-3.45	9.54	6.09	46.00	-39.91	AVG	
9		17.0300	7.00	9.83	16.83	60.00	-43.17	QP	
10		17.0300	0.77	9.83	10.60	50.00	-39.40	AVG	
11		29.7300	11.73	10.36	22.09	60.00	-37.91	QP	
12		29.7300	2.19	10.36	12.55	50.00	-37.45	AVG	

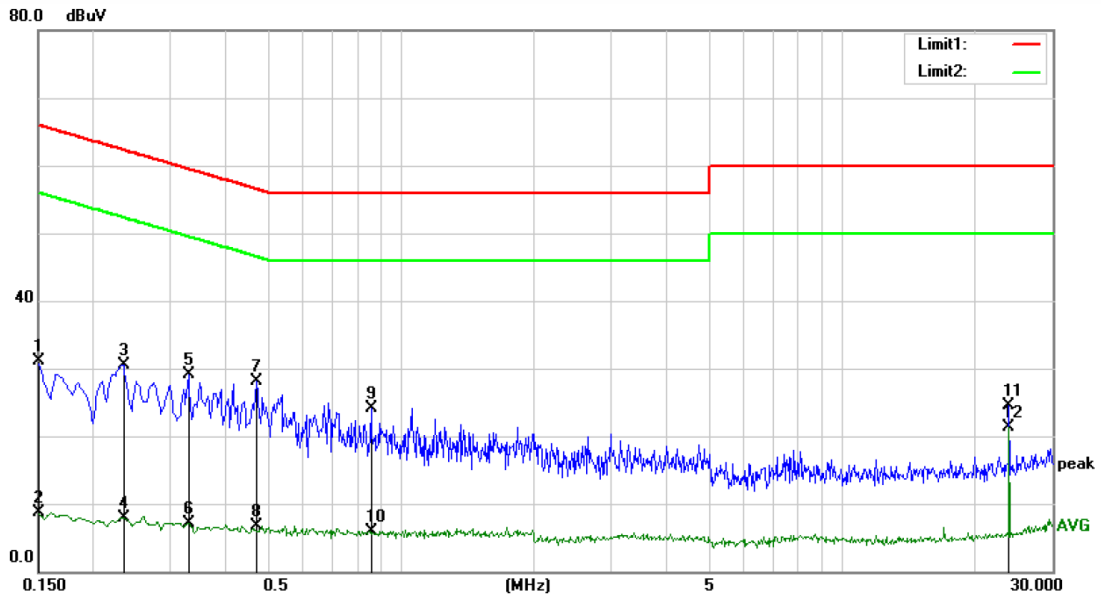

Site: Conduction #1
 Limit: (CE)FCC PART 15 class B_QP
 Mode: BT mode
 Note:

Phase: **N**
 Power: AC 30V

Temperature: 22.2
 Humidity: 55 %

No.	Mk.	Freq. MHz	Reading Level dBuV	Correct Factor dB	Measure- ment dBuV	Limit dBuV	Over dB	Detector	Comment
1		0.1500	21.62	9.54	31.16	66.00	-34.84	QP	
2		0.1500	-0.79	9.54	8.75	56.00	-47.25	AVG	
3		0.2350	21.02	9.54	30.56	62.27	-31.71	QP	
4		0.2350	-1.66	9.54	7.88	52.27	-44.39	AVG	
5		0.3300	19.54	9.53	29.07	59.45	-30.38	QP	
6		0.3300	-2.33	9.53	7.20	49.45	-42.25	AVG	
7	*	0.4700	18.60	9.53	28.13	56.51	-28.38	QP	
8		0.4700	-2.92	9.53	6.61	46.51	-39.90	AVG	
9		0.8550	14.60	9.55	24.15	56.00	-31.85	QP	
10		0.8550	-3.57	9.55	5.98	46.00	-40.02	AVG	
11		23.9800	14.37	10.04	24.41	60.00	-35.59	QP	
12		23.9800	11.19	10.04	21.23	50.00	-28.77	AVG	

8.9 ANTENNA APPLICATION

8.9.1 Antenna Requirement

Standard	Requirement
FCC CRF Part 15.203	An intentional radiator shall be designed to ensure that no antenna other than that furnished by the responsible party shall be used with the device. The use of a permanently attached antenna or of an antenna that uses a unique coupling to the intentional radiator shall be considered sufficient to comply with the provisions of this section. The manufacturer may design the unit so that a broken antenna can be replaced by the user, but the use of a standard antenna jack or electrical connector is prohibited.
FCC 47 CFR Part 15.247 (b)	If transmitting antennas of directional gain greater than 6dBi are used, the power shall be reduced by the amount in dB that the directional gain of the antenna exceeds 6dBi.
RSS-Gen Section 6.8	The applicant for equipment certification shall provide a list of all antenna types that may be used with the transmitter, where applicable (i.e. for transmitters with detachable antenna), indicating the maximum permissible antenna gain (in dBi) and the required impedance for each antenna. The test report shall demonstrate the compliance of the transmitter with the limit for maximum equivalent isotropically radiated power (e.i.r.p.) specified in the applicable RSS, when the transmitter is equipped with any antenna type, selected from this list.
RSS-247 Section 5.4	If the transmitter employs an antenna system that emits multiple directional beams, but does not emit multiple directional beams simultaneously, the total output power conducted to the array or arrays that comprise the device (i.e. the sum of the power supplied to all antennas, antenna elements, staves, etc., and summed across all carriers or frequency channels) shall not exceed the applicable output power limit. However, the total conducted output power shall be reduced by 1 dB below the specified limits for each 3 dB that the directional gain of the antenna/antenna array exceeds 6 dBi. The directional antenna gain shall be computed as the sum of 10 log (number of array elements or staves) plus the directional gain of the element or stave having the highest gain.

8.9.2 Result

PASS.

- Note:
- Antenna use a permanently attached antenna which is not replaceable.
 - Not using a standard antenna jack or electrical connector for antenna replacement
 - The antenna has to be professionally installed (please provide method of installation)

Please refer to the attached document Internal Photos to show the antenna connector.

Detail of Factor For Radiated Emission

Frequency(MHz)	Ant_F(dB)	Cab_L(dB)	Preamp(dB)	Correct Factor(dB)
0.009	20.6	0.03	\	20.63
0.15	20.7	0.1	\	20.8
1	20.9	0.15	\	21.05
10	20.1	0.28	\	20.38
30	18.8	0.45	\	19.25
30	11.7	0.62	27.9	-15.58
100	12.5	1.02	27.8	-14.28
300	12.9	1.91	27.5	-12.69
600	19.2	2.92	27	-4.88
800	21.1	3.54	26.6	-1.96
1000	22.3	4.17	26.2	0.27
1000	25.6	1.76	41.4	-14.04
3000	28.9	3.27	43.2	-11.03
5000	31.1	4.2	44.6	-9.3
8000	36.2	5.95	44.7	-2.55
10000	38.4	6.3	43.9	0.8
12000	38.5	7.14	42.3	3.34
15000	40.2	8.15	41.4	6.95
18000	45.4	9.02	41.3	13.12
18000	37.9	1.81	47.9	-8.19
21000	37.9	1.95	48.7	-8.85
25000	39.3	2.01	42.8	-1.49
28000	39.6	2.16	46.0	-4.24
31000	41.2	2.24	44.5	-1.06
34000	41.5	2.29	46.6	-2.81
37000	43.8	2.30	46.4	-0.3
40000	43.2	2.50	42.2	3.5

----- END OF REPORT -----