

# VU<sup>TM</sup> CAM & Garage Controller

USER'S MANUAL



**VU**point<sup>™</sup>  
Home Solutions

## Installation Guide

SMART SOCKET ADAPTER  
PAGE 02 - 08

VUcam  
PAGE 09 - 15

CONTROLLER and SENSOR  
PAGE 16 - 22

COMPANION and SETUP  
WITH YOUR MOBILE DEVICE  
PAGE 23 - 26

TROUBLESHOOTING and FAQ  
REGULATIONS and COMPLIANCE  
COMPATIBILITY  
PAGE 27 - 34

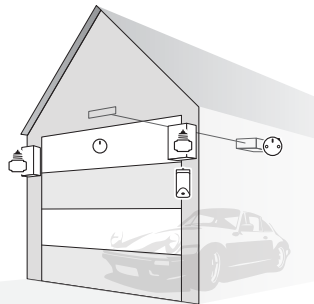

Installation Guide

# Smart Socket Adapter



Model No.: SA010KU



## Power Connection Options

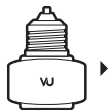

### Compatible light bulb types



For use only with max. 40W, E26 and standard A15 / A19 size Incandescent, CFL or LED light bulb.

### NOT Compatible light bulb types



Halogen, Candelabra, Triple Twin Tube, Two Prong, Globe, Motion-activated Light and others.

### Compatible light fixtures



Ceiling lamp and Wall mounted lamp.

### NOT Compatible light fixtures



Light fixtures with motion sensor or 12-hour mechanical timer.

### Compatible light bulb types



### Compatible light fixtures

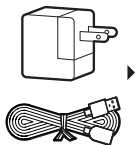

Smart Socket Adapter for use in dry or damp locations



## Kit Components

- 1 Smart Socket Adapters x 2
- 2 Power Cable(1m)
- 3 Power Extension Cable(3m)
- 4 Cable Clips for 1m Cable x 6
- 5 Cable Clips for 3m Cable x 6
- 6 AC / DC Adapter

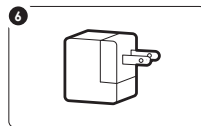
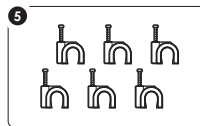
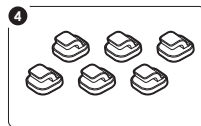
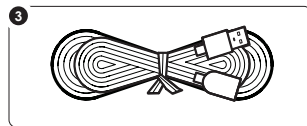
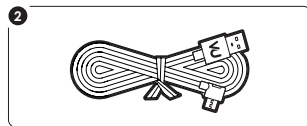
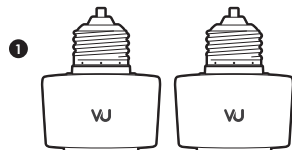



## Specifications

Lamp Base Type	Socket type E26
Output Voltage	DC: 5V/1A
Input Voltage	120VAC, 60Hz
Lighting Control	On/Off/Light Scheduling BLE Mesh Network
Bluetooth®	Bluetooth® BLE 4.0
Light bulb	Support maximum 40W, A15/A19 size Incandescent, CFL or LED light bulb Recommended LED light bulb (not included)
Dimensions (L x W x H)	2.4" x 2.0" x 2.5"
Operating Temperature	-4°F - 113°F



## Smart Socket Adapter Installation

**⚠** Before installation, ensure the power switch is OFF or disconnect power at the fuse.

Remove cover and insert Power Cable to Smart Socket Adapter.

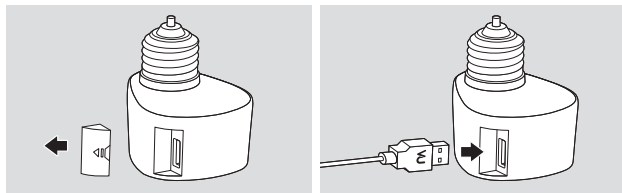

Install Smart Socket Adapter to fixture, and thread in light bulb.  
Disassemble the lamp sconce if necessary.

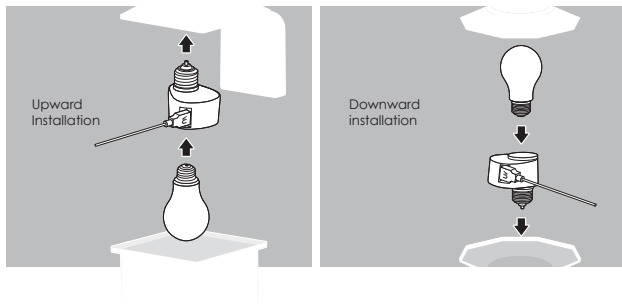



Drag out Power Cable through the shade and then adjust silicon sleeve from Power Cable to protect the cable.

Screw lamp sconce or lamp cover back to your light fixture.

Use Cable Clips to manage the cable if necessary.

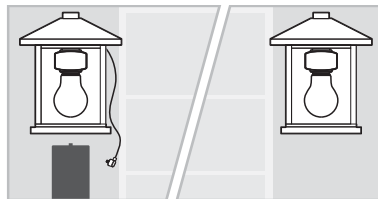
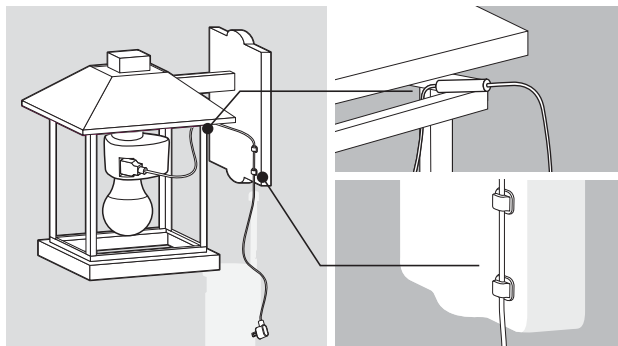

For additional light fixture:  
Install second optional Smart Socket Adapter when necessary for lighting synchronization.

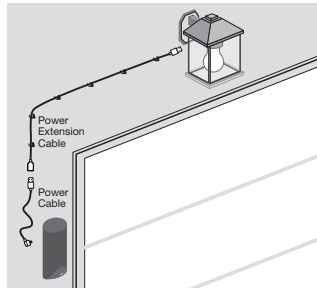

#### For camera installation with light fixture above the door (optional)

Use Power Extension Cable to connect Power Cable from camera with ceiling light fixture above the door. Use Cable clips to manage the cable if necessary.

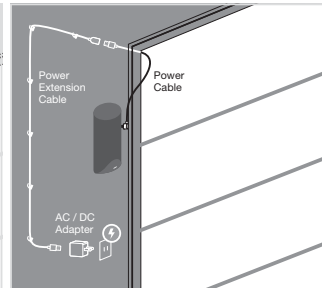

#### Alternative power source

Connect camera directly to alternative power outlet with Extension Power Cable. Use Cable clips to manage the cable if necessary.

## Installation Guide

# Companion with Mobile



Model No.: GC100KU

## Kit Components

- 1 VUcam
- 2 Bracket
- 3 Conduit
- 4 Mount Screws x 2
- 5 Anchors x 2
- 6 Allen Wrench

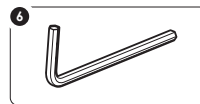
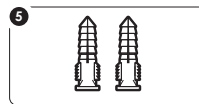
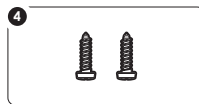
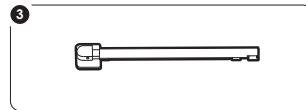
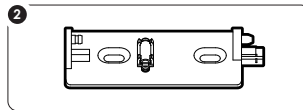
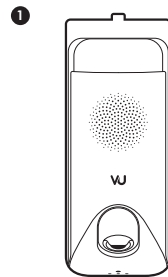

# Specifications

Camera	HD 1080p resolution
Video resolution	1920x1080 at 30 fps. H.264
Field of View	180 degrees (diagonal)
Wi-Fi®	2.4GHz & 5GHz 802.11 b/g/n/ac
Bluetooth®	Bluetooth® BLE 4.0
Siren Alarm	100 dB
Lighting Control	On/Off/Light Scheduling
Weatherproof Design	Yes
Dimensions (L x W x H)	2.4" x 2.4" x 5.9"
Microphone	Built-in
Speaker	Built-in
Input Voltage	DC: 5V/1A
Compatibility	iOS: 8 or above / Android : 4.3 or above
Operating Temperature	-4°F - 113°F



## Mounting the Camera

After using the Leveler to adjust the balance of the Bracket, mount it with Anchors and Screws.

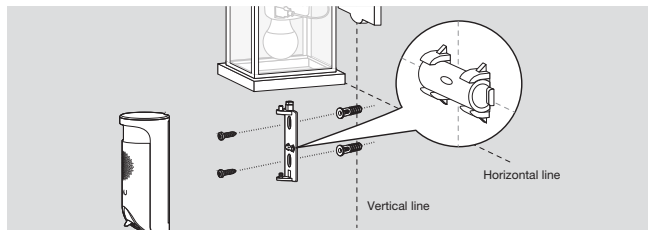

Remove back cover from the bottom of the camera, insert Power Cable, and then coil the cable around wrapping posts.

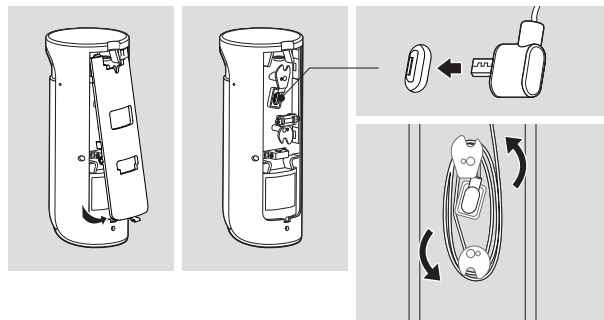

Reinstall the back cover to the camera.

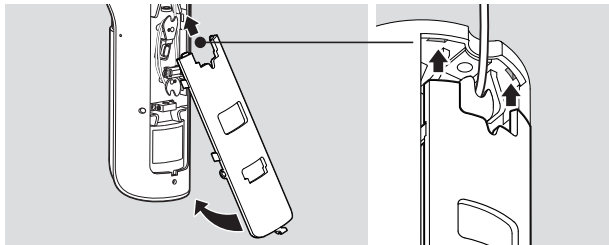

Attach the camera to the Bracket and slightly pull camera down to snap the camera in place.

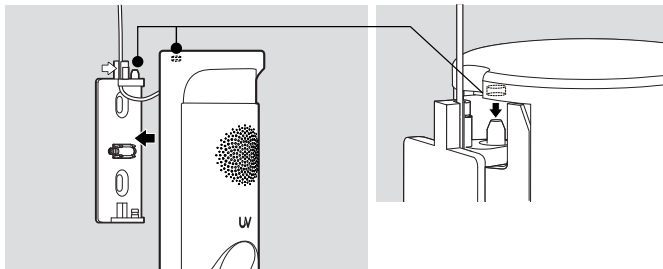

Manage the cable with optional Conduit. Remove the adhesives from the Conduit, then slide the bottom of the Conduit into the Bracket.

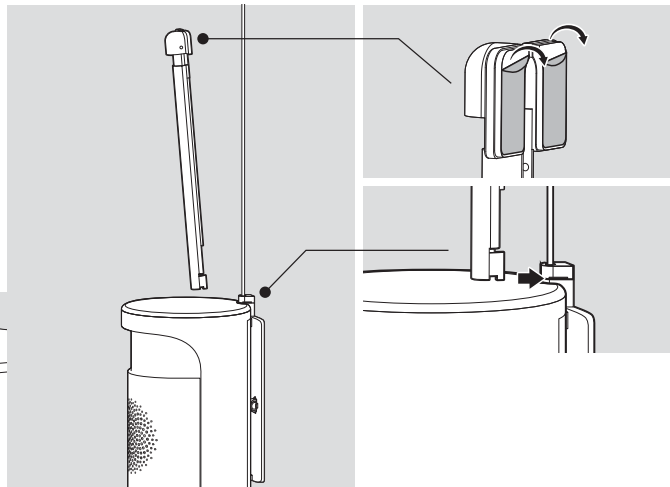



Align Power Cable and extend the Conduit to preferred length.  
Secure conduit onto the wall.

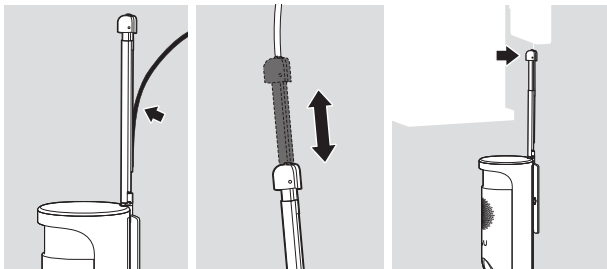

Adjust the camera to your desired position and angle.

Tighten the security screws  
on both sides by using the  
supplied Allen Wrench.

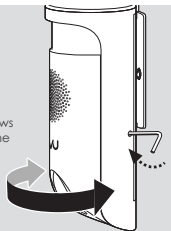

Do not over-tighten the security screws.

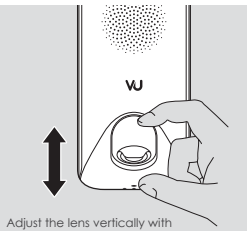

Adjust the lens vertically with  
fingers to your desired position.

## Installation Guide

# Controller & Sensor

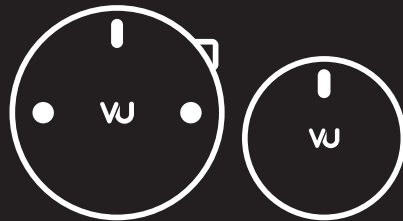

Controller Model No.: C001KU  
Sensor Model No.: S001KU

## Kit Components

- 1 Controller
- 2 Sensor
- 3 Nylon Zip Ties x 2

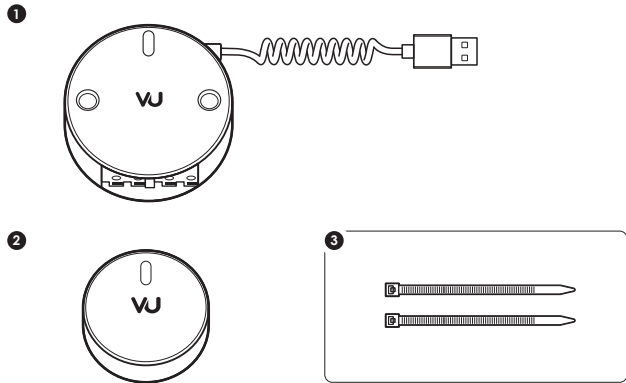

## Specifications

### Controller

Bluetooth®	Bluetooth® BLE 4.0
Input Voltage	5V, 0.2A
Dimensions (L x W x H)	2.4" x 0.8" x 2.4"
Operating Temperature	-4°F - 113°F



### Sensor

Sensor	3-Axis G Sensor
Bluetooth®	Bluetooth® BLE 4.0 or above
Sensor Sensitivity	+/-2g to +/- 8g
Dimensions (L x W x H)	1.8" x 0.5" x 1.8"
Battery Life	Approx. 20 months (10 times operation per day)
Battery Type	CR2450 3V
Operating Temperature	14°F - 131°F



## Installing Sensor

Remove adhesive from the Sensor and attach Sensor on the inside of the garage door. For optimal performance, install Sensor at the top panel of the door.

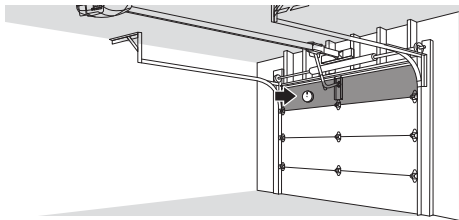
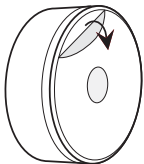

### Battery Installation

1. Turn the sensor cover to open
2. Remove battery insulation tab
3. Lock Sensor cover on base plate by aligning the white dots

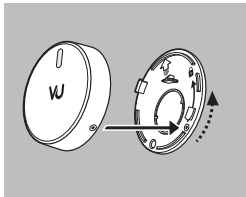
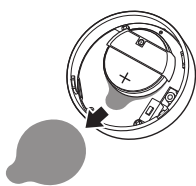
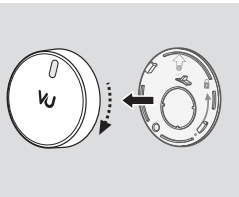

## Installing Controller

Install Controller near the garage door opener. Use supplied Zip Ties to secure the Controller in place.

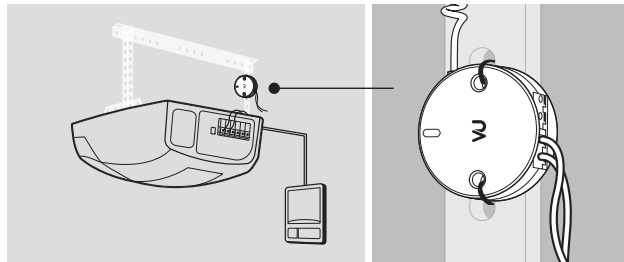

To release existing wires from garage door opener, push in tab with screwdriver tip.

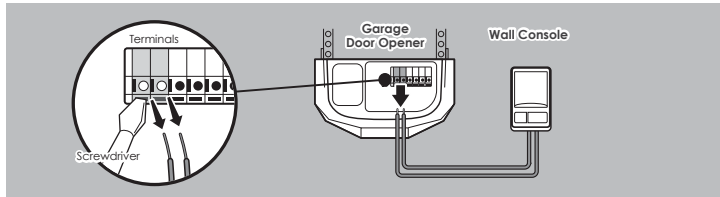

Wall console terminal's location may vary depending on various garage opener models

Push in tabs from the garage door opener terminals with screwdriver to insert wires from the Controller.

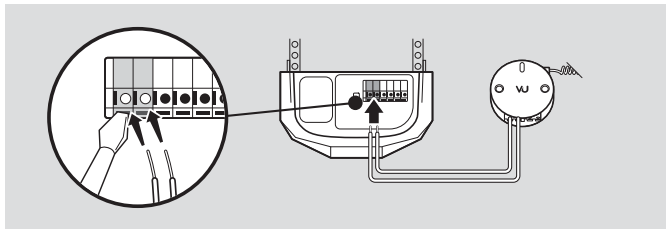

Insert wall console wires to Controller. Push in tab with screwdriver.

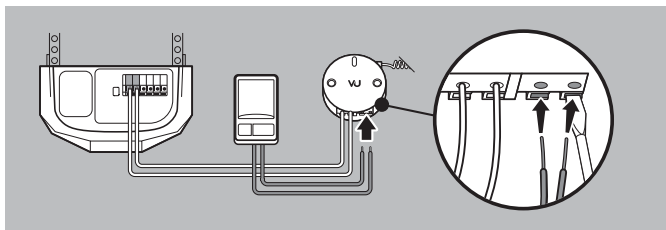

Plug the Controller's Power Cable to AC/ DC Adapter supplied, and then to a wall outlet for power.

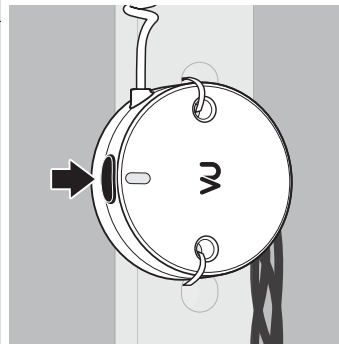
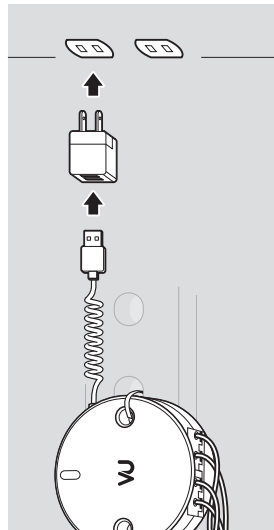

To ensure Controller works properly, press its button until red LED flashes. Then, your garage door should have response.

## Installation Guide

# Companion with Mobile



### Download "VUpoint Home" app

Scan the QR code or search "VUpoint Home" on google play or app store to download the app.



### 1. Open VUpoint Home app

Tap the app icon to launch application.



### 2. Add camera

On the homepage, tap the add camera icon in the upper right corner.



### 3. Before set up

Follow on-screen instructions to proceed with installation.



### 4. Camera found

Once camera device is found, tap "Next" to continue setup.



**5. Connect wifi**  
Enter your wifi password then tap "Next".



**6. Camera added**  
After camera added, tap "Add other device"  
to pair camera with companion devices.



**9. Select Sensor**  
Select Sensor for left or right door.



**10. Select Controller**  
Select Controller for left or right door.



**7. Adding new devices**  
From New Device page,  
tap to select devices to pair.



**8. New device light on**  
Selected item will light on in app  
as well as on device.



**11. Finished add device**  
Tap "Add Device" to confirm.  
When devices are successfully  
added, tap "Next".

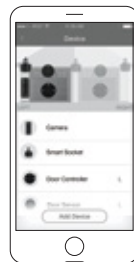

**12. Complete**  
Device map illustrates which devices  
are connected for the door(s).

## Appendix

# Troubleshooting and FAQ Regulations and Compliance Compatibility



## Troubleshooting and FAQ

Note: Model Number and Serial Number (S/N) are located on the packaging, user's manual, or on the product. Please have this information ready before contacting tech support.

### Frequently Asked Questions

#### VUcam

- 1. How long will my recordings be available?**  
All VUcam units come standard with 24-hour event review and download. With premium subscription plans, you can "go back in time" to access every event that your VUcam generated.
- 2. How many VUcams can I install?**  
There's no limit. We recommend installing VUcams at each entry points of Garage. You can add multiple cameras to your VUpoint Home app and manage each camera all in one app.
- 3. I do not see any VUcam show up in setup screen.**  
VUcam uses Bluetooth® LE 4.0 for setup. You will need to be within a maximum distance of 30 feet from the Garage devices and have Bluetooth enabled on your mobile device. Try rebooting your mobile device and launch the VUpoint Home app again when necessary.
- 4. My VUcam is "Offline".**
  - 1) Reboot camera:** Turn off your VUcam (using the light switch it's connected to) and wait at least 10 seconds. Then, turn the light switch back on.
  - 2) Run through the set-up process:** Re-add the VUcam again.  
This may be caused by weak Wi-Fi signal. Improve performance by moving your router closer to your VUcam, or adding a Wi-Fi extender in between.
- 5. How can I reset my camera?**  
VUcam can be reset through app, you can remove camera and re-add the camera in app again. You can also reset the camera manually by pressing the reset button at back for 7 seconds until you see the flash light changes to red.

## Smart Socket Adapter

1. **Do I have to leave my light switch on?**

Yes, VUcam uses power continuously, so you will have to leave the light switch on. We have provided with your VUcam a “Keep it on” label as reminder to leave the switch on.

2. **Can I use LED bulb with Smart Socket Adapter?**

Yes, we recommend that you use an LED bulb.

3. **What is the maximum light bulb wattage I can use with the Smart Socket Adapter?**

Smart Socket Adapter supports up to maximum 40W.

4. **My Smart Socket Adapter is “Offline”.**

VUcam uses BLE Mesh Network that is capable to provide connections for all devices within 30 feet. Firstly, ensure your Smart Socket Adapter is within this range with the camera. If your device still looks offline in the device map of VUpoint Home app, please go through the reset procedures once.

5. **How can I reset my Smart Socket Adapter?**

Smart Socket Adapter can be reset through app, you can remove Smart Socket Adapter and re-add it in app again. Another reset method is to press the on/off button in a designed sequence. When the light is on, press the light off for 3 seconds then on for 1 second. Repeat this sequence for three times. After reset, the light bulb will flash for 3 times, please note the light bulb will not light up once reset is successful.

## Sensor

1. **My Door Sensor is “Offline”.**

VUcam uses BLE Mesh Network that is capable to provide connections for all devices within 30 feet. Please ensure your Sensor is within this range with the camera. Then, shake the Sensor to see if its LED flashes. If Sensor has no response, please ensure battery is installed properly. If your Sensor still looks offline in the device map of VUpoint Home app, please run through the reset procedures once.

2. **I cannot open the cover of Sensor.**

Please turn the front cover of Sensor open after attaching it on the garage door.

3. **How can I reset my Sensor?**

Sensor can be reset through app, user can remove Controller and re-add it in app again. Another reset method is to turn on the cover and press the reset button for 7 seconds.

## Controller

1. **My Door Controller is “Offline”.**

VUcam uses BLE Mesh Network that is capable of providing connections for all devices within 30 feet. Please ensure your Controller is within range of the camera. Then, press the button on the Controller and see if its LED flashes. If the Controller has no response, please ensure the installation between the garage door opener and wall console has been done properly. If your Controller still looks offline in the device map of VUpoint Home app, please run through the reset procedures once.

2. **How can I reset my Controller?**

The Controller can be reset through the app. You can remove the Controller and re-add it in the app again. Another reset method is to press and hold the button for 7 seconds.







# Regulations and Compliance

## Safety & Operations

### IMPORTANT SAFETY INSTRUCTIONS

Please adhere to the following safety instructions. Failure to follow the instructions outlined in the user's manual may lead to serious personal injury and possible property damage.

-  Smart Socket Adapter DC power output max. up to 5W. The Smart Socket Adapter must be installed in the listed lampholder.
-  Power Cable use only with the Camera Model: GC100KU. Class 2 output connections are not intended for supporting products or appliances.
-  Use only the Power Cable packaged with the Camera Model: GC100KU. The Smart Socket Adapter and Power Cable may become warm during normal use. Always allow adequate ventilation around the Smart Socket Adapter and Power Cable and use care when handling. Unplug the device if any of the following conditions exist:
  - The Power Cable or Smart Socket Adapter has become frayed or damaged
  - The Power Connector or Smart Socket Adapter is exposed to rain, liquid, or excessive moisture
  - The Power Cable or Smart Socket Adapter has become damaged
  - You suspect the Power Cable or Smart Socket Adapter needs service or repair
  - You want to clean the Power Cable or Smart Socket Adapter
  - Class 2 output connections are not intended for supporting products or appliances

### SAVE THESE INSTRUCTIONS

### FCC Statement

Warning: Changes or modifications to this unit not expressly approved by the party responsible for compliance could void the user's authority to operate the equipment.

NOTE: This equipment has been tested and found to comply with the limits for a Class B digital device, pursuant to Part 15 of the FCC Rules. These limits are designed to provide reasonable protection against harmful interference in a residential installation. This equipment generates, uses and can radiate radio frequency energy and, if not installed and used in accordance with the instructions, may cause harmful interference to radio communications.

However, there is no guarantee that interference will not occur in a particular installation. If this equipment does cause harmful interference to radio or television reception, which can be determined by turning the equipment off and on, the user is encouraged to try to correct the interference by one or more of the following measures:

- Reorient or relocate the receiving antenna.
- Increase the separation between the equipment and receiver.
- Connect the equipment into an outlet on a circuit different from that to which the receiver is connected.
- Consult the dealer or an experienced radio/ TV technician for help.

This device complies with Part 15 of the FCC Rules. Operation is subject to the following two conditions:

- (1) This device may not cause harmful interference.
- (2) This device must accept any interference received, including interference that may cause undesired operation.

The transmitter must not be co-located or operated in conjunction with any other antenna or transmitter. This equipment complies with the FCC RF radiation exposure limits set forth for an uncontrolled environment. This equipment should be installed and operated with a minimum distance of 20cm between the radiator and any part of your body.

- (i) the device for operation in the band 5150–5250 MHz is only for indoor use to reduce the potential for harmful interference to co-channel mobile satellite systems;
- (ii) for devices with detachable antenna(s), the maximum antenna gain permitted for devices in the bands 5250–5350 MHz and 5470–5725 MHz shall be such that the equipment still complies with the e.i.r.p. limit;
- (iii) the worst case tilt angle(s) necessary to remain compliant with the e.i.r.p. elevation mask requirement set forth in Section 6.2.2(3) shall be clearly indicated.

Until further notice, devices subject to this section shall not be capable of transmitting in the band 5600–5650 MHz. This restriction is for the protection of Environment Canada's weather radars operating in this band.

GC100KU FCC ID: 2AK7ELIH01  
SA010KU FCC ID: 2AK7ELIH03

C001KU FCC ID: 2AK7ELIH04  
S001KU FCC ID: 2AK7ELIH05

## IC Caution

This device complies with Industry Canada licence-exempt RSS standard(s).

Operation is subject to the following two conditions:

- (1) This device may not cause interference, and
- (2) This device must accept any interference, including interference that may cause undesired operation of the device.

The device meets the exemption from the routine evaluation limits in section 2.5 of RSS 102 and compliance with RSS-102 RF exposure, users can obtain Canadian information on RF exposure and compliance.

This transmitter must not be co-located or operating in conjunction with any other antenna or transmitter. This equipment should be installed and operated with a minimum distance of 20 centimeters between the radiator and your body.

*Le présent appareil est conforme aux CNR d'Industrie Canada applicables aux appareils radio exempts de licence. L'exploitation est autorisée aux deux conditions suivantes:*

- (1) l'appareil ne doit pas produire de brouillage, et*
- (2) l'utilisateur de l'appareil doit accepter tout brouillage radioélectrique subi, même si le brouillage est susceptible d'en compromettre le fonctionnement.*

*Le dispositif rencontre l'exemption des limites courantes d'évaluation dans la section 2.5 de RSS 102 et la conformité à l'exposition de RSS-102 rf, utilisateurs peut obtenir l'information canadienne sur l'exposition et la conformité de rf.*



*Cet émetteur ne doit pas être Co-placé ou ne fonctionnant en même temps qu'aucune autre antenne ou émetteur. Cet équipement devrait être installé et actionné avec une distance minimum de 20 centimètres entre le radiateur et votre corps.*

GC100KU IC: 22430-LIH01  
SA010KU IC: 22430-LIH03

C001KU IC: 22430-LIH04  
S001KU IC: 22430-LIH05



## Compatibility

-  Socket for use in dry or damp locations. Support up to max. 40W, E26 and standard A15 / A19 size incandescent, CFL or LED light bulb.
-  Socket requires continuous power from light fixtures. Not compatible to motion-activated light fixtures and power timer.
-  Smartphone controlled garage opener is not compatible.

For a compatible list of garage openers, light bulbs and light fixtures, visit: [www.vupointhome.com/compatibility](http://www.vupointhome.com/compatibility)

App Store is a service mark of Apple Inc., in the U.S. and other countries. Google Play badge is a trademark of Google, Inc. Use of this trademark is subject to Google Permission.

Product names, logos, brands, and other trademarks, referred to herein are the property of their respective trademark holders. All trademarks remain the property of their respective holders, and are used only to directly describe the products being provided. These trademark holders are not affiliated with VuPoint Solutions Inc. They do not sponsor or endorse VuPoint Solutions Inc. products or services.

VUcam & Garage Controller\_US Manual\_17-0310

[vupointhome.com](http://vupointhome.com)

## Compatibility

### Compatible light bulb types



For use only with max. 40W, E26 and standard A15 / A19 size Incandescent, CFL or LED light bulb.

### NOT Compatible light bulb types



Halogen, Candleabra, Triple Twin Tube, Two Prong, Globe, Motion-activated Light and others.

**!** Smart Socket Adapter for use in dry or damp locations

### Compatible light fixtures



Ceiling lamp and Wall mounted lamp.

### NOT Compatible light fixtures



Light fixtures with motion sensor or 12-hour mechanical timer.

## Installation

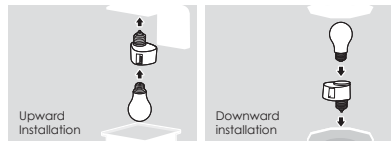

Install Smart Socket Adapter to fixture, and thread in light bulb. Disassemble the lamp sconce if necessary.

**!** Before installation, ensure the power switch is OFF or disconnect power at the fuse.

## Specifications

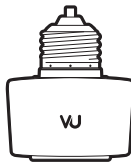

Model No.: SA010KU

Lamp Base Type	Socket type E26
Output Voltage	DC: 5V/1A
Input Voltage	120VAC, 60Hz
Lighting Control	On/Off/Light Scheduling BLE Mesh Network
Bluetooth®	Bluetooth® BLE 4.0
Light bulb	Support maximum 40W, A15/A19 size Incandescent, CFL or LED light bulb Recommended LED light bulb (not included)
Dimensions (L x W x H)	2.4" x 2.0" x 2.5"
Operating Temperature	-4°F - 113°F

## Regulations and Compliance

### IMPORTANT SAFETY INSTRUCTIONS

Please adhere to the following safety instructions. Failure to follow the instructions outlined in the user's manual may lead to serious personal injury and possible property damage.

- !** Smart Socket Adapter DC power output max. up to 5W.  
The Smart Socket Adapter must be installed in the listed lampholder.
- !** Class 2 output connections are not intended for supporting products or appliances.
- !** The Smart Socket Adapter may become warm during normal use. Always allow adequate ventilation around the Smart Socket Adapter and use care when handling.  
Unplug the device if any of the following conditions exist:
  - The Smart Socket Adapter has become frayed or damaged
  - The Smart Socket Adapter is exposed to rain, liquid, or excessive moisture
  - The Smart Socket Adapter has become damaged
  - You suspect the Smart Socket Adapter needs service or repair
  - You want to clean the Smart Socket Adapter
  - Class 2 output connections are not intended for supporting products or appliances

SAVE THESE INSTRUCTIONS

Smart Socket Adapter\_US Manual\_17-0310