



FCC RADIO TEST REPORT

FCC ID: 2AK77W1

Product: DashCam

Trade Mark: N/A

Model No.: W1

Family Model: N/A

Report No.: S18103001301E003

Issue Date: 11 Dec. 2018

Prepared for

Shenzhen Yuetu Network Technology Ltd.
3/F, Yinjin Industrial Park, Liuxian 2 Road, Bao'an District, Shenzhen,
Guangdong, China

Prepared by

Shenzhen NTEK Testing Technology Co., Ltd.
1/F, Building E, Fenda Science Park, Sanwei Community,
Xixiang Street Bao'an District, Shenzhen 518126 P.R. China
Tel.: +86-755-6115 6588
Fax.: +86-755-6115 6599
Website:<http://www.ntek.org.cn>

TABLE OF CONTENTS

1	TEST RESULT CERTIFICATION	3
2	SUMMARY OF TEST RESULTS	4
3	FACILITIES AND ACCREDITATIONS	5
3.1	FACILITIES	5
3.2	LABORATORY ACCREDITATIONS AND LISTINGS	5
3.3	MEASUREMENT UNCERTAINTY	5
4	GENERAL DESCRIPTION OF EUT	6
5	DESCRIPTION OF TEST MODES	8
6	SETUP OF EQUIPMENT UNDER TEST	10
6.1	BLOCK DIAGRAM CONFIGURATION OF TEST SYSTEM	10
6.2	SUPPORT EQUIPMENT	11
6.3	EQUIPMENTS LIST FOR ALL TEST ITEMS	12
7	TEST REQUIREMENTS	14
7.1	CONDUCTED EMISSIONS TEST	14
7.2	RADIATED SPURIOUS EMISSION	19
7.3	6DB BANDWIDTH	28
7.4	DUTY CYCLE	32
7.5	MAXIMUM OUTPUT POWER	34
7.6	POWER SPECTRAL DENSITY	36
7.7	CONDUCTED BAND EDGE MEASUREMENT	40
7.8	SPURIOUS RF CONDUCTED EMISSIONS	44
7.9	ANTENNA APPLICATION	57

1 TEST RESULT CERTIFICATION

Applicant's name	Shenzhen Yuetu Network Technology Ltd.
Address	3/F, Yinjin Industrial Park, Liuxian 2 Road, Bao'an District, Shenzhen, Guangdong, China
Manufacturer's Name	Shenzhen Yuetu Network Technology Ltd.
Address	3/F, Yinjin Industrial Park, Liuxian 2 Road, Bao'an District, Shenzhen, Guangdong, China
Product description	
Product name	DashCam
Model and/or type reference	W1
Family Model	N/A

Measurement Procedure Used:

APPLICABLE STANDARDS	
APPLICABLE STANDARD/ TEST PROCEDURE	TEST RESULT
FCC 47 CFR Part 2, Subpart J FCC 47 CFR Part 15, Subpart C KDB 174176 D01 Line Conducted FAQ v01r01 ANSI C63.10-2013 KDB 558074 D01 15.247 Meas Guidance v05	Complied

This device described above has been tested by Shenzhen NTEK Testing Technology Co., Ltd., and the test results show that the equipment under test (EUT) is in compliance with the FCC requirements. And it is applicable only to the tested sample identified in the report.

This report shall not be reproduced except in full, without the written approval of Shenzhen NTEK Testing Technology Co., Ltd., this document may be altered or revised by Shenzhen NTEK Testing Technology Co., Ltd., personnel only, and shall be noted in the revision of the document.

The test results of this report relate only to the tested sample identified in this report.

Date of Test : 10 Nov. 2018 ~ 11 Dec. 2018

Testing Engineer : Loren Luo
(Loren Luo)

Technical Manager : Jason Chen
(Jason Chen)

Authorized Signatory : Sam Chen
(Sam Chen)

2 SUMMARY OF TEST RESULTS

FCC Part15 (15.247), Subpart C			
Standard Section	Test Item	Verdict	Remark
15.207	Conducted Emission	PASS	
15.247 (a)(2)	6dB Bandwidth	PASS	
15.247 (b)	Maximum Output Power	PASS	
15.209 (a) 15.205 (a)	Radiated Spurious Emission	PASS	
15.247 (d)	Power Spectral Density	PASS	
15.247 (d)	Band Edge Emission	PASS	
15.247 (d)	Spurious RF Conducted Emission	PASS	
15.203	Antenna Requirement	PASS	

Remark:

1. "N/A" denotes test is not applicable in this Test Report.
2. All test items were verified and recorded according to the standards and without any deviation during the test.

3 FACILITIES AND ACCREDITATIONS

3.1 FACILITIES

All measurement facilities used to collect the measurement data are located at 1/F, Building E, Fenda Science Park, Sanwei Community, Xixiang Street, Bao'an District, Shenzhen 518126 P.R. China.

The sites are constructed in conformance with the requirements of ANSI C63.7, ANSI C63.10 and CISPR Publication 22.

3.2 LABORATORY ACCREDITATIONS AND LISTINGS

Site Description

CNAS-Lab. : The Laboratory has been assessed and proved to be in compliance with CNAS-CL01:2006 (identical to ISO/IEC 17025:2005)
The Certificate Registration Number is L5516.

IC-Registration The Certificate Registration Number is 9270A-1.

FCC- Accredited Test Firm Registration Number: 463705.
Designation Number: CN1184

A2LA-Lab. The Certificate Registration Number is 4298.01
This laboratory is accredited in accordance with the recognized International Standard ISO/IEC 17025:2005 General requirements for the competence of testing and calibration laboratories.
This accreditation demonstrates technical competence for a defined scope and the operation of a laboratory quality management system (refer to joint ISO-ILAC-IAF Communiqué dated 8 January 2009).

Name of Firm : Shenzhen NTEK Testing Technology Co., Ltd.

Site Location : 1/F, Building E, Fenda Science Park, Sanwei Community, Xixiang Street, Bao'an District, Shenzhen 518126 P.R. China.

2.3 MEASUREMENT UNCERTAINTY

The reported uncertainty of measurement $y \pm U$, where expanded uncertainty U is based on a standard uncertainty multiplied by a coverage factor of $k=2$, providing a level of confidence of approximately 95 %.

No.	Item	Uncertainty
1	Conducted Emission Test	$\pm 2.80\text{dB}$
2	RF power, conducted	$\pm 0.16\text{dB}$
3	Spurious emissions, conducted	$\pm 0.21\text{dB}$
4	All emissions, radiated(30MHz~1GHz)	$\pm 2.64\text{dB}$
5	All emissions, radiated(1GHz~6GHz)	$\pm 2.40\text{dB}$
6	All emissions, radiated(>6GHz)	$\pm 2.52\text{dB}$
7	Temperature	$\pm 0.5^\circ\text{C}$
8	Humidity	$\pm 2\%$

4 GENERAL DESCRIPTION OF EUT

Product Feature and Specification	
Equipment	DashCam
Trade Mark	N/A
FCC ID	2AK77W1
Model No.	W1
Family Model	N/A
Model Difference	N/A
Operating Frequency	2412-2462MHz for 802.11b/g/11n(HT20); 2422-2452MHz for 802.11n(HT40);
Modulation	DSSS with DBPSK/DQPSK/CCK for 802.11b; OFDM with BPSK/QPSK/16QAM/64QAM for 802.11g/n;
Number of Channels	11 channels for 802.11b/g/11n(HT20); 7 channels for 802.11n(HT40);
Antenna Type	FPCB Antenna
Antenna Gain	1.9 dBi
Power supply	<input checked="" type="checkbox"/> DC supply: DC 3.7V/480mAh from Battery or DC 5V from USB Port.
	<input checked="" type="checkbox"/> Adapter supply: Model:C001 Input: DC 12V/24V Output: DC 5V 1A/1A
HW Version	YT_miniplus_main_v0.6_BT
SW Version	3.3.14

Note: Based on the application, features, or specification exhibited in User's Manual, the EUT is considered as an ITE/Computing Device. More details of EUT technical specification, please refer to the User's Manual.

5 DESCRIPTION OF TEST MODES

To investigate the maximum EMI emission characteristics generates from EUT, the test system was pre-scanning tested base on the consideration of following EUT operation mode or test configuration mode which possible have effect on EMI emission level. Each of these EUT operation mode(s) or test configuration mode(s) mentioned above was evaluated respectively.

The Transmitter was operated in the normal operating mode. The TX frequency was fixed which was for the purpose of the measurements.

Test of channel included the lowest and middle and highest frequency to perform the test, then record on this report.

Those data rates (802.11b: 1 Mbps; 802.11g: 6 Mbps; 802.11n (HT20): MCS0; 802.11n (HT40): MCS0) were used for all test.

The EUT was pretested with 3 orientations placed on the table for the radiated emission measurement –X, Y, and Z-plane. The Y-plane results were found as the worst case and were shown in this report.

Frequency and Channel list for 802.11b/g/n (HT20/HT40):

Channel	Frequency(MHz)
1	2412
2	2417
...	...
5	2432
6	2437
...	...
10	2457
11	2462

Note: $f_c=2412\text{MHz}+(k-1)\times 5\text{MHz}$ $k=1$ to 11

AC power line Conducted Emission was tested under maximum output power.

Test Mode:

Test Items	Mode	Data Rate	Channel	Ant
AC Power Line Conducted Emissions	Normal Link	-	-	-
Maximum Conducted Output Power	11b/CCK	1 Mbps	1/6/11	1
	11g/BPSK	6 Mbps	1/6/11	1
	11n HT20	MCS0	1/6/11	1
	11n HT40	MCS0	3/6/9	1
Power Spectral Density	11b/CCK	1 Mbps	1/6/11	1
	11g/BPSK	6 Mbps	1/6/11	1
	11n HT20	MCS0	1/6/11	1
	11n HT40	MCS0	3/6/9	1
6dB Spectrum Bandwidth	11b/CCK	1 Mbps	1/6/11	1
	11g/BPSK	6 Mbps	1/6/11	1
	11n HT20	MCS0	1/6/11	1
	11n HT40	MCS0	3/6/9	1
Radiated Emissions Below 1GHz	Normal Link	-	-	-
Radiated Emissions Above 1GHz	11b/CCK	1 Mbps	1/6/11	1
	11g/BPSK	6 Mbps	1/6/11	1
	11n HT20	MCS0	1/6/11	1
	11n HT40	MCS0	3/6/9	1
Band Edge Emissions	11b/CCK	1 Mbps	1/6/11	1
	11g/BPSK	6 Mbps	1/6/11	1
	11n HT20	MCS0	1/6/11	1
	11n HT40	MCS0	3/6/9	1

6 SETUP OF EQUIPMENT UNDER TEST

6.1 BLOCK DIAGRAM CONFIGURATION OF TEST SYSTEM

For AC Conducted Emission Mode

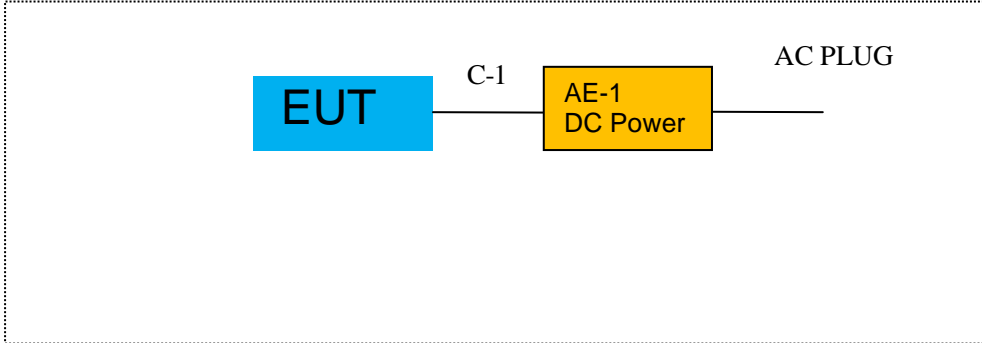

For Radiated Test Cases



For Conducted Test Cases

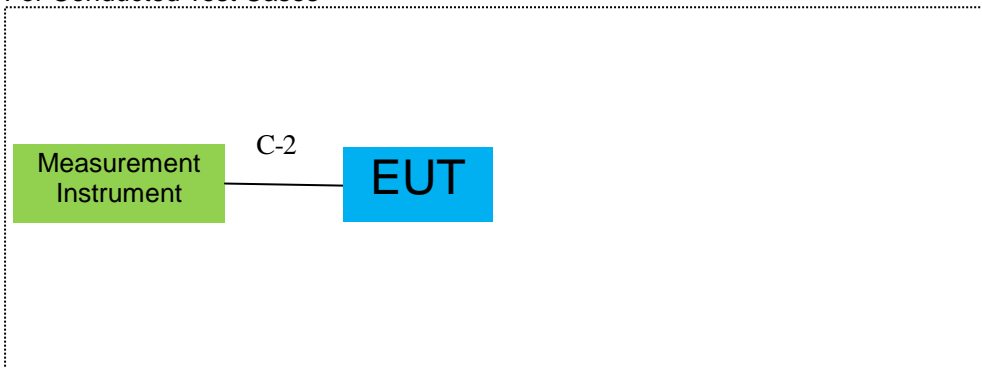

Note:1.The temporary antenna connector is soldered on the PCB board in order to perform conducted tests and this temporary antenna connector is listed in the equipment list.
 2.EUT built-in battery-powered, the battery is fully-charged.

6.2 SUPPORT EQUIPMENT

The EUT has been tested as an independent unit together with other necessary accessories or support units. The following support units or accessories were used to form a representative test configuration during the tests.

Item	Equipment	Mfr/Brand	Model/Type No.	Series No.	Note
AE-1	DC Power	N/A	N/A	N/A	

Item	Cable Type	Shielded Type	Ferrite Core	Length
C-1	DC Cable	NO	NO	0.5m
C-2	RF Cable	YES	NO	0.1m

Notes:

- (1) The support equipment was authorized by Declaration of Confirmation.
- (2) For detachable type I/O cable should be specified the length in cm in 『Length』 column.
- (3) “YES” is means “shielded” “with core”; “NO” is means “unshielded” “without core”.

6.3 EQUIPMENTS LIST FOR ALL TEST ITEMS

Radiation& Conducted Test equipment

Item	Kind of Equipment	Manufacturer	Type No.	Serial No.	Last calibration	Calibrated until	Calibration period
1	Spectrum Analyzer	Agilent	E4407B	MY45108040	2018.05.19	2019.05.18	1 year
2	Spectrum Analyzer	Agilent	N9020A	MY49100060	2018.10.08	2019.10.07	1 year
3	Spectrum Analyzer	R&S	FSV40	101417	2018.10.08	2019.10.07	1 year
4	Test Receiver	R&S	ESPI7	101318	2018.05.19	2019.05.18	1 year
5	Bilog Antenna	TESEQ	CBL6111D	31216	2018.04.08	2019.04.07	1 year
6	50Ω Coaxial Switch	Anritsu	MP59B	6200983705	2018.05.19	2020.05.18	2 year
7	Horn Antenna	EM	EM-AH-10180	2011071402	2018.04.08	2019.04.07	1 year
8	Broadband Horn Antenna	SCHWARZBECK	BBHA 9170	803	2018.11.03	2019.11.02	1 year
9	Amplifier	EMC	EMC051835SE	980246	2018.08.05	2019.08.04	1 year
10	Active Loop Antenna	SCHWARZBECK	FMZB 1519B	055	2018.11.03	2019.11.02	1 year
11	Power Meter	DARE	RPR3006W	15I00041SN084	2018.08.05	2019.08.04	1 year
12	Test Cable (9KHz-30MHz)	N/A	R-01	N/A	2017.04.21	2020.04.20	3 year
13	Test Cable (30MHz-1GHz)	N/A	R-02	N/A	2017.04.21	2020.04.20	3 year
14	High Test Cable(1G-40G Hz)	N/A	R-03	N/A	2017.04.21	2020.04.20	3 year
15	High Test Cable(1G-40G Hz)	N/A	R-04	N/A	2017.04.21	2020.04.20	3 year
16	Filter	TRILTHIC	2400MHz	29	2017.04.19	2020.04.18	3 year
17	temporary antenna connector (Note)	NTS	R001	N/A	N/A	N/A	N/A

Note:

We will use the temporary antenna connector (soldered on the PCB board) When conducted test
 And this temporary antenna connector is listed within the instrument list

AC Conduction Test equipment

Item	Kind of Equipment	Manufacturer	Type No.	Serial No.	Last calibration	Calibrated until	Calibration period
1	Test Receiver	R&S	ESCI	101160	2018.05.19	2019.05.18	1 year
2	LISN	R&S	ENV216	101313	2018.04.18	2019.04.19	1 year
3	LISN	SCHWARZBECK	NNLK 8129	8129245	2018.05.19	2019.05.18	1 year
4	50Ω Coaxial Switch	ANRITSU CORP	MP59B	6200983704	2018.05.19	2020.05.18	2 year
5	Test Cable (9KHz-30MHz)	N/A	C01	N/A	2017.04.21	2020.04.20	3 year
6	Test Cable (9KHz-30MHz)	N/A	C02	N/A	2017.04.21	2020.04.20	3 year
7	Test Cable (9KHz-30MHz)	N/A	C03	N/A	2017.04.21	2020.04.20	3 year

Note: Each piece of equipment is scheduled for calibration once a year except the Aux Equipment & Test Cable which is scheduled for calibration every 2 or 3 years.

7.1.6 Test Results

EUT:	DashCam	Model Name :	W1
Temperature:	26 °C	Relative Humidity:	54%
Pressure:	1010hPa	Phase :	L
Test Voltage :	DC 12V from DC Power AC 120V/60Hz	Test Mode:	Mode 1

Frequency (MHz)	Reading Level (dBμV)	Correct Factor (dB)	Measure-ment (dBμV)	Limits (dBμV)	Margin (dB)	Remark
0.1859	35.35	9.82	45.17	64.21	-19.04	QP
0.1859	13.54	9.82	23.36	54.21	-30.85	AVG
0.2099	29.24	9.82	39.06	63.21	-24.15	QP
0.2099	16.83	9.82	26.65	53.21	-26.56	AVG
0.2858	27.52	9.82	37.34	60.64	-23.30	QP
0.2858	15.76	9.82	25.58	50.64	-25.06	AVG
0.5540	20.08	9.83	29.91	56.00	-26.09	QP
0.5540	9.50	9.83	19.33	46.00	-26.67	AVG
4.9058	12.54	10.06	22.60	56.00	-33.40	QP
4.9058	0.19	10.06	10.25	46.00	-35.75	AVG
16.4459	12.51	10.23	22.74	60.00	-37.26	QP
16.4459	0.79	10.23	11.02	50.00	-38.98	AVG

Remark:

1. All readings are Quasi-Peak and Average values.
2. Factor = Insertion Loss + Cable Loss.

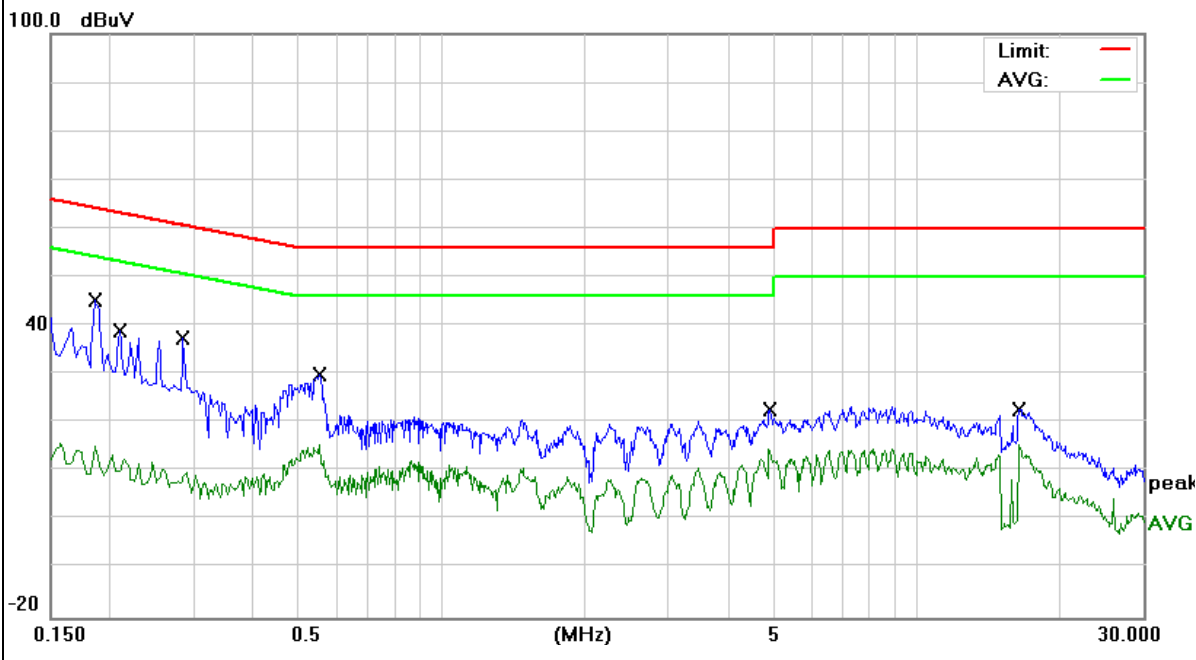

EUT:	DashCam	Model Name :	W1
Temperature:	26 °C	Relative Humidity:	54%
Pressure:	1010hPa	Phase :	N
Test Voltage :	DC 12V from DC Power AC 120V/60Hz	Test Mode:	Mode 1

Frequency (MHz)	Reading Level (dBμV)	Correct Factor (dB)	Measure-ment (dBμV)	Limits (dBμV)	Margin (dB)	Remark
0.1660	38.83	9.92	48.75	65.15	-16.40	QP
0.1660	16.67	9.92	26.59	55.15	-28.56	AVG
0.1779	36.52	9.92	46.44	64.58	-18.14	QP
0.1779	19.41	9.92	29.33	54.58	-25.25	AVG
0.5500	25.81	9.93	35.74	56.00	-20.26	QP
0.5500	18.32	9.93	28.25	46.00	-17.75	AVG
0.9818	18.32	9.93	28.25	56.00	-27.75	QP
0.9818	8.09	9.93	18.02	46.00	-27.98	AVG
1.4058	16.18	9.93	26.11	56.00	-29.89	QP
1.4058	3.39	9.93	13.32	46.00	-32.68	AVG
2.3060	14.97	9.94	24.91	56.00	-31.09	QP
2.3060	4.08	9.94	14.02	46.00	-31.98	AVG

Remark:

1. All readings are Quasi-Peak and Average values.
2. Factor = Insertion Loss + Cable Loss.

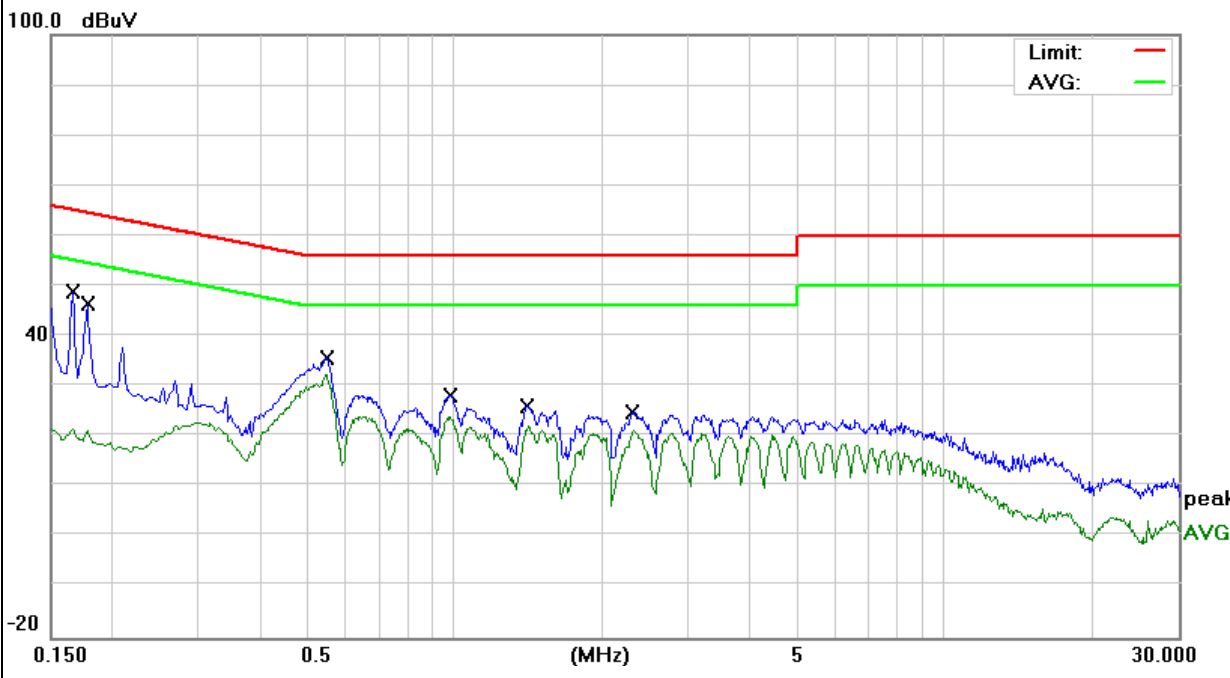

EUT:	DashCam	Model Name :	W1
Temperature:	26 °C	Relative Humidity:	54%
Pressure:	1010hPa	Phase :	L
Test Voltage :	DC 12V from DC Power AC 240V/60Hz	Test Mode:	Mode 1

Frequency (MHz)	Reading Level (dBμV)	Correct Factor (dB)	Measurement (dBμV)	Limits (dBμV)	Margin (dB)	Remark
0.4980	18.84	9.83	28.67	56.03	-27.36	QP
0.4980	5.28	9.83	15.11	46.03	-30.92	AVG
0.5660	19.74	9.83	29.57	56.00	-26.43	QP
0.5660	6.19	9.83	16.02	46.00	-29.98	AVG
1.4260	13.34	9.89	23.23	56.00	-32.77	QP
1.4260	4.44	9.89	14.33	46.00	-31.67	AVG
2.2820	13.27	9.90	23.17	56.00	-32.83	QP
2.2820	2.35	9.90	12.25	46.00	-33.75	AVG
3.0780	13.17	10.05	23.22	56.00	-32.78	QP
3.0780	3.97	10.05	14.02	46.00	-31.98	AVG
3.9620	12.69	10.05	22.74	56.00	-33.26	QP
3.9620	0.60	10.05	10.65	46.00	-35.35	AVG

Remark:

1. All readings are Quasi-Peak and Average values.
2. Factor = Insertion Loss + Cable Loss.

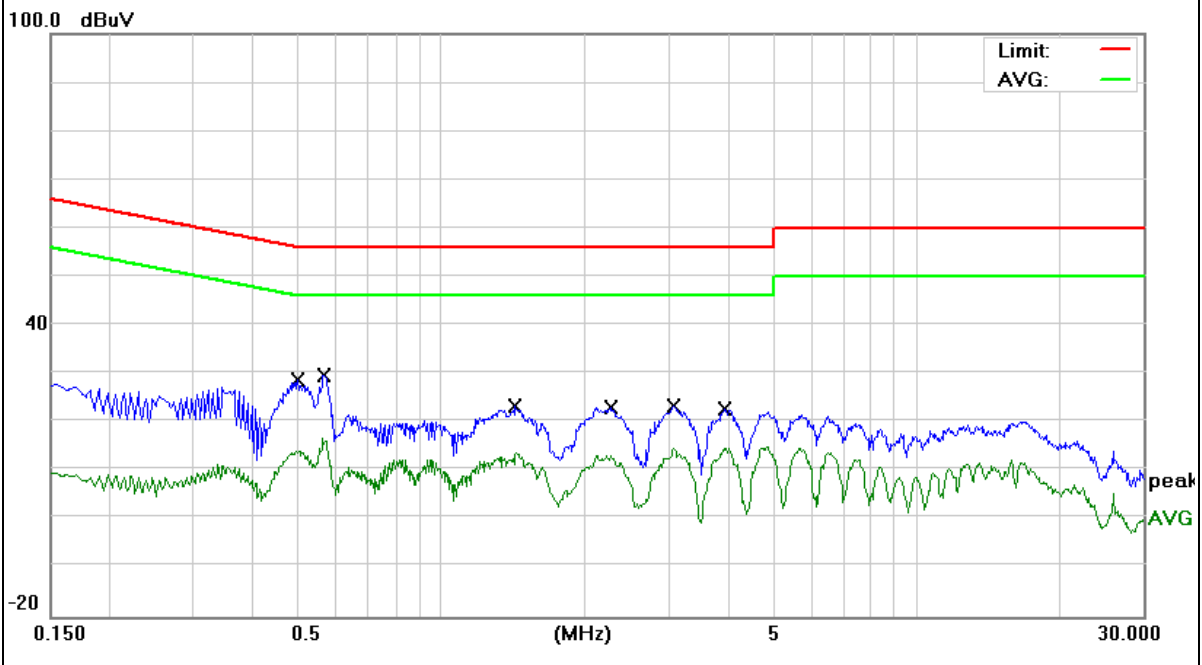

EUT:	DashCam	Model Name :	W1
Temperature:	26 °C	Relative Humidity:	54%
Pressure:	1010hPa	Phase :	N
Test Voltage :	DC 12V from DC Power AC 240V/60Hz	Test Mode:	Mode 1

Frequency (MHz)	Reading Level (dBμV)	Correct Factor (dB)	Measurement (dBμV)	Limits (dBμV)	Margin (dB)	Remark
0.4858	25.26	9.93	35.19	56.24	-21.05	QP
0.4858	12.43	9.93	22.36	46.24	-23.88	AVG
0.5620	27.75	9.93	37.68	56.00	-18.32	QP
0.5620	15.22	9.93	25.15	46.00	-20.85	AVG
0.9858	19.39	9.93	29.32	56.00	-26.68	QP
0.9858	8.18	9.93	18.11	46.00	-27.89	AVG
2.0698	18.58	9.94	28.52	56.00	-27.48	QP
2.0698	6.39	9.94	16.33	46.00	-29.67	AVG
3.0459	17.79	9.95	27.74	56.00	-28.26	QP
3.0459	5.30	9.95	15.25	46.00	-30.75	AVG
3.8060	16.94	9.95	26.89	56.00	-29.11	QP
3.8060	4.60	9.95	14.55	46.00	-31.45	AVG

Remark:

1. All readings are Quasi-Peak and Average values.
2. Factor = Insertion Loss + Cable Loss.

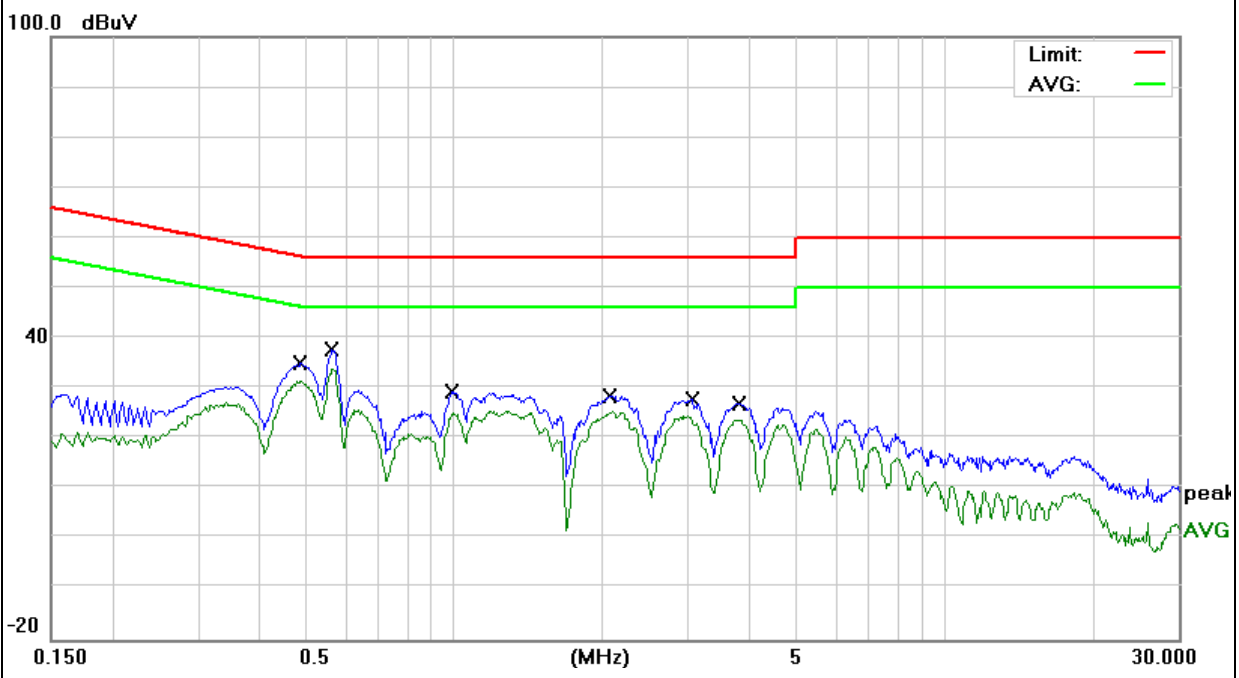

7.2 RADIATED SPURIOUS EMISSION

7.2.1 Applicable Standard

According to FCC Part 15.247(d) and 15.209 and ANSI C63.10-2013

7.2.2 Conformance Limit

According to FCC Part 15.247(d): radiated emissions which fall in the restricted bands, as defined in §15.205(a), must also comply with the radiated emission limits specified in §15.209(a) (see §15.205(c)).
According to FCC Part 15.205, Restricted bands

MHz	MHz	MHz	GHz
0.090-0.110	16.42-16.423	399.9-410	4.5-5.15
10.495-0.505	16.69475-16.69525	608-614	5.35-5.46
2.1735-2.1905	16.80425-16.80475	960-1240	7.25-7.75
4.125-4.128	25.5-25.67	1300-1427	8.025-8.5
4.17725-4.17775	37.5-38.25	1435-1626.5	9.0-9.2
4.20725-4.20775	73-74.6	1645.5-1646.5	9.3-9.5
6.215-6.218	74.8-75.2	1660-1710	10.6-12.7
6.26775-6.26825	123-138	2200-2300	14.47-14.5
8.291-8.294	149.9-150.05	2310-2390	15.35-16.2
8.362-8.366	156.52475-156.52525	2483.5-2500	17.7-21.4
8.37625-8.38675	156.7-156.9	2690-2900	22.01-23.12
8.41425-8.41475	162.0125-167.17	3260-3267	23.6-24.0
12.29-12.293	167.72-173.2	3332-3339	31.2-31.8
12.51975-12.52025	240-285	3345.8-3358	36.43-36.5
12.57675-12.57725	322-335.4	3600-4400	(2)
13.36-13.41			

20dBc in any 100 kHz bandwidth outside the operating frequency band. In case the emission fall within the restricted band specified on 15.205(a), then the 15.209(a) limit in the table below has to be followed.

Restricted Frequency(MHz)	Field Strength (μV/m)	Field Strength (dBμV/m)	Measurement Distance
0.009~0.490	2400/F(KHz)	20 log (uV/m)	300
0.490~1.705	2400/F(KHz)	20 log (uV/m)	30
1.705~30.0	30	29.5	30
30-88	100	40	3
88-216	150	43.5	3
216-960	200	46	3
Above 960	500	54	3

Limits of Radiated Emission Measurement(Above 1000MHz)

Frequency(MHz)	Class B (dBuV/m) (at 3M)	
	PEAK	AVERAGE
Above 1000	74	54

Remark :1. Emission level in dBuV/m=20 log (uV/m)
 2. Measurement was performed at an antenna to the closed point of EUT distance of meters.
 3. For Frequency 9kHz~30MHz:
 Distance extrapolation factor =40log(Specific distance/ test distance)(dB);
 Limit line=Specific limits(dBuV) + distance extrapolation factor.
 For Frequency above 30MHz:
 Distance extrapolation factor =20log(Specific distance/ test distance)(dB);
 Limit line=Specific limits(dBuV) + distance extrapolation factor.

7.2.3 Measuring Instruments

The Measuring equipment is listed in the section 6.3 of this test report.

7.2.4 Test Configuration

(a) For radiated emissions below 30MHz

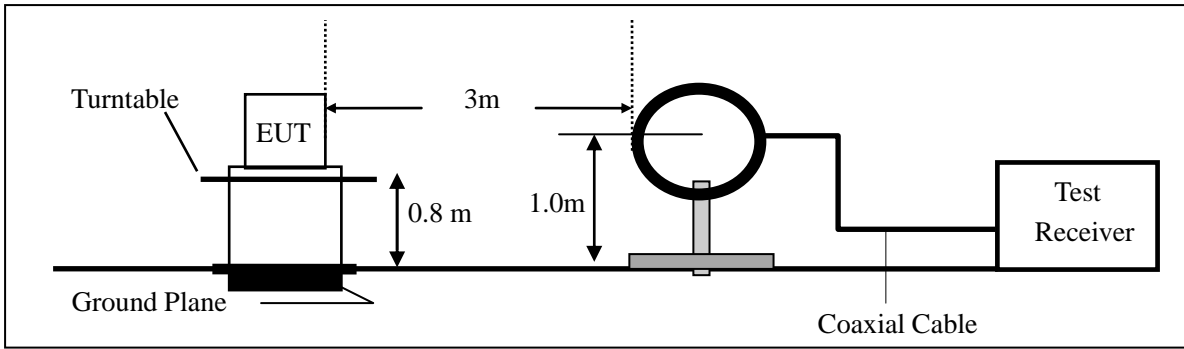

(b) For radiated emissions from 30MHz to 1000MHz

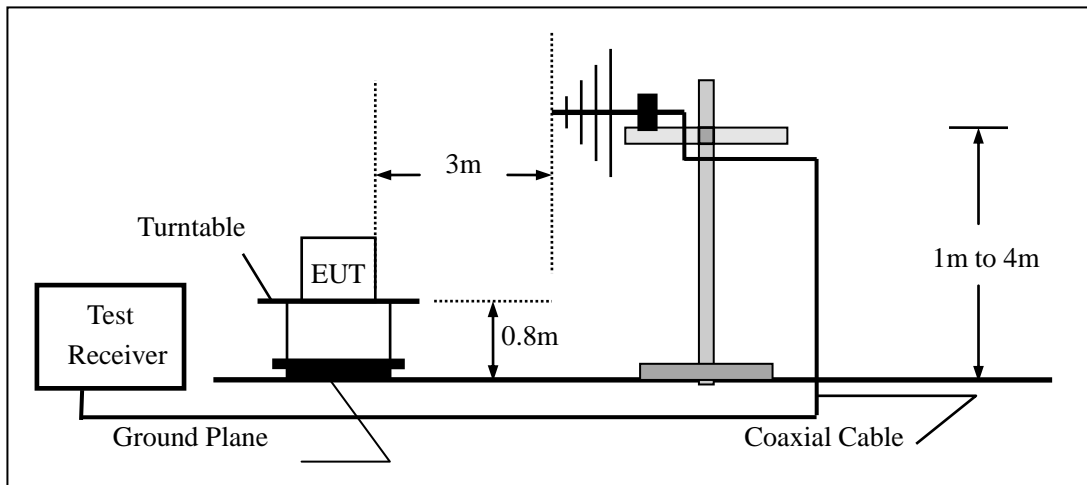

(c) For radiated emissions above 1000MHz

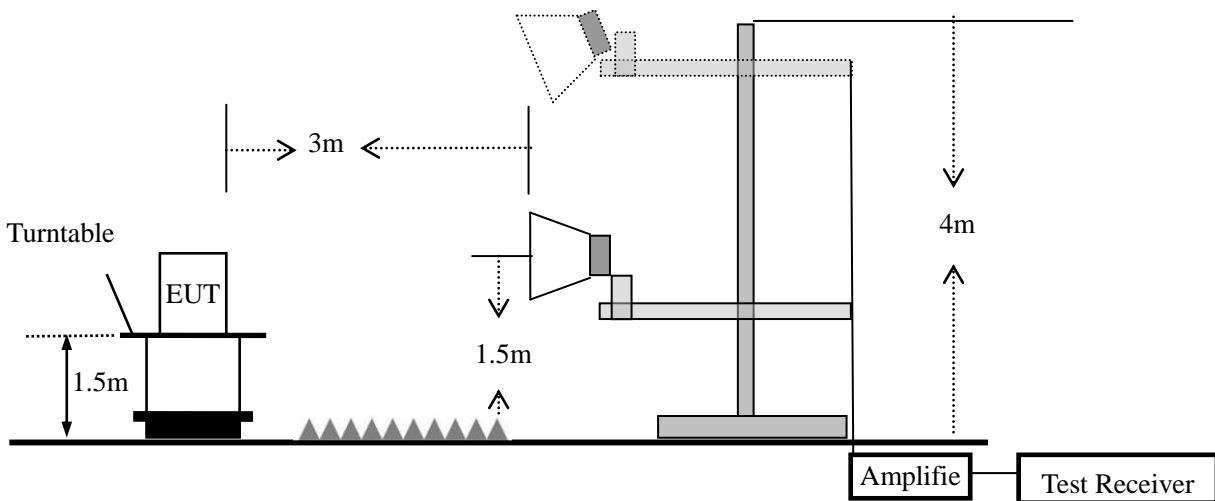

7.2.5 Test Procedure

The test site semi-anechoic chamber has met the requirement of NSA tolerance 4 dB according to the standards: ANSI C63.10-2013. The test distance is 3m. The setup is according to the requirements in Section 13.1.4.1 of ANSI C63.10-2013 and CAN/CSA-CEI/IEC CISPR 22.

This test is required for any spurious emission that falls in a Restricted Band, as defined in Section 15.205. It must be performed with the highest gain of each type of antenna proposed for use with the EUT.

Use the following spectrum analyzer settings:

Spectrum Parameter	Setting
Attenuation	Auto
Start Frequency	1000 MHz
Stop Frequency	10th carrier harmonic
RB / VB (emission in restricted band)	1 MHz / 1 MHz for Peak, 1 MHz / 10Hz for Average

Receiver Parameter	Setting
Attenuation	Auto
Start ~ Stop Frequency	9kHz~150kHz / RB 200Hz for QP
Start ~ Stop Frequency	150kHz~30MHz / RB 9kHz for QP
Start ~ Stop Frequency	30MHz~1000MHz / RB 120kHz for QP

- a. The measuring distance of at 3 m shall be used for measurements at frequency up to 1GHz and frequencies above 1GHz,
- b. The EUT was placed on the top of a rotating table 0.8 m for below 1GHz and 1.5m for above 1GHz the ground at a 3 meter. The table was rotated 360 degrees to determine the position of the highest radiation.
- c. The height of the equipment or of the substitution antenna shall be 0.8 m for below 1GHz and 1.5m for above 1GHz; the height of the test antenna shall vary between 1 m to 4 m. Both horizontal and vertical polarizations of the antenna are set to make the measurement.
- d. For the radiated emission test above 1GHz:
Place the measurement antenna away from each area of the EUT determined to be a source of emissions at the specified measurement distance, while keeping the measurement antenna aimed at the source of emissions at each frequency of significant emissions, with polarization oriented for maximum response. The measurement antenna may have to be higher or lower than the EUT, depending on the radiation pattern of the emission and staying aimed at the emission source for receiving the maximum signal. The final measurement antenna elevation shall be that which maximizes the emissions. The measurement antenna elevation for maximum emissions shall be restricted to a range of heights of from 1 m to 4 m above the ground or reference ground plane.
- e. The initial step in collecting conducted emission data is a spectrum analyzer peak detector mode pre-scanning the measurement frequency range. Significant peaks are then marked and then Quasi Peak detector mode re-measured.
- f. If the Peak Mode measured value compliance with and lower than Quasi Peak Mode Limit, the EUT shall be deemed to meet QP Limits and then no additional QP Mode measurement performed.
- g. For the actual test configuration, please refer to the related Item –EUT Test Photos.

Note:

Both horizontal and vertical antenna polarities were tested and performed pretest to three orthogonal axis. The worst case emissions were reported

During the radiated emission test, the Spectrum Analyzer was set with the following configurations:

For peak measurement:

Set RBW=100 kHz for $f < 1$ GHz; $VBW \geq RBW$; Sweep = auto; Detector function = peak; Trace = max hold;

Set RBW = 1 MHz, VBW= 3MHz for $f \geq 1$ GHz

For average measurement:

VBW = 10 Hz, when duty cycle is no less than 98 percent.

$VBW \geq 1/T$, when duty cycle is less than 98 percent where T is the minimum transmission duration over which the transmitter is on and is transmitting at its maximum power control level for the tested mode of

operation.

Note: for the frequency ranges below 30 MHz, a narrower RBW is used for these ranges but the measured value should add a RBW correction factor (RBWCF) where $RBWCF [dB] = 10 \cdot \lg(100 [kHz]/\text{narrower RBW [kHz]})$. , the narrower RBW is 1 kHz and RBWCF is 20 dB for the frequency 9 kHz to 150 kHz, and the narrower RBW is 10 kHz and RBWCF is 10 dB for the frequency 150 kHz to 30 MHz.

7.2.6 Test Results

■ Spurious Emission below 30MHz (9KHz to 30MHz)

EUT:	DashCam	Model No.:	W1
Temperature:	20 °C	Relative Humidity:	48%
Test Mode:	Mode2/Mode3/Mode4/Mode5	Test By:	Loren Luo

Freq. (MHz)	Ant.Pol. H/V	Emission Level(dBuV/m)		Limit 3m(dBuV/m)		Over(dB)	
		PK	AV	PK	AV	PK	AV
--	--	--	--	--	--	--	--

Note: the amplitude of spurious emission that is attenuated by more than 20dB below the permissible limit has no need to be reported.

- Spurious Emission below 1GHz (30MHz to 1GHz)
All the modulation modes have been tested, and the worst result was report as below:

EUT:	DashCam	Model Name :	W1
Temperature:	20 °C	Relative Humidity:	48%
Pressure:	1010hPa	Test Mode:	Normal Link
Test Voltage :	DC 3.7V		

Polar (H/V)	Frequency	Meter Reading	Factor	Emission Level	Limits	Margin	Remark
	(MHz)	(dBuV)	(dB)	(dBuV/m)	(dBuV/m)	(dB)	
V	30.9619	13.76	20.79	34.55	40.00	-5.45	QP
V	33.4448	14.48	19.64	34.12	40.00	-5.88	QP
V	51.1209	17.51	13.30	30.81	40.00	-9.19	QP
V	60.7044	21.44	10.64	32.08	40.00	-7.92	QP
V	78.1389	17.54	11.55	29.09	40.00	-10.91	QP
V	121.1231	13.74	10.61	24.35	43.50	-19.15	QP

Remark:

Absolute Level= ReadingLevel+ Factor, Margin= Absolute Level - Limit

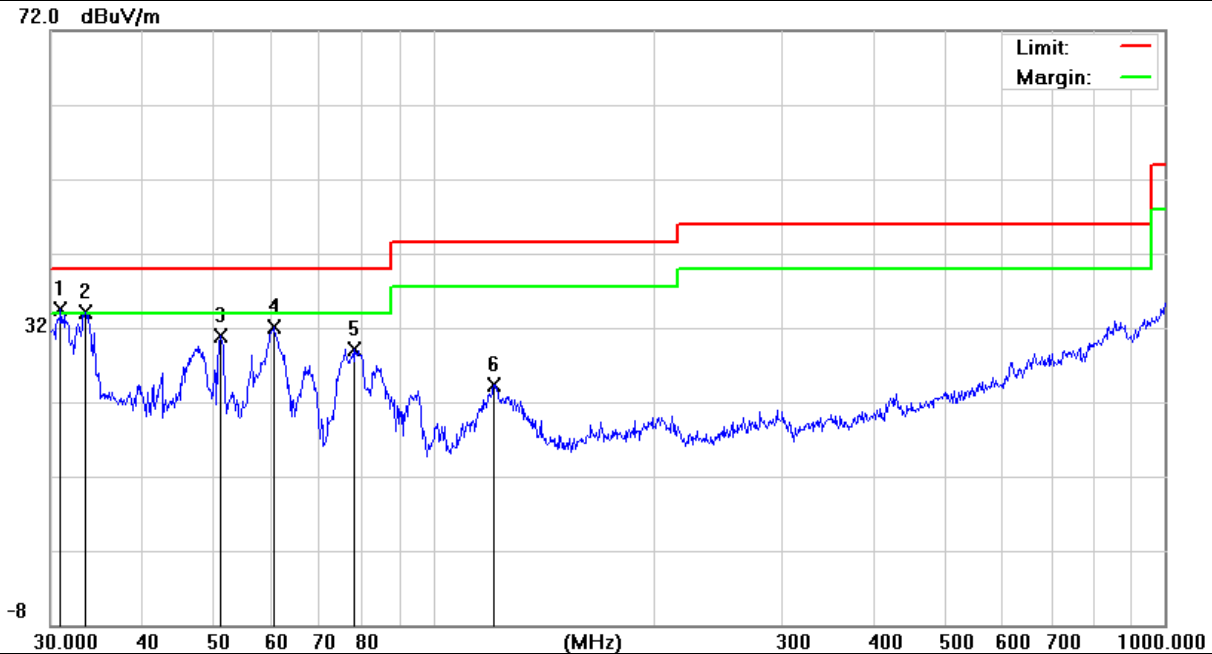

Polar (H/V)	Frequency	Meter Reading	Factor	Emission Level	Limits	Margin	Remark
	(MHz)	(dBuV)	(dB)	(dBuV/m)	(dBuV/m)	(dB)	
H	128.5630	13.48	10.52	24.00	43.50	-19.50	QP
H	185.7882	9.75	12.70	22.45	43.50	-21.05	QP
H	323.3204	10.32	13.57	23.89	46.00	-22.11	QP
H	435.5898	7.71	16.26	23.97	46.00	-22.03	QP
H	656.5300	6.91	20.88	27.79	46.00	-18.21	QP
H	854.0247	8.09	25.78	33.87	46.00	-12.13	QP

Remark:

Absolute Level= ReadingLevel+ Factor, Margin= Absolute Level - Limit

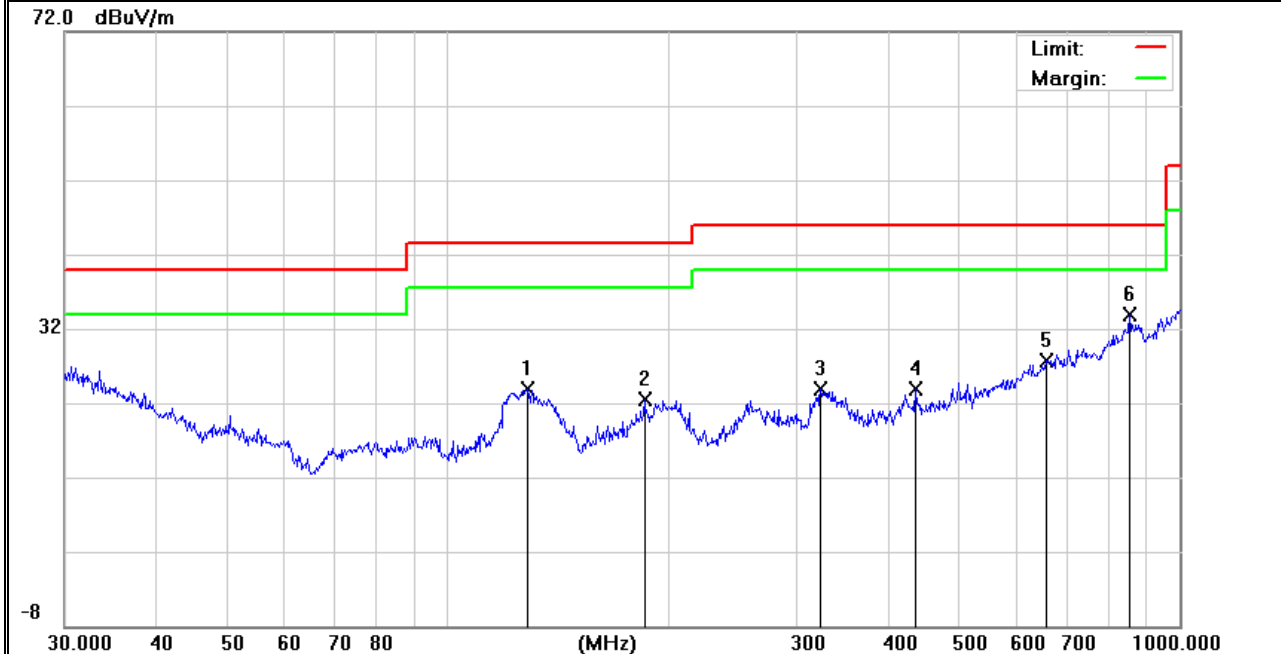

■ Spurious Emission Above 1GHz (1GHz to 25GHz)

EUT:	DashCam	Model No.:	W1
Temperature:	20 °C	Relative Humidity:	48%
Test Mode:	802.11b/g/n20/n40	Test By:	Loren Luo

All the modulation modes have been tested, and the worst result was report as below:

Frequency (MHz)	Read Level (dBμV)	Cable loss (dB)	Antenna Factor dB/m	Preamp Factor (dB)	Emission Level (dBμV/m)	Limits (dBμV/m)	Margin (dB)	Remark	Comment
Low Channel (2412 MHz)(802.11b)--Above 1G									
4824.008	61.59	5.21	35.59	44.30	58.09	74.00	-15.91	Pk	Vertical
4824.008	44.47	5.21	35.59	44.30	40.97	54.00	-13.03	AV	Vertical
7236.184	65.58	6.48	36.27	44.60	63.73	74.00	-10.27	Pk	Vertical
7236.184	47.81	6.48	36.27	44.60	45.96	54.00	-8.04	AV	Vertical
4824	62.56	5.21	35.55	44.30	59.02	74.00	-14.98	Pk	Horizontal
4824	43.95	5.21	35.55	44.30	40.41	54.00	-13.59	AV	Horizontal
7236.103	60.58	6.48	36.27	44.52	58.81	74.00	-15.19	Pk	Horizontal
7236.103	43.11	6.48	36.27	44.52	41.34	54.00	-12.66	AV	Horizontal
Middle Channel (2437 MHz)(802.11b)--Above 1G									
4874.293	65.95	5.21	35.66	44.20	62.62	74.00	-11.38	Pk	Vertical
4874.293	46.85	5.21	35.66	44.20	43.52	54.00	-10.48	AV	Vertical
7311.107	62.87	7.10	36.50	44.43	62.04	74.00	-11.96	Pk	Vertical
7311.107	44.14	7.10	36.50	44.43	43.31	54.00	-10.69	AV	Vertical
4874.085	66.75	5.21	35.66	44.20	63.42	74.00	-10.58	Pk	Horizontal
4874.085	45.18	5.21	35.66	44.20	41.85	54.00	-12.15	AV	Horizontal
7311.179	63.25	7.10	36.50	44.43	62.42	74.00	-11.58	Pk	Horizontal
7311.179	43.77	7.10	36.50	44.43	42.94	54.00	-11.06	AV	Horizontal
High Channel (2462 MHz)(802.11b)--Above 1G									
4924.226	62.59	5.21	35.52	44.21	59.11	74.00	-14.89	Pk	Vertical
4924.226	62.53	5.21	35.52	44.21	59.05	54.00	5.05	AV	Vertical
7386.158	64.54	7.10	36.53	44.60	63.57	74.00	-10.43	Pk	Vertical
7386.158	43.49	7.10	36.53	44.60	42.52	54.00	-11.48	AV	Vertical
4924.427	64.84	5.21	35.52	44.21	61.36	74.00	-12.64	Pk	Horizontal
4924.427	43.67	5.21	35.52	44.21	40.19	54.00	-13.81	AV	Horizontal
7386.335	67.48	7.10	36.53	44.60	66.51	74.00	-7.49	Pk	Horizontal
7386.335	46.39	7.10	36.53	44.60	45.42	54.00	-8.58	AV	Horizontal

Note:

- (1) Emission Level= Antenna Factor + Cable Loss + Read Level - Preamp Factor
- (2) Data of measurement within this frequency range shown "--" in the table above means the reading of emissions are attenuated more than 20dB below the permissible limits or the field strength is too small to be measured.
- (3)"802.11b" mode is the worst mode. When PK value is lower than the Average value limit, average don't record.

■ Spurious Emission in Restricted Band 2310MHz -18000MHz

All the modulation modes have been tested, and the worst result was report as below:

Frequency (MHz)	Meter Reading (dBμV)	Cable Loss (dB)	Antenna Factor (dB/m)	Preamp Factor (dB)	Emission Level (dBμV/m)	Limits (dBμV/m)	Margin (dB)	Detector Type	Comment
802.11b									
2310.00	62.59	2.97	27.21	43.80	48.97	74	-25.03	Pk	Horizontal
2310.00	44.41	2.97	27.21	43.80	30.79	54	-23.21	AV	Horizontal
2310.00	65.58	2.97	27.21	43.80	51.96	74	-22.04	Pk	Vertical
2310.00	46.63	2.97	27.21	43.80	33.01	54	-20.99	AV	Vertical
2390.00	62.85	3.14	27.33	43.80	49.52	74	-24.48	Pk	Vertical
2390.00	45.12	3.14	27.33	43.80	31.79	54	-22.21	AV	Vertical
2390.00	68.95	3.14	27.33	43.80	55.62	74	-18.38	Pk	Horizontal
2390.00	46.63	3.14	27.33	43.80	33.30	54	-20.70	AV	Horizontal
2483.50	65.52	3.58	27.70	44.00	52.80	74	-21.20	Pk	Vertical
2483.50	43.62	3.58	27.70	44.00	30.90	54	-23.10	AV	Vertical
2483.50	64.11	3.58	27.70	44.00	51.39	74	-22.61	Pk	Horizontal
2483.50	45.52	3.58	27.70	44.00	32.80	54	-21.20	AV	Horizontal
802.11g									
2310.00	66.67	2.97	27.21	43.80	53.05	74	-20.95	Pk	Horizontal
2310.00	45.59	2.97	27.21	43.80	31.97	54	-22.03	AV	Horizontal
2310.00	68.52	2.97	27.21	43.80	54.90	74	-19.10	Pk	Vertical
2310.00	43.62	2.97	27.21	43.80	30.00	54	-24.00	AV	Vertical
2390.00	68.85	3.14	27.33	43.80	55.52	74	-18.48	Pk	Vertical
2390.00	44.41	3.14	27.33	43.80	31.08	54	-22.92	AV	Vertical
2390.00	62.59	3.14	27.33	43.80	49.26	74	-24.74	Pk	Horizontal
2390.00	43.47	3.14	27.33	43.80	30.14	54	-23.86	AV	Horizontal
2483.50	65.52	3.58	27.70	44.00	52.80	74	-21.20	Pk	Vertical
2483.50	46.59	3.58	27.70	44.00	33.87	54	-20.13	AV	Vertical
2483.50	65.57	3.58	27.70	44.00	52.85	74	-21.15	Pk	Horizontal
2483.50	47.41	3.58	27.70	44.00	34.69	54	-19.31	AV	Horizontal
802.11n20									
2310.00	67.52	2.97	27.21	43.80	53.90	74	-20.10	Pk	Horizontal
2310.00	46.95	2.97	27.21	43.80	33.33	54	-20.67	AV	Horizontal
2310.00	67.48	2.97	27.21	43.80	53.86	74	-20.14	Pk	Vertical
2310.00	46.52	2.97	27.21	43.80	32.90	54	-21.10	AV	Vertical
2390.00	62.21	3.14	27.33	43.80	48.88	74	-25.12	Pk	Vertical
2390.00	45.59	3.14	27.33	43.80	32.26	54	-21.74	AV	Vertical
2390.00	63.35	3.14	27.33	43.80	50.02	74	-23.98	Pk	Horizontal
2390.00	47.74	3.14	27.33	43.80	34.41	54	-19.59	AV	Horizontal
2483.50	68.52	3.58	27.70	44.00	55.80	74	-18.20	Pk	Vertical
2483.50	44.45	3.58	27.70	44.00	31.73	54	-22.27	AV	Vertical
2483.50	61.12	3.58	27.70	44.00	48.40	74	-25.60	Pk	Horizontal
2483.50	44.49	3.58	27.70	44.00	31.77	54	-22.23	AV	Horizontal
802.11n40									
2310.00	67.52	2.97	27.21	43.80	53.90	74	-20.10	Pk	Horizontal
2310.00	50.29	2.97	27.21	43.80	36.67	54	-17.33	AV	Horizontal
2310.00	65.54	2.97	27.21	43.80	51.92	74	-22.08	Pk	Vertical
2310.00	57.98	2.97	27.21	43.80	44.36	54	-9.64	AV	Vertical
2390.00	68.63	3.14	27.33	43.80	55.30	74	-18.70	Pk	Vertical
2390.00	47.05	3.14	27.33	43.80	33.72	54	-20.28	AV	Vertical
2390.00	67.42	3.14	27.33	43.80	54.09	74	-19.91	Pk	Horizontal
2390.00	48.52	3.14	27.33	43.80	35.19	54	-18.81	AV	Horizontal
2483.50	66.69	3.58	27.70	44.00	53.97	74	-20.03	Pk	Vertical
2483.50	47.53	3.58	27.70	44.00	34.81	54	-19.19	AV	Vertical
2483.50	66.63	3.58	27.70	44.00	53.91	74	-20.09	Pk	Horizontal
2483.50	45.98	3.58	27.70	44.00	33.26	54	-20.74	AV	Horizontal

Spurious Emission in Restricted Bands 3260MHz- 18000MHz

All the modulation modes have been tested, the worst result was report as below:

Frequency (MHz)	Reading Level (dBμV)	Cable Loss (dB)	Antenna Factor (dB/m)	Preamp Factor (dB)	Emission Level (dBμV/m)	Limits (dBμV/m)	Margin (dB)	Detector Type	Comment
3260	63.34	4.04	29.57	44.70	52.25	74	-21.75	Pk	Vertical
3260	60.57	4.04	29.57	44.70	49.48	54	-4.52	AV	Vertical
3260	61.42	4.04	29.57	44.70	50.33	74	-23.67	Pk	Horizontal
3260	52.22	4.04	29.57	44.70	41.13	54	-12.87	AV	Horizontal
3332	62.29	4.26	29.87	44.40	52.02	74	-21.98	Pk	Vertical
3332	52.21	4.26	29.87	44.40	41.94	54	-12.06	AV	Vertical
3332	63.35	4.26	29.87	44.40	53.08	74	-20.92	Pk	Horizontal
3332	51	4.26	29.87	44.40	40.73	54	-13.27	AV	Horizontal
17797	45.54	10.99	43.95	43.50	56.98	74	-17.02	Pk	Vertical
17797	29.97	10.99	43.95	43.50	41.41	54	-12.59	AV	Vertical
17788	50.42	11.81	43.69	44.60	61.32	74	-12.68	Pk	Horizontal
17788	32.26	11.81	43.69	44.60	43.16	54	-10.84	AV	Horizontal

"802.11 b" mode is the worst mode. When PK value is lower than the Average value limit, average don't record.

7.3 6DB BANDWIDTH

7.3.1 Applicable Standard

According to FCC Part 15.247(a)(2) and KDB 558074 D01 15.247 Meas Guidance v05 Section 8.2.

7.3.2 Conformance Limit

The minimum permissible 6dB bandwidth is 500 kHz.

7.3.3 Measuring Instruments

The Measuring equipment is listed in the section 6.3 of this test report.

7.3.4 Test Setup

Please refer to Section 6.1 of this test report.

7.3.5 Test Procedure

The testing follows Subclause 11.8 of ANSI C63.10.

The RF output of EUT was connected to the spectrum analyzer by RF cable and attenuator.

The path loss was compensated to the results for each measurement.

Set to the maximum power setting and enable the EUT transmit continuously.

The EUT was operating in controlled its channel.

Use the following spectrum analyzer settings:

Span = the frequency band of operation

RBW = 100KHz

VBW \geq 3*RBW

Sweep = auto

Detector function = peak

Trace = max hold

7.3.6 Test Results

EUT:	DashCam	Model No.:	W1
Temperature:	20 °C	Relative Humidity:	48%
Test Mode:	802.11b/g/n20/n40	Test By:	Loren Luo

Mode	Channel	Frequency (MHz)	6dB bandwidth	Limit (kHz)	Result
			(MHz)		
802.11b	Low	2412	10.55	500	Pass
	Middle	2437	10.17	500	Pass
	High	2462	10.70	500	Pass
802.11g	Low	2412	16.47	500	Pass
	Middle	2437	16.45	500	Pass
	High	2462	16.47	500	Pass
802.11n HT20	Low	2412	17.33	500	Pass
	Middle	2437	17.61	500	Pass
	High	2462	17.67	500	Pass
802.11n HT40	Low	2422	36.26	500	Pass
	Middle	2437	36.11	500	Pass
	High	2452	35.72	500	Pass

Test plot

(802.11b) 6dB Bandwidth plot on channel 1

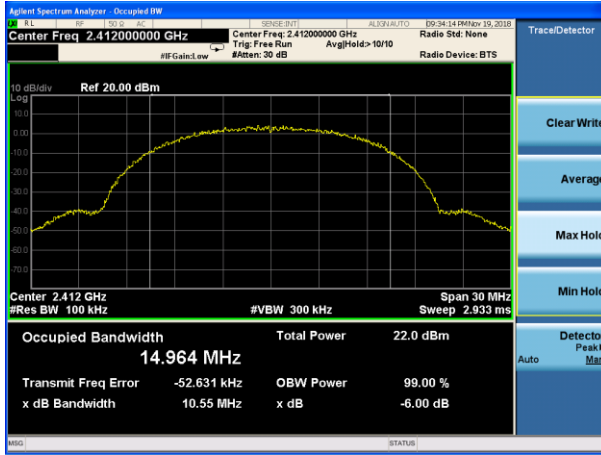

(802.11g) 6dB Bandwidth plot on channel 1

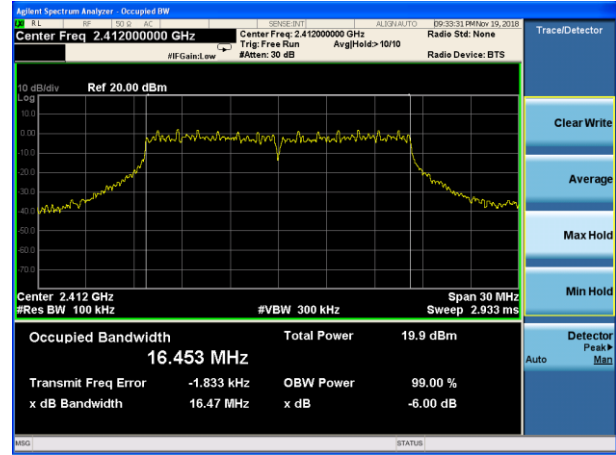

(802.11b) 6dB Bandwidth plot on channel 6

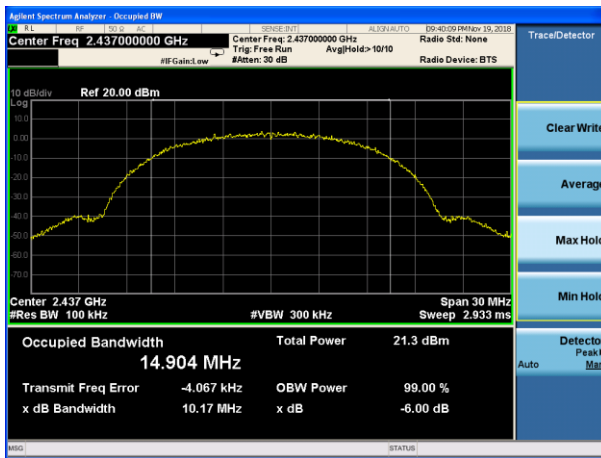

(802.11g) 6dB Bandwidth plot on channel 6

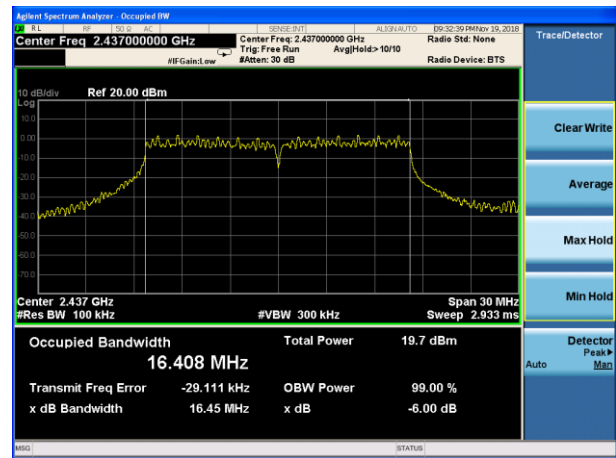

(802.11b) 6dB Bandwidth plot on channel 11

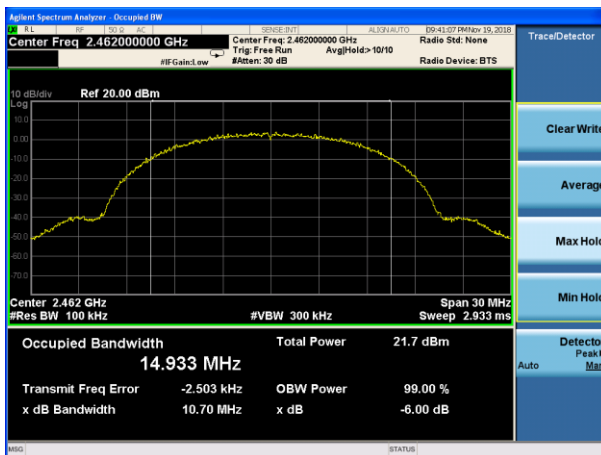

(802.11g) 6dB Bandwidth plot on channel 11

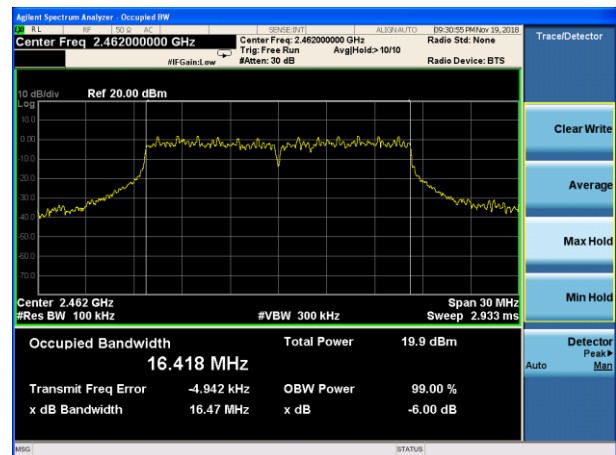

Test plot

(802.11n HT20) 6dB Bandwidth plot on channel 1

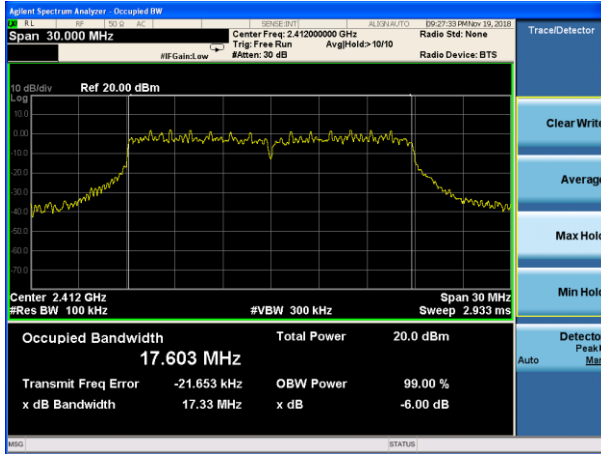

(802.11n HT40) 6dB Bandwidth plot on channel 3

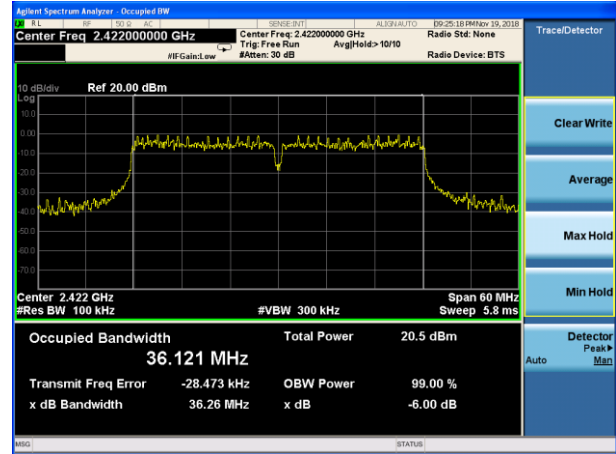

(802.11n HT20) 6dB Bandwidth plot on channel 6

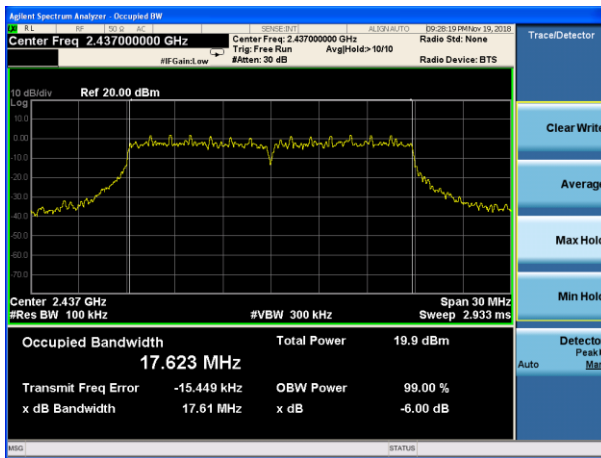

(802.11n HT40) 6dB Bandwidth plot on channel 6

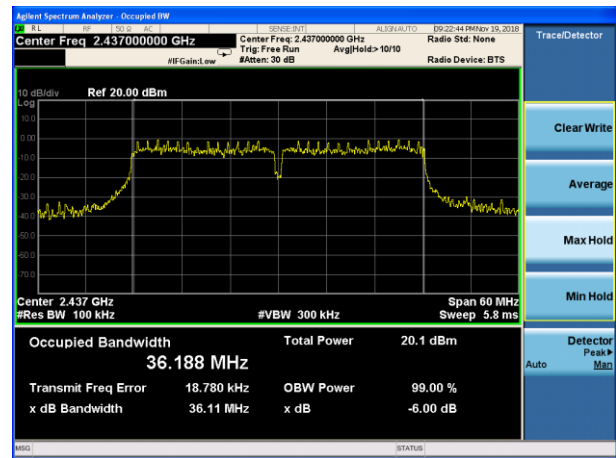

(802.11n HT20) 6dB Bandwidth plot on channel 11

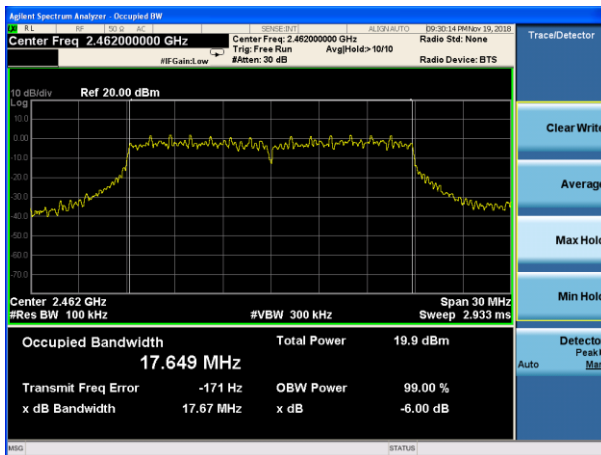

(802.11n HT40) 6dB Bandwidth plot on channel 9

