



# RADIOTESTREPORT

Report No:STS1908166W17

Issued for

Shanghai Unihertz E-Commerce Co., Ltd

Room 302, No. 5, Lane 59, Shennan Rd, Minhang district,  
Shanghai, China 201108

<b>Product Name:</b>	Smart phone
<b>Brand Name:</b>	Unihertz
<b>Model Name:</b>	Titan
<b>Series Model:</b>	N/A
<b>FCC ID:</b>	2AK6CTITAN
<b>Test Standard:</b>	FCC Part 15.407

Any reproduction of this document must be done in full. No single part of this document may be reproduced without permission from STS, All Test Data Presented in this report is only applicable to presented Test sample.

Shenzhen STS Test Services Co., Ltd.  
1/F., Building B, Zhuoke Science Park, No.190, Chongqing Road,  
Fuyong Street, Bao'an District, Shenzhen, Guangdong, China  
TEL: +86-755 3688 6288 FAX: +86-755 3688 6277 E-mail:sts@stsapp.com



S

T

S

L

A

B



### TEST RESULT CERTIFICATION

**Applicant's Name**..... : Shanghai Unihertz E-Commerce Co., Ltd  
**Address** ..... : Room 302, No. 5, Lane 59, Shennan Rd, Minhang district, Shanghai, China 201108  
**Manufacture's Name**..... : OBLUE Communication Technology Co.,Ltd.  
**Address** ..... : Room 406, Hivac Building, No. 2 North keji Rd, North Hi-Tech Industry Park, Nanshan district, shenzhen, China 201108

**Product Description**

**Product Name**..... : Smart phone  
**Brand Name** ..... : Unihertz  
**Model Name** ..... : Titan  
**Series Model**..... : N/A

**Test Standards**..... : FCC Part15.407

**Test Procedure**..... ANSI C63.10-2013

This device described above has been tested by STS, the test results show that the equipment under test (EUT) is in compliance with the FCC requirements. And it is applicable only to the tested sample identified in the report.

This report shall not be reproduced except in full, without the written approval of STS, this document only be altered or revised by STS, personal only, and shall be noted in the revision of the document.

**Date of Test**..... :  
**Date (s) of performance of tests**..... : 07 Aug. 2019 ~ 06 Sept. 2019  
**Date of Issue**..... : 06 Sept. 2019  
**Test Result**..... : **Pass**

Testing Engineer :   
 \_\_\_\_\_  
 (Chris Chen)

Technical Manager :   
 \_\_\_\_\_  
 (Sunday Hu)

Authorized Signatory :   
 \_\_\_\_\_  
 (Vita Li)





Table of Contents	Page
<b>1 . SUMMARY OF TEST RESULTS</b>	<b>6</b>
1.1 TEST FACTORY	7
1.2 MEASUREMENT UNCERTAINTY	7
<b>2 . GENERAL INFORMATION</b>	<b>8</b>
2.1 GENERAL DESCRIPTION OF THE EUT	8
2.2 DESCRIPTION OF TEST MODES	11
2.3 BLOCK DIGRAM SHOWING THE CONFIGURATION OF SYSTEM TESTED	12
2.4 DESCRIPTION OF NECESSARY ACCESSORIES AND SUPPORT UNITS	13
2.5EQUIPMENTS LIST FOR ALL TEST ITEMS	14
<b>3 . EMC EMISSION TEST</b>	<b>15</b>
3.1 CONDUCTED EMISSION MEASUREMENT	15
3.2 RADIATED EMISSION AND ( BANDEGE) MEASUREMENT	19
<b>4. CONDUCTED SPURIOUS EMISSIONS AND BANDEGE</b>	<b>43</b>
4.1 LIMIT	43
4.2 TEST PROCEDURE	43
4.3 DEVIATION FROM STANDARD	43
4.4 TEST SETUP	44
4.5 EUT OPERATION CONDITIONS	44
4.6 TEST RESULTS	44
<b>5. POWER SPECTRAL DENSITY TEST</b>	<b>45</b>
5.1 LIMIT	45
5.2 TEST PROCEDURE	45
5.3 DEVIATION FROM STANDARD	46
5.4 TEST SETUP	46
5.5 EUT OPERATION CONDITIONS	46
5.6 TEST RESULTS	46
<b>6.BANDWIDTH MEASUREMENT</b>	<b>50</b>
6.1EMISSION BANDWIDTH (EBW) 26 BANDWID PROCEDURES / LIMIT	50
6.2 OCCUPIED BANDWIDTH ( 99%) TEST APPLIED PROCEDURES / LIMIT	53
6.3 MINIMUM EMISSION BANDWIDTH(6 DB) PROCEDURES / LIMIT	56
<b>7. MAXIMUM CONDUCTED OUTPUT POWER</b>	<b>58</b>
7.1 LIMIT	58
7.2 TEST PROCEDURE	58
7.3 DEVIATION FROM STANDARD	59



Table of Contents	Page
7.4 TEST SETUP	59
7.5 EUT OPERATION CONDITIONS	59
7.6 TEST RESULTS	60
<b>8. AUTOMATICALLY DISCONTINUE TRANSMISSION</b>	<b>80</b>
8.1 LIMIT OF AUTOMATICALLY DISCONTINUE TRANSMISSION	80
8.2 TEST RESULT OF AUTOMATICALLY DISCONTINUE TRANSMISSION	80
<b>9. ANTENNA REQUIREMENT</b>	<b>81</b>
9.1 STANDARD REQUIREMENT	81
9.2 EUT ANTENNA	81
<b>APPENDIX - PHOTOS OF TEST SETUP</b>	<b>82</b>





**Revision History**

Rev.	Issue Date	Report NO.	Effect Page	Contents
00	06 Sept. 2019	STS1908166W17	ALL	Initial Issue





## 1. SUMMARY OF TEST RESULTS

Test procedures according to the technical standards:

§ 15.407, KDB789033 D02 General U-NII Test Procedures New Rules v02r01

FCC Part 15.407		
FCC standard	Test Item	Results
15.207	AC Conducted Emission	PASS
§ 15.407 (2) (26 dB) / § 15.407 (e) (6 dB) / § 15.407 (a) (99%)	26dB/6dB&99% Bandwidth	PASS
15.407(a) (1).(2).(3).(4).(5)	Maximum Conducted Output Power	PASS
15.407(b)& 15.209	Radiated Emission And (bandedge Emissions) Measurement	PASS
15.407(b)7	Conducted Emission And (bandedge Emissions) Measurement	PASS
15.407(a)(1).(2).(3).(4).(5)	Power Spectral Density	PASS
15.407(c)	Automatically Discontinue Transmission	PASS
15.203/15.204	Antenna Requirement	PASS

NOTE:

(1) "N/A" denotes test is not applicable in this Test Report

(2) all tests are according to ANSI C63.10-2013



## 1.1 TEST FACTORY

SHENZHEN STS TEST SERVICES CO., LTD

Add. : A 1/F, Building B, Zhuoke Science Park, No.190 Chongqing Road, HepingShequ, Fuyong Sub-District, Bao'an District, Shenzhen, Guang Dong, China

FCC test Firm Registration Number: 625569

IC test Firm Registration Number: 12108A

A2LA Certificate No.: 4338.01

## 1.2 MEASUREMENT UNCERTAINTY

The reported uncertainty of measurement  $y \pm U$ , where expanded uncertainty  $U$  is based on a standard uncertainty multiplied by a coverage factor of  $k=2$ , providing a level of confidence of approximately **95%**.

No.	Item	Uncertainty
1	RF output power, conducted	$\pm 0.71$ dB
2	Unwanted Emissions, conducted	$\pm 0.63$ dB
3	All emissions, radiated 30-200MHz	$\pm 3.43$ dB
4	All emissions, radiated 200MHz-1GHz	$\pm 3.57$ dB
5	All emissions, radiated >1G	$\pm 4.13$ dB
6	Conducted Emission (9KHz-150KHz)	$\pm 3.18$ dB
7	Conducted Emission (150KHz-30MHz)	$\pm 2.70$ dB



**2. GENERAL INFORMATION**

**2.1 GENERAL DESCRIPTION OF THE EUT**

Product Name	Smart phone	
Trade Name	Unihertz	
Model Name	Titan	
Series Model	N/A	
Model Difference	N/A	
Product Description	The EUT is a Smart phone	
	Operation Frequency:	IEEE 802.11a/ n(HT20)/ac(VHT20): 5.180GHz-5.240GHz IEEE 802.11n(HT40)/ac(VHT40): 5.190GHz-5.310GHz IEEE 802.11ac(VHT80): 5.210GHz IEEE 802.11a/ n(HT20)/ac(VHT20): 5.260GHz-5.320GHz IEEE 802.11n(HT40)/ac(VHT40):5.270GHz-5.310GHz IEEE 802.11ac(VHT80):5.290GHz
		IEEE 802.11a/ n(HT20)/ac(VHT20): 5.500GHz-5.700GHz IEEE 802.11n(HT40)/ac(VHT40):5.510GHz-5.670GHz IEEE 802.11ac(VHT80):5.530GHz-5.610GHz
		IEEE 802.11a/ n(HT20)/ac(VHT20): 5.745GHz-5.825GHz IEEE 802.11n(HT40)/ac(VHT40): 5.755GHz-5.795GHz IEEE 802.11ac(VHT80): 5.775GHz
	Modulation Type:	802.11a(OFDM): BPSK,QPSK,16-QAM,64-QAM 802.11n(OFDM): BPSK,QPSK,16-QAM,64-QAM 802.11ac(OFDM): BPSK,QPSK,16-QAM,64-QAM,256-QAM
	Antenna Designation:	See Note 2
	Max. Output Power(Conducted)	12.0dBm
		More details of EUT technical specification, please refer to the User's Manual.
Test Channel	Please refer to the Note 1.	
Adapter	Input: 100-240V, 50/60Hz, 0.6A Output: 5V, 2.0A 9V, 2.0A 12V, 1.5A	
Battery	Rated Voltage: 3.85V Charge Limit: 4.4V Capacity: 6000mAh	
Hardware version number	G61_V2.0	





Software version number	Titan_20190629
Connecting I/O Port(s)	Please refer to the User's Manual

Note: For a more detailed features description, please refer to the manufacturer's specifications or the User's Manual. The EUT not support straddle channels.

1. Operation Frequency of channel

5.180GHz-5.240GHz		5.500GHz-5.720GHz	
Channel	Frequency	Channel	Frequency
36	5180	100	5500
38	5190	102	5510
40	5200	104	5520
42	5210	108	5540
44	5220	110	5550
46	5230	112	5560
48	5240	116	5580
		118	5590
		120	5600
5.260GHz-5.320GHz			
Channel	Frequency	Channel	Frequency
52	5260	124	5620
54	5270	126	5630
56	5280	128	5640
58	5290	132	5660
60	5300	134	5670
62	5310	136	5680
64	5320	140	5700
5.745GHz-5.825GHz			
Channel	Frequency	Channel	Frequency
149	5745		
151	5755		
153	5765		
157	5785		
159	5795		
161	5805		
165	5825		

Note:

In section 15.31(m), regards to the operating frequency range over 10 MHz, the Lowest frequency, the middle frequency, and the highest frequency of channel were selected to perform the test, and the selected channel see below:

Carrier Frequency Channel

5GHz:

For 802.11a/n(HT20) /ac (VHT20)			
Channel	Freq.(MHz)	Channel	Freq.(MHz)
36	5180	52	5260
40	5200	60	5300
48	5240	64	5320



For 802.11a/n(HT20) /ac (VHT20)			
Channel	Freq.(MHz)	Channel	Freq.(MHz)
100	5500	149	5745
116	5580	157	5785
140	5700	165	5825

For 802.11n(HT40) /ac (VHT40)			
Channel	Freq.(MHz)	Channel	Freq.(MHz)
38	5190	54	5270
46	5230	62	5310

For 802.11n(HT40) /ac (VHT40)			
Channel	Freq.(MHz)	Channel	Freq.(MHz)
102	5510	151	5755
110	5550	159	5795
134	5670		

For 802.11ac (VHT80)			
Channel	Freq.(MHz)	Channel	Freq.(MHz)
42	5210	155	5775

For 802.11ac (VHT80)			
Channel	Freq.(MHz)	Channel	Freq.(MHz)
106	5530	155	5775
122	5610		

2.	Ant	Brand	Model Name	Ant Type	Connector	Gain (dBi)	NOTE
	A	Unihertz	Titan	PIFA	N/A	5.2GWIFI: 1.11dBi 5.3GWIFI: 0.56dBi 5.6GWIFI: 3.9dBi 5.8GWIFI:4.94dBi	WLANAnt



## 2.2 DESCRIPTION OF TEST MODES

To investigate the maximum EMI emission characteristics generated from EUT, the test system was pre-scanning tested based on the consideration of following EUT operation mode or test configuration mode which possibly have effect on EMI emission level. Each of these EUT operation mode(s) or test configuration mode(s) mentioned above was evaluated respectively.

Worst Mode	Description	Data Rate
Mode 1	TX IEEE 802.11a HT20 CH36&CH40&CH48	6 Mbps
Mode 2	TX IEEE 802.11a HT20 CH52&CH60&CH64	6 Mbps
Mode 3	TX IEEE 802.11a HT20 CH100&CH116&CH140	6 Mbps
Mode 4	TX IEEE 802.11a HT20 CH149&CH157&CH165	6 Mbps
Mode 5	TX IEEE 802.11n HT20 CH36&CH40&CH48	MCS 0
Mode 6	TX IEEE 802.11ac HT20 CH36&CH40&CH48	NSS1 MCS0
Mode 7	TX IEEE 802.11n HT20 CH52&CH60&CH64	MCS 0
Mode 8	TX IEEE 802.11ac HT20 CH52&CH60&CH64	NSS1 MCS0
Mode 9	TX IEEE 802.11n HT20 CH100&CH116&CH140	MCS 0
Mode 10	TX IEEE 802.11ac HT20 CH100&CH116&CH140	NSS1 MCS0
Mode 11	TX IEEE 802.11n HT20 CH149&CH157&CH165	MCS 0
Mode 12	TX IEEE 802.11ac HT20 CH149&CH157&CH165	NSS1 MCS0
Mode 13	TX IEEE 802.11n HT40 CH38&CH46	MCS 0
Mode 14	TX IEEE 802.11ac HT40 CH38&CH46	NSS1 MCS0
Mode 15	TX IEEE 802.11n HT40 CH54 &CH62	MCS 0
Mode 16	TX IEEE 802.11ac HT40 CH54 &CH62	NSS1 MCS0
Mode 17	TX IEEE 802.11n HT40 CH102&CH110&CH134	MCS 0
Mode 18	TX IEEE 802.11ac HT40 CH102&CH110&CH134	NSS1 MCS0
Mode 19	TX IEEE 802.11n HT40 CH151&CH159	MCS 0
Mode 20	TX IEEE 802.11ac HT40 CH151&CH159	NSS1 MCS0
Mode 21	TX IEEE 802.11ac HT80 CH42	NSS1 MCS0
Mode 22	TX IEEE 802.11ac HT80 CH58	NSS1 MCS0
Mode 23	TX IEEE 802.11ac HT80 CH106&122	NSS1 MCS0
Mode 24	TX IEEE 802.11ac HT80 CH155	NSS1 MCS0

- Note: (1) The measurements are performed at the highest, middle, lowest available channels.  
 (2) The measurements are performed at all Bit Rate of Transmitter, the worst data was reported  
 (3) We have been tested for all available U.S. voltage and frequencies (For 120V, 50/60Hz and 240V, 50/60Hz) for which the device is capable of operation.



AC Conducted Emission

Test Case	
AC Conducted Emission	Mode25: Keeping TX + WLAN Link

2.3 BLOCK DIAGRAM SHOWING THE CONFIGURATION OF SYSTEM TESTED

Radiated Spurious Emission Test

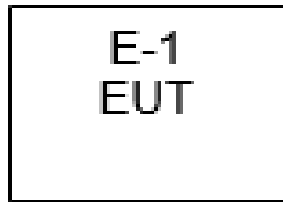

Conducted Emission Test

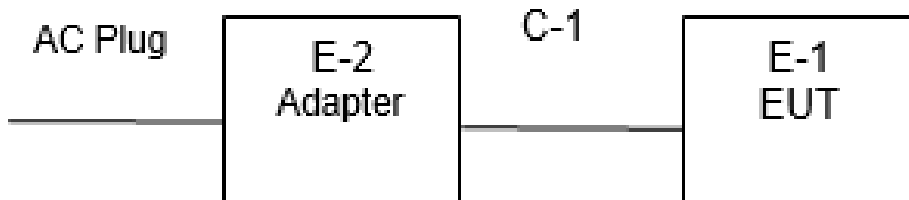



## 2.4 DESCRIPTION OF NECESSARY ACCESSORIES AND SUPPORT UNITS

The EUT has been tested as an independent unit together with other necessary accessories or support units. The following support units or accessories were used to form a representative test configuration during the tests.

### Necessary accessories

Item	Equipment	Mfr/Brand	Model/Type No.	Serial No.	Note
E-2	Adapter	Unihertz	HJ-FC010K7-US	N/A	N/A
C-2	DC Cable	N/A	110cm	N/A	N/A

### Support units

Item	Equipment	Mfr/Brand	Model/Type No.	Serial No.	Note
N/A	N/A	N/A	N/A	N/A	N/A

### Note:

- (1) The support equipment was authorized by Declaration of Confirmation.
- (2) For detachable type I/O cable should be specified the length in cm in 『Length』 column.
- (3) “YES” is means “shielded” “with core”; “NO” is means “unshielded” “without core”.



## 2.5 EQUIPMENTS LIST FOR ALL TEST ITEMS

### Radiation Test equipment

Kind of Equipment	Manufacturer	Type No.	Serial No.	Last calibration	Calibrated until
EMI Test Receiver	R&S	ESCI	101427	2018.10.13	2019.10.12
Signal Analyzer	Agilent	N9020A	MY51110105	2019.03.02	2020.03.01
Active loop Antenna	ZHINAN	ZN30900C	16035	2018.03.11	2021.03.10
Bilog Antenna	TESEQ	CBL6111D	34678	2017.11.02	2020.11.1
Horn Antenna	SCHWARZBECK	BBHA 9120D(1201)	9120D-1343	2018.10.19	2021.10.18
SHF-EHF Horn Antenna (18G-40GHz)	A-INFO	LB-180400-KF	J211020657	2018.03.11	2021.03.10
Pre-Amplifier(0.1 M-3GHz)	EM	EM330	060665	2018.10.13	2019.10.12
Pre-Amplifier (1G-18GHz)	SKET	LNPA-01018G-4 5	SK2018080901	2018.10.13	2019.10.12
Temperature & Humidity	HH660	Mieo	N/A	2018.10.11	2019.10.10
turn table	EM	SC100_1	60531	N/A	N/A
Antenna mast	EM	SC100	N/A	N/A	N/A
Test SW	BULUN	BL410-E/18.905			

### Conduction Test equipment

Kind of Equipment	Manufacturer	Type No.	Serial No.	Last calibration	Calibrated until
Test Receiver	R&S	ESCI	101427	2018.10.13	2019.10.12
LISN	R&S	ENV216	101242	2018.10.11	2019.10.10
LISN	EMCO	3810/2NM	23625	2018.10.11	2019.10.10
Temperature & Humidity	HH660	Mieo	N/A	2018.10.11	2019.10.10
Test SW	FARAD	EZ-EMC(Ver.STSLAB-03A1 CE)			

### RF Connected Test

Kind of Equipment	Manufacturer	Type No.	Serial No.	Last calibration	Calibrated until
USB RF power sensor	DARE	RPR3006W	15I00041SNO03	2018.10.13	2019.10.12
Signal Analyzer	Agilent	N9020A	MY49100060	2018.10.13	2019.10.12
Temperature & Humidity	HH660	Mieo	N/A	2018.10.11	2019.10.10
Test SW	FARAD	LZ-RF /LzRf-3A3			



### 3. EMC EMISSION TEST

#### 3.1 CONDUCTED EMISSION MEASUREMENT

##### 3.1.1 POWER LINE CONDUCTED EMISSION Limits (Frequency Range 150KHz-30MHz)

FREQUENCY (MHz)	Class B (dBuV)		Standard
	Quasi-peak	Average	
0.15 -0.5	66 - 56 *	56 - 46 *	CISPR
0.50 -5.0	56.00	46.00	CISPR
5.0 -30.0	60.00	50.00	CISPR

0.15 -0.5	66 - 56 *	56 - 46 *	FCC
0.50 -5.0	56.00	46.00	FCC
5.0 -30.0	60.00	50.00	FCC

Note:

- (1) The tighter limit applies at the band edges.
- (2) The limit of " \* " marked band means the limitation decreases linearly with the logarithm of the frequency in the range.

The following table is the setting of the receiver

Receiver Parameters	Setting
Attenuation	10 dB
Start Frequency	0.15 MHz
Stop Frequency	30 MHz
IF Bandwidth	9 kHz

### 3.1.2 TEST PROCEDURE

- The EUT was placed 0.8 meters from the horizontal ground plane with EUT being connected to the power mains through a line impedance stabilization network (LISN). All other support equipments powered from additional LISN(s). The LISN provide 50 Ohm/ 50uH of coupling impedance for the measuring instrument.
- Interconnecting cables that hang closer than 40 cm to the groundplane shall be folded back and forth in the center forming a bundle 30 to 40 cm long.
- I/O cables that are not connected to a peripheral shall be bundled in the center. The end of the cable may be terminated, if required, using the correct terminating impedance. The overall length shall not exceed 1 m.
- LISN at least 80 cm from nearest part of EUT chassis.
- For the actual test configuration, please refer to the related Item –EUT Test Photos.

### 3.1.3 DEVIATION FROM TEST STANDARD

No deviation

### 3.1.4 TEST SETUP

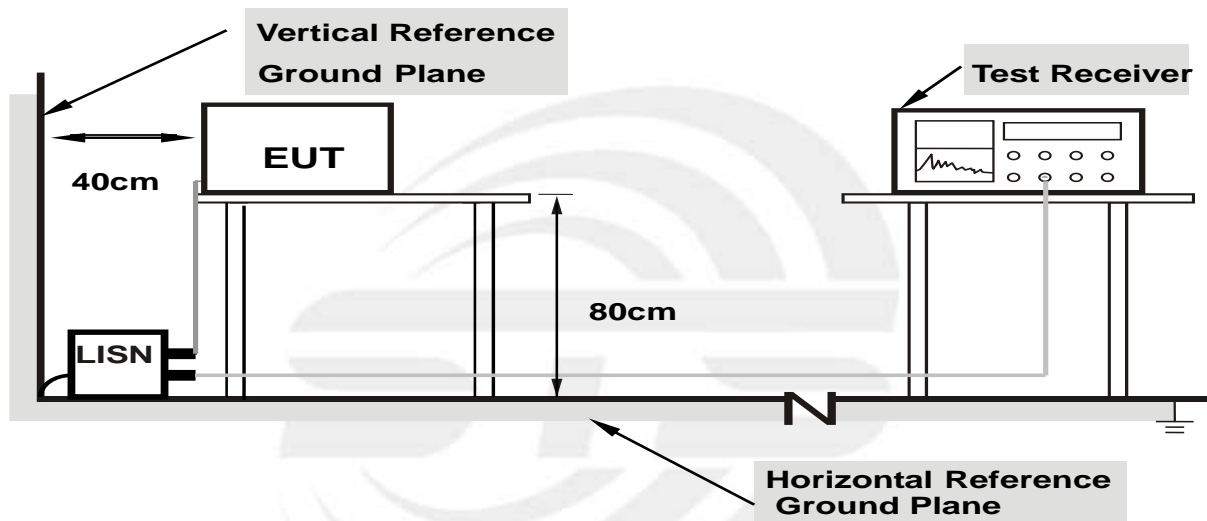

- Note:**
- Support units were connected to second LISN.
  - Both of LISNs (AMN) are 80 cm from EUT and at least 80 cm from other units and other metal planes

### 3.1.5 EUT OPERATING CONDITIONS

The EUT was configured for testing in a typical fashion (as a customer would normally use it). The EUT has been programmed to continuously transmit during test. This operating condition was tested and used to collect the included data.





### 3.1.6 TEST RESULTS

Temperature:	26(C)	Relative Humidity:	60%RH
Test Voltage:	AC 120V/60Hz	Phase:	L
Test Mode :	Mode 25		

No.	Frequency (MHz)	Reading (dBuV)	Correct Factor(dB)	Result (dBuV)	Limit (dBuV)	Margin (dB)	Remark
1	0.1500	48.36	9.79	58.15	66.00	-7.85	QP
2	0.1500	32.28	9.79	42.07	56.00	-13.93	AVG
3	0.2180	40.57	9.86	50.43	62.89	-12.46	QP
4	0.2180	26.00	9.86	35.86	52.89	-17.03	AVG
5	0.4260	34.19	10.03	44.22	57.33	-13.11	QP
6	0.4260	20.64	10.03	30.67	47.33	-16.66	AVG
7	0.7660	29.71	9.83	39.54	56.00	-16.46	QP
8	0.7660	16.99	9.83	26.82	46.00	-19.18	AVG
9	1.9860	29.78	9.78	39.56	56.00	-16.44	QP
10	1.9860	16.52	9.78	26.30	46.00	-19.70	AVG
11	13.0260	34.35	10.22	44.57	60.00	-15.43	QP
12	13.0260	20.63	10.22	30.85	50.00	-19.15	AVG

Remark:

1. All readings are Quasi-Peak and Average values.
2. Margin = Result (Result = Reading + Factor) – Limit

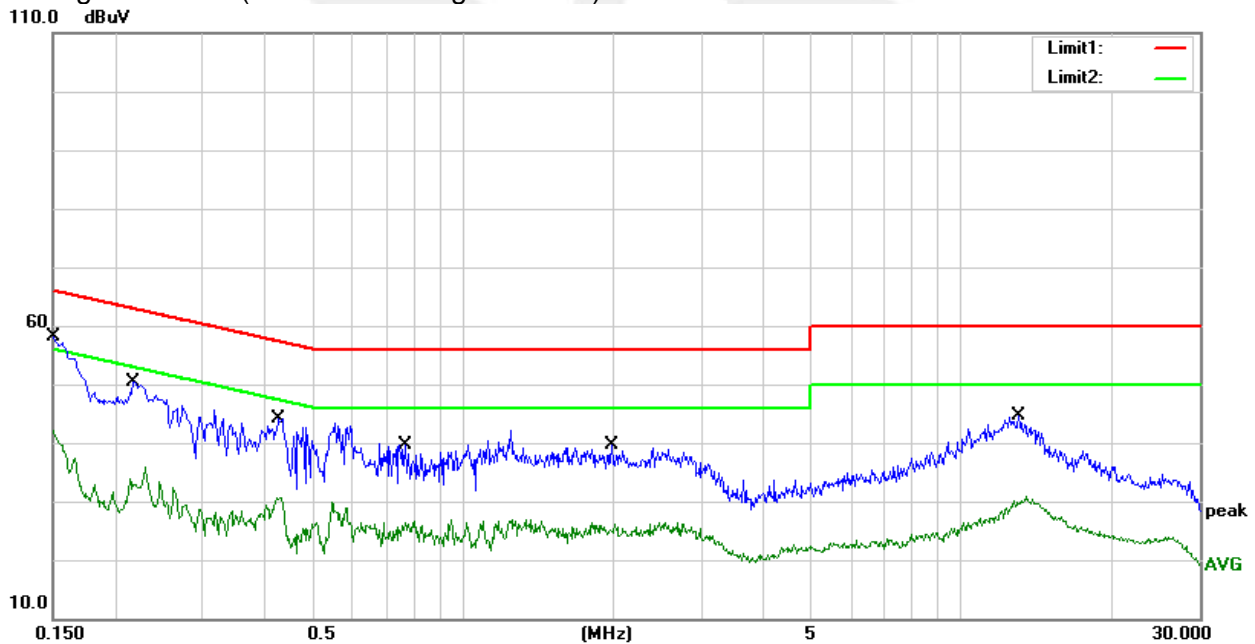



Temperature:	26(C)	Relative Humidity:	60%RH
Test Voltage	AC 120V/60Hz	Phase:	N
Test Mode	Mode 25		

No.	Frequency (MHz)	Reading (dBuV)	Correct Factor(dB)	Result (dBuV)	Limit (dBuV)	Margin (dB)	Remark
1	0.1621	45.65	9.79	55.44	65.36	-9.92	QP
2	0.1621	29.27	9.79	39.06	55.36	-16.30	AVG
3	0.2260	39.56	9.90	49.46	62.60	-13.14	QP
4	0.2260	18.35	9.90	28.25	52.60	-24.35	AVG
5	0.5540	32.86	9.98	42.84	56.00	-13.16	QP
6	0.5540	19.34	9.98	29.32	46.00	-16.68	AVG
7	1.9860	29.28	9.78	39.06	56.00	-16.94	QP
8	1.9860	16.91	9.78	26.69	46.00	-19.31	AVG
9	2.7780	28.04	9.81	37.85	56.00	-18.15	QP
10	2.7780	16.08	9.81	25.89	46.00	-20.11	AVG
11	12.5100	34.26	10.22	44.48	60.00	-15.52	QP
12	12.5100	20.15	10.22	30.37	50.00	-19.63	AVG

Remark:

1. All readings are Quasi-Peak and Average values.
2. Margin = Result (Result = Reading + Factor) - Limit

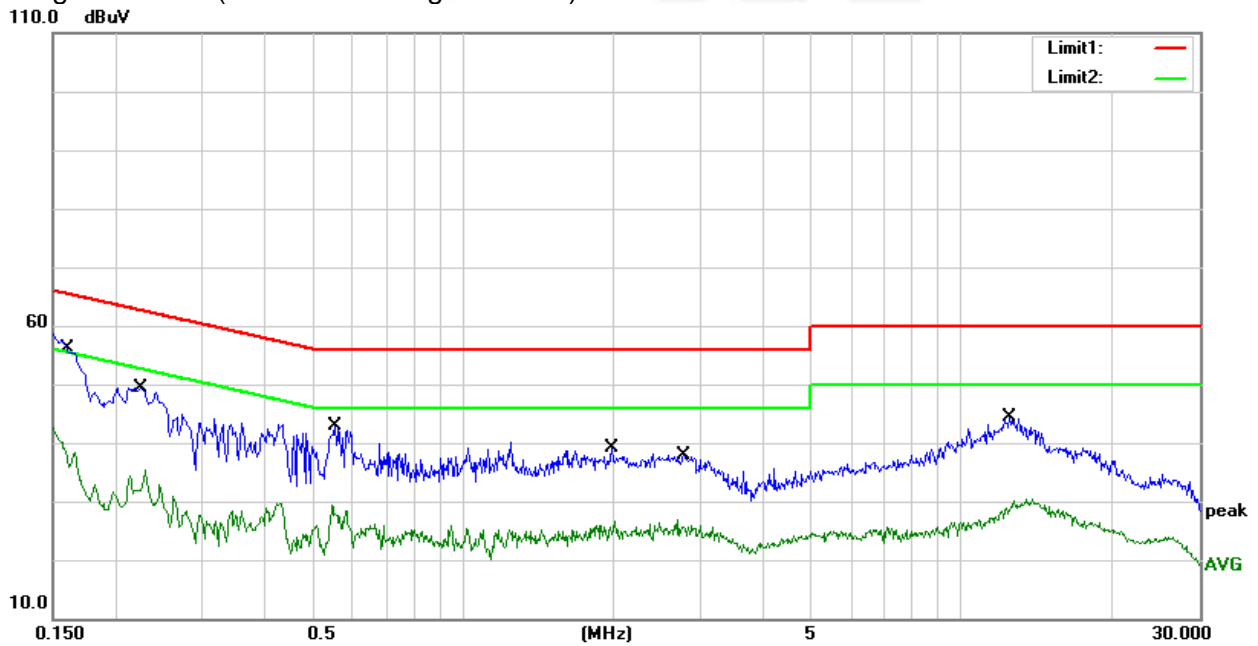



### 3.2 RADIATED EMISSION AND ( BANDEDGE)MEASUREMENT

#### 3.2.1 RADIATED EMISSION LIMITS (Frequency Range 9kHz-1000MHz)

In case the emission fall within the restricted band specified on 15.407(b)7& 15.205/209(a), then the (a); limit in the table below has to be followed.

Frequencies (MHz)	Field Strength (micorvolts/meter)	Measurement Distance (meters)
0.009~0.490	2400/F(KHz)	300
0.490~1.705	24000/F(KHz)	30
1.705~30.0	30	30
30~88	100	3
88~216	150	3
216~960	200	3
Above 960	500	3

#### LIMITS OF RADIATED EMISSION MEASUREMENT (Above 1000MHz)

FREQUENCY (MHz)	Class B (dBuV/m) (at 3M)	
	PEAK	AVERAGE
Above 1000	68.2	54

Notes:

- (1) The limit for radiated test was performed according to FCC PART 15E.
- (2) The tighter limit applies at the band edges.
- (3) Emission level (dBuV/m)=20log Emission level (uV/m).

Spectrum Parameter	Setting
Attenuation	Auto
Detector	Peak
Start Frequency	1000 MHz(Peak/AV)
Stop Frequency	10th carrier harmonic(Peak/AV)
RB / VB (emission in restricted band)	1MHz / 1MHz, AV=1 MHz /3 MHz

For Band edge

Spectrum Parameter	Setting
Detector	Peak
RB / VB (emission in restricted band)	1MHz / 1MHz, AV=1 MHz /3 MHz



Receiver Parameter	Setting
Attenuation	Auto
Start ~ Stop Frequency	9kHz~90kHz / RB 200Hz for PK & AV
Start ~ Stop Frequency	90kHz~110kHz / RB 200Hz for QP
Start ~ Stop Frequency	110kHz~490kHz / RB 200Hz for PK & AV
Start ~ Stop Frequency	490kHz~30MHz / RB 9kHz for QP
Start ~ Stop Frequency	30MHz~1000MHz / RB 120kHz for QP

### 3.2.2 TEST PROCEDURE

- a. The measuring distance of at 3 m shall be used for measurements at frequency 0.009MHz up to 1GHz. For frequencies above 1GHz, any suitable measuring distance may be used.
- b. The EUT was placed on the top of a rotating table 0.8 meters (above 1GHz is 1.5 m) above the ground at a 3 meter anechoic chamber. The table was rotated 360 degrees to determine the position of the highest radiation.
- c. The height of the equipment shall be 0.8 m (above 1GHz is 1.5 m); the height of the test antenna shall vary between 1 m to 4 m. Horizontal and vertical polarizations of the antenna are set to make the measurement
- d. The initial step in collecting conducted emission data is a spectrum analyzer peak detector mode pre-scanning the measurement frequency range. Significant peaks are then marked and then QuasiPeak detector mode re-measured.
- e. If the Peak Mode measured value compliance with and lower than Quasi Peak Mode Limit, the EUT shall be deemed to meet QP Limits and then no additional QP Mode measurement performed.
- f. For the actual test configuration, please refer to the related Item –EUT Test Photos.

Note:

Both horizontal and vertical antenna polarities were tested and performed test to three orthogonal axis. The worst case emissions were reported

### 3.2.2 DEVIATION FROM TEST STANDARD

No deviation

### 3.2.3 TESTSETUP

(A) Radiated Emission Test-Up Frequency Below 30MHz

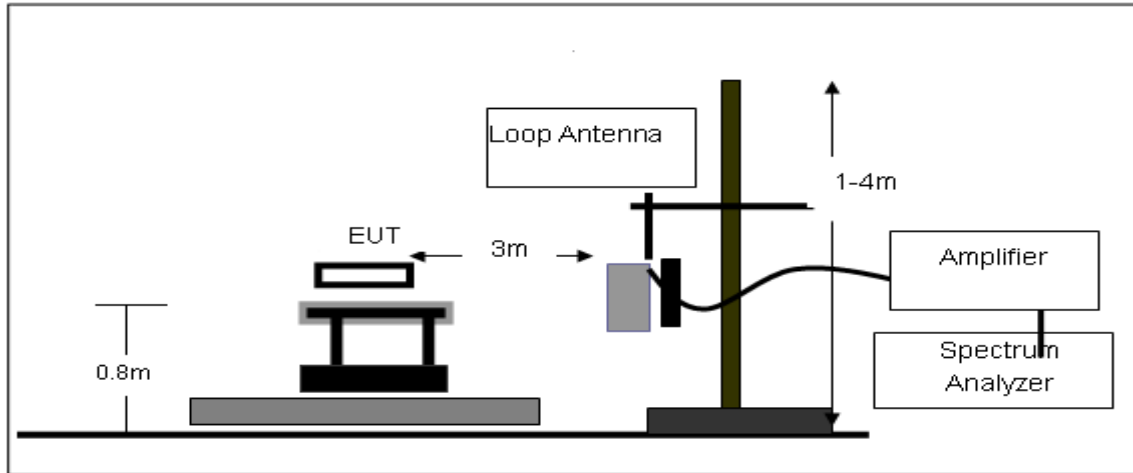

(B) Radiated Emission Test-Up Frequency 30MHz~1GHz

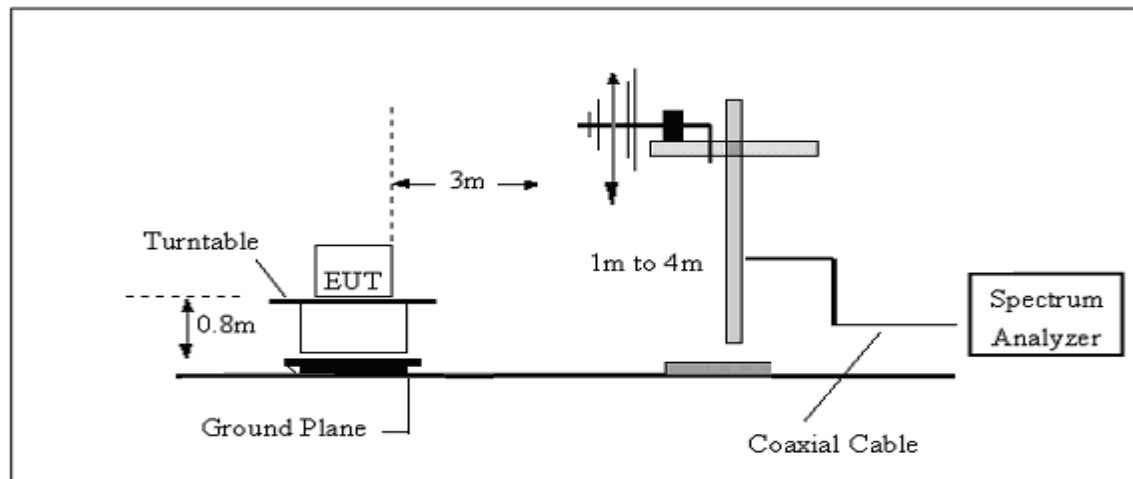

(C) Radiated Emission Test-Up Frequency Above 1GHz

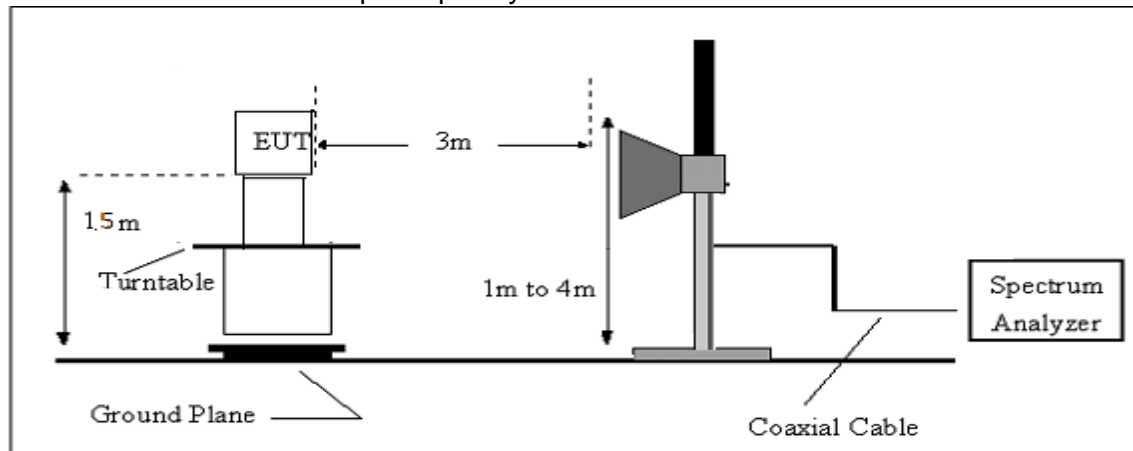



### 3.2.4 EUT OPERATING CONDITIONS

The EUT tested system was configured as the statements of 2.4 Unless otherwise a special operating condition is specified in the follows during the testing.

### 3.2.5 FIELD STRENGTH CALCULATION

The field strength is calculated by adding the Antenna Factor and Cable Factor and subtracting the Amplifier Gain and Duty Cycle Correction Factor (if any) from the measured reading. The basic equation with a sample calculation is as follows:

$$FS = RA + AF + CL - AG$$

Where

FS = Field Strength

CL = Cable Attenuation Factor (Cable Loss)

RA = Reading Amplitude

AG = Amplifier Gain

AF = Antenna Factor

For example

Frequency (MHz)	FS (dB $\mu$ V/m)	RA (dB $\mu$ V/m)	AF (dB)	CL (dB)	AG (dB)	Factor (dB)
300	40	58.1	12.2	1.6	31.9	-18.1

$$\text{Factor} = \text{AF} + \text{CL} - \text{AG}$$

**3.2.6 TEST RESULTS (Between 9KHz – 30 MHz)**

Temperature:	25.1(C)	Relative Humidity:	69%RH
Test Voltage:	DC 3.85V from battery	Polarization:	--
Test Mode:	TX Mode		

Freq. (MHz)	Reading (dBuV/m)	Limit (dBuV/m)	Margin (dB)	State P/F
--	--	--	--	PASS
--	--	--	--	PASS

**Note:**

The amplitude of spurious emissions which are attenuated by more than 20dB below the permissible value has no need to be reported.

Distance extrapolation factor =  $40 \log(\text{specific distance}/\text{test distance})$ (dB);

Limit line = specific limits(dBuV) + distance extrapolation factor.



3.2.7 TEST RESULTS(Between 30MHz – 1GHz)

Temperature	25.1(C)	Relative Humidity:	69%RH
Test Voltage	DC 3.85V from battery	Polarization:	Horizontal
Test Mode	Mode 1-24 (Mode 2 worst mode)		

No.	Frequency (MHz)	Reading (dBuV)	Correct Factor(dB/m)	Result (dBuV/m)	Limit (dBuV/m)	Margin (dB)	Remark
1	51.4807	49.17	-23.88	25.29	40.00	-14.71	QP
2	87.7248	55.11	-21.79	33.32	40.00	-6.68	QP
3	180.0165	43.66	-20.01	23.65	43.50	-19.85	QP
4	408.9460	34.77	-10.62	24.15	46.00	-21.85	QP
5	729.3583	29.17	-2.52	26.65	46.00	-19.35	QP
6	945.4400	34.94	1.50	36.44	46.00	-9.56	QP

Remark:

1. Margin = Result (Result = Reading + Factor) – Limit

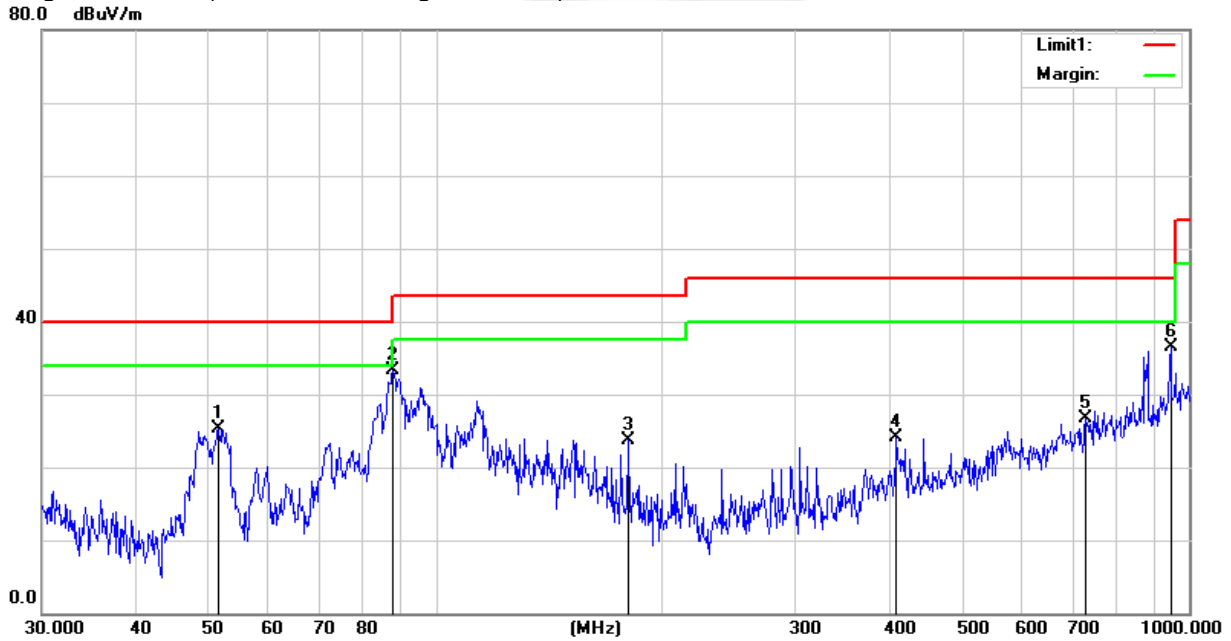





Temperature	25.1(C)	Relative Humidity:	69%RH
Test Voltage	DC 3.85V from battery	Polarization:	Vertical
Test Mode	Mode 1-24 (Mode 2 worst mode)		

No.	Frequency (MHz)	Reading (dBuV)	Correct Factor(dB/m)	Result (dBuV/m)	Limit (dBuV/m)	Margin (dB)	Remark
1	31.3992	34.93	-13.57	21.36	40.00	-18.64	QP
2	83.8156	52.11	-22.45	29.66	40.00	-10.34	QP
3	113.7143	44.34	-18.69	25.65	43.50	-17.85	QP
4	319.9370	37.71	-14.00	23.71	46.00	-22.29	QP
5	570.6100	32.36	-5.61	26.75	46.00	-19.25	QP
6	942.1305	37.91	1.43	39.34	46.00	-6.66	QP

Remark:

1. Margin = Result (Result = Reading + Factor) – Limit

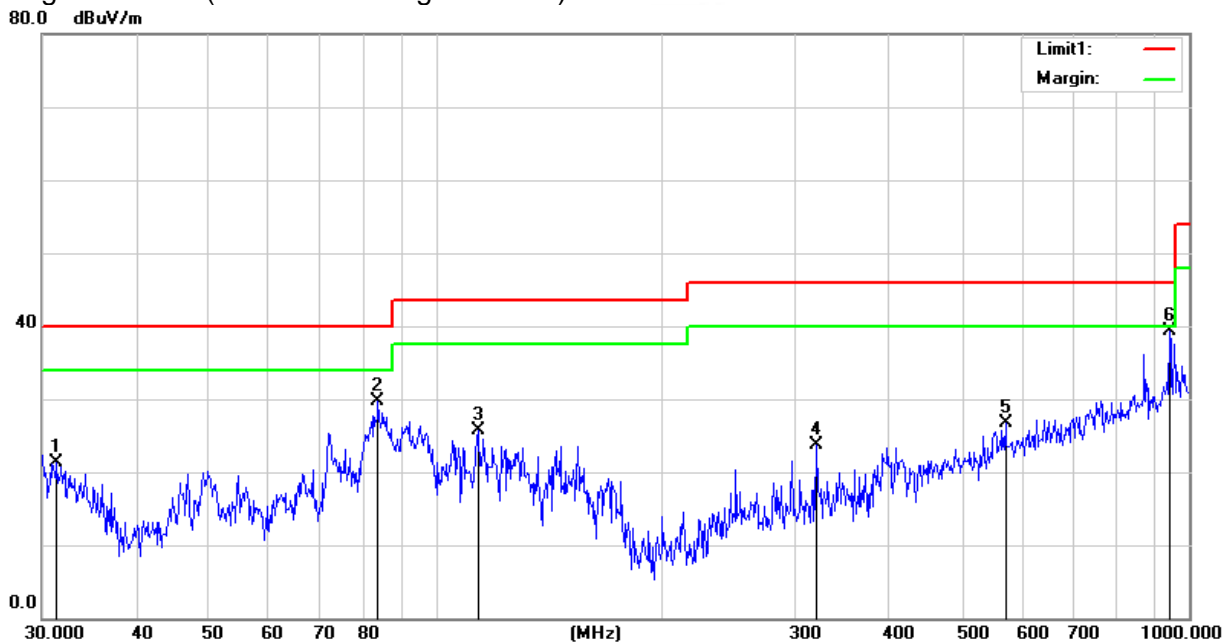



3.2.8 TEST RESULTS(Above 1000 MHz)

**Band I 5150-5250MHz**

Frequency (MHz)	Reading (dBuV)	Amplifier (dB)	Loss (dB)	Antenna Factor (dB/m)	Corrected Factor (dB)	Emission Level (dBμV/m)	Limit (dBuV/m)	Margin (dB)	Detector	Comment
Low Channel (802.11 a/ 5180 MHz)										
3265.24	44.89	44.70	6.70	28.20	-9.80	35.09	68.20	-33.11	Pk	Vertical
3265.24	41.20	44.70	6.70	28.20	-9.80	31.40	54.00	-22.60	AV	Vertical
3265.02	45.13	44.70	6.70	28.20	-9.80	35.33	68.20	-32.87	Pk	Horizontal
3265.02	41.07	44.70	6.70	28.20	-9.80	31.27	54.00	-22.73	AV	Horizontal
3996.85	39.06	44.20	7.90	29.70	-6.60	32.46	68.20	-35.74	Pk	Vertical
3996.85	36.80	44.20	7.90	29.70	-6.60	30.20	54.00	-23.80	AV	Vertical
3984.94	39.66	44.20	7.90	29.70	-6.60	33.06	68.20	-35.14	Pk	Horizontal
3984.94	36.32	44.20	7.90	29.70	-6.60	29.72	54.00	-24.28	AV	Horizontal
7217.69	36.98	43.50	11.40	35.50	3.40	40.38	68.20	-27.82	Pk	Vertical
7217.69	34.69	43.50	11.40	35.50	3.40	38.09	54.00	-15.91	AV	Vertical
7235.49	36.48	43.50	11.40	35.50	3.40	39.88	68.20	-28.32	Pk	Horizontal
7235.49	34.07	43.50	11.40	35.50	3.40	37.47	54.00	-16.53	AV	Horizontal
10360.22	39.42	44.50	13.80	38.80	8.10	47.52	68.20	-20.68	Pk	Vertical
10360.22	36.86	44.50	13.80	38.80	8.10	44.96	54.00	-9.04	AV	Vertical
10360.08	39.73	44.50	13.80	38.80	8.10	47.83	68.20	-20.37	Pk	Horizontal
10360.08	36.68	44.50	13.80	38.80	8.10	44.78	54.00	-9.22	AV	Horizontal
11026.72	33.76	43.60	14.30	39.50	10.20	43.96	68.20	-24.24	Pk	Vertical
11026.72	30.94	43.60	14.30	39.50	10.20	41.14	54.00	-12.86	AV	Vertical
11026.61	33.08	43.60	14.30	39.50	10.20	43.28	68.20	-24.92	Pk	Horizontal
11026.61	30.86	43.60	14.30	39.50	10.20	41.06	54.00	-12.94	AV	Horizontal
13296.08	32.74	42.60	15.90	38.90	12.20	44.94	68.20	-23.26	Pk	Vertical
13296.08	29.08	42.60	15.90	38.90	12.20	41.28	54.00	-12.72	AV	Vertical
13298.51	32.26	42.60	15.90	38.90	12.20	44.46	68.20	-23.74	Pk	Horizontal
13298.51	28.86	42.60	15.90	38.90	12.20	41.06	54.00	-12.94	AV	Horizontal



Mid Channel (802.11 a/ 5200 MHz)										
3251.47	44.01	44.70	6.70	28.20	-9.80	34.21	68.20	-33.99	Pk	Vertical
3251.47	41.36	44.70	6.70	28.20	-9.80	31.56	54.00	-22.44	AV	Vertical
3259.79	44.44	44.70	6.70	28.20	-9.80	34.64	68.20	-33.56	Pk	Horizontal
3259.79	40.98	44.70	6.70	28.20	-9.80	31.18	54.00	-22.82	AV	Horizontal
3999.87	38.99	44.20	7.90	29.70	-6.60	32.39	68.20	-35.81	Pk	Vertical
3999.87	36.77	44.20	7.90	29.70	-6.60	30.17	54.00	-23.83	AV	Vertical
3987.89	39.24	44.20	7.90	29.70	-6.60	32.64	68.20	-35.56	Pk	Horizontal
3987.89	36.69	44.20	7.90	29.70	-6.60	30.09	54.00	-23.91	AV	Horizontal
7216.92	36.61	43.50	11.40	35.50	3.40	40.01	68.20	-28.19	Pk	Vertical
7216.92	34.75	43.50	11.40	35.50	3.40	38.15	54.00	-15.85	AV	Vertical
7231.59	37.73	43.50	11.40	35.50	3.40	41.13	68.20	-27.07	Pk	Horizontal
7231.59	34.88	43.50	11.40	35.50	3.40	38.28	54.00	-15.72	AV	Horizontal
10400.01	40.16	44.50	13.80	38.80	8.10	48.26	68.20	-19.94	Pk	Vertical
10400.01	36.14	44.50	13.80	38.80	8.10	44.24	54.00	-9.76	AV	Vertical
10400.24	39.00	44.50	13.80	38.80	8.10	47.10	68.20	-21.10	Pk	Horizontal
10400.24	37.01	44.50	13.80	38.80	8.10	45.11	54.00	-8.89	AV	Horizontal
11034.60	33.16	43.60	14.30	39.50	10.20	43.36	68.20	-24.84	Pk	Vertical
11034.60	30.31	43.60	14.30	39.50	10.20	40.51	54.00	-13.49	AV	Vertical
11020.04	33.48	43.60	14.30	39.50	10.20	43.68	68.20	-24.52	Pk	Horizontal
11020.04	30.27	43.60	14.30	39.50	10.20	40.47	54.00	-13.53	AV	Horizontal
13282.91	32.33	42.60	15.90	38.90	12.20	44.53	68.20	-23.67	Pk	Vertical
13282.91	29.34	42.60	15.90	38.90	12.20	41.54	54.00	-12.46	AV	Vertical
13282.17	31.91	42.60	15.90	38.90	12.20	44.11	68.20	-24.09	Pk	Horizontal
13282.17	28.66	42.60	15.90	38.90	12.20	40.86	54.00	-13.14	AV	Horizontal



High Channel (802.11 a/ 5240 MHz)										
3246.30	44.72	44.70	6.70	28.20	-9.80	34.92	68.20	-33.28	Pk	Vertical
3246.30	41.94	44.70	6.70	28.20	-9.80	32.14	54.00	-21.86	AV	Vertical
3249.95	44.81	44.70	6.70	28.20	-9.80	35.01	68.20	-33.19	Pk	Horizontal
3249.95	41.26	44.70	6.70	28.20	-9.80	31.46	54.00	-22.54	AV	Horizontal
3988.88	38.95	44.20	7.90	29.70	-6.60	32.35	68.20	-35.85	Pk	Vertical
3988.88	35.90	44.20	7.90	29.70	-6.60	29.30	54.00	-24.70	AV	Vertical
3995.33	39.61	44.20	7.90	29.70	-6.60	33.01	68.20	-35.19	Pk	Horizontal
3995.33	36.92	44.20	7.90	29.70	-6.60	30.32	54.00	-23.68	AV	Horizontal
7219.83	37.47	43.50	11.40	35.50	3.40	40.87	68.20	-27.33	Pk	Vertical
7219.83	34.29	43.50	11.40	35.50	3.40	37.69	54.00	-16.31	AV	Vertical
7236.04	36.57	43.50	11.40	35.50	3.40	39.97	68.20	-28.23	Pk	Horizontal
7236.04	34.68	43.50	11.40	35.50	3.40	38.08	54.00	-15.92	AV	Horizontal
10480.30	39.38	44.50	13.80	38.80	8.10	47.48	68.20	-20.72	Pk	Vertical
10480.30	36.68	44.50	13.80	38.80	8.10	44.78	54.00	-9.22	AV	Vertical
10480.29	38.90	44.50	13.80	38.80	8.10	47.00	68.20	-21.20	Pk	Horizontal
10480.29	35.70	44.50	13.80	38.80	8.10	43.80	54.00	-10.20	AV	Horizontal
11018.15	32.99	43.60	14.30	39.50	10.20	43.19	68.20	-25.01	Pk	Vertical
11018.15	30.75	43.60	14.30	39.50	10.20	40.95	54.00	-13.05	AV	Vertical
11018.70	33.77	43.60	14.30	39.50	10.20	43.97	68.20	-24.23	Pk	Horizontal
11018.70	29.81	43.60	14.30	39.50	10.20	40.01	54.00	-13.99	AV	Horizontal
13297.99	33.00	42.60	15.90	38.90	12.20	45.20	68.20	-23.00	Pk	Vertical
13297.99	28.88	42.60	15.90	38.90	12.20	41.08	54.00	-12.92	AV	Vertical
13290.14	32.88	42.60	15.90	38.90	12.20	45.08	68.20	-23.12	Pk	Horizontal
13290.14	29.73	42.60	15.90	38.90	12.20	41.93	54.00	-12.07	AV	Horizontal

Remark:

- Factor = Antenna Factor + Cable Loss – Pre-amplifier.
- Scan with 802.11a, 802.11n (HT-20), 802.11n (HT-40), 802.11ac (VHT-20), 802.11ac (VHT-40), 802.11ac (VHT-80) the worst case is 802.11a.
- The frequency emission of peak points that did not show above the forms are at least 20dB below the limit, the frequency emission is mainly from the environment noise.

**Band II 5250-5350MHz**

Frequency (MHz)	Reading	Amplifier	Loss	Antenna Factor	Orrected Factor	Emission Level	Limit (dBuV/m)	Margin	Detector	Comment
	(dBuV)	(dB)	(dB)	(dB/m)	(dB)	(dBμV/m)		(dB)		
Low Channel (802.11 a/ 5260 MHz)										
3263.59	44.18	44.70	6.70	28.20	-9.80	34.38	68.20	-33.82	Pk	Vertical
3263.59	41.85	44.70	6.70	28.20	-9.80	32.05	54.00	-21.95	AV	Vertical
3258.87	45.02	44.70	6.70	28.20	-9.80	35.22	68.20	-32.98	Pk	Horizontal
3258.87	40.86	44.70	6.70	28.20	-9.80	31.06	54.00	-22.94	AV	Horizontal
3989.74	39.02	44.20	7.90	29.70	-6.60	32.42	68.20	-35.78	Pk	Vertical
3989.74	36.40	44.20	7.90	29.70	-6.60	29.80	54.00	-24.20	AV	Vertical
3995.87	39.80	44.20	7.90	29.70	-6.60	33.20	68.20	-35.00	Pk	Horizontal
3995.87	36.40	44.20	7.90	29.70	-6.60	29.80	54.00	-24.20	AV	Horizontal
7220.21	37.27	43.50	11.40	35.50	3.40	40.67	68.20	-27.53	Pk	Vertical
7220.21	33.94	43.50	11.40	35.50	3.40	37.34	54.00	-16.66	AV	Vertical
7231.52	37.39	43.50	11.40	35.50	3.40	40.79	68.20	-27.41	Pk	Horizontal
7231.52	34.40	43.50	11.40	35.50	3.40	37.80	54.00	-16.20	AV	Horizontal
10520.33	39.48	44.50	13.90	38.80	8.20	47.68	68.20	-20.52	Pk	Vertical
10520.33	35.77	44.50	13.90	38.80	8.20	43.97	54.00	-10.03	AV	Vertical
10520.12	39.63	44.50	13.90	38.80	8.20	47.83	68.20	-20.37	Pk	Horizontal
10520.12	35.87	44.50	13.90	38.80	8.20	44.07	54.00	-9.93	AV	Horizontal
11035.59	33.82	43.60	14.30	39.50	10.20	44.02	68.20	-24.18	Pk	Vertical
11035.59	31.15	43.60	14.30	39.50	10.20	41.35	54.00	-12.65	AV	Vertical
11016.84	32.86	43.60	14.30	39.50	10.20	43.06	68.20	-25.14	Pk	Horizontal
11016.84	30.83	43.60	14.30	39.50	10.20	41.03	54.00	-12.97	AV	Horizontal
13297.38	32.94	42.60	15.90	38.90	12.20	45.14	68.20	-23.06	Pk	Vertical
13297.38	29.61	42.60	15.90	38.90	12.20	41.81	54.00	-12.19	AV	Vertical
13280.12	32.94	42.60	15.90	38.90	12.20	45.14	68.20	-23.06	Pk	Horizontal
13280.12	29.36	42.60	15.90	38.90	12.20	41.56	54.00	-12.44	AV	Horizontal



Mid Channel (802.11 a/ 5300 MHz)										
3256.57	45.20	44.70	6.70	28.20	-9.80	35.40	68.20	-32.80	Pk	Vertical
3256.57	42.21	44.70	6.70	28.20	-9.80	32.41	54.00	-21.59	AV	Vertical
3261.11	43.88	44.70	6.70	28.20	-9.80	34.08	68.20	-34.12	Pk	Horizontal
3261.11	42.20	44.70	6.70	28.20	-9.80	32.40	54.00	-21.60	AV	Horizontal
3980.39	40.03	44.20	7.90	29.70	-6.60	33.43	68.20	-34.77	Pk	Vertical
3980.39	35.68	44.20	7.90	29.70	-6.60	29.08	54.00	-24.92	AV	Vertical
4000.01	39.15	44.20	7.90	29.70	-6.60	32.55	68.20	-35.65	Pk	Horizontal
4000.01	36.23	44.20	7.90	29.70	-6.60	29.63	54.00	-24.37	AV	Horizontal
7232.40	36.44	43.50	11.40	35.50	3.40	39.84	68.20	-28.36	Pk	Vertical
7232.40	34.55	43.50	11.40	35.50	3.40	37.95	54.00	-16.05	AV	Vertical
7225.42	37.61	43.50	11.40	35.50	3.40	41.01	68.20	-27.19	Pk	Horizontal
7225.42	34.93	43.50	11.40	35.50	3.40	38.33	54.00	-15.67	AV	Horizontal
10599.99	38.81	44.50	13.80	38.80	8.10	46.91	68.20	-21.29	Pk	Vertical
10599.99	36.72	44.50	13.80	38.80	8.10	44.82	54.00	-9.18	AV	Vertical
10599.95	39.23	44.50	13.80	38.80	8.10	47.33	68.20	-20.87	Pk	Horizontal
10599.95	36.77	44.50	13.80	38.80	8.10	44.87	54.00	-9.13	AV	Horizontal
11024.71	33.15	43.60	14.30	39.50	10.20	43.35	68.20	-24.85	Pk	Vertical
11024.71	30.26	43.60	14.30	39.50	10.20	40.46	54.00	-13.54	AV	Vertical
11034.50	33.57	43.60	14.30	39.50	10.20	43.77	68.20	-24.43	Pk	Horizontal
11034.50	30.70	43.60	14.30	39.50	10.20	40.90	54.00	-13.10	AV	Horizontal
13287.85	31.74	42.60	15.90	38.90	12.20	43.94	68.20	-24.26	Pk	Vertical
13287.85	29.22	42.60	15.90	38.90	12.20	41.42	54.00	-12.58	AV	Vertical
13291.13	31.70	42.60	15.90	38.90	12.20	43.90	68.20	-24.30	Pk	Horizontal
13291.13	29.59	42.60	15.90	38.90	12.20	41.79	54.00	-12.21	AV	Horizontal



High Channel (802.11 a/ 5320 MHz)										
3259.33	44.21	44.70	6.70	28.20	-9.80	34.41	68.20	-33.79	Pk	Vertical
3259.33	42.02	44.70	6.70	28.20	-9.80	32.22	54.00	-21.78	AV	Vertical
3263.91	44.85	44.70	6.70	28.20	-9.80	35.05	68.20	-33.15	Pk	Horizontal
3263.91	41.96	44.70	6.70	28.20	-9.80	32.16	54.00	-21.84	AV	Horizontal
3984.32	39.49	44.20	7.90	29.70	-6.60	32.89	68.20	-35.31	Pk	Vertical
3984.32	36.20	44.20	7.90	29.70	-6.60	29.60	54.00	-24.40	AV	Vertical
3988.97	38.69	44.20	7.90	29.70	-6.60	32.09	68.20	-36.11	Pk	Horizontal
3988.97	36.35	44.20	7.90	29.70	-6.60	29.75	54.00	-24.25	AV	Horizontal
7231.59	37.34	43.50	11.40	35.50	3.40	40.74	68.20	-27.46	Pk	Vertical
7231.59	34.89	43.50	11.40	35.50	3.40	38.29	54.00	-15.71	AV	Vertical
7218.74	37.91	43.50	11.40	35.50	3.40	41.31	68.20	-26.89	Pk	Horizontal
7218.74	34.91	43.50	11.40	35.50	3.40	38.31	54.00	-15.69	AV	Horizontal
10640.01	38.93	44.50	13.80	38.80	8.10	47.03	68.20	-21.17	Pk	Vertical
10640.01	36.08	44.50	13.80	38.80	8.10	44.18	54.00	-9.82	AV	Vertical
10640.07	38.81	44.50	13.80	38.80	8.10	46.91	68.20	-21.29	Pk	Horizontal
10640.07	36.82	44.50	13.80	38.80	8.10	44.92	54.00	-9.08	AV	Horizontal
11026.50	34.15	43.60	14.30	39.50	10.20	44.35	68.20	-23.85	Pk	Vertical
11026.50	30.96	43.60	14.30	39.50	10.20	41.16	54.00	-12.84	AV	Vertical
11020.38	33.77	43.60	14.30	39.50	10.20	43.97	68.20	-24.23	Pk	Horizontal
11020.38	30.27	43.60	14.30	39.50	10.20	40.47	54.00	-13.53	AV	Horizontal
13296.02	32.55	42.70	18.00	37.10	12.40	44.95	68.20	-23.25	Pk	Vertical
13296.02	29.88	42.70	18.00	37.10	12.40	42.28	54.00	-11.72	AV	Vertical
13287.75	32.47	42.70	18.00	37.10	12.40	44.87	68.20	-23.33	Pk	Horizontal
13287.75	29.08	42.70	18.00	37.10	12.40	41.48	54.00	-12.52	AV	Horizontal

## Remark:

1. Factor = Antenna Factor + Cable Loss – Pre-amplifier.
2. Scan with 802.11a, 802.11n (HT-20), 802.11n (HT-40), 802.11ac (VHT-20), 802.11ac (VHT-40), 802.11ac (VHT-80) the worst case is 802.11a.
3. The frequency emission of peak points that did not show above the forms are at least 20dB below the limit, the frequency emission is mainly from the environment noise.



## Band III 5470-5725MHz

Frequency (MHz)	Reading	Amplifier	Loss	Antenna Factor	Orrected Factor	Emission Level	Limit (dBuV/m)	Margin	Detector	Comment
	(dBuV)	(dB)	(dB)	(dB/m)	(dB)	(dBuV/m)		(dB)		
Low Channel (802.11 a/ 5500 MHz)										
3260.10	45.25	44.70	6.70	28.20	-9.80	35.45	68.20	-32.75	Pk	Vertical
3260.10	41.17	44.70	6.70	28.20	-9.80	31.37	54.00	-22.63	AV	Vertical
3255.04	43.76	44.70	6.70	28.20	-9.80	33.96	68.20	-34.24	Pk	Horizontal
3255.04	41.53	44.70	6.70	28.20	-9.80	31.73	54.00	-22.27	AV	Horizontal
3983.28	38.91	44.20	7.90	29.70	-6.60	32.31	68.20	-35.89	Pk	Vertical
3983.28	36.15	44.20	7.90	29.70	-6.60	29.55	54.00	-24.45	AV	Vertical
3995.85	39.08	44.20	7.90	29.70	-6.60	32.48	68.20	-35.72	Pk	Horizontal
3995.85	36.27	44.20	7.90	29.70	-6.60	29.67	54.00	-24.33	AV	Horizontal
7222.04	36.83	43.50	11.40	35.50	3.40	40.23	68.20	-27.97	Pk	Vertical
7222.04	33.91	43.50	11.40	35.50	3.40	37.31	54.00	-16.69	AV	Vertical
7232.72	36.65	43.50	11.40	35.50	3.40	40.05	68.20	-28.15	Pk	Horizontal
7232.72	34.26	43.50	11.40	35.50	3.40	37.66	54.00	-16.34	AV	Horizontal
10350.39	39.78	44.50	13.80	38.80	8.10	47.88	68.20	-20.32	Pk	Vertical
10350.39	36.47	44.50	13.80	38.80	8.10	44.57	54.00	-9.43	AV	Vertical
10358.80	38.71	44.50	13.80	38.80	8.10	46.81	68.20	-21.39	Pk	Horizontal
10358.80	37.01	44.50	13.80	38.80	8.10	45.11	54.00	-8.89	AV	Horizontal
11000.36	33.53	43.60	14.30	39.50	10.20	43.73	68.20	-24.47	Pk	Vertical
11000.36	30.03	43.60	14.30	39.50	10.20	40.23	54.00	-13.77	AV	Vertical
11000.04	33.97	43.60	14.30	39.50	10.20	44.17	68.20	-24.03	Pk	Horizontal
11000.04	30.77	43.60	14.30	39.50	10.20	40.97	54.00	-13.03	AV	Horizontal
13297.63	32.55	42.60	15.90	38.90	12.20	44.75	68.20	-23.45	Pk	Vertical
13297.63	29.20	42.60	15.90	38.90	12.20	41.40	54.00	-12.60	AV	Vertical
13280.52	32.83	42.60	15.90	38.90	12.20	45.03	68.20	-23.17	Pk	Horizontal
13280.52	29.07	42.60	15.90	38.90	12.20	41.27	54.00	-12.73	AV	Horizontal





Mid Channel (802.11 a/ 5580 MHz)										
3253.25	45.23	44.70	6.70	28.20	-9.80	35.43	68.20	-32.77	Pk	Vertical
3253.25	41.90	44.70	6.70	28.20	-9.80	32.10	54.00	-21.90	AV	Vertical
3260.56	44.61	44.70	6.70	28.20	-9.80	34.81	68.20	-33.39	Pk	Horizontal
3260.56	42.19	44.70	6.70	28.20	-9.80	32.39	54.00	-21.61	AV	Horizontal
3993.36	39.99	44.20	7.90	29.70	-6.60	33.39	68.20	-34.81	Pk	Vertical
3993.36	35.92	44.20	7.90	29.70	-6.60	29.32	54.00	-24.68	AV	Vertical
4000.16	38.75	44.20	7.90	29.70	-6.60	32.15	68.20	-36.05	Pk	Horizontal
4000.16	35.71	44.20	7.90	29.70	-6.60	29.11	54.00	-24.89	AV	Horizontal
7230.96	37.30	43.50	11.40	35.50	3.40	40.70	68.20	-27.50	Pk	Vertical
7230.96	34.21	43.50	11.40	35.50	3.40	37.61	54.00	-16.39	AV	Vertical
7233.65	37.31	43.50	11.40	35.50	3.40	40.71	68.20	-27.49	Pk	Horizontal
7233.65	33.78	43.50	11.40	35.50	3.40	37.18	54.00	-16.82	AV	Horizontal
10394.54	40.16	44.50	13.80	38.80	8.10	48.26	68.20	-19.94	Pk	Vertical
10394.54	36.59	44.50	13.80	38.80	8.10	44.69	54.00	-9.31	AV	Vertical
10382.41	39.16	44.50	13.80	38.80	8.10	47.26	68.20	-20.94	Pk	Horizontal
10382.41	36.45	44.50	13.80	38.80	8.10	44.55	54.00	-9.45	AV	Horizontal
11160.12	32.96	43.60	14.30	39.50	10.20	43.16	68.20	-25.04	Pk	Vertical
11160.12	31.02	43.60	14.30	39.50	10.20	41.22	54.00	-12.78	AV	Vertical
11160.32	33.63	43.60	14.30	39.50	10.20	43.83	68.20	-24.37	Pk	Horizontal
11160.32	30.92	43.60	14.30	39.50	10.20	41.12	54.00	-12.88	AV	Horizontal
13288.68	31.89	42.60	15.90	38.90	12.20	44.09	68.20	-24.11	Pk	Vertical
13288.68	29.07	42.60	15.90	38.90	12.20	41.27	54.00	-12.73	AV	Vertical
13296.38	32.76	42.60	15.90	38.90	12.20	44.96	68.20	-23.24	Pk	Horizontal
13296.38	29.14	42.60	15.90	38.90	12.20	41.34	54.00	-12.66	AV	Horizontal



High Channel (802.11 a/ 5700 MHz)										
3249.51	44.69	44.70	6.70	28.20	-9.80	34.89	68.20	-33.31	Pk	Vertical
3249.51	40.84	44.70	6.70	28.20	-9.80	31.04	54.00	-22.96	AV	Vertical
3264.73	44.76	44.70	6.70	28.20	-9.80	34.96	68.20	-33.24	Pk	Horizontal
3264.73	42.01	44.70	6.70	28.20	-9.80	32.21	54.00	-21.79	AV	Horizontal
3987.46	38.82	44.20	7.90	29.70	-6.60	32.22	68.20	-35.98	Pk	Vertical
3987.46	36.78	44.20	7.90	29.70	-6.60	30.18	54.00	-23.82	AV	Vertical
3990.07	39.42	44.20	7.90	29.70	-6.60	32.82	68.20	-35.38	Pk	Horizontal
3990.07	36.56	44.20	7.90	29.70	-6.60	29.96	54.00	-24.04	AV	Horizontal
7218.37	37.32	43.50	11.40	35.50	3.40	40.72	68.20	-27.48	Pk	Vertical
7218.37	33.54	43.50	11.40	35.50	3.40	36.94	54.00	-17.06	AV	Vertical
7223.20	36.65	43.50	11.40	35.50	3.40	40.05	68.20	-28.15	Pk	Horizontal
7223.20	34.81	43.50	11.40	35.50	3.40	38.21	54.00	-15.79	AV	Horizontal
10467.48	38.96	44.50	13.80	38.80	8.10	47.06	68.20	-21.14	Pk	Vertical
10467.48	36.43	44.50	13.80	38.80	8.10	44.53	54.00	-9.47	AV	Vertical
10469.30	38.88	44.50	13.80	38.80	8.10	46.98	68.20	-21.22	Pk	Horizontal
10469.30	36.05	44.50	13.80	38.80	8.10	44.15	54.00	-9.85	AV	Horizontal
11400.11	34.04	43.60	14.30	39.50	10.20	44.24	68.20	-23.96	Pk	Vertical
11400.11	30.63	43.60	14.30	39.50	10.20	40.83	54.00	-13.17	AV	Vertical
11400.07	34.05	43.60	14.30	39.50	10.20	44.25	68.20	-23.95	Pk	Horizontal
11400.07	30.81	43.60	14.30	39.50	10.20	41.01	54.00	-12.99	AV	Horizontal
13288.74	33.00	42.60	15.90	38.90	12.20	45.20	68.20	-23.00	Pk	Vertical
13288.74	28.64	42.60	15.90	38.90	12.20	40.84	54.00	-13.16	AV	Vertical
13286.64	31.67	42.60	15.90	38.90	12.20	43.87	68.20	-24.33	Pk	Horizontal
13286.64	29.98	42.60	15.90	38.90	12.20	42.18	54.00	-11.82	AV	Horizontal

Remark:

1. Factor = Antenna Factor + Cable Loss – Pre-amplifier.
2. Scan with 802.11a, 802.11n (HT-20), 802.11n (HT-40), 802.11ac (VHT-20), 802.11ac (VHT-40), 802.11ac (VHT-80) the worst case is 802.11a.
3. The frequency emission of peak points that did not show above the forms are at least 20dB below the limit, the frequency emission is mainly from the environment noise.



**Band IV(5.725-5.850) GHz**

Frequency (MHz)	Reading	Amplifier	Loss	Antenna Factor	Orrected Factor	Emission Level	Limit (dBuV/m)	Margin	Detector	Comment
	(dBuV)	(dB)	(dB)	(dB/m)	(dB)	(dBμV/m)		(dB)		
Low Channel (802.11 a/ 5745 MHz)										
3259.71	44.32	44.70	6.70	28.20	-9.80	34.52	68.20	-33.68	Pk	Vertical
3259.71	40.77	44.70	6.70	28.20	-9.80	30.97	54.00	-23.03	AV	Vertical
3252.23	44.17	44.70	6.70	28.20	-9.80	34.37	68.20	-33.83	Pk	Horizontal
3252.23	41.75	44.70	6.70	28.20	-9.80	31.95	54.00	-22.05	AV	Horizontal
3989.49	39.93	44.20	7.90	29.70	-6.60	33.33	68.20	-34.87	Pk	Vertical
3989.49	37.00	44.20	7.90	29.70	-6.60	30.40	54.00	-23.60	AV	Vertical
3982.02	38.87	44.20	7.90	29.70	-6.60	32.27	68.20	-35.93	Pk	Horizontal
3982.02	36.42	44.20	7.90	29.70	-6.60	29.82	54.00	-24.18	AV	Horizontal
7226.97	37.75	43.50	11.40	35.50	3.40	41.15	68.20	-27.05	Pk	Vertical
7226.97	34.89	43.50	11.40	35.50	3.40	38.29	54.00	-15.71	AV	Vertical
7226.34	37.57	43.50	11.40	35.50	3.40	40.97	68.20	-27.23	Pk	Horizontal
7226.34	34.12	43.50	11.40	35.50	3.40	37.52	54.00	-16.48	AV	Horizontal
10503.40	39.38	44.50	13.90	38.80	8.20	47.58	68.20	-20.62	Pk	Vertical
10503.40	36.34	44.50	13.90	38.80	8.20	44.54	54.00	-9.46	AV	Vertical
10505.06	39.53	44.50	13.90	38.80	8.20	47.73	68.20	-20.47	Pk	Horizontal
10505.06	36.26	44.50	13.90	38.80	8.20	44.46	54.00	-9.54	AV	Horizontal
11490.20	32.71	43.60	14.30	39.50	10.20	42.91	68.20	-25.29	Pk	Vertical
11490.20	29.94	43.60	14.30	39.50	10.20	40.14	54.00	-13.86	AV	Vertical
11490.36	33.09	43.60	14.30	39.50	10.20	43.29	68.20	-24.91	Pk	Horizontal
11490.36	29.86	43.60	14.30	39.50	10.20	40.06	54.00	-13.94	AV	Horizontal
13298.11	31.91	42.60	15.90	38.90	12.20	44.11	68.20	-24.09	Pk	Vertical
13298.11	28.59	42.60	15.90	38.90	12.20	40.79	54.00	-13.21	AV	Vertical
13297.92	31.67	42.60	15.90	38.90	12.20	43.87	68.20	-24.33	Pk	Horizontal
13297.92	28.80	42.60	15.90	38.90	12.20	41.00	54.00	-13.00	AV	Horizontal



Mid Channel (802.11 a/ 5785 MHz)										
3253.26	44.67	44.70	6.70	28.20	-9.80	34.87	68.20	-33.33	Pk	Vertical
3253.26	40.85	44.70	6.70	28.20	-9.80	31.05	54.00	-22.95	AV	Vertical
3250.77	44.29	44.70	6.70	28.20	-9.80	34.49	68.20	-33.71	Pk	Horizontal
3250.77	42.20	44.70	6.70	28.20	-9.80	32.40	54.00	-21.60	AV	Horizontal
3985.28	39.77	44.20	7.90	29.70	-6.60	33.17	68.20	-35.03	Pk	Vertical
3985.28	36.38	44.20	7.90	29.70	-6.60	29.78	54.00	-24.22	AV	Vertical
3983.97	39.46	44.20	7.90	29.70	-6.60	32.86	68.20	-35.34	Pk	Horizontal
3983.97	36.50	44.20	7.90	29.70	-6.60	29.90	54.00	-24.10	AV	Horizontal
7230.87	36.98	43.50	11.40	35.50	3.40	40.38	68.20	-27.82	Pk	Vertical
7230.87	33.65	43.50	11.40	35.50	3.40	37.05	54.00	-16.95	AV	Vertical
7220.79	37.21	43.50	11.40	35.50	3.40	40.61	68.20	-27.59	Pk	Horizontal
7220.79	34.75	43.50	11.40	35.50	3.40	38.15	54.00	-15.85	AV	Horizontal
10582.02	38.78	44.50	13.80	38.80	8.10	46.88	68.20	-21.32	Pk	Vertical
10582.02	37.02	44.50	13.80	38.80	8.10	45.12	54.00	-8.88	AV	Vertical
10587.87	39.36	44.50	13.80	38.80	8.10	47.46	68.20	-20.74	Pk	Horizontal
10587.87	35.70	44.50	13.80	38.80	8.10	43.80	54.00	-10.20	AV	Horizontal
11570.12	33.24	43.60	14.30	39.50	10.20	43.44	68.20	-24.76	Pk	Vertical
11570.12	30.11	43.60	14.30	39.50	10.20	40.31	54.00	-13.69	AV	Vertical
11570.05	33.01	43.60	14.30	39.50	10.20	43.21	68.20	-24.99	Pk	Horizontal
11570.05	30.46	43.60	14.30	39.50	10.20	40.66	54.00	-13.34	AV	Horizontal
13282.89	32.82	42.60	15.90	38.90	12.20	45.02	68.20	-23.18	Pk	Vertical
13282.89	29.47	42.60	15.90	38.90	12.20	41.67	54.00	-12.33	AV	Vertical
13289.80	31.71	42.60	15.90	38.90	12.20	43.91	68.20	-24.29	Pk	Horizontal
13289.80	29.01	42.60	15.90	38.90	12.20	41.21	54.00	-12.79	AV	Horizontal



High Channel (802.11 a/ 5825 MHz)										
3251.59	44.90	44.70	6.70	28.20	-9.80	35.10	68.20	-33.10	Pk	Vertical
3251.59	41.58	44.70	6.70	28.20	-9.80	31.78	54.00	-22.22	AV	Vertical
3246.41	44.53	44.70	6.70	28.20	-9.80	34.73	68.20	-33.47	Pk	Horizontal
3246.41	41.43	44.70	6.70	28.20	-9.80	31.63	54.00	-22.37	AV	Horizontal
3995.90	39.52	44.20	7.90	29.70	-6.60	32.92	68.20	-35.28	Pk	Vertical
3995.90	36.64	44.20	7.90	29.70	-6.60	30.04	54.00	-23.96	AV	Vertical
3995.92	39.03	44.20	7.90	29.70	-6.60	32.43	68.20	-35.77	Pk	Horizontal
3995.92	35.68	44.20	7.90	29.70	-6.60	29.08	54.00	-24.92	AV	Horizontal
7217.12	36.47	43.50	11.40	35.50	3.40	39.87	68.20	-28.33	Pk	Vertical
7217.12	33.79	43.50	11.40	35.50	3.40	37.19	54.00	-16.81	AV	Vertical
7231.88	37.59	43.50	11.40	35.50	3.40	40.99	68.20	-27.21	Pk	Horizontal
7231.88	34.46	43.50	11.40	35.50	3.40	37.86	54.00	-16.14	AV	Horizontal
10623.30	39.80	44.50	13.80	38.80	8.10	47.90	68.20	-20.30	Pk	Vertical
10623.30	36.70	44.50	13.80	38.80	8.10	44.80	54.00	-9.20	AV	Vertical
10639.94	39.60	44.50	13.80	38.80	8.10	47.70	68.20	-20.50	Pk	Horizontal
10639.94	36.30	44.50	13.80	38.80	8.10	44.40	54.00	-9.60	AV	Horizontal
11650.37	34.12	43.60	14.30	39.50	10.20	44.32	68.20	-23.88	Pk	Vertical
11650.37	29.76	43.60	14.30	39.50	10.20	39.96	54.00	-14.04	AV	Vertical
11650.00	33.78	43.60	14.30	39.50	10.20	43.98	68.20	-24.22	Pk	Horizontal
11650.00	30.34	43.60	14.30	39.50	10.20	40.54	54.00	-13.46	AV	Horizontal
13286.36	32.16	42.70	18.00	37.10	12.40	44.56	68.20	-23.64	Pk	Vertical
13286.36	29.37	42.70	18.00	37.10	12.40	41.77	54.00	-12.23	AV	Vertical
13290.64	32.17	42.70	18.00	37.10	12.40	44.57	68.20	-23.63	Pk	Horizontal
13290.64	29.74	42.70	18.00	37.10	12.40	42.14	54.00	-11.86	AV	Horizontal

Remark:

1. Factor = Antenna Factor + Cable Loss – Pre-amplifier.
2. Scan with 802.11a, 802.11n (HT-20), 802.11n (HT-40), 802.11ac (VHT-20), 802.11ac (VHT-40), 802.11ac (VHT-80) the worst case is 802.11a.
3. The frequency emission of peak points that did not show above the forms are at least 20dB below the limit, the frequency emission is mainly from the environment noise.



3.2.9 Band Edge  
Band I 5150-5250MHz

802.11n(HT20) Low  
Horizontal

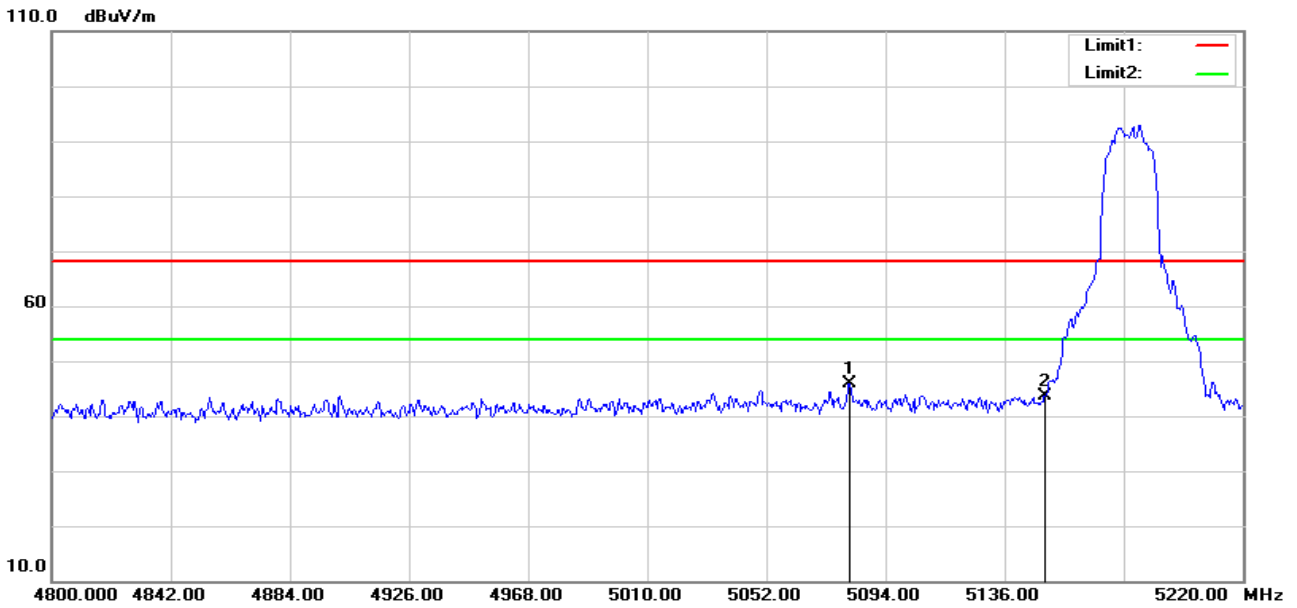

No.	Frequency (MHz)	Reading (dBuV)	Correct Factor(dB/m)	Result (dBuV/m)	Limit (dBuV/m)	Margin (dB)	Remark
1	5081.400	51.62	-5.82	45.80	68.20	-22.40	peak
2	5150.000	49.28	-5.73	43.55	68.20	-24.65	peak

Vertical

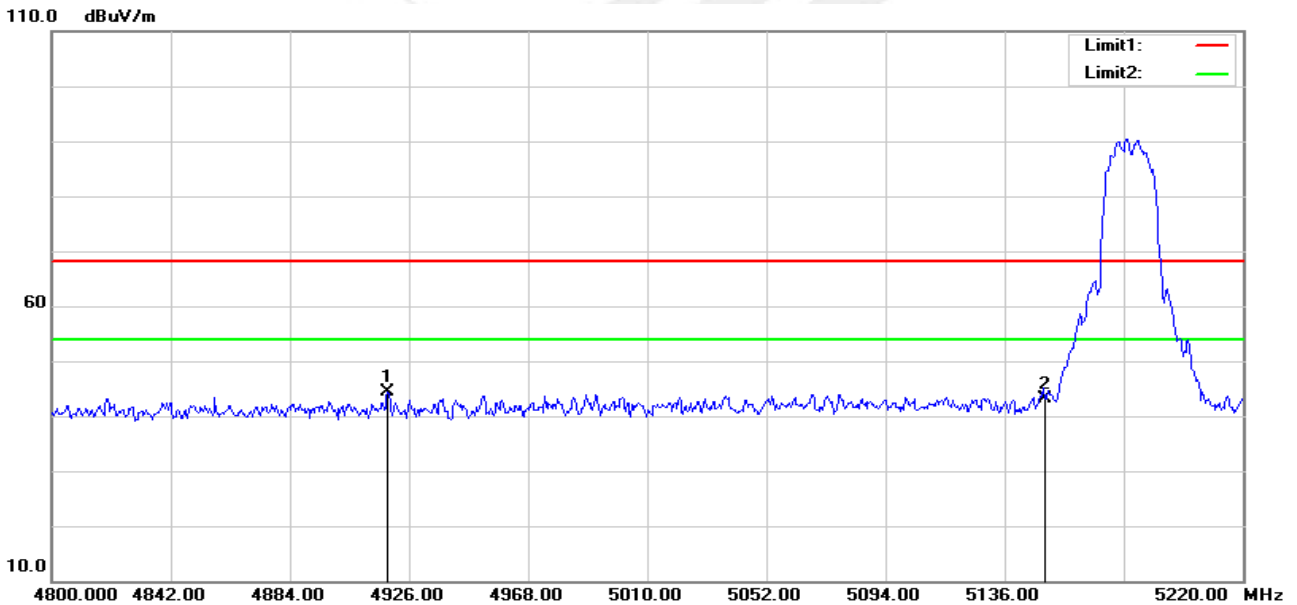

No.	Frequency (MHz)	Reading (dBuV)	Correct Factor(dB/m)	Result (dBuV/m)	Limit (dBuV/m)	Margin (dB)	Remark
1	4918.440	51.05	-6.72	44.33	68.20	-23.87	peak
2	5150.000	48.87	-5.73	43.14	68.20	-25.06	peak



802.11n(HT20)High  
Horizontal

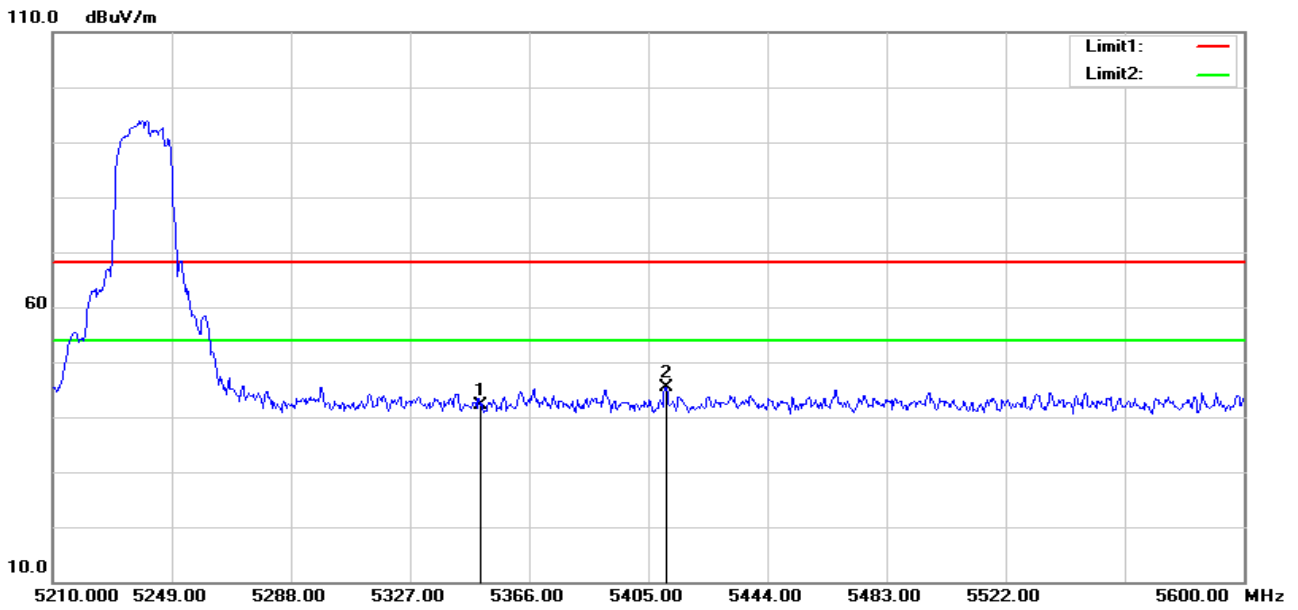

No.	Frequency (MHz)	Reading (dBuV)	Correct Factor(dB/m)	Result (dBuV/m)	Limit (dBuV/m)	Margin (dB)	Remark
1	5350.000	47.40	-5.23	42.17	68.20	-26.03	peak
2	5410.850	50.55	-5.22	45.33	68.20	-22.87	peak

Vertical

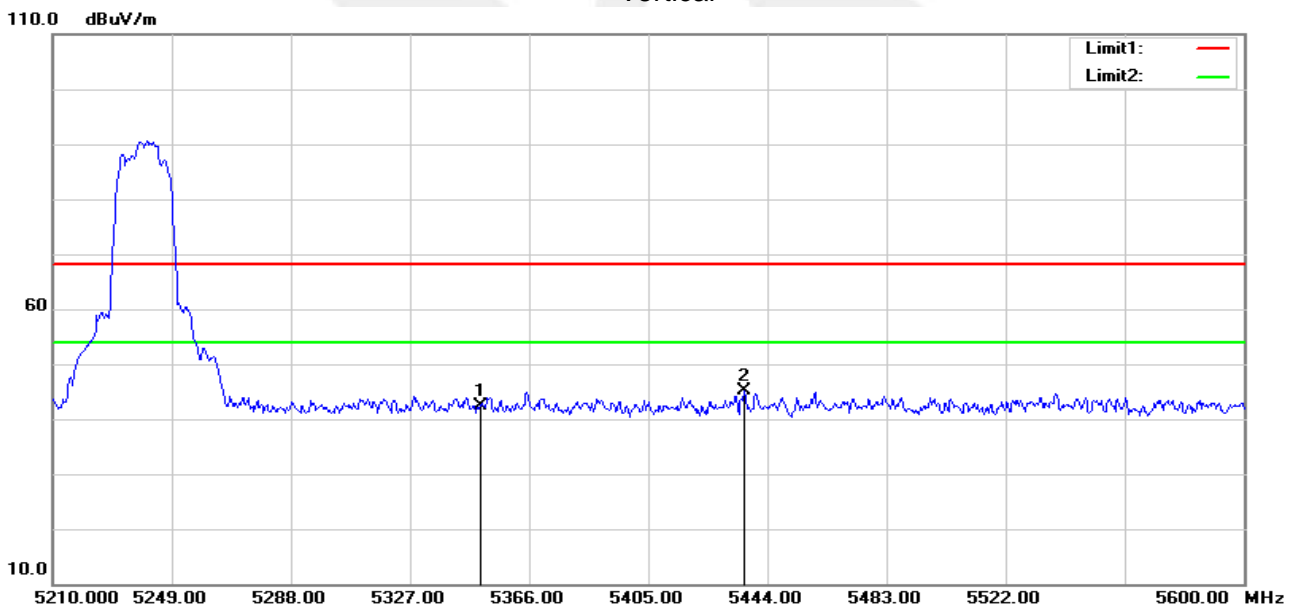

No.	Frequency (MHz)	Reading (dBuV)	Correct Factor(dB/m)	Result (dBuV/m)	Limit (dBuV/m)	Margin (dB)	Remark
1	5350.000	47.50	-5.23	42.27	68.20	-25.93	peak
2	5436.590	50.22	-5.17	45.05	68.20	-23.15	peak

Note:802.11a,802.11n (HT-20),802.11n (HT-40), 802.11ac (VHT-20),802.11ac (VHT-40), 802.11ac (VHT-80) all has been tested, the worst case is 802.11n(HT20),only shown the worst case.



Band II 5250-5350MHz

802.11a Low Horizontal

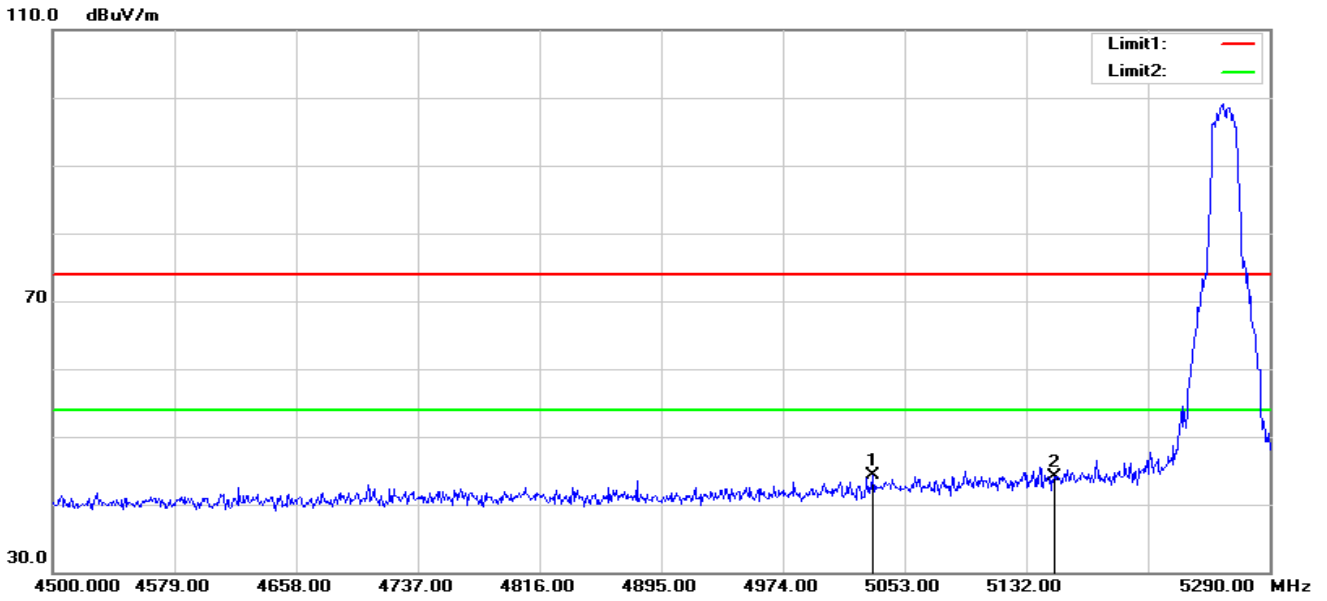

No.	Frequency (MHz)	Reading (dBuV)	Correct Factor(dB/m)	Result (dBuV/m)	Limit (dBuV/m)	Margin (dB)	Remark
1	5032.460	50.37	-6.04	44.33	68.20	-23.87	peak
2	5150.000	49.82	-5.73	44.09	68.20	-24.11	peak

Vertical

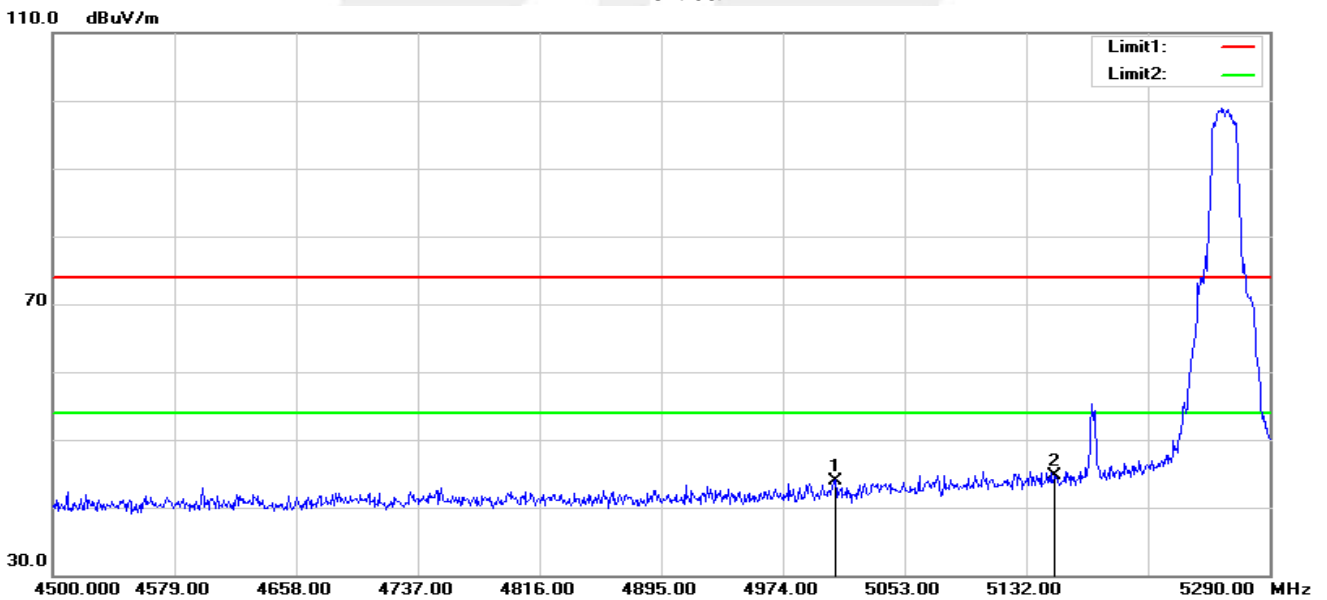

No.	Frequency (MHz)	Reading (dBuV)	Correct Factor(dB/m)	Result (dBuV/m)	Limit (dBuV/m)	Margin (dB)	Remark
1	5007.970	50.15	-6.15	44.00	68.20	-24.20	peak
2	5150.000	50.35	-5.73	44.62	68.20	-23.58	peak





802.11a High  
Horizontal

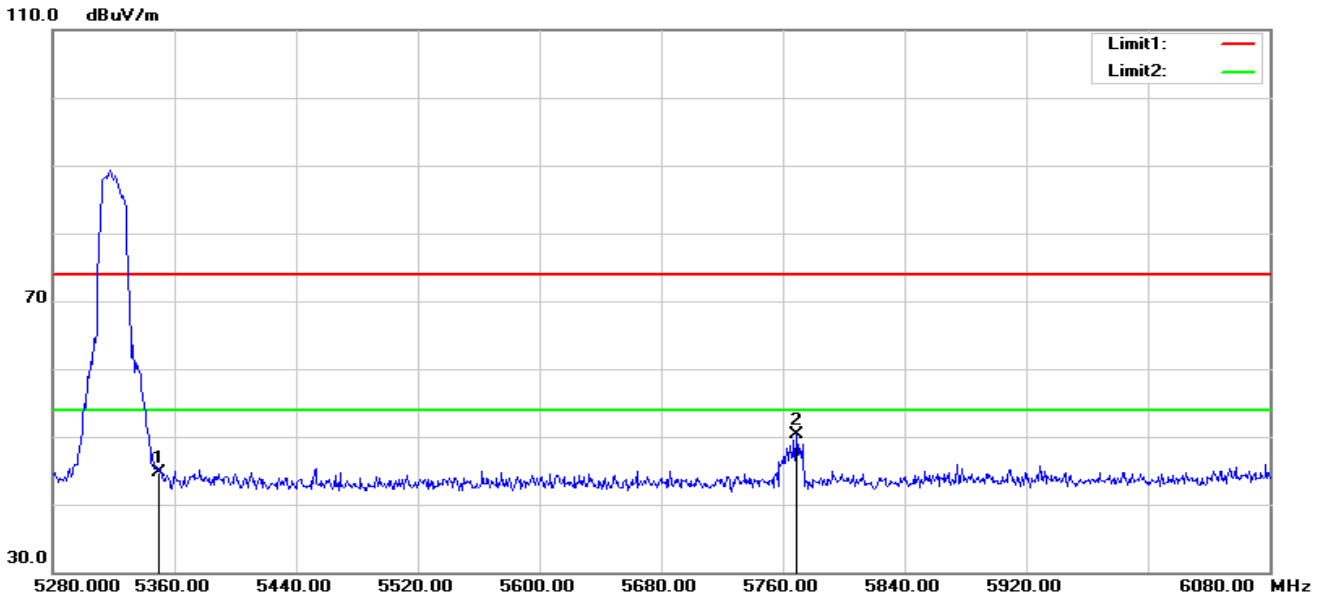

No.	Frequency (MHz)	Reading (dBuV)	Correct Factor(dB/m)	Result (dBuV/m)	Limit (dBuV/m)	Margin (dB)	Remark
1	5350.000	49.96	-5.23	44.73	68.20	-23.47	peak
2	5768.800	54.83	-4.43	50.40	68.20	-17.80	peak

Vertical

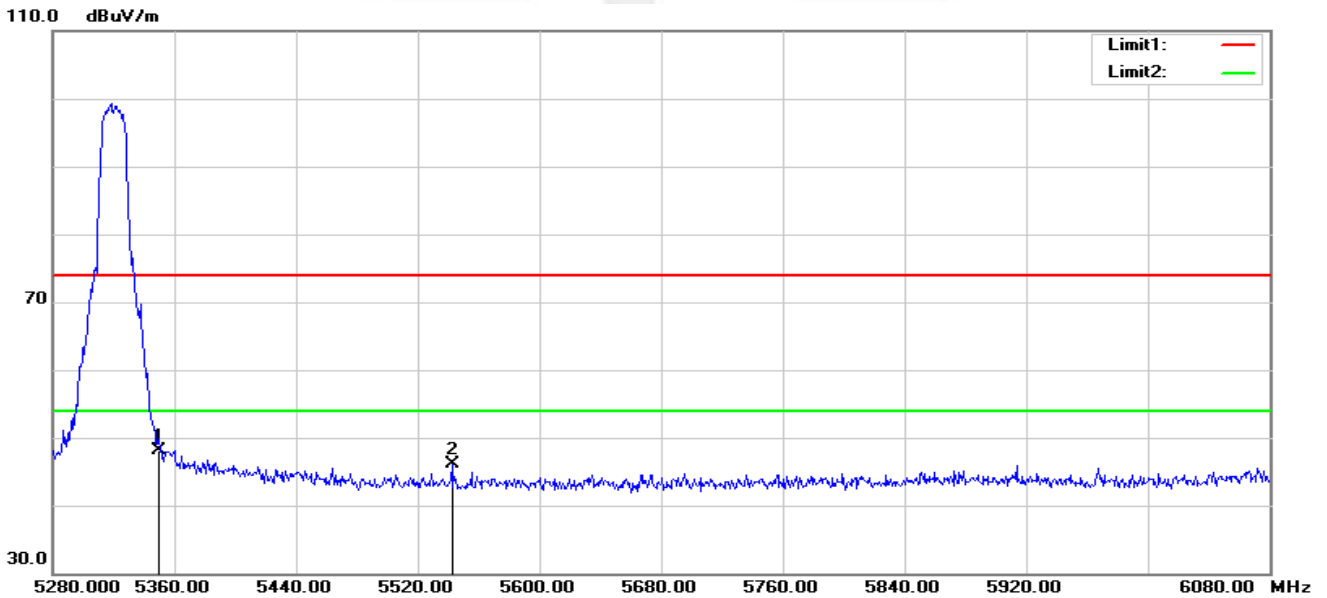

No.	Frequency (MHz)	Reading (dBuV)	Correct Factor(dB/m)	Result (dBuV/m)	Limit (dBuV/m)	Margin (dB)	Remark
1	5350.000	53.34	-5.23	48.11	68.20	-20.09	peak
2	5542.400	50.95	-4.88	46.07	68.20	-22.13	peak

Note:802.11a,802.11n (HT-20),802.11n (HT-40), 802.11ac (VHT-20),802.11ac (VHT-40), 802.11ac (VHT-80) all has been tested, the worst case is 802.11a,only shown the worst case.



**Band III 5470-5725MHz**

**802.11a Low  
Horizontal**

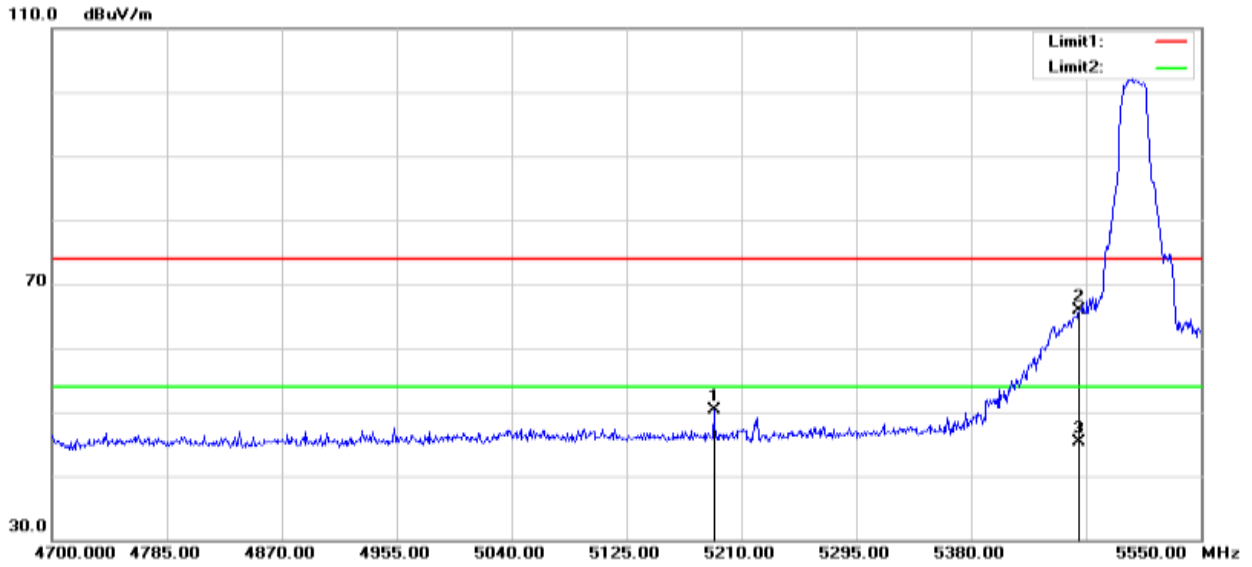

No.	Frequency (MHz)	Reading (dBuV)	Correct Factor(dB/m)	Result (dBuV/m)	Limit (dBuV/m)	Margin (dB)	Remark
1	5189.600	56.08	-5.73	50.35	68.20	-17.85	peak
2	5460.000	70.92	-5.11	65.81	68.20	-2.39	peak
3	5460.000	50.32	-5.11	45.21	54.00	-8.79	AVG

**Vertical**

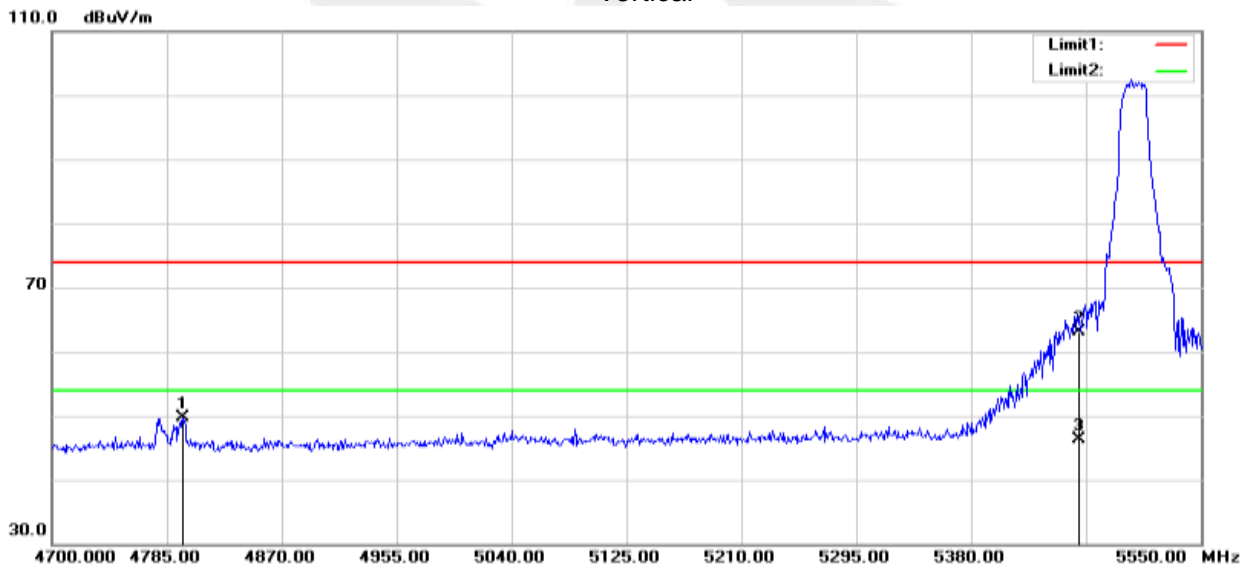

No.	Frequency (MHz)	Reading (dBuV)	Correct Factor(dB/m)	Result (dBuV/m)	Limit (dBuV/m)	Margin (dB)	Remark
1	4796.900	56.96	-7.23	49.73	68.20	-18.47	peak
2	5460.000	68.23	-5.11	63.12	68.20	-5.08	peak
3	5460.000	51.35	-5.11	46.24	54.00	-7.76	AVG

Note: 1. 802.11a, 802.11n (HT-20), 802.11n (HT-40), 802.11ac (VHT-20), 802.11ac (VHT-40), 802.11ac (VHT-80) all has been tested, the worst case is 802.11a, only shown the worst case.

2. The high channel main frequency is too far away from the restricted band and does not require testing.

**Band IV(5.725-5.85 GHz)**

Note: The main frequency is too far away from the restricted band and does not require testing.



## 4. CONDUCTED SPURIOUS EMISSIONS AND BANDEDGE

### 4.1 LIMIT

Undesirable emission limits. Except as shown in paragraph (b)(7) of this section, the maximum emissions outside of the frequency bands of operation shall be attenuated in accordance with the following limits:

- (1) For transmitters operating in the 5.15-5.25 GHz band: All emissions outside of the 5.15-5.35 GHz band shall not exceed an e.i.r.p. of  $-27$  dBm/MHz.
- (2) For transmitters operating in the 5.25-5.35 GHz band: All emissions outside of the 5.15-5.35 GHz band shall not exceed an e.i.r.p. of  $-27$  dBm/MHz.
- (3) For transmitters operating in the 5.47-5.725 GHz band: All emissions outside of the 5.47-5.725 GHz band shall not exceed an e.i.r.p. of  $-27$  dBm/MHz.
- (4) For transmitters operating in the 5.725-5.85 GHz band:
  - (i) All emissions shall be limited to a level of  $-27$  dBm/MHz at 75 MHz or more above or below the band edge increasing linearly to 10 dBm/MHz at 25 MHz above or below the band edge, and from 25 MHz above or below the band edge increasing linearly to a level of 15.6 dBm/MHz at 5 MHz above or below the band edge, and from 5 MHz above or below the band edge increasing linearly to a level of 27 dBm/MHz at the band edge.

### 4.2 TEST PROCEDURE

Spectrum Parameter	Setting
Detector	Peak
Start/Stop Frequency	30 MHz to 10th carrier harmonic
RB / VB (emission in restricted band)	1000 KHz/3000 KHz
Trace-Mode:	Max hold

For Band edge

Spectrum Parameter	Setting
Detector	Peak
Start/Stop Frequency	Lower Band Edge: 5700to5725 MHz Upper Band Edge: 5850to5870 MHz
RB / VB (emission in restricted band)	1000 KHz/3000 KHz
Trace-Mode:	Max hold

### 4.3 DEVIATION FROM STANDARD

No deviation.

#### 4.4 TEST SETUP

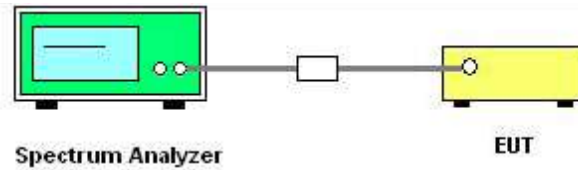

The EUT which is powered by the Battery, is coupled to the Spectrum Analyzer; the RF load attached to the EUT antenna terminal is 50 Ohm; the path loss as the factor is calibrated to correct the reading.

Make the measurement with the spectrum analyzer's resolution bandwidth (RBW) = 1000 kHz. In order to make an accurate measurement, set the span greater than RBW.

#### 4.5 EUT OPERATION CONDITIONS

The EUT tested system was configured as the statements of 2.3 Unless otherwise a special operating condition is specified in the follows during the testing.

#### 4.6 TEST RESULTS

Data See Attachment A





## 5. POWER SPECTRAL DENSITY TEST

### 5.1 LIMIT

1. For mobile and portable client devices in the 5.15-5.25 GHz band, the maximum power spectral density shall not exceed 11 dBm in any 1 megahertz band. If transmitting antennas of directional gain greater than 6 dBi are used, both the maximum conducted output power and the maximum power spectral density shall be reduced by the amount in dB that the directional gain of the antenna exceeds 6 dBi.
2. For the 5.25-5.35 GHz and 5.47-5.725 GHz bands, the maximum power spectral density shall not exceed 11 dBm in any 1 megahertz band. If transmitting antennas of directional gain greater than 6 dBi are used, both the maximum conducted output power and the maximum power spectral density shall be reduced by the amount in dB that the directional gain of the antenna exceeds 6 dBi.
3. For the band 5.725-5.850 GHz, the peak power spectral density shall not exceed 30 dBm in any 500 kHz band. If transmitting antenna directional gain is greater than 6 dBi, both the maximum conducted output power and the peak power spectral density shall be reduced by the amount in dB that the directional gain of the antenna exceeds 6 dBi.

### 5.2 TEST PROCEDURE

1. The setting follows Method SA-1 of FCC KDB D02 General UNII Test Procedures New Rules v01r03.

For devices operating in the band, the rules specify a measurement bandwidth of 500 kHz.

Many spectrum analyzers do not have 500 kHz RBW, thus a narrower RBW may need to be used.

The rules permit the use of a RBWs less than 1 MHz, or 500 kHz, "provided that the measured power is integrated over the full reference bandwidth" to show the total power over the specified measurement bandwidth (*i.e.*, 1 MHz, or 500 kHz). If measurements are performed using a reduced resolution bandwidth (< 1 MHz, or < 500 kHz) and integrated over 1 MHz, or 500 kHz bandwidth, the following adjustments to the procedures apply:

- a) Set  $RBW \geq 1/T$ , where  $T$  is defined in section II.B.1.a).
- b) Set  $VBW \geq 3 RBW$ .
- c) If measurement bandwidth of Maximum PSD is specified in 500 kHz, add  $10 \log (500\text{kHz}/RBW)$  to the measured result, whereas RBW (< 500 kHz) is the reduced resolution bandwidth of the spectrum analyzer set during measurement.
- d) If measurement bandwidth of Maximum PSD is specified in 1 MHz, add  $10 \log (1\text{MHz}/RBW)$  to the measured result, whereas RBW (< 1 MHz) is the reduced resolution bandwidth of spectrum analyzer set during measurement.
- e) Care must be taken to ensure that the measurements are performed during a period of continuous transmission or are corrected upward for duty cycle.

Note: As a practical matter, it is recommended to use reduced RBW of 100 kHz for the sections 5.c) and 5.d) above, since RBW=100 KHZ is available on nearly all spectrum analyzers.

**5.3 DEVIATION FROM STANDARD**

No deviation.

**5.4 TEST SETUP****5.5 EUT OPERATION CONDITIONS**

The EUT tested system was configured as the statements of 2.1 Unless otherwise a special operating condition is specified in the follows during the testing.

**5.6 TEST RESULTS**

5150-5250MHz					
Frequency	Power Density(dBm)	Duty cycle factor (dB)	Power Density(dBm)	Limit	Result
802.11a					
5180	6.454	0.09	6.544	11	PASS
5200	6.369	0.09	6.459	11	PASS
5240	6.725	0.09	6.815	11	PASS
802.11n20					
5180	6.584	0.10	6.684	11	PASS
5200	6.302	0.10	6.402	11	PASS
5240	6.623	0.10	6.723	11	PASS
802.11n40					
5190	2.744	0.19	2.934	11	PASS
5230	2.054	0.19	2.244	11	PASS
802.11ac20					
5180	6.510	0.08	6.590	11	PASS
5200	6.525	0.08	6.605	11	PASS
5240	6.715	0.08	6.795	11	PASS
802.11ac40					
5190	3.310	0.19	3.500	11	PASS
5230	2.163	0.19	2.353	11	PASS
802.11ac80					
5210	-0.417	0.40	-0.017	11	PASS



5250-5350MHz					
Frequency	Power Density(dBm)	Duty cycle factor (dB)	Power Density(dBm)	Limit	Result
802.11a					
5260	8.721	0.07	8.791	11	PASS
5300	8.670	0.07	8.740	11	PASS
5320	8.698	0.07	8.768	11	PASS
802.11n20					
5260	8.681	0.10	8.781	11	PASS
5300	7.983	0.10	8.083	11	PASS
5320	8.677	0.10	8.777	11	PASS
802.11n40					
5270	6.195	0.21	6.405	11	PASS
5310	6.159	0.21	6.369	11	PASS
802.11ac20					
5260	7.421	0.09	7.511	11	PASS
5300	6.980	0.09	7.070	11	PASS
5320	7.992	0.09	8.082	11	PASS
802.11ac40					
5270	2.592	0.19	2.782	11	PASS
5310	3.191	0.19	3.381	11	PASS
802.11ac80					
5290	0.292	0.40	0.692	11	PASS



5470-5725MHz					
Frequency	Power Density(dBm)	Duty cycle factor (dB)	Power Density(dBm)	Limit	Result
802.11a					
5500	3.732	0.07	3.802	11	PASS
5580	2.702	0.07	2.772	11	PASS
5700	3.540	0.07	3.610	11	PASS
802.11n20					
5500	3.233	0.10	3.333	11	PASS
5580	0.720	0.10	0.820	11	PASS
5700	3.418	0.10	3.518	11	PASS
802.11n40					
5510	-1.176	0.21	-0.966	11	PASS
5550	0.739	0.21	0.949	11	PASS
5670	-1.527	0.21	-1.317	11	PASS
802.11ac20					
5500	3.165	0.09	3.255	11	PASS
5580	2.678	0.09	2.768	11	PASS
5700	3.290	0.09	3.380	11	PASS
802.11ac40					
5510	-1.124	0.19	-0.934	11	PASS
5550	-1.323	0.19	-1.133	11	PASS
5670	-2.097	0.19	-1.907	11	PASS
802.11ac80					
5530	-1.734	0.42	-1.314	11	PASS
5610	-4.740	0.42	-4.320	11	PASS





5725-5850MHz					
Frequency	Power Density(dBm)	Duty cycle factor (dB)	Power Density(dBm)	Limit	Result
802.11a					
5745	0.082	0.09	0.172	30	PASS
5785	-1.142	0.09	-1.052	30	PASS
5825	-0.986	0.09	-0.896	30	PASS
802.11n20					
5745	-0.763	0.10	-0.663	30	PASS
5785	-1.795	0.10	-1.695	30	PASS
5825	-0.118	0.10	-0.018	30	PASS
802.11n40					
5755	-3.846	0.21	-3.636	30	PASS
5795	-4.123	0.21	-3.913	30	PASS
802.11ac20					
5745	-0.947	0.08	-0.867	30	PASS
5785	-0.516	0.08	-0.436	30	PASS
5825	-1.271	0.08	-1.191	30	PASS
802.11ac40					
5755	-3.917	0.19	-3.727	30	PASS
5795	-4.212	0.19	-4.022	30	PASS
802.11ac80					
5775	-7.321	0.42	-6.901	30	PASS

Test plots see Attachment B



## 6. BANDWIDTH MEASUREMENT

### 6.1 EMISSION BANDWIDTH (EBW) 26 BANDWIDTH PROCEDURES / LIMIT

See list of measuring instruments of this test report.

#### 6.1.1 TEST PROCEDURE

1. The testing follows FCC KDB 789033 D02 General UNII Test Procedures New Rules v02r01
2. Set RBW = approximately 1% of the emission bandwidth.
3. Set the VBW  $\geq$  RBW.
4. Detector = Peak.
5. Trace mode = max hold.
6. Measure the maximum width of the emission that is 26 dB down from the peak of the emission. Compare this with the RBW setting of the analyzer. Readjust RBW and repeat measurement as needed until the RBW/EBW ratio is approximately 1%.

#### 6.1.2 DEVIATION FROM STANDARD

No deviation.

#### 6.1.3 TEST SETUP



#### 6.1.4 EUT OPERATION CONDITIONS

The EUT tested system was configured as the statements of 2.4 Unless otherwise a special operating condition is specified in the follows during the testing.



**6.1.5 TEST RESULTS**

Frequency (MHz)	26dB Bandwidth (MHz)	Pass/Fail
802.11a		
5180	20.16	Pass
5200	20.16	Pass
5240	20.05	Pass
802.11n(HT20)		
5180	19.84	Pass
5200	20.07	Pass
5240	19.92	Pass
802.11n(HT40)		
5180	40.47	Pass
5200	40.15	Pass
802.11ac(VHT20)		
5180	19.75	Pass
5200	19.91	Pass
5240	19.82	Pass
802.11ac(VHT40)		
5180	40.11	Pass
5200	40.18	Pass
802.11ac(VHT80)		
5210	81.37	Pass

Frequency (MHz)	26dB Bandwidth (MHz)	Pass/Fail
802.11a		
5260	19.70	Pass
5300	20.20	Pass
5320	20.27	Pass
802.11n(HT20)		
5260	19.89	Pass
5300	19.86	Pass
5320	19.83	Pass
802.11n(HT40)		
5270	45.45	Pass
5310	45.40	Pass
802.11ac(VHT20)		
5260	20.25	Pass
5300	20.17	Pass
5320	20.14	Pass
802.11ac(VHT40)		
5270	40.87	Pass
5310	40.47	Pass
802.11ac(VHT80)		
5290	81.56	Pass



Frequency (MHz)	26dB Bandwidth (MHz)	Pass/Fail
802.11a		
5500	19.90	Pass
5580	19.85	Pass
5700	19.95	Pass
802.11n(HT20)		
5500	19.81	Pass
5580	19.79	Pass
5700	19.84	Pass
802.11n(HT40)		
5510	40.30	Pass
5550	40.28	Pass
5670	40.48	Pass
802.11ac(VHT20)		
5500	19.74	Pass
5580	19.74	Pass
5700	19.83	Pass
802.11ac(VHT40)		
5510	39.99	Pass
5550	40.03	Pass
5670	40.10	Pass
802.11ac(VHT80)		
5530	81.40	Pass
5610	81.03	Pass

Frequency (MHz)	26dB Bandwidth (MHz)	Pass/Fail
802.11a		
5745	19.82	Pass
5785	19.90	Pass
5825	19.81	Pass
802.11n(HT20)		
5745	19.93	Pass
5785	19.89	Pass
5825	19.86	Pass
802.11n(HT40)		
5755	40.34	Pass
5795	40.19	Pass
802.11ac(VHT20)		
5745	19.86	Pass
5785	19.79	Pass
5825	19.95	Pass
802.11ac(VHT40)		
5755	40.42	Pass
5795	40.27	Pass
802.11ac(VHT80)		
5775	81.20	Pass

Test plot see AttachmentC



## 6.2 OCCUPIED BANDWIDTH ( 99%) TEST APPLIED PROCEDURES / LIMIT

The following procedure shall be used for measuring (99 %) power bandwidth:

### 6.2.1 TEST PROCEDURE

1. The testing follows FCC KDB 789033 D02 General UNII Test Procedures v02r01.

The following procedure shall be used for measuring (99 %) power bandwidth:

1. Set center frequency to the nominal EUT channel center frequency.
2. Set span = 1.5 times to 5.0 times the OBW.
3. Set RBW = 1 % to 5 % of the OBW
4. Set VBW  $\geq 3 \cdot$  RBW
5. Video averaging is not permitted. Where practical, a sample detection and single sweep mode shall be used. Otherwise, peak detection and max hold mode (until the trace stabilizes) shall be used.
6. Use the 99 % power bandwidth function of the instrument (if available).
7. If the instrument does not have a 99 % power bandwidth function, the trace data points are recovered and directly summed in power units. The recovered amplitude data points, beginning at the lowest frequency, are placed in a running sum until 0.5 % of the total is reached; that frequency is recorded as the lower frequency. The process is repeated until 99.5 % of the total is reached; that frequency is recorded as the upper frequency. The 99% occupied bandwidth is the difference between these two frequencies.

### 6.2.2 DEVIATION FROM STANDARD

No deviation.

### 6.2.3 TEST SETUP

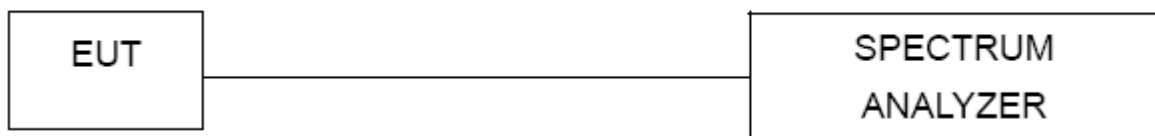

### 6.2.4 EUT OPERATION CONDITIONS

The EUT tested system was configured as the statements of 2.4 Unless otherwise a special operating condition is specified in the follows during the testing.



**6.2.5 TEST RESULTS**

Frequency (MHz)	99% Bandwidth (MHz)	Pass/Fail
802.11a		
5180	16.43	Pass
5200	16.43	Pass
5240	16.42	Pass
802.11n(HT20)		
5180	17.51	Pass
5200	17.50	Pass
5240	17.51	Pass
802.11n(HT40)		
5180	35.90	Pass
5200	35.91	Pass
802.11ac(VHT20)		
5180	17.51	Pass
5200	17.51	Pass
5240	17.51	Pass
802.11ac(VHT40)		
5180	35.86	Pass
5200	35.88	Pass
802.11ac(VHT80)		
5210	75.79	Pass

Frequency (MHz)	99% Bandwidth (MHz)	Pass/Fail
802.11a		
5260	16.42	Pass
5300	16.43	Pass
5320	16.43	Pass
802.11n(HT20)		
5260	17.51	Pass
5300	17.50	Pass
5320	17.50	Pass
802.11n(HT40)		
5270	36.96	Pass
5310	35.96	Pass
802.11ac(VHT20)		
5260	16.41	Pass
5300	16.40	Pass
5320	16.42	Pass
802.11ac(VHT40)		
5270	35.91	Pass
5310	35.91	Pass
802.11ac(VHT80)		
5290	75.80	Pass



Frequency (MHz)	99% Bandwidth (MHz)	Pass/Fail
802.11a		
5500	16.42	Pass
5580	16.41	Pass
5700	16.40	Pass
802.11n(HT20)		
5500	17.47	Pass
5580	17.47	Pass
5700	17.47	Pass
802.11n(HT40)		
5510	35.87	Pass
5550	35.87	Pass
5670	35.89	Pass
802.11ac(VHT20)		
5500	17.47	Pass
5580	17.47	Pass
5700	17.48	Pass
802.11ac(VHT40)		
5510	35.84	Pass
5550	35.85	Pass
5670	35.86	Pass
802.11ac(VHT80)		
5530	75.69	Pass
5610	75.71	Pass

Frequency (MHz)	99% Bandwidth (MHz)	Pass/Fail
802.11a		
5745	16.41	Pass
5785	16.41	Pass
5825	16.43	Pass
802.11n(HT20)		
5745	17.48	Pass
5785	17.48	Pass
5825	17.48	Pass
802.11n(HT40)		
5755	35.84	Pass
5795	35.92	Pass
802.11ac(VHT20)		
5745	17.47	Pass
5785	17.48	Pass
5825	17.47	Pass
802.11ac(VHT40)		
5755	35.87	Pass
5795	35.86	Pass
802.11ac(VHT80)		
5775	78.82	Pass

Test plot See Attachment C



### 6.3 MINIMUM EMISSION BANDWIDTH(6 DB) PROCEDURES / LIMIT

Section 15.407(e) specifies the minimum 6 dB emission bandwidth of at least 500 KHz for the band 5.725-5.85 GHz. The following procedure shall be used for measuring this bandwidth:

#### 6.3.1 TEST PROCEDURE

1. The testing follows FCC KDB 789033 D02 General UNII Test Procedures v02r01.
  - a) Set RBW = 100 kHz.
  - b) Set the video bandwidth (VBW)  $\geq 3 \times$  RBW.
  - c) Detector = Peak.
  - d) Trace mode = max hold.
  - e) Sweep = auto couple.
  - f) Allow the trace to stabilize.
  - g) Measure the maximum width of the emission that is constrained by the frequencies associated with the two outermost amplitude points (upper and lower frequencies) that are attenuated by 6 dB relative to the maximum level measured in the fundamental emission.

#### 6.3.2 DEVIATION FROM STANDARD

No deviation.

#### 6.3.3 TEST SETUP



#### 6.3.4 EUT OPERATION CONDITIONS

The EUT tested system was configured as the statements of 2.4 Unless otherwise a special operating condition is specified in the follows during the testing.



**6.3.5 TEST RESULTS**

Frequency (MHz)	6dB Bandwidth (MHz)	Pass/Fail
802.11a		
5745	15.08	Pass
5785	15.04	Pass
5825	15.10	Pass
802.11n(HT20)		
5745	15.09	Pass
5785	15.09	Pass
5825	15.10	Pass
802.11n(HT40)		
5755	39.58	Pass
5795	39.77	Pass
802.11ac(VHT20)		
5745	15.11	Pass
5785	15.10	Pass
5825	15.07	Pass
802.11ac(VHT40)		
5755	35.03	Pass
5795	35.09	Pass
802.11ac(VHT80)		
5775	75.96	Pass

Test plots see AttachmentD



### 7. MAXIMUM CONDUCTED OUTPUT POWER

#### 7.1 LIMIT

For mobile and portable client devices in the 5.15-5.25 GHz band, the maximum conducted output power over the frequency band of operation shall not exceed 250 mW provided the maximum antenna gain does not exceed 6 dBi. If transmitting antennas of directional gain greater than 6 dBi are used, both the maximum conducted output power and the maximum power spectral density shall be reduced by the amount in dB that the directional gain of the antenna exceeds 6 dBi.

For the 5.25-5.35 GHz and 5.47-5.725 GHz bands, the maximum conducted output power over the frequency bands of operation shall not exceed the lesser of 250 mW or 11 dBm + 10 log B, where B is the 26 dB emission bandwidth in megahertz, if transmitting antennas of directional gain greater than 6 dBi are used.

For the band 5.725-5.85 GHz, the maximum conducted output power over the frequency band of operation shall not exceed 1 W. If transmitting antennas of directional gain greater than 6 dBi are used.

FCC Part15 (15.407) , Subpart E				
Section	Test Item	Limit	FrequencyRange (MHz)	Result
15.407(a)(1)(iv)	Peak Output Power	0.25 watt	5150-5250	PASS
		The lesser of 250 mW or 11 dBm + 10 log (26 dB emission bandwidth)	5250-5350	
5470-5725				
15.407(a)(3)		1 watt	5725-5825	

#### 7.2 TEST PROCEDURE

One of the following procedures may be used to determine the maximum peak conducted output power of a DTS EUT.

RBW ≥ DTS bandwidth

The following procedure shall be used when an instrument with a resolution bandwidth that is greater than the DTS bandwidth is available to perform the measurement:

- a) Set the RBW ≥ DTS bandwidth.
- b) Set VBW ≥ [3 × RBW].
- c) Set span ≥ [3 × RBW].
- d) Sweep time = auto couple.
- e) Detector = peak.
- f) Trace mode = max hold.
- g) Allow trace to fully stabilize.
- h) Use peak marker function to determine the peak amplitude level.



Integrated band power method:

The following procedure can be used when the maximum available RBW of the instrument is less than the

DTS bandwidth:

- a) Set the RBW = 1 MHz.
- b) Set the VBW  $\geq [3 \times \text{RBW}]$ .
- c) Set the span  $\geq [1.5 \times \text{DTS bandwidth}]$ .
- d) Detector = peak.
- e) Sweep time = auto couple.
- f) Trace mode = max hold.
- g) Allow trace to fully stabilize.
- h) Use the instrument's band/channel power measurement function with the band limits set equal to the DTS bandwidth edges (for some instruments, this may require a manual override to select the peak detector). If the instrument does not have a band power function, then sum the spectrum levels (in linear power units) at intervals equal to the RBW extending across the DTS channel bandwidth.

PKPM1 Peak power meter method:

The maximum peak conducted output power may be measured using a broadband peak RF power meter. The power meter shall have a video bandwidth that is greater than or equal to the DTS bandwidth and shall use a fast-responding diode detector.

### 7.3 DEVIATION FROM STANDARD

No deviation.

### 7.4 TEST SETUP

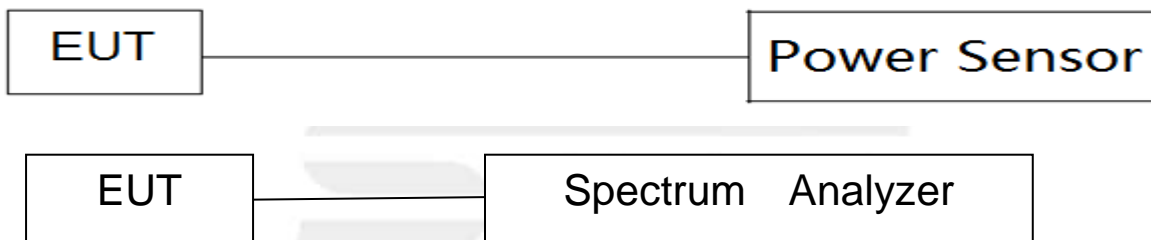

### 7.5 EUT OPERATION CONDITIONS

The EUT tested system was configured as the statements of 5 Unless otherwise a special operating condition is specified in the follows during the testing.

**7.6 TEST RESULTS**

Note:

1. For mobile and portable client devices in the 5.15-5.25 GHz band, the maximum conducted output power over the frequency band of operation shall not exceed the lesser of 0.25 W.
2. For mobile and portable client devices in the 5.25-5.35 GHz band, the maximum conducted output power over the frequency band of operation shall not exceed the lesser of 0.25 W.
3. For mobile and portable client devices in the 5.47-5.725 GHz band, the maximum conducted output power over the frequency band of operation shall not exceed the lesser of 0.25 W.
4. For the band 5.745-5.850 GHz, the maximum conducted output power over the frequency band of operation shall not exceed the lesser of 1 W.

**Band I (5.15-5.25GHz)**

<b>Band I (5.15-5.25GHz)</b>					
Test Channel	Frequency (MHz)	AV Power (dBm)	Duty cycle factor (dB)	AV Power (dBm)	LIMIT (dBm)
802.11a					
36	5180	11.87	0.09	11.96	23.98
40	5200	11.52	0.09	11.61	23.98
48	5240	11.72	0.09	11.81	23.98
802.11n(HT20)					
36	5180	11.87	0.10	11.97	23.98
40	5200	11.90	0.10	12.00	23.98
48	5240	11.64	0.10	11.74	23.98
802.11n(HT40)					
38	5190	9.78	0.19	9.97	23.98
46	5230	9.61	0.19	9.80	23.98
802.11ac(HT20)					
36	5180	10.51	0.08	10.59	23.98
40	5200	10.84	0.08	10.92	23.98
48	5240	10.66	0.08	10.74	23.98
802.11ac(HT40)					
38	5190	9.69	0.19	9.88	23.98
46	5230	9.68	0.19	9.87	23.98
802.11ac(HT80)					
42	5210	9.18	0.40	9.58	23.98



<b>Band II(5.25-5.35GHz)</b>					
Test Channel	Frequency (MHz)	AV Power (dBm)	Duty cycle factor (dB)	AV Power (dBm)	LIMIT (dBm)
802.11a					
52	5260	11.92	0.07	11.99	23.98
60	5300	11.80	0.07	11.87	23.98
64	5320	11.72	0.07	11.79	23.98
802.11n(HT20)					
52	5260	11.80	0.10	11.90	23.98
60	5300	11.83	0.10	11.93	23.98
64	5320	11.73	0.10	11.83	23.98
802.11n(HT40)					
54	5270	9.46	0.21	9.67	23.98
62	5310	9.54	0.21	9.75	23.98
802.11ac(HT20)					
52	5260	11.79	0.09	11.88	23.98
60	5300	11.83	0.09	11.92	23.98
64	5320	11.72	0.09	11.81	23.98
802.11ac(HT40)					
54	5270	9.50	0.19	9.69	23.98
62	5310	9.53	0.19	9.72	23.98
802.11ac(HT80)					
58	5290	8.71	0.40	9.11	23.98



<b>Band III(5.47-5.725GHz)</b>					
Test Channel	Frequency (MHz)	AV Power (dBm)	Duty cycle factor (dB)	AV Power (dBm)	LIMIT (dBm)
802.11a					
100	5500	6.72	0.07	6.79	23.98
116	5580	6.44	0.07	6.51	23.98
140	5700	6.76	0.07	6.83	23.98
802.11n(HT20)					
100	5500	6.64	0.10	6.74	23.98
116	5580	6.09	0.10	6.19	23.98
140	5700	7.09	0.10	7.19	23.98
802.11n(HT40)					
102	5510	5.26	0.21	5.47	23.98
110	5550	4.92	0.21	5.13	23.98
134	5670	4.28	0.21	4.49	23.98
802.11ac(HT20)					
100	5500	7.60	0.09	7.69	23.98
116	5580	6.96	0.09	7.05	23.98
140	5700	6.54	0.09	6.63	23.98
802.11ac(HT40)					
102	5510	4.33	0.19	4.52	23.98
110	5550	4.91	0.19	5.10	23.98
134	5670	4.89	0.19	5.08	23.98
802.11ac(HT80)					
106	5530	4.15	0.42	4.57	23.98
122	5610	4.16	0.42	4.58	23.98



<b>Band IV (5.725-5.85GHz)</b>					
Test Channel	Frequency (MHz)	AV Power (dBm)	Duty cycle factor (dB)	AV Power (dBm)	LIMIT (dBm)
802.11a					
149	5745	5.14	0.09	5.23	30
157	5785	5.01	0.09	5.10	30
165	5825	3.73	0.09	3.82	30
802.11n(HT20)					
149	5745	4.330	0.10	4.43	30
157	5785	4.850	0.10	4.95	30
165	5825	4.090	0.10	4.19	30
802.11n(HT40)					
151	5755	4.070	0.21	4.28	30
159	5795	3.980	0.21	4.19	30
802.11ac(HT20)					
149	5745	4.940	0.08	5.02	30
157	5785	4.240	0.08	4.32	30
165	5825	3.550	0.08	3.63	30
802.11ac(HT40)					
151	5755	4.780	0.19	4.97	30
159	5795	4.460	0.19	4.65	30
802.11ac(HT80)					
155	5775	3.730	0.42	4.15	30



802.11ac HT80(5210MHz)

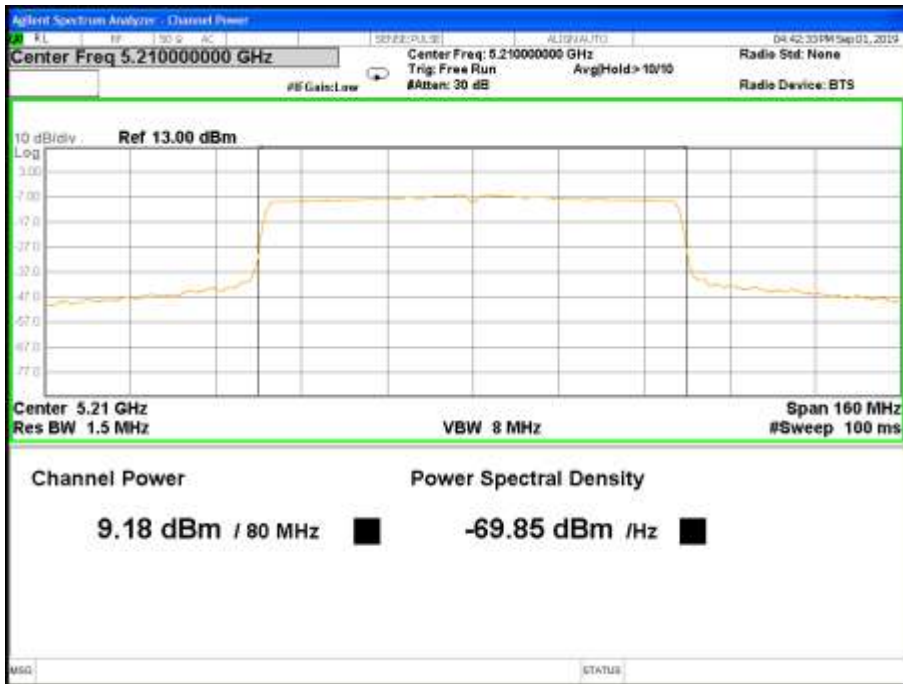

802.11ac HT80(5290MHz)

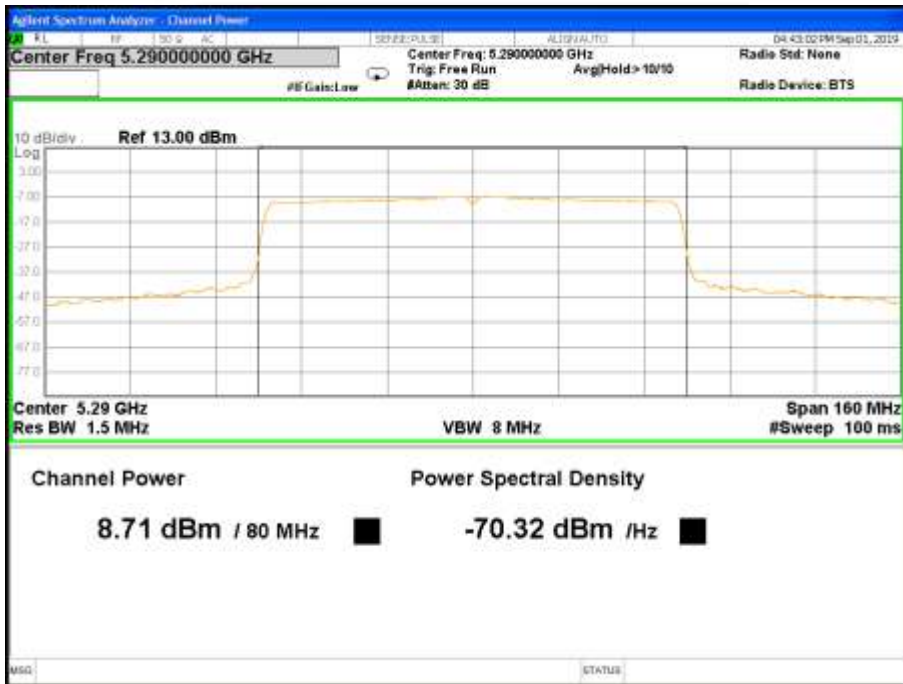





802.11ac HT80(5530MHz)

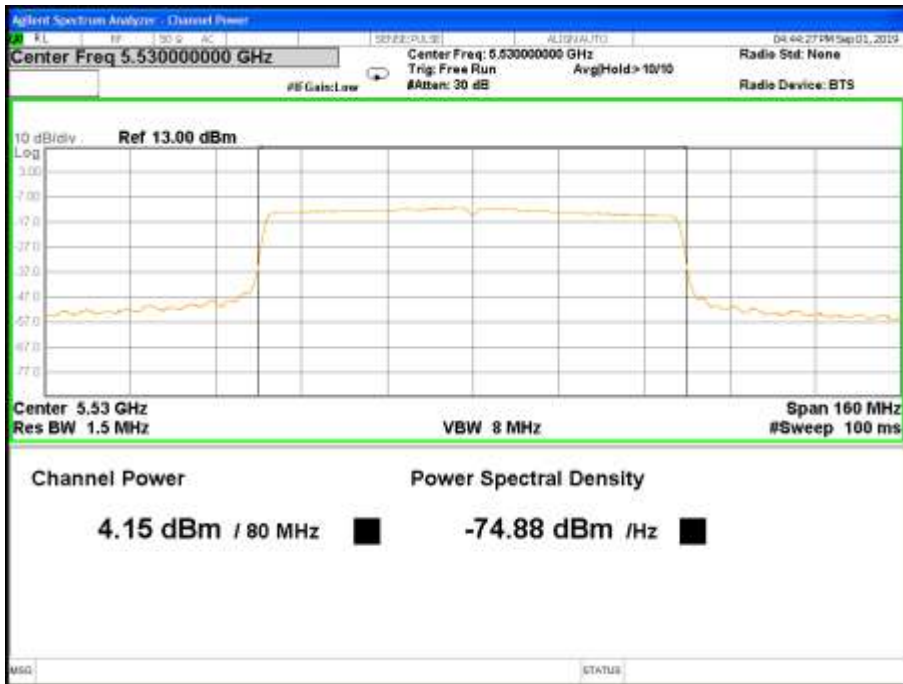

802.11ac HT80(5610MHz)

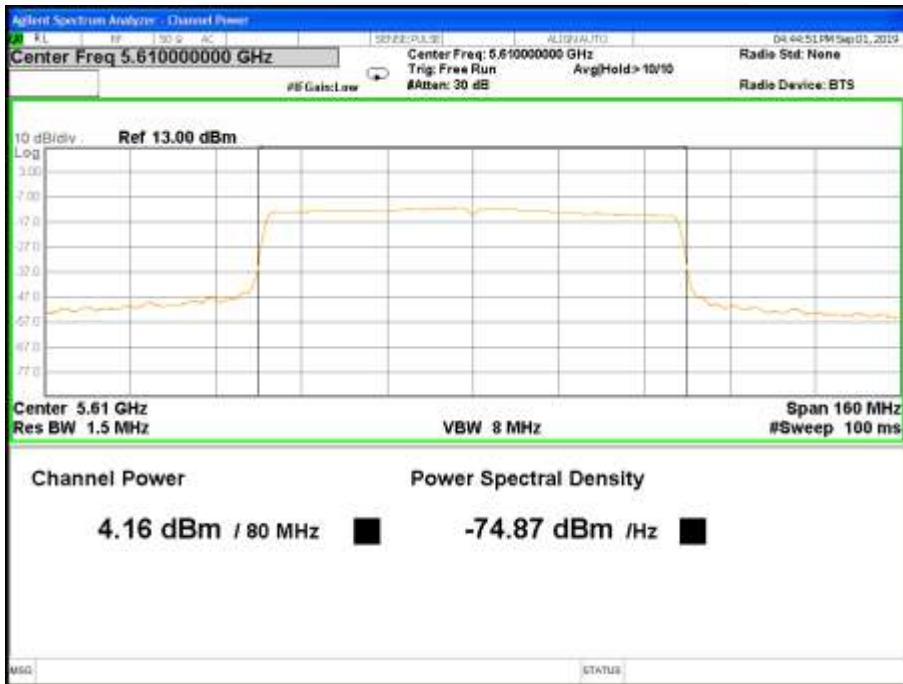



802.11ac HT80(5775MHz)

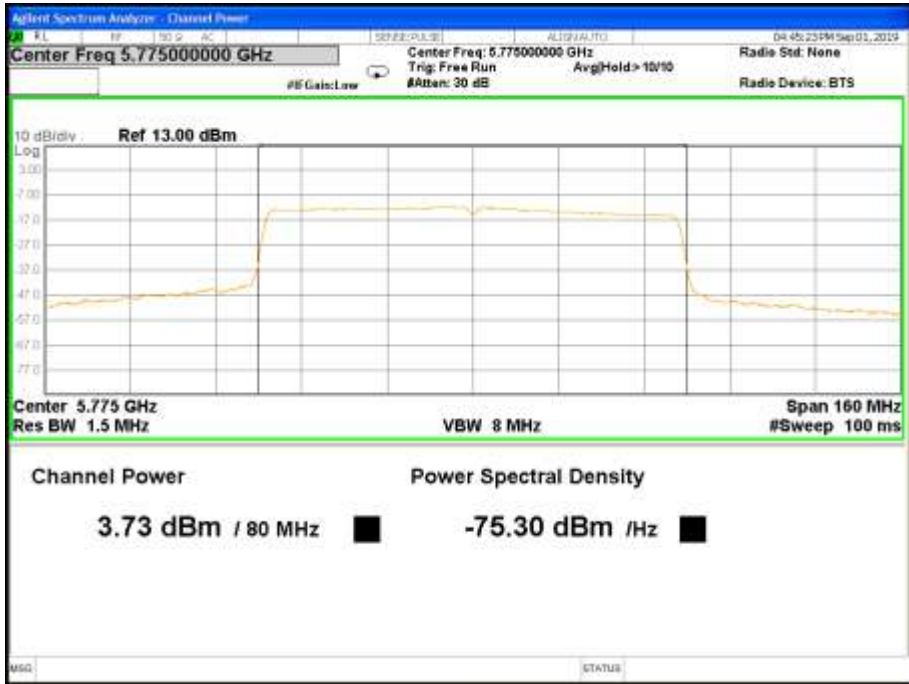



## Duty cycle

Band	Mode	Ton(ms)	Tp(ms)	Duty cycle(%)	Duty cycle factor
5.2G	a20	1.399	1.427	98.04%	0.09
	n20	1.307	1.336	97.83%	0.10
	n40	0.656	0.686	95.63%	0.19
	ac20	1.321	1.346	98.14%	0.08
	ac40	0.658	0.688	95.64%	0.19
	ac80	0.328	0.360	91.11%	0.40
5.3G	a20	1.404	1.428	98.32%	0.07
	n20	1.307	1.336	97.83%	0.10
	n40	0.652	0.684	95.32%	0.21
	ac20	1.321	1.350	97.85%	0.09
	ac40	0.656	0.686	95.63%	0.19
	ac80	0.328	0.360	91.11%	0.40
5.6G	a20	1.403	1.427	98.32%	0.07
	n20	1.307	1.336	97.83%	0.10
	n40	0.652	0.684	95.32%	0.21
	ac20	1.318	1.346	97.92%	0.09
	ac40	0.658	0.688	95.64%	0.19
	ac80	0.327	0.360	90.83%	0.42
5.8G	a20	1.399	1.427	98.04%	0.09
	n20	1.307	1.336	97.83%	0.10
	n40	0.652	0.684	95.32%	0.21
	ac20	1.321	1.346	98.14%	0.08
	ac40	0.658	0.688	95.64%	0.19
	ac80	0.327	0.360	90.83%	0.42

NOTE:

Duty cycle factor =  $10 \cdot \log(1 / \text{Duty cycle})$



5.2G

802.11a

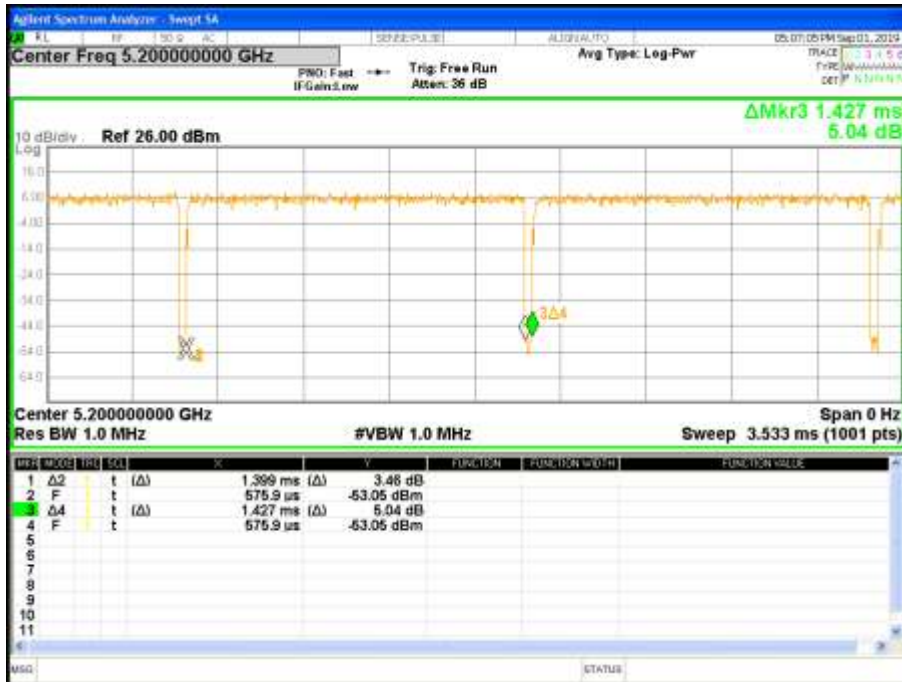

802.11n HT20





802.11n HT40

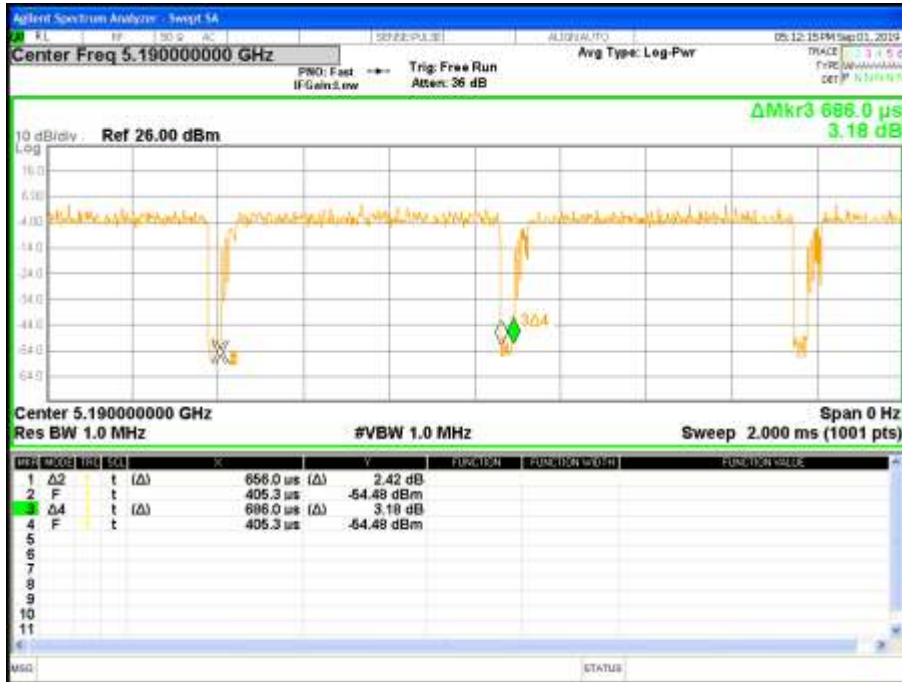

802.11ac VHT20





802.11ac VHT40

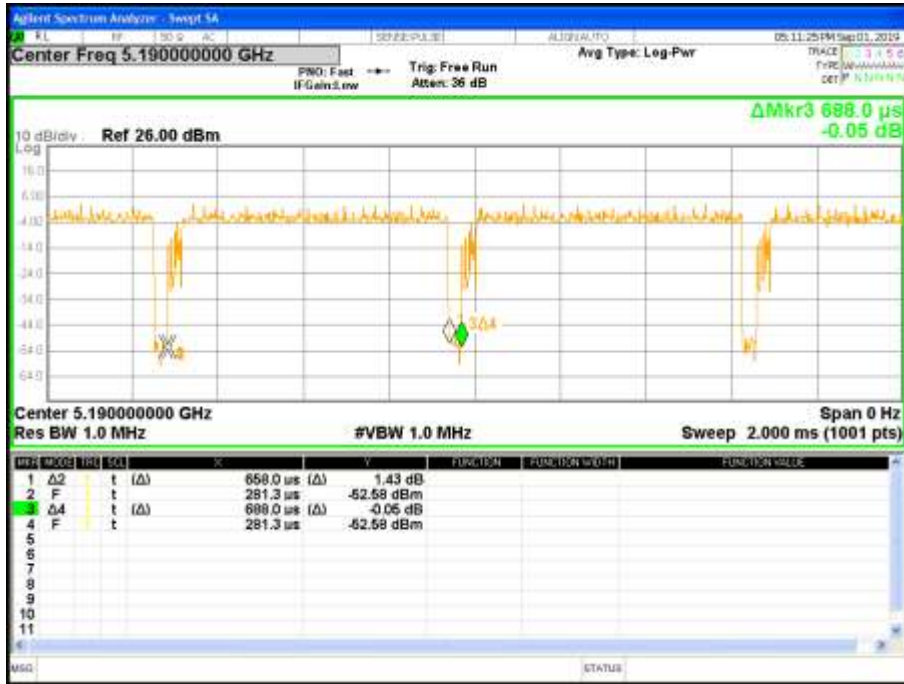

802.11ac VHT80





5.3G

802.11a



802.11n HT20





802.11n HT40



802.11ac VHT20

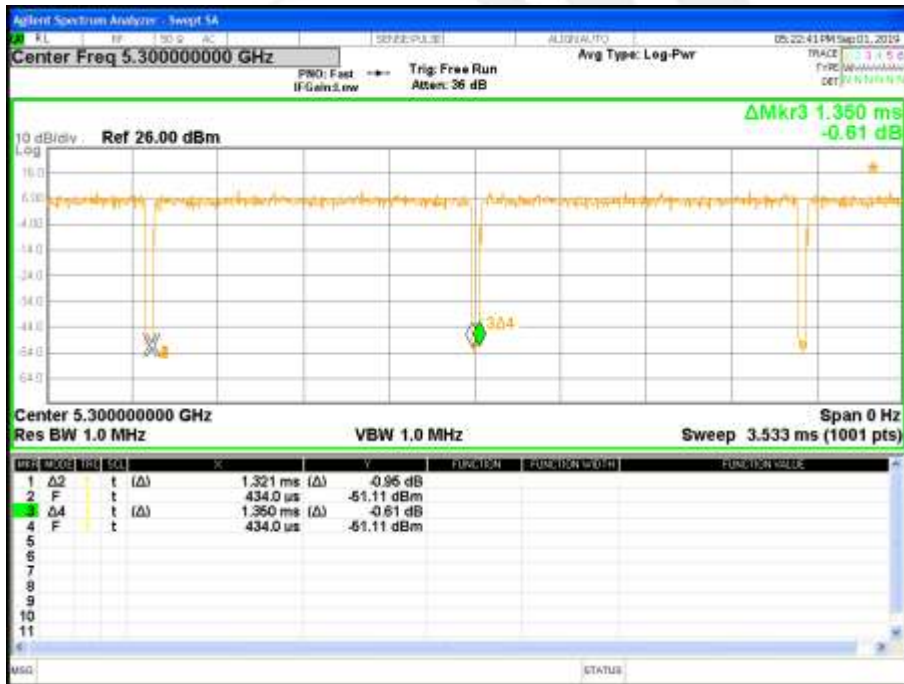





802.11ac VHT40

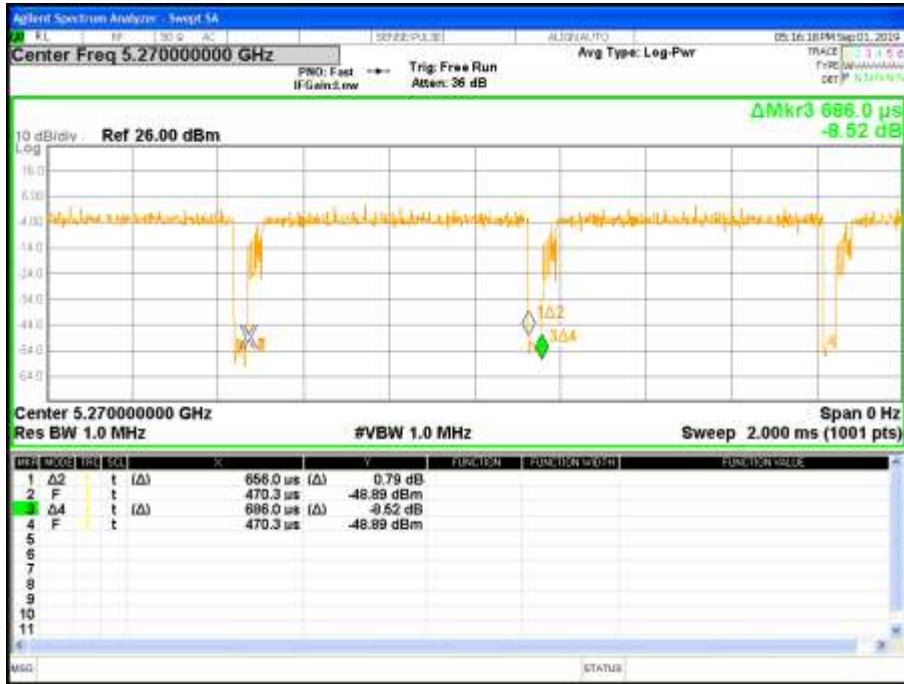

802.11ac VHT80





5.6G

802.11a

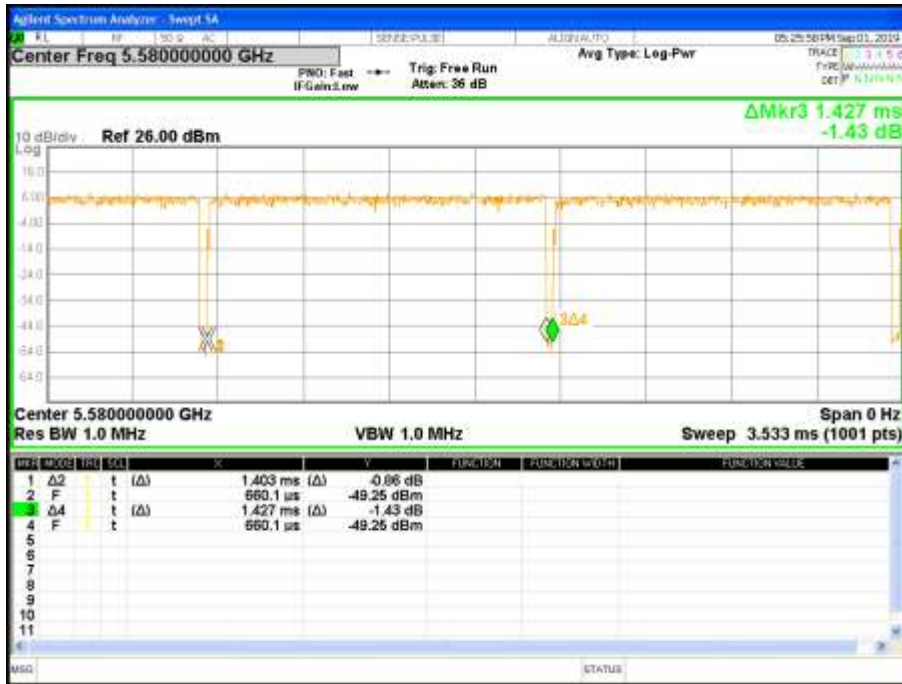

802.11n HT20

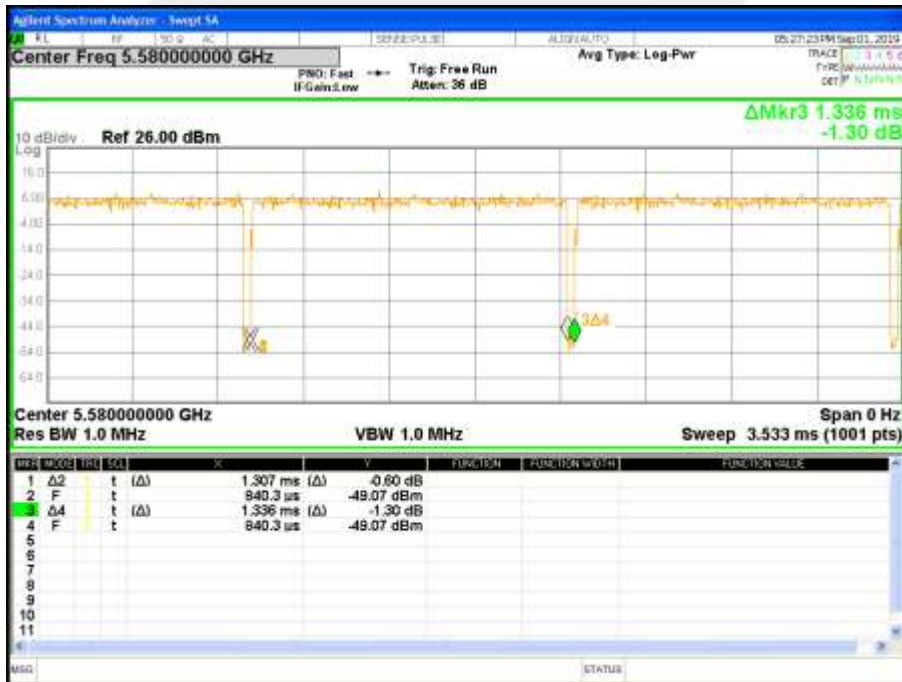



802.11n HT40

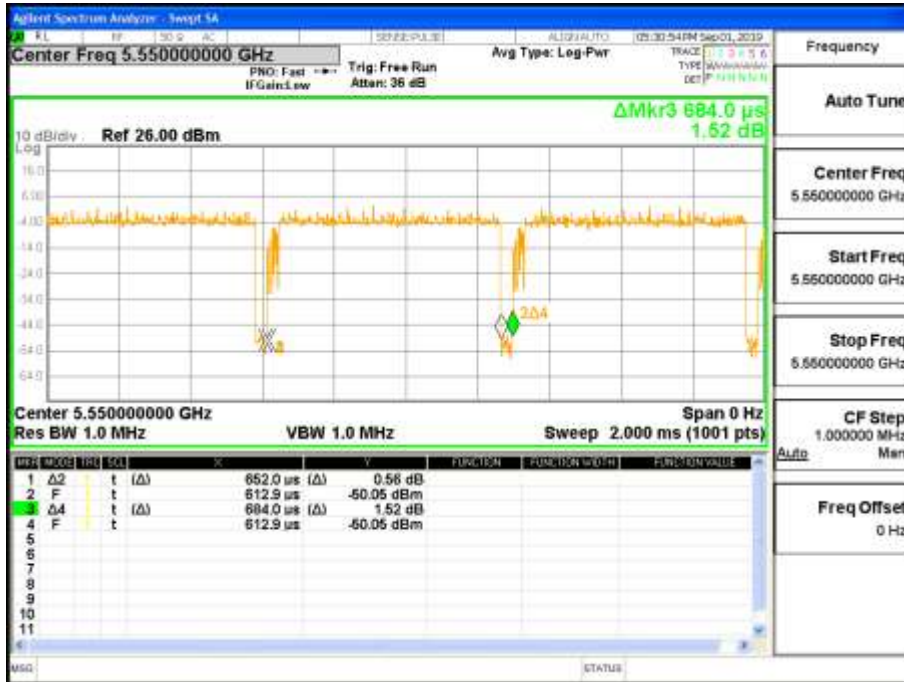

802.11ac VHT20

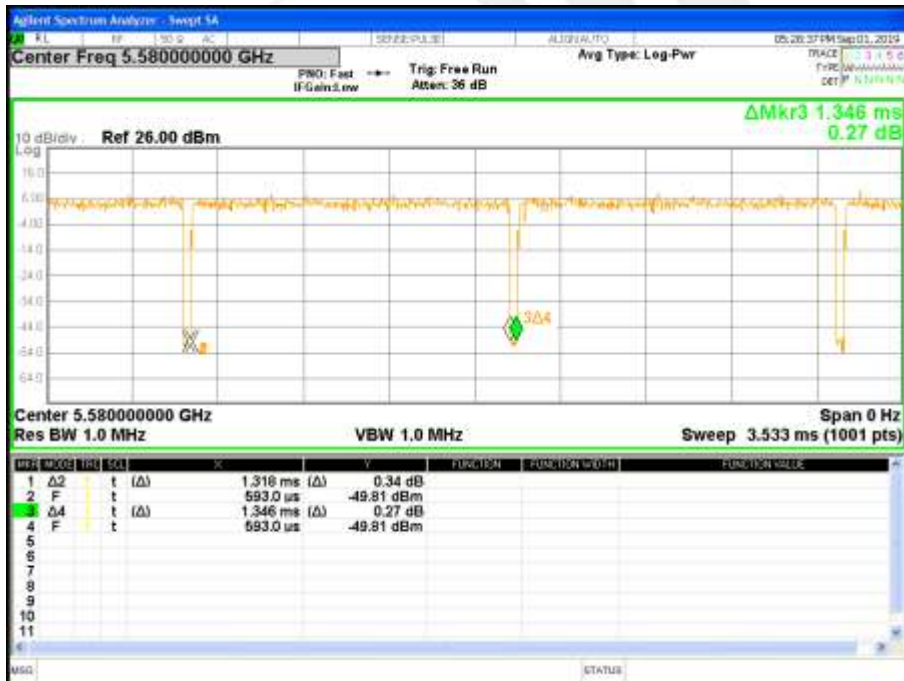



802.11ac VHT40

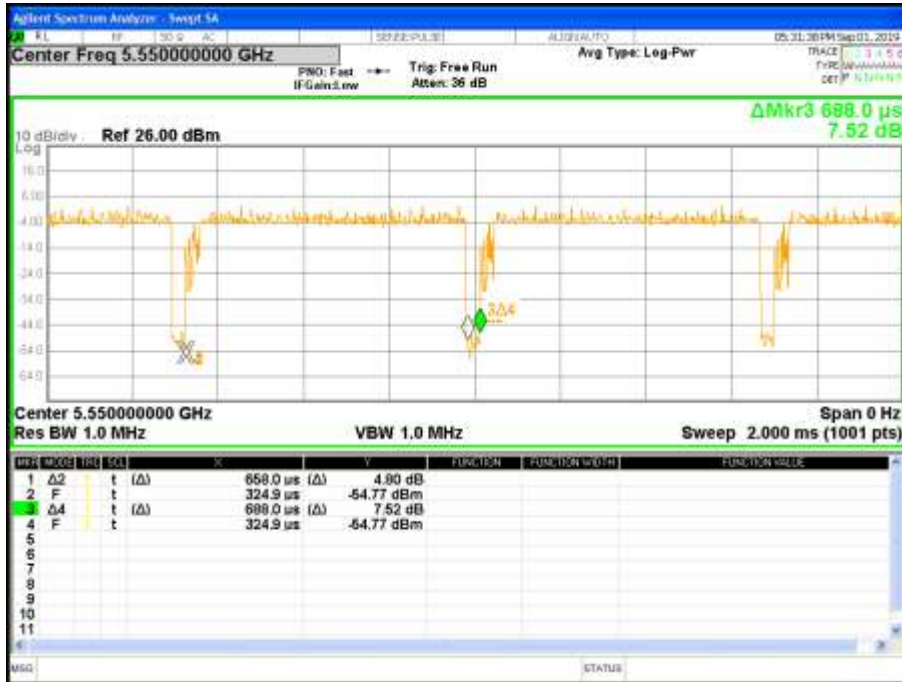

802.11ac VHT80





5.8G

802.11a



802.11n HT20

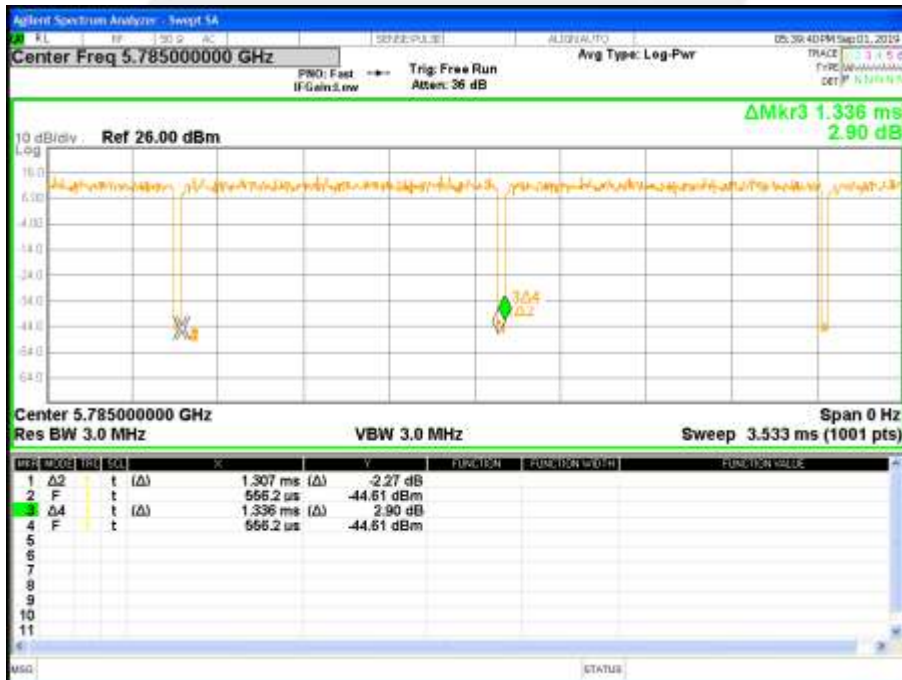



802.11n HT40



802.11ac VHT20

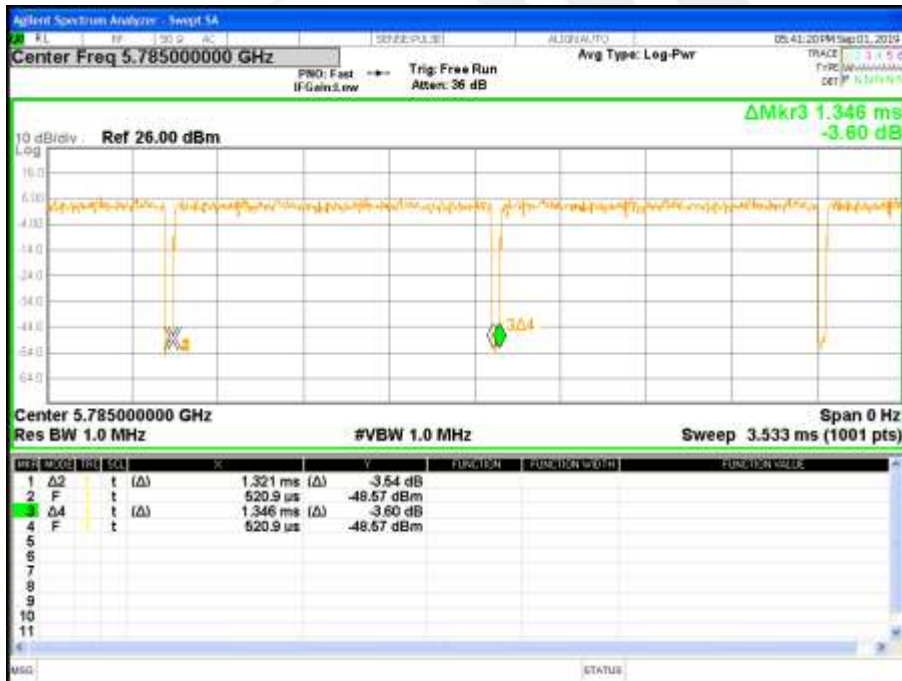



802.11ac VHT40

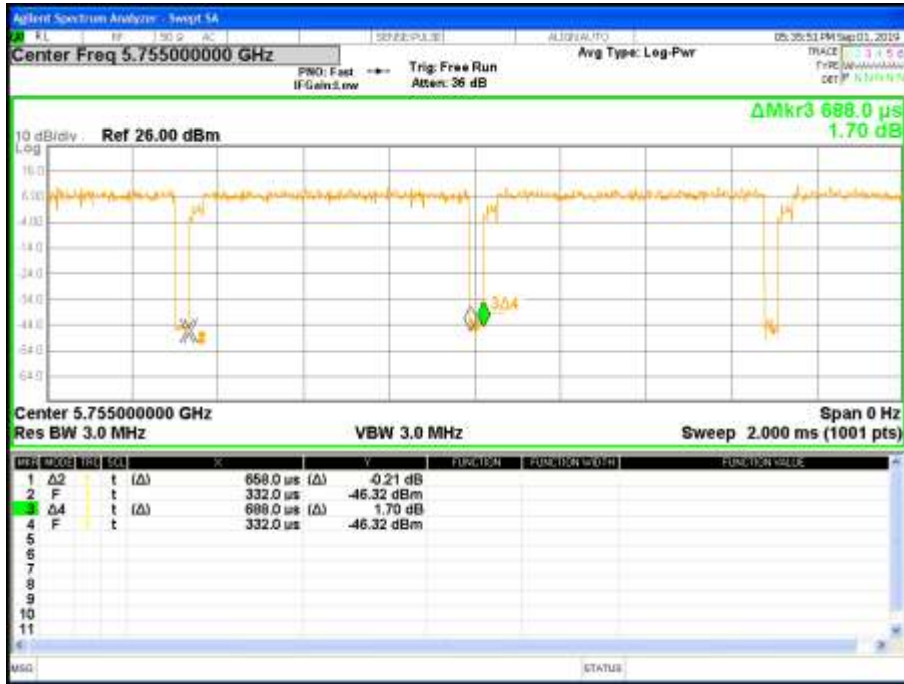

802.11ac VHT80





## **8. AUTOMATICALLY DISCONTINUE TRANSMISSION**

### **8.1 LIMIT OF AUTOMATICALLY DISCONTINUE TRANSMISSION**

The device shall automatically discontinue transmission in case of either absence of information to transmit or operational failure. These provisions are not intended to preclude the transmission of control or signaling information or the use of repetitive codes used by certain digital technologies to complete frame or burst intervals. Applicants shall include in their application for equipment authorization to describe how this requirement is met.

### **8.2 TEST RESULT OF AUTOMATICALLY DISCONTINUE TRANSMISSION**

During no any information transmission, the EUT can automatically discontinue transmission and become standby mode for power saving. The EUT can detect the controlling signal of ACK message transmitting from remote device and verify whether it shall resend or discontinue transmission







## 9. ANTENNA REQUIREMENT

### 9.1 STANDARD REQUIREMENT

15.203 requirement: For intentional device, according to 15.203: an intentional radiator shall be designed to ensure that no antenna other than that furnished by the responsible party shall be used with the device.

### 9.2 EUT ANTENNA

The EUT antenna is PIFA Antenna. It comply with the standard requirement.





## APPENDIX- PHOTOS OF TEST SETUP

Note: See test photos in setup photo document for the actual connections between Product and support equipment.

※※※※END OF THE REPORT※※※※

