



RF TEST REPORT

Product Name: TANK

Model Name: TANK 01

FCC ID: 2AK6CTANK01

Issued For : Shanghai Unihertz E-Commerce Co., Ltd

Room 308, Building C, 508Chundong Rd, Minhang district
Shanghai, China 201108

Issued By : Shenzhen LGT Test Service Co., Ltd.

Room 205, Building 13, Zone B, Chen Hsong Industrial Park,
No.177 Renmin West Road, Jinsha Community, Kengzi
Street, Pingshan New District, Shenzhen, China

Report Number: LGT22J019RF12

Sample Received Date: October 14, 2022

Date of Tested: October 14, 2022 – October 25, 2022

Date of Issue: October 31, 2022

The test report is effective only with both signature and specialized stamp. This report shall not be reproduced except in full without the written approval of the Laboratory. The results in this report only apply to the tested sample.



TEST REPORT CERTIFICATION

Applicant Shanghai Unihertz E-Commerce Co., Ltd
Address Room 308, Building C, 508Chundong Rd, Minhang district
Shanghai, China 201108

Manufacturer OBLUE Communication Technology Co., Ltd.
Address 7th floor, building B, dayou industrial and trade industrial
park, heping yonghe road, fuyong street, baoan district,
Shenzhen, China

Product Name TANK
Trademark Unihertz
Model Name TANK 01
Sample Status: Normal

APPLICABLE STANDARDS	
STANDARD	TEST RESULTS
FCC Part 15.247, Subpart C ANSI C63.10-2013	PASS

Prepared by:

Zane Shan

Zane Shan
Engineer

Approved by:

Vita Li

Vita Li
Technical Director





Table of Contents	Page
1. SUMMARY OF TEST RESULTS	6
1.1 TEST FACTORY	7
1.2 MEASUREMENT UNCERTAINTY	7
2. GENERAL INFORMATION	8
2.1 GENERAL DESCRIPTION OF THE EUT	8
2.2 DESCRIPTION OF THE TEST MODES	10
2.3 TEST SOFTWARE AND POWER LEVEL	11
2.5 EQUIPMENTS LIST FOR ALL TEST ITEMS	12
3. EMC EMISSION TEST	13
3.1 CONDUCTED EMISSION MEASUREMENT	13
3.2 RADIATED EMISSION MEASUREMENT	17
4. CONDUCTED SPURIOUS & BAND EDGE EMISSION	34
4.1 LIMIT	34
4.2 TEST PROCEDURE	34
4.3 DEVIATION FROM STANDARD	34
4.4 TEST SETUP	34
4.5 EUT OPERATION CONDITIONS	34
4.6 TEST RESULTS	34
5. POWER SPECTRAL DENSITY TEST	35
5.1 LIMIT	35
5.2 TEST PROCEDURE	35
5.3 DEVIATION FROM STANDARD	35
5.4 TEST SETUP	35
5.5 EUT OPERATION CONDITIONS	35
5.6 TEST RESULTS	35
6. BANDWIDTH TEST	36
6.1 LIMIT	36
6.2 TEST PROCEDURE	36
6.3 DEVIATION FROM STANDARD	36
6.4 TEST SETUP	36
6.5 EUT OPERATION CONDITIONS	36
6.6 TEST RESULTS	36



Table of Contents	Page
7. PEAK OUTPUT POWER TEST	37
7.1 LIMIT	37
7.2 TEST PROCEDURE	37
7.3 DEVIATION FROM STANDARD	37
7.4 TEST SETUP	37
7.5 EUT OPERATION CONDITIONS	37
7.6 TEST RESULTS	37
8. ANTENNA REQUIREMENT	38
8.1 STANDARD REQUIREMENT	38
8.2 EUT ANTENNA	38
APPENDIX I:TEST RESULTS	39
DUTY CYCLE	39
MAXIMUM PEAK CONDUCTED OUTPUT POWER	46
-6DB BANDWIDTH	47
MAXIMUM POWER SPECTRAL DENSITY LEVEL	54
BAND EDGE	61
CONDUCTED RF SPURIOUS EMISSION	70
APPENDIX II:PHOTOS OF TEST SETUP	83



Revision History

Rev.	Issue Date	Contents
00	Oct. 31, 2022	Initial Issue



1. SUMMARY OF TEST RESULTS

Test procedures according to the technical standards:
KDB 558074 D01 15.247 Meas Guidance v05r02.

FCC Part 15.247, Subpart C			
Standard Section	Test Item	Judgment	Remark
15.207	Conducted Emission	PASS	--
15.247 (a)(2)	6dB Bandwidth	PASS	--
15.247 (b)(3)	Output Power	PASS	--
15.209	Radiated Spurious Emission	PASS	--
15.247 (d)	Conducted Spurious & Band Edge Emission	PASS	--
15.247 (e)	Power Spectral Density	PASS	--
15.205	Restricted Band Edge Emission	PASS	--
Part 15.247(d)/ Part 15.209(a)	Band Edge Emission	PASS	--
15.203	Antenna Requirement	PASS	--

NOTE:

- (1) 'N/A' denotes test is not applicable in this Test Report.
- (2) All tests are according to ANSI C63.10-2013.



1.1 TEST FACTORY

Company Name:	Shenzhen LGT Test Service Co., Ltd.
Address:	Room 205, Building 13, Zone B, Chen Hsong Industrial Park, No.177 Renmin West Road, Jinsha Community, Kengzi Street, Pingshan New District, Shenzhen, China
Accreditation Certificate	A2LA Certificate No.: 6727.01
	FCC Registration No.: 746540
	CAB ID: CN0136

1.2 MEASUREMENT UNCERTAINTY

The reported uncertainty of measurement $y \pm U$, where expanded uncertainty U is based on a standard uncertainty multiplied by a coverage factor of $k=2$, providing a level of confidence of approximately **95** %.

No.	Item	Uncertainty
1	RF Output Power, Conducted	± 0.71 dB
2	Power Spectral Density, Conducted	± 1.57 dB
3	Unwanted Emission, Conducted	± 0.63 dB
4	Conducted emission	± 2.80 dB
5	All Emissions, Radiated (0.009-30MHz)	± 2.16 dB
6	All Emissions, Radiated (30MHz-1GHz)	± 4.40 dB
7	All Emissions, Radiated (1GHz-18GHz)	± 5.49 dB



2. GENERAL INFORMATION

2.1 GENERAL DESCRIPTION OF THE EUT

Product Name	TANK	
Trademark	Unihertz	
Model Name	TANK 01	
Series Model	N/A	
Model Difference	N/A	
Product Description	The EUT is a TANK	
	Operation Frequency:	802.11b/g/n: 2412~2462 MHz 802.11n (40MHz):2422~2452MHz
	Modulation Type:	802.11b(DSSS):CCK,DQPSK,DBPSK 802.11g(OFDM):BPSK,QPSK,16-QAM,64-QAM 802.11n(OFDM):BPSK,QPSK,16-QAM,64-QAM
	Number of Channel:	802.11b/g/n: 11CH 802.11n: 7CH
	Antenna Designation:	PIFA Antenna
	Antenna Gain(dBi):	1.2
Channel List	Please refer to the Note 2.	
Adapter	Model: HJ-PD66W-US Input: 100-240V, 50/60Hz, 1.5A Output: 5V, 3A 15W or 9V, 3A 27W or 12V, 3A 36W or 15V, 3A 45W or 20V, 3.25A 65W or 11V, 6A 66W MAX	
Battery	Capacity: 22000mAh Rated Voltage: 3.87V	
Hardware version number	G86_V1.1	
Software versionnumber	TANK 01_20221103	
Connecting I/O Port(s)	Please refer to the Note 1.	

Note:

1. For a more detailed features description, please refer to the manufacturer's specifications or the User Manual.



2.

Operation Frequency of channel			
802.11b/g/n(20MHz)		Channel List for 802.11n(40MHz)	
Channel	Frequency	Channel	Frequency
01	2412	03	2422
02	2417	04	2427
03	2422	05	2432
04	2427	06	2437
05	2432	07	2442
06	2437	08	2447
07	2442	09	2452
08	2447		
09	2452		
10	2457		
11	2462		

Note:

In section 15.31(m), regards to the operating frequency range over 10 MHz, the Lowest frequency, the middle frequency, and the highest frequency of channel were selected to perform the test, and the selected channel see below:

Carrier Frequency Channel

2.4GHz Test Frequency:

For 802.11b/g/n (HT20)		For 802.11n (HT40)	
Channel	Freq.(MHz)	Channel	Freq.(MHz)
01	2412	03	2422
06	2437	06	2437
11	2462	09	2452

3. KDB 662911 D01 Multiple Transmitter Output v02r01

2) Directional Gain Calculations for In-Band Measurements

a) Basic methodology with NANT transmit antennas, each with the same directional gain GANT dBi, being driven by NANT transmitter outputs of equal power. Directional gain is to be computed as follows:

(i) If any transmit signals are correlated with each other,
Directional gain = GANT + 10 log(NANT) dBi

(ii) If all transmit signals are completely uncorrelated with each other,
Directional gain = GANT

4

Ant.	Brand	Model Name	Antenna Type	Connector	Gain (dBi)	Note
1	Unihertz	TANK	PIFA antenna	N/A	1.2	WLAN Antenna

Note: The antenna information refer the manufacturer provide report, applicable only to the tested sa-mple identified in the report.



2.2 DESCRIPTION OF THE TEST MODES

Each of these EUT operation mode(s) or test configuration mode(s) mentioned above was evaluated respectively.

Worst Mode	Description	Data Rate
Mode 1	TX IEEE 802.11b CH1	1 Mbps
Mode 2	TX IEEE 802.11b CH6	1 Mbps
Mode 3	TX IEEE 802.11 b CH11	1 Mbps
Mode 4	TX IEEE 802.11g CH1	6 Mbps
Mode 5	TX IEEE 802.11g CH6	6 Mbps
Mode 6	TX IEEE 802.11g CH11	6 Mbps
Mode 7	TX IEEE 802.11n HT20 CH1	MCS 0
Mode 8	TX IEEE 802.11n HT20 CH6	MCS 0
Mode 9	TX IEEE 802.11n HT20 CH11	MCS 0
Mode 10	TX IEEE 802.11n HT40 CH3	MCS 0
Mode 11	TX IEEE 802.11n HT40 CH6	MCS 0
Mode 12	TX IEEE 802.11n HT40 CH9	MCS 0

Note:

(1) The measurements are performed at all Bit Rate of Transmitter, the worst data was reported.

AC Conducted Emission

Test Case	
AC Conducted Emission	Mode13: Keeping TX + WLAN Link



2.3 TEST SOFTWARE AND POWER LEVEL

During testing channel & power controlling software provided by the customer was used to control the operating channel as well as the output power level.

RF Function	Type	Mode Or Modulation type	ANT Gain(dBi)	ANT_A Power Class	Software For Testing
WIFI(2.4G)	2.4G WIFI	802.11b	1.2	17	Engineering mode
		802.11g		7	
		802.11n(HT20)		4	
		802.11n(HT40)		4	

2.4 DESCRIPTION OF necessary accessories AND support units

During testing channel & power controlling software provided by the customer was used to control the operating channel as well as the output power level.

Accessories Equipment

Description	Manufacturer	Model	S/N	Rating
Type-C Cable	N/A	N/A	N/A	1m
Adapter	Huajin	HJ-PD66W-EU	N/A	Input: 100-240V ~ 50/60Hz 1.5A Output: 5V@3A 9V@3A 12V@3A 15V@3A 20V@3A 11V@6A

Auxiliary Equipment

Description	Manufacturer	Model	S/N	Rating
Earphone	N/A	39630078	N/A	N/A

Note:

- (1) For detachable type I/O cable should be specified the length in cm in 『Length』 column.



2.5 EQUIPMENTS LIST FOR ALL TEST ITEMS

Radiation Test equipment

Kind of Equipment	Manufacturer	Type No.	Company No.	Last calibration	Calibrated until
EMI Test Receiver	R&S	ESU8	100372	2022.04.12	2023.04.11
Active loop Antenna	R&S	HFH2-Z2	POS87139818 1	2022.06.02	2024.06.01
Spectrum Analyzer	Kesight	N9010B	MY60242508	2022.04.29	2023.04.28
Bilog Antenna	SCHAFFNER	CBL6112B	2705	2022.06.05	2024.06.04
Horn Antenna	SCHWARZBECK	3115	10SL0060	2022.06.02	2024.06.01
Pre-amplifier(0.1M-3G Hz)	HP	8447D	2727A05655	2022.04.11	2023.04.10
Pre-amplifier(1-26.5G)	Agilent	8449B	3008A4722	2022.04.13	2023.04.12
RE Cable (9K-1G)	N.A	R01	N.A	2022.05.05	2023.05.04
RE Cable (1-26G)	N.A	R02	N.A	2022.05.05	2023.05.04
Wireless Communications Test Set	R&S	CMW 500	137737	2022.04.29	2023.04.28
Temperature & Humidity	KTJ	TA218B	N.A	2022.05.05	2023.05.04
Testing Software	EZ-EMC(Ver.STSLAB 03A1 RE)				

Conduction Test equipment

Kind of Equipment	Manufacturer	Type No.	Company No.	Last calibration	Calibrated until
EMI Test Receiver	R&S	ESU8	100372	2022.04.12	2023.04.11
LISN	COM-POWER	LI-115	02032	2022.04.13	2023.04.12
LISN	SCHWARZBECK	NNLK 8121	00847	2022.08.19	2023.08.18
CE Cable	N.A	C01	N.A	2022.05.05	2023.05.04
Transient Limiter	CYBERTEK	EM5010A	E2250100049	2022.08.19	2023.08.18
Temperature & Humidity	KTJ	TA218B	N.A	2022.05.05	2023.05.04
Testing Software	EZ-EMC(Ver.EMC-CON 3A1.1)				

RF Connected Test

Kind of Equipment	Manufacturer	Type No.	Company No.	Last calibration	Calibrated until
Signal Analyzer	keysight	N9010B	MY60242508	2022.04.29	2023.04.28
RF Automatic Test system	迈微	MW200-RFCB	MW220322LG	2022.04.29	2023.04.28
Temperature & Humidity	KTJ	TA218B	N.A	2022.05.05	2023.05.04
Temperature & Humidity test chamber	AISRY	LX-1000L	171200018	2022.05.10	2023.05.09
Attenuator	eastsheep	90db	N.A	2022.04.29	2023.04.28
Router	WAVLINK	WL-WN575A2	WL1512260336	N.C.R	N.C.R
Router	TP-LINK	TL-WR885N	1125074010735	N.C.R	N.C.R
Testing Software	MTS8310_V2.0.0.0_迈微				



3. EMC EMISSION TEST

3.1 CONDUCTED EMISSION MEASUREMENT

3.1.1 POWER LINE CONDUCTED EMISSION LIMITS

The radio frequency voltage that is conducted back onto the AC power line on any frequency or frequencies, within the band 150 kHz to 30 MHz, shall not exceed the limits in the following table.

FREQUENCY (MHz)	Conducted Emissionlimit (dBuV)	
	Quasi-peak	Average
0.15 -0.5	66 - 56 *	56 - 46 *
0.50 -5.0	56.00	46.00
5.0 -30.0	60.00	50.00

Note:

- (1) The tighter limit applies at the band edges.
- (2) The limit of “ * ” marked band means the limitation decreases linearly with the logarithm of the frequency in the range.

The following table is the setting of the receiver

Receiver Parameters	Setting
Attenuation	10 dB
Start Frequency	0.15 MHz
Stop Frequency	30 MHz
IF Bandwidth	9 kHz

3.1.2 TEST PROCEDURE

- a. The EUT is 0.8 m from the horizontal ground plane and 0.4 m from the vertical ground plane with EUT being connected to the power mains through a line impedance stabilization network (LISN). All other support equipments are powered from additional LISN(s). The LISN provides 50 Ohm/ 50uH of coupling impedance for the measuring instrument.
- b. Interconnecting cables that hang closer than 40 cm to the ground plane shall be folded back and forth in the center forming a bundle 30 to 40 cm long.
- c. I/O cables that are not connected to a peripheral shall be bundled in the center. The end of the cable may be terminated, if required, using the correct terminating impedance. The overall length shall not exceed 1 m.
- d. LISN is at least 80 cm from the nearest part of EUT chassis.
- e. For the actual test configuration, please refer to the related Item –EUT Test Photos.

3.1.3 TEST SETUP

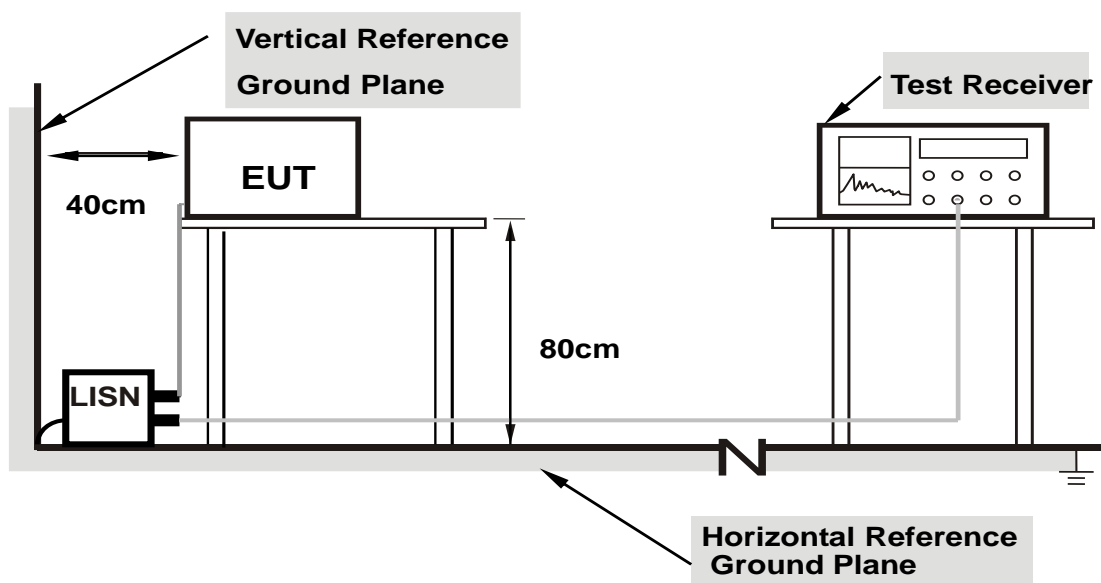

- Note: 1. Support units were connected to second LISN.**
- 2. Both of LISNs (AMN) are 80 cm from EUT and at least 80 cm from other units and other metal planes support units.**

3.1.4 EUT OPERATING CONDITIONS

The EUT was configured for testing in a typical fashion (as a customer would normally use it). The EUT has been programmed to continuously transmit during test. This operating condition was tested and used to collect the included data.



3.1.5 TEST RESULT

Project: LGT22J019	Test Engineer: Dylan.shi
EUT: Smart phone	Temperature: 24.1°C
M/N: TANK 01	Humidity: 42%RH
Test Voltage: AC 120V/60Hz	Test Data: 2022-10-19
Test Mode: TX 2.4G WIFI	
Note:	

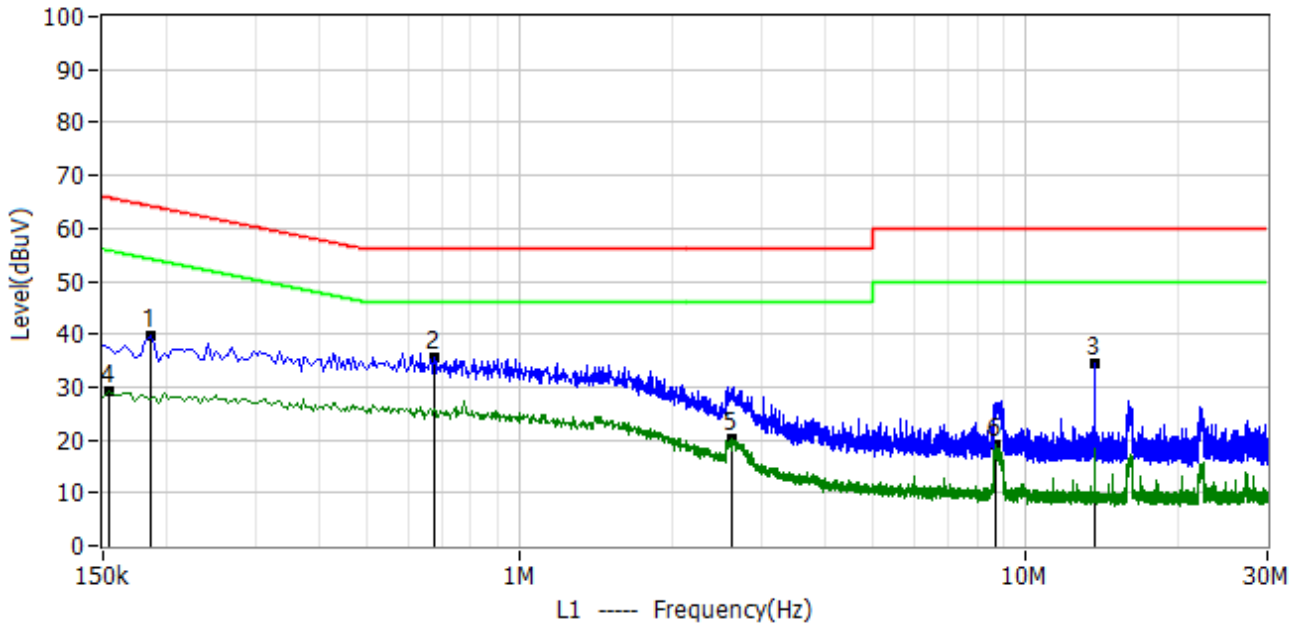

No.	Frequency	Reading dBuV	Factor dB	Level dBuV	Limit dBuV	Margin dB	Detector	Polar
1*	186.000kHz	29.30	10.50	39.80	64.21	-24.41	PK	L1
2*	678.000kHz	24.94	10.51	35.45	56.00	-20.55	PK	L1
3*	13.718MHz	23.33	11.01	34.34	60.00	-25.66	PK	L1
4*	154.000kHz	18.53	10.50	29.03	55.78	-26.75	AV	L1
5*	2.618MHz	9.32	10.76	20.08	46.00	-25.92	AV	L1
6*	8.678MHz	8.11	10.92	19.03	50.00	-30.97	AV	L1



Project: LGT22J019	Test Engineer: Dylan.shi
EUT: Smart phone	Temperature: 24.1℃
M/N: TANK 01	Humidity: 42%RH
Test Voltage: AC 120V/60Hz	Test Data: 2022-10-19
Test Mode: TX 2.4G WIFI	
Note:	

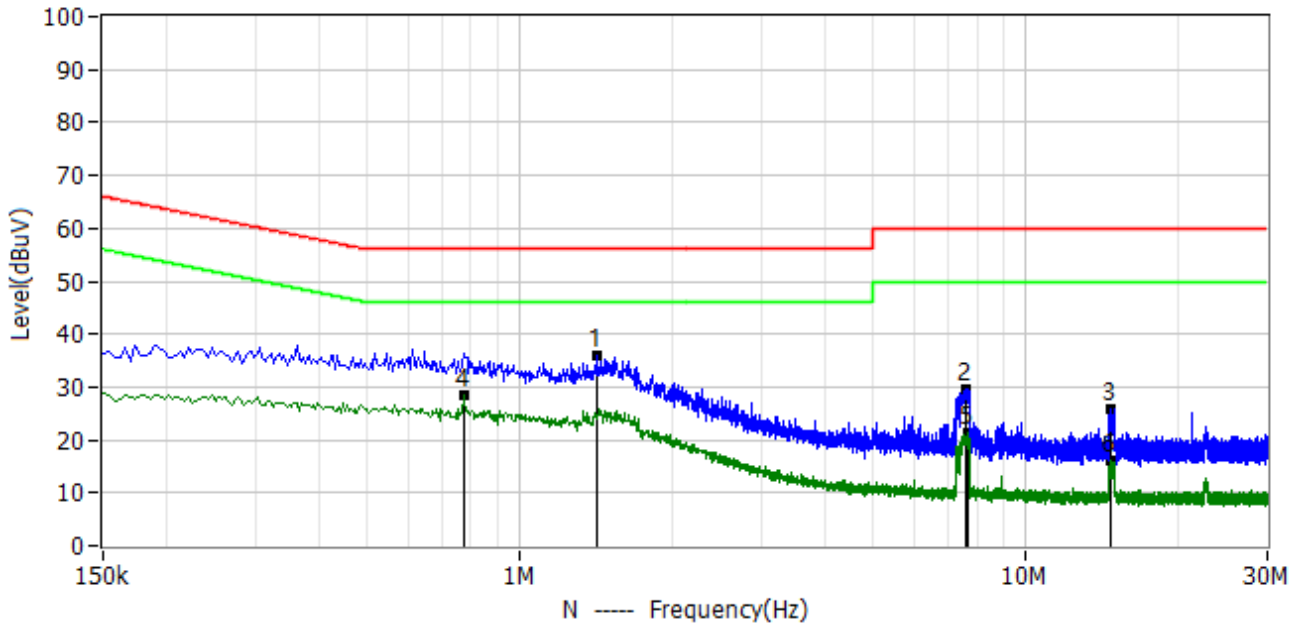

No.	Frequency	Reading dBuV	Factor dB	Level dBuV	Limit dBuV	Margin dB	Detector	Polar
1*	1.418MHz	25.50	10.62	36.12	56.00	-19.88	PK	N
2*	7.638MHz	18.73	10.90	29.63	60.00	-30.37	PK	N
3*	14.750MHz	14.87	11.06	25.93	60.00	-34.07	PK	N
4*	774.000kHz	17.77	10.52	28.29	46.00	-17.71	AV	N
5*	7.670MHz	10.51	10.90	21.41	50.00	-28.59	AV	N
6*	14.650MHz	5.02	11.05	16.07	50.00	-33.93	AV	N



3.2 RADIATED EMISSION MEASUREMENT

3.2.1 RADIATED EMISSION LIMITS

In any 100 kHz bandwidth outside the operating frequency band. In case the emission fall within the Restricted band specified on Part15.205(a)&209(a) limit in the table and according to ANSI C63.10-2013 below has to be followed.

LIMITS OF RADIATED EMISSION MEASUREMENT (0.009MHz - 1000MHz)

Frequencies (MHz)	Field Strength (micovolts/meter)	Measurement Distance (meters)
0.009~0.490	2400/F(KHz)	300
0.490~1.705	24000/F(KHz)	30
1.705~30.0	30	30
30~88	100	3
88~216	150	3
216~960	200	3
Above 960	500	3

LIMITS OF RADIATED EMISSION MEASUREMENT (1000MHz-25GHz)

FREQUENCY (MHz)	(dBuV/m) (at 3M)	
	PEAK	AVERAGE
Above 1000	74	54

Notes:

- (1) The limit for radiated test was performed according to FCC PART 15C.
- (2) The tighter limit applies at the band edges.
- (3) Emission level (dBuV/m)=20log Emission level (uV/m).

LIMITS OF RESTRICTED FREQUENCY BANDS

FREQUENCY (MHz)	FREQUENCY (MHz)	FREQUENCY (MHz)	FREQUENCY (GHz)
0.090-0.110	16.42-16.423	399.9-410	4.5-5.15
0.495-0.505	16.69475-16.69525	608-614	5.35-5.46
2.1735-2.1905	16.80425-16.80475	960-1240	7.25-7.75
4.125-4.128	25.5-25.67	1300-1427	8.025-8.5
4.17725-4.17775	37.5-38.25	1435-1626.5	9.0-9.2
4.20725-4.20775	73-74.6	1645.5-1646.5	9.3-9.5
6.215-6.218	74.8-75.2	1660-1710	10.6-12.7
6.26775-6.26825	108-121.94	1718.8-1722.2	13.25-13.4
6.31175-6.31225	123-138	2200-2300	14.47-14.5
8.291-8.294	149.9-150.05	2310-2390	15.35-16.2
8.362-8.366	156.52475-156.52525	2483.5-2500	17.7-21.4
8.37625-8.38675	156.7-156.9	2690-2900	22.01-23.12
8.41425-8.41475	162.0125-167.17	3260-3267	23.6-24.0
12.29-12.293	167.72-173.2	3332-3339	31.2-31.8
12.51975-12.52025	240-285	3345.8-3358	36.43-36.5
12.57675-12.57725	322-335.4	3600-4400	Above 38.6
13.36-13.41			

For Radiated Emission



Spectrum Parameter	Setting
Attenuation	Auto
Detector	Peak/QP/AV
Start Frequency	9 KHz/150KHz(Peak/QP/AV)
Stop Frequency	150KHz/30MHz(Peak/QP/AV)
RB / VB (emission in restricted band)	200Hz (From 9kHz to 0.15MHz)/ 9KHz (From 0.15MHz to 30MHz); 200Hz (From 9kHz to 0.15MHz)/ 9KHz (From 0.15MHz to 30MHz)

Spectrum Parameter	Setting
Attenuation	Auto
Detector	Peak/QP
Start Frequency	30 MHz(Peak/QP)
Stop Frequency	1000 MHz (Peak/QP)
RB / VB (emission in restricted band)	120 KHz / 300 KHz

Spectrum Parameter	Setting
Attenuation	Auto
Detector	Peak/AV
Start Frequency	1000 MHz(Peak/AV)
Stop Frequency	10th carrier hamonic(Peak/AV)
RB / VB (emission in restricted band)	1 MHz / 3 MHz(Peak) 1 MHz/1/T MHz(AVG)

For Restricted band

Spectrum Parameter	Setting
Detector	Peak/AV
Start/Stop Frequency	Lower Band Edge: 2310 to 2430 MHz Upper Band Edge: 2445 to 2500 MHz
RB / VB	1 MHz / 3 MHz(Peak) 1 MHz/1/T MHz(AVG)



Receiver Parameter	Setting
Start ~ Stop Frequency	9kHz~90kHz / RB 200Hz for PK & AV
Start ~ Stop Frequency	90kHz~110kHz / RB 200Hz for QP
Start ~ Stop Frequency	110kHz~490kHz / RB 200Hz for PK & AV
Start ~ Stop Frequency	490kHz~30MHz / RB 9kHz for QP
Start ~ Stop Frequency	30MHz~1000MHz / RB 120kHz for QP

3.2.2 TEST PROCEDURE

- a. The measuring distance at 3 m shall be used for measurements at frequency 0.009MHz up to 1GHz, and above 1GHz.
- b. The EUT was placed on the top of a rotating table 0.8 m (above 1GHz is 1.5 m) above the ground at a 3 m anechoic chamber test site. The table was rotated 360 degree to determine the position of the highest radiation.
- c. The height of the equipment shall be 0.8 m (above 1GHz is 1.5 m); the height of the test antenna shall vary between 1 m to 4 m. Horizontal and vertical polarization of the antenna are set to make the measurement.
- d. The initial step in collecting conducted emission data is a spectrum analyzer peak detector mode pre-scanning the measurement frequency range. Significant peaks are then marked and QuasiPeak detector mode will be re-measured.
- e. If the Peak Mode measured value is compliance with and lower than Quasi Peak Mode Limit, the EUT shall be deemed to meet QP Limits and no additional QP Mode measurement was performed.
- f. For the actual test configuration, please refer to the related Item –EUT Test Photos.

Note:

Both horizontal and vertical antenna polarities were tested and performed pretest to three orthogonal axis. The worst case emissions were reported.

3.2.3 TEST SETUP

(A) Radiated Emission Test-Up Frequency Below 30MHz

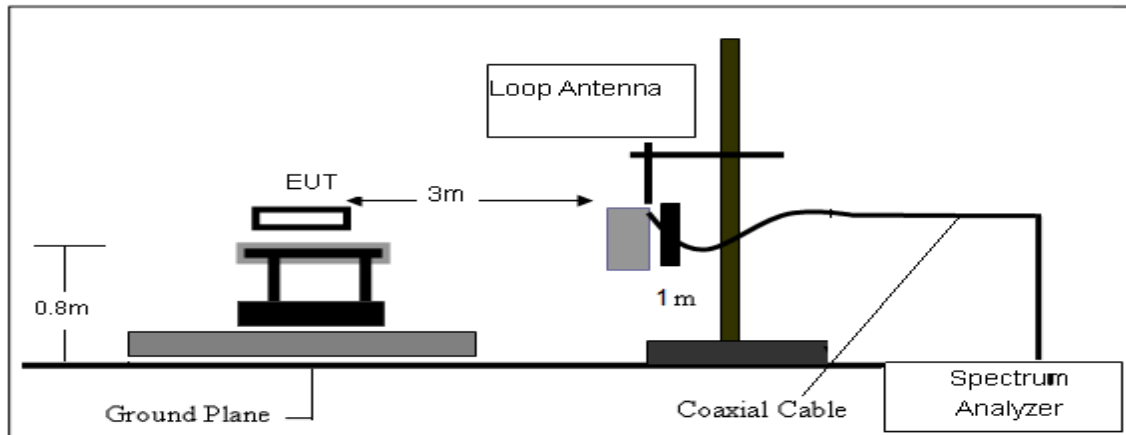

(B) Radiated Emission Test-Up Frequency 30MHz~1GHz

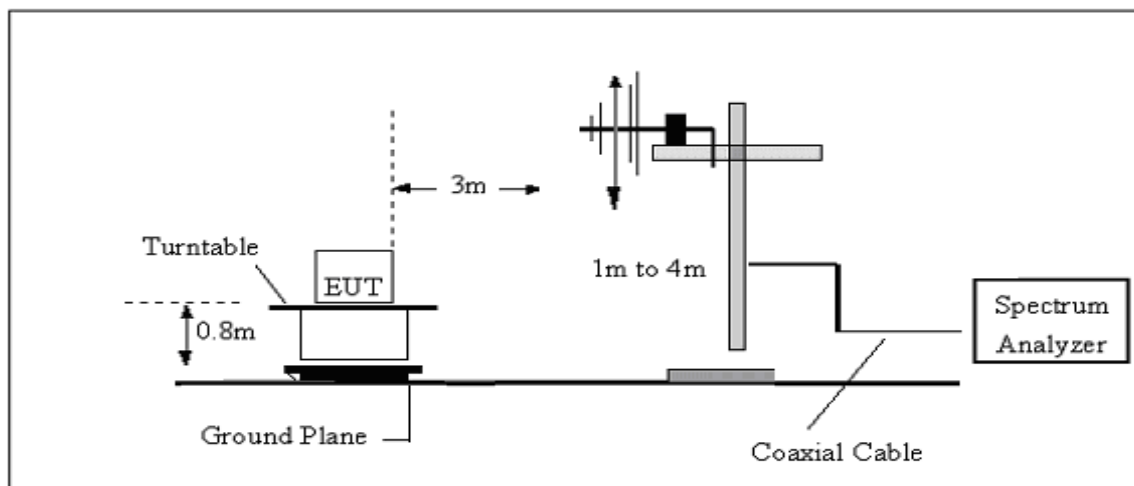

(C) Radiated Emission Test-Up Frequency Above 1GHz

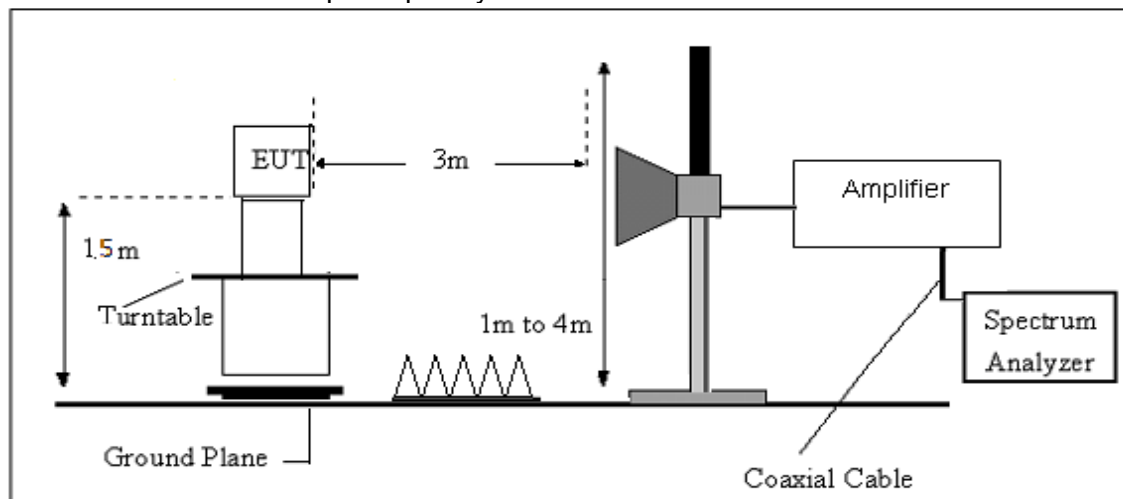

3.2.4 EUT OPERATING CONDITIONS

Please refer to section 3.1.4 of this report.



3.2.5 FIELD STRENGTH CALCULATION

The field strength is calculated by adding the Antenna Factor and Cable Factor and subtracting the Amplifier Gain and Duty Cycle Correction Factor (if any) from the measured reading. The basic equation with a sample calculation is as follows:

$$FS = RA + AF + CL - AG$$

Where

FS = Field Strength

CL = Cable Attenuation Factor (Cable Loss)

RA = Reading Amplitude

AG = Amplifier Gain

AF = Antenna Factor

For example

Frequency (MHz)	FS (dB μ V/m)	RA (dB μ V/m)	AF (dB)	CL (dB)	AG (dB)	Factor (dB)
300	40	58.1	12.2	1.6	31.9	-18.1

$$\text{Factor} = \text{AF} + \text{CL} - \text{AG}$$



3.2.6 TEST RESULT

Project: LGT22J019	Test Engineer: Dylan.shi
EUT: Smart phone	Temperature: 28.4°C
M/N: TANK 01	Humidity: 42%RH
Test Voltage: Power by Battery	Test Data: 2022-10-25
Test Mode: TX 2.4G WIFI	
Note:	

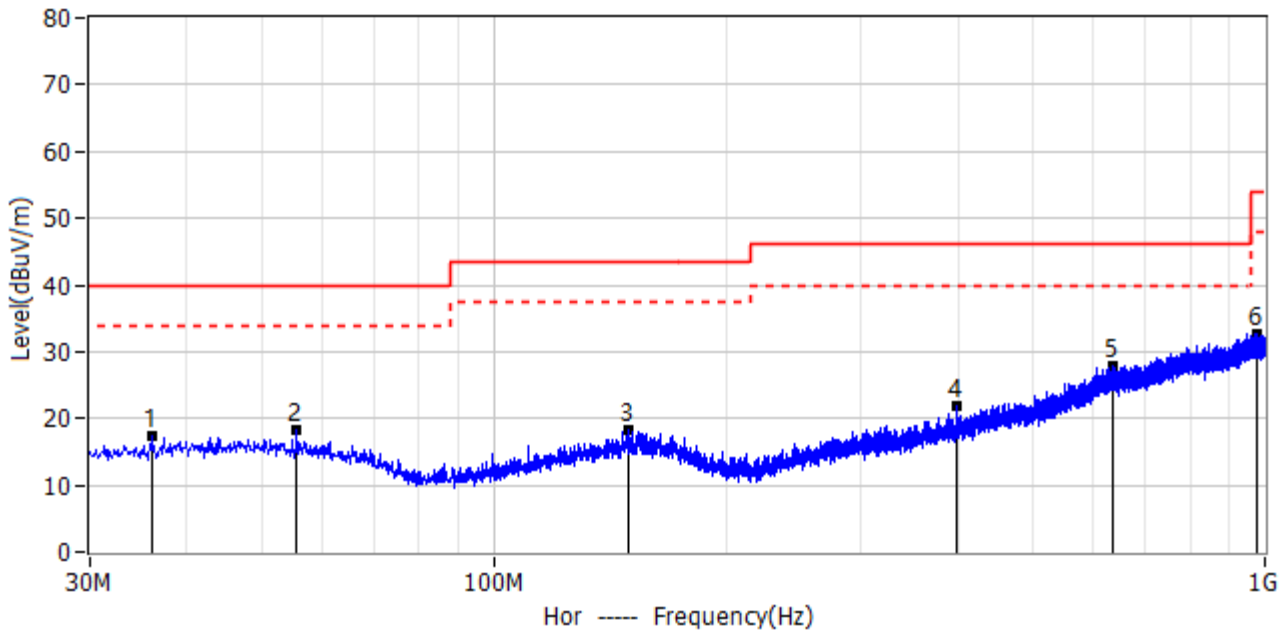

No.	Frequency	Reading dBuV	Factor dB/m	Level dBuV/m	Limit dBuV/m	Margin dB	Detector	Polar
1*	36.184MHz	3.92	13.33	17.25	40.00	-22.75	PK	Hor
2*	55.463MHz	4.84	13.33	18.17	40.00	-21.83	PK	Hor
3*	149.189MHz	4.26	14.13	18.39	43.50	-25.11	PK	Hor
4*	399.691MHz	4.92	17.04	21.96	46.00	-24.04	PK	Hor
5*	636.129MHz	5.00	22.82	27.82	46.00	-18.18	PK	Hor
6*	976.235MHz	4.92	27.84	32.76	54.00	-21.24	PK	Hor



Project: LGT22J019	Test Engineer: Dylan.shi
EUT: Smart phone	Temperature: 28.4°C
M/N: TANK 01	Humidity: 42%RH
Test Voltage: Power by Battery	Test Data: 2022-10-25
Test Mode: TX 2.4G WIFI	
Note:	

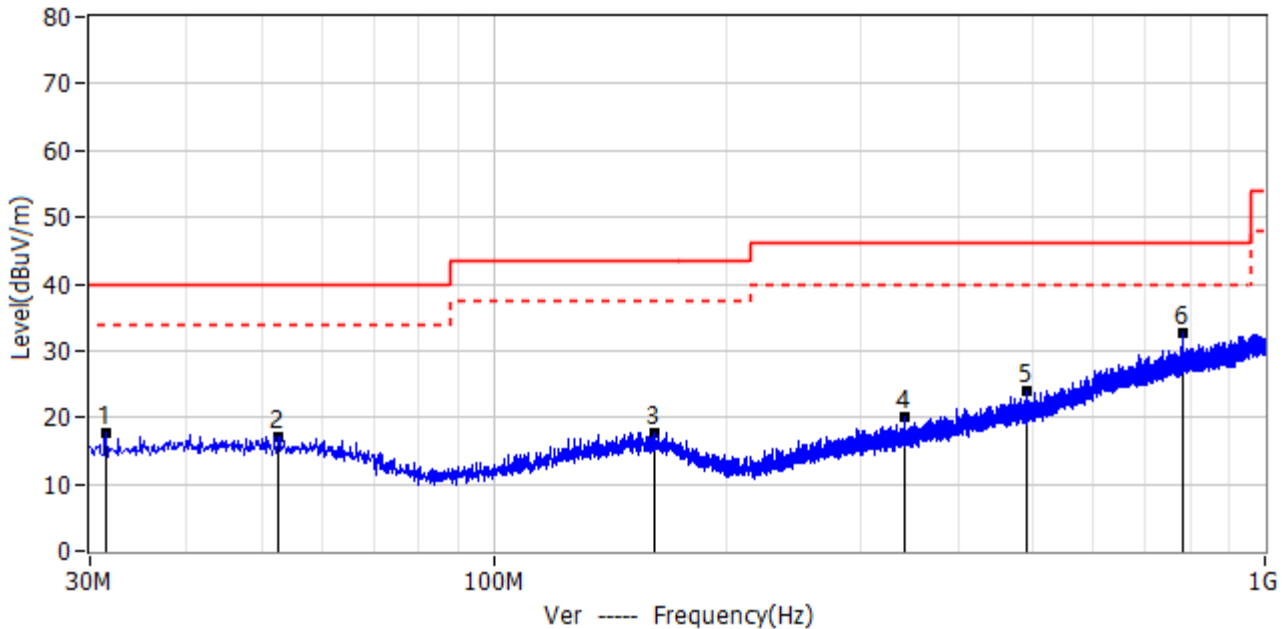

No.	Frequency	Reading dBuV	Factor dB/m	Level dBuV/m	Limit dBuV/m	Margin dB	Detector	Polar
1*	31.455MHz	4.74	12.88	17.62	40.00	-22.38	PK	Ver
2*	52.674MHz	3.66	13.56	17.22	40.00	-22.78	PK	Ver
3*	161.314MHz	3.63	14.16	17.79	43.50	-25.71	PK	Ver
4*	341.734MHz	4.40	15.56	19.96	46.00	-26.04	PK	Ver
5*	491.356MHz	4.75	19.13	23.88	46.00	-22.12	PK	Ver
6*	780.538MHz	7.22	25.33	32.55	46.00	-13.45	PK	Ver



3.2.7 TEST RESULTS (RESTRICTED BANDS REQUIREMENTS)

Project: LGT22J019	Test Engineer: Dylan.shi
EUT: Smart phone	Humidity: 41%RH
Temperature: 24.3°C	Test Voltage: Power by Battery
M/N: TANK 01	Test Data: 2022-10-26
Test Mode: 802.11b 2412	
Note:	

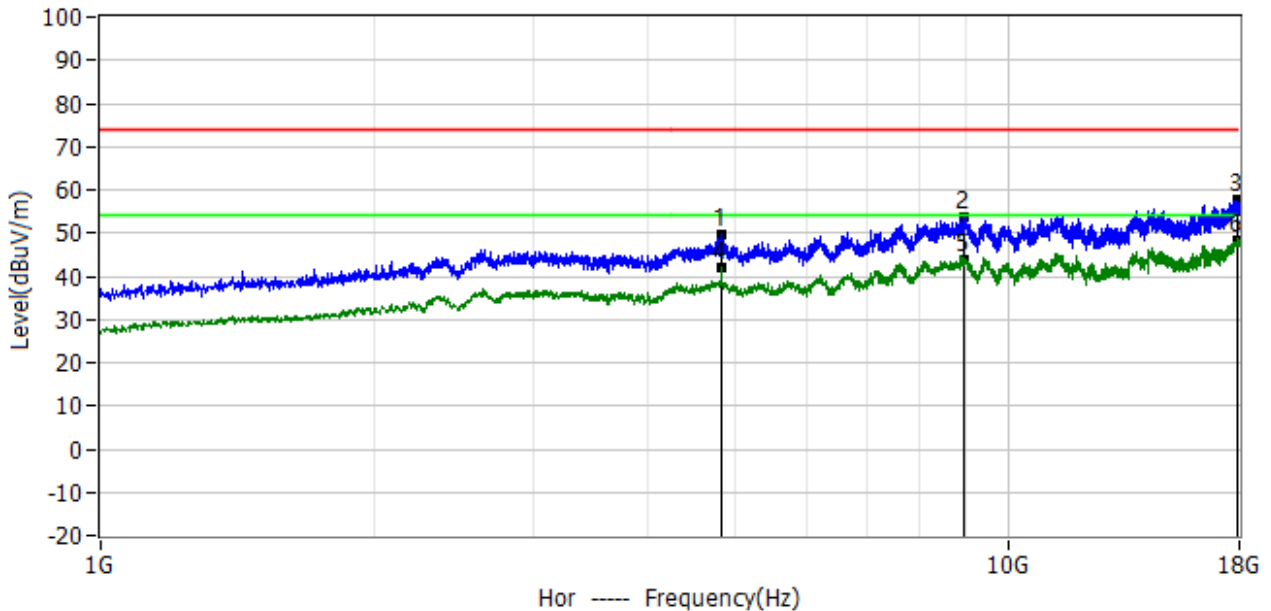

No.	Frequency	Reading dBuV	Factor dB/m	Level dBuV/m	Limit dBuV/m	Margin dB	Detector	Polar
1*	4.825GHz	55.67	-6.01	49.66	74.00	-24.34	PK	Hor
2*	8.928GHz	54.95	-1.37	53.58	74.00	-20.42	PK	Hor
3*	17.894GHz	49.08	8.45	57.53	74.00	-16.47	PK	Hor
4*	4.827GHz	48.16	-6.01	42.15	54.00	-11.85	AV	Hor
5*	8.928GHz	45.37	-1.37	44.00	54.00	-10.00	AV	Hor
6*	17.894GHz	39.95	8.45	48.40	54.00	-5.60	AV	Hor



Project: LGT22J019	Test Engineer: Dylan.shi
EUT: Smart phone	Humidity: 41%RH
Temperature: 24.3°C	Test Voltage: Power by Battery
M/N: TANK 01	Test Data: 2022-10-26
Test Mode: 802.11b 2412	
Note:	

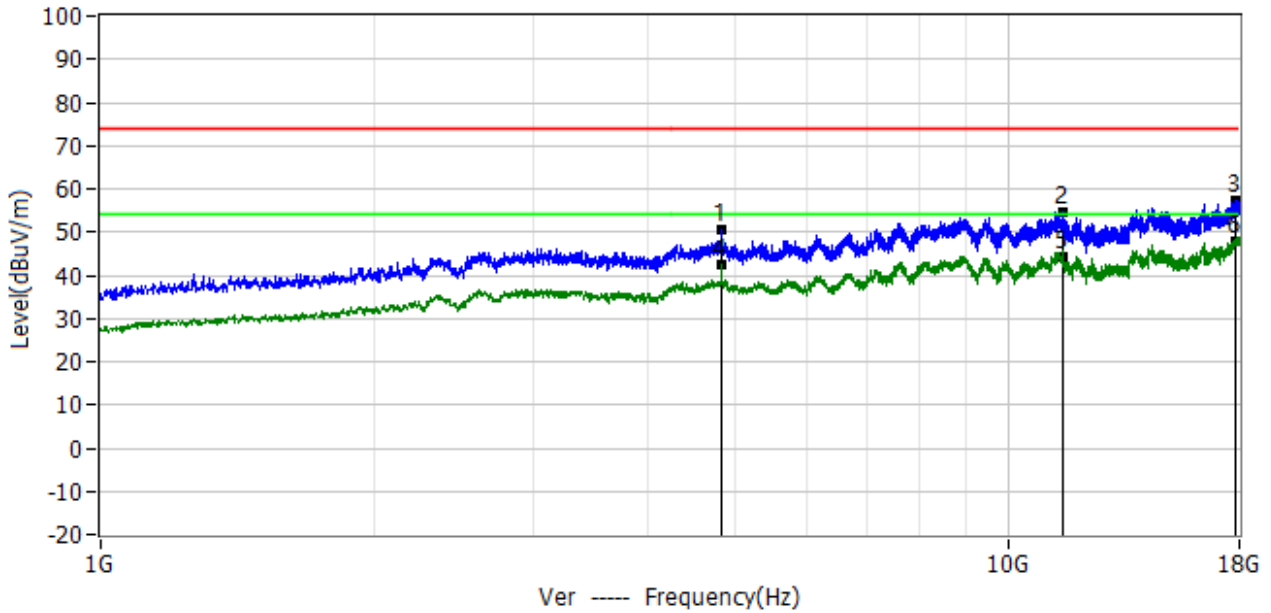

No.	Frequency	Reading dBuV	Factor dB/m	Level dBuV/m	Limit dBuV/m	Margin dB	Detector	Polar
1*	4.825GHz	56.57	-6.01	50.56	74.00	-23.44	PK	Ver
2*	11.498GHz	52.76	1.92	54.68	74.00	-19.32	PK	Ver
3*	17.849GHz	49.06	8.41	57.47	74.00	-16.53	PK	Ver
4*	4.827GHz	48.65	-6.01	42.64	54.00	-11.36	AV	Ver
5*	11.498GHz	42.48	1.92	44.40	54.00	-9.60	AV	Ver
6*	17.849GHz	39.59	8.41	48.00	54.00	-6.00	AV	Ver



Project: LGT22J019	Test Engineer: Dylan.shi
EUT: Smart phone	Humidity: 41%RH
Temperature: 24.3°C	Test Voltage: Power by Battery
M/N: TANK 01	Test Data: 2022-10-26
Test Mode: 802.11b 2437	
Note:	

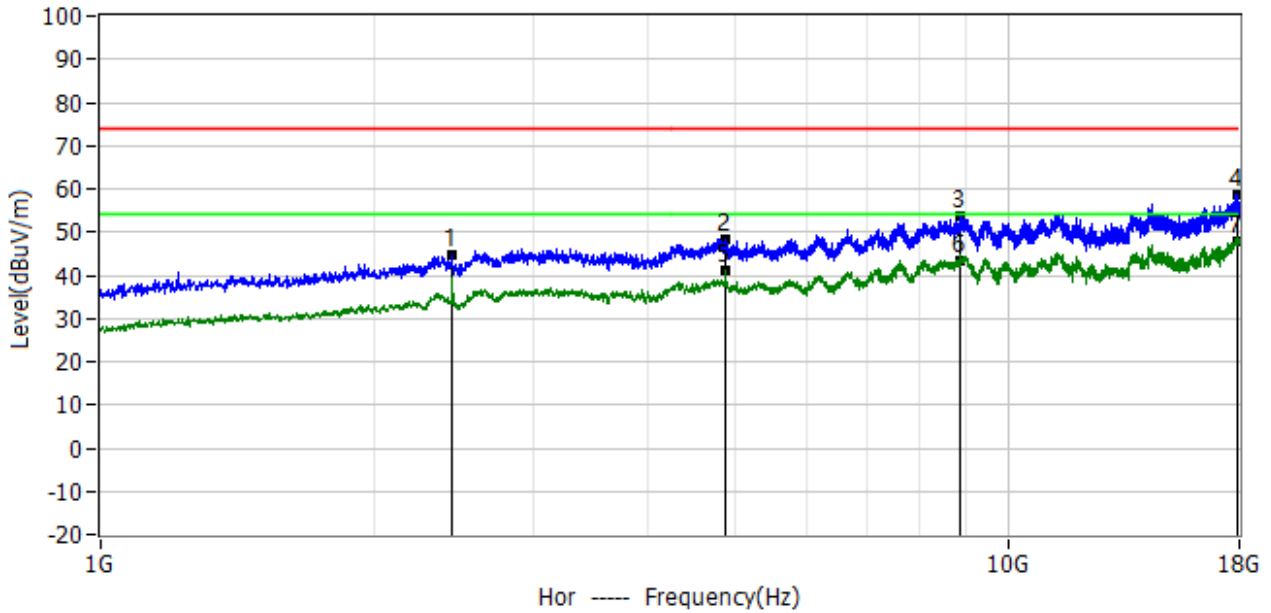

No.	Frequency	Reading dBuV	Factor dB/m	Level dBuV/m	Limit dBuV/m	Margin dB	Detector	Polar
1*	2.439GHz	/	/	/	/	/	PK	Hor
2*	4.874GHz	54.52	-6.04	48.48	74.00	-25.52	PK	Hor
3*	8.863GHz	55.23	-1.56	53.67	74.00	-20.33	PK	Hor
4*	17.941GHz	50.24	8.48	58.72	74.00	-15.28	PK	Hor
5*	4.876GHz	47.25	-6.04	41.21	54.00	-12.79	AV	Hor
6*	8.863GHz	44.96	-1.56	43.40	54.00	-10.60	AV	Hor
7*	17.941GHz	39.32	8.48	47.80	54.00	-6.20	AV	Hor



Project: LGT22J019	Test Engineer: Dylan.shi
EUT: Smart phone	Humidity: 41%RH
Temperature: 24.3°C	Test Voltage: Power by Battery
M/N: TANK 01	Test Data: 2022-10-26
Test Mode: 802.11b 2437	
Note:	

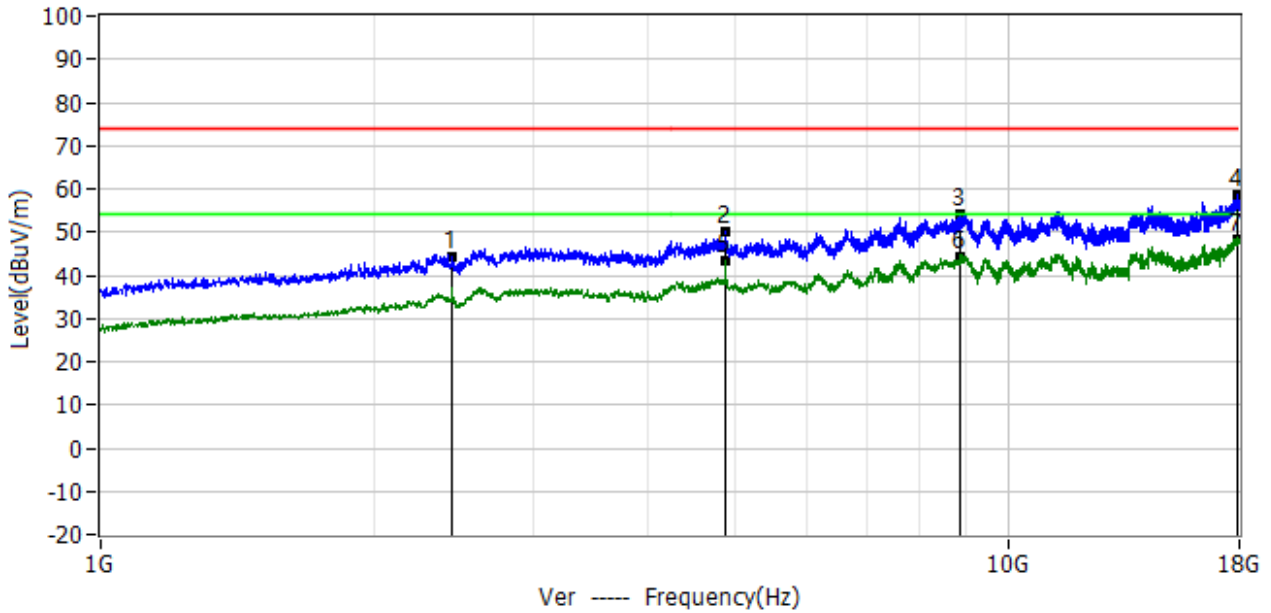

No.	Frequency	Reading dBuV	Factor dB/m	Level dBuV/m	Limit dBuV/m	Margin dB	Detector	Polar
1*	2.439GHz	/	/	/	/	/	PK	Ver
2*	4.874GHz	55.94	-6.04	49.90	74.00	-24.10	PK	Ver
3*	8.871GHz	55.81	-1.54	54.27	74.00	-19.73	PK	Ver
4*	17.896GHz	50.20	8.45	58.65	74.00	-15.35	PK	Ver
5*	4.876GHz	49.46	-6.04	43.42	54.00	-10.58	AV	Ver
6*	8.871GHz	45.64	-1.54	44.10	54.00	-9.90	AV	Ver
7*	17.896GHz	39.65	8.45	48.10	54.00	-5.90	AV	Ver



Project: LGT22J019	Test Engineer: Dylan.shi
EUT: Smart phone	Humidity: 41%RH
Temperature: 24.3°C	Test Voltage: Power by Battery
M/N: TANK 01	Test Data: 2022-10-26
Test Mode: 802.11b 2462	
Note:	

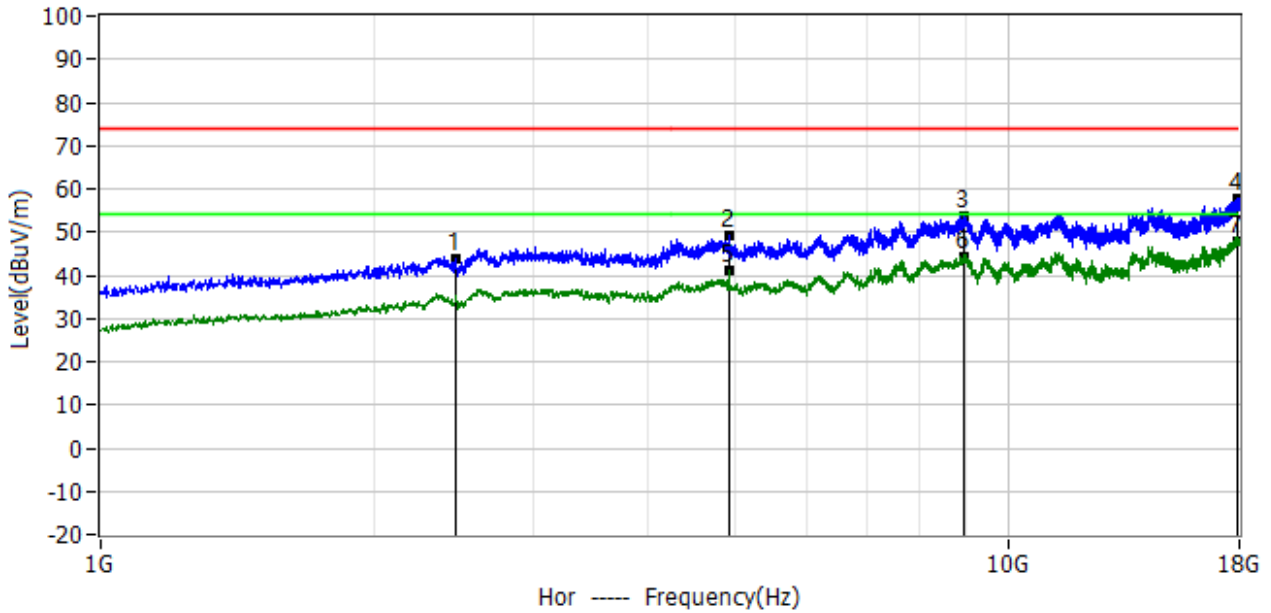

No.	Frequency	Reading dBuV	Factor dB/m	Level dBuV/m	Limit dBuV/m	Margin dB	Detector	Polar
1*	2.458GHz	/	/	/	/	/	PK	Hor
2*	4.925GHz	55.11	-6.08	49.03	74.00	-24.97	PK	Hor
3*	8.928GHz	55.11	-1.37	53.74	74.00	-20.26	PK	Hor
4*	17.913GHz	49.27	8.46	57.73	74.00	-16.27	PK	Hor
5*	4.927GHz	47.32	-6.08	41.24	54.00	-12.76	AV	Hor
6*	8.928GHz	45.77	-1.37	44.40	54.00	-9.60	AV	Hor
7*	17.913GHz	39.54	8.46	48.00	54.00	-6.00	AV	Hor



Project: LGT22J019	Test Engineer: Dylan.shi
EUT: Smart phone	Humidity: 41%RH
Temperature: 24.3°C	Test Voltage: Power by Battery
M/N: TANK 01	Test Data: 2022-10-26
Test Mode: 802.11b 2462	
Note:	

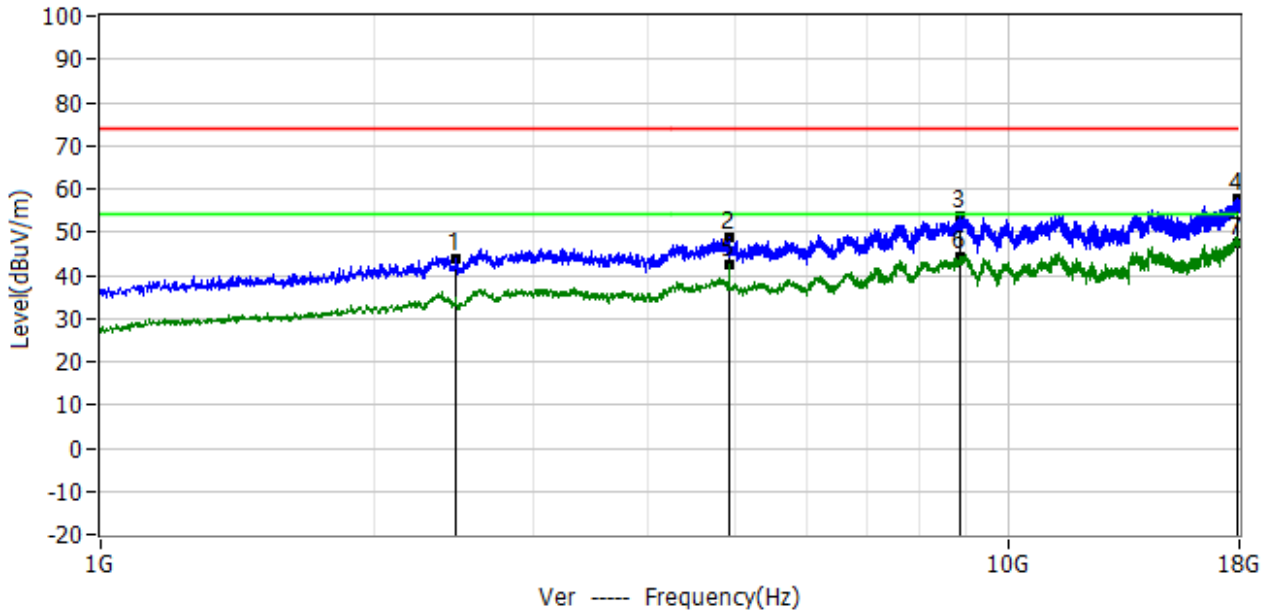

No.	Frequency	Reading dBuV	Factor dB/m	Level dBuV/m	Limit dBuV/m	Margin dB	Detector	Polar
1*	2.466GHz	/	/	/	/	/	PK	Ver
2*	4.923GHz	54.98	-6.08	48.90	74.00	-25.10	PK	Ver
3*	8.875GHz	55.14	-1.52	53.62	74.00	-20.38	PK	Ver
4*	17.887GHz	49.47	8.44	57.91	74.00	-16.09	PK	Ver
5*	4.927GHz	48.35	-6.08	42.27	54.00	-11.73	AV	Ver
6*	8.875GHz	45.72	-1.52	44.20	54.00	-9.80	AV	Ver
7*	17.887GHz	39.06	8.44	47.50	54.00	-6.50	AV	Ver



3.2.8 TEST RESULTS(Band edge Requirements)

Project: LGT22J019	Test Engineer: Dylan.shi
EUT: Smart phone	Humidity: 48%RH
Temperature: 25.5°C	Test Voltage: Power by Battery
M/N: TANK 01	Test Data: 2022-10-27
Test Mode: 802.11b 2412	
Note:	

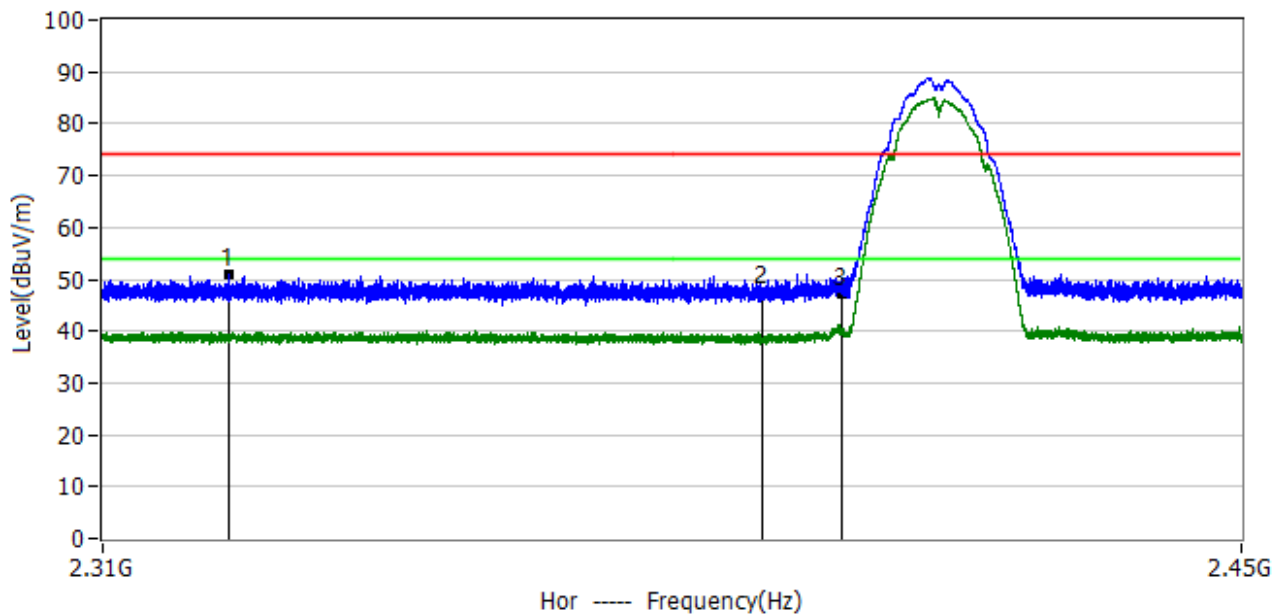

No.	Frequency	Reading dBuV	Factor dB/m	Level dBuV/m	Limit dBuV/m	Margin dB	Detector	Polar
1*	2.3250GHz	16.66	34.11	50.77	74.00	-23.23	PK	Hor
2*	2.3900GHz	13.65	33.95	47.60	74.00	-26.40	PK	Hor
3*	2.4000GHz	13.17	33.93	47.10	74.00	-26.90	PK	Hor



Project: LGT22J019	Test Engineer: Dylan.shi
EUT: Smart phone	Humidity: 48%RH
Temperature: 25.5°C	Test Voltage: Power by Battery
M/N: TANK 01	Test Data: 2022-10-27
Test Mode: 802.11b 2412	
Note:	

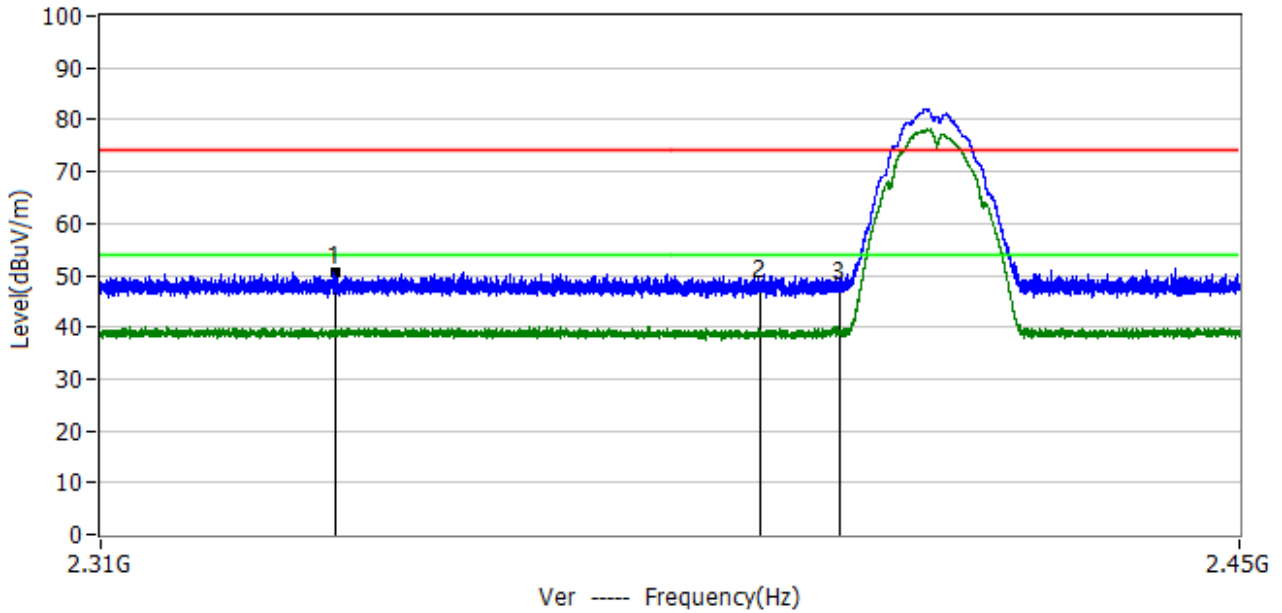

No.	Frequency	Reading dBuV	Factor dB/m	Level dBuV/m	Limit dBuV/m	Margin dB	Detector	Polar
1*	2.3381GHz	16.66	34.08	50.74	74.00	-23.26	PK	Ver
2*	2.3900GHz	13.85	33.95	47.80	74.00	-26.20	PK	Ver
3*	2.4000GHz	13.77	33.93	47.70	74.00	-26.30	PK	Ver



Project: LGT22J019	Test Engineer: Dylan.shi
EUT: Smart phone	Humidity: 48%RH
Temperature: 25.5°C	Test Voltage: Power by Battery
M/N: TANK 01	Test Data: 2022-10-27
Test Mode: 802.11b 2462	
Note:	

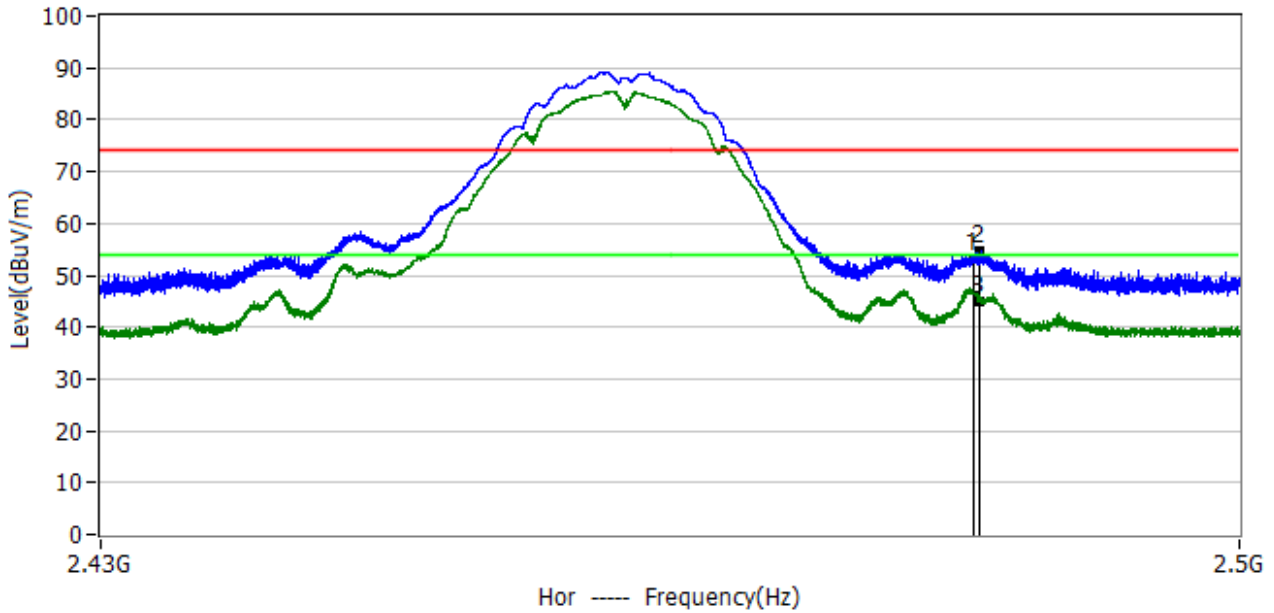

No.	Frequency	Reading dBuV	Factor dB/m	Level dBuV/m	Limit dBuV/m	Margin dB	Detector	Polar
1*	2.4835GHz	19.07	34.13	53.20	74.00	-20.80	PK	Hor
2*	2.4839GHz	20.63	34.13	54.76	74.00	-19.24	PK	Hor
3*	2.4839GHz	10.77	34.13	44.90	54.00	-9.10	AV	Hor



Project: LGT22J019	Test Engineer: Dylan.shi
EUT: Smart phone	Humidity: 48%RH
Temperature: 25.5°C	Test Voltage: Power by Battery
M/N: TANK 01	Test Data: 2022-10-27
Test Mode: 802.11b 2462	
Note:	

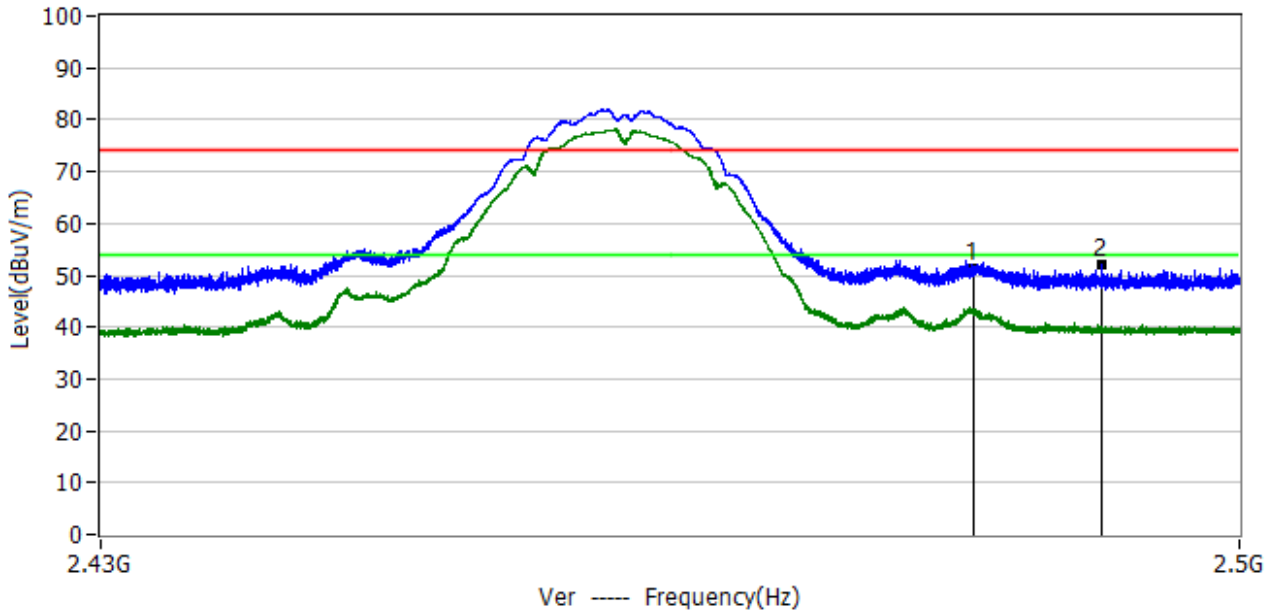

No.	Frequency	Reading dBuV	Factor dB/m	Level dBuV/m	Limit dBuV/m	Margin dB	Detector	Polar
1*	2.4835GHz	17.27	34.13	51.40	74.00	-22.60	PK	Ver
2*	2.4914GHz	17.77	34.14	51.91	74.00	-22.09	PK	Ver



4. CONDUCTED SPURIOUS & BAND EDGE EMISSION

4.1 LIMIT

According to FCC section 15.247(d), in any 100kHz bandwidth outside the frequency band in which the spread spectrum or digitally modulated intentional radiator is operating, the radio frequency power that is produced by the intentional radiator shall be at least 20dB below that in the 100kHz bandwidth within the band that contains the highest level of the desired power, based on either an RF conducted or a radiated measurement.

4.2 TEST PROCEDURE

Spectrum Parameter	Setting
Detector	Peak
Start/Stop Frequency	30 MHz to 10th carrier harmonic
RB / VB (emission in restricted band)	100 KHz/300 KHz
Trace-Mode:	Max hold

For Band edge

Spectrum Parameter	Setting
Detector	Peak
Start/Stop Frequency	Lower Band Edge: 2300 to 2432 MHz Upper Band Edge: 2442 to 2500 MHz
RB / VB (emission in restricted band)	100 KHz/300 KHz
Trace-Mode:	Max hold

4.3 DEVIATION FROM STANDARD

No deviation.

4.4 TEST SETUP



The EUT is connected to the Spectrum Analyzer; the RF load attached to the EUT antenna terminal is 50Ohm; the path loss as the factor is calibrated to correct the reading.

Make the measurement with the spectrum analyzer's resolution bandwidth (RBW) = 100 kHz. In order to make an accurate measurement, set the span greater than RBW.

4.5 EUT OPERATION CONDITIONS

Please refer to section 3.1.4 of this report.

4.6 TEST RESULTS

For the measurement records, refer to the appendix I.



5. POWER SPECTRAL DENSITY TEST

5.1 LIMIT

FCC Part15.247 , Subpart C				
Section	Test Item	Limit	Frequency Range (MHz)	Result
15.247(e)	Power Spectral Density	≤ 8 dBm (RBW ≥ 3 KHz)	2400-2483.5	PASS

5.2 TEST PROCEDURE

1. Set analyzer center frequency to DTS channel center frequency.
2. Set the span to 1.5 times the DTS channel bandwidth.
3. Set the $100 \text{ kHz} \geq \text{RBW} \geq 3 \text{ kHz}$.
4. Set the $\text{VBW} \geq 3 \times \text{RBW}$.
5. Detector = peak.
6. Sweep time = auto couple.
7. Trace mode = max hold.
8. Allow trace to fully stabilize.
9. Use the peak marker function to determine the maximum amplitude level.
10. If measured value exceeds limit, reduce RBW (no less than 3 kHz) and repeat.

5.3 DEVIATION FROM STANDARD

No deviation.

5.4 TEST SETUP



5.5 EUT OPERATION CONDITIONS

Please refer to section 3.1.4 of this report.

5.6 TEST RESULTS

For the measurement records, refer to the appendix I.



6. BANDWIDTH TEST

6.1 LIMIT

FCC Part15.247,Subpart C				
Section	Test Item	Limit	Frequency Range (MHz)	Result
15.247(a)(2)	Bandwidth	$\geq 500\text{KHz}$ (6dB bandwidth)	2400-2483.5	PASS

6.2 TEST PROCEDURE

The automatic bandwidth measurement capability of an instrument may be employed using the X dB bandwidth mode with X set to 6 dB, if the functionality described above (i.e., RBW = 100 kHz, VBW \geq 3RBW, peak detector with maximum hold) is implemented by the instrumentation function. When using this capability, care shall be taken so that the bandwidth measurement is not influenced by any intermediate power nulls in the fundamental emission that might be ≥ 6 dB.

6.3 DEVIATION FROM STANDARD

No deviation.

6.4 TEST SETUP

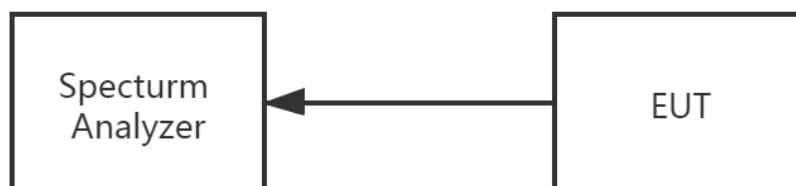

6.5 EUT OPERATION CONDITIONS

Please refer to section 3.1.4 of this report.

6.6 TEST RESULTS

For the measurement records, refer to the appendix I.



7. PEAK OUTPUT POWER TEST

7.1 LIMIT

FCC Part15.247,Subpart C				
Section	Test Item	Limit	Frequency Range (MHz)	Result
15.247(b)(3)	Output Power	1 watt or 30dBm	2400-2483.5	PASS

7.2 TEST PROCEDURE

One of the following procedures may be used to determine the maximum peak conducted output power of a DTS EUT.

RBW \geq DTS bandwidth

The following procedure shall be used when an instrument with a resolution bandwidth that is greater than the DTS bandwidth is available to perform the measurement:

- Set the RBW \geq DTS bandwidth.
- Set VBW \geq [3 \times RBW].
- Set span \geq [3 \times RBW].
- Sweep time = auto couple.
- Detector = peak.
- Trace mode = max hold.
- Allow trace to fully stabilize.
- Use peak marker function to determine the peak amplitude level.

Integrated band power method:

The following procedure can be used when the maximum available RBW of the instrument is less than the

DTS bandwidth:

- Set the RBW = 1 MHz.
- Set the VBW \geq [3 \times RBW].
- Set the span \geq [1.5 \times DTS bandwidth].
- Detector = peak.
- Sweep time = auto couple.
- Trace mode = max hold.
- Allow trace to fully stabilize.
- Use the instrument's band/channel power measurement function with the band limits set equal to the DTS bandwidth edges (for some instruments, this may require a manual override to select the peak detector). If the instrument does not have a band power function, then sum the spectrum levels (in linear power units) at intervals equal to the RBW extending across the DTS channel bandwidth.

PKPM1 Peak power meter method:

The maximum peak conducted output power may be measured using a broadband peak RF power meter. The power meter shall have a video bandwidth that is greater than or equal to the DTS bandwidth and shall use a fast-responding diode detector.

7.3 DEVIATION FROM STANDARD

No deviation.

7.4 TEST SETUP

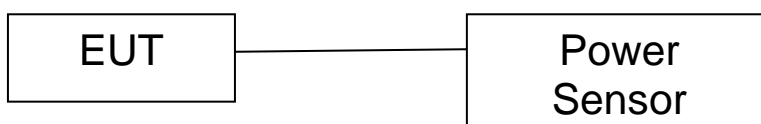

7.5 EUT OPERATION CONDITIONS

Please refer to section 3.1.4 of this report.

7.6 TEST RESULTS

For the measurement records, refer to the appendix I.



8. ANTENNA REQUIREMENT

8.1 STANDARD REQUIREMENT

15.203 requirement: For intentional device, according to 15.203: an intentional radiator shall be designed to ensure that no antenna other than that furnished by the responsible party shall be used with the device.

8.2 EUT ANTENNA

The EUT antenna is PIFA Antenna. It comply with the standard requirement.



APPENDIX I: TEST RESULTS

DUTY CYCLE

Condition	Mode	Frequency (MHz)	Antenna	Duty Cycle (%)	Correction Factor (dB)	1/T (kHz)
NVNT	b	2412	Ant1	99.67	0	0.12
NVNT	b	2437	Ant1	99.67	0	0.12
NVNT	b	2462	Ant1	99.67	0	0.12
NVNT	g	2412	Ant1	97.48	0.11	0.72
NVNT	g	2437	Ant1	97.48	0.11	0.72
NVNT	g	2462	Ant1	97.48	0.11	0.72
NVNT	n20	2412	Ant1	97.31	0.12	0.77
NVNT	n20	2437	Ant1	97.31	0.12	0.77
NVNT	n20	2462	Ant1	97.31	0.12	0.77
NVNT	n40	2422	Ant1	95.02	0.22	1.54
NVNT	n40	2437	Ant1	95.02	0.22	1.54
NVNT	n40	2452	Ant1	95.02	0.22	1.54



Test Graphs

Duty Cycle NVNT b 2412MHz Ant1

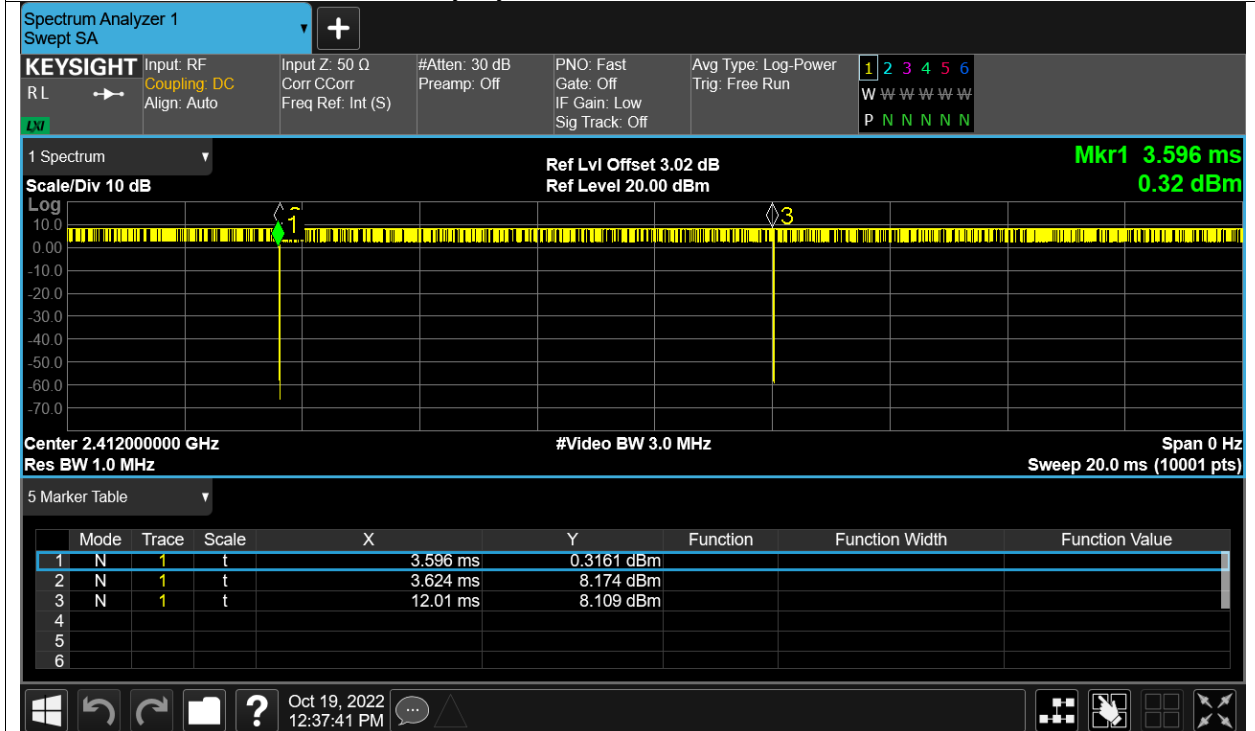

Duty Cycle NVNT b 2437MHz Ant1

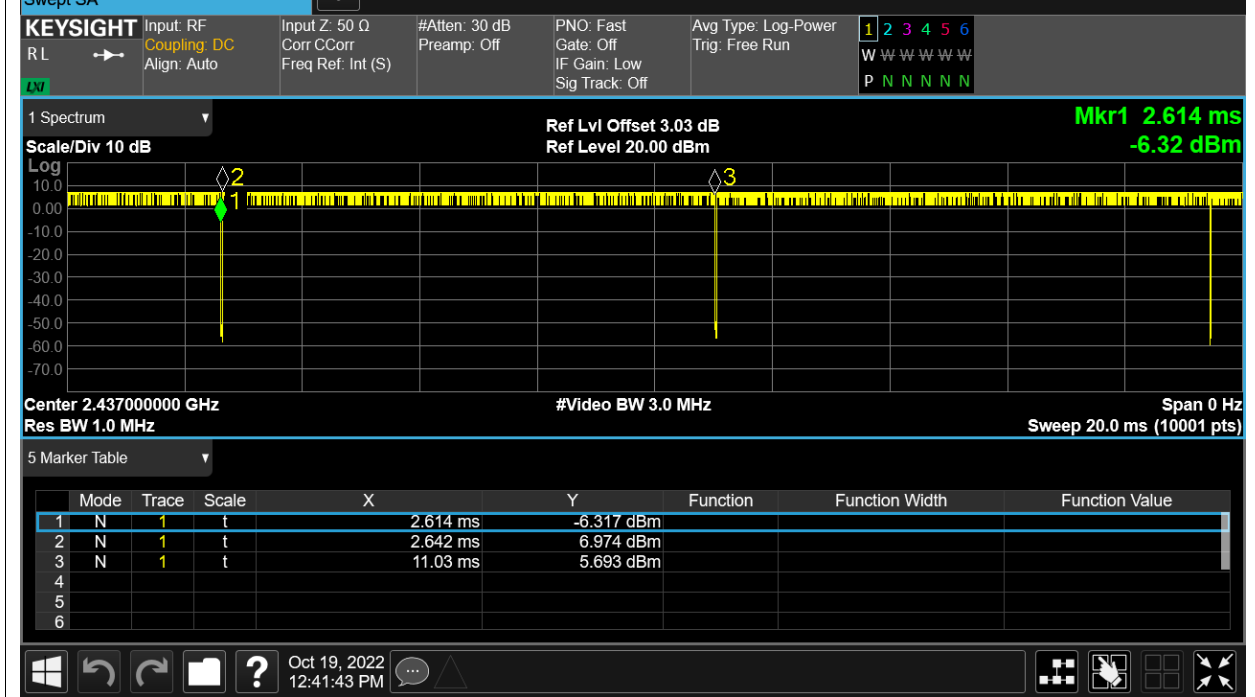



Duty Cycle NVNT b 2462MHz Ant1

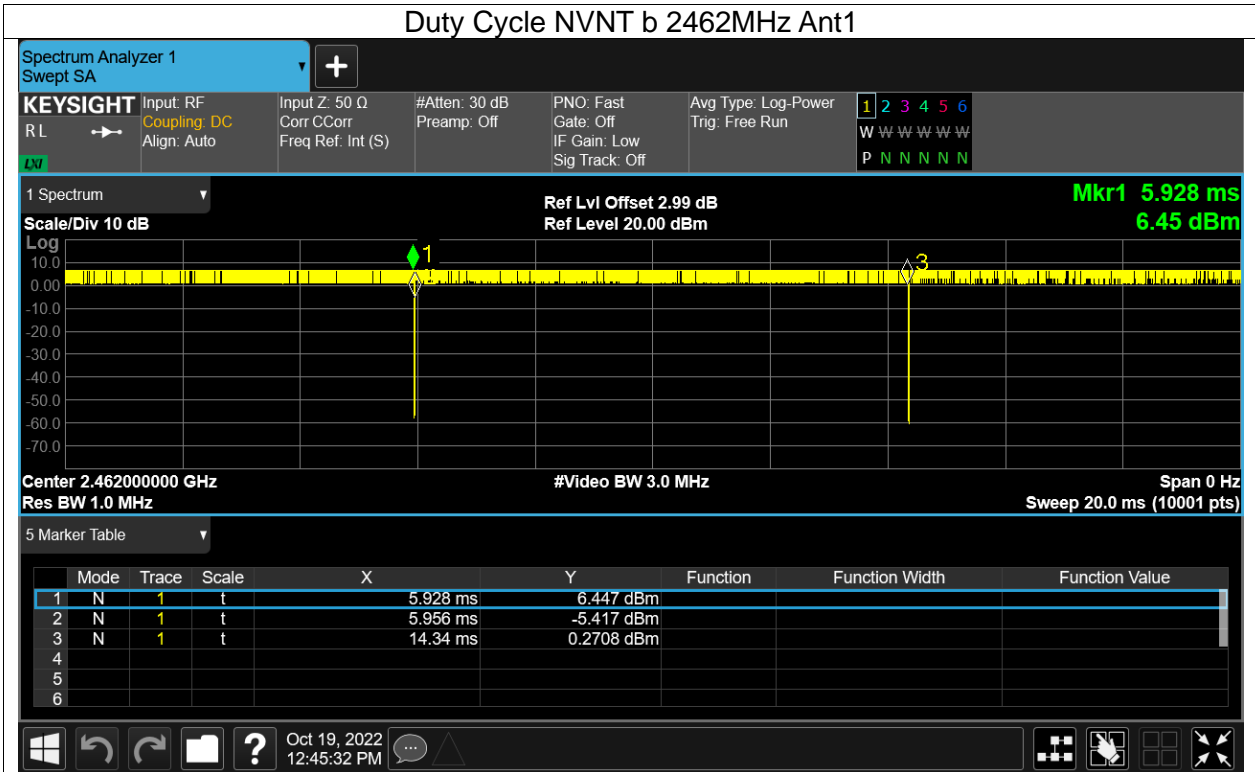

Duty Cycle NVNT g 2412MHz Ant1

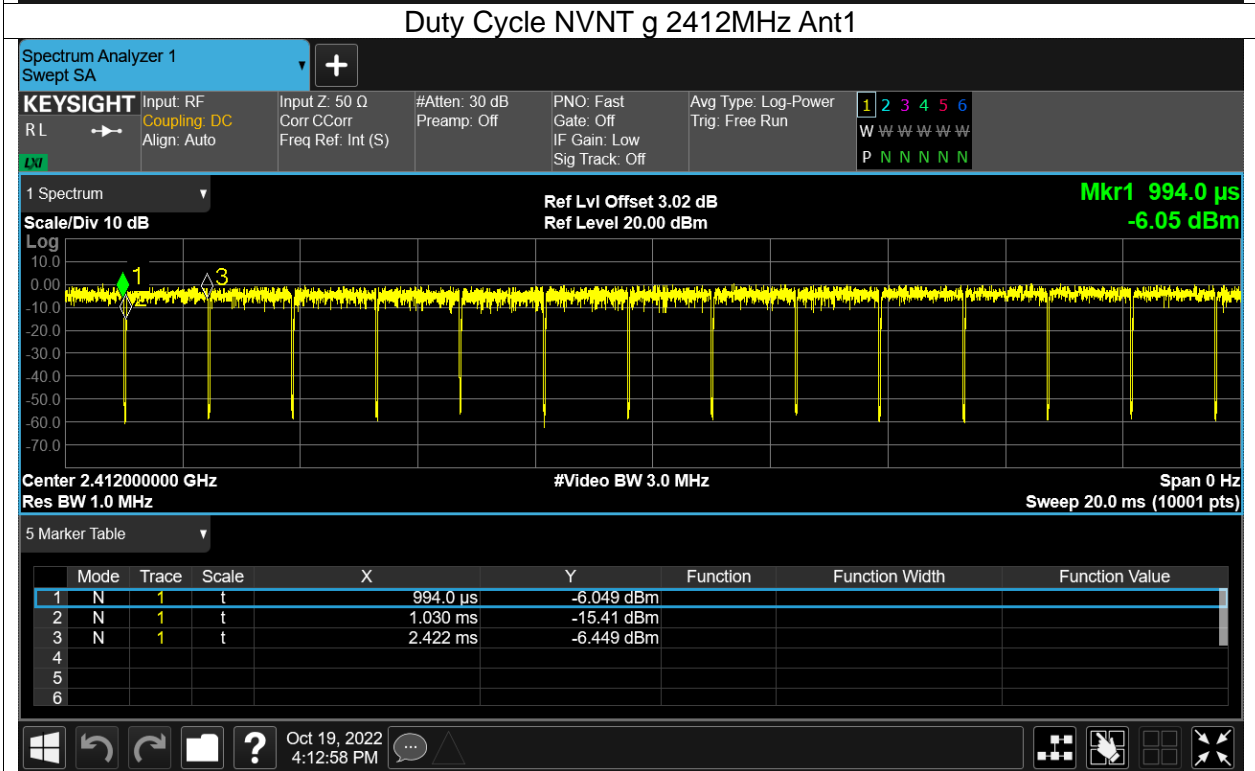



Duty Cycle NVNT g 2437MHz Ant1

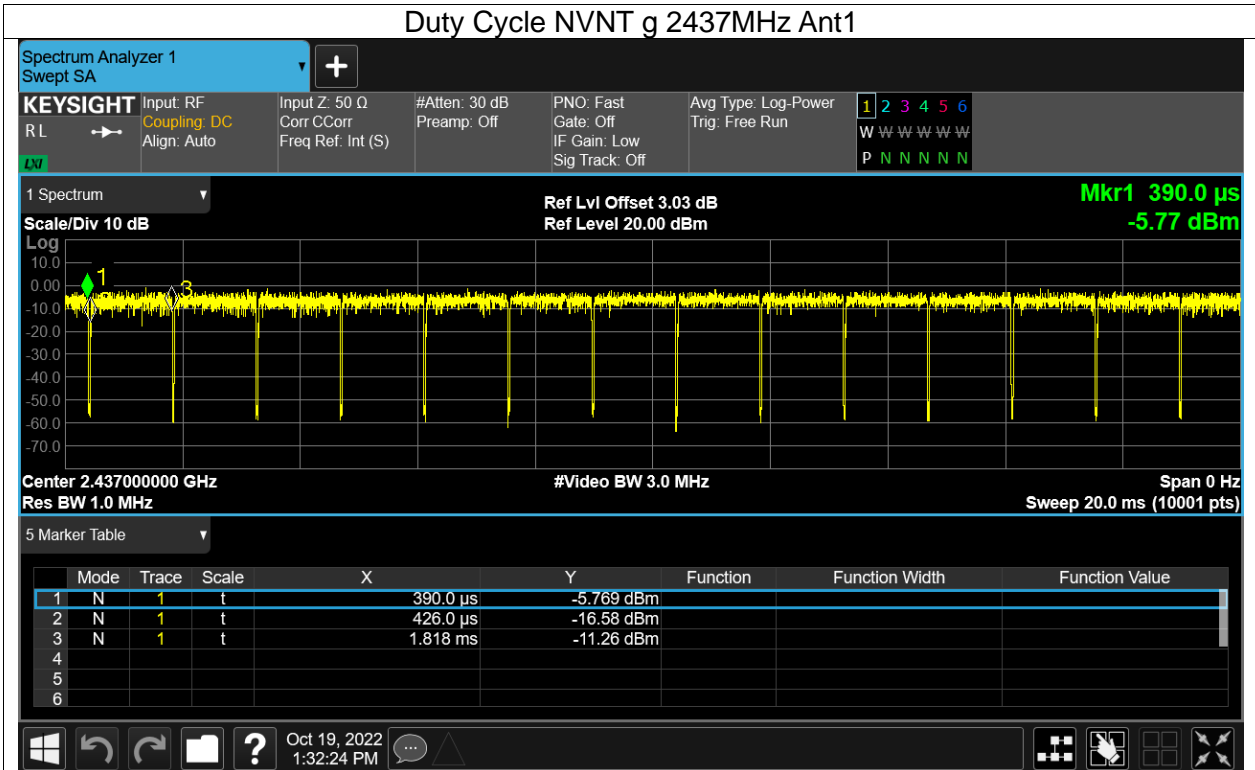

Duty Cycle NVNT g 2462MHz Ant1

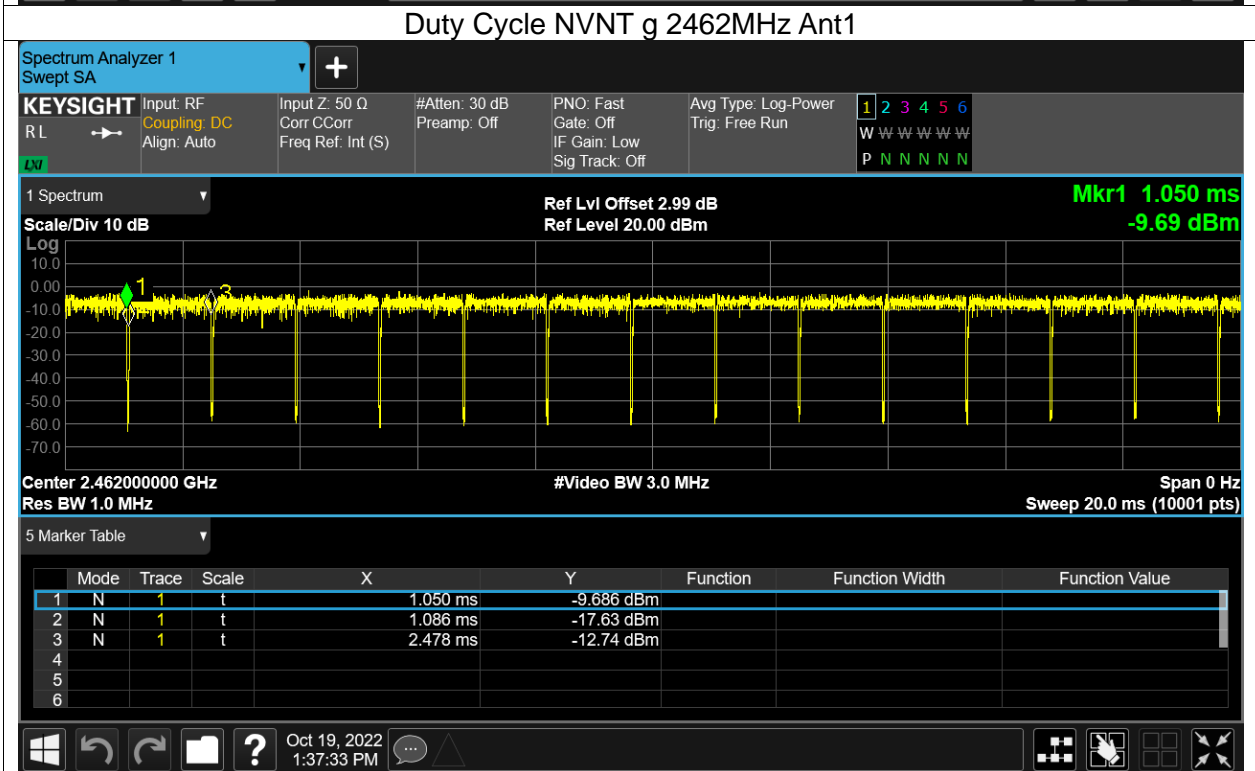



Duty Cycle NVNT n20 2412MHz Ant1

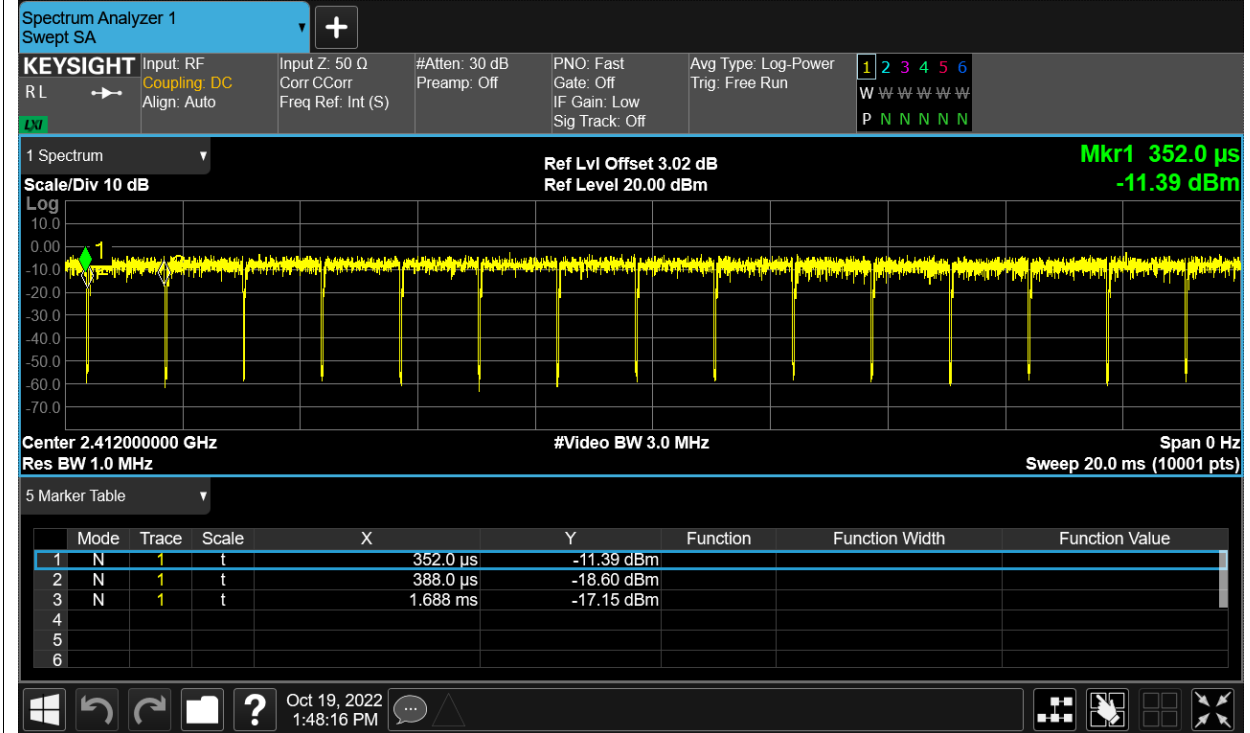

Duty Cycle NVNT n20 2437MHz Ant1

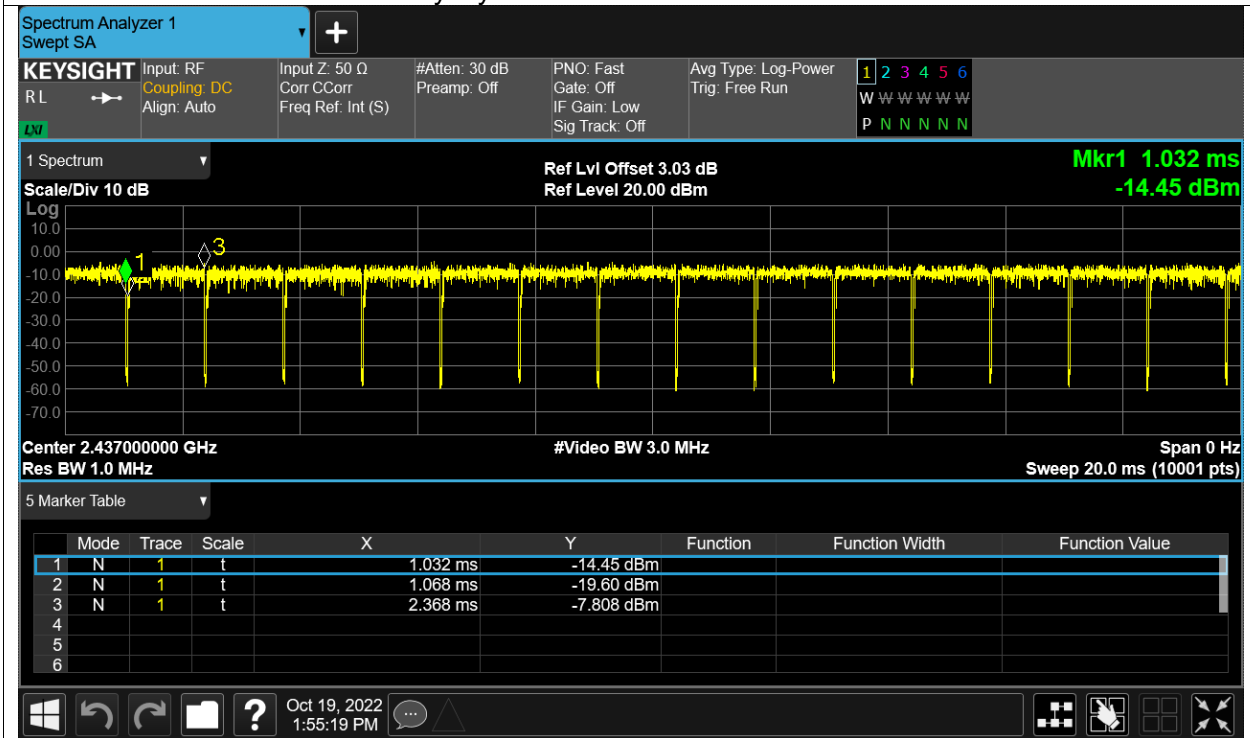



Duty Cycle NVNT n20 2462MHz Ant1

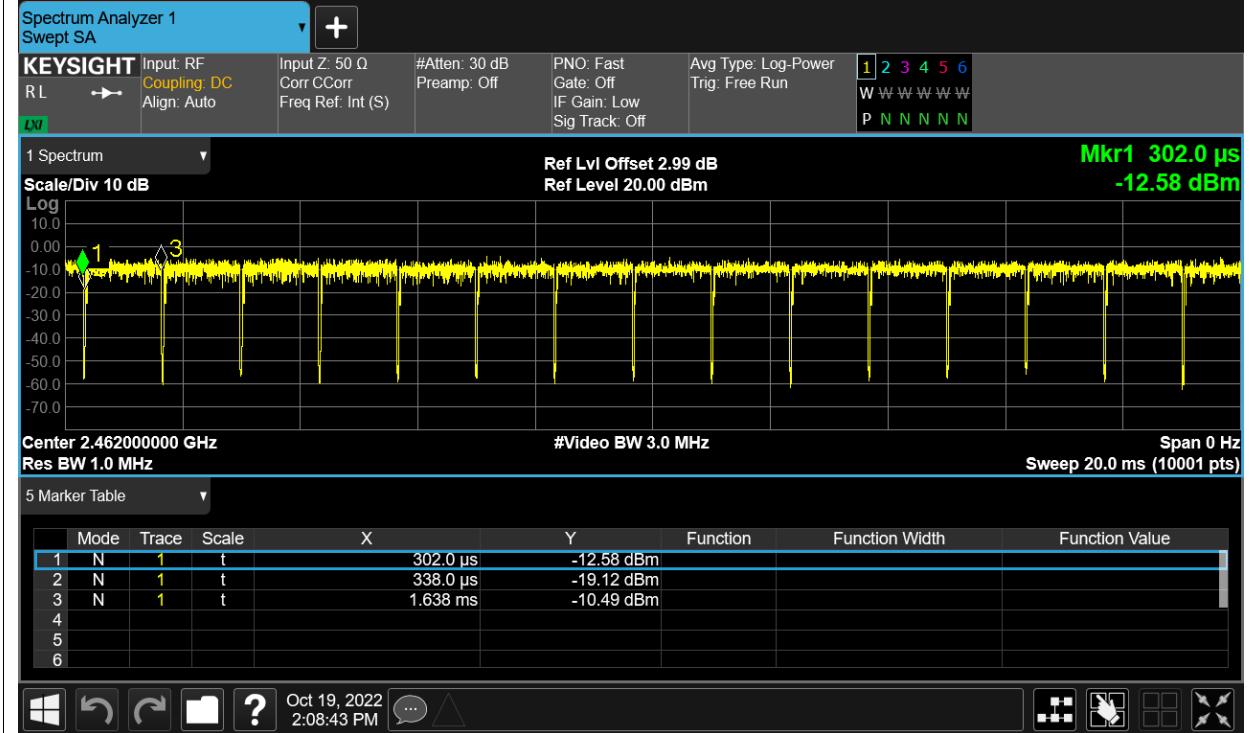

Duty Cycle NVNT n40 2422MHz Ant1





Duty Cycle NVNT n40 2437MHz Ant1

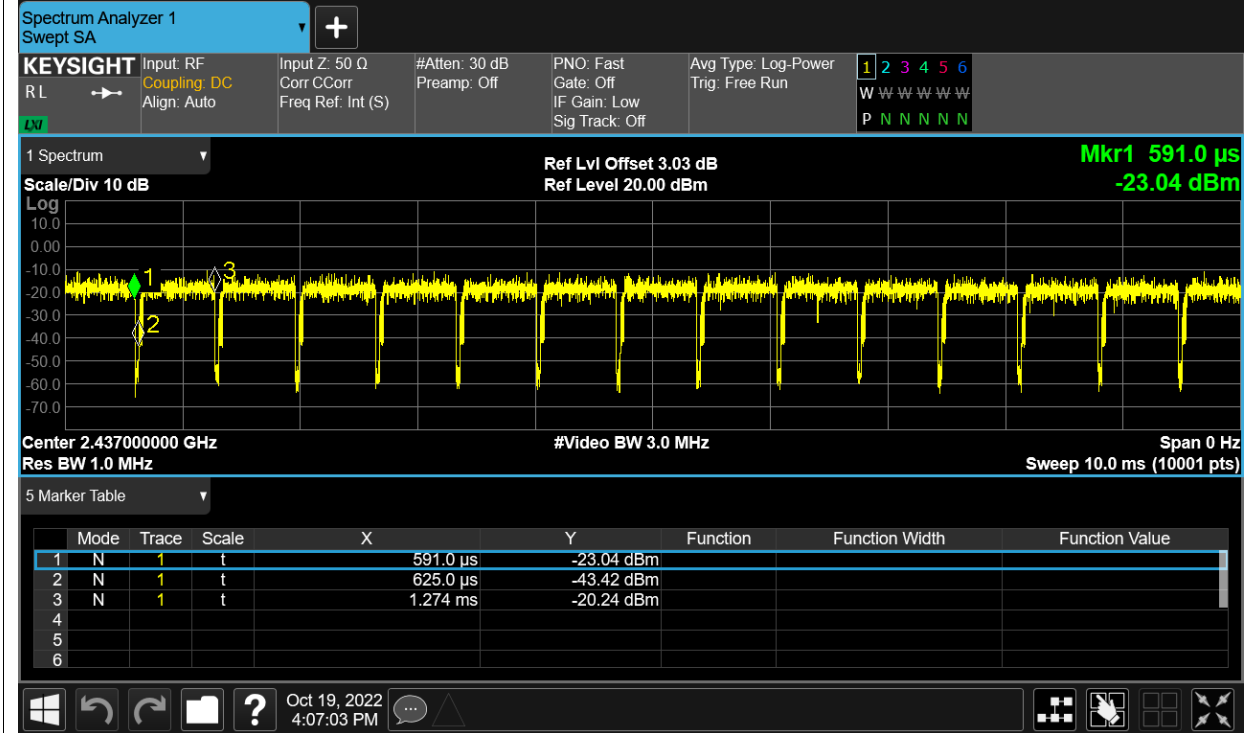

Duty Cycle NVNT n40 2452MHz Ant1





MAXIMUM PEAK CONDUCTED OUTPUT POWER

Condition	Mode	Frequency (MHz)	Antenna	Conducted Power (dBm)	Limit (dBm)	Verdict
NVNT	b	2412	Ant1	14.91	30	Pass
NVNT	b	2437	Ant1	13.9	30	Pass
NVNT	b	2462	Ant1	13.39	30	Pass
NVNT	g	2412	Ant1	8.3	30	Pass
NVNT	g	2437	Ant1	7.15	30	Pass
NVNT	g	2462	Ant1	6.66	30	Pass
NVNT	n20	2412	Ant1	5.42	30	Pass
NVNT	n20	2437	Ant1	4.48	30	Pass
NVNT	n20	2462	Ant1	4.14	30	Pass
NVNT	n40	2422	Ant1	5.28	30	Pass
NVNT	n40	2437	Ant1	4.66	30	Pass
NVNT	n40	2452	Ant1	4.88	30	Pass



-6DB BANDWIDTH

Condition	Mode	Frequency (MHz)	Antenna	-6 dB Bandwidth (MHz)	Limit -6 dB Bandwidth (MHz)	Verdict
NVNT	b	2412	Ant1	8.47	0.5	Pass
NVNT	b	2437	Ant1	7.551	0.5	Pass
NVNT	b	2462	Ant1	8.028	0.5	Pass
NVNT	g	2412	Ant1	14.659	0.5	Pass
NVNT	g	2437	Ant1	12.063	0.5	Pass
NVNT	g	2462	Ant1	10.67	0.5	Pass
NVNT	n20	2412	Ant1	15.011	0.5	Pass
NVNT	n20	2437	Ant1	15.111	0.5	Pass
NVNT	n20	2462	Ant1	12.609	0.5	Pass
NVNT	n40	2422	Ant1	36.322	0.5	Pass
NVNT	n40	2437	Ant1	11.349	0.5	Pass
NVNT	n40	2452	Ant1	13.799	0.5	Pass



Test Graphs

-6dB Bandwidth NVNT b 2412MHz Ant1

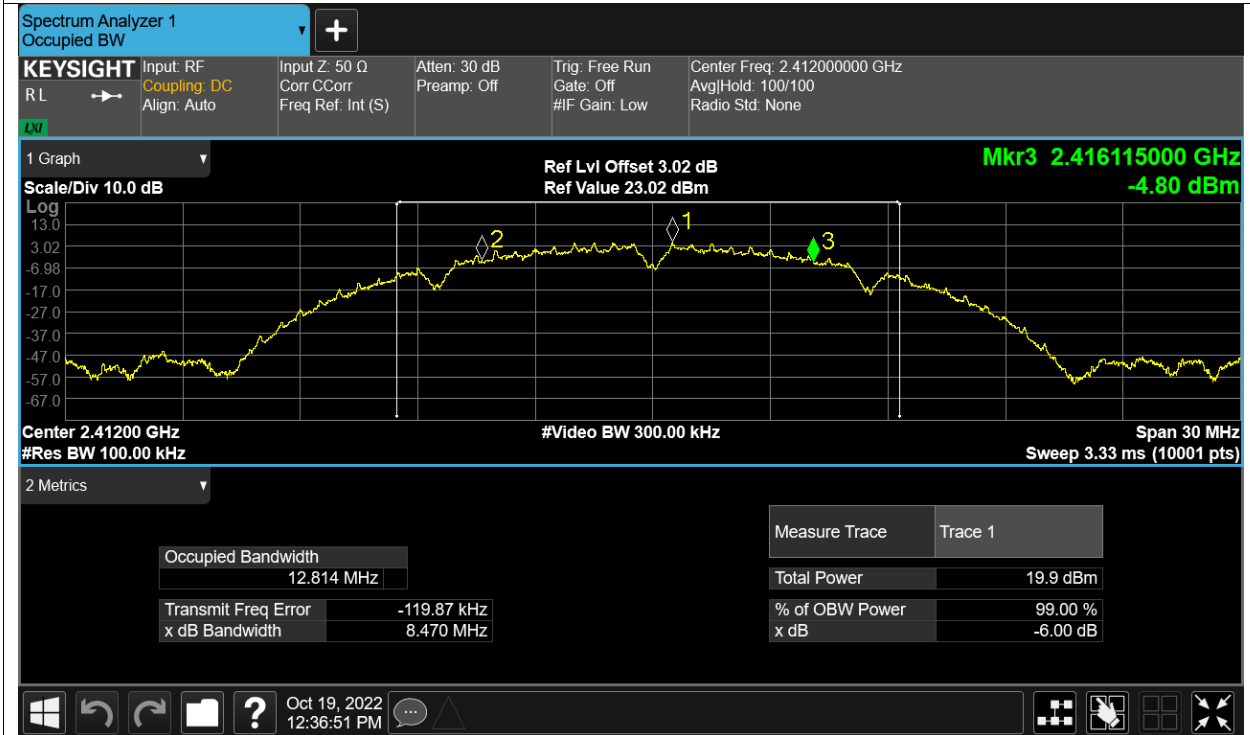

-6dB Bandwidth NVNT b 2437MHz Ant1

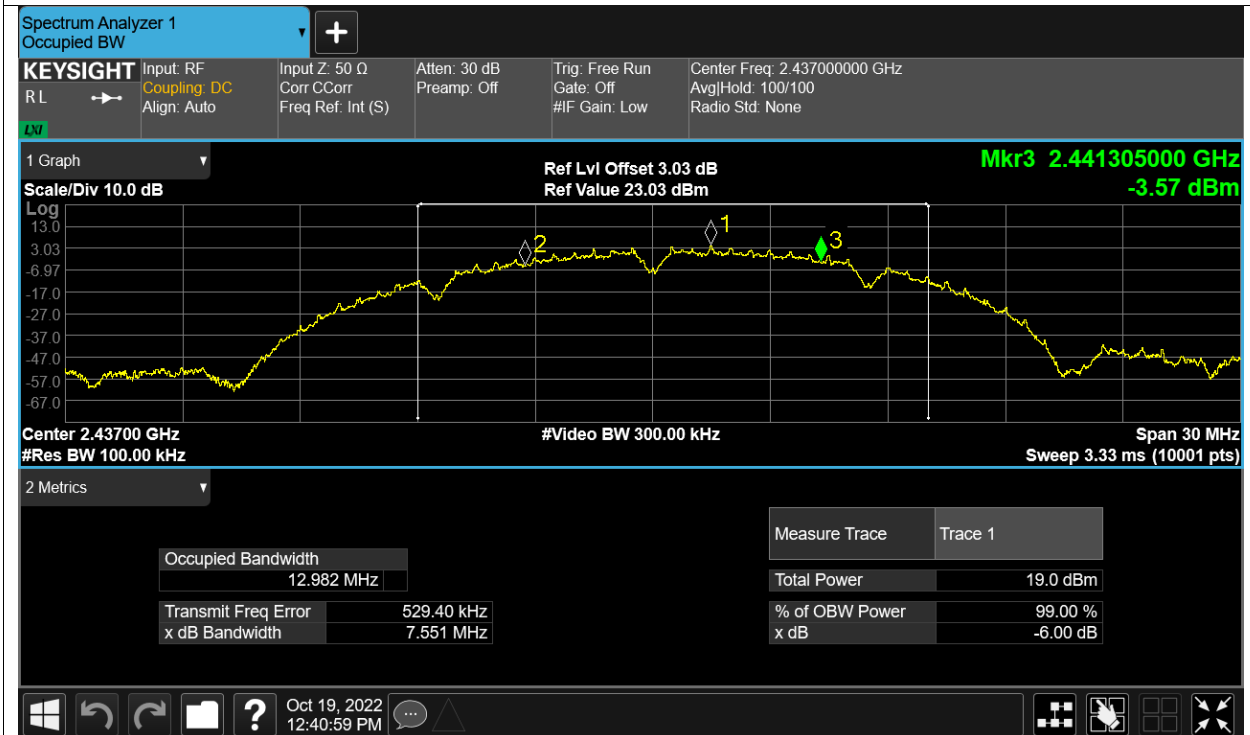



-6dB Bandwidth NVNT b 2462MHz Ant1

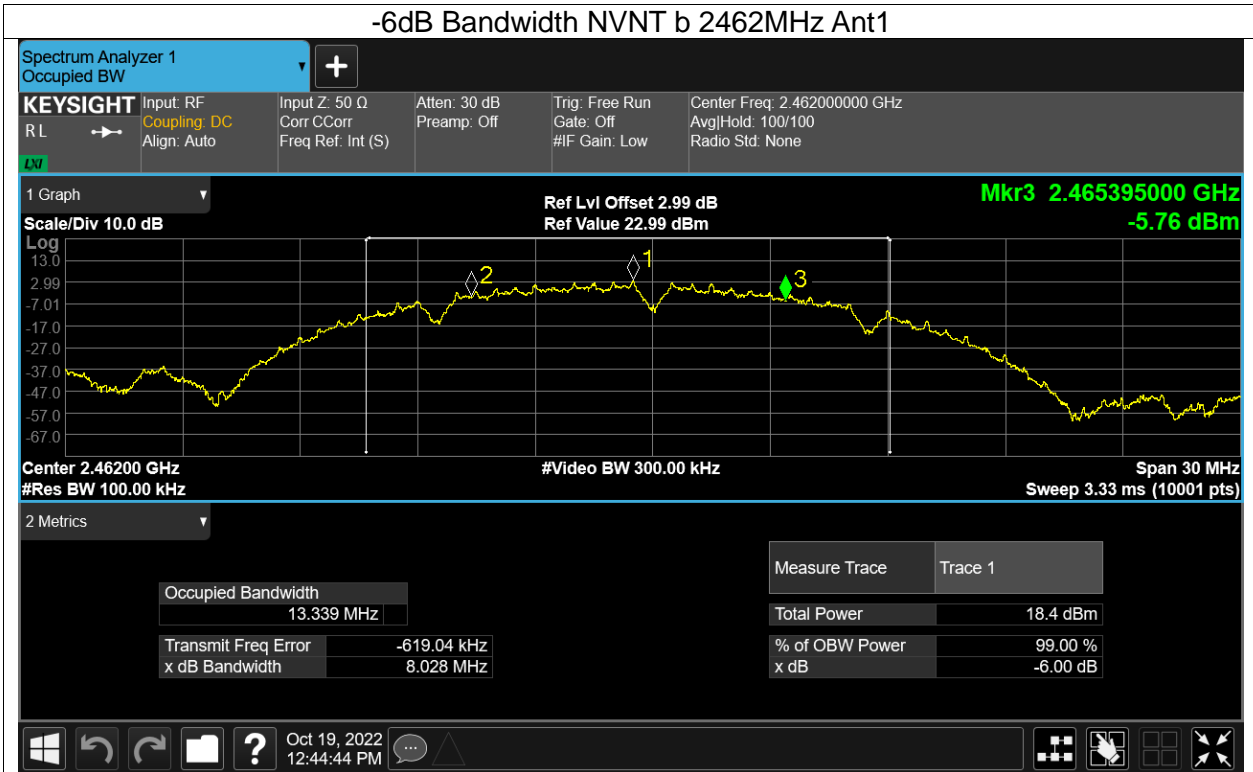

-6dB Bandwidth NVNT g 2412MHz Ant1

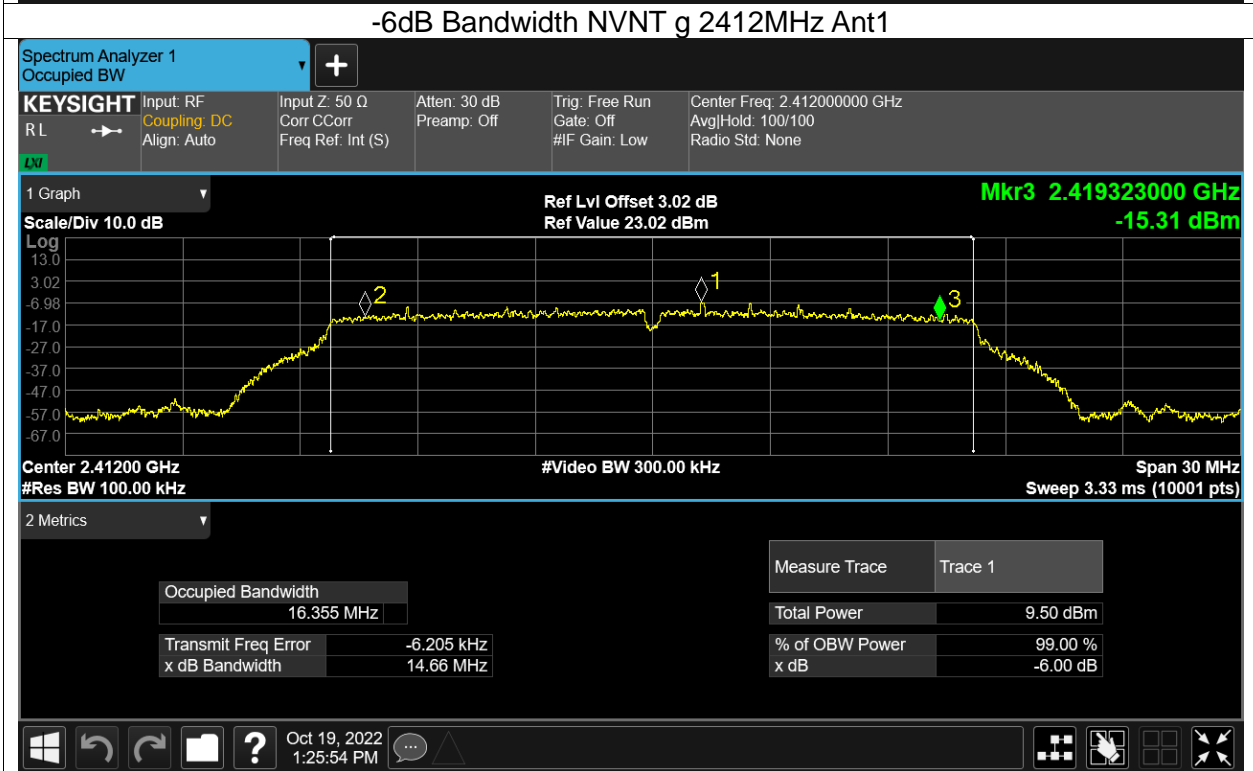



-6dB Bandwidth NVNT g 2437MHz Ant1

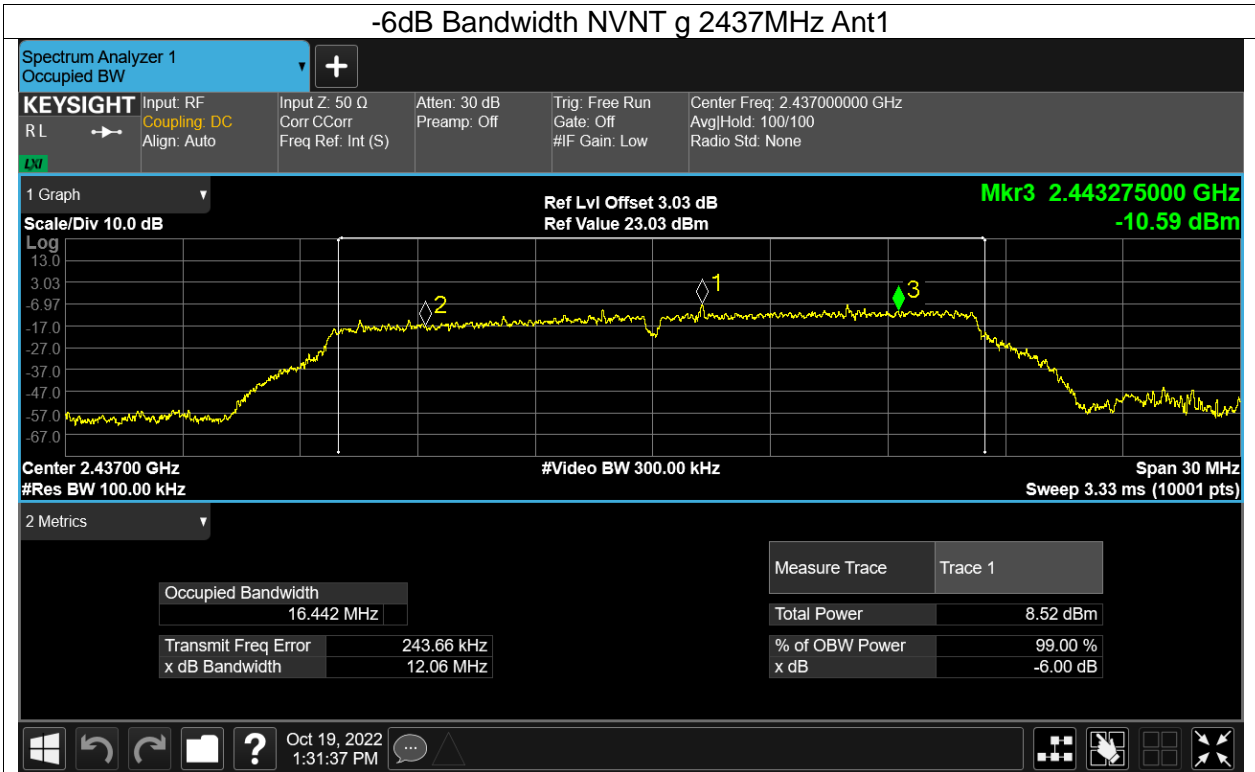

-6dB Bandwidth NVNT g 2462MHz Ant1

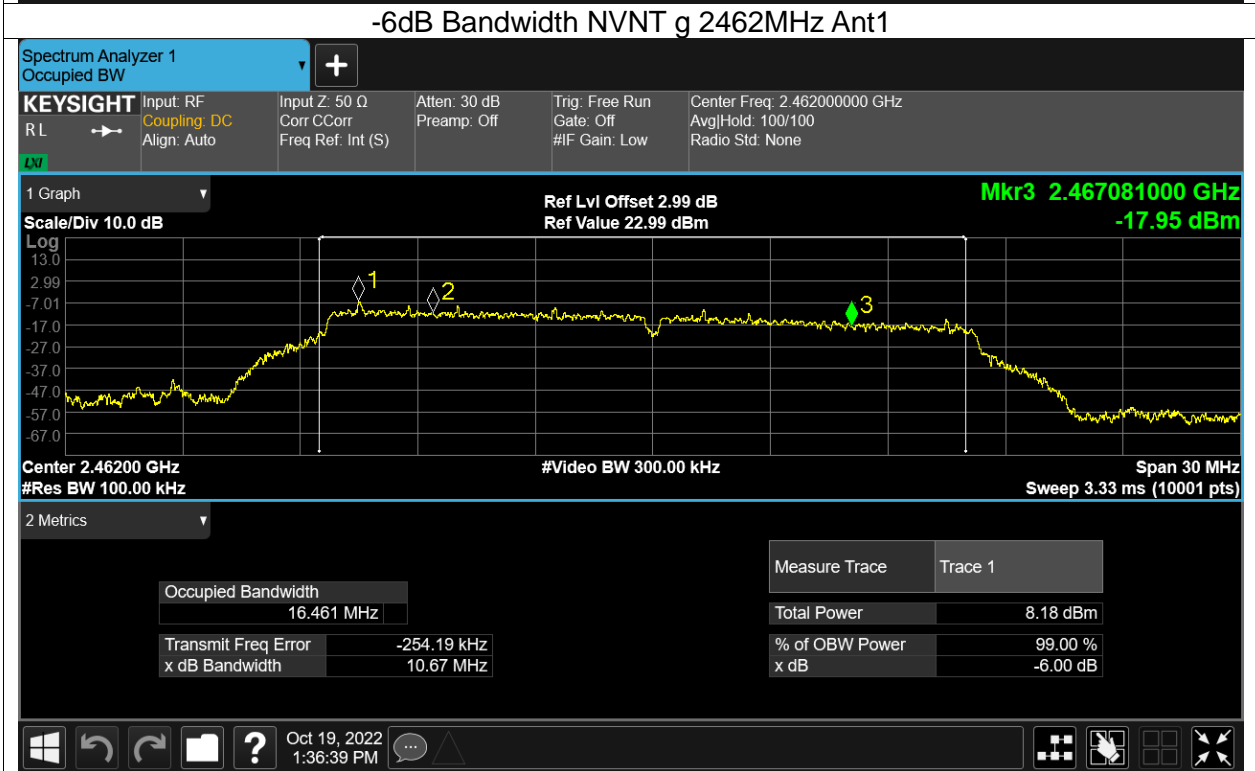

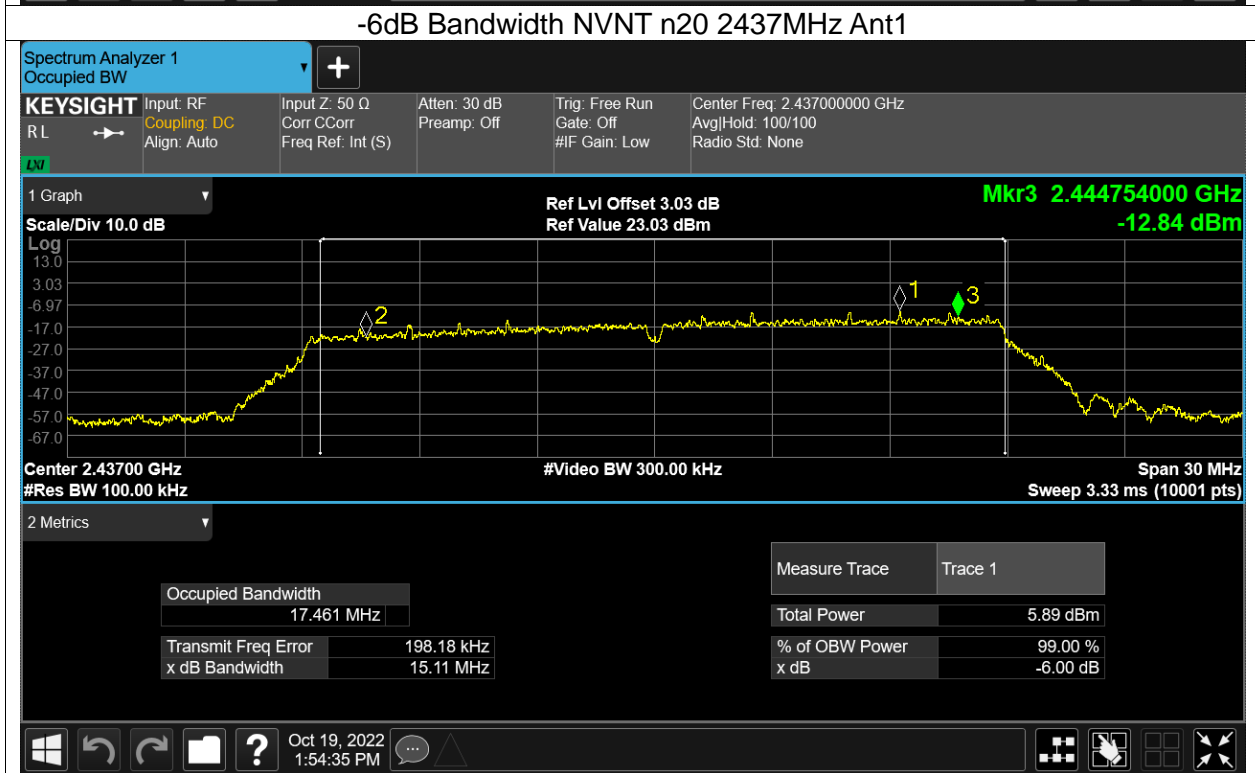
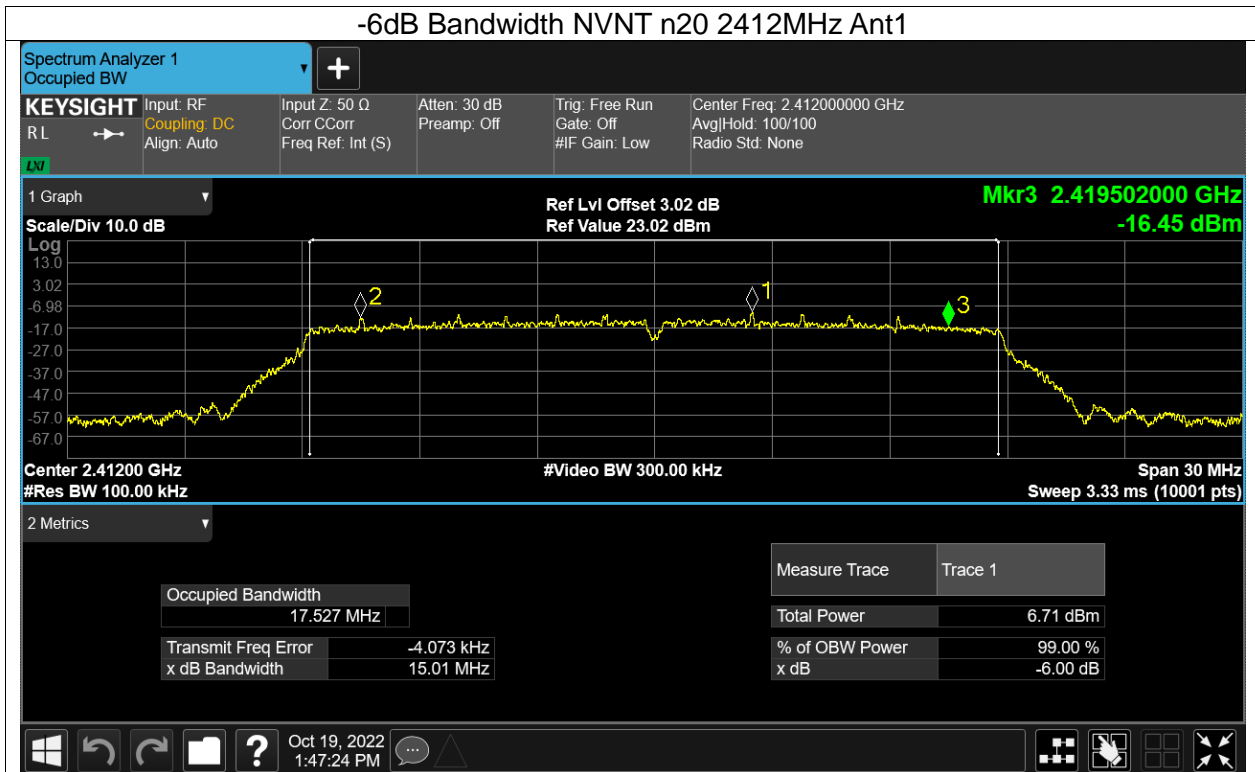

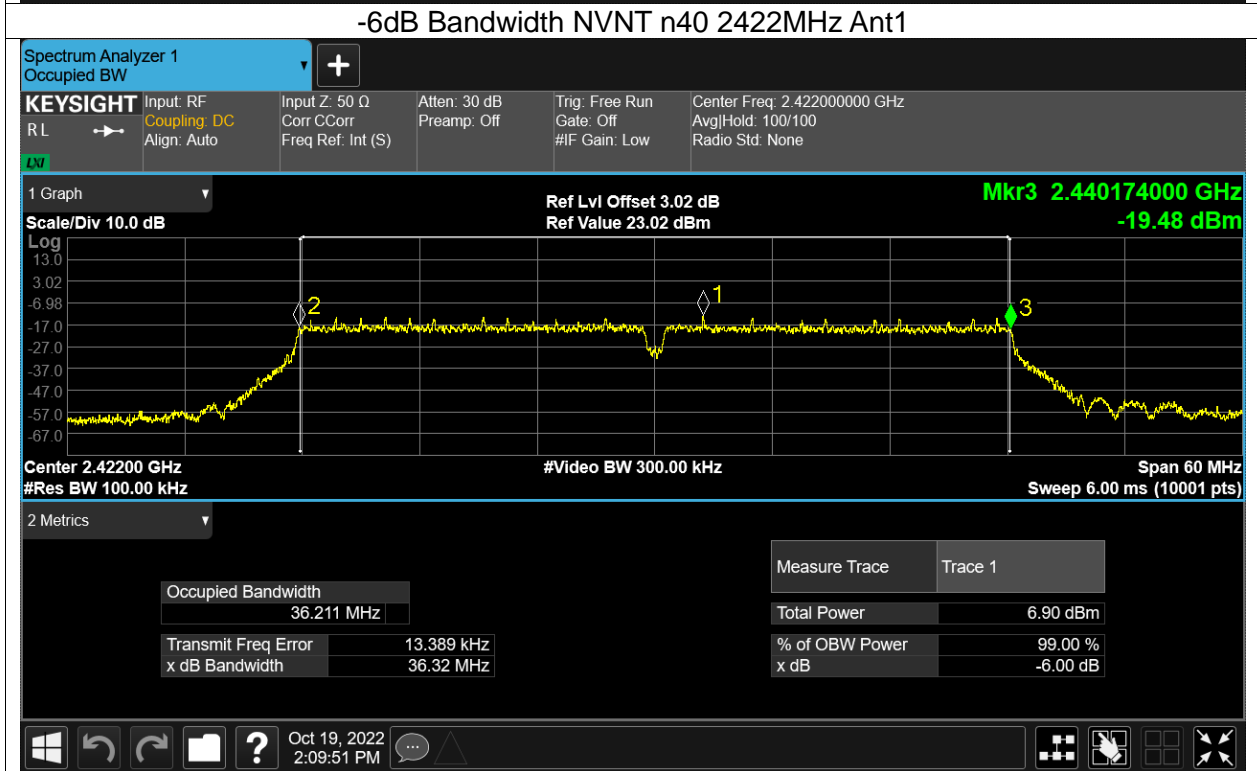
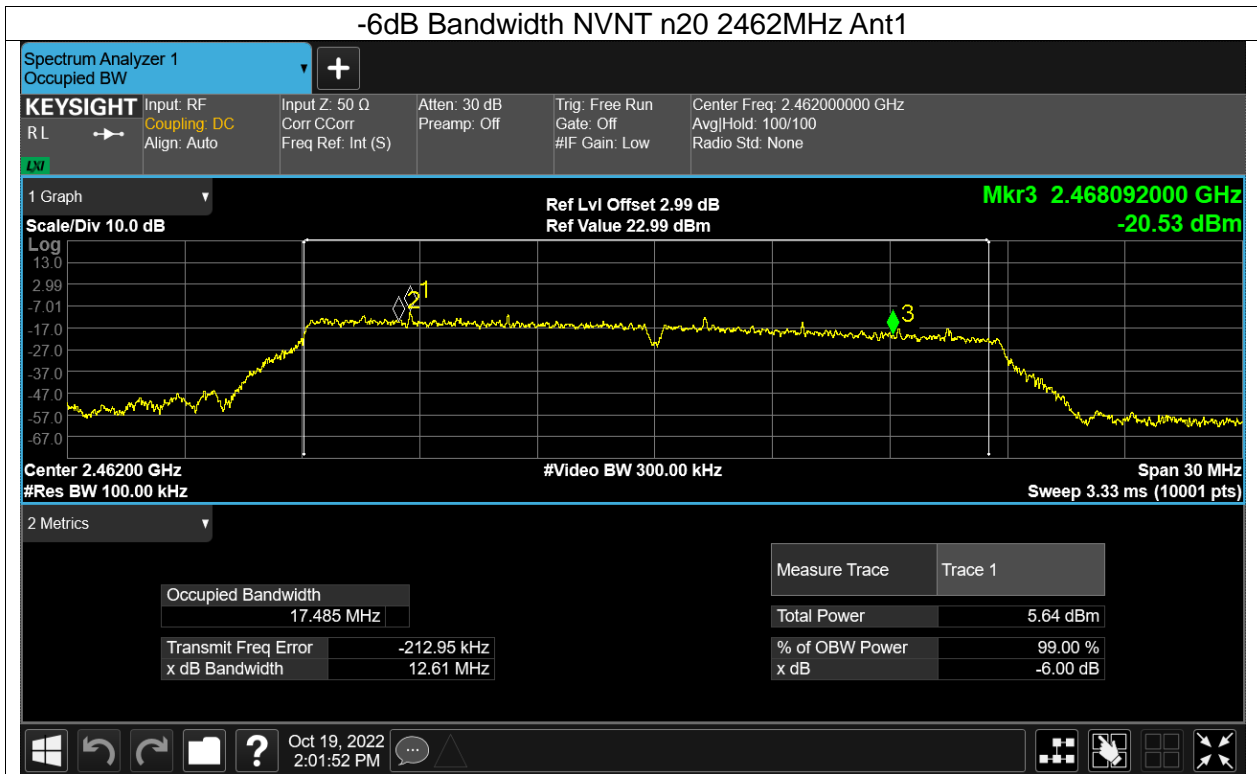



-6dB Bandwidth NVNT n40 2437MHz Ant1

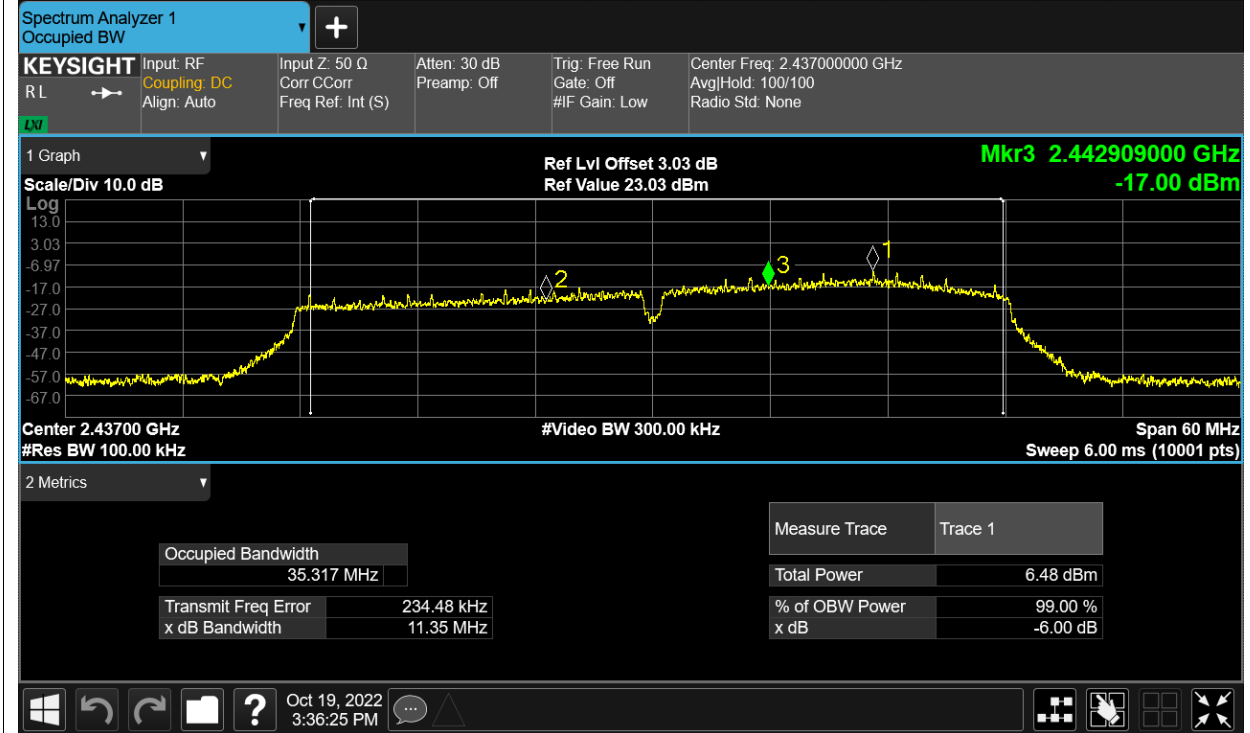

-6dB Bandwidth NVNT n40 2452MHz Ant1

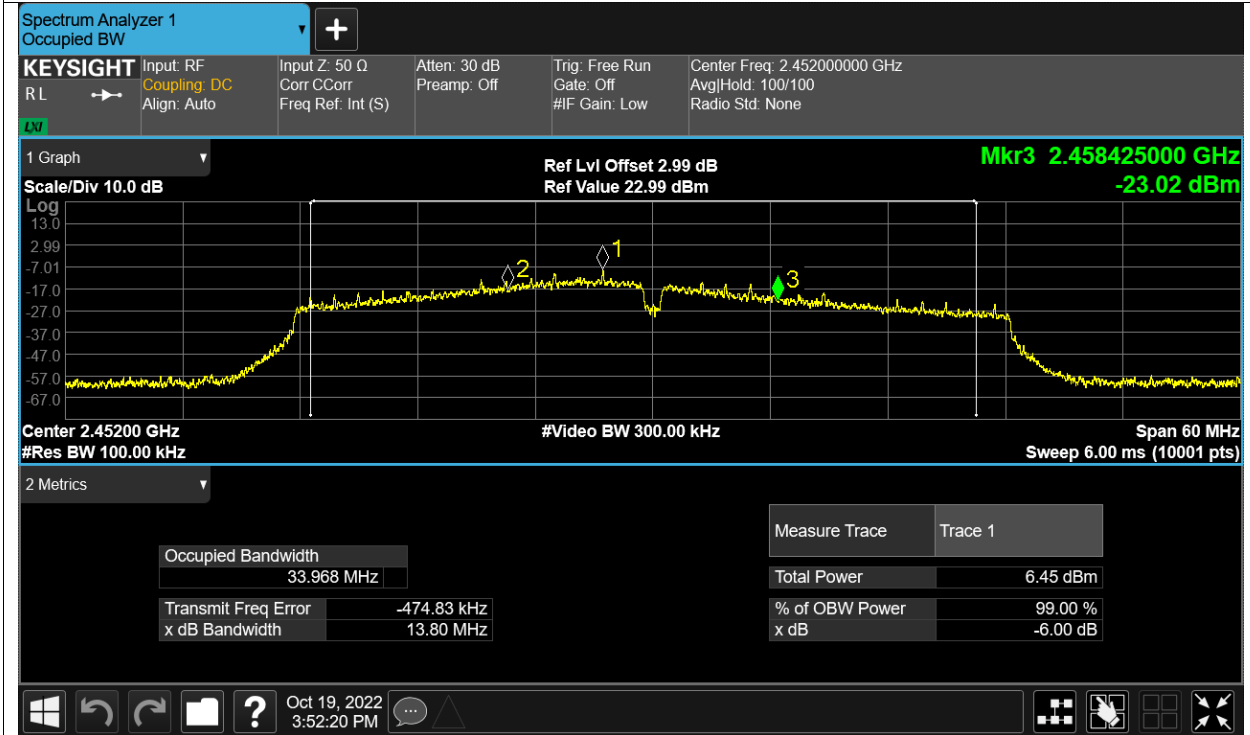



MAXIMUM POWER SPECTRAL DENSITY LEVEL

Condition	Mode	Frequency (MHz)	Antenna	Conducted PSD (dBm/3kHz)	Limit (dBm/3kHz)	Verdict
NVNT	b	2412	Ant1	-8.05	8	Pass
NVNT	b	2437	Ant1	-8.63	8	Pass
NVNT	b	2462	Ant1	-8.86	8	Pass
NVNT	g	2412	Ant1	-17.95	8	Pass
NVNT	g	2437	Ant1	-18.64	8	Pass
NVNT	g	2462	Ant1	-20.75	8	Pass
NVNT	n20	2412	Ant1	-22.56	8	Pass
NVNT	n20	2437	Ant1	-22.94	8	Pass
NVNT	n20	2462	Ant1	-23.25	8	Pass
NVNT	n40	2422	Ant1	-26.36	8	Pass
NVNT	n40	2437	Ant1	-23.64	8	Pass
NVNT	n40	2452	Ant1	-20.86	8	Pass



Test Graphs

PSD NVNT b 2412MHz Ant1

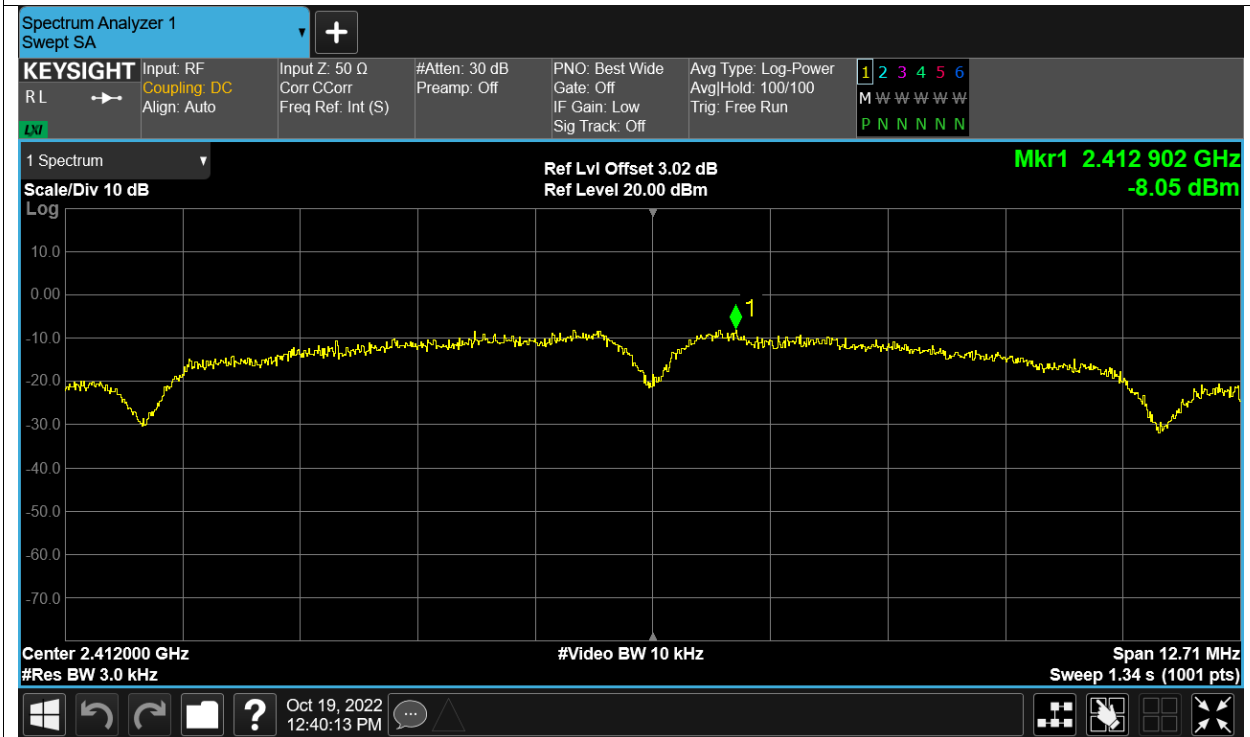

PSD NVNT b 2437MHz Ant1

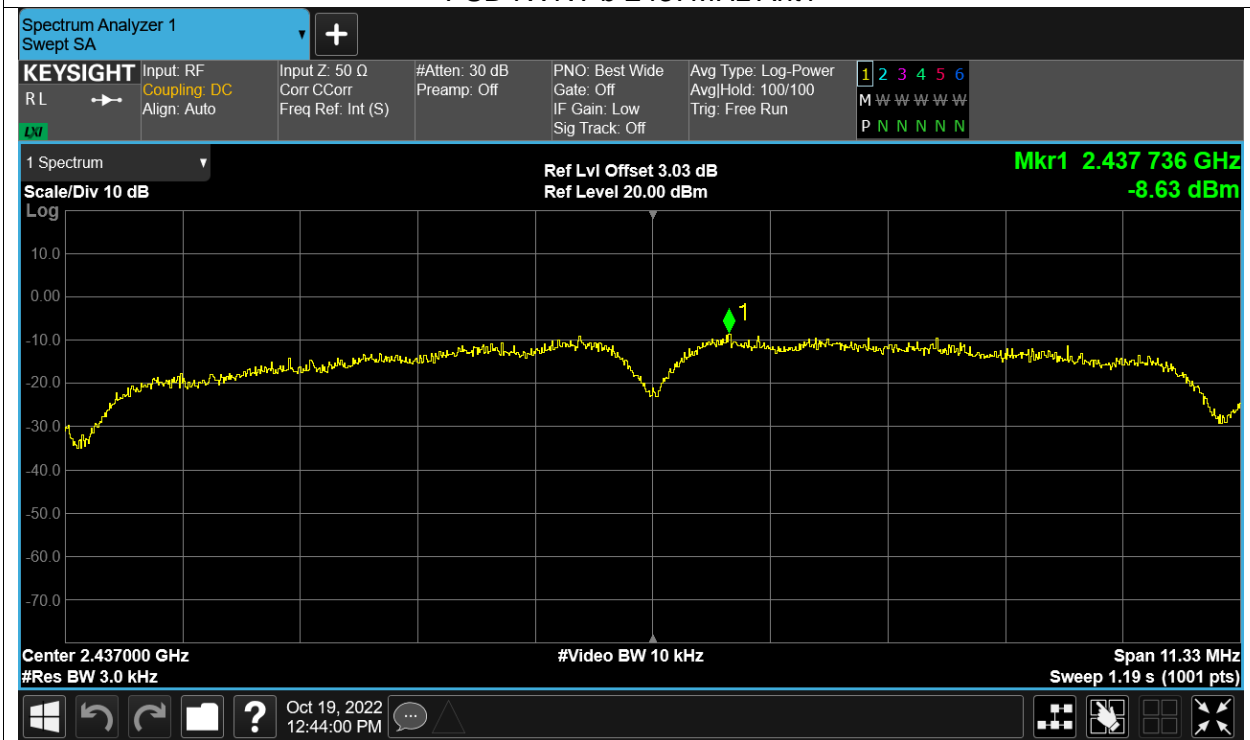



PSD NVNT b 2462MHz Ant1

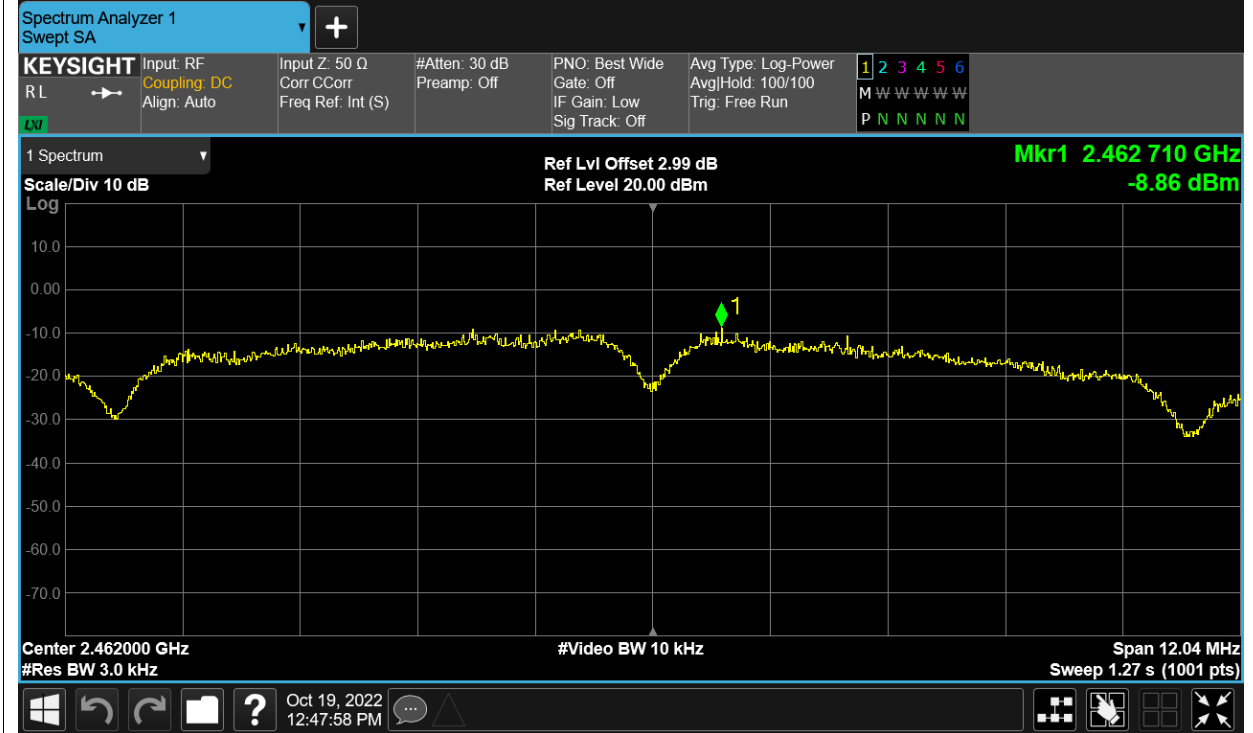

PSD NVNT g 2412MHz Ant1

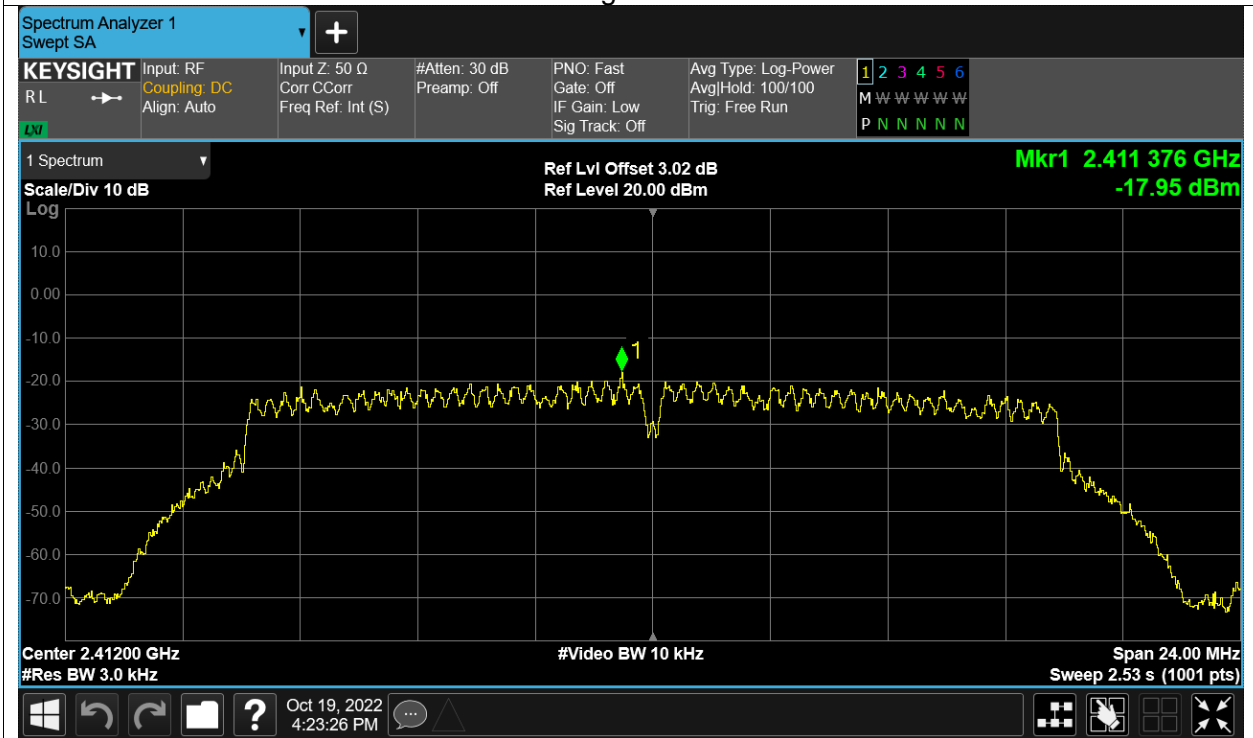



PSD NVNT g 2437MHz Ant1

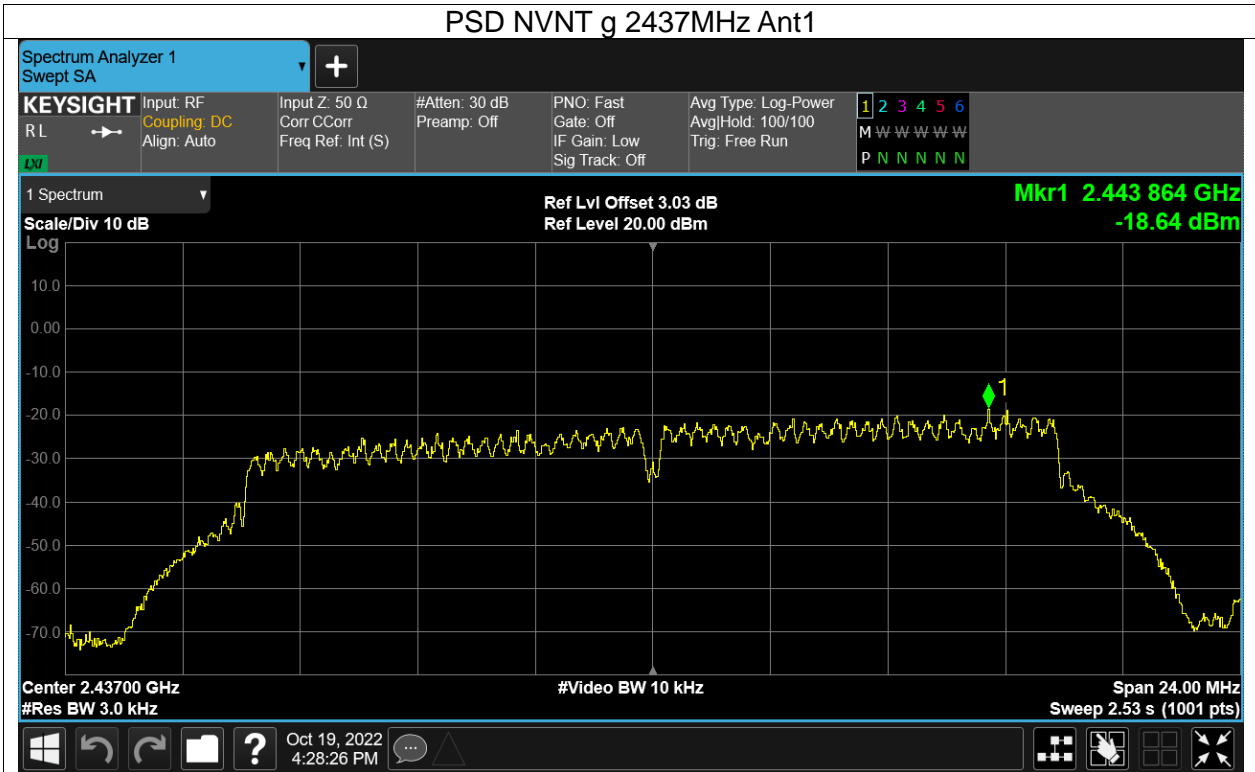

PSD NVNT g 2462MHz Ant1

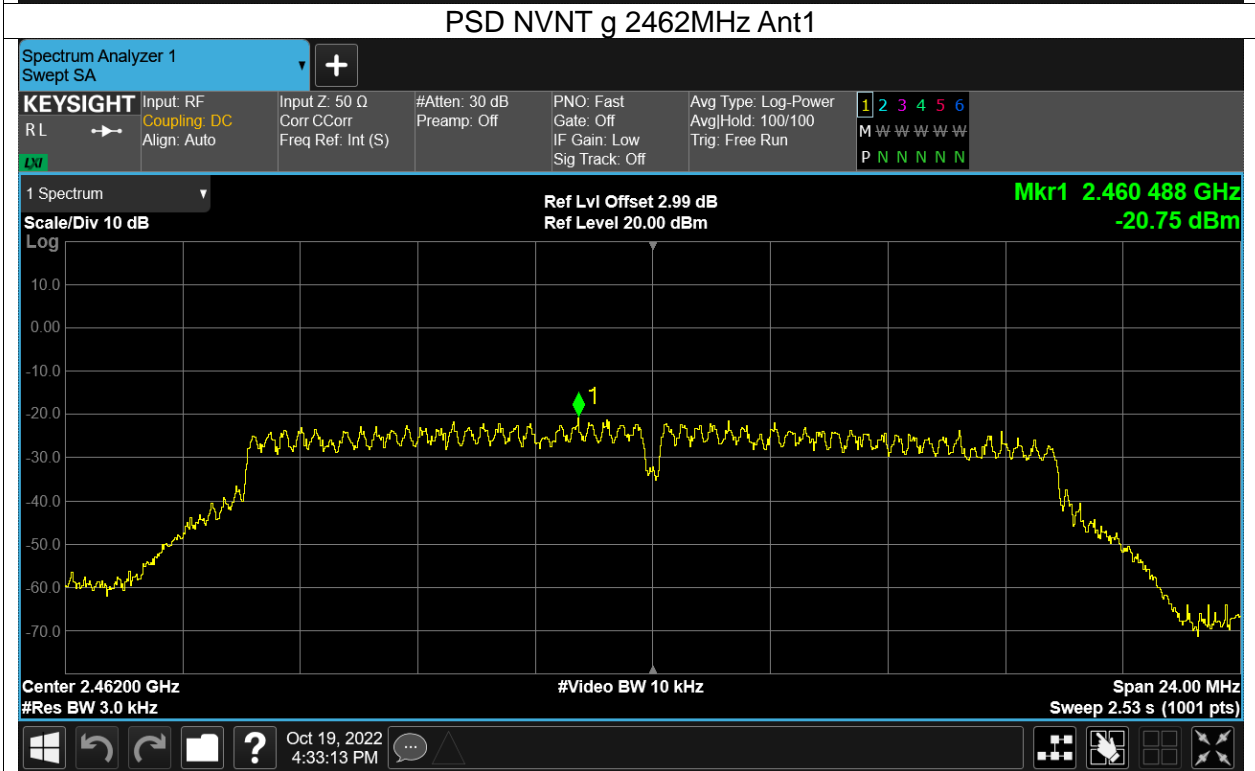



PSD NVNT n20 2412MHz Ant1

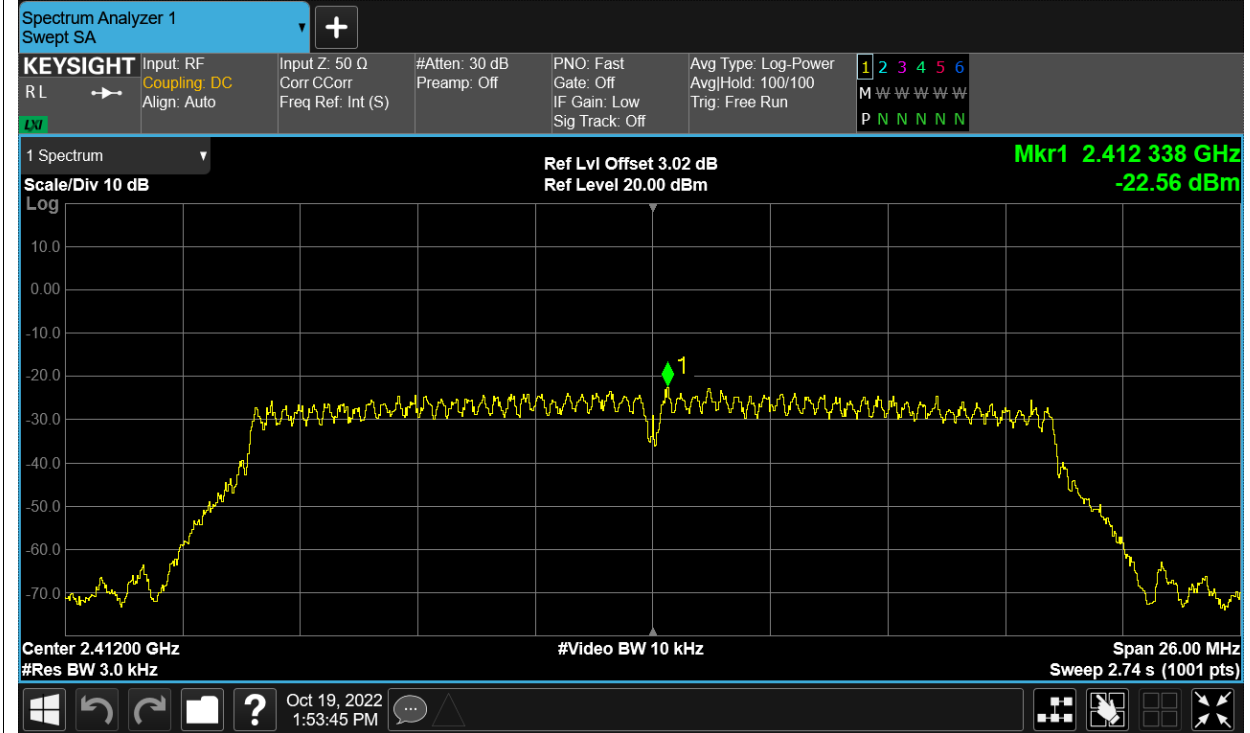

PSD NVNT n20 2437MHz Ant1

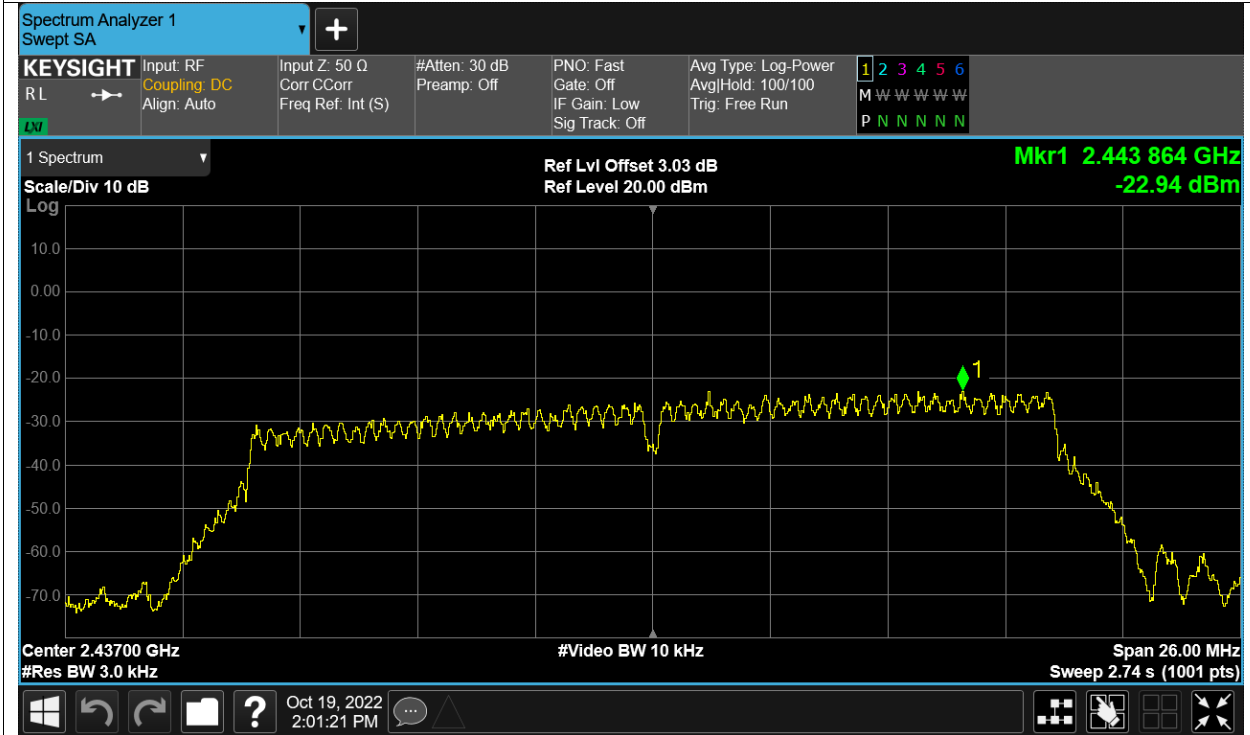



PSD NVNT n20 2462MHz Ant1

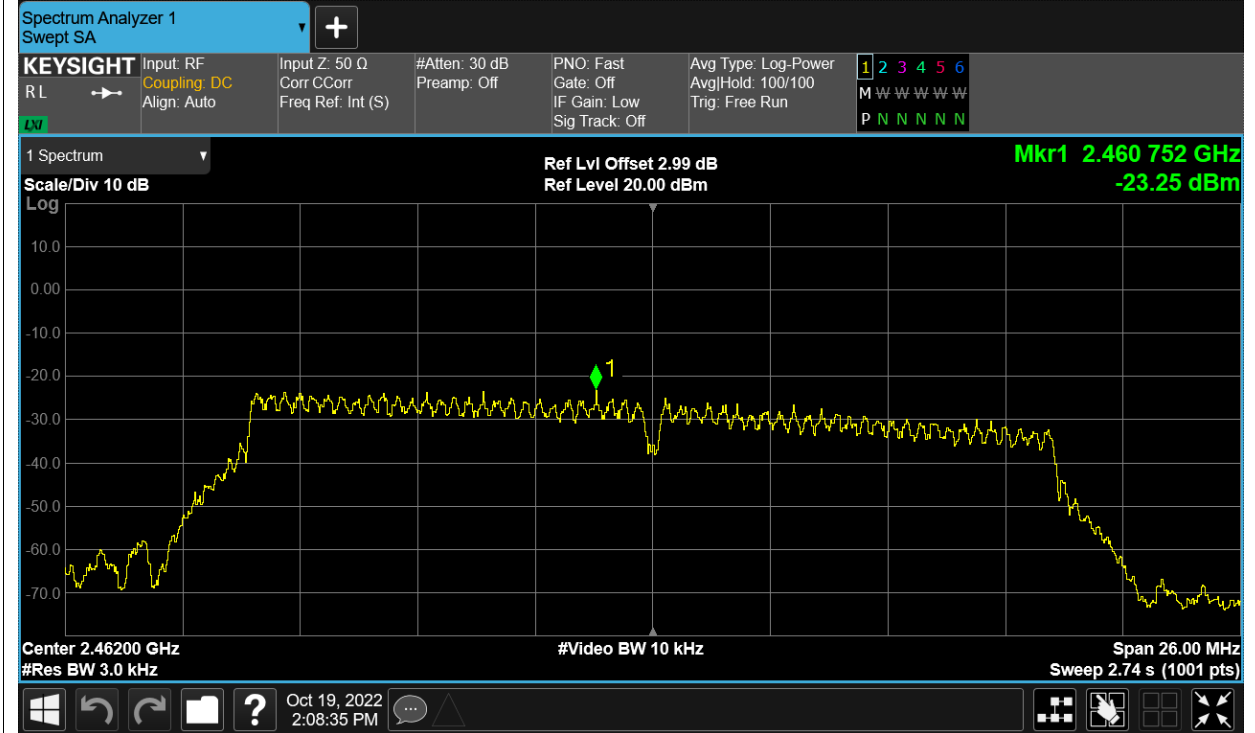

PSD NVNT n40 2422MHz Ant1

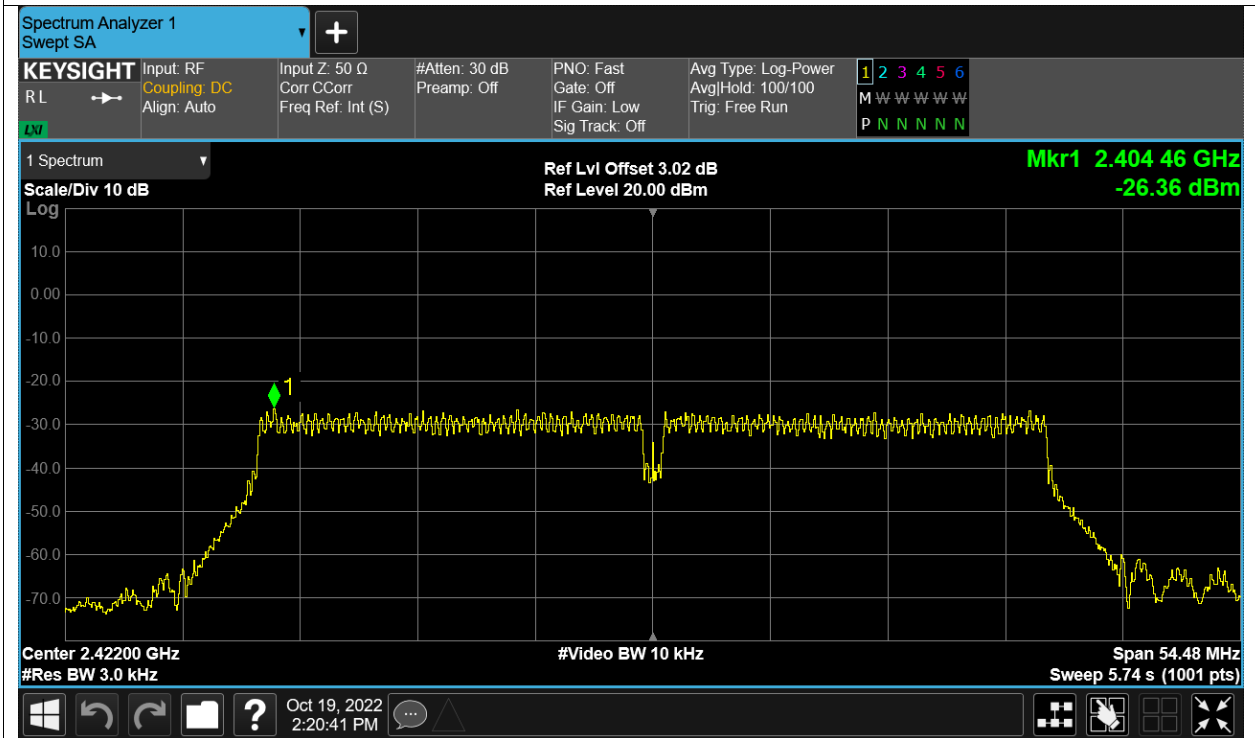



PSD NVNT n40 2437MHz Ant1

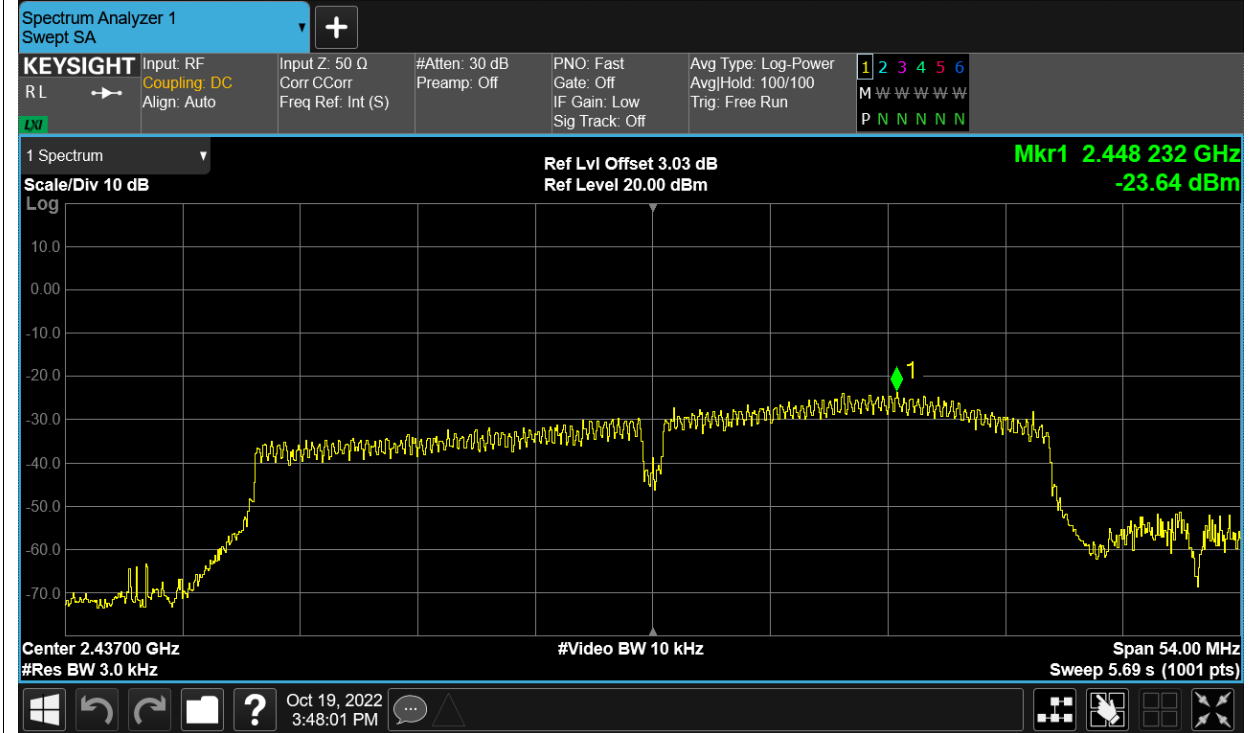

PSD NVNT n40 2452MHz Ant1

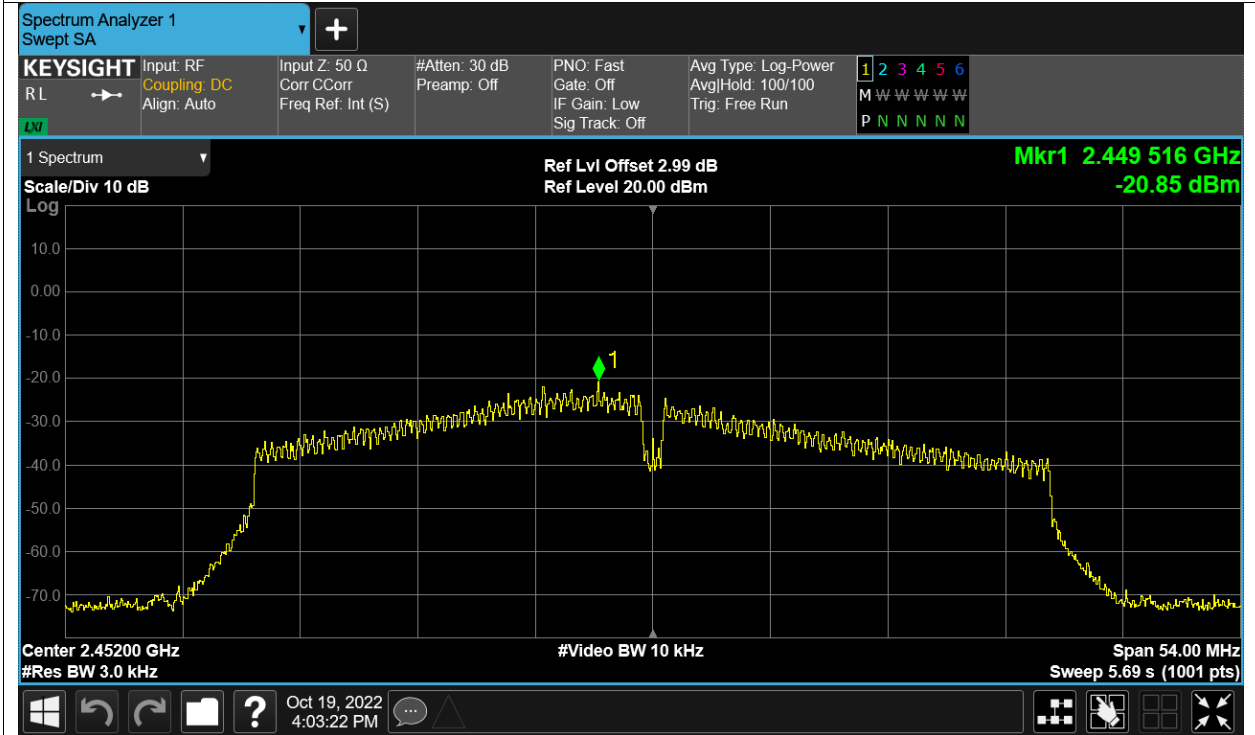



BAND EDGE

Condition	Mode	Frequency (MHz)	Antenna	Max Value (dBc)	Limit (dBc)	Verdict
NVNT	b	2412	Ant1	-50.43	-20	Pass
NVNT	b	2462	Ant1	-55.86	-20	Pass
NVNT	g	2412	Ant1	-46.4	-20	Pass
NVNT	g	2462	Ant1	-47.89	-20	Pass
NVNT	n20	2412	Ant1	-43.53	-20	Pass
NVNT	n20	2462	Ant1	-45.64	-20	Pass
NVNT	n40	2422	Ant1	-39.44	-20	Pass
NVNT	n40	2452	Ant1	-46.84	-20	Pass



Test Graphs

Band Edge NVNT b 2412MHz Ant1 Ref

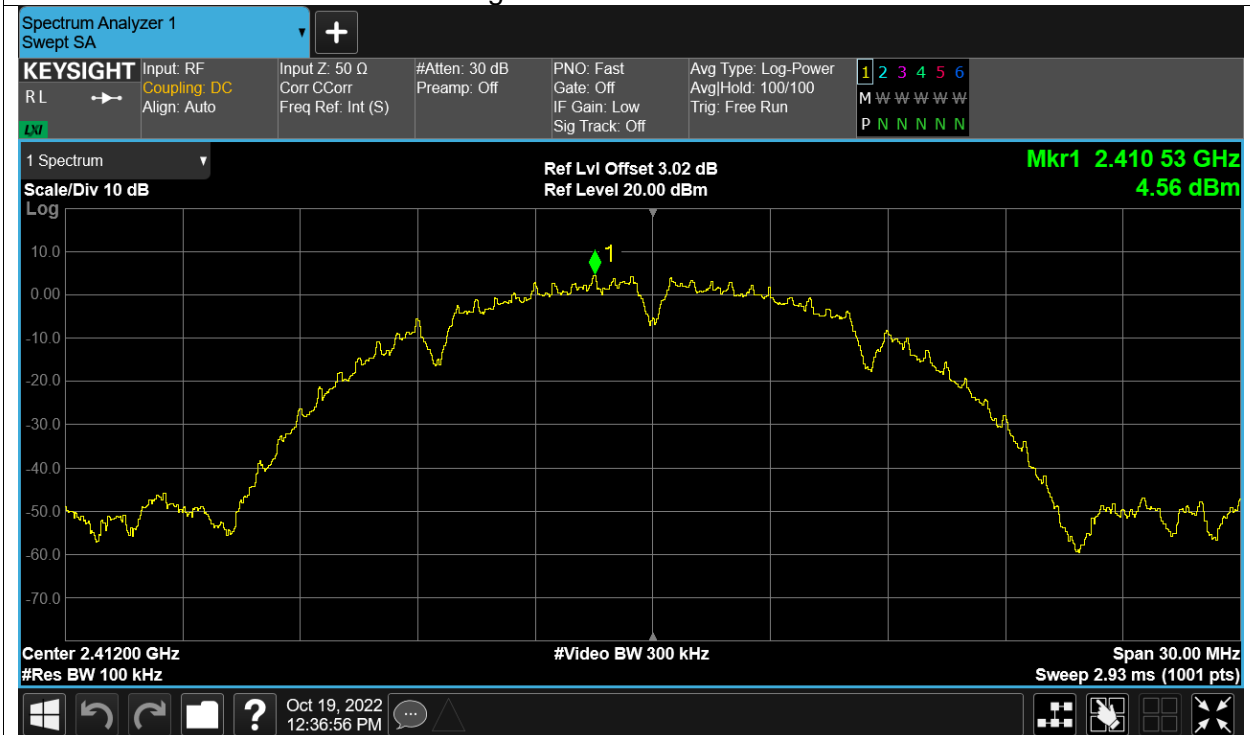

Band Edge NVNT b 2412MHz Ant1 Emission

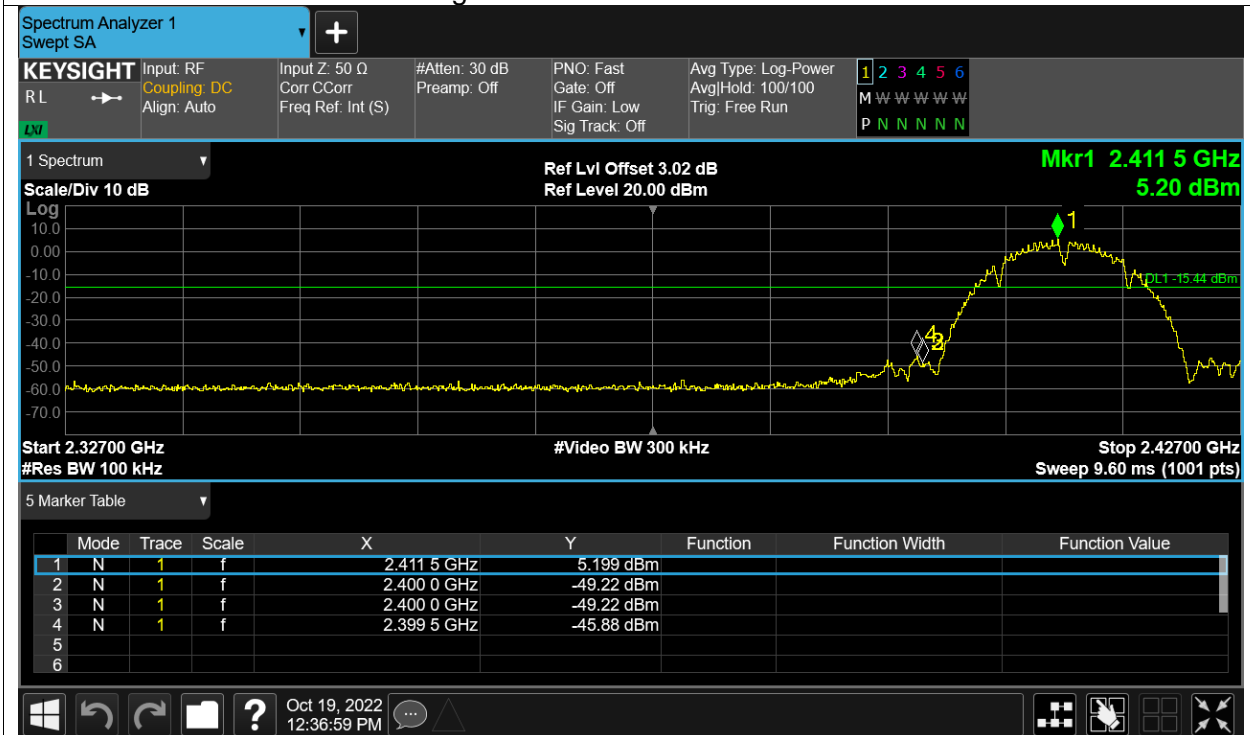



Band Edge NVNT b 2462MHz Ant1 Ref

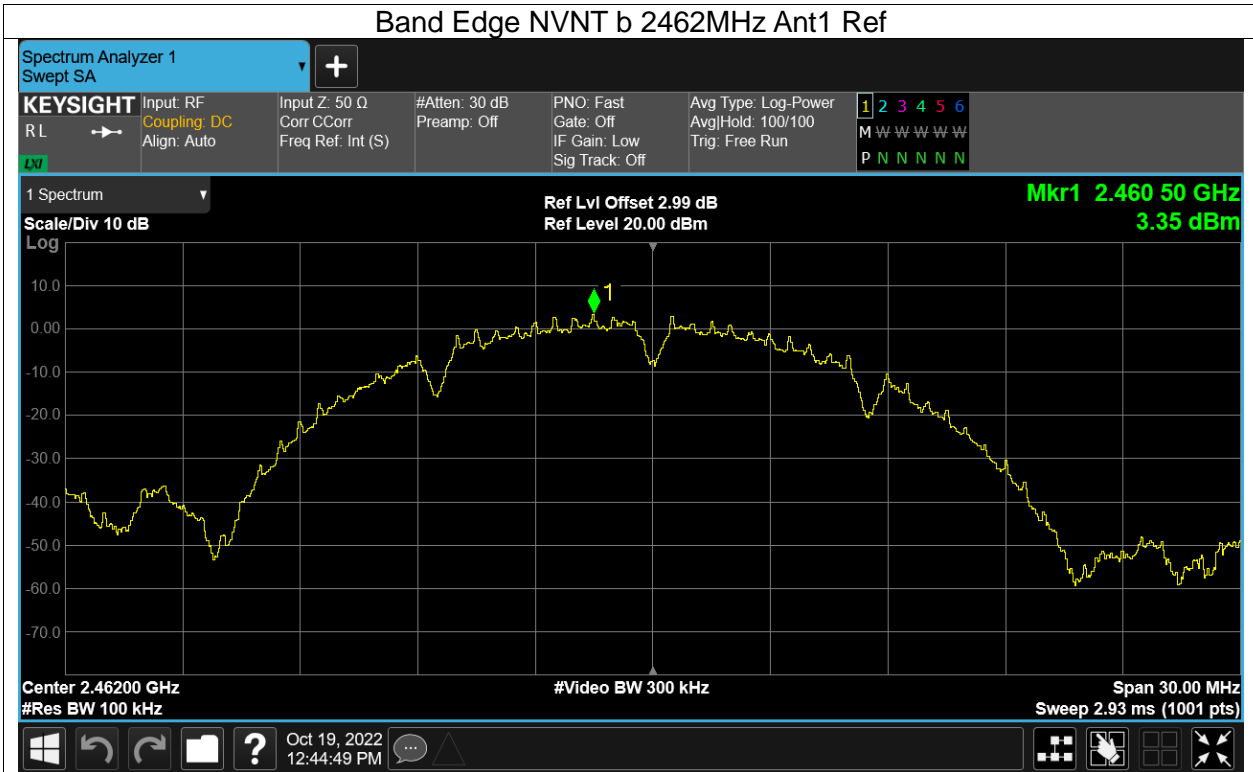

Band Edge NVNT b 2462MHz Ant1 Emission

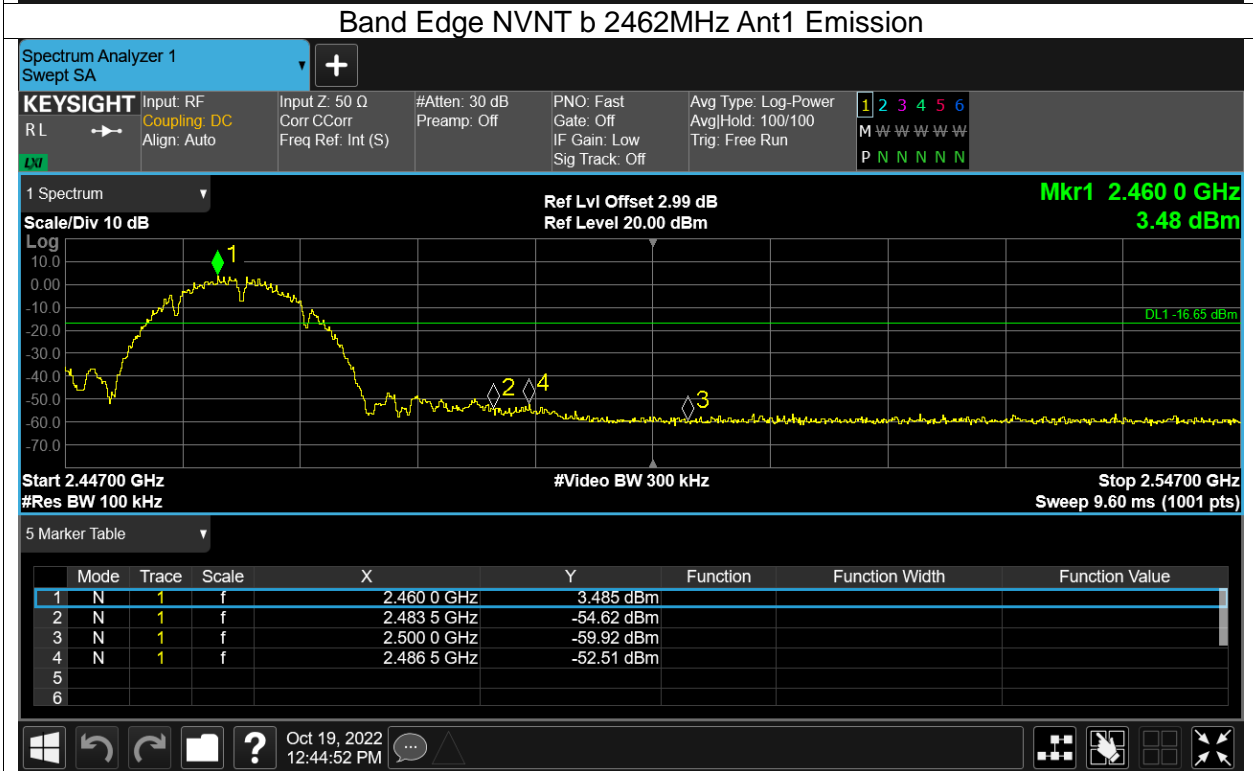



Band Edge NVNT g 2412MHz Ant1 Ref

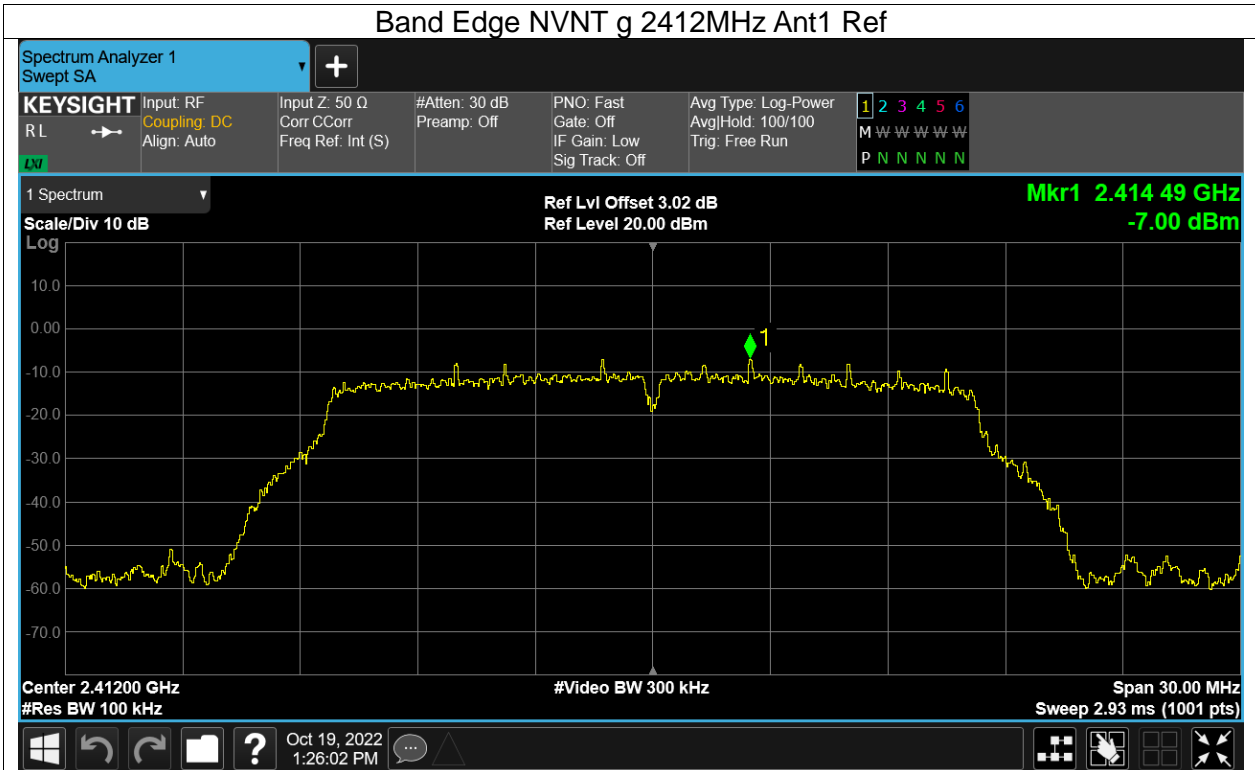

Band Edge NVNT g 2412MHz Ant1 Emission

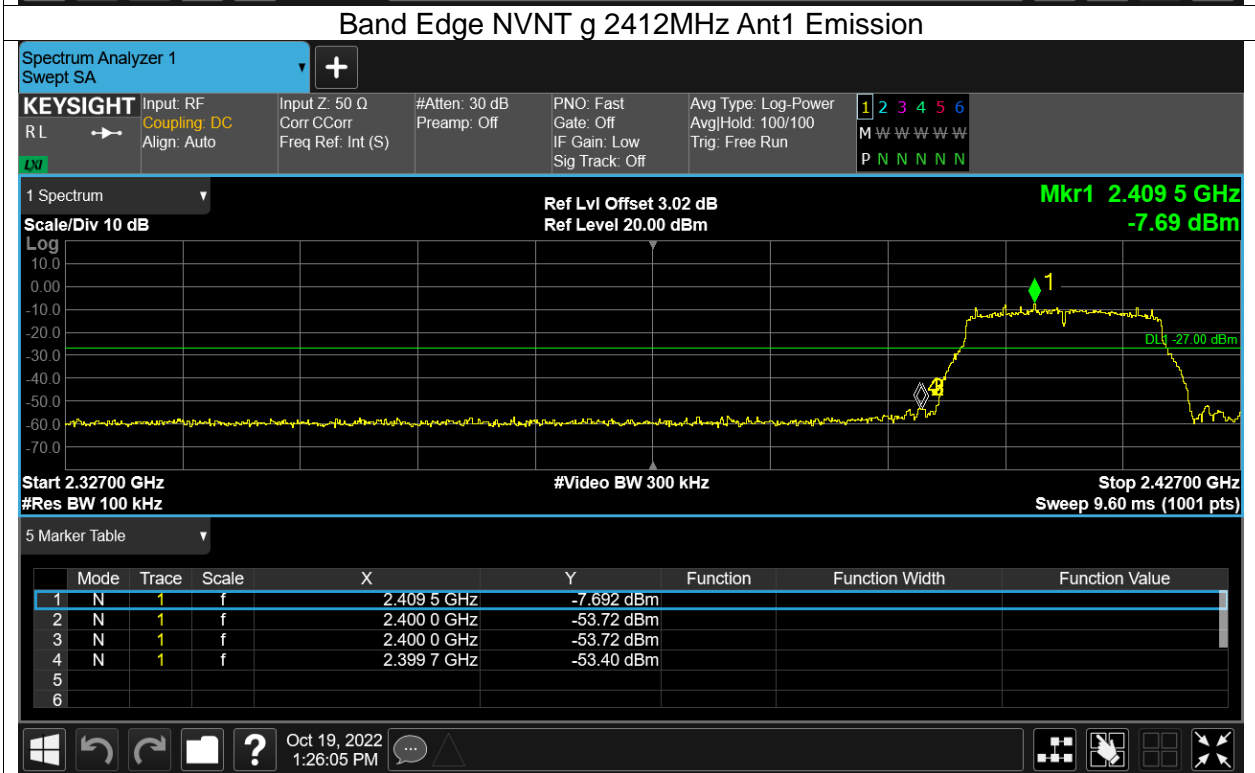



Band Edge NVNT g 2462MHz Ant1 Ref

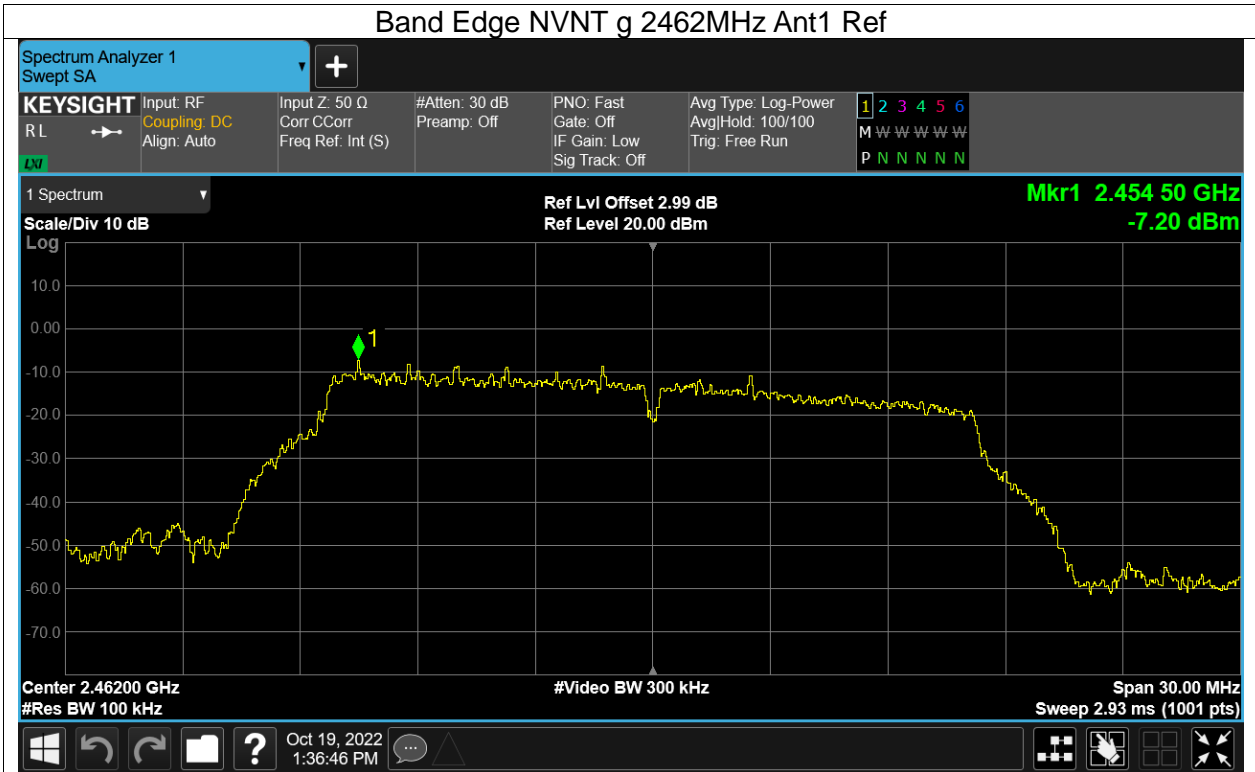

Band Edge NVNT g 2462MHz Ant1 Emission

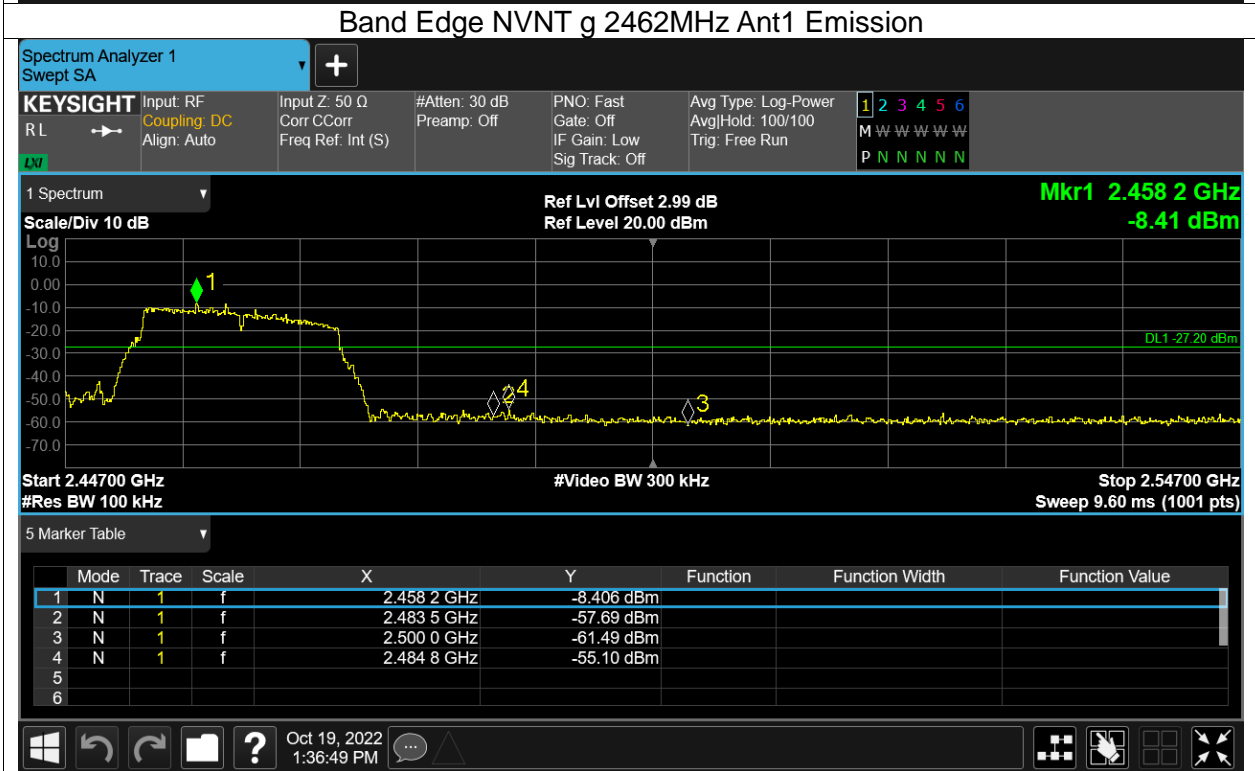

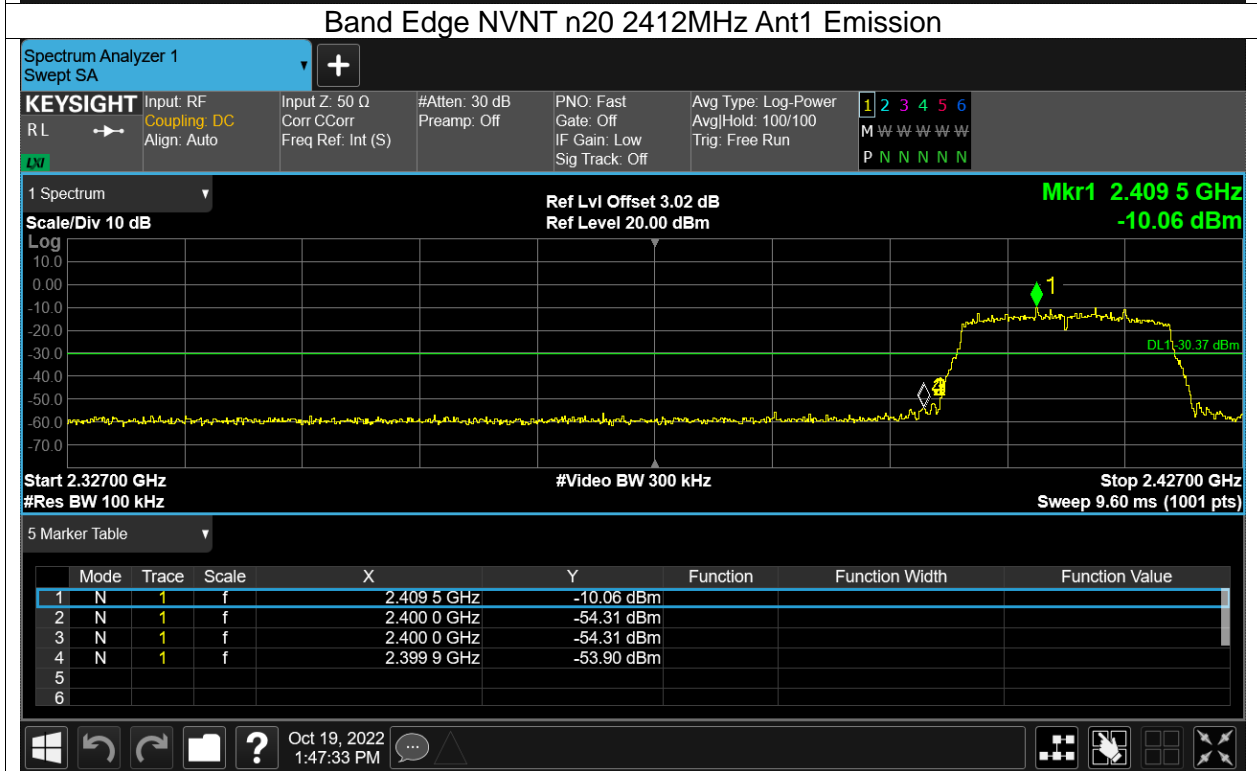
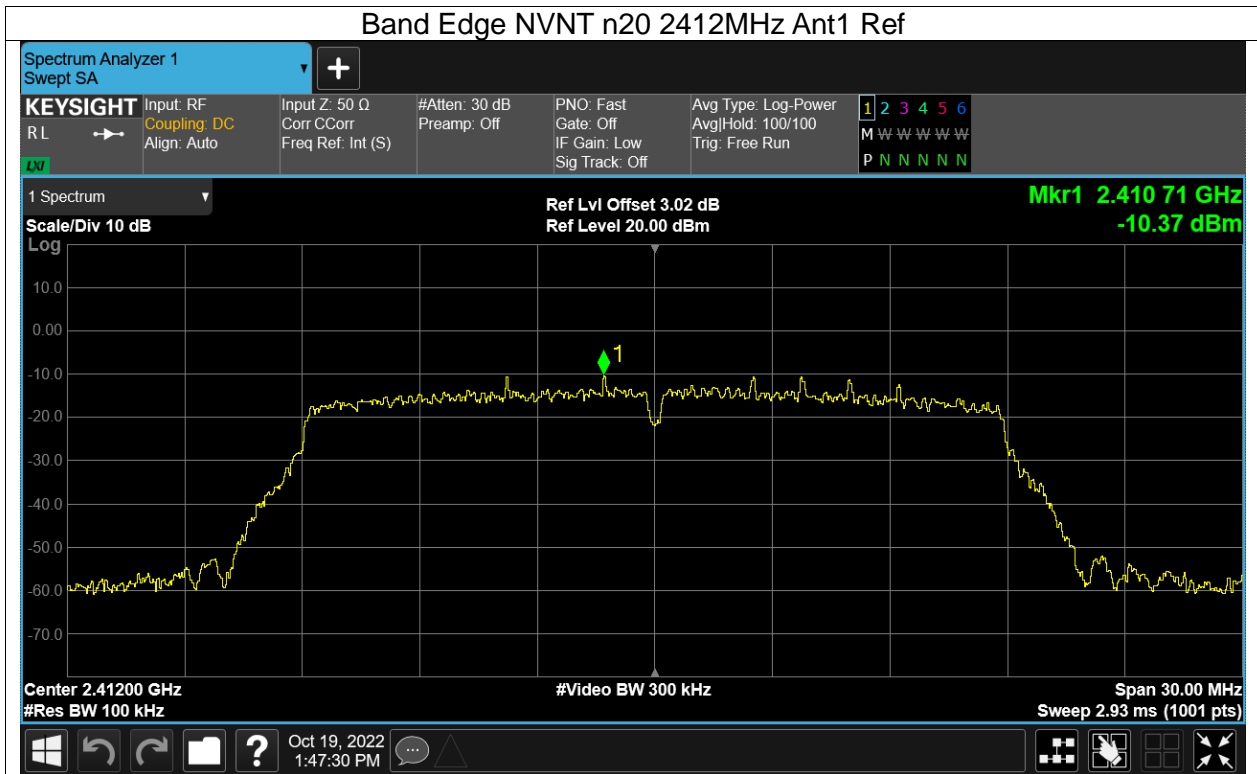

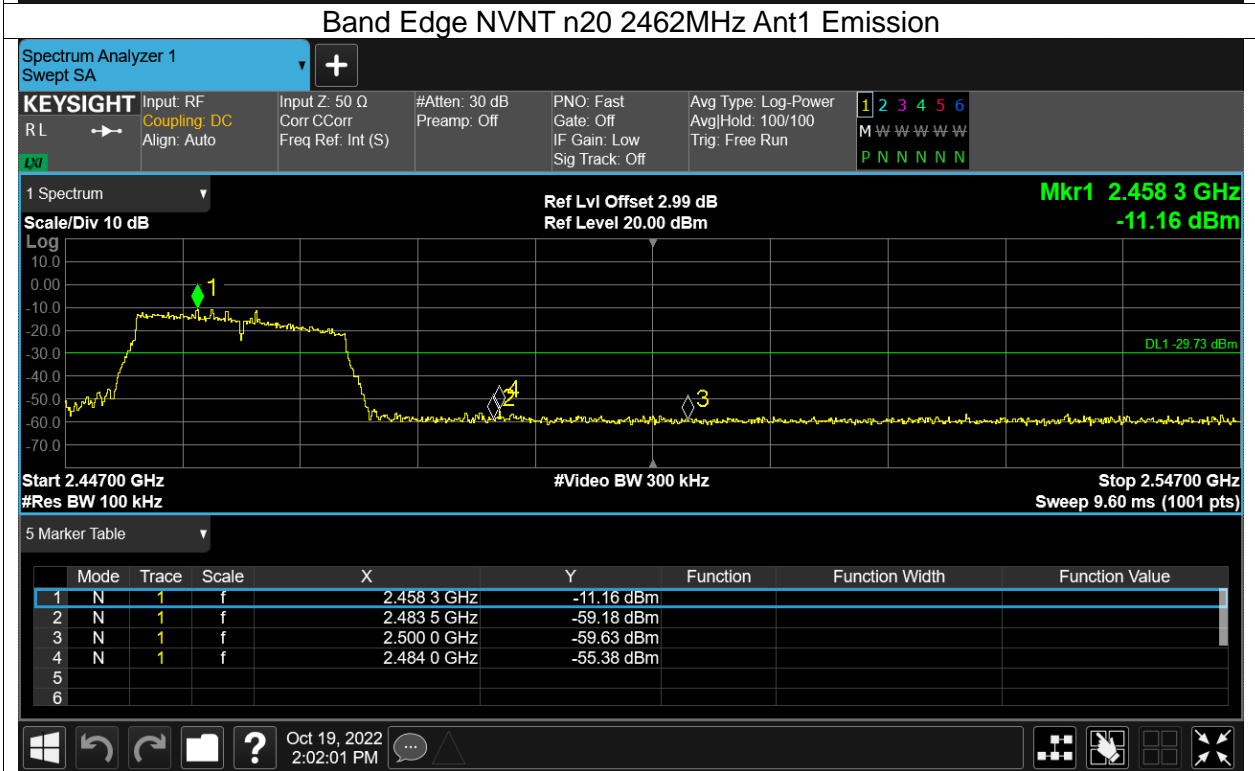
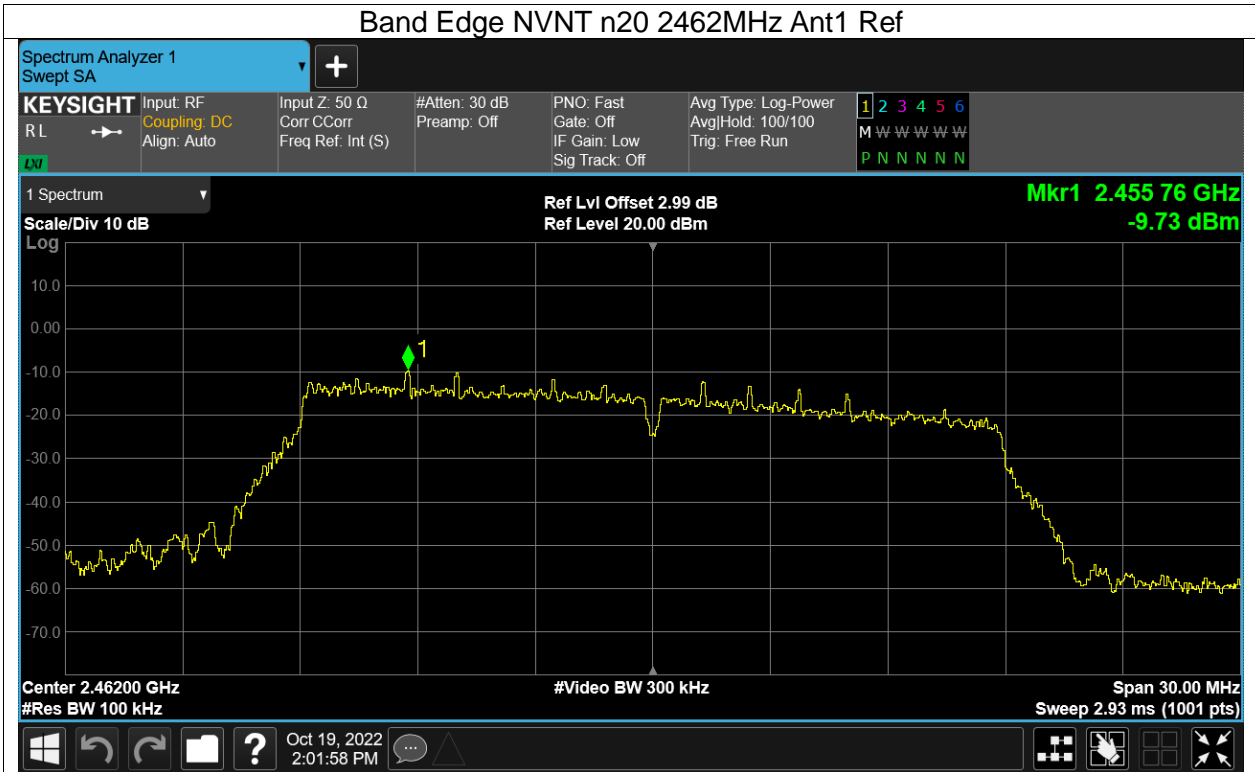

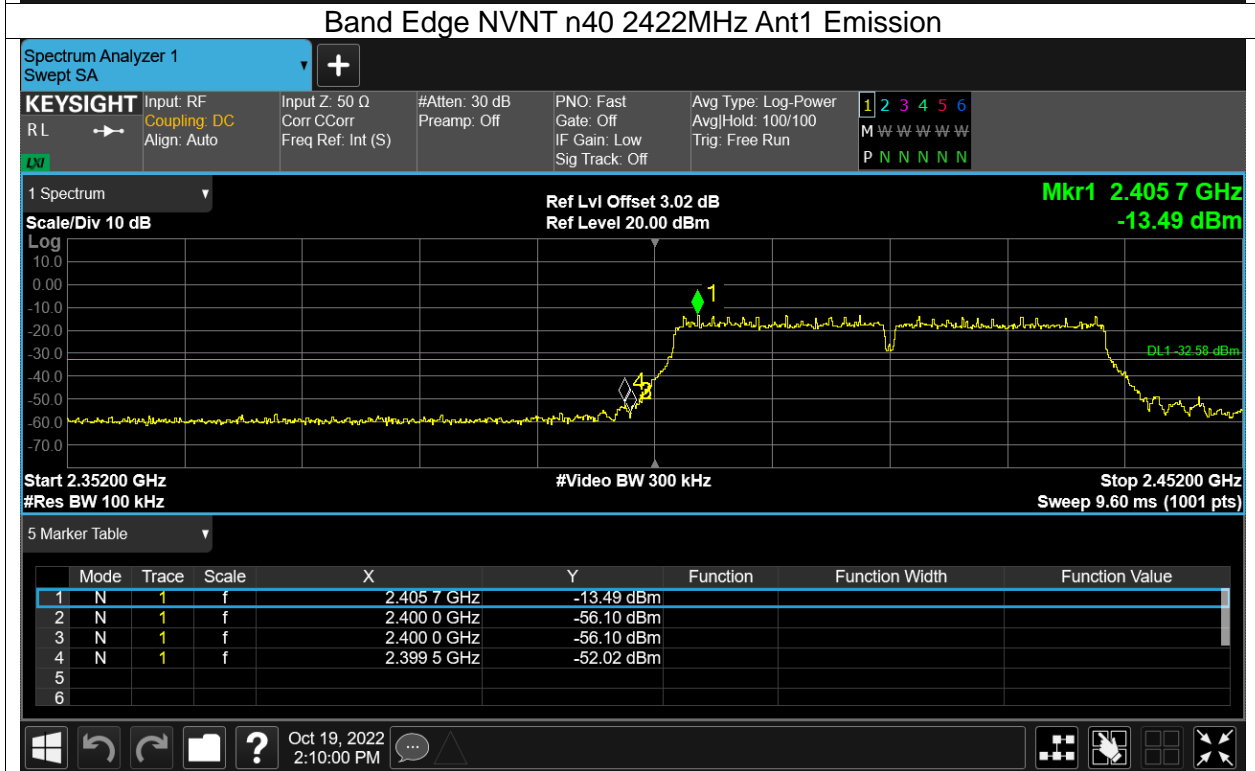
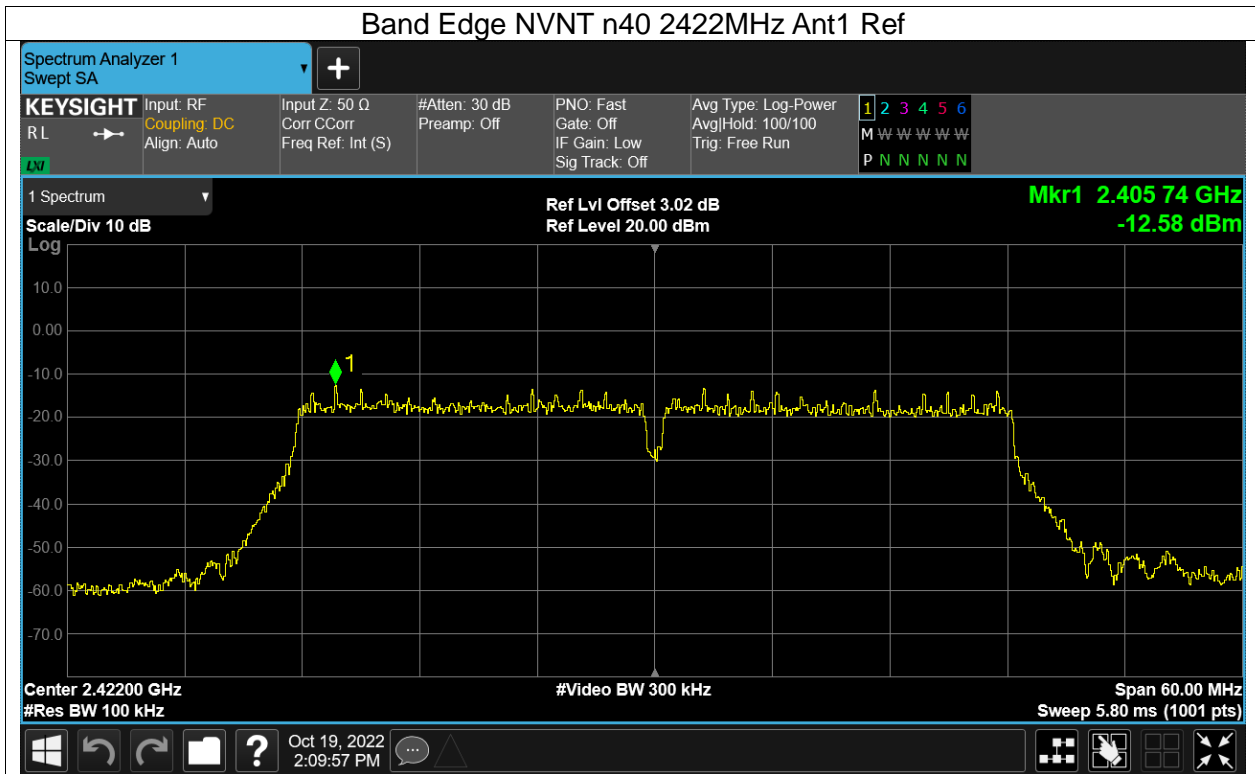



Band Edge NVNT n40 2452MHz Ant1 Ref

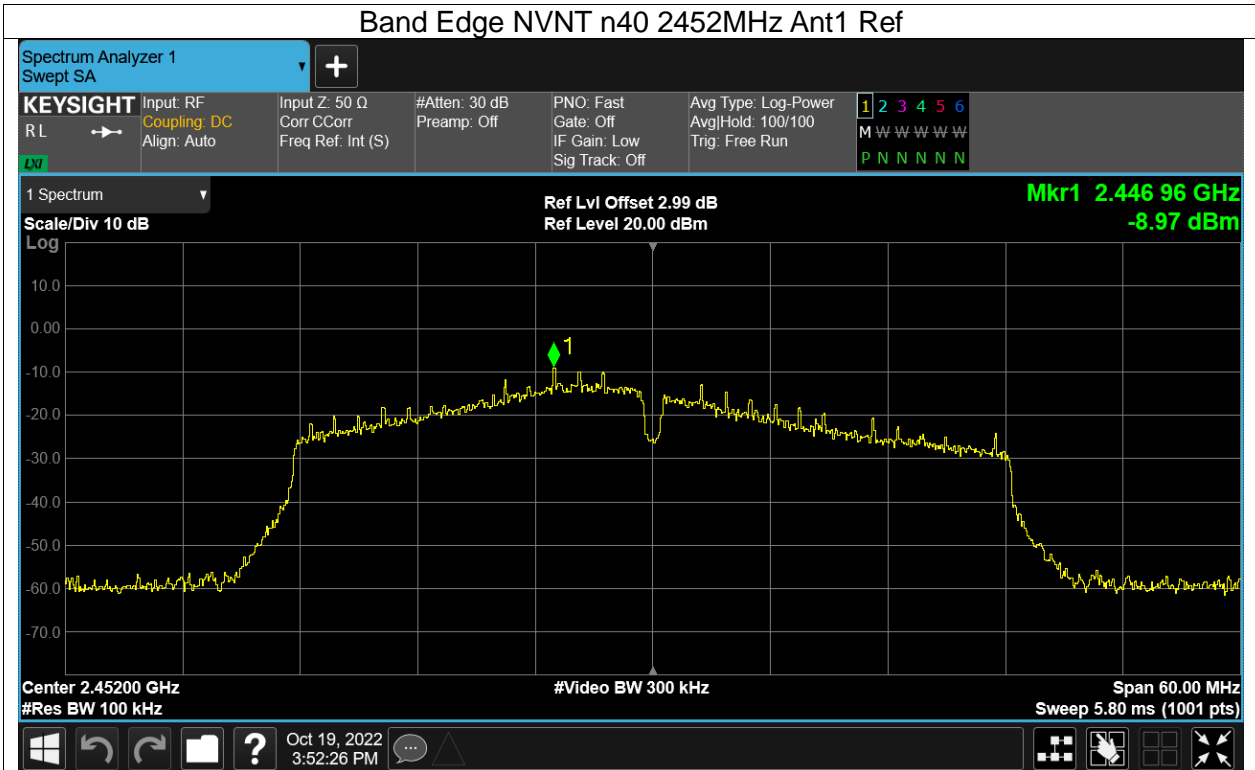

Band Edge NVNT n40 2452MHz Ant1 Emission

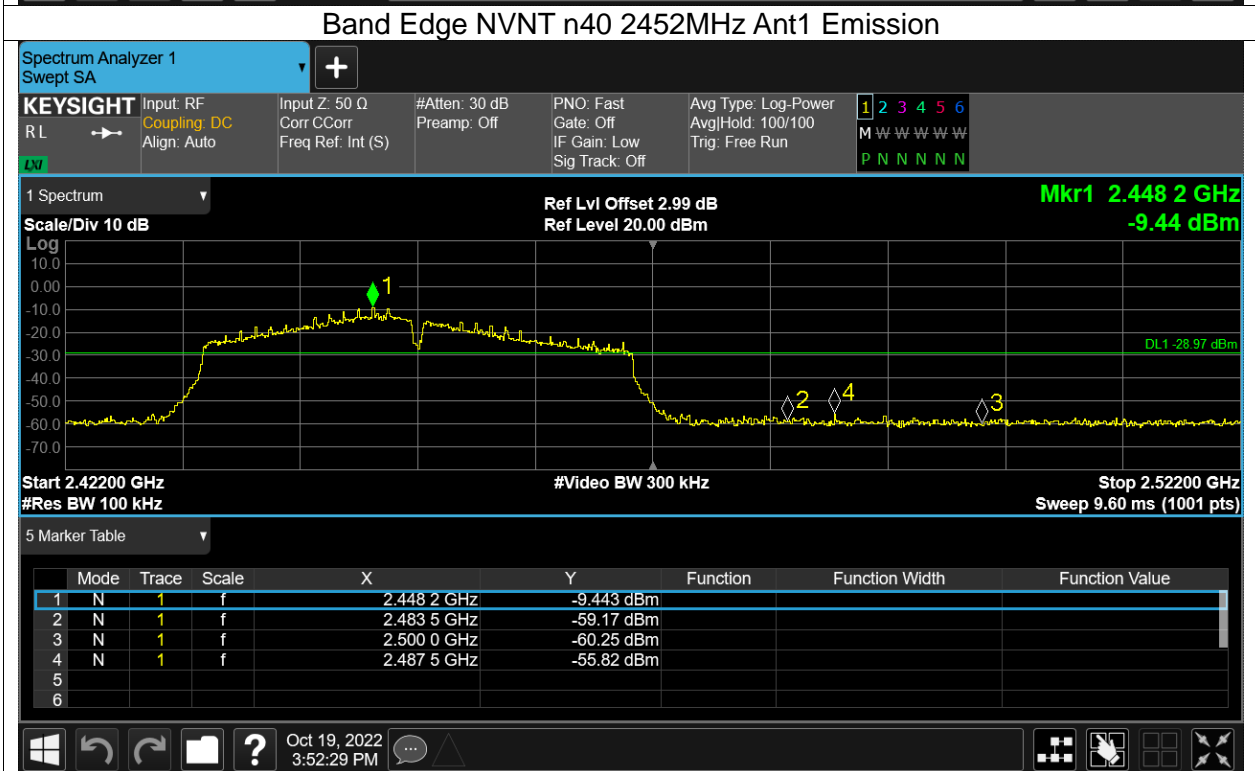



CONDUCTED RF SPURIOUS EMISSION

Condition	Mode	Frequency (MHz)	Antenna	Max Value (dBc)	Limit (dBc)	Verdict
NVNT	b	2412	Ant1	-53.56	-20	Pass
NVNT	b	2437	Ant1	-52.44	-20	Pass
NVNT	b	2462	Ant1	-49.63	-20	Pass
NVNT	g	2412	Ant1	-40.44	-20	Pass
NVNT	g	2437	Ant1	-40.79	-20	Pass
NVNT	g	2462	Ant1	-39.4	-20	Pass
NVNT	n20	2412	Ant1	-38.26	-20	Pass
NVNT	n20	2437	Ant1	-34.61	-20	Pass
NVNT	n20	2462	Ant1	-38.49	-20	Pass
NVNT	n40	2422	Ant1	-34.75	-20	Pass
NVNT	n40	2437	Ant1	-38.31	-20	Pass
NVNT	n40	2452	Ant1	-37.55	-20	Pass



Test Graphs

Tx. Spurious NVNT b 2412MHz Ant1 Ref

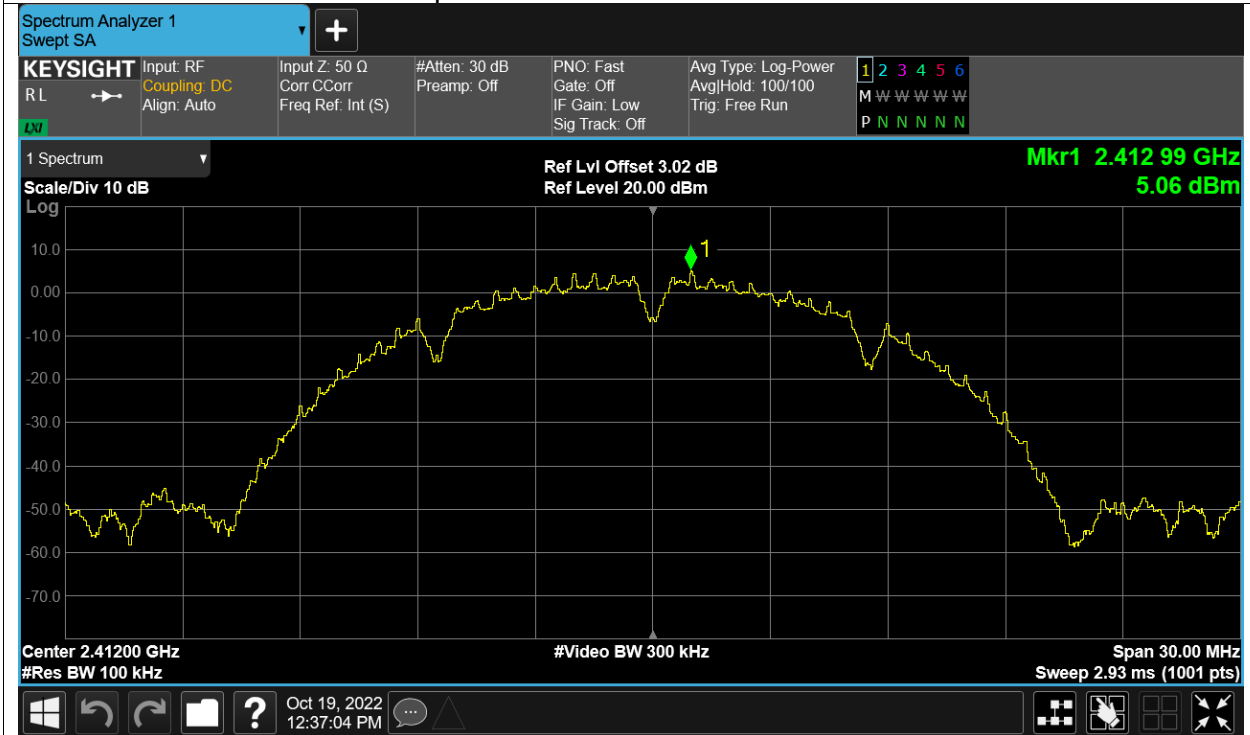

Tx. Spurious NVNT b 2412MHz Ant1 Emission

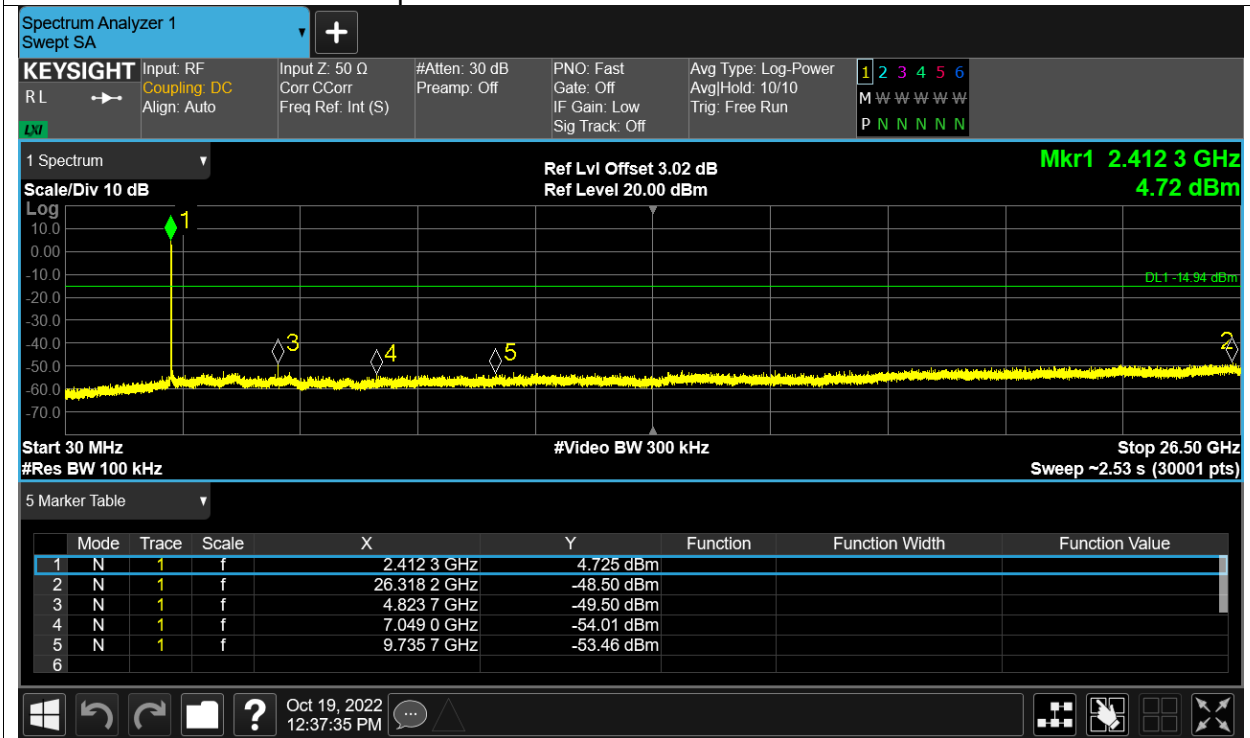



Tx. Spurious NVNT b 2437MHz Ant1 Ref

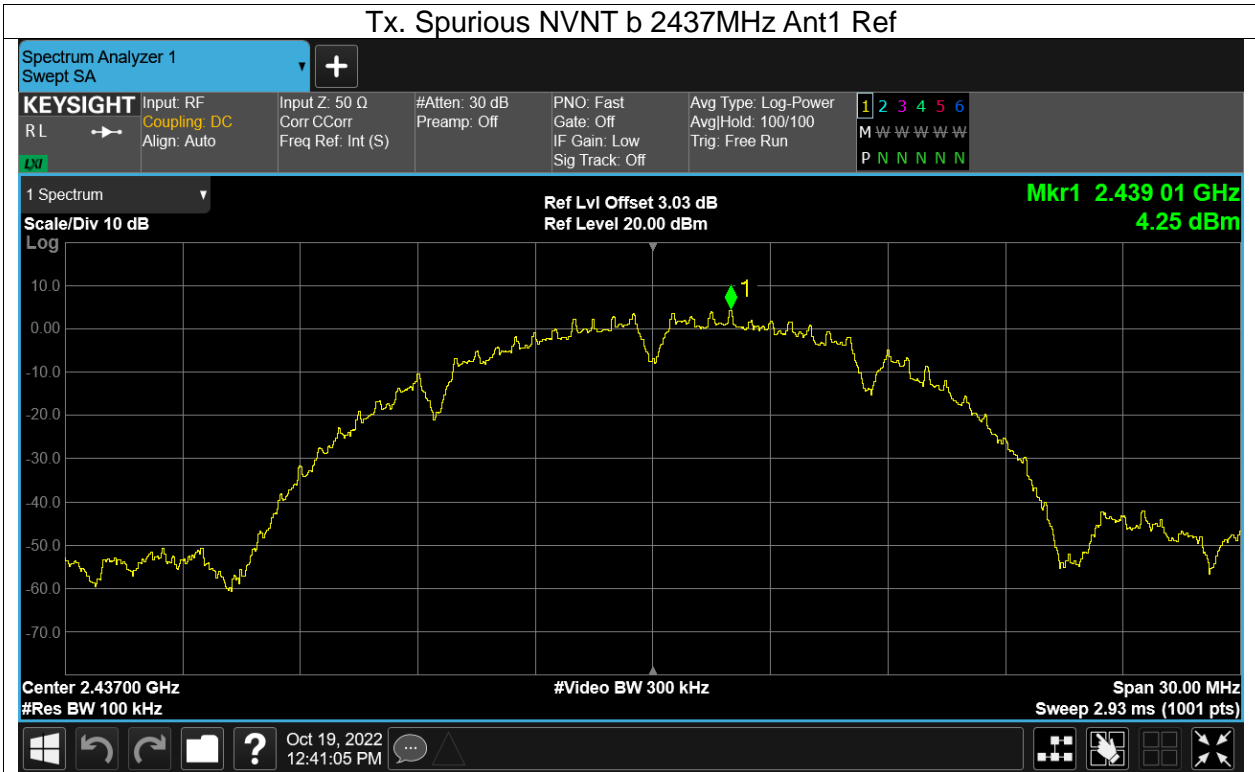

Tx. Spurious NVNT b 2437MHz Ant1 Emission

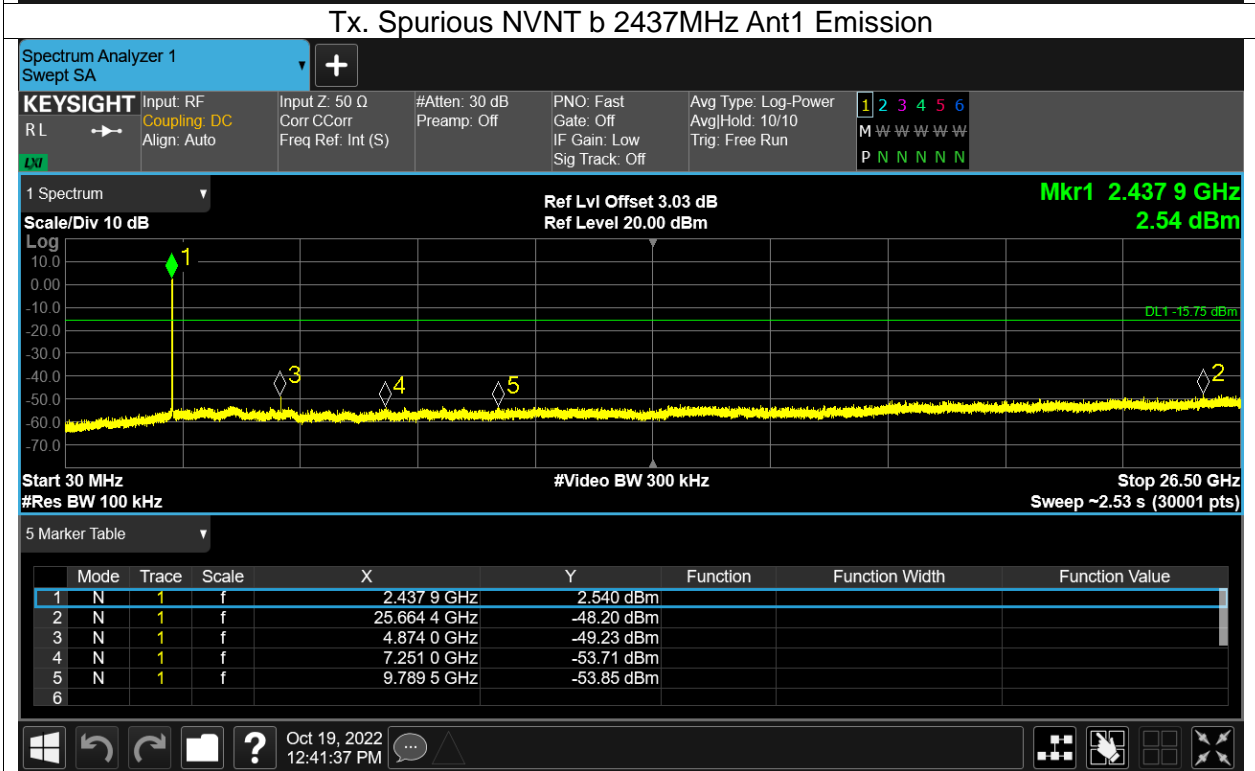



Tx. Spurious NVNT b 2462MHz Ant1 Ref

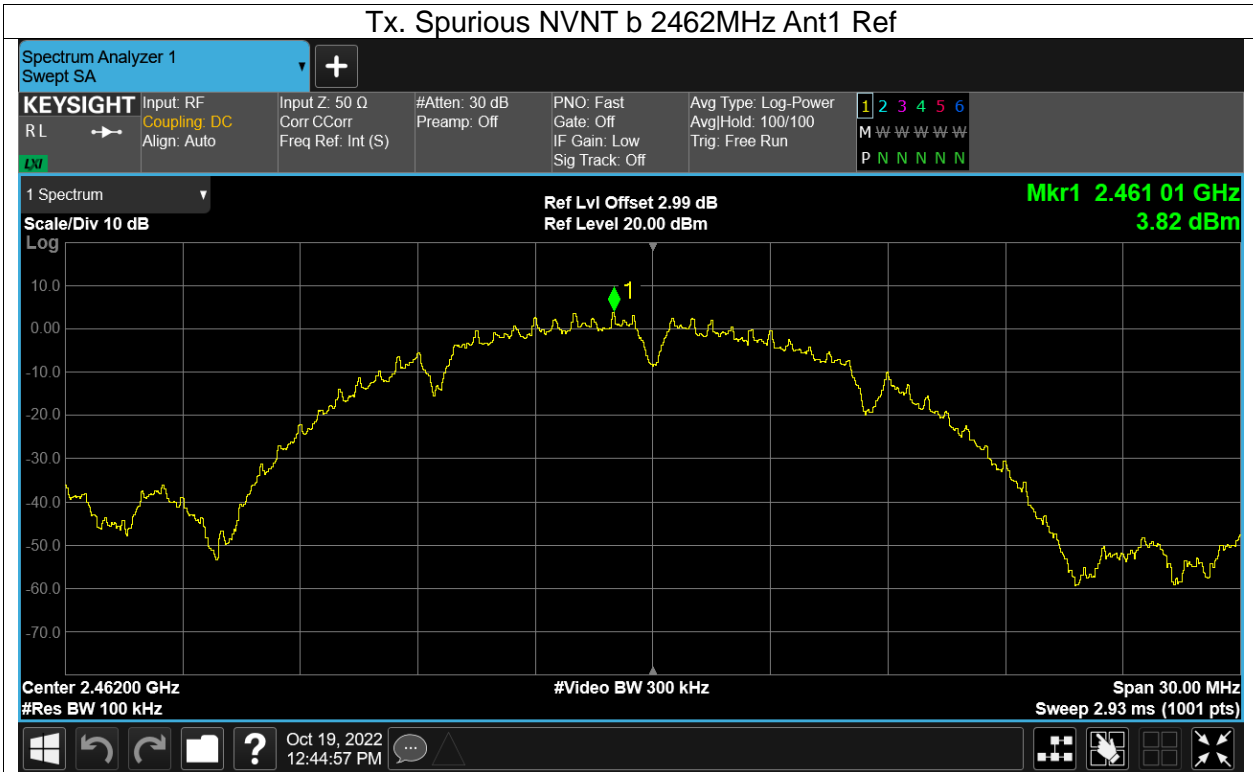

Tx. Spurious NVNT b 2462MHz Ant1 Emission

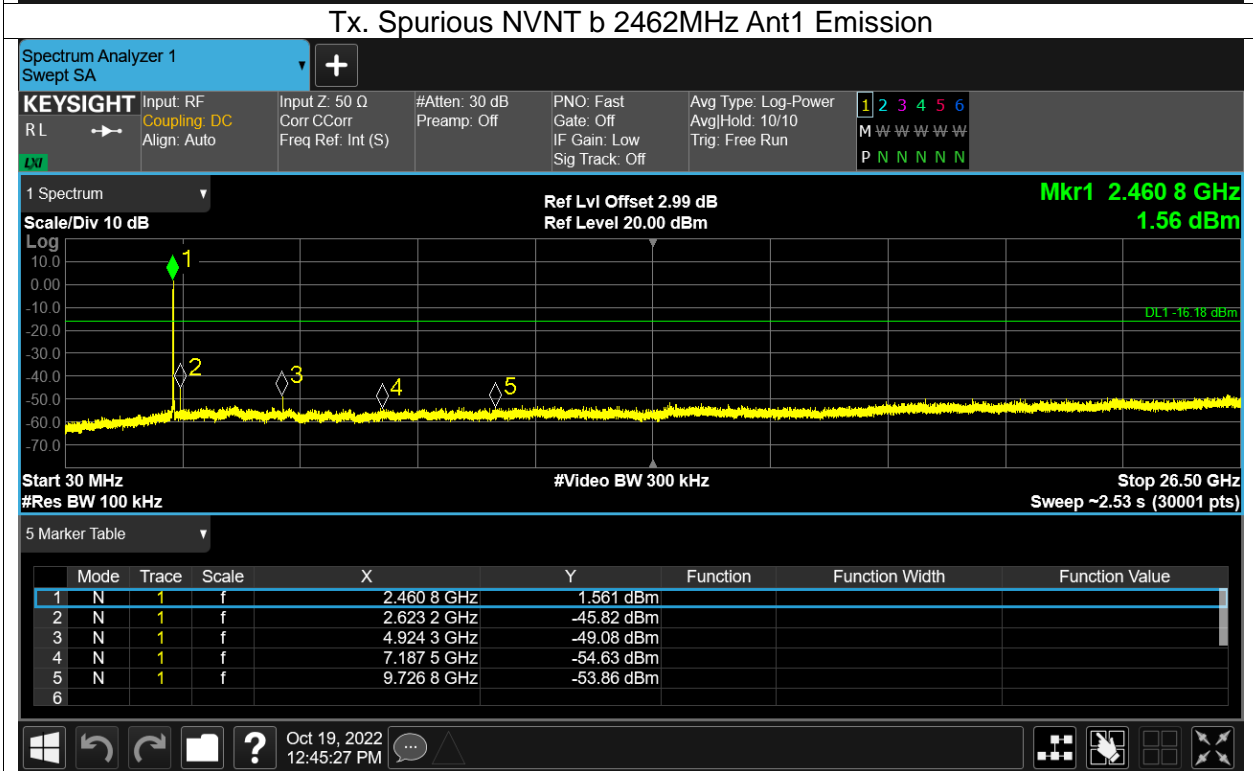



Tx. Spurious NVNT g 2412MHz Ant1 Ref

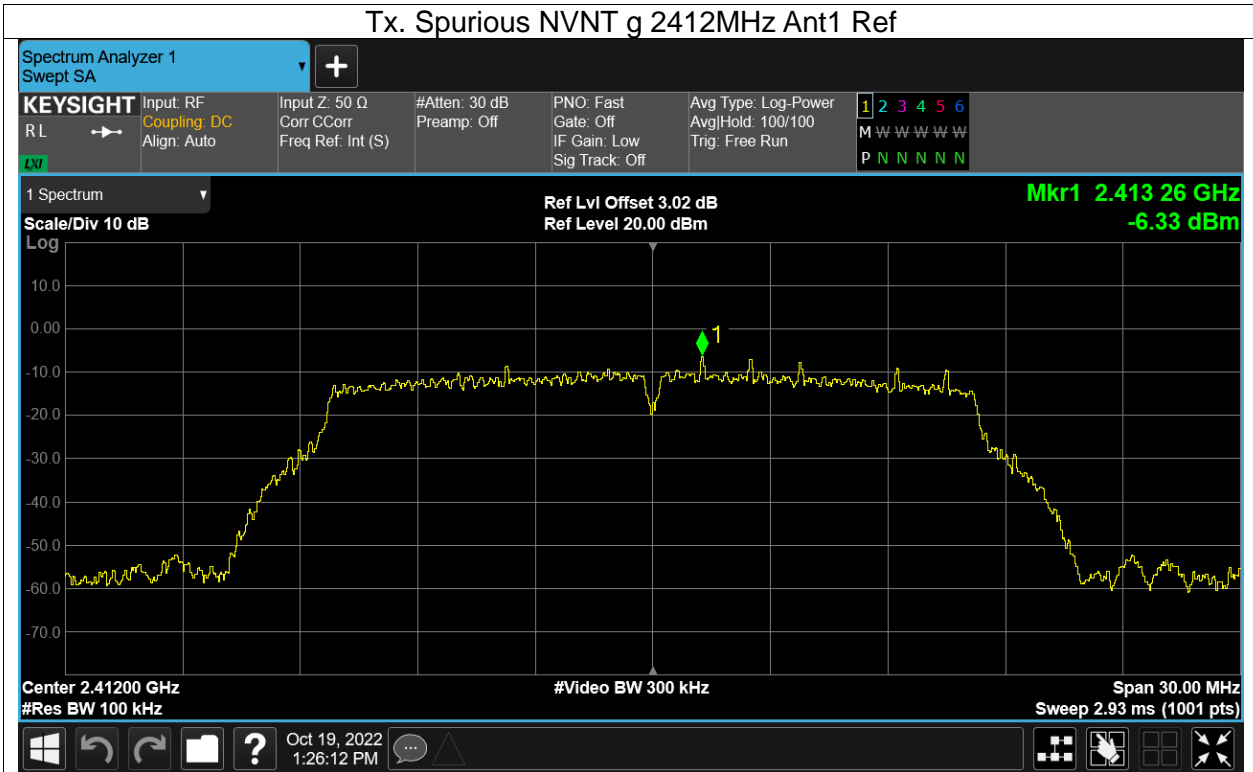

Tx. Spurious NVNT g 2412MHz Ant1 Emission

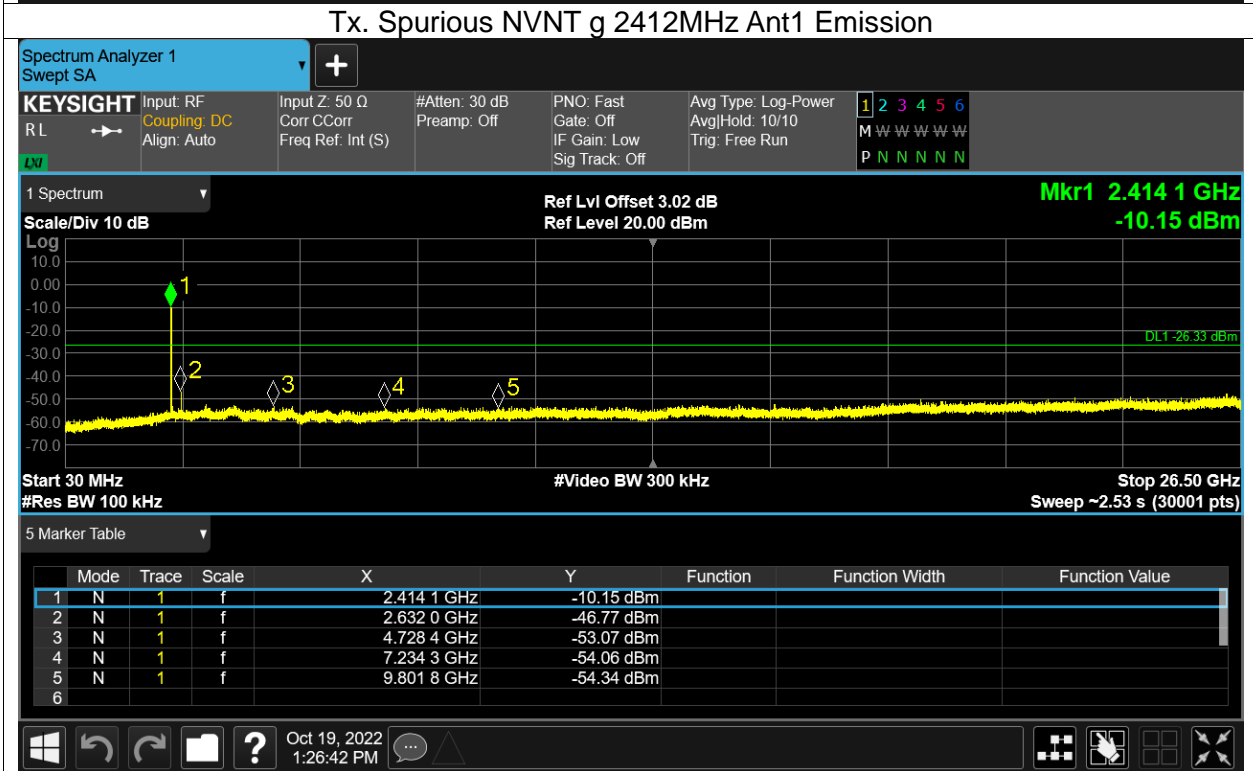



Tx. Spurious NVNT g 2437MHz Ant1 Ref

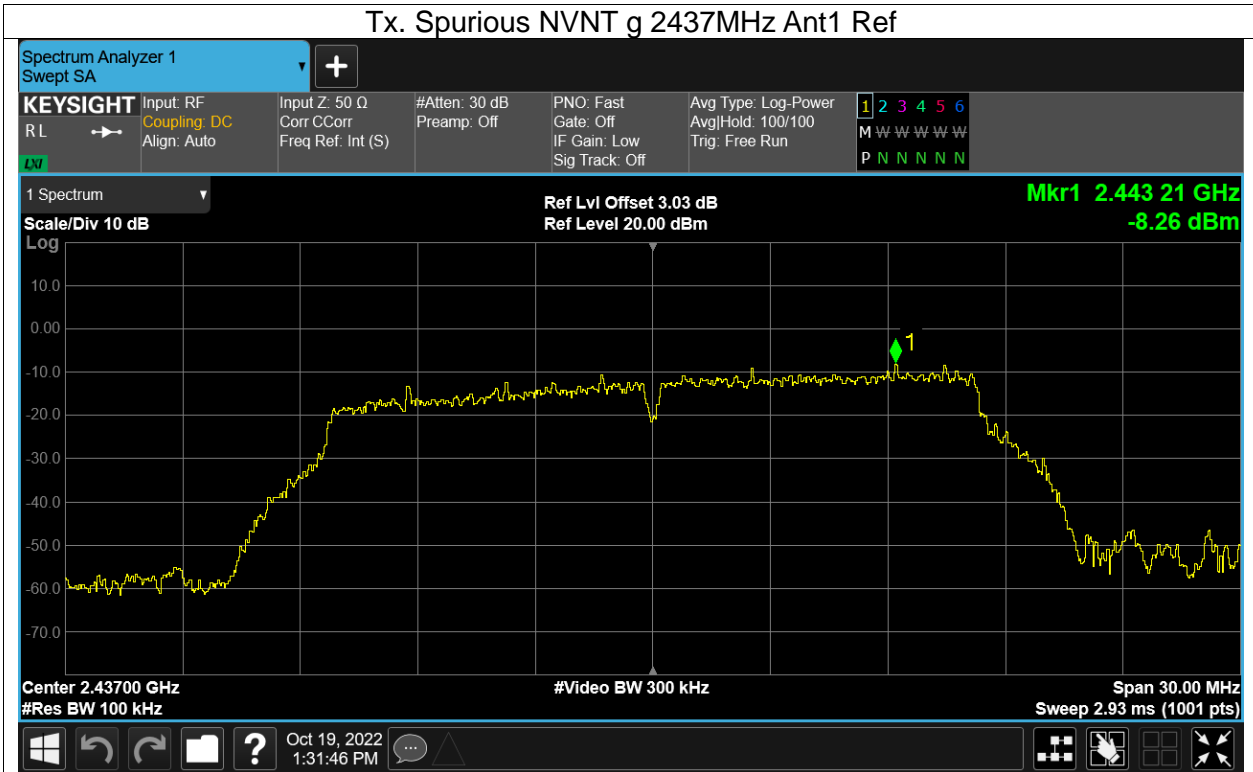

Tx. Spurious NVNT g 2437MHz Ant1 Emission

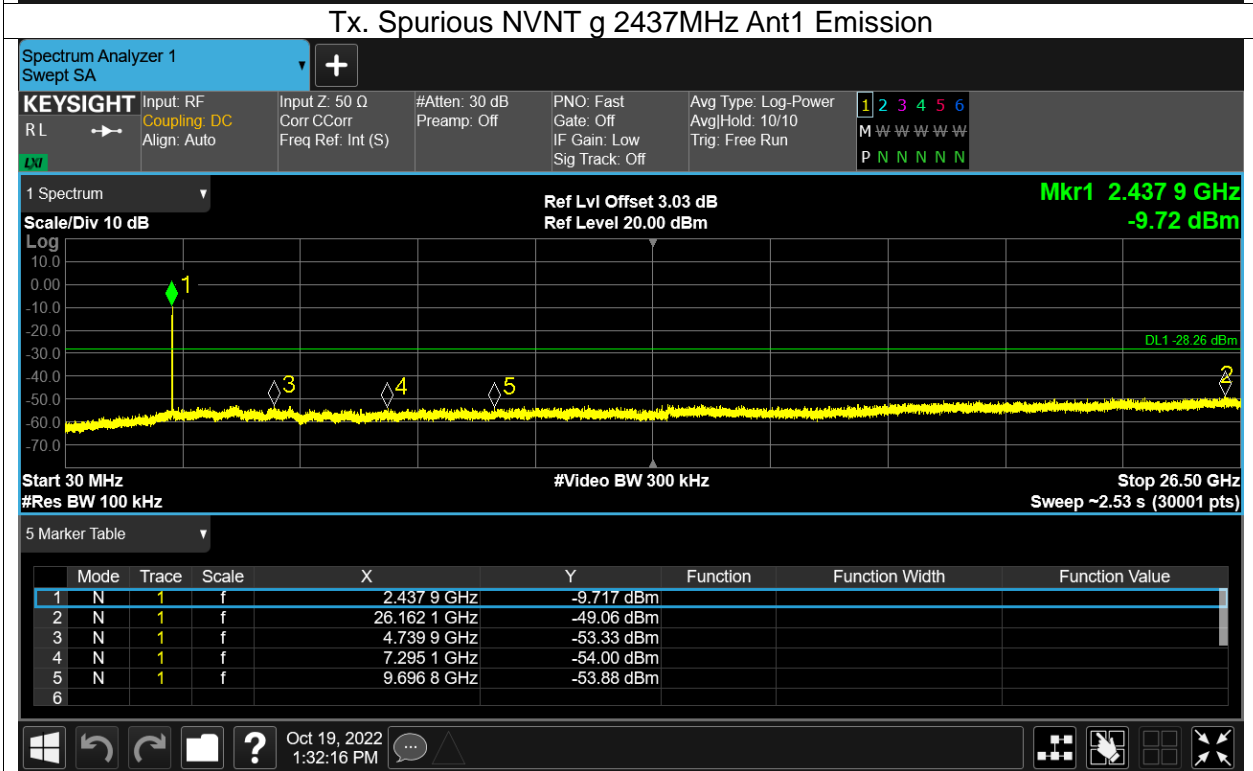



Tx. Spurious NVNT g 2462MHz Ant1 Ref

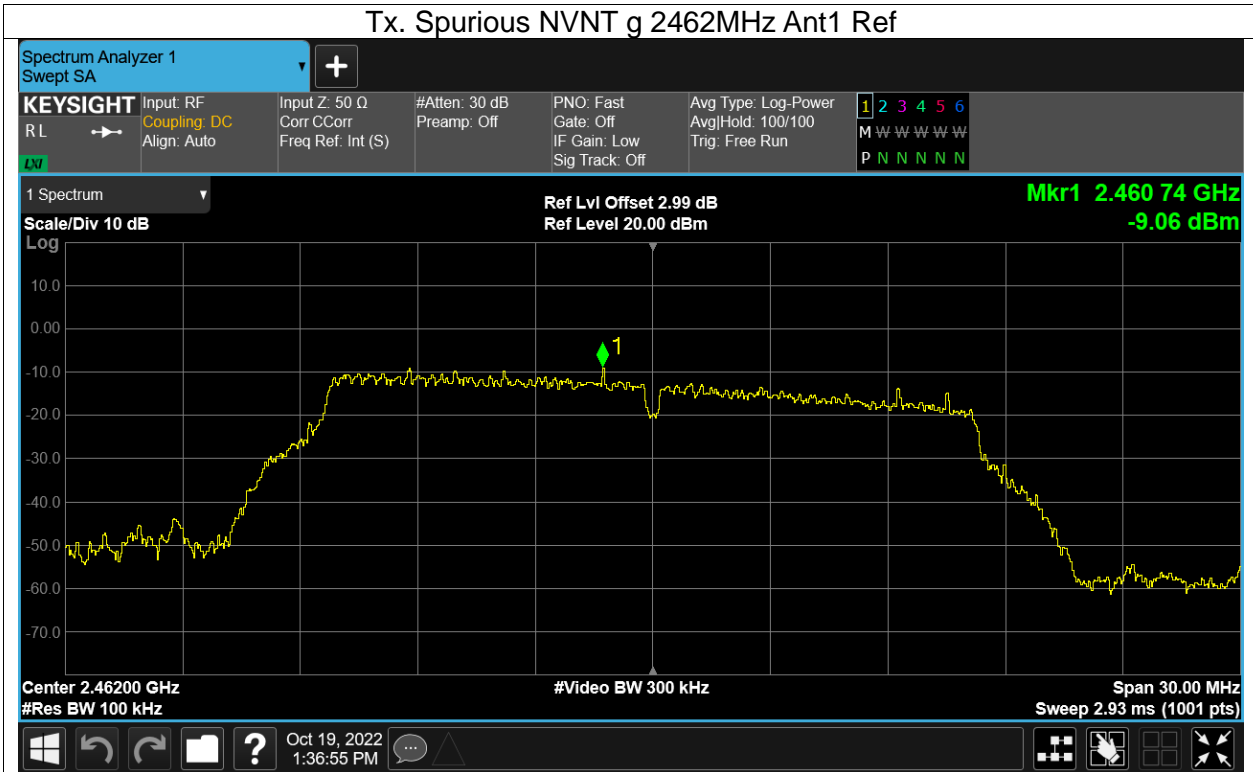

Tx. Spurious NVNT g 2462MHz Ant1 Emission

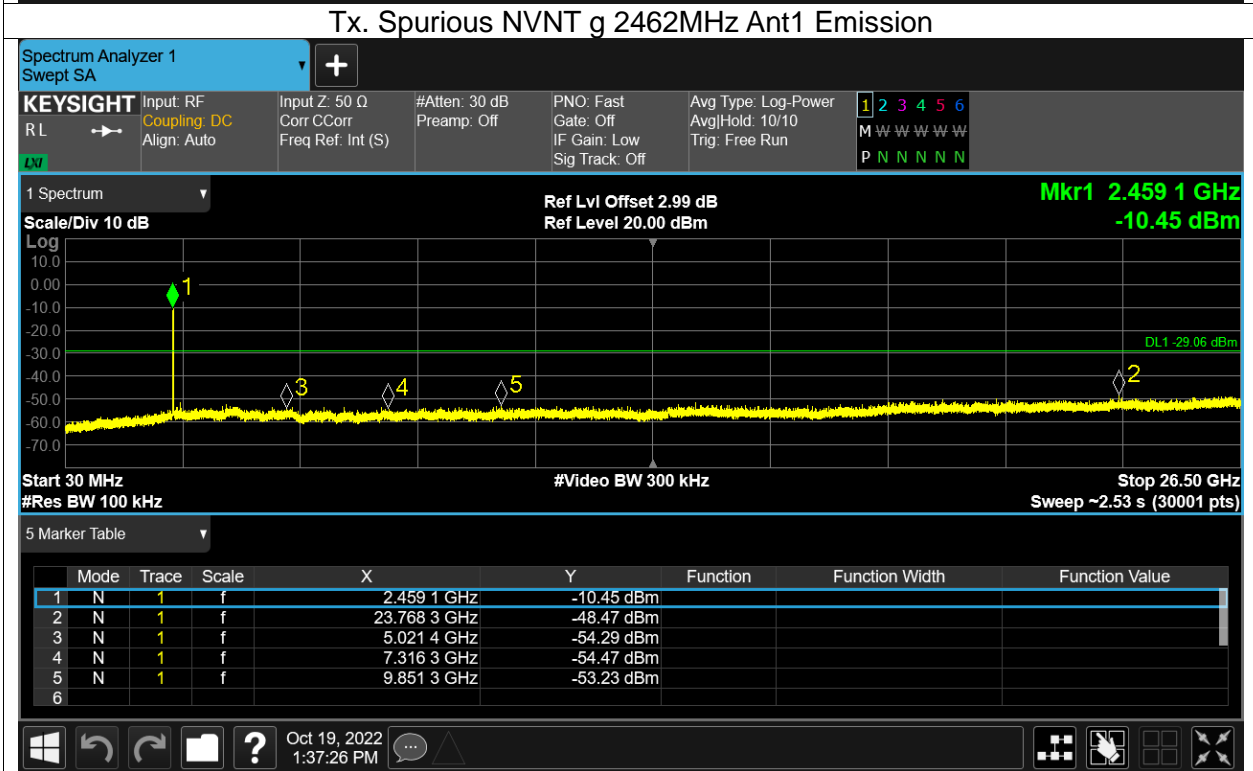



Tx. Spurious NVNT n20 2412MHz Ant1 Ref

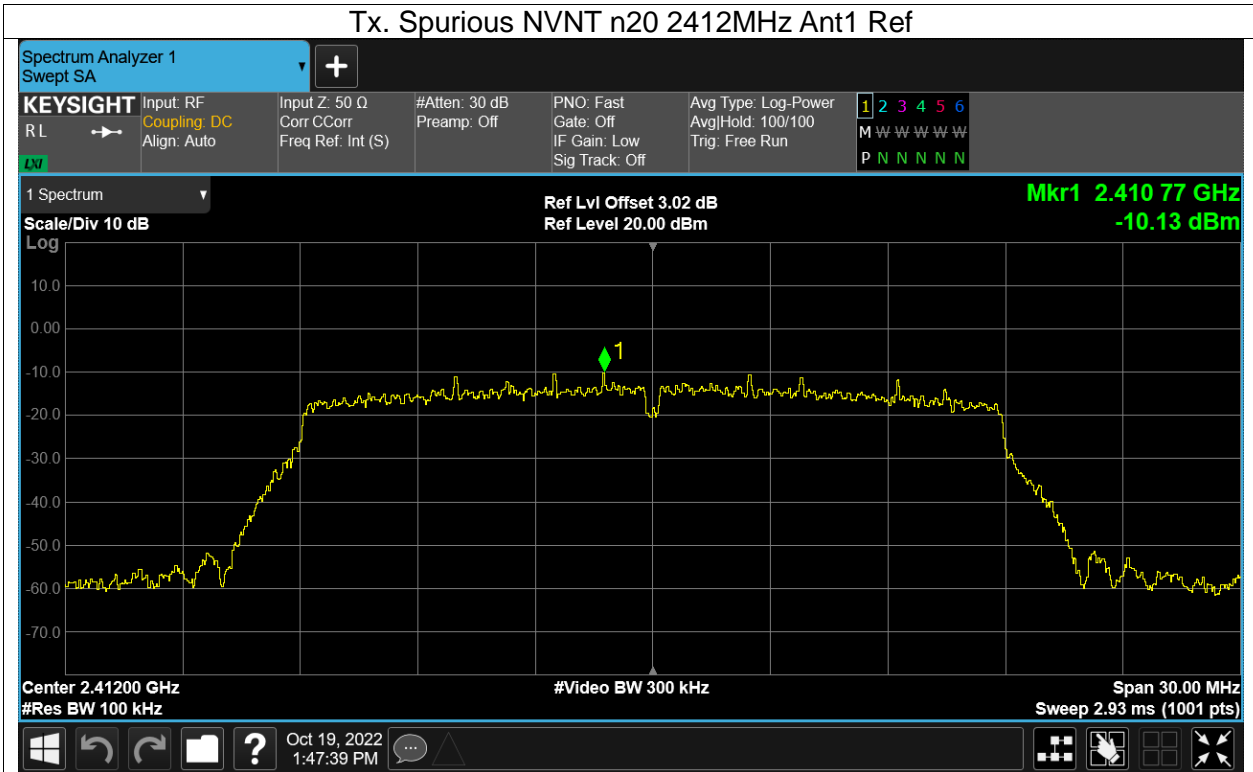

Tx. Spurious NVNT n20 2412MHz Ant1 Emission

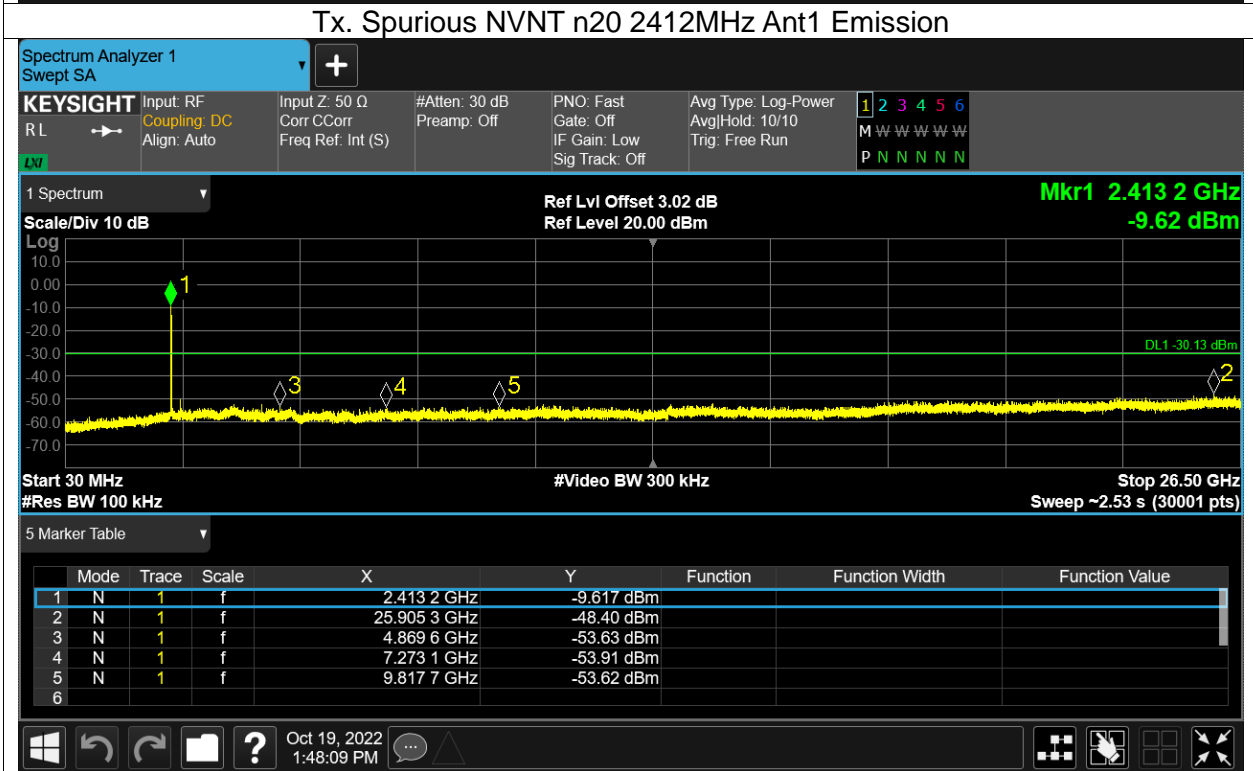



Tx. Spurious NVNT n20 2437MHz Ant1 Ref

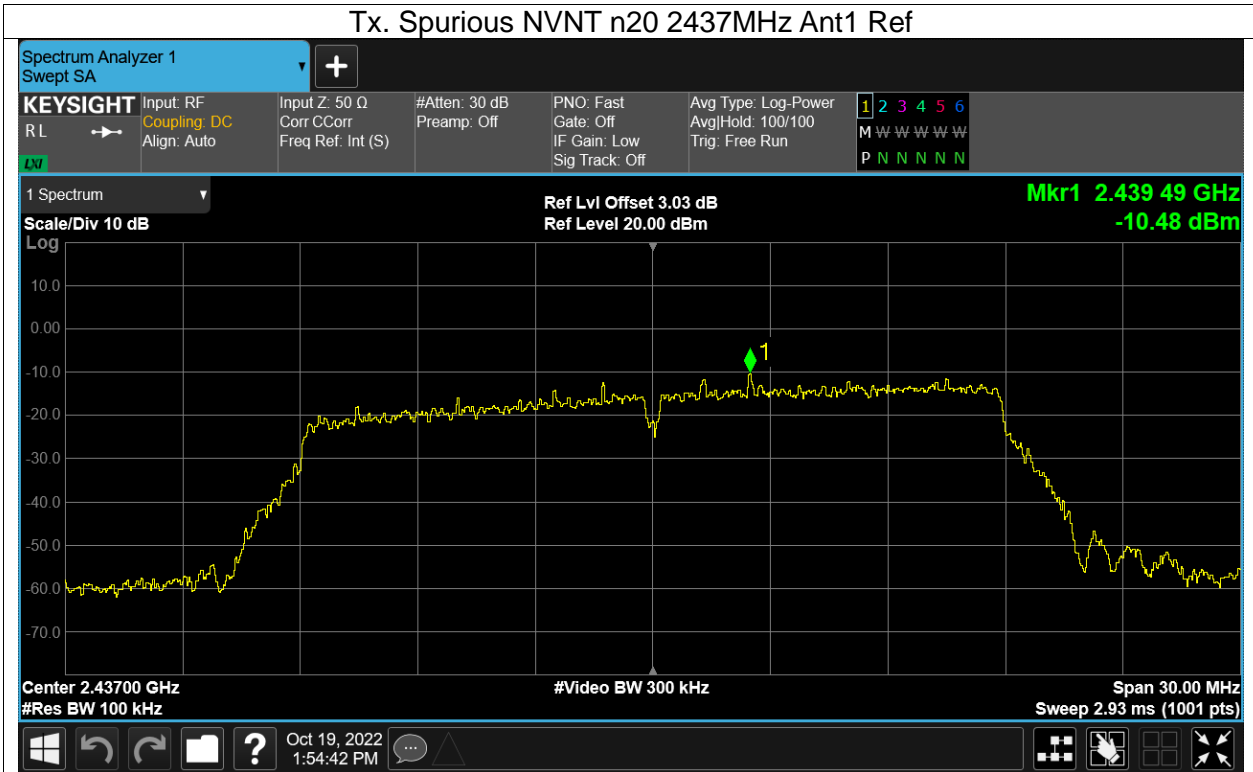

Tx. Spurious NVNT n20 2437MHz Ant1 Emission

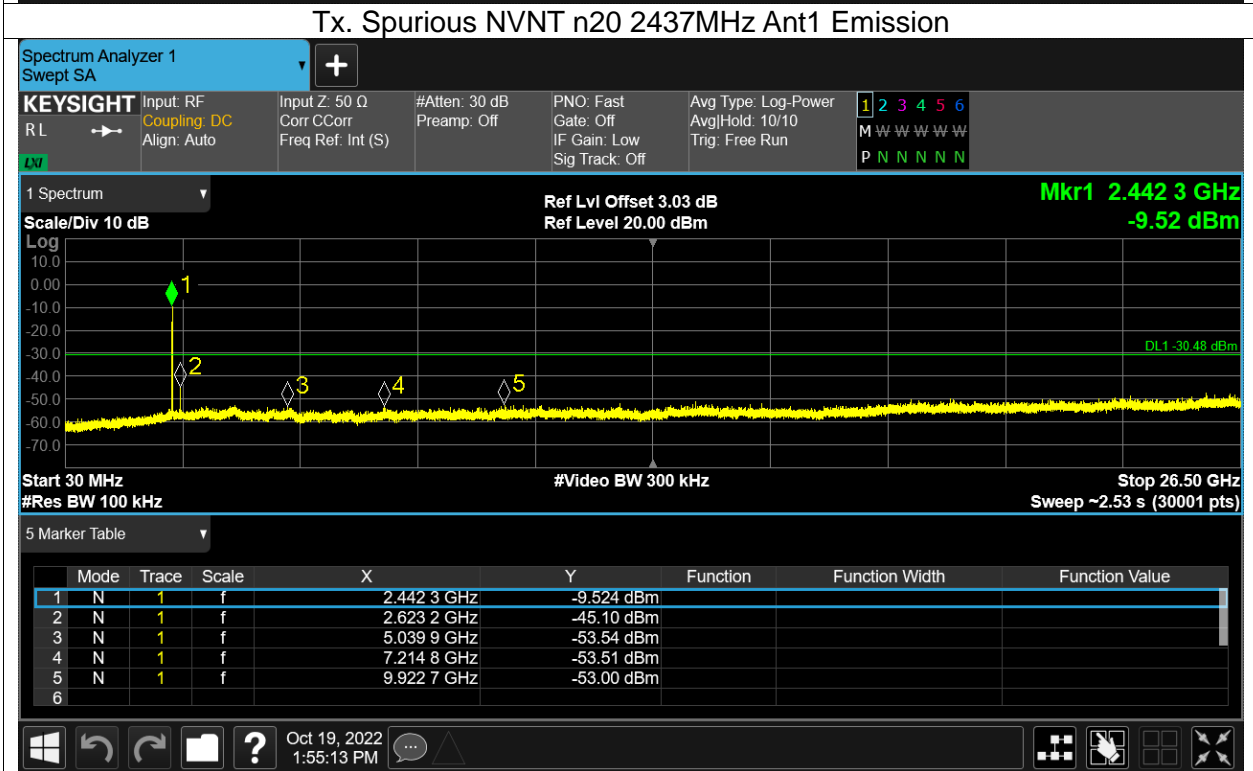



Tx. Spurious NVNT n20 2462MHz Ant1 Ref

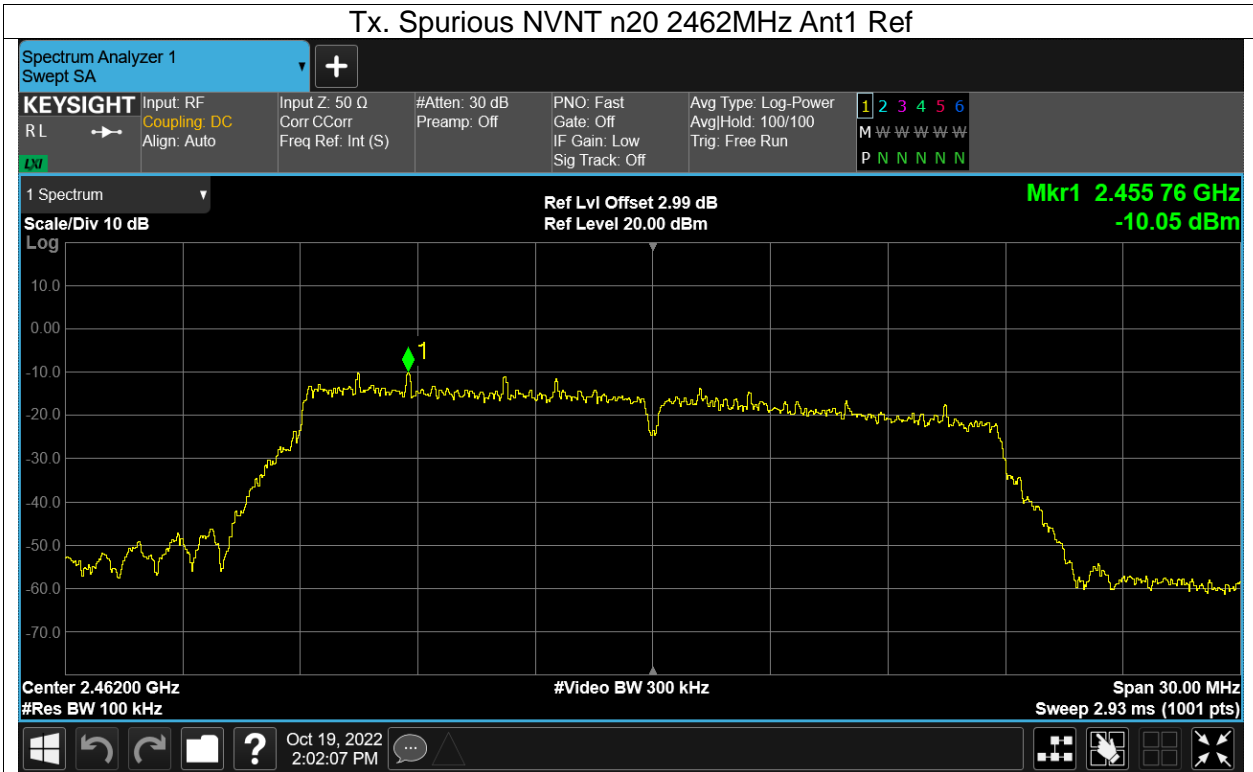

Tx. Spurious NVNT n20 2462MHz Ant1 Emission

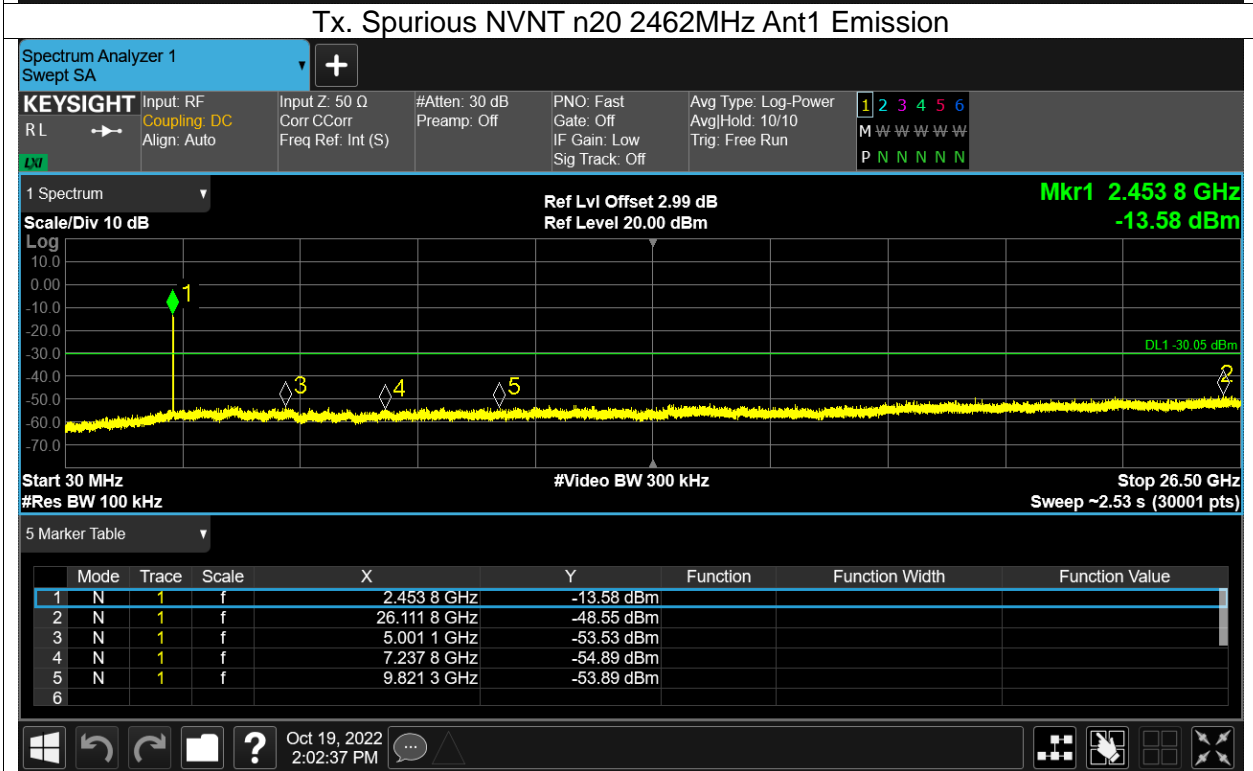



Tx. Spurious NVNT n40 2422MHz Ant1 Ref

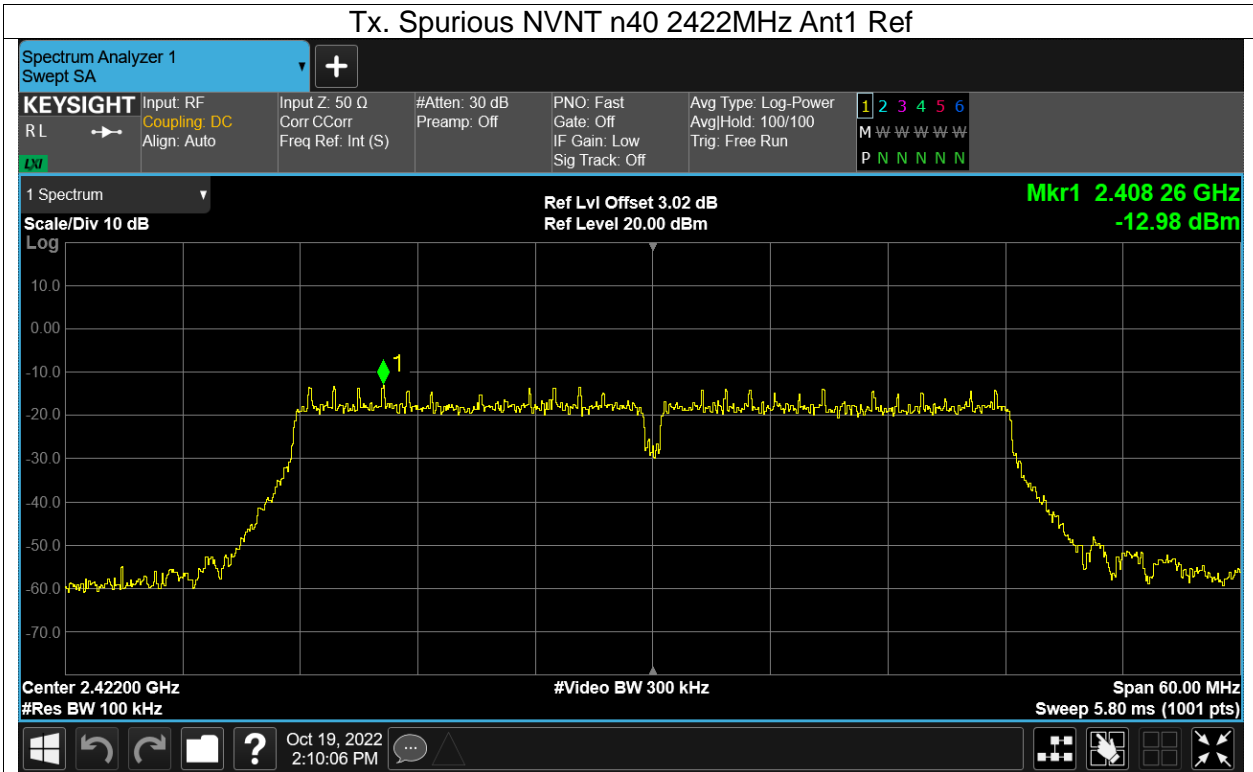

Tx. Spurious NVNT n40 2422MHz Ant1 Emission

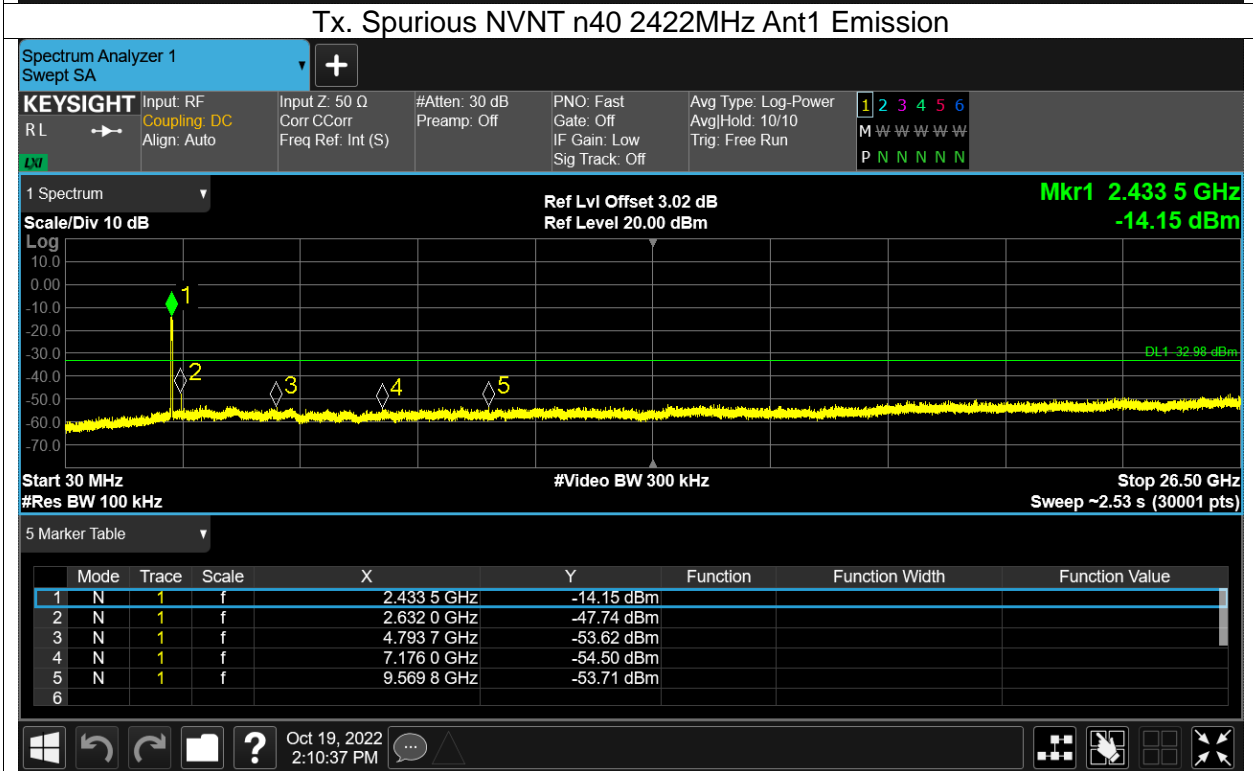



Tx. Spurious NVNT n40 2437MHz Ant1 Ref

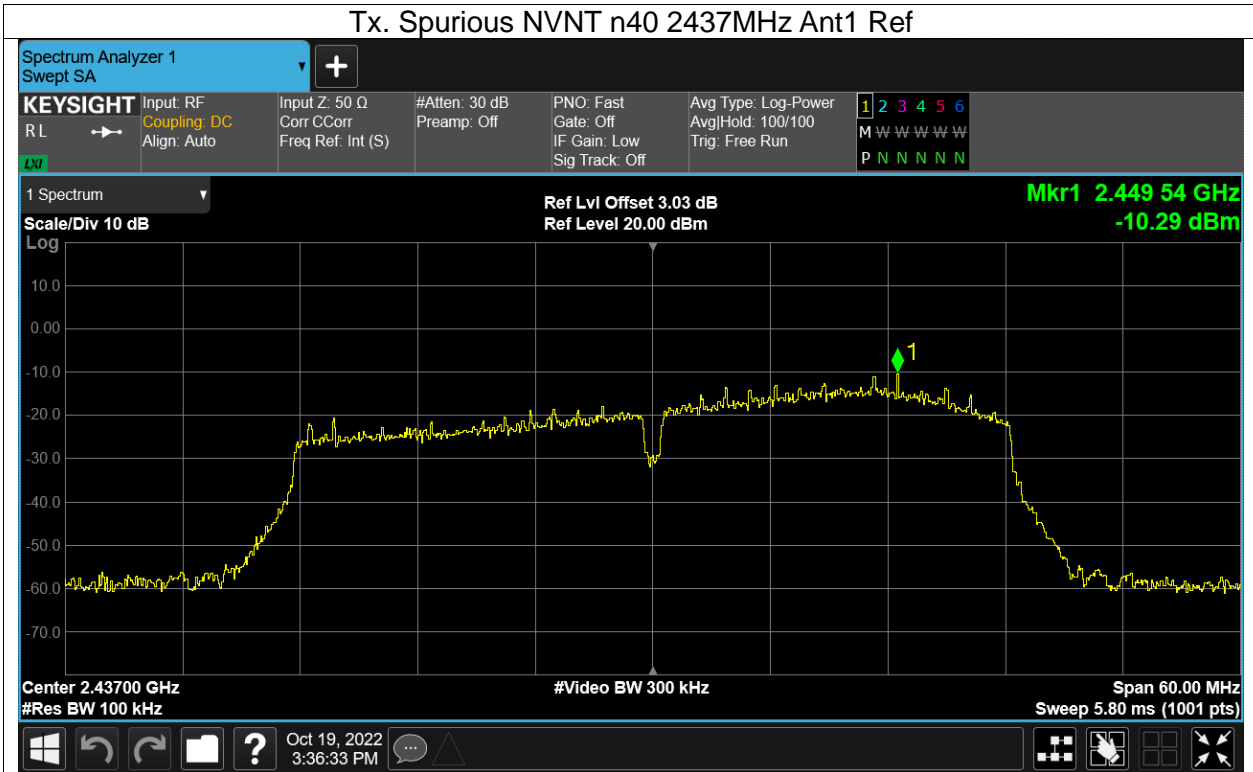

Tx. Spurious NVNT n40 2437MHz Ant1 Emission

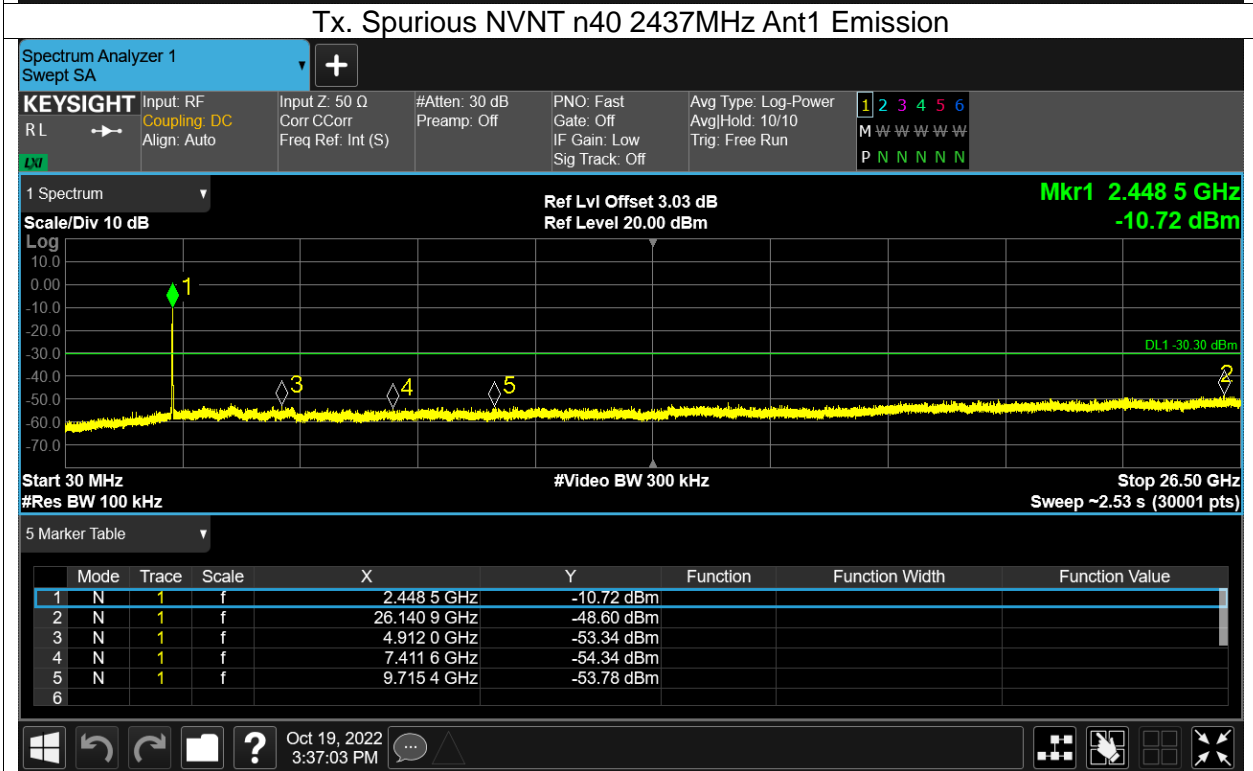



Tx. Spurious NVNT n40 2452MHz Ant1 Ref

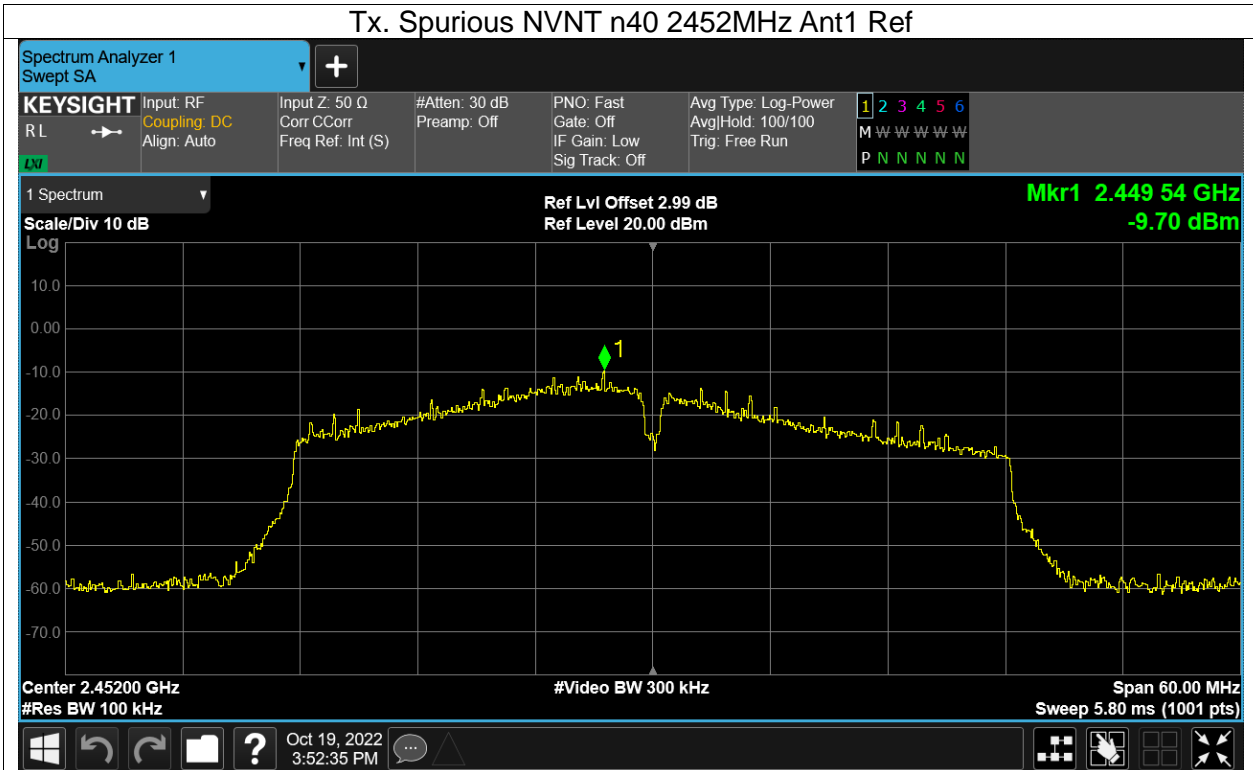

Tx. Spurious NVNT n40 2452MHz Ant1 Emission

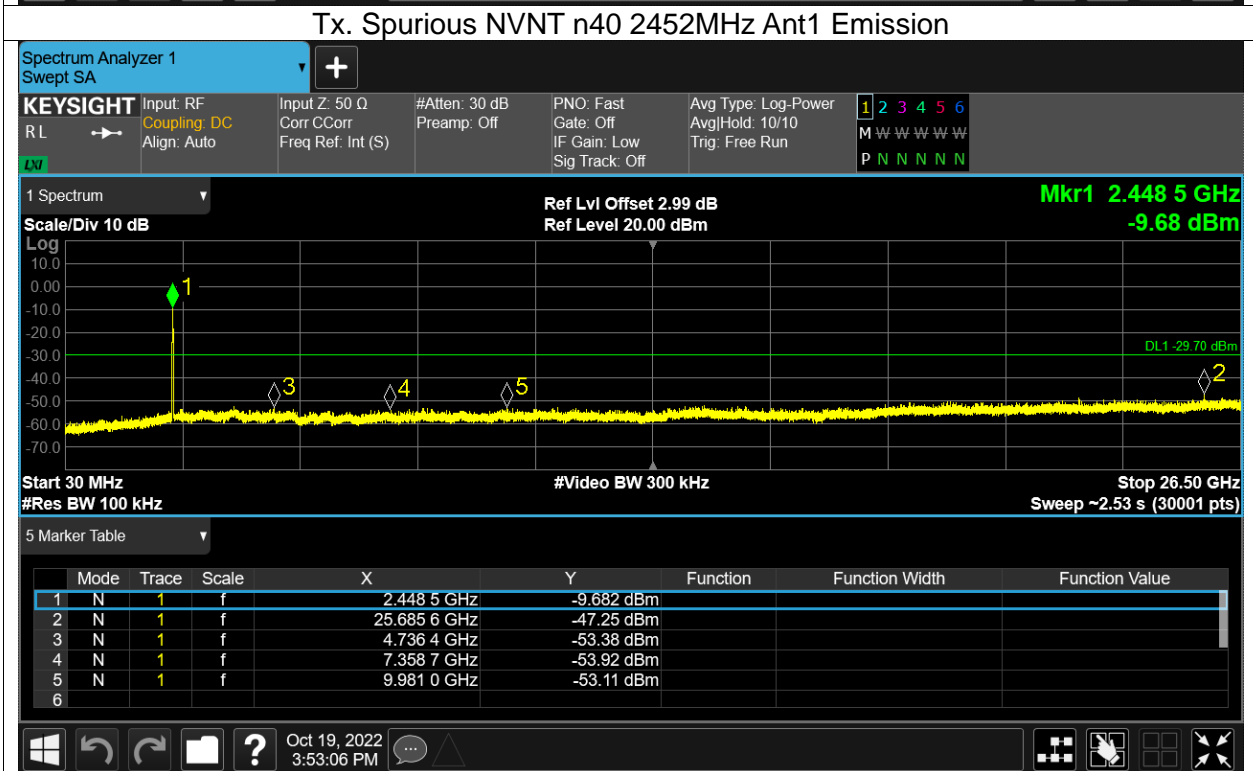

APPENDIX II:PHOTOS OF TEST SETUP

Radiated Spurious Emission Test Setup Photo - Below 1GHz



Radiated Spurious Emission Test Setup Photo - Above 1GHz





Conducted Emission Test Setup Photo



※※※※END OF THE REPORT※※※※