



RF TEST REPORT

Product Name: Smart phone

Model Name: Luna

FCC ID: 2AK6CLUNA

Issued For : Shanghai Unihertz E-Commerce Co., Ltd

Room 308, Building C, 508Chundong Rd, Minhang district
Shanghai, China 201108

Issued By : Shenzhen LGT Test Service Co., Ltd.

Room 205, Building 13, Zone B, Chen Hsong Industrial Park,
No.177 Renmin West Road, Jinsha Community, Kengzi
Street, Pingshan New District, Shenzhen, China

Report Number: LGT23B010RF20

Sample Received Date: Feb. 09, 2023

Date of Test: Feb. 09, 2023 – Mar. 13, 2023

Date of Issue: Mar. 13, 2023

The test report is effective only with both signature and specialized stamp. This report shall not be reproduced except in full without the written approval of the Laboratory. The results in this report only apply to the tested sample.



TEST REPORT CERTIFICATION

Applicant Shanghai Unihertz E-Commerce Co., Ltd
Address Room 308, Building C, 508Chundong Rd, Minhang district
Shanghai, China 201108

Manufacturer Shenzhen OBLUE Communication Technology Co., Ltd.
Address Room 702, Hepingdayou industrial and trade industrial park, No.
41, Yonghe Road, Heping Community, Fuhai Street, Baoan
District, Shenzhen City, China

Product Name Smart phone

Trademark Unihertz, iHunt, 8849

Model Name Luna

Sample Status: Normal

APPLICABLE STANDARDS	
STANDARD	TEST RESULTS
FCC Part 15.225, Subpart C ANSI C63.10-2013	PASS

Prepared by:

Zane Shan

Zane Shan
Engineer

Approved by:

Vita Li

Vita Li
Technical Director





Table of Contents

1. SUMMARY OF TEST RESULTS	6
1.1 TEST FACTORY	7
1.2 MEASUREMENT UNCERTAINTY	7
2. GENERAL INFORMATION	8
2.1 GENERAL DESCRIPTION OF THE EUT	8
2.2 DESCRIPTION OF THE TEST MODES	9
2.3 TEST SOFTWARE AND POWER LEVEL	9
2.4 BLOCK DIAGRAM SHOWING THE CONFIGURATION OF SYSTEM TESTED	10
2.5 DESCRIPTION OF NECESSARY ACCESSORIES AND SUPPORT UNITS	11
2.6 EQUIPMENTS LIST	12
3. EMC EMISSION TEST	13
3.1 CONDUCTED EMISSION MEASUREMENT	13
3.2 TEST PROCEDURE	14
3.3 TEST SETUP	14
3.4 EUT OPERATING CONDITIONS	14
3.5 TEST RESULTS	15
4. RADIATED EMISSION MEASUREMENT	17
4.1 RADIATED EMISSION LIMITS	17
4.2 TEST PROCEDURE	19
4.3 TEST SETUP	20
4.4 EUT OPERATING CONDITIONS	20
4.5 FIELD STRENGTH CALCULATION	21
4.6 TEST RESULTS	22
5. FREQUENCY TOLERANCE	27
5.1 LIMIT	27
5.2 TEST PROCEDURE	27
5.3 TEST SETUP	27
5.4 EUT OPERATION CONDITIONS	27
5.5 TEST RESULTS	28
6. 20DB BANDWIDTH	29
6.1 LIMIT	29
6.2 TEST PROCEDURE	29
6.3 TEST SETUP	29



Table of Contents

6.4 EUT OPERATION CONDITIONS	29
6.5 TEST RESULTS	30
7. ANTENNA REQUIREMENT	31
7.1 STANDARD REQUIREMENT	31
7.2 EUT ANTENNA	31
APPENDIX 1- PHOTOS OF TEST SETUP	32



Revision History

Rev.	Issue Date	Contents
00	Mar. 13, 2023	Initial Issue



1. SUMMARY OF TEST RESULTS

Test procedures according to the technical standards:

FCC Part 15.225, Subpart C			
Standard Section	Test Item	Judgment	Remark
15.207	Conducted Emission	PASS	--
15.209 15.225(a)(b)(c)(d)	Radiated Emission	PASS	--
15.225(e)	Frequency Tolerance	PASS	--
15.203	Antenna Requirement	PASS	--
15.215	20dB Bandwidth	PASS	--

NOTE:

- (1) 'N/A' denotes test is not applicable in this Test Report.
- (2) All tests are according to ANSI C63.10-2013.



1.1 TEST FACTORY

Company Name:	Shenzhen LGT Test Service Co., Ltd.
Address:	Room 205, Building 13, Zone B, Chen Hsong Industrial Park, No.177 Renmin West Road, Jinsha Community, Kengzi Street, Pingshan New District, Shenzhen, China
Accreditation Certificate	FCC Registration No.: 746540
	A2LA Certificate No.: 6727.01

1.2 MEASUREMENT UNCERTAINTY

The reported uncertainty of measurement $y \pm U$, where expanded uncertainty U is based on a standard uncertainty multiplied by a coverage factor of $k=2$, providing a level of confidence of approximately **95** %.

No.	Item	Uncertainty
1	RF output power, conducted	± 0.68 dB
2	Unwanted Emissions, conducted	± 2.988 dB
3	All emissions, radiated 9K-30MHz	± 2.84 dB
4	All emissions, radiated 30M-1GHz	± 4.39 dB
5	All emissions, radiated 1G-6GHz	± 5.10 dB
6	All emissions, radiated >6G	± 5.48 dB
7	Conducted Emission (9KHz-150KHz)	± 2.79 dB
8	Conducted Emission (150KHz-30MHz)	± 2.80 dB



2. GENERAL INFORMATION

2.1 GENERAL DESCRIPTION OF THE EUT

Product Name	Smart phone	
Trademark	Unihertz, iHunt, 8849	
Model Name	Luna	
Series Model	N/A	
Model Difference	N/A	
Product Description	The EUT is a Smart phone	
	Operation Frequency:	13.56MHz
	Modulation Type:	FSK
	Antenna Designation:	Please see Note 2.
Channel List	Please refer to the Note 2.	
Adapter	Model: HJ-FC010K7-US Input: 100~240V, 50/60Hz, 0.6A Output: 5V, 2A OR 9V, 2A OR 12V, 1.5A	
Battery	Capacity: 5000mAh Rated Voltage: 3.87V	
Hardware Version	G68_V1.1	
Software Version	Luna _2023013113	
Connecting I/O Port(s)	Please refer to the Note 1.	

Note:

1. For a more detailed features description, please refer to the manufacturer's specifications or the User Manual.
- 2.

Table for Filed Antenna

Ant.	Brand	Model Name	Antenna Type	Connector	NOTE
1	Unihertz	Luna	Coil	N/A	NFC ANT

Note: The antenna information refer the manufacturer provide report, applicable only to the tested sa-mple identified in the report.



2.2 DESCRIPTION OF THE TEST MODES

For conducted test items and radiated spurious emissions
Each of these EUT operation mode(s) or test configuration mode(s) mentioned below was evaluated respectively.

Worst Mode	Description
Mode 1	TX Mode

Note:

- (1) The measurements are performed at all Bit Rate of Transmitter, the worst data was reported.
- (2) We have be tested for all avaiable U.S. voltage and Frequency (For 120V,50/60Hz and 240V, 50/60Hz) for which the device is capable of operation, and the worst case of 120V/60Hz is shown in the report.
- (3) The battery is fully-charged during the radited and RF conducted test.

2.3 TEST SOFTWARE AND POWER LEVEL

During testing channel & power controlling software provided by the customer was used to control the operating channel as well as the output power level.



2.4 BLOCK DIAGRAM SHOWING THE CONFIGURATION OF SYSTEM TESTED

Radiated Spurious Emission Test

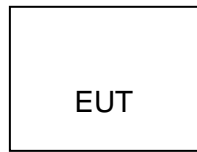

Conducted Emission Test

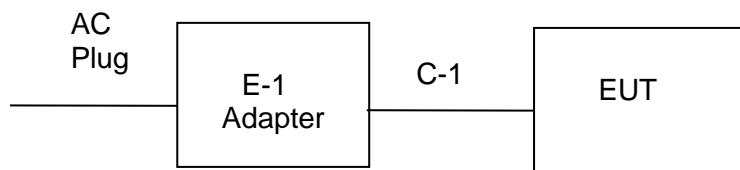



2.5 DESCRIPTION OF NECESSARY ACCESSORIES AND SUPPORT UNITS

The EUT has been tested as an independent unit together with other necessary accessories or support units. The following support units or accessories were used to form a representative test configuration during the tests.

Necessary accessories

Item	Equipment	Mfr/Brand	Model/Type No.	Length	Note
E-1	Adapter	Unihertz	HJ-FC010K7-US	N/A	N/A
C-1	USB Cable	N/A	N/A	100cm	NO

Support units

Item	Equipment	Mfr/Brand	Model/Type No.	Length	Note
N/A	N/A	N/A	N/A	N/A	N/A

Note:

- (1) For detachable type I/O cable should be specified the length in cm in 『Length』 column.
- (2) “YES” is means “with core”; “NO” is means “without core”.



2.6 EQUIPMENTS LIST

Conducted Emission					
Equipment	Manufacturer	Model No.	Serial No.	Cal. Date	Cal. Until
EMI Test Receiver	R&S	ESU8	100372	2022.04.12	2023.04.11
LISN	COM-POWER	LI-115	02032	2022.04.13	2023.04.12
LISN	Schwarzbeck	NNLK 8121	00847	2022.08.19	2023.08.18
CE Cable	N.A	C01	N.A	2022.05.05	2023.05.04
Transient Limiter	CYBERTEK	EM5010A	E2250100049	2022.08.19	2023.08.18
Temperature & Humidity	KTJ	TA218B	N.A	2022.05.05	2023.05.04
Testing Software	EMC-I_V1.4.0.3_SKET				

Radiated Emission					
Equipment	Manufacturer	Model No.	Serial No.	Cal. Date	Cal. Until
EMI Test Receiver	R&S	ESU8	100372	2022.04.12	2023.04.11
Active loop Antenna	R&S	HFH2-Z2	POS871398181	2022.06.02	2024.06.01
Spectrum Analyzer	Keysight	N9010B	MY60242508	2022.04.29	2023.04.28
Bilog Antenna	Schwarzbeck	VULB 9168	01447	2022.12.12	2024.12.11
Horn Antenna	Schwarzbeck	3115	10SL0060	2022.06.02	2024.06.01
Pre-amplifier(0.1M-3 GHz)	HP	8447D	2727A05655	2022.04.11	2023.04.10
Pre-amplifier(1-26.5 G)	Agilent	8449B	3008A4722	2022.04.13	2023.04.12
RE Cable (9K-1G)	N.A	R01	N.A	2022.05.05	2023.05.04
RE Cable (1-26G)	N.A	R02	N.A	2022.05.05	2023.05.04
Temperature & Humidity	KTJ	TA218B	N.A	2022.05.05	2023.05.04
Testing Software	EMC-I_V1.4.0.3_SKET				



3. EMC EMISSION TEST

3.1 CONDUCTED EMISSION MEASUREMENT

3.1.1 POWER LINE CONDUCTED EMISSION LIMITS

The radio frequency voltage that is conducted back onto the AC power line on any frequency or frequencies, within the band 150 kHz to 30 MHz, shall not exceed the limits in the following table.

FREQUENCY (MHz)	Class B (dBuV)		Standard
	Quasi-peak	Average	
0.15 -0.5	66 - 56 *	56 - 46 *	FCC
0.50 -5.0	56.00	46.00	FCC
5.0 -30.0	60.00	50.00	FCC

Note:

- (1) The tighter limit applies at the band edges.
- (2) The limit of " * " marked band means the limitation decreases linearly with the logarithm of the frequency in the range.

The following table is the setting of the receiver

Receiver Parameters	Setting
Attenuation	10 dB
Start Frequency	0.15 MHz
Stop Frequency	30 MHz
IF Bandwidth	9 kHz



3.2 TEST PROCEDURE

- a. The EUT is 0.8 m from the horizontal ground plane and 0.4 m from the vertical ground plane with EUT being connected to the power mains through a line impedance stabilization network (LISN). All other support equipments are powered from additional LISN(s). The LISN provides 50 Ohm/ 50uH of coupling impedance for the measuring instrument.
- b. Interconnecting cables that hang closer than 40 cm to the ground plane shall be folded back and forth in the center forming a bundle 30 to 40 cm long.
- c. I/O cables that are not connected to a peripheral shall be bundled in the center. The end of the cable may be terminated, if required, using the correct terminating impedance. The overall length shall not exceed 1 m.
- d. LISN at least 80 cm from nearest part of EUT chassis.
- e. For the actual test configuration, please refer to the related Item –EUT Test Photos.

3.3 TEST SETUP

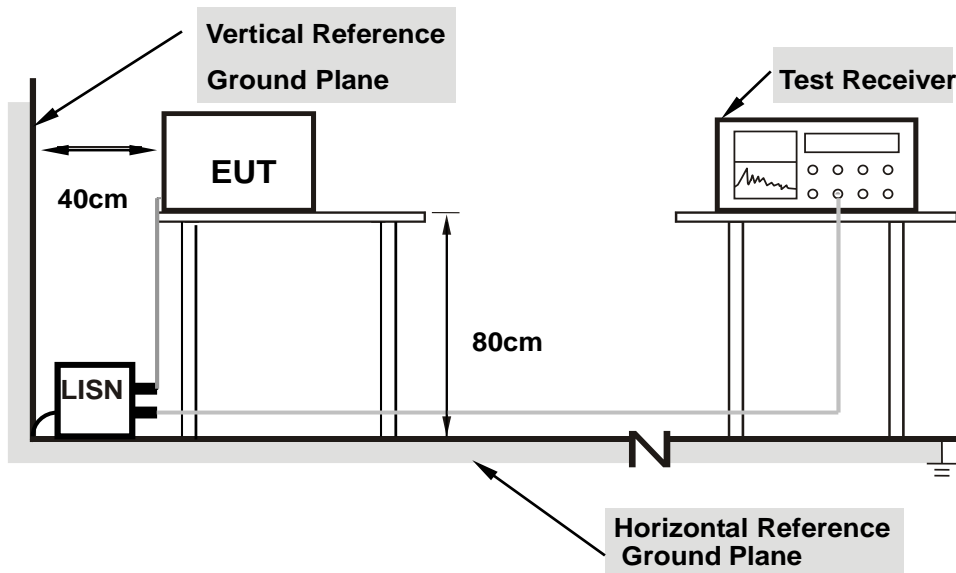

Note: 1. Support units were connected to second LISN.

2. Both of LISNs (AMN) are 80 cm from EUT and at least 80 cm from other units and other metal planes support.

3.4 EUT OPERATING CONDITIONS

The EUT was configured for testing in a typical fashion (as a customer would normally use it). The EUT has been programmed to continuously transmit during test. This operating condition was tested and used to collect the included data.



3.5 TEST RESULTS

Project: LGT23B010	Test Engineer: Dylan.shi
EUT: Smart phone	Temperature: 22.2°C
M/N: Luna	Humidity: 55%RH
Test Voltage: AC 120V/60Hz	Test Data: 2023-02-18
Test Mode: NFC	
Note:	

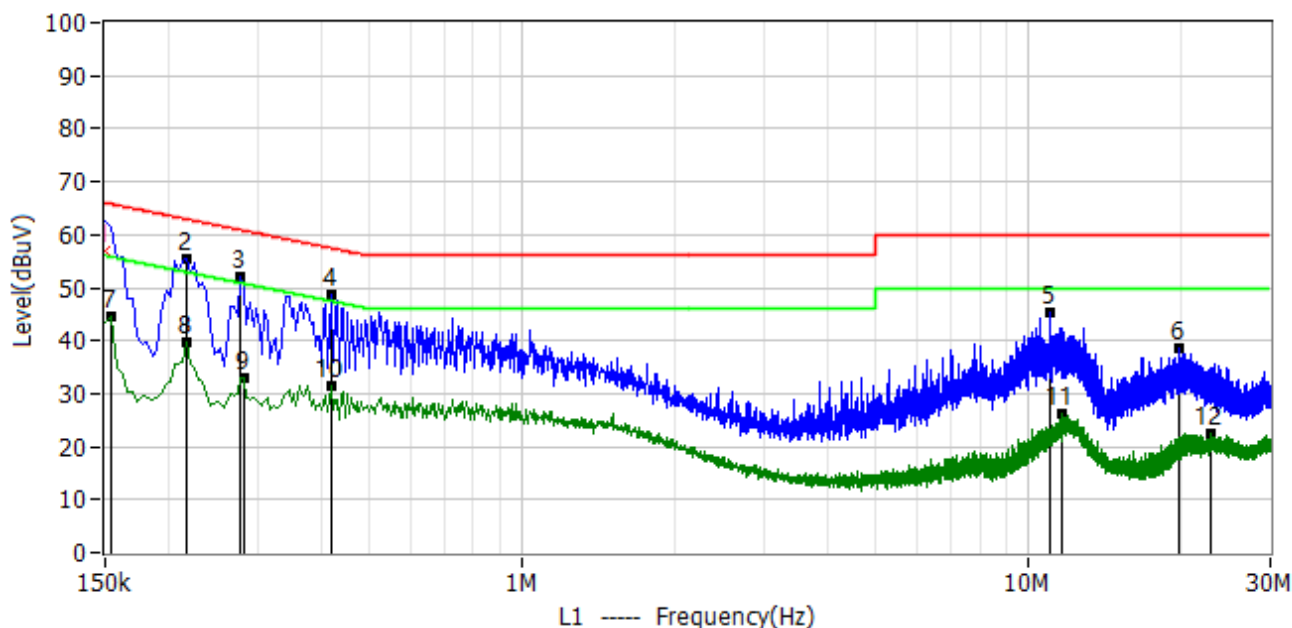

No.	Frequency	Reading dBuV	Factor dB	Level dBuV	Limit dBuV	Margin dB	Detector	Polar
1	150.000kHz	46.42	10.50	56.92	66.00	-9.08	QP	L1
2*	218.000kHz	45.01	10.50	55.51	62.89	-7.38	PK	L1
3*	278.000kHz	41.62	10.50	52.12	60.88	-8.76	PK	L1
4*	418.000kHz	38.10	10.50	48.60	57.49	-8.89	PK	L1
5*	10.978MHz	34.30	10.97	45.27	60.00	-14.73	PK	L1
6*	19.770MHz	27.44	11.09	38.53	60.00	-21.47	PK	L1
7*	154.000kHz	33.97	10.50	44.47	55.78	-11.31	AV	L1
8*	218.000kHz	29.19	10.50	39.69	52.89	-13.21	AV	L1
9*	282.000kHz	22.48	10.50	32.98	50.76	-17.78	AV	L1
10*	418.000kHz	21.06	10.50	31.56	47.49	-15.93	AV	L1
11*	11.606MHz	15.18	10.98	26.16	50.00	-23.84	AV	L1
12*	22.906MHz	11.21	11.17	22.38	50.00	-27.62	AV	L1



Project: LGT23B010	Test Engineer: Dylan.shi
EUT: Smart phone	Temperature: 22.2°C
M/N: Luna	Humidity: 55%RH
Test Voltage: AC 120V/60Hz	Test Data: 2023-02-18
Test Mode: NFC	
Note:	

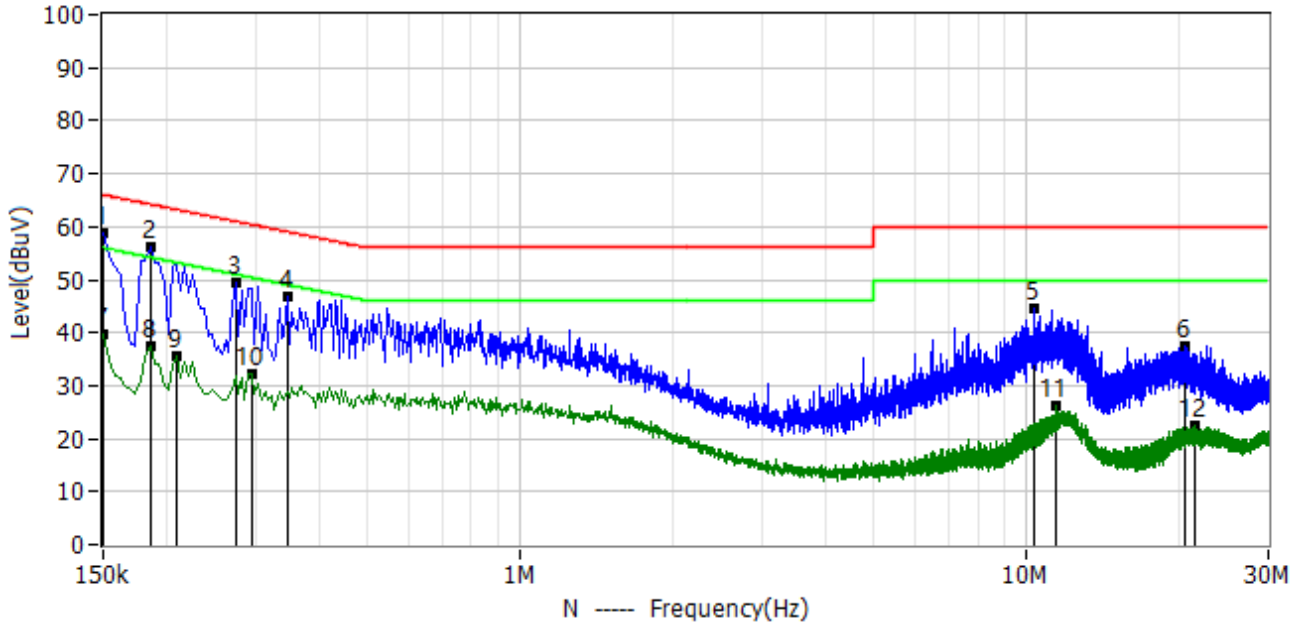

No.	Frequency	Reading dBuV	Factor dB	Level dBuV	Limit dBuV	Margin dB	Detector	Polar
1*	150.000kHz	48.28	10.50	58.78	66.00	-7.22	PK	N
2*	186.000kHz	45.54	10.50	56.04	64.21	-8.17	PK	N
3*	274.000kHz	38.76	10.50	49.26	61.00	-11.74	PK	N
4*	346.000kHz	36.37	10.50	46.87	59.06	-12.19	PK	N
5*	10.346MHz	33.48	10.97	44.45	60.00	-15.55	PK	N
6*	20.462MHz	26.20	11.11	37.31	60.00	-22.69	PK	N
7*	150.000kHz	29.08	10.50	39.58	56.00	-16.42	AV	N
8*	186.000kHz	27.00	10.50	37.50	54.21	-16.71	AV	N
9*	210.000kHz	25.14	10.50	35.64	53.21	-17.57	AV	N
10*	294.000kHz	21.71	10.50	32.21	50.41	-18.20	AV	N
11*	11.386MHz	15.25	10.99	26.24	50.00	-23.76	AV	N
12*	21.454MHz	11.25	11.13	22.38	50.00	-27.62	AV	N



4. RADIATED EMISSION MEASUREMENT

4.1 RADIATED EMISSION LIMITS

- (a) The field strength of any emissions within the band 13.553-13.567 MHz shall not exceed 15,848 microvolts/meter at 30 meters.
- (b) Within the bands 13.410-13.553 MHz and 13.567-13.710 MHz, the field strength of any emissions shall not exceed 334 microvolts/meter at 30 meters.
- (c) Within the bands 13.110-13.410 MHz and 13.710-14.010 MHz the field strength of any emissions shall not exceed 106 microvolts/meter at 30 meters.
- (d) The field strength of any emissions appearing outside of the 13.110-14.010 MHz band shall not exceed the general radiated emission limits in §15.209.

(Radiated Emission <30MHz (9KHz-30MHz, H-field)

According to FCC section 15.225, for <30MHz, Radiated emissions were measured according to ANSIC63.4. The EUT was set to transmit at the highest output power. The EUT was set 30 meter away from the measuring antenna. The loop antenna was positioned 1 meter above the ground from the center of the loop. The measuring bandwidth was set to 10KHz. (Note: During testing the receive antenna was rotated about its axis to maximize the emission from the EUT)

There was no detected Restricted bands and Radiated suprious emission below 30MHz. The 30m limit was converted to 3m Limit using square factor(x) as it was found by measurements as follows;

$$3 \text{ m Limit(dBuV/m)} = 20\log(X)+40\log(30/3)= 20\log(15,848)+40\log(30/3) =124\text{dBuV}$$

$$3 \text{ m Limit(dBuV/m)} = 20\log(X)+40\log(30/3)= 20\log(334)+40\log(30/3) =90.47\text{dBuV}$$

$$3 \text{ m Limit(dBuV/m)} = 20\log(X)+40\log(30/3)= 20\log(106)+40\log(30/3) =80.506\text{dBuV}$$

$$3 \text{ m Limit(dBuV/m)} = 20\log(X)+40\log(30/3)= 20\log(30)+40\log(30/3) =69.54\text{dBuV}$$

Except as provided elsewhere in this Subpart, the emissions from an intentional radiator shall not exceed the field strength levels specified in the following table:

LIMITS OF RADIATED EMISSION MEASUREMENT (Frequency Range 9kHz-1000MHz)

Frequency range (KHz)	Frequency (KHz)	Field Strength@300m		Field Strength@3m
		µV/m	dBµV/m	dBµV/m
9 ~ 490	9	266.67	48.52	128.52
	150	16.00	24.08	104.08
	490	4.90	13.80	93.80

Frequency range (KHz)	Frequency (KHz)	Field Strength@30m		Field Strength@3m
		µV/m	dBµV/m	dBµV/m
490 ~ 1705	490	48.98	33.80	73.80
	1705	14.08	22.97	62.97

Frequency range (KHz)	Frequency (KHz)	Field Strength@30m		Field Strength@3m
		µV/m	dBµV/m	dBµV/m
1705 ~ 30000	1705	30.00	29.54	69.54
	30000	30.00	29.54	69.54



Frequency range (MHz)	Field Strength@30m		Field Strength@3m
	$\mu\text{V/m}$	$\text{dB}\mu\text{V/m}$	$\text{dB}\mu\text{V/m}$
13.110 ~ 13.410	106	40.5	80.5
13.410 ~ 13.553	334	50.5	90.5
13.553 ~13.567	15.848	84	124.0
13.567 ~ 13.710	334	50.5	90.5
13.710 ~14.010	106	40.5	80.5

NOTE:

- a) Field Strength ($\text{dB}\mu\text{V/m}$) = $20 \cdot \log[\text{Field Strength } (\mu\text{V/m})]$.
- b) In the emission tables above, the tighter limit applies at the Band edge.
 Radiated Emission >30MHz (30MHz-1GHz, E-field)
 According to FCC section 15.205, the field strength of radiated emissions from intentional radiators at a distance of 3 meters shall not exceed the following values:

Frequencies (MHz)	Field Strength (micorvolts/meter)	Measurement Distance (meters)
30~88	100	3
88~216	150	3
216~960	200	3
Above 960	500	3

Receiver Parameter	Setting
Attenuation	Auto
Start ~ Stop Frequency	9kHz~90kHz / RB 200Hz for PK & AV
Start ~ Stop Frequency	90kHz~110kHz / RB 200Hz for QP
Start ~ Stop Frequency	110kHz~490kHz / RB 200Hz for PK & AV
Start ~ Stop Frequency	490kHz~30MHz / RB 9kHz for QP
Start ~ Stop Frequency	30MHz~1000MHz / RB 120kHz for QP



4.2 TEST PROCEDURE

- a. The test is performed in a 3m Semi-Anechoic Chamber; the antenna factor, cable loss and so on of the site (factors) is calculated to correct the reading. The EUT is placed on a 0.8m high insulating Turn Table, and keeps 3m away from the Test Antenna, which is mounted on a variable-height antenna master tower. For the test Antenna
- b. In the frequency range of 9KHz to 30MHz, magnetic field is measured with Loop Test Antenna. The Test Antenna is positioned with its plane vertical at 1m distance from the EUT. The center of the Loop Test Antenna is 1m above the ground. During the measurement the Loop Test Antenna rotates about its vertical axis for maximum response at each azimuth about the EUT.
- c. In the frequency range above 30MHz, Bi-Log Test Antenna (30MHz to 1GHz) used. Test Antenna is 3m away from the EUT. Test Antenna height is varied from 1m to 4m above the ground to determine the maximum value of the field strength. The emission levels at both horizontal and vertical polarizations should be tested.
- f. The initial step in collecting conducted emission data is a spectrum analyzer peak detector mode pre-scanning the measurement frequency range. Significant peaks are then marked and then Quasi Peak detector mode re-measured.
- g. If the Peak Mode measured value compliance with and lower than Quasi Peak Mode Limit, the EUT shall be deemed to meet QP Limits and then no additional QP Mode measurement performed.
- h. For the actual test configuration, please refer to the related Item –EUT Test Photos.

NOTE:

Both horizontal and vertical antenna polarities were tested and performed pretest to three orthogonal axis. The worst case emissions were reported

4.3 TEST SETUP

(A) Radiated Emission Test-Up Frequency Below 30MHz

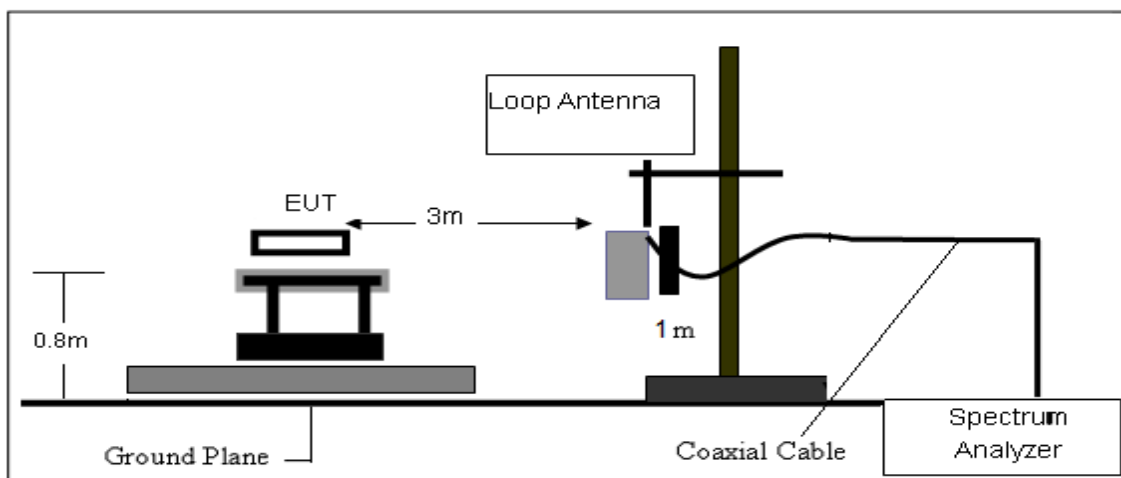

(B) Radiated Emission Test-Up Frequency 30MHz~1GHz

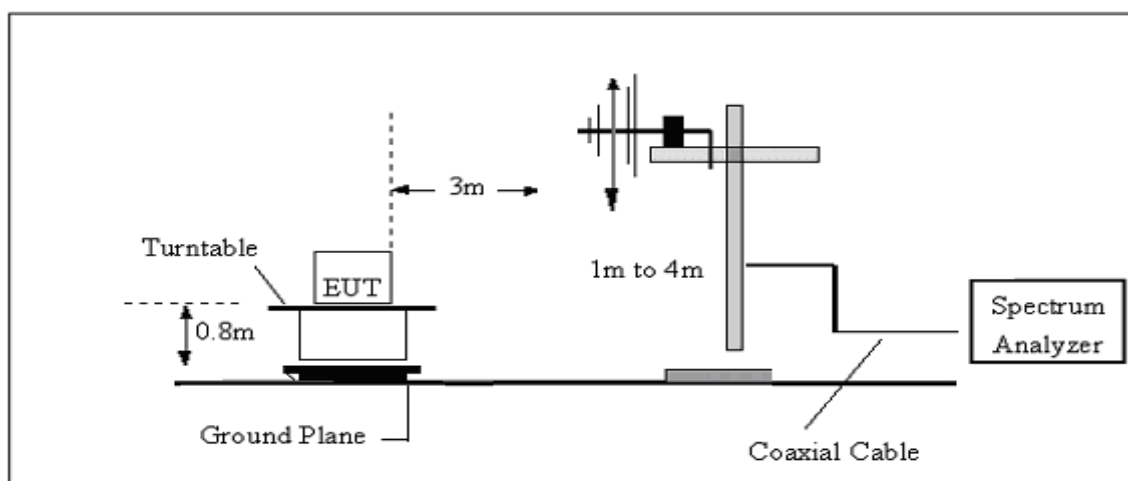

4.4 EUT OPERATING CONDITIONS

Please refer to section 3.4 of this report.



4.5 FIELD STRENGTH CALCULATION

The field strength is calculated by adding the Antenna Factor and Cable Factor and subtracting the Amplifier Gain and Duty Cycle Correction Factor (if any) from the measured reading. The basic equation with a sample calculation is as follows:

$$FS = RA + AF + CL - AG$$

Where

FS = Field Strength

CL = Cable Attenuation Factor (Cable Loss)

RA = Reading Amplitude

AG = Amplifier Gain

AF = Antenna Factor

For example

Frequency	FS	RA	AF	CL	AG	Factor
(MHz)	(dB μ V/m)	(dB μ V/m)	(dB)	(dB)	(dB)	(dB)
300	40	58.1	12.2	1.6	31.9	-18.1

$$\text{Factor} = \text{AF} + \text{CL} - \text{AG}$$



4.6 TEST RESULTS

(Radiated Emission<30MHz (9KHz-30MHz, H-field))

9KHz-150KHz

Project: LGT23B010	Test Engineer: Dylan.shi
EUT: Smart phone	Temperature: 20.7°C
M/N: Luna	Humidity: 56%RH
Test Voltage: Battery	Test Data: 2023-02-24
Test Mode: RFID Operating	
Note:	

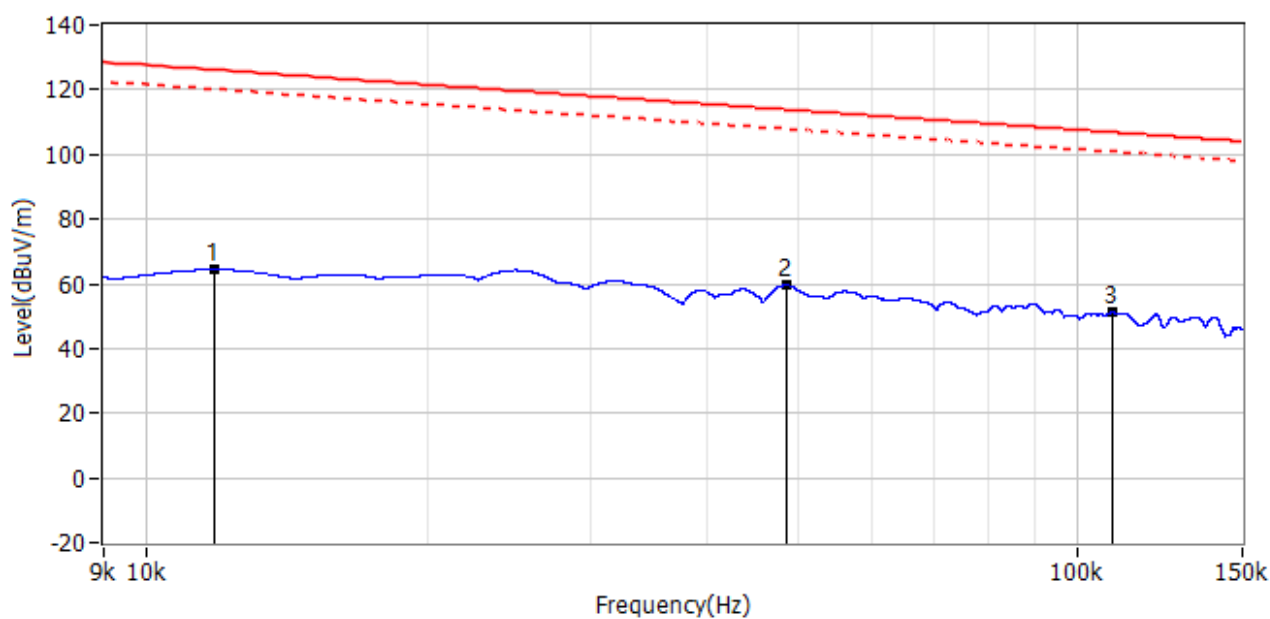

No.	Frequency	Reading dBuV	Factor dB/m	Level dBuV/m	Limit dBuV/m	Margin dB	Detector
1*	11.820kHz	42.82	21.57	64.39	126.15	-61.76	PK
2*	48.586kHz	38.30	21.21	59.51	113.87	-54.36	PK
3*	108.652kHz	29.80	21.28	51.08	106.88	-55.80	PK



Project: LGT23B010	Test Engineer: Dylan.shi
EUT: Smart phone	Temperature: 20.7°C
M/N: Luna	Humidity: 56%RH
Test Voltage: Battery	Test Data: 2023-02-24
Test Mode: RFID Operating	
Note:	

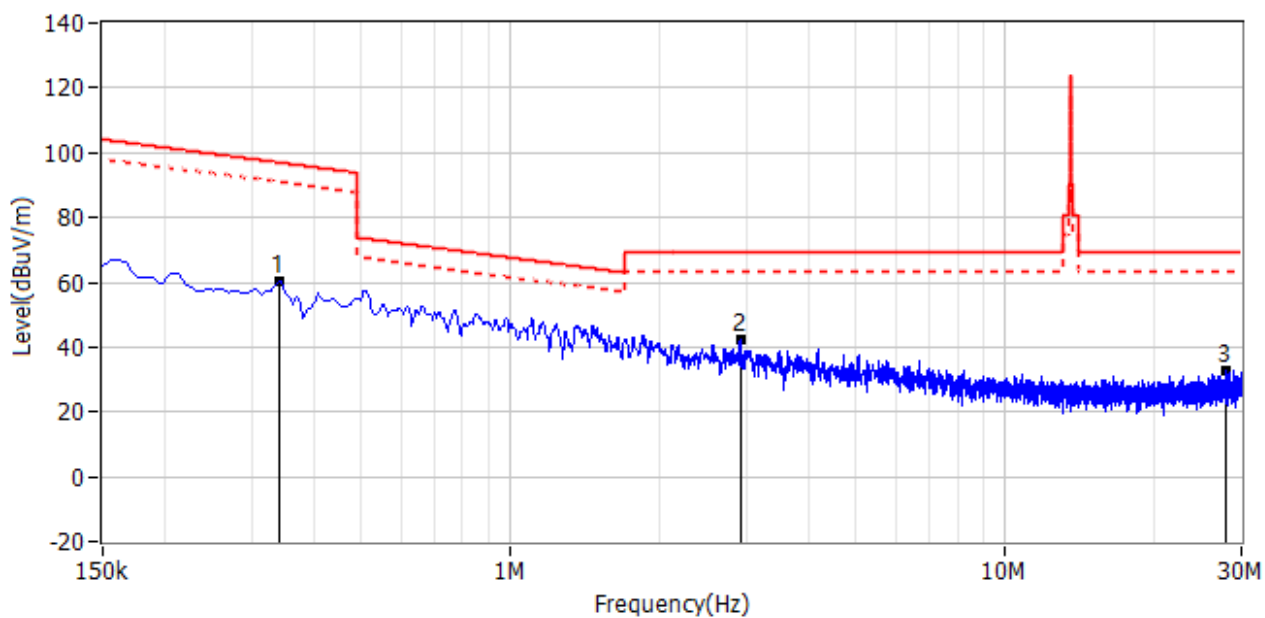

No.	Frequency	Reading dBuV	Factor dB/m	Level dBuV/m	Limit dBuV/m	Margin dB	Detector
1*	340.294kHz	38.50	21.60	60.10	96.97	-36.87	PK
2*	2.911MHz	21.01	21.32	42.33	69.54	-27.21	PK
3*	27.873MHz	10.43	22.39	32.82	69.54	-36.72	PK



Project: LGT23B010	Test Engineer: Dylan.shi
EUT: Smart phone	Temperature: 20.7°C
M/N: Luna	Humidity: 56%RH
Test Voltage: Battery	Test Data: 2023-02-24
Test Mode: RFID Operating	
Note:	

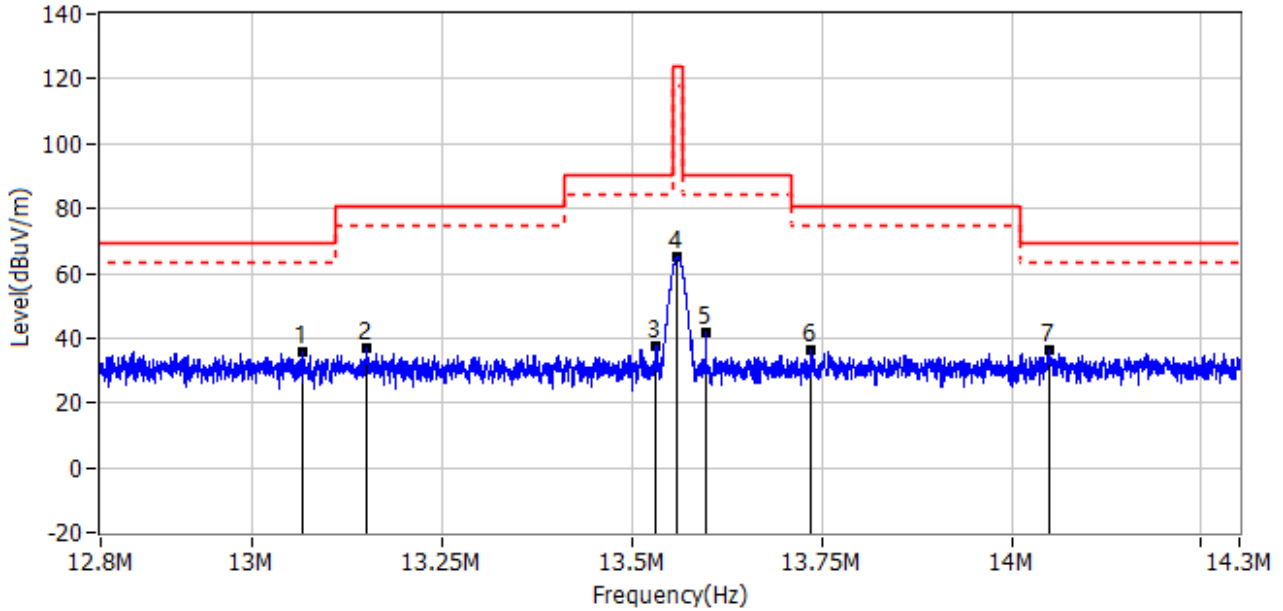

No.	Frequency	Reading dBuV	Factor dB/m	Level dBuV/m	Limit dBuV/m	Margin dB	Detector
1*	13.066MHz	14.57	21.21	35.78	69.54	-33.76	PK
2*	13.150MHz	16.01	21.21	37.22	80.50	-43.28	PK
3*	13.532MHz	16.16	21.25	37.41	90.50	-53.09	PK
4*	13.560MHz	43.95	21.26	65.21	124.00	-58.79	PK
5*	13.598MHz	20.59	21.26	41.85	90.50	-48.65	PK
6*	13.736MHz	14.86	21.27	36.13	80.50	-44.37	PK
7*	14.049MHz	15.01	21.30	36.31	69.54	-33.23	PK



Between 30-1000MHz

Project: LGT23B010	Test Engineer: Dylan.shi
EUT: Smart phone	Temperature: 20.7°C
M/N: Luna	Humidity: 56%RH
Test Voltage: Battery	Test Data: 2023-02-24
Test Mode: Operating	
Note:	

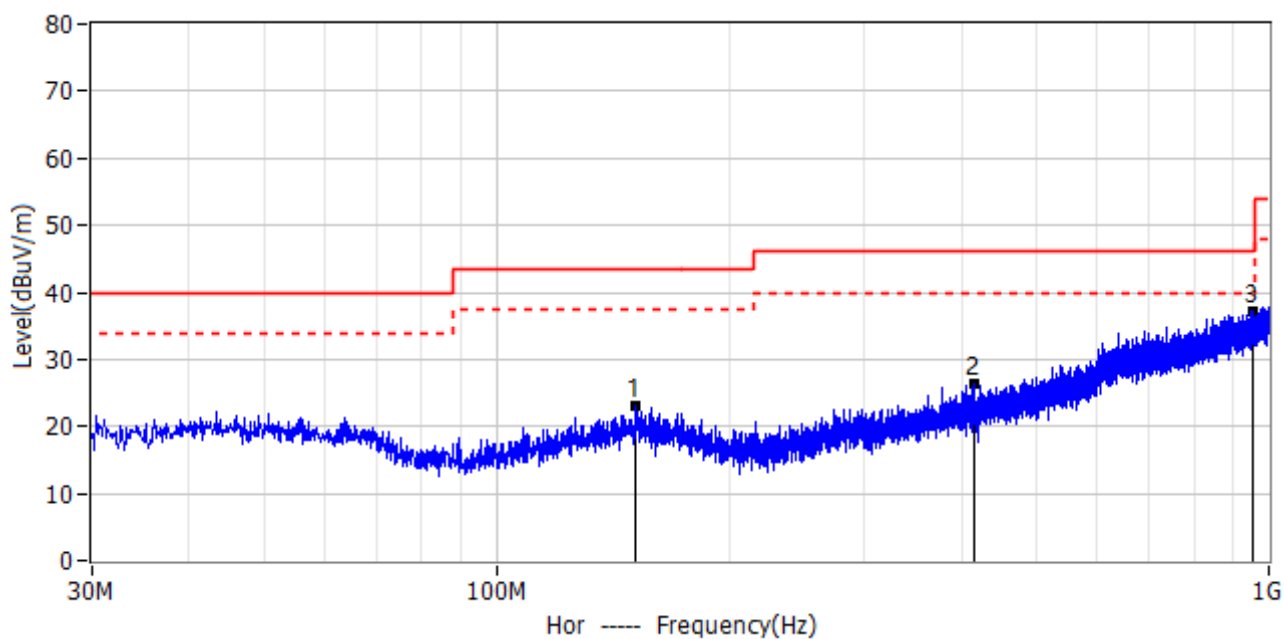

No.	Frequency	Reading dBuV	Factor dB/m	Level dBuV/m	Limit dBuV/m	Margin dB	Detector	Polar
1*	151.614MHz	2.96	19.97	22.93	43.50	-20.57	PK	Hor
2*	414.363MHz	3.18	23.06	26.24	46.00	-19.76	PK	Hor
3*	951.500MHz	3.18	33.99	37.17	46.00	-8.83	PK	Hor



Project: LGT23B010	Test Engineer: Dylan.shi
EUT: Smart phone	Temperature: 20.7°C
M/N: Luna	Humidity: 56%RH
Test Voltage: Battery	Test Data: 2023-02-24
Test Mode: Operating	
Note:	

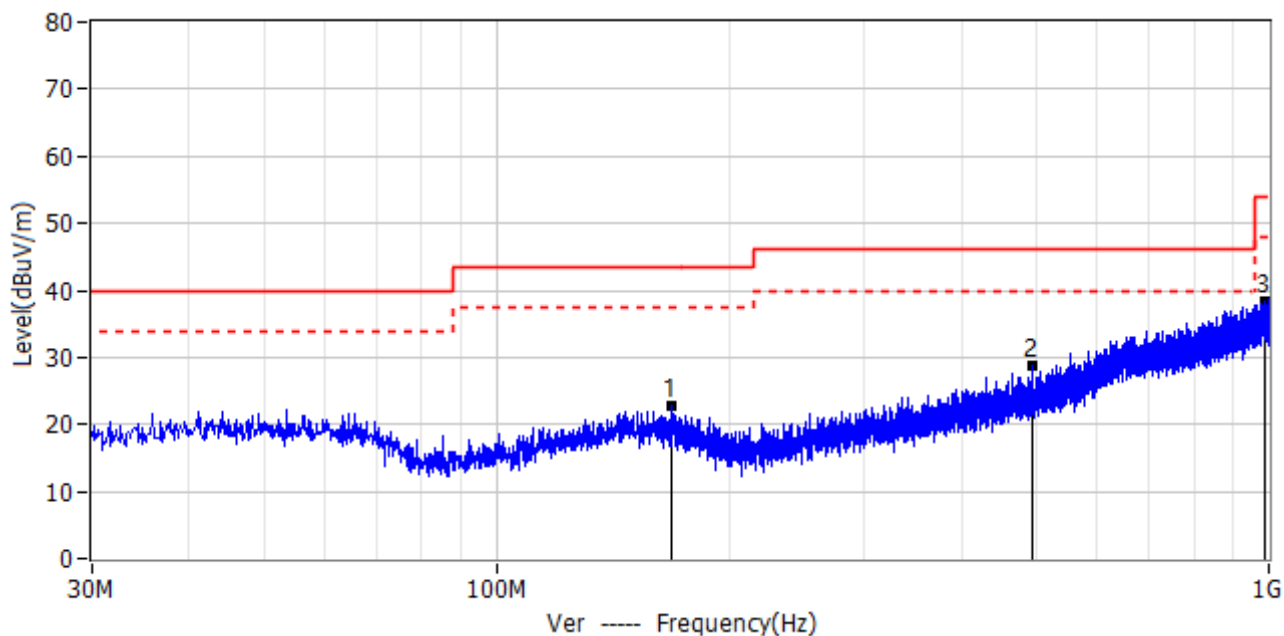

No.	Frequency	Reading dBuV	Factor dB/m	Level dBuV/m	Limit dBuV/m	Margin dB	Detector	Polar
1*	168.831MHz	3.05	19.79	22.84	43.50	-20.66	PK	Ver
2*	495.358MHz	4.12	24.78	28.90	46.00	-17.10	PK	Ver
3*	989.330MHz	3.93	34.52	38.45	54.00	-15.55	PK	Ver



5. FREQUENCY TOLERANCE

5.1 LIMIT

According to FCC section 15.225, the devices operating in the 13.553-13.567 MHz shall maintain the carrier frequency within 0.01% of the operating frequency over the temperature variation of -20°C to +50°C using an environmental chamber. The primary supply voltage is varied from 85% to 115% of the voltage normally at the input to the device or at the power supply terminals if cables are not normally supplied.

5.2 TEST PROCEDURE

According to FCC section 15.225(e), The frequency tolerance of the carrier signal shall be maintained within $\pm 0.01\%$ of the operating frequency over a temperature variation of -20 degrees to + 50 degrees C at normal supply voltage, and for a variation in the primary supply voltage from 85% to 115% of the rated supply voltage at a temperature of 20 degrees C. For battery operated equipment, the equipment tests shall be performed using a new battery.

5.3 TEST SETUP

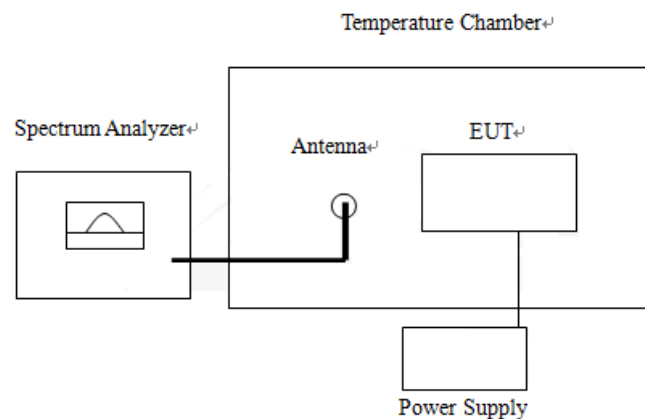

The EUT which is powered by the Battery, is coupled to the Spectrum Analyzer; the RF load attached to the EUT antenna terminal is 50Ohm; the path loss as the factor is calibrated to correct the reading

5.4 EUT OPERATION CONDITIONS

Please refer to section 3.4 of this report.



5.5 TEST RESULTS

Temperature:	25 °C	Relative Humidity:	50%
Test Voltage:	DC 3.87V	Test Mode:	TX Mode

13.56MHz

VOLTAGE (%)	Test Conditions		Frequency	Deviation	Limit	Verdict
	Power (VDC)	Temperature (°C)	(Hz)			
100	3.87	+20°C(Ref)	13558818	-0.00871%	±0.01%	PASS
100		-20	13561077	0.00794%	±0.01%	
100		-10	13559978	-0.00016%	±0.01%	
100		0	13559790	-0.00155%	±0.01%	
100		10	13560371	0.00274%	±0.01%	
100		20	13561013	0.00747%	±0.01%	
100		25	13559776	-0.00166%	±0.01%	
100		30	13559163	-0.00617%	±0.01%	
100		40	13560620	0.00457%	±0.01%	
100		50	13561199	0.00884%	±0.01%	
Battery End Point	3.290	20	13559858	-0.00105%	±0.01%	
115	4.45	20	13560190	0.00140%	±0.01%	



6. 20DB BANDWIDTH

6.1 LIMIT

According to FCC section 15.215©, the 20dB bandwidth should be contained within the frequency band designated in the rule section under which the EUT is operated, it was measured with a spectrum analyzer connected the EUT while the EUT is operating in transmission mode.

6.2 TEST PROCEDURE

Intentional radiators operating under the alternative provisions to the general emission limits, as contained in §13.553-13.567 MHz and in subpart E of this part, must be designed to ensure that the 20 dB bandwidth of the emission, or whatever bandwidth may otherwise be specified in the specific rule section under which the equipment operates, is contained within the frequency band designated in the rule section under which the equipment is operated. In the case of intentional radiators operating under the provisions of subpart E, the emission bandwidth may span across multiple contiguous frequency bands identified in that subpart. The requirement to contain the designated bandwidth of the emission within the specified frequency band includes the effects from frequency sweeping, frequency hopping and other modulation techniques that may be employed as well as the frequency stability of the transmitter over expected variations in temperature and supply voltage. If a frequency stability is not specified in the regulations, it is recommended that the fundamental emission be kept within at least the central 80% of the permitted band in order to minimize the possibility of out-of-band operation.

1. Set RBW = 1 kHz.
2. Set the video Mobile Phonewidth (VBW) ≥ 3 RBW.
3. Detector = Peak.
4. Trace mode = max hold.
5. Sweep = auto couple.
6. Allow the trace to stabilize.
7. Measure the maximum width of the emission that is constrained by the frequencies associated with the two outermost amplitude points (upper and lower frequencies) that are attenuated by 6 dB relative to the maximum level measured in the fundamental emission.

6.3 TEST SETUP

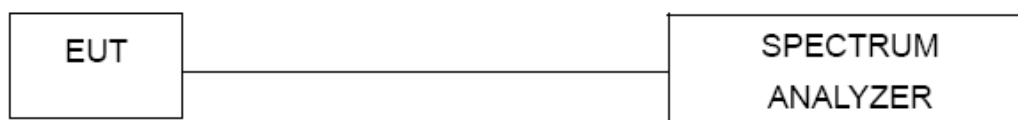

6.4 EUT OPERATION CONDITIONS

Please refer to section 3.4 of this report.



6.5 TEST RESULTS

Temperature:	25 °C	Relative Humidity:	60%
Test Voltage:	DC 3.87V	Test Mode:	TX Mode

13.56MHz

Centre Frequency	Measurement		
	20dB Bandwidth	99% Bandwidth	Frequency Range (MHz)
	(KHz)	(KHz)	
13.56MHz	3.078	2.873	13.553-13.567

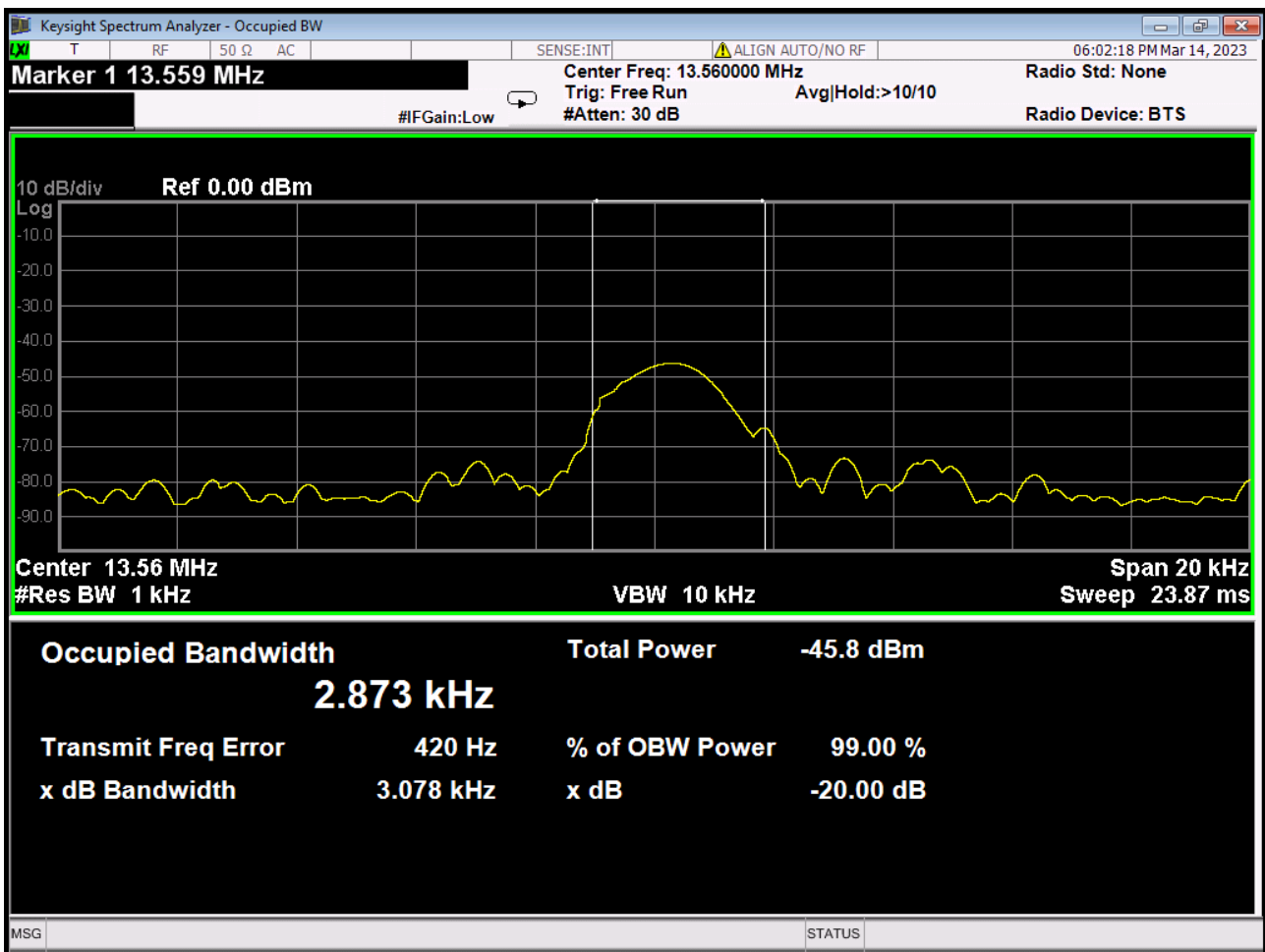



7. ANTENNA REQUIREMENT

7.1 STANDARD REQUIREMENT

Part 15.203 requirement: For intentional device, according to 15.203: an intentional radiator shall be designed to ensure that no antenna other than that furnished by the responsible party shall be used with the device.

7.2 EUT ANTENNA

The EUT antenna is coil Antenna. It comply with the standard requirement.



APPENDIX 1- PHOTOS OF TEST SETUP

Note: See test photos in setup photo document for the actual connections between Product and support equipment.

※※※※※END OF THE REPORT※※※※※