



FCC TEST REPORT

Report No: STS1807042W16

Issued for

Shanghai Unihertz E-Commerce Co., Ltd

Room 302, No. 5, Lane 59, Shennan Rd, Minhang district,
Shanghai, China 201108

| | |
|-----------------------|-----------------|
| Product Name: | Smart phone |
| Brand Name: | Unihertz |
| Model Name: | Atom |
| Series Model: | N/A |
| FCC ID: | 2AK6CATOM |
| Test Standard: | FCC Part 15.407 |

Any reproduction of this document must be done in full. No single part of this document may be reproduced without permission from STS, All Test Data Presented in this report is only applicable to presented Test sample.





TEST RESULT CERTIFICATION

Applicant's name : Shanghai Unihertz E-Commerce Co., Ltd
Address : Room 302, No. 5, Lane 59, Shennan Rd, Minhang district, Shanghai, China 201108
Manufacture's Name..... : OBLUE Communication Technology Co.,Ltd.
Address : Room 406, Hivac Building, No. 2 North keji Rd, North Hi-Tech Industry Park, Nanshan district, shenzhen, China 201108

Product description

Product Name..... : Smart phone
Brand Name : Unihertz
Model Name : Atom
Series Model..... : N/A

Test Standards..... : FCC Part15.407

Test procedure ANSI C63.10-2013

This device described above has been tested by STS, the test results show that the equipment under test (EUT) is in compliance with the FCC requirements. And it is applicable only to the tested sample identified in the report.

This report shall not be reproduced except in full, without the written approval of STS, this document only be altered or revised by STS, personal only, and shall be noted in the revision of the document.

Date of Test :
Date (s) of performance of tests : 25 July 2018~20 Aug. 2018
Date of Issue..... : 20 Aug. 2018
Test Result..... : **Pass**

Testing Engineer : *Chris chen*

 (Chris chen)

Technical Manager : *Sean she*

 (Sean she)

Authorized Signatory : *Vita Li*

 (Vita Li)





| Table of Contents | Page |
|---|-----------|
| 1 . SUMMARY OF TEST RESULTS | 5 |
| 1.1 TEST FACTORY | 6 |
| 1.2 MEASUREMENT UNCERTAINTY | 6 |
| 2 . GENERAL INFORMATION | 7 |
| 2.1 GENERAL DESCRIPTION OF EUT | 7 |
| 2.2 DESCRIPTION OF TEST MODES | 10 |
| 2.3 BLOCK DIGRAM SHOWING THE CONFIGURATION OF SYSTEM TESTED | 11 |
| 2.4 DESCRIPTION OF SUPPORT UNITS(CONDUCTED MODE) | 12 |
| 2.5 EQUIPMENTS LIST FOR ALL TEST ITEMS | 13 |
| 3 . EMC EMISSION TEST | 14 |
| 3.1 CONDUCTED EMISSION MEASUREMENT | 14 |
| 3.2 RADIATED EMISSION AND (BANDEDGE) MEASUREMENT | 18 |
| 4. CONDUCTED SPURIOUS EMISSIONS AND BANDEDGE | 40 |
| 4.1 APPLIED PROCEDURES / LIMIT | 40 |
| 5. POWER SPECTRAL DENSITY TEST | 42 |
| 5.1 APPLIED PROCEDURES / LIMIT | 42 |
| 6. BANDWIDTH MEASUREMENT | 44 |
| 6.1 EMISSION BANDWIDTH (EBW) 26 BANDWID PROCEDURES / LIMIT | 44 |
| 6.2 OCCUPIED BANDWIDTH (99%) TEST APPLIED PROCEDURES / LIMIT | 45 |
| 6.3 MINIMUM EMISSION BANDWIDTH(6 DB) PROCEDURES / LIMIT | 46 |
| 7. MAXIMUM CONDUCTED OUTPUT POWER | 47 |
| 7.1 APPLIED PROCEDURES / LIMIT | 47 |
| 8. AUTOMATICALLY DISCONTINUE TRANSMISSION | 52 |
| 8.1 LIMIT OF AUTOMATICALLY DISCONTINUE TRANSMISSION | 52 |
| 8.2 TEST RESULT OF AUTOMATICALLY DISCONTINUE TRANSMISSION | 52 |
| 9. ANTENNA REQUIREMENT | 53 |
| 9.1 STANDARD REQUIREMENT | 53 |
| 9.2 EUT ANTENNA | 53 |
| APPENDIX - PHOTOS OF TEST SETUP | 54 |



Revision History

| Rev. | Issue Date | Report NO. | Effect Page | Contents |
|------|--------------|---------------|-------------|---------------|
| 00 | 20 Aug. 2018 | STS1807042W16 | ALL | Initial Issue |
| | | | | |





1. SUMMARY OF TEST RESULTS

Test procedures according to the technical standards:

§ 15.407, KDB 789033 D02 General U-NII Test Procedures New Rules v02r01

| FCC Part 15.407 | | |
|---|---|---------|
| FCC standard | Test Item | Results |
| 15.207 | AC Conducted Emission | PASS |
| § 15.407 (2) (26 dB) / § 15.407 (e) (6 dB) / § 15.407 (a) (99%) | 26dB/6dB & 99% Bandwidth | PASS |
| 15.407(a) (1).(2).(3).(4).(5) | Maximum Conducted Output Power | PASS |
| 15.407(b) & 15.209 | Radiated Emission And (bandedge Emissions) Measurement | PASS |
| 15.407(b)7 | Conducted Emission And (bandedge Emissions) Measurement | PASS |
| 15.407(a) (1).(2).(3).(4).(5) | Power Spectral Density | PASS |
| 15.407(c) | Automatically Discontinue Transmission | PASS |
| 15.203/15.204 | Antenna Requirement | PASS |

NOTE:

(1) "N/A" denotes test is not applicable in this Test Report

(2) all tests are according to ANSI C63.10-2013



1.1 TEST FACTORY

Shenzhen STS Test Services Co., Ltd.

Add. : 1/F., Building B, Zhuoke Science Park, No.190, Chongqing Road,
Fuyong Street, Bao'an District, Shenzhen, Guangdong, China

CNAS Registration No.: L7649; FCC Registration No.: 625569

IC Registration No.: 12108A; A2LA Certificate No.: 4338.01;

1.2 MEASUREMENT UNCERTAINTY

The reported uncertainty of measurement $y \pm U$ · where expanded uncertainty **U** is based on a standard uncertainty multiplied by a coverage factor of **k=2** · providing a level of confidence of approximately **95 %** .

| No. | Item | Uncertainty |
|-----|--|-------------|
| 1 | Conducted Emission (9KHz-150KHz) | ±2.88dB |
| 2 | Conducted Emission (150KHz-30MHz) | ±2.67dB |
| 3 | RF power,conducted | ±0.71dB |
| 4 | Spurious emissions,conducted | ±0.63dB |
| 5 | All emissions,radiated(<1G) 30MHz-200MHz | ±3.80dB |
| 6 | All emissions,radiated(<1G) 200MHz-1000MHz | ±3.97dB |
| 7 | All emissions,radiated(>1G) | ±3.03dB |



2. GENERAL INFORMATION

2.1 GENERAL DESCRIPTION OF EUT

| | | |
|---|--|--|
| Product Name | Smart phone | |
| Trade Name | Unihertz | |
| Model Name | Atom | |
| Series Model | N/A | |
| Model Difference | N/A | |
| Product Description | The EUT is a Smart phone | |
| | Operation Frequency: | IEEE 802.11a/ n (HT20) 5.180GHz-5.240GHz IEEE 802.11n (HT40) 5.190GHz-5.230GHz |
| | | IEEE 802.11a/ n (HT20)5.260GHz-5.320GHz IEEE 802.11n (HT40)5.270GHz-5.310GHz |
| | | IEEE 802.11a/ n (HT20)5.500GHz-5.700GHz IEEE 802.11n (HT40)5.510GHz-5.670GHz |
| | | IEEE 802.11a/ n (HT20)5.745GHz-5.825GHz IEEE 802.11a/ n (HT40)5.755GHz-5.795GHz |
| | Modulation Type: | 802.11a(OFDM):BPSK,QPSK,16-QAM,64-QAM 802.11n(OFDM):BPSK,QPSK,16-QAM,64-QAM |
| | Antenna Designation: | See Note 3 |
| | Max.Output Power(Conducted): | 11.45dBm |
| Duty Cycle: | >98% | |
| More details of EUT technical specification, please refer to the User's Manual. | | |
| Test Channel | Please refer to the Note 2. | |
| Adapter | Power supply and ADP(rating): Input: AC100-240V, 300mA, 50/60Hz Output: DC5V, 1500mA | |
| Battery | Battery(rating): Rated Voltage: 3.85V Charge Limit: 4.4V Capacity: 2000mAh | |
| Hardware version number | G35_V1.2 | |
| Software version number | alps-mp-01.mp1 | |
| Connecting I/O Port(s) | Please refer to the User's Manual | |

Note:For a more detailed features description, please refer to the manufacturer's specifications or the User's Manual.



1. Operation Frequency of channel

| 5.180GHz-5.240GHz | | 5.500GHz-5.720GHz | |
|-------------------|-----------|-------------------|-----------|
| Channel | Frequency | Channel | Frequency |
| 36 | 5180 | 100 | 5500 |
| 38 | 5190 | 102 | 5510 |
| 40 | 5200 | 104 | 5520 |
| 42 | 5210 | 108 | 5540 |
| 44 | 5220 | 110 | 5550 |
| 46 | 5230 | 112 | 5560 |
| 48 | 5240 | 116 | 5580 |
| | | 118 | 5590 |
| | | 120 | 5600 |
| 5.260GHz-5.320GHz | | | |
| Channel | Frequency | | |
| 52 | 5260 | 124 | 5620 |
| 54 | 5270 | 126 | 5630 |
| 56 | 5280 | 128 | 5640 |
| 58 | 5290 | 132 | 5660 |
| 60 | 5300 | 134 | 5670 |
| 62 | 5310 | 136 | 5680 |
| 64 | 5320 | 140 | 5700 |
| | | | |
| | | | |
| 5.745GHz-5.825GHz | | | |
| Channel | Frequency | | |
| 149 | 5745 | | |
| 151 | 5755 | | |
| 153 | 5765 | | |
| 157 | 5785 | | |
| 159 | 5795 | | |
| 161 | 5805 | | |
| 165 | 5825 | | |

Note:

In section 15.31(m), regards to the operating frequency range over 10 MHz, the Lowest frequency, the middle frequency, and the highest frequency of channel were selected to perform the test, and the selected channel see below:

Carrier Frequency Channel

5GHz:

| For 802.11a/n (HT20) | | | |
|----------------------|------------|---------|------------|
| Channel | Freq.(MHz) | Channel | Freq.(MHz) |
| 36 | 5180 | 52 | 5260 |
| 40 | 5200 | 60 | 5300 |
| 48 | 5240 | 64 | 5320 |

| For 802.11a/n (HT20) | | | |
|----------------------|------------|---------|------------|
| Channel | Freq.(MHz) | Channel | Freq.(MHz) |
| 100 | 5500 | 149 | 5745 |
| 116 | 5580 | 157 | 5785 |
| 140 | 5700 | 165 | 5825 |



| For 802.11n (HT40) | | | |
|--------------------|------------|---------|------------|
| Channel | Freq.(MHz) | Channel | Freq.(MHz) |
| 38 | 5190 | 54 | 5270 |
| 46 | 5230 | 62 | 5310 |

| For 802.11n (HT40) | | | |
|--------------------|------------|---------|------------|
| Channel | Freq.(MHz) | Channel | Freq.(MHz) |
| 102 | 5510 | 151 | 5755 |
| 110 | 5550 | 159 | 5795 |
| 134 | 5670 | | |

| Ant. | Brand | Model Name | Ant Type | Connector | Gain (dBi) | NOTE |
|------|----------|------------|--------------|-----------|--|-----------|
| A | Unihertz | Atom | PIFA Antenna | N/A | Band 1: 1.07dBi Band 2: 0.56dBi Band 3: 2.48dBi Band 4: 2.56dBi | WLAN Ant. |



2.2 DESCRIPTION OF TEST MODES

To investigate the maximum EMI emission characteristics generated from EUT, the test system was pre-scanning tested based on the consideration of following EUT operation mode or test configuration mode which possibly have effect on EMI emission level. Each of these EUT operation mode(s) or test configuration mode(s) mentioned above was evaluated respectively.

| Worst Mode | Description | Data Rate |
|------------|--|-----------|
| Mode 1 | TX IEEE 802.11a HT20 CH36&CH40&CH48 | 6 Mbps |
| Mode 2 | TX IEEE 802.11a HT20 CH52&CH60&CH64 | 6 Mbps |
| Mode 3 | TX IEEE 802.11a HT20 CH100&CH116&CH140 | 6 Mbps |
| Mode 4 | TX IEEE 802.11a HT20 CH149&CH157&CH165 | 6 Mbps |
| Mode 5 | TX IEEE 802.11n HT20 CH36&CH40&CH48 | MCS 0 |
| Mode 6 | TX IEEE 802.11n HT20 CH52&CH60&CH64 | MCS 0 |
| Mode 7 | TX IEEE 802.11n HT20 CH100&CH116&CH140 | MCS 0 |
| Mode 8 | TX IEEE 802.11n HT20 CH149&CH157&CH165 | MCS 0 |
| Mode 9 | TX IEEE 802.11n HT40 CH38&CH46 | MCS 0 |
| Mode 10 | TX IEEE 802.11n HT40 CH54 &CH62 | MCS 0 |
| Mode 11 | TX IEEE 802.11n HT40 CH102&CH110&CH134 | MCS 0 |
| Mode 12 | TX IEEE 802.11n HT40 CH151&CH159 | MCS 0 |

- Note: (1) The measurements are performed at the highest, middle, lowest available channels.
 (2) The measurements are performed at all Bit Rate of Transmitter, the worst data was reported
 (3) We have been tested for all available U.S. voltage and frequencies (For 120V, 50/60Hz and 240V, 50/60Hz) for which the device is capable of operation.

AC Conducted Emission

| Test Case | |
|-----------------------|---------------------------------|
| AC Conducted Emission | Mode 13: Keeping TX + WLAN Link |

2.3 BLOCK DIGRAM SHOWING THE CONFIGURATION OF SYSTEM TESTED

Radiated Spurious Emission Test

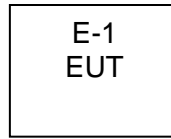

Conducted Emission Test

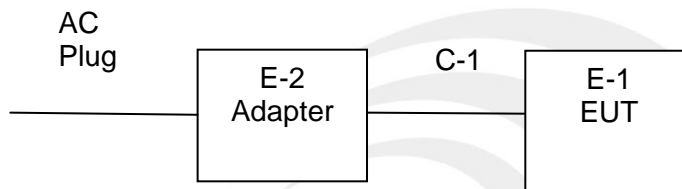



2.4 DESCRIPTION OF SUPPORT UNITS(CONDUCTED MODE)

The EUT has been tested as an independent unit together with other necessary accessories or support units. The following support units or accessories were used to form a representative test configuration during the tests.

| Item | Equipment | Mfr/Brand | Model/Type No. | Series No. | Note |
|------|-----------|-----------|-----------------|------------|------|
| E-2 | Adapter | Unihertz | HJ-0501500W2-US | N/A | N/A |
| | | | | | |
| | | | | | |
| | | | | | |
| | | | | | |
| | | | | | |

| Item | Shielded Type | Ferrite Core | Length | Note |
|------|-------------------------------------|--------------|--------|------|
| C-1 | USB Cable shielded line (Charging) | NO | 100cm | N/A |
| | | | | |
| | | | | |
| | | | | |

Note:

- (1) The support equipment was authorized by Declaration of Confirmation.
- (2) For detachable type I/O cable should be specified the length in cm in 『Length』 column.
- (3) “YES” is means “shielded” “with core”; “NO” is means “unshielded” “without core”.

2.5 EQUIPMENTS LIST FOR ALL TEST ITEMS

Radiation Test equipment

| Kind of Equipment | Manufacturer | Type No. | Serial No. | Last calibration | Calibrated until |
|--------------------------|--------------|------------|----------------|------------------|------------------|
| EMI Test Receiver | R&S | ESCI | 102086 | 2017.10.15 | 2018.10.14 |
| Bilog Antenna | TESEQ | CBL6111D | 34678 | 2017.11.02 | 2018.11.01 |
| Horn Antenna | Schwarzbeck | BBHA 9120D | 9120D-1343 | 2017.10.27 | 2018.10.26 |
| Horn Antenna | Schwarzbeck | BBHA 9170 | 9170-0741 | 2016.03.06 | 2019.03.03 |
| PreAmplifier | Agilent | 8449B | 60538 | 2017.10.15 | 2018.10.14 |
| Passive Loop (9K--30MHz) | ZHMAN | ZN3090C | 16035 | 2018.03.11 | 2019.03.10 |
| Low frequency cable | EM | R01 | N/A | NCR | NCR |
| High frequency cable | SCHWARZBECK | AK9515H | SN-96286/96287 | NCR | NCR |
| EMI Test Receiver | R&S | ESW44 | 101535 | 2018.07.10 | 2019.07.09 |

Conduction Test equipment

| Kind of Equipment | Manufacturer | Type No. | Serial No. | Last calibration | Calibrated until |
|-------------------|--------------|----------|------------|------------------|------------------|
| Test Receiver | R&S | ESCI | 101427 | 2017.10.15 | 2018.10.14 |
| LISN | R&S | ENV216 | 101242 | 2017.10.15 | 2018.10.14 |
| Conduction Cable | EM | C01 | N/A | 2018.03.11 | 2019.03.10 |

RF Connected Test

| Kind of Equipment | Manufacturer | Type No. | Serial No. | Last calibration | Calibrated until |
|---------------------|--------------|----------|---------------|------------------|------------------|
| USB RF power sensor | DARE | RPR3006W | 15I00041SNO03 | 2017.10.15 | 2018.10.14 |
| Spectrum Analyzer | Agilent | N9020A | MY51110105 | 2018.03.08 | 2019.03.07 |
| Signal Analyzer | Agilent | N9020A | MY49100060 | 2017.10.15 | 2018.10.14 |



3. EMC EMISSION TEST

3.1 CONDUCTED EMISSION MEASUREMENT

3.1.1 POWER LINE CONDUCTED EMISSION Limits (Frequency Range 150KHz-30MHz)

| FREQUENCY (MHz) | Class B (dBuV) | | Standard |
|-----------------|----------------|-----------|----------|
| | Quasi-peak | Average | |
| 0.15 -0.5 | 66 - 56 * | 56 - 46 * | CISPR |
| 0.50 -5.0 | 56.00 | 46.00 | CISPR |
| 5.0 -30.0 | 60.00 | 50.00 | CISPR |

| | | | |
|-----------|-----------|-----------|-----|
| 0.15 -0.5 | 66 - 56 * | 56 - 46 * | FCC |
| 0.50 -5.0 | 56.00 | 46.00 | FCC |
| 5.0 -30.0 | 60.00 | 50.00 | FCC |

Note:

- (1) The tighter limit applies at the band edges.
- (2) The limit of " * " marked band means the limitation decreases linearly with the logarithm of the frequency in the range.

The following table is the setting of the receiver

| Receiver Parameters | Setting |
|---------------------|----------|
| Attenuation | 10 dB |
| Start Frequency | 0.15 MHz |
| Stop Frequency | 30 MHz |
| IF Bandwidth | 9 kHz |

3.1.2 TEST PROCEDURE

- a. The EUT was placed 0.8 meters from the horizontal ground plane with EUT being connected to the power mains through a line impedance stabilization network (LISN). All other support equipments powered from additional LISN(s). The LISN provide 50 Ohm/ 50uH of coupling impedance for the measuring instrument.
- b. Interconnecting cables that hang closer than 40 cm to the ground plane shall be folded back and forth in the center forming a bundle 30 to 40 cm long.
- c. I/O cables that are not connected to a peripheral shall be bundled in the center. The end of the cable may be terminated, if required, using the correct terminating impedance. The overall length shall not exceed 1 m.
- d. LISN at least 80 cm from nearest part of EUT chassis.
- e. For the actual test configuration, please refer to the related Item –EUT Test Photos.

3.1.3 DEVIATION FROM TEST STANDARD

No deviation

3.1.4 TEST SETUP

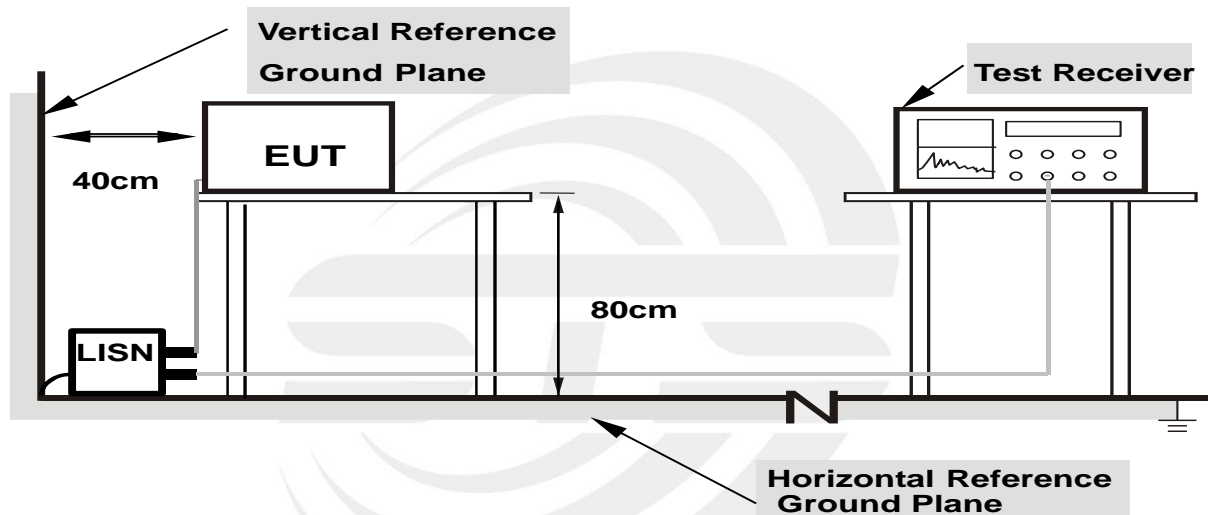

- Note: 1.Support units were connected to second LISN.**
2.Both of LISNs (AMN) are 80 cm from EUT and at least 80 from other units and other metal planes

3.1.5 EUT OPERATING CONDITIONS

The EUT was configured for testing in a typical fashion (as a customer would normally use it). The EUT has been programmed to continuously transmit during test. This operating condition was tested and used to collect the included data.



3.1.6 TEST RESULTS

| | | | |
|---------------|--------------|--------------------|-----|
| Temperature: | 26.7 °C | Relative Humidity: | 65% |
| Test Voltage: | AC 120V/60Hz | Phase: | L |
| Test Mode : | Mode 13 | | |

| Frequency (MHz) | Reading (dBuV) | Correct Factor(dB) | Result (dBuV) | Limit (dBuV) | Margin (dB) | Remark |
|-----------------|----------------|--------------------|---------------|--------------|-------------|--------|
| 0.1540 | 50.49 | 9.79 | 60.28 | 65.78 | -5.50 | QP |
| 0.1540 | 32.92 | 9.79 | 42.71 | 55.78 | -13.07 | AVG |
| 0.2380 | 43.98 | 9.95 | 53.93 | 62.17 | -8.24 | QP |
| 0.2380 | 27.13 | 9.95 | 37.08 | 52.17 | -15.09 | AVG |
| 0.5580 | 37.96 | 9.97 | 47.93 | 56.00 | -8.07 | QP |
| 0.5580 | 21.18 | 9.97 | 31.15 | 46.00 | -14.85 | AVG |
| 1.2060 | 31.58 | 9.80 | 41.38 | 56.00 | -14.62 | QP |
| 1.2060 | 15.91 | 9.80 | 25.71 | 46.00 | -20.29 | AVG |
| 3.7820 | 32.19 | 9.83 | 42.02 | 56.00 | -13.98 | QP |
| 3.7820 | 15.25 | 9.83 | 25.08 | 46.00 | -20.92 | AVG |
| 12.0980 | 28.50 | 10.22 | 38.72 | 60.00 | -21.28 | QP |
| 12.0980 | 13.32 | 10.22 | 23.54 | 50.00 | -26.46 | AVG |

Remark:

1. All readings are Quasi-Peak and Average values.
2. Margin = Result (Result =Reading + Factor)–Limit

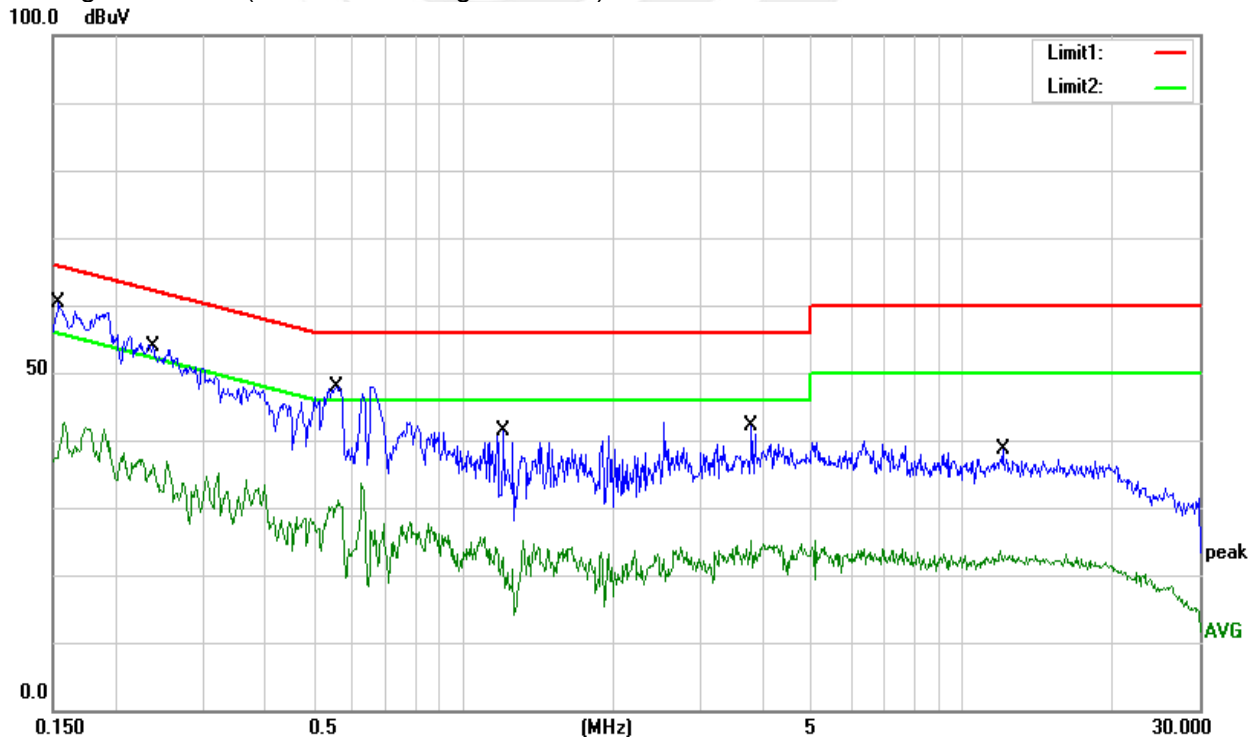



| | | | |
|--------------|--------------|--------------------|-----|
| Temperature: | 26.7 °C | Relative Humidity: | 65% |
| Test Voltage | AC 120V/60Hz | Phase: | N |
| Test Mode | Mode 13 | | |

| Frequency (MHz) | Reading (dBuV) | Correct Factor(dB) | Result (dBuV) | Limit (dBuV) | Margin (dB) | Remark |
|-----------------|----------------|--------------------|---------------|--------------|-------------|--------|
| 0.1540 | 49.62 | 9.76 | 59.38 | 65.78 | -6.40 | QP |
| 0.1540 | 31.80 | 9.76 | 41.56 | 55.78 | -14.22 | AVG |
| 0.2340 | 44.61 | 10.01 | 54.62 | 62.31 | -7.69 | QP |
| 0.2340 | 26.32 | 10.01 | 36.33 | 52.31 | -15.98 | AVG |
| 0.5580 | 41.26 | 9.95 | 51.21 | 56.00 | -4.79 | QP |
| 0.5580 | 28.55 | 9.95 | 38.50 | 46.00 | -7.50 | AVG |
| 1.4860 | 33.05 | 9.83 | 42.88 | 56.00 | -13.12 | QP |
| 1.4860 | 17.43 | 9.83 | 27.26 | 46.00 | -18.74 | AVG |
| 3.8420 | 31.34 | 9.94 | 41.28 | 56.00 | -14.72 | QP |
| 3.8420 | 14.29 | 9.94 | 24.23 | 46.00 | -21.77 | AVG |
| 13.2940 | 29.87 | 10.02 | 39.89 | 60.00 | -20.11 | QP |
| 13.2940 | 14.45 | 10.02 | 24.47 | 50.00 | -25.53 | AVG |

Remark:

1. All readings are Quasi-Peak and Average values.
2. Margin = Result (Result =Reading + Factor)–Limit

100.0 dBuV

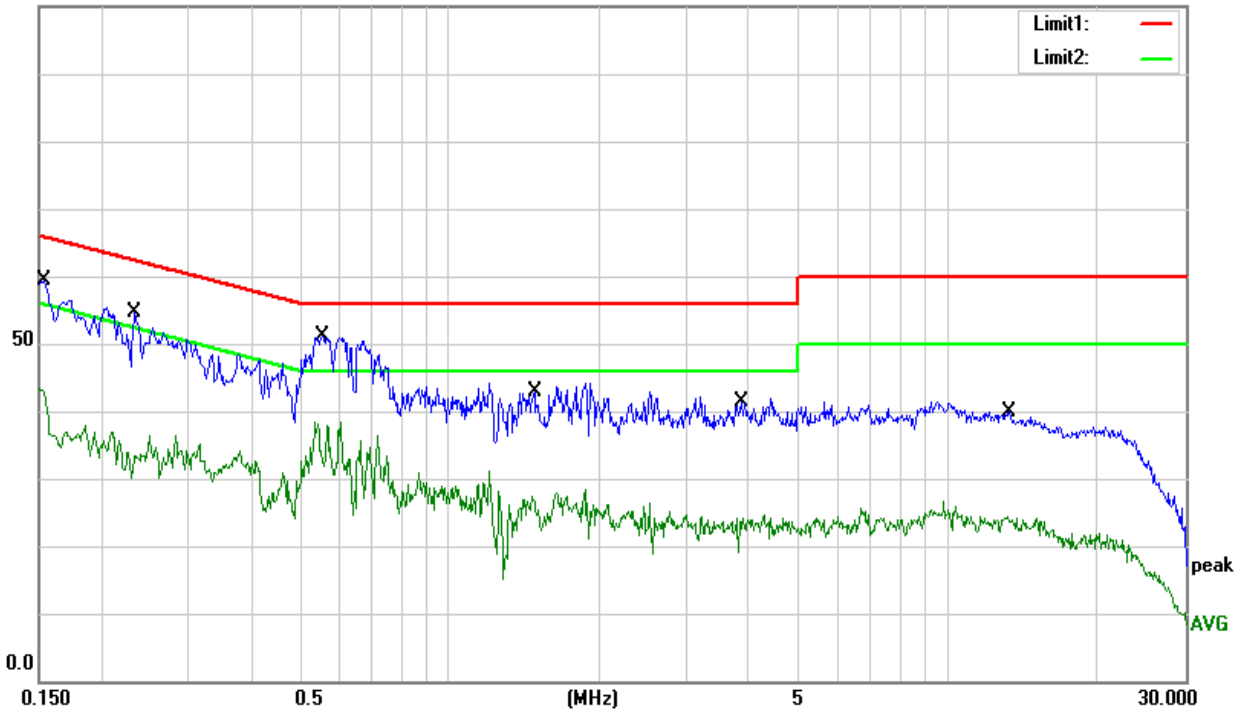

3.2 RADIATED EMISSION AND (BANDEDGE) MEASUREMENT

3.2.1 RADIATED EMISSION LIMITS (Frequency Range 9kHz-1000MHz)

In case the emission fall within the restricted band specified on 15.407(b)7& 15.205/209(a), then the (a); limit in the table below has to be followed.

| Frequencies (MHz) | Field Strength (micorvolts/meter) | Measurement Distance (meters) |
|-------------------|-----------------------------------|-------------------------------|
| 0.009~0.490 | 2400/F(KHz) | 300 |
| 0.490~1.705 | 24000/F(KHz) | 30 |
| 1.705~30.0 | 30 | 30 |
| 30~88 | 100 | 3 |
| 88~216 | 150 | 3 |
| 216~960 | 200 | 3 |
| Above 960 | 500 | 3 |

LIMITS OF RADIATED EMISSION MEASUREMENT (Above 1000MHz)

| FREQUENCY (MHz) | Class B (dBuV/m) (at 3M) | |
|-----------------|--------------------------|---------|
| | PEAK | AVERAGE |
| Above 1000 | 74 | 54 |

Notes:

- (1) The limit for radiated test was performed according to FCC PART 15E.
- (2) The tighter limit applies at the band edges.
- (3) Emission level (dBuV/m)=20log Emission level (uV/m).

| Spectrum Parameter | Setting |
|---------------------------------------|--------------------------------|
| Attenuation | Auto |
| Detector | Peak |
| Start Frequency | 1000 MHz(Peak/AV) |
| Stop Frequency | 10th carrier harmonic(Peak/AV) |
| RB / VB (emission in restricted band) | 1 MHz / 1 MHz, AV=1 MHz /3 MHz |

For Band edge

| Spectrum Parameter | Setting |
|---------------------------------------|--------------------------------|
| Detector | Peak |
| RB / VB (emission in restricted band) | 1 MHz / 1 MHz, AV=1 MHz /3 MHz |



| Receiver Parameter | Setting |
|------------------------|--------------------------------------|
| Attenuation | Auto |
| Start ~ Stop Frequency | 9kHz~90kHz / RB 200Hz for PK & AV |
| Start ~ Stop Frequency | 90kHz~110kHz / RB 200Hz for QP |
| Start ~ Stop Frequency | 110kHz~490kHz / RB 200Hz for PK & AV |
| Start ~ Stop Frequency | 490kHz~30MHz / RB 9kHz for QP |
| Start ~ Stop Frequency | 30MHz~1000MHz / RB 120kHz for QP |

3.2.2 TEST PROCEDURE

- The measuring distance of at 3 m shall be used for measurements at frequency 0.009MHz up to 1GHz. For frequencies above 1GHz, any suitable measuring distance may be used.
- The EUT was placed on the top of a rotating table 0.8 meters(above 1GHz is 1.5 m) above the ground at a 3 meter anechoic chamber. The table was rotated 360 degrees to determine the position of the highest radiation.
- The height of the equipment shall be 0.8 m(above 1GHz is 1.5 m); the height of the test antenna shall vary between 1 m to 4 m. Horizontal and vertical polarizations of the antenna are set to make the measurement
- The initial step in collecting conducted emission data is a spectrum analyzer peak detector mode pre-scanning the measurement frequency range. Significant peaks are then marked and then Quasi Peak detector mode re-measured.
- If the Peak Mode measured value compliance with and lower than Quasi Peak Mode Limit, the EUT shall be deemed to meet QP Limits and then no additional QP Mode measurement performed.
- For the actual test configuration, please refer to the related Item –EUT Test Photos.

Note:

Both horizontal and vertical antenna polarities were tested and performed test to three orthogonal axis. The worst case emissions were reported

3.2.2 DEVIATION FROM TEST STANDARD

No deviation

3.2.3 TEST SETUP

(A) Radiated Emission Test-Up Frequency Below 30MHz

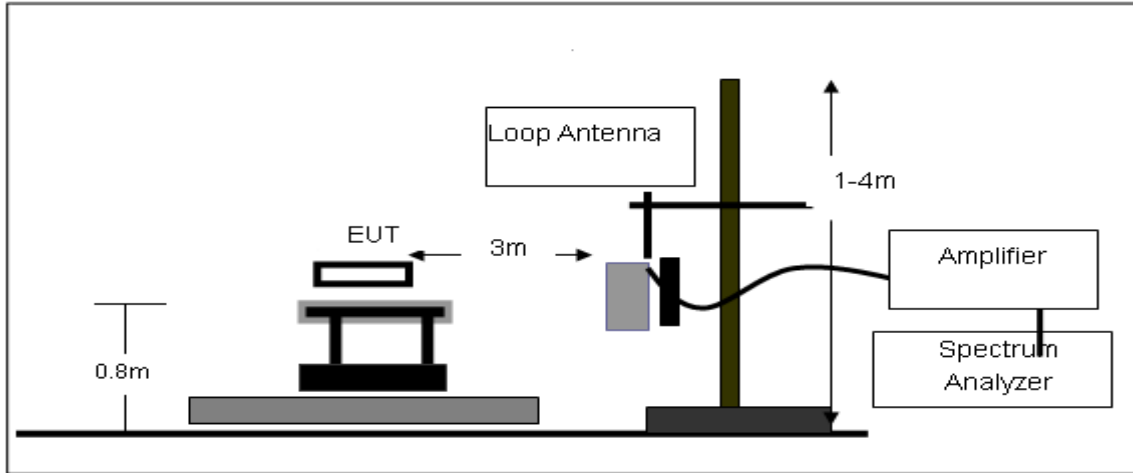

(B) Radiated Emission Test-Up Frequency 30MHz~1GHz

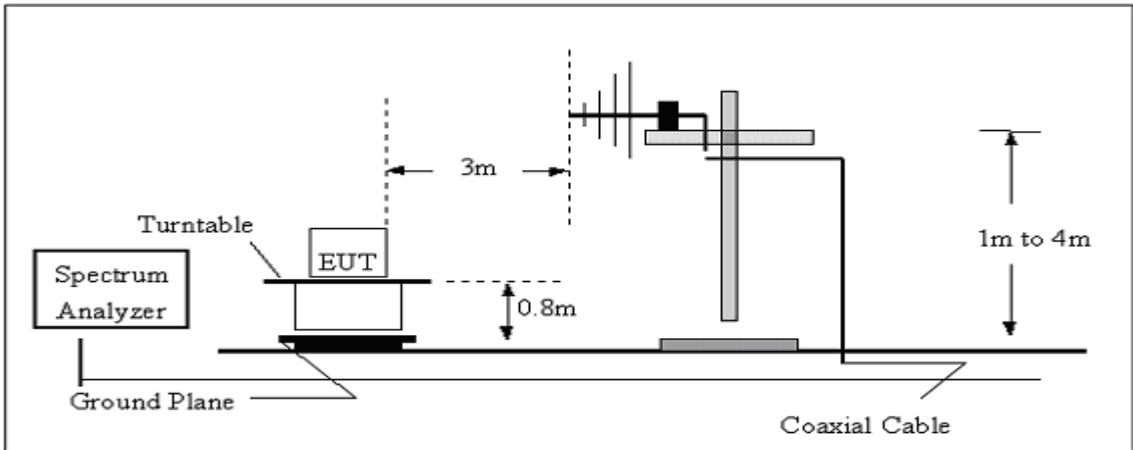

(C) Radiated Emission Test-Up Frequency Above 1GHz

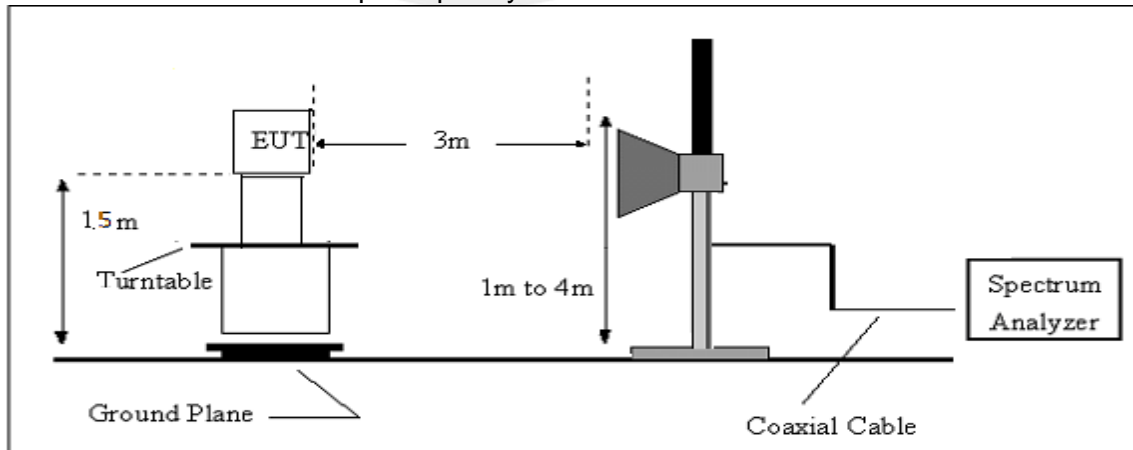



3.2.4 EUT OPERATING CONDITIONS

The EUT tested system was configured as the statements of 2.4 Unless otherwise a special operating condition is specified in the follows during the testing.

3.2.5 FIELD STRENGTH CALCULATION

The field strength is calculated by adding the Antenna Factor and Cable Factor and subtracting the Amplifier Gain and Duty Cycle Correction Factor (if any) from the measured reading. The basic equation with a sample calculation is as follows:

$$FS = RA + AF + CL - AG$$

Where

FS = Field Strength

CL = Cable Attenuation Factor (Cable Loss)

RA = Reading Amplitude

AG = Amplifier Gain

AF = Antenna Factor

For example

| Frequency (MHz) | FS (dB μ V/m) | RA (dB μ V/m) | AF (dB) | CL (dB) | AG (dB) | Factor (dB) |
|--------------------|----------------------|----------------------|------------|------------|------------|----------------|
| 300 | 40 | 58.1 | 12.2 | 1.6 | 31.9 | -18.1 |

$$\text{Factor} = \text{AF} + \text{CL} - \text{AG}$$

**3.2.6 TEST RESULTS (Between 9KHz – 30 MHz)**

| | | | |
|----------------|-----------------------|--------------------|-----|
| Temperature: | 24.8 °C | Relative Humidity: | 60% |
| Test Voltage : | DC 3.85V from Battery | Polarization : | -- |
| Test Mode : | TX Mode | | |

| Freq. | Reading | Limit | Margin | State |
|-------|----------|----------|--------|-------|
| (MHz) | (dBuV/m) | (dBuV/m) | (dB) | P/F |
| -- | -- | -- | -- | PASS |
| -- | -- | -- | -- | PASS |

Note:

The amplitude of spurious emissions which are attenuated by more than 20dB below the permissible value has no need to be reported.

Distance extrapolation factor = $40 \log(\text{specific distance}/\text{test distance})$ (dB);

Limit line = specific limits(dBuv) + distance extrapolation factor.



3.2.7 TEST RESULTS (Between 30MHz – 1GHz)

| | | | |
|--------------|---------------------------------|-------------------|------------|
| Temperature | 24.8 °C | Relative Humidity | 60% |
| Test Voltage | DC 3.85V from Battery | Polarization | Horizontal |
| Test Mode | Mode 1-12(Mode 5-6M worst mode) | | |

| Frequency (MHz) | Reading (dBUV) | Correct Factor(dB/m) | Result (dBUV/m) | Limit (dBUV/m) | Margin (dB) | Remark |
|-----------------|----------------|----------------------|-----------------|----------------|-------------|--------|
| 30.2110 | 34.00 | -11.30 | 22.70 | 40.00 | -17.30 | QP |
| 67.9128 | 46.54 | -24.15 | 22.39 | 40.00 | -17.61 | QP |
| 100.2286 | 41.92 | -19.17 | 22.75 | 43.50 | -20.75 | QP |
| 209.3130 | 45.67 | -19.78 | 25.89 | 43.50 | -17.61 | QP |
| 318.8170 | 37.14 | -14.21 | 22.93 | 46.00 | -23.07 | QP |
| 543.2740 | 31.61 | -6.92 | 24.69 | 46.00 | -21.31 | QP |

Remark:

1. Margin = Result (Result = Reading + Factor) – Limit

80.0 dBUV/m

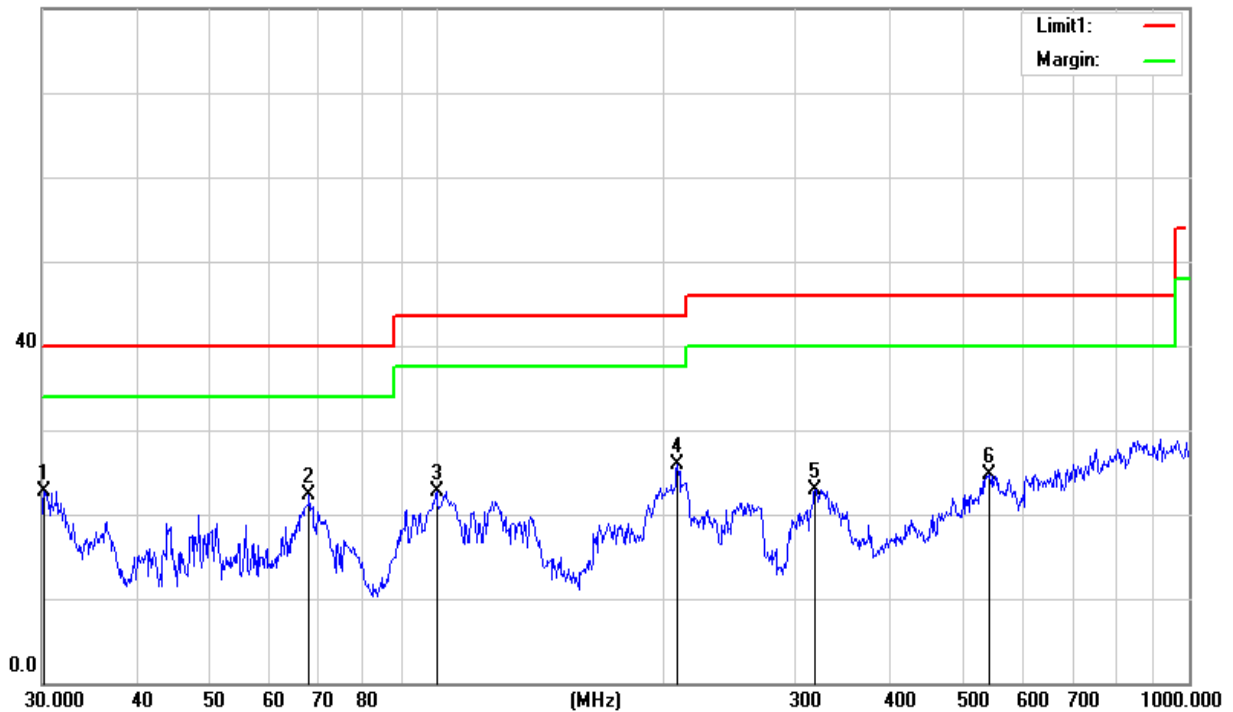



| | | | |
|--------------|---------------------------------|-------------------|----------|
| Temperature | 24.8°C | Relative Humidity | 60% |
| Test Voltage | DC 3.85V from Battery | Polarization | Vertical |
| Test Mode | Mode 1-12(Mode 5-6M worst mode) | | |

| Frequency (MHz) | Reading (dBuV) | Correct Factor(dB/m) | Result (dBuV/m) | Limit (dBuV/m) | Margin (dB) | Remark |
|-----------------|----------------|----------------------|-----------------|----------------|-------------|--------|
| 48.5016 | 41.53 | -20.71 | 20.82 | 40.00 | -19.18 | QP |
| 68.6310 | 45.58 | -24.14 | 21.44 | 40.00 | -18.56 | QP |
| 100.2286 | 42.92 | -19.17 | 23.75 | 43.50 | -19.75 | QP |
| 198.5880 | 44.24 | -20.19 | 24.05 | 43.50 | -19.45 | QP |
| 752.7432 | 30.78 | -3.57 | 27.21 | 46.00 | -18.79 | QP |
| 916.0687 | 30.71 | -1.71 | 29.00 | 46.00 | -17.00 | QP |

Remark:

1. Margin = Result (Result =Reading + Factor)–Limit

80.0 dBuV/m

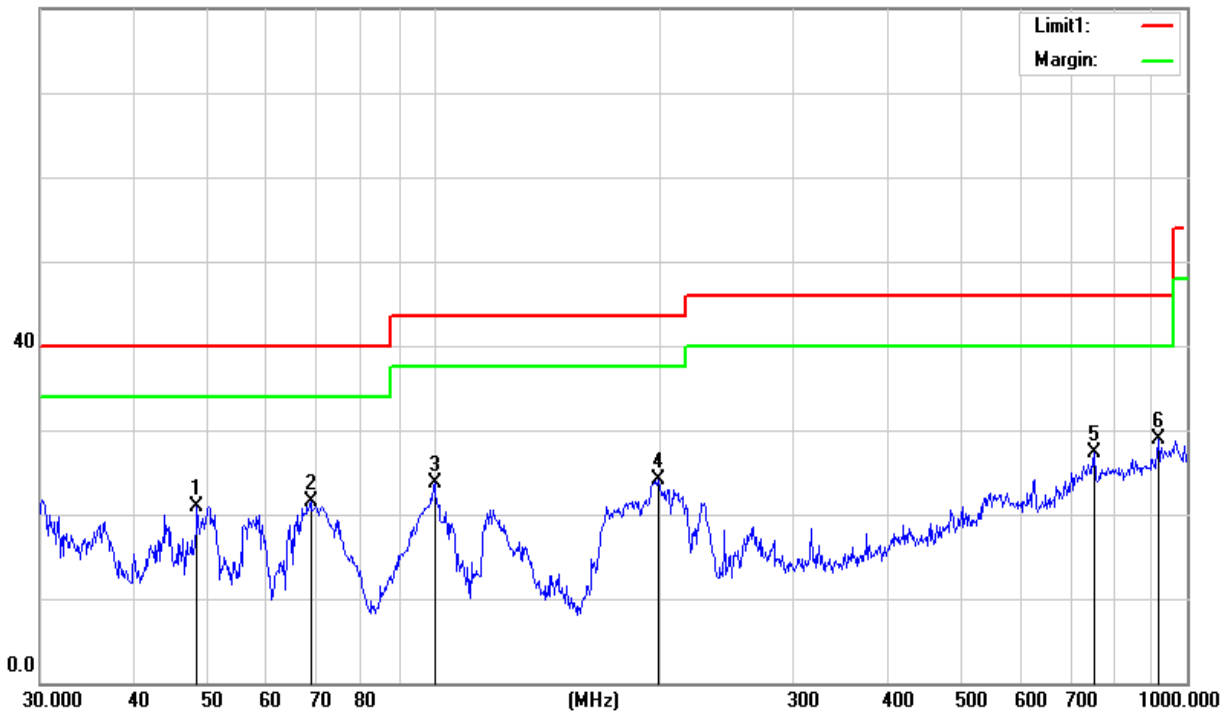



3.2.8 TEST RESULTS (Above 1000 MHz)

Band I 5150-5250MHz

| Band I(5.15-5.25) GHz | | | | | | | | | | |
|-----------------------------------|---------|-----------|-------|---------|-----------|----------|-------------------|-------------------|----------|------------|
| Frequency (MHz) | Reading | Amplifier | Loss | Antenna | Corrected | Emission | Limit (dBuV/m) | Margin | Detector | Comment |
| | (dBuV) | (dB) | (dB) | (dB/m) | Factor | Factor | | Level (dBμV/m) | | |
| Low Channel (802.11n20/ 5180 MHz) | | | | | | | | | | |
| 3257.41 | 43.78 | 44.70 | 6.70 | 28.20 | -9.80 | 33.98 | 74.00 | -40.02 | PK | Vertical |
| 3257.41 | 41.07 | 44.70 | 6.70 | 28.20 | -9.80 | 31.27 | 54.00 | -22.73 | AV | Vertical |
| 3262.55 | 44.70 | 44.70 | 6.70 | 28.20 | -9.80 | 34.90 | 74.00 | -39.10 | PK | Horizontal |
| 3262.55 | 41.77 | 44.70 | 6.70 | 28.20 | -9.80 | 31.97 | 54.00 | -22.03 | AV | Horizontal |
| 3998.93 | 38.93 | 44.20 | 7.90 | 29.70 | -6.60 | 32.33 | 74.00 | -41.67 | PK | Vertical |
| 3998.93 | 36.08 | 44.20 | 7.90 | 29.70 | -6.60 | 29.48 | 54.00 | -24.52 | AV | Vertical |
| 3981.69 | 38.79 | 44.20 | 7.90 | 29.70 | -6.60 | 32.19 | 74.00 | -41.81 | PK | Horizontal |
| 3981.69 | 36.38 | 44.20 | 7.90 | 29.70 | -6.60 | 29.78 | 54.00 | -24.22 | AV | Horizontal |
| 7225.27 | 37.45 | 43.50 | 11.40 | 35.50 | 3.40 | 40.85 | 74.00 | -33.15 | PK | Vertical |
| 7225.27 | 33.53 | 43.50 | 11.40 | 35.50 | 3.40 | 36.93 | 54.00 | -17.07 | AV | Vertical |
| 7219.09 | 37.26 | 43.50 | 11.40 | 35.50 | 3.40 | 40.66 | 74.00 | -33.34 | PK | Horizontal |
| 7219.09 | 33.88 | 43.50 | 11.40 | 35.50 | 3.40 | 37.28 | 54.00 | -16.72 | AV | Horizontal |
| 10360.03 | 39.31 | 44.50 | 13.80 | 38.80 | 8.10 | 47.41 | 74.00 | -26.59 | PK | Vertical |
| 10360.03 | 37.06 | 44.50 | 13.80 | 38.80 | 8.10 | 45.16 | 54.00 | -8.84 | AV | Vertical |
| 10360.02 | 39.34 | 44.50 | 13.80 | 38.80 | 8.10 | 47.44 | 74.00 | -26.56 | PK | Horizontal |
| 10360.02 | 36.82 | 44.50 | 13.80 | 38.80 | 8.10 | 44.92 | 54.00 | -9.08 | AV | Horizontal |
| 11018.74 | 32.84 | 43.60 | 14.30 | 39.50 | 10.20 | 43.04 | 74.00 | -30.96 | PK | Vertical |
| 11018.74 | 30.13 | 43.60 | 14.30 | 39.50 | 10.20 | 40.33 | 54.00 | -13.67 | AV | Vertical |
| 11017.81 | 32.94 | 43.60 | 14.30 | 39.50 | 10.20 | 43.14 | 74.00 | -30.86 | PK | Horizontal |
| 11017.81 | 29.86 | 43.60 | 14.30 | 39.50 | 10.20 | 40.06 | 54.00 | -13.94 | AV | Horizontal |
| 13286.74 | 31.62 | 42.60 | 15.90 | 38.90 | 12.20 | 43.82 | 74.00 | -30.18 | PK | Vertical |
| 13286.74 | 28.93 | 42.60 | 15.90 | 38.90 | 12.20 | 41.13 | 54.00 | -12.87 | AV | Vertical |
| 13287.69 | 31.78 | 42.60 | 15.90 | 38.90 | 12.20 | 43.98 | 74.00 | -30.02 | PK | Horizontal |
| 13287.69 | 29.38 | 42.60 | 15.90 | 38.90 | 12.20 | 41.58 | 54.00 | -12.42 | AV | Horizontal |



| Mid Channel (802.11 n20/ 5200 MHz) | | | | | | | | | | |
|------------------------------------|-------|-------|-------|-------|-------|-------|-------|--------|----|------------|
| 3251.87 | 44.26 | 44.70 | 6.70 | 28.20 | -9.80 | 34.46 | 74.00 | -39.54 | PK | Vertical |
| 3251.87 | 41.36 | 44.70 | 6.70 | 28.20 | -9.80 | 31.56 | 54.00 | -22.44 | AV | Vertical |
| 3248.00 | 44.65 | 44.70 | 6.70 | 28.20 | -9.80 | 34.85 | 74.00 | -39.15 | PK | Horizontal |
| 3248.00 | 41.85 | 44.70 | 6.70 | 28.20 | -9.80 | 32.05 | 54.00 | -21.95 | AV | Horizontal |
| 3993.48 | 39.19 | 44.20 | 7.90 | 29.70 | -6.60 | 32.59 | 74.00 | -41.41 | PK | Vertical |
| 3993.48 | 36.73 | 44.20 | 7.90 | 29.70 | -6.60 | 30.13 | 54.00 | -23.87 | AV | Vertical |
| 3996.10 | 38.81 | 44.20 | 7.90 | 29.70 | -6.60 | 32.21 | 74.00 | -41.79 | PK | Horizontal |
| 3996.10 | 36.95 | 44.20 | 7.90 | 29.70 | -6.60 | 30.35 | 54.00 | -23.65 | AV | Horizontal |
| 7220.89 | 36.54 | 43.50 | 11.40 | 35.50 | 3.40 | 39.94 | 74.00 | -34.06 | PK | Vertical |
| 7220.89 | 34.19 | 43.50 | 11.40 | 35.50 | 3.40 | 37.59 | 54.00 | -16.41 | AV | Vertical |
| 7231.12 | 37.66 | 43.50 | 11.40 | 35.50 | 3.40 | 41.06 | 74.00 | -32.94 | PK | Horizontal |
| 7231.12 | 33.73 | 43.50 | 11.40 | 35.50 | 3.40 | 37.13 | 54.00 | -16.87 | AV | Horizontal |
| 10399.96 | 39.70 | 44.50 | 13.80 | 38.80 | 8.10 | 47.80 | 74.00 | -26.20 | PK | Vertical |
| 10399.96 | 36.98 | 44.50 | 13.80 | 38.80 | 8.10 | 45.08 | 54.00 | -8.92 | AV | Vertical |
| 10400.30 | 39.24 | 44.50 | 13.80 | 38.80 | 8.10 | 47.34 | 74.00 | -26.66 | PK | Horizontal |
| 10400.30 | 35.94 | 44.50 | 13.80 | 38.80 | 8.10 | 44.04 | 54.00 | -9.96 | AV | Horizontal |
| 11033.44 | 34.03 | 43.60 | 14.30 | 39.50 | 10.20 | 44.23 | 74.00 | -29.77 | PK | Vertical |
| 11033.44 | 30.16 | 43.60 | 14.30 | 39.50 | 10.20 | 40.36 | 54.00 | -13.64 | AV | Vertical |
| 11023.66 | 33.62 | 43.60 | 14.30 | 39.50 | 10.20 | 43.82 | 74.00 | -30.18 | PK | Horizontal |
| 11023.66 | 30.90 | 43.60 | 14.30 | 39.50 | 10.20 | 41.10 | 54.00 | -12.90 | AV | Horizontal |
| 13286.67 | 32.56 | 42.60 | 15.90 | 38.90 | 12.20 | 44.76 | 74.00 | -29.24 | PK | Vertical |
| 13286.67 | 28.87 | 42.60 | 15.90 | 38.90 | 12.20 | 41.07 | 54.00 | -12.93 | AV | Vertical |
| 13285.47 | 31.75 | 42.60 | 15.90 | 38.90 | 12.20 | 43.95 | 74.00 | -30.05 | PK | Horizontal |
| 13285.47 | 29.70 | 42.60 | 15.90 | 38.90 | 12.20 | 41.90 | 54.00 | -12.10 | AV | Horizontal |



| High Channel (802.11 n20/ 5240 MHz) | | | | | | | | | | |
|-------------------------------------|-------|-------|-------|-------|-------|-------|-------|--------|----|------------|
| 3255.68 | 43.99 | 44.70 | 6.70 | 28.20 | -9.80 | 34.19 | 74.00 | -39.81 | PK | Vertical |
| 3255.68 | 41.71 | 44.70 | 6.70 | 28.20 | -9.80 | 31.91 | 54.00 | -22.09 | AV | Vertical |
| 3256.59 | 45.10 | 44.70 | 6.70 | 28.20 | -9.80 | 35.30 | 74.00 | -38.70 | PK | Horizontal |
| 3256.59 | 42.07 | 44.70 | 6.70 | 28.20 | -9.80 | 32.27 | 54.00 | -21.73 | AV | Horizontal |
| 3992.62 | 39.55 | 44.20 | 7.90 | 29.70 | -6.60 | 32.95 | 74.00 | -41.05 | PK | Vertical |
| 3992.62 | 35.93 | 44.20 | 7.90 | 29.70 | -6.60 | 29.33 | 54.00 | -24.67 | AV | Vertical |
| 3980.67 | 39.65 | 44.20 | 7.90 | 29.70 | -6.60 | 33.05 | 74.00 | -40.95 | PK | Horizontal |
| 3980.67 | 36.69 | 44.20 | 7.90 | 29.70 | -6.60 | 30.09 | 54.00 | -23.91 | AV | Horizontal |
| 7220.57 | 37.73 | 43.50 | 11.40 | 35.50 | 3.40 | 41.13 | 74.00 | -32.87 | PK | Vertical |
| 7220.57 | 34.38 | 43.50 | 11.40 | 35.50 | 3.40 | 37.78 | 54.00 | -16.22 | AV | Vertical |
| 7227.35 | 36.46 | 43.50 | 11.40 | 35.50 | 3.40 | 39.86 | 74.00 | -34.14 | PK | Horizontal |
| 7227.35 | 34.63 | 43.50 | 11.40 | 35.50 | 3.40 | 38.03 | 54.00 | -15.97 | AV | Horizontal |
| 10480.21 | 39.12 | 44.50 | 13.80 | 38.80 | 8.10 | 47.22 | 74.00 | -26.78 | PK | Vertical |
| 10480.21 | 37.06 | 44.50 | 13.80 | 38.80 | 8.10 | 45.16 | 54.00 | -8.84 | AV | Vertical |
| 10479.95 | 39.15 | 44.50 | 13.80 | 38.80 | 8.10 | 47.25 | 74.00 | -26.75 | PK | Horizontal |
| 10479.95 | 36.37 | 44.50 | 13.80 | 38.80 | 8.10 | 44.47 | 54.00 | -9.53 | AV | Horizontal |
| 11019.68 | 33.19 | 43.60 | 14.30 | 39.50 | 10.20 | 43.39 | 74.00 | -30.61 | PK | Vertical |
| 11019.68 | 29.94 | 43.60 | 14.30 | 39.50 | 10.20 | 40.14 | 54.00 | -13.86 | AV | Vertical |
| 11017.56 | 33.53 | 43.60 | 14.30 | 39.50 | 10.20 | 43.73 | 74.00 | -30.27 | PK | Horizontal |
| 11017.56 | 30.73 | 43.60 | 14.30 | 39.50 | 10.20 | 40.93 | 54.00 | -13.07 | AV | Horizontal |
| 13286.74 | 31.87 | 42.60 | 15.90 | 38.90 | 12.20 | 44.07 | 74.00 | -29.93 | PK | Vertical |
| 13286.74 | 29.61 | 42.60 | 15.90 | 38.90 | 12.20 | 41.81 | 54.00 | -12.19 | AV | Vertical |
| 13284.78 | 32.27 | 42.60 | 15.90 | 38.90 | 12.20 | 44.47 | 74.00 | -29.53 | PK | Horizontal |
| 13284.78 | 29.92 | 42.60 | 15.90 | 38.90 | 12.20 | 42.12 | 54.00 | -11.88 | AV | Horizontal |

Remark:

1. Factor = Antenna Factor + Cable Loss – Pre-amplifier.
2. Scan with 802.11a, 802.11n (HT-20), 802.11n (HT-40), the worst case is 802.11n (HT-20).
3. The frequency emission of peak points that did not show above the forms are at least 20dB below the limit, the frequency emission is mainly from the environment noise.



Band II 5250-5350MHz

| Band II(5.25-5.35) GHz | | | | | | | | | | |
|------------------------------------|---------|-----------|-------|-------------------|---------------------|-------------------|-------------------|--------|----------|------------|
| Frequency (MHz) | Reading | Amplifier | Loss | Antenna Factor | Corrected Factor | Emission Level | Limit (dBuV/m) | Margin | Detector | Comment |
| | (dBuV) | (dB) | (dB) | (dB/m) | (dB) | (dBμV/m) | | (dB) | | |
| Low Channel (802.11 n20/ 5260 MHz) | | | | | | | | | | |
| 3248.53 | 44.98 | 44.70 | 6.70 | 28.20 | -9.80 | 35.18 | 74.00 | -38.82 | PK | Vertical |
| 3248.53 | 41.79 | 44.70 | 6.70 | 28.20 | -9.80 | 31.99 | 54.00 | -22.01 | AV | Vertical |
| 3253.75 | 45.05 | 44.70 | 6.70 | 28.20 | -9.80 | 35.25 | 74.00 | -38.75 | PK | Horizontal |
| 3253.75 | 42.22 | 44.70 | 6.70 | 28.20 | -9.80 | 32.42 | 54.00 | -21.58 | AV | Horizontal |
| 3982.58 | 38.64 | 44.20 | 7.90 | 29.70 | -6.60 | 32.04 | 74.00 | -41.96 | PK | Vertical |
| 3982.58 | 35.82 | 44.20 | 7.90 | 29.70 | -6.60 | 29.22 | 54.00 | -24.78 | AV | Vertical |
| 3984.94 | 39.69 | 44.20 | 7.90 | 29.70 | -6.60 | 33.09 | 74.00 | -40.91 | PK | Horizontal |
| 3984.94 | 36.02 | 44.20 | 7.90 | 29.70 | -6.60 | 29.42 | 54.00 | -24.58 | AV | Horizontal |
| 7229.51 | 36.47 | 43.50 | 11.40 | 35.50 | 3.40 | 39.87 | 74.00 | -34.13 | PK | Vertical |
| 7229.51 | 34.15 | 43.50 | 11.40 | 35.50 | 3.40 | 37.55 | 54.00 | -16.45 | AV | Vertical |
| 7232.59 | 36.90 | 43.50 | 11.40 | 35.50 | 3.40 | 40.30 | 74.00 | -33.70 | PK | Horizontal |
| 7232.59 | 34.62 | 43.50 | 11.40 | 35.50 | 3.40 | 38.02 | 54.00 | -15.98 | AV | Horizontal |
| 10520.21 | 39.85 | 44.50 | 13.90 | 38.80 | 8.20 | 48.05 | 74.00 | -25.95 | PK | Vertical |
| 10520.21 | 35.75 | 44.50 | 13.90 | 38.80 | 8.20 | 43.95 | 54.00 | -10.05 | AV | Vertical |
| 10520.12 | 38.80 | 44.50 | 13.90 | 38.80 | 8.20 | 47.00 | 74.00 | -27.00 | PK | Horizontal |
| 10520.12 | 35.78 | 44.50 | 13.90 | 38.80 | 8.20 | 43.98 | 54.00 | -10.02 | AV | Horizontal |
| 11034.36 | 32.88 | 43.60 | 14.30 | 39.50 | 10.20 | 43.08 | 74.00 | -30.92 | PK | Vertical |
| 11034.36 | 29.69 | 43.60 | 14.30 | 39.50 | 10.20 | 39.89 | 54.00 | -14.11 | AV | Vertical |
| 11029.21 | 32.80 | 43.60 | 14.30 | 39.50 | 10.20 | 43.00 | 74.00 | -31.00 | PK | Horizontal |
| 11029.21 | 30.02 | 43.60 | 14.30 | 39.50 | 10.20 | 40.22 | 54.00 | -13.78 | AV | Horizontal |
| 13283.30 | 32.63 | 42.60 | 15.90 | 38.90 | 12.20 | 44.83 | 74.00 | -29.17 | PK | Vertical |
| 13283.30 | 29.17 | 42.60 | 15.90 | 38.90 | 12.20 | 41.37 | 54.00 | -12.63 | AV | Vertical |
| 13284.27 | 32.73 | 42.60 | 15.90 | 38.90 | 12.20 | 44.93 | 74.00 | -29.07 | PK | Horizontal |
| 13284.27 | 28.63 | 42.60 | 15.90 | 38.90 | 12.20 | 40.83 | 54.00 | -13.17 | AV | Horizontal |



| Mid Channel (802.11 n20/ 5300 MHz) | | | | | | | | | | |
|------------------------------------|-------|-------|-------|-------|-------|-------|-------|--------|----|------------|
| 3259.96 | 43.93 | 44.70 | 6.70 | 28.20 | -9.80 | 34.13 | 74.00 | -39.87 | PK | Vertical |
| 3259.96 | 41.43 | 44.70 | 6.70 | 28.20 | -9.80 | 31.63 | 54.00 | -22.37 | AV | Vertical |
| 3257.30 | 44.55 | 44.70 | 6.70 | 28.20 | -9.80 | 34.75 | 74.00 | -39.25 | PK | Horizontal |
| 3257.30 | 41.15 | 44.70 | 6.70 | 28.20 | -9.80 | 31.35 | 54.00 | -22.65 | AV | Horizontal |
| 3984.54 | 39.27 | 44.20 | 7.90 | 29.70 | -6.60 | 32.67 | 74.00 | -41.33 | PK | Vertical |
| 3984.54 | 36.21 | 44.20 | 7.90 | 29.70 | -6.60 | 29.61 | 54.00 | -24.39 | AV | Vertical |
| 3995.27 | 39.49 | 44.20 | 7.90 | 29.70 | -6.60 | 32.89 | 74.00 | -41.11 | PK | Horizontal |
| 3995.27 | 37.05 | 44.20 | 7.90 | 29.70 | -6.60 | 30.45 | 54.00 | -23.55 | AV | Horizontal |
| 7224.51 | 37.51 | 43.50 | 11.40 | 35.50 | 3.40 | 40.91 | 74.00 | -33.09 | PK | Vertical |
| 7224.51 | 34.41 | 43.50 | 11.40 | 35.50 | 3.40 | 37.81 | 54.00 | -16.19 | AV | Vertical |
| 7220.16 | 37.62 | 43.50 | 11.40 | 35.50 | 3.40 | 41.02 | 74.00 | -32.98 | PK | Horizontal |
| 7220.16 | 34.65 | 43.50 | 11.40 | 35.50 | 3.40 | 38.05 | 54.00 | -15.95 | AV | Horizontal |
| 10600.31 | 39.65 | 44.50 | 13.80 | 38.80 | 8.10 | 47.75 | 74.00 | -26.25 | PK | Vertical |
| 10600.31 | 35.92 | 44.50 | 13.80 | 38.80 | 8.10 | 44.02 | 54.00 | -9.98 | AV | Vertical |
| 10600.42 | 39.96 | 44.50 | 13.80 | 38.80 | 8.10 | 48.06 | 74.00 | -25.94 | PK | Horizontal |
| 10600.42 | 36.93 | 44.50 | 13.80 | 38.80 | 8.10 | 45.03 | 54.00 | -8.97 | AV | Horizontal |
| 11017.53 | 33.45 | 43.60 | 14.30 | 39.50 | 10.20 | 43.65 | 74.00 | -30.35 | PK | Vertical |
| 11017.53 | 30.06 | 43.60 | 14.30 | 39.50 | 10.20 | 40.26 | 54.00 | -13.74 | AV | Vertical |
| 11034.95 | 33.89 | 43.60 | 14.30 | 39.50 | 10.20 | 44.09 | 74.00 | -29.91 | PK | Horizontal |
| 11034.95 | 30.03 | 43.60 | 14.30 | 39.50 | 10.20 | 40.23 | 54.00 | -13.77 | AV | Horizontal |
| 13292.38 | 32.45 | 42.60 | 15.90 | 38.90 | 12.20 | 44.65 | 74.00 | -29.35 | PK | Vertical |
| 13292.38 | 29.79 | 42.60 | 15.90 | 38.90 | 12.20 | 41.99 | 54.00 | -12.01 | AV | Vertical |
| 13288.30 | 32.58 | 42.60 | 15.90 | 38.90 | 12.20 | 44.78 | 74.00 | -29.22 | PK | Horizontal |



| High Channel (802.11 n20/ 5320 MHz) | | | | | | | | | | |
|-------------------------------------|-------|-------|-------|-------|-------|-------|-------|--------|----|------------|
| 3247.15 | 43.87 | 44.70 | 6.70 | 28.20 | -9.80 | 34.07 | 74.00 | -39.93 | PK | Vertical |
| 3247.15 | 41.05 | 44.70 | 6.70 | 28.20 | -9.80 | 31.25 | 54.00 | -22.75 | AV | Vertical |
| 3256.62 | 44.78 | 44.70 | 6.70 | 28.20 | -9.80 | 34.98 | 74.00 | -39.02 | PK | Horizontal |
| 3256.62 | 41.72 | 44.70 | 6.70 | 28.20 | -9.80 | 31.92 | 54.00 | -22.08 | AV | Horizontal |
| 3998.19 | 39.48 | 44.20 | 7.90 | 29.70 | -6.60 | 32.88 | 74.00 | -41.12 | PK | Vertical |
| 3998.19 | 37.14 | 44.20 | 7.90 | 29.70 | -6.60 | 30.54 | 54.00 | -23.46 | AV | Vertical |
| 3996.90 | 39.57 | 44.20 | 7.90 | 29.70 | -6.60 | 32.97 | 74.00 | -41.03 | PK | Horizontal |
| 3996.90 | 36.10 | 44.20 | 7.90 | 29.70 | -6.60 | 29.50 | 54.00 | -24.50 | AV | Horizontal |
| 7223.15 | 37.39 | 43.50 | 11.40 | 35.50 | 3.40 | 40.79 | 74.00 | -33.21 | PK | Vertical |
| 7223.15 | 34.66 | 43.50 | 11.40 | 35.50 | 3.40 | 38.06 | 54.00 | -15.94 | AV | Vertical |
| 7223.17 | 37.05 | 43.50 | 11.40 | 35.50 | 3.40 | 40.45 | 74.00 | -33.55 | PK | Horizontal |
| 7223.17 | 34.47 | 43.50 | 11.40 | 35.50 | 3.40 | 37.87 | 54.00 | -16.13 | AV | Horizontal |
| 10640.13 | 39.18 | 44.50 | 13.80 | 38.80 | 8.10 | 47.28 | 74.00 | -26.72 | PK | Vertical |
| 10640.13 | 36.95 | 44.50 | 13.80 | 38.80 | 8.10 | 45.05 | 54.00 | -8.95 | AV | Vertical |
| 10640.36 | 40.00 | 44.50 | 13.80 | 38.80 | 8.10 | 48.10 | 74.00 | -25.90 | PK | Horizontal |
| 10640.36 | 36.34 | 44.50 | 13.80 | 38.80 | 8.10 | 44.44 | 54.00 | -9.56 | AV | Horizontal |
| 11029.81 | 33.13 | 43.60 | 14.30 | 39.50 | 10.20 | 43.33 | 74.00 | -30.67 | PK | Vertical |
| 11029.81 | 31.10 | 43.60 | 14.30 | 39.50 | 10.20 | 41.30 | 54.00 | -12.70 | AV | Vertical |
| 11019.23 | 33.78 | 43.60 | 14.30 | 39.50 | 10.20 | 43.98 | 74.00 | -30.02 | PK | Horizontal |
| 11019.23 | 30.46 | 43.60 | 14.30 | 39.50 | 10.20 | 40.66 | 54.00 | -13.34 | AV | Horizontal |
| 13297.42 | 32.44 | 42.70 | 18.00 | 37.10 | 12.40 | 44.84 | 74.00 | -29.16 | PK | Vertical |
| 13297.42 | 29.90 | 42.70 | 18.00 | 37.10 | 12.40 | 42.30 | 54.00 | -11.70 | AV | Vertical |
| 13291.98 | 32.53 | 42.70 | 18.00 | 37.10 | 12.40 | 44.93 | 74.00 | -29.07 | PK | Horizontal |
| 13291.98 | 28.62 | 42.70 | 18.00 | 37.10 | 12.40 | 41.02 | 54.00 | -12.98 | AV | Horizontal |

Remark:

1. Factor = Antenna Factor + Cable Loss – Pre-amplifier.
2. Scan with 802.11a, 802.11n (HT-20), 802.11n (HT-40), the worst case is 802.11n (HT-20).
3. The frequency emission of peak points that did not show above the forms are at least 20dB below the limit, the frequency emission is mainly from the environment noise.



Band III 5470-5725MHz

| Band III(5.47-5.725) GHz | | | | | | | | | | |
|------------------------------------|---------|-----------|-------|-------------------|---------------------|-------------------|-------------------|--------|----------|------------|
| Frequency (MHz) | Reading | Amplifier | Loss | Antenna Factor | Corrected Factor | Emission Level | Limit (dBuV/m) | Margin | Detector | Comment |
| | (dBuV) | (dB) | (dB) | (dB/m) | (dB) | (dBμV/m) | | (dB) | | |
| Low Channel (802.11 n20/ 5500 MHz) | | | | | | | | | | |
| 3249.06 | 44.16 | 44.70 | 6.70 | 28.20 | -9.80 | 34.36 | 74.00 | -39.64 | PK | Vertical |
| 3249.06 | 41.24 | 44.70 | 6.70 | 28.20 | -9.80 | 31.44 | 54.00 | -22.56 | AV | Vertical |
| 3254.92 | 43.78 | 44.70 | 6.70 | 28.20 | -9.80 | 33.98 | 74.00 | -40.02 | PK | Horizontal |
| 3254.92 | 42.23 | 44.70 | 6.70 | 28.20 | -9.80 | 32.43 | 54.00 | -21.57 | AV | Horizontal |
| 3984.43 | 39.74 | 44.20 | 7.90 | 29.70 | -6.60 | 33.14 | 74.00 | -40.86 | PK | Vertical |
| 3984.43 | 35.90 | 44.20 | 7.90 | 29.70 | -6.60 | 29.30 | 54.00 | -24.70 | AV | Vertical |
| 3998.66 | 39.69 | 44.20 | 7.90 | 29.70 | -6.60 | 33.09 | 74.00 | -40.91 | PK | Horizontal |
| 3998.66 | 36.50 | 44.20 | 7.90 | 29.70 | -6.60 | 29.90 | 54.00 | -24.10 | AV | Horizontal |
| 7233.95 | 36.82 | 43.50 | 11.40 | 35.50 | 3.40 | 40.22 | 74.00 | -33.78 | PK | Vertical |
| 7233.95 | 34.39 | 43.50 | 11.40 | 35.50 | 3.40 | 37.79 | 54.00 | -16.21 | AV | Vertical |
| 7230.99 | 37.72 | 43.50 | 11.40 | 35.50 | 3.40 | 41.12 | 74.00 | -32.88 | PK | Horizontal |
| 7230.99 | 34.12 | 43.50 | 11.40 | 35.50 | 3.40 | 37.52 | 54.00 | -16.48 | AV | Horizontal |
| 10348.54 | 39.17 | 44.50 | 13.80 | 38.80 | 8.10 | 47.27 | 74.00 | -26.73 | PK | Vertical |
| 10348.54 | 35.90 | 44.50 | 13.80 | 38.80 | 8.10 | 44.00 | 54.00 | -10.00 | AV | Vertical |
| 10356.51 | 39.12 | 44.50 | 13.80 | 38.80 | 8.10 | 47.22 | 74.00 | -26.78 | PK | Horizontal |
| 10356.51 | 36.38 | 44.50 | 13.80 | 38.80 | 8.10 | 44.48 | 54.00 | -9.52 | AV | Horizontal |
| 11000.19 | 33.87 | 43.60 | 14.30 | 39.50 | 10.20 | 44.07 | 74.00 | -29.93 | PK | Vertical |
| 11000.19 | 30.20 | 43.60 | 14.30 | 39.50 | 10.20 | 40.40 | 54.00 | -13.60 | AV | Vertical |
| 11000.39 | 32.88 | 43.60 | 14.30 | 39.50 | 10.20 | 43.08 | 74.00 | -30.92 | PK | Horizontal |
| 11000.39 | 30.75 | 43.60 | 14.30 | 39.50 | 10.20 | 40.95 | 54.00 | -13.05 | AV | Horizontal |
| 13280.11 | 33.01 | 42.60 | 15.90 | 38.90 | 12.20 | 45.21 | 74.00 | -28.79 | PK | Vertical |
| 13280.11 | 28.87 | 42.60 | 15.90 | 38.90 | 12.20 | 41.07 | 54.00 | -12.93 | AV | Vertical |
| 13282.85 | 31.67 | 42.60 | 15.90 | 38.90 | 12.20 | 43.87 | 74.00 | -30.13 | PK | Horizontal |
| 13282.85 | 28.87 | 42.60 | 15.90 | 38.90 | 12.20 | 41.07 | 54.00 | -12.93 | AV | Horizontal |



| Mid Channel (802.11 n20/ 5580 MHz) | | | | | | | | | | |
|------------------------------------|-------|-------|-------|-------|-------|-------|-------|--------|----|------------|
| 3254.15 | 45.15 | 44.70 | 6.70 | 28.20 | -9.80 | 35.35 | 74.00 | -38.65 | PK | Vertical |
| 3254.15 | 41.27 | 44.70 | 6.70 | 28.20 | -9.80 | 31.47 | 54.00 | -22.53 | AV | Vertical |
| 3261.12 | 44.30 | 44.70 | 6.70 | 28.20 | -9.80 | 34.50 | 74.00 | -39.50 | PK | Horizontal |
| 3261.12 | 41.50 | 44.70 | 6.70 | 28.20 | -9.80 | 31.70 | 54.00 | -22.30 | AV | Horizontal |
| 3981.12 | 38.94 | 44.20 | 7.90 | 29.70 | -6.60 | 32.34 | 74.00 | -41.66 | PK | Vertical |
| 3981.12 | 37.08 | 44.20 | 7.90 | 29.70 | -6.60 | 30.48 | 54.00 | -23.52 | AV | Vertical |
| 3996.22 | 39.75 | 44.20 | 7.90 | 29.70 | -6.60 | 33.15 | 74.00 | -40.85 | PK | Horizontal |
| 3996.22 | 36.02 | 44.20 | 7.90 | 29.70 | -6.60 | 29.42 | 54.00 | -24.58 | AV | Horizontal |
| 7218.83 | 37.87 | 43.50 | 11.40 | 35.50 | 3.40 | 41.27 | 74.00 | -32.73 | PK | Vertical |
| 7218.83 | 33.78 | 43.50 | 11.40 | 35.50 | 3.40 | 37.18 | 54.00 | -16.82 | AV | Vertical |
| 7229.79 | 36.93 | 43.50 | 11.40 | 35.50 | 3.40 | 40.33 | 74.00 | -33.67 | PK | Horizontal |
| 7229.79 | 34.90 | 43.50 | 11.40 | 35.50 | 3.40 | 38.30 | 54.00 | -15.70 | AV | Horizontal |
| 10400.31 | 39.42 | 44.50 | 13.80 | 38.80 | 8.10 | 47.52 | 74.00 | -26.48 | PK | Vertical |
| 10400.31 | 36.22 | 44.50 | 13.80 | 38.80 | 8.10 | 44.32 | 54.00 | -9.68 | AV | Vertical |
| 10389.06 | 39.50 | 44.50 | 13.80 | 38.80 | 8.10 | 47.60 | 74.00 | -26.40 | PK | Horizontal |
| 10389.06 | 37.14 | 44.50 | 13.80 | 38.80 | 8.10 | 45.24 | 54.00 | -8.76 | AV | Horizontal |
| 11160.33 | 32.88 | 43.60 | 14.30 | 39.50 | 10.20 | 43.08 | 74.00 | -30.92 | PK | Vertical |
| 11160.33 | 30.92 | 43.60 | 14.30 | 39.50 | 10.20 | 41.12 | 54.00 | -12.88 | AV | Vertical |
| 11160.29 | 32.88 | 43.60 | 14.30 | 39.50 | 10.20 | 43.08 | 74.00 | -30.92 | PK | Horizontal |
| 11160.29 | 31.02 | 43.60 | 14.30 | 39.50 | 10.20 | 41.22 | 54.00 | -12.78 | AV | Horizontal |
| 13292.61 | 32.08 | 42.60 | 15.90 | 38.90 | 12.20 | 44.28 | 74.00 | -29.72 | PK | Vertical |
| 13292.61 | 29.10 | 42.60 | 15.90 | 38.90 | 12.20 | 41.30 | 54.00 | -12.70 | AV | Vertical |
| 13287.80 | 32.29 | 42.60 | 15.90 | 38.90 | 12.20 | 44.49 | 74.00 | -29.51 | PK | Horizontal |
| 13287.80 | 28.56 | 42.60 | 15.90 | 38.90 | 12.20 | 40.76 | 54.00 | -13.24 | AV | Horizontal |



| High Channel (802.11 n20/ 5700 MHz) | | | | | | | | | | |
|-------------------------------------|-------|-------|-------|-------|-------|-------|-------|--------|----|------------|
| 3251.02 | 44.87 | 44.70 | 6.70 | 28.20 | -9.80 | 35.07 | 74.00 | -38.93 | PK | Vertical |
| 3251.02 | 42.12 | 44.70 | 6.70 | 28.20 | -9.80 | 32.32 | 54.00 | -21.68 | AV | Vertical |
| 3255.98 | 43.82 | 44.70 | 6.70 | 28.20 | -9.80 | 34.02 | 74.00 | -39.98 | PK | Horizontal |
| 3255.98 | 42.07 | 44.70 | 6.70 | 28.20 | -9.80 | 32.27 | 54.00 | -21.73 | AV | Horizontal |
| 3995.57 | 39.42 | 44.20 | 7.90 | 29.70 | -6.60 | 32.82 | 74.00 | -41.18 | PK | Vertical |
| 3995.57 | 36.99 | 44.20 | 7.90 | 29.70 | -6.60 | 30.39 | 54.00 | -23.61 | AV | Vertical |
| 3999.97 | 39.08 | 44.20 | 7.90 | 29.70 | -6.60 | 32.48 | 74.00 | -41.52 | PK | Horizontal |
| 3999.97 | 36.16 | 44.20 | 7.90 | 29.70 | -6.60 | 29.56 | 54.00 | -24.44 | AV | Horizontal |
| 7235.26 | 36.75 | 43.50 | 11.40 | 35.50 | 3.40 | 40.15 | 74.00 | -33.85 | PK | Vertical |
| 7235.26 | 34.34 | 43.50 | 11.40 | 35.50 | 3.40 | 37.74 | 54.00 | -16.26 | AV | Vertical |
| 7227.09 | 37.72 | 43.50 | 11.40 | 35.50 | 3.40 | 41.12 | 74.00 | -32.88 | PK | Horizontal |
| 7227.09 | 34.88 | 43.50 | 11.40 | 35.50 | 3.40 | 38.28 | 54.00 | -15.72 | AV | Horizontal |
| 10471.88 | 39.16 | 44.50 | 13.80 | 38.80 | 8.10 | 47.26 | 74.00 | -26.74 | PK | Vertical |
| 10471.88 | 36.95 | 44.50 | 13.80 | 38.80 | 8.10 | 45.05 | 54.00 | -8.95 | AV | Vertical |
| 10468.45 | 39.22 | 44.50 | 13.80 | 38.80 | 8.10 | 47.32 | 74.00 | -26.68 | PK | Horizontal |
| 10468.45 | 36.82 | 44.50 | 13.80 | 38.80 | 8.10 | 44.92 | 54.00 | -9.08 | AV | Horizontal |
| 11400.38 | 33.42 | 43.60 | 14.30 | 39.50 | 10.20 | 43.62 | 74.00 | -30.38 | PK | Vertical |
| 11400.38 | 31.02 | 43.60 | 14.30 | 39.50 | 10.20 | 41.22 | 54.00 | -12.78 | AV | Vertical |
| 11400.17 | 32.88 | 43.60 | 14.30 | 39.50 | 10.20 | 43.08 | 74.00 | -30.92 | PK | Horizontal |
| 11400.17 | 29.89 | 43.60 | 14.30 | 39.50 | 10.20 | 40.09 | 54.00 | -13.91 | AV | Horizontal |
| 13298.67 | 31.59 | 42.60 | 15.90 | 38.90 | 12.20 | 43.79 | 74.00 | -30.21 | PK | Vertical |
| 13298.67 | 29.09 | 42.60 | 15.90 | 38.90 | 12.20 | 41.29 | 54.00 | -12.71 | AV | Vertical |
| 13294.92 | 32.50 | 42.60 | 15.90 | 38.90 | 12.20 | 44.70 | 74.00 | -29.30 | PK | Horizontal |
| 13294.92 | 28.91 | 42.60 | 15.90 | 38.90 | 12.20 | 41.11 | 54.00 | -12.89 | AV | Horizontal |

Remark:

1. Factor = Antenna Factor + Cable Loss – Pre-amplifier.
2. Scan with 802.11a, 802.11n (HT-20), 802.11n (HT-40), the worst case is 802.11n (HT-20).
3. The frequency emission of peak points that did not show above the forms are at least 20dB below the limit, the frequency emission is mainly from the environment noise.



Band IV(5.725-5.850) GHz

| Band IV(5.725-5.85) GHz | | | | | | | | | | |
|----------------------------------|---------|-----------|-------|---------|-----------|----------|-------------------|--------|----------|------------|
| Frequency (MHz) | Reading | Amplifier | Loss | Antenna | Corrected | Emission | Limit (dBuV/m) | Margin | Detector | Comment |
| | (dBuV) | (dB) | (dB) | (dB/m) | (dB) | (dBμV/m) | | (dB) | | |
| Low Channel (802.11 a/ 5745 MHz) | | | | | | | | | | |
| 3264.39 | 44.79 | 44.70 | 6.70 | 28.20 | -9.80 | 34.99 | 74.00 | -39.01 | PK | Vertical |
| 3264.39 | 41.14 | 44.70 | 6.70 | 28.20 | -9.80 | 31.34 | 54.00 | -22.66 | AV | Vertical |
| 3254.66 | 44.52 | 44.70 | 6.70 | 28.20 | -9.80 | 34.72 | 74.00 | -39.28 | PK | Horizontal |
| 3254.66 | 41.48 | 44.70 | 6.70 | 28.20 | -9.80 | 31.68 | 54.00 | -22.32 | AV | Horizontal |
| 3983.16 | 39.16 | 44.20 | 7.90 | 29.70 | -6.60 | 32.56 | 74.00 | -41.44 | PK | Vertical |
| 3983.16 | 36.46 | 44.20 | 7.90 | 29.70 | -6.60 | 29.86 | 54.00 | -24.14 | AV | Vertical |
| 3998.31 | 38.83 | 44.20 | 7.90 | 29.70 | -6.60 | 32.23 | 74.00 | -41.77 | PK | Horizontal |
| 3998.31 | 36.07 | 44.20 | 7.90 | 29.70 | -6.60 | 29.47 | 54.00 | -24.53 | AV | Horizontal |
| 7225.86 | 37.00 | 43.50 | 11.40 | 35.50 | 3.40 | 40.40 | 74.00 | -33.60 | PK | Vertical |
| 7225.86 | 33.68 | 43.50 | 11.40 | 35.50 | 3.40 | 37.08 | 54.00 | -16.92 | AV | Vertical |
| 7230.14 | 36.58 | 43.50 | 11.40 | 35.50 | 3.40 | 39.98 | 74.00 | -34.02 | PK | Horizontal |
| 7230.14 | 34.87 | 43.50 | 11.40 | 35.50 | 3.40 | 38.27 | 54.00 | -15.73 | AV | Horizontal |
| 10510.09 | 39.61 | 44.50 | 13.90 | 38.80 | 8.20 | 47.81 | 74.00 | -26.19 | PK | Vertical |
| 10510.09 | 36.24 | 44.50 | 13.90 | 38.80 | 8.20 | 44.44 | 54.00 | -9.56 | AV | Vertical |
| 10518.63 | 39.96 | 44.50 | 13.90 | 38.80 | 8.20 | 48.16 | 74.00 | -25.84 | PK | Horizontal |
| 10518.63 | 36.47 | 44.50 | 13.90 | 38.80 | 8.20 | 44.67 | 54.00 | -9.33 | AV | Horizontal |
| 11490.21 | 33.10 | 43.60 | 14.30 | 39.50 | 10.20 | 43.30 | 74.00 | -30.70 | PK | Vertical |
| 11490.21 | 30.35 | 43.60 | 14.30 | 39.50 | 10.20 | 40.55 | 54.00 | -13.45 | AV | Vertical |
| 11490.30 | 33.24 | 43.60 | 14.30 | 39.50 | 10.20 | 43.44 | 74.00 | -30.56 | PK | Horizontal |
| 11490.30 | 29.83 | 43.60 | 14.30 | 39.50 | 10.20 | 40.03 | 54.00 | -13.97 | AV | Horizontal |
| 13287.38 | 32.15 | 42.60 | 15.90 | 38.90 | 12.20 | 44.35 | 74.00 | -29.65 | PK | Vertical |
| 13287.38 | 28.56 | 42.60 | 15.90 | 38.90 | 12.20 | 40.76 | 54.00 | -13.24 | AV | Vertical |
| 13295.75 | 32.64 | 42.60 | 15.90 | 38.90 | 12.20 | 44.84 | 74.00 | -29.16 | PK | Horizontal |
| 13295.75 | 29.16 | 42.60 | 15.90 | 38.90 | 12.20 | 41.36 | 54.00 | -12.64 | AV | Horizontal |



| Mid Channel (802.11 a/ 5785 MHz) | | | | | | | | | | |
|----------------------------------|-------|-------|-------|-------|-------|-------|-------|--------|----|------------|
| 3259.33 | 44.47 | 44.70 | 6.70 | 28.20 | -9.80 | 34.67 | 74.00 | -39.33 | PK | Vertical |
| 3259.33 | 41.40 | 44.70 | 6.70 | 28.20 | -9.80 | 31.60 | 54.00 | -22.40 | AV | Vertical |
| 3249.68 | 45.06 | 44.70 | 6.70 | 28.20 | -9.80 | 35.26 | 74.00 | -38.74 | PK | Horizontal |
| 3249.68 | 42.23 | 44.70 | 6.70 | 28.20 | -9.80 | 32.43 | 54.00 | -21.57 | AV | Horizontal |
| 3990.18 | 39.90 | 44.20 | 7.90 | 29.70 | -6.60 | 33.30 | 74.00 | -40.70 | PK | Vertical |
| 3990.18 | 36.75 | 44.20 | 7.90 | 29.70 | -6.60 | 30.15 | 54.00 | -23.85 | AV | Vertical |
| 3990.67 | 38.92 | 44.20 | 7.90 | 29.70 | -6.60 | 32.32 | 74.00 | -41.68 | PK | Horizontal |
| 3990.67 | 36.13 | 44.20 | 7.90 | 29.70 | -6.60 | 29.53 | 54.00 | -24.47 | AV | Horizontal |
| 7236.17 | 37.56 | 43.50 | 11.40 | 35.50 | 3.40 | 40.96 | 74.00 | -33.04 | PK | Vertical |
| 7236.17 | 33.58 | 43.50 | 11.40 | 35.50 | 3.40 | 36.98 | 54.00 | -17.02 | AV | Vertical |
| 7227.25 | 37.39 | 43.50 | 11.40 | 35.50 | 3.40 | 40.79 | 74.00 | -33.21 | PK | Horizontal |
| 7227.25 | 34.21 | 43.50 | 11.40 | 35.50 | 3.40 | 37.61 | 54.00 | -16.39 | AV | Horizontal |
| 10584.55 | 40.00 | 44.50 | 13.80 | 38.80 | 8.10 | 48.10 | 74.00 | -25.90 | PK | Vertical |
| 10584.55 | 37.12 | 44.50 | 13.80 | 38.80 | 8.10 | 45.22 | 54.00 | -8.78 | AV | Vertical |
| 10586.23 | 39.56 | 44.50 | 13.80 | 38.80 | 8.10 | 47.66 | 74.00 | -26.34 | PK | Horizontal |
| 10586.23 | 36.23 | 44.50 | 13.80 | 38.80 | 8.10 | 44.33 | 54.00 | -9.67 | AV | Horizontal |
| 11570.36 | 33.97 | 43.60 | 14.30 | 39.50 | 10.20 | 44.17 | 74.00 | -29.83 | PK | Vertical |
| 11570.36 | 30.06 | 43.60 | 14.30 | 39.50 | 10.20 | 40.26 | 54.00 | -13.74 | AV | Vertical |
| 11570.38 | 32.93 | 43.60 | 14.30 | 39.50 | 10.20 | 43.13 | 74.00 | -30.87 | PK | Horizontal |
| 11570.38 | 30.97 | 43.60 | 14.30 | 39.50 | 10.20 | 41.17 | 54.00 | -12.83 | AV | Horizontal |
| 13280.43 | 32.19 | 42.60 | 15.90 | 38.90 | 12.20 | 44.39 | 74.00 | -29.61 | PK | Vertical |
| 13280.43 | 28.84 | 42.60 | 15.90 | 38.90 | 12.20 | 41.04 | 54.00 | -12.96 | AV | Vertical |
| 13290.78 | 32.15 | 42.60 | 15.90 | 38.90 | 12.20 | 44.35 | 74.00 | -29.65 | PK | Horizontal |
| 13290.78 | 28.61 | 42.60 | 15.90 | 38.90 | 12.20 | 40.81 | 54.00 | -13.19 | AV | Horizontal |



| High Channel (802.11 a/ 5825 MHz) | | | | | | | | | | |
|-----------------------------------|-------|-------|-------|-------|-------|-------|-------|--------|----|------------|
| 3252.42 | 45.11 | 44.70 | 6.70 | 28.20 | -9.80 | 35.31 | 74.00 | -38.69 | PK | Vertical |
| 3252.42 | 41.19 | 44.70 | 6.70 | 28.20 | -9.80 | 31.39 | 54.00 | -22.61 | AV | Vertical |
| 3253.81 | 45.15 | 44.70 | 6.70 | 28.20 | -9.80 | 35.35 | 74.00 | -38.65 | PK | Horizontal |
| 3253.81 | 40.76 | 44.70 | 6.70 | 28.20 | -9.80 | 30.96 | 54.00 | -23.04 | AV | Horizontal |
| 3999.01 | 38.70 | 44.20 | 7.90 | 29.70 | -6.60 | 32.10 | 74.00 | -41.90 | PK | Vertical |
| 3999.01 | 35.72 | 44.20 | 7.90 | 29.70 | -6.60 | 29.12 | 54.00 | -24.88 | AV | Vertical |
| 3982.46 | 39.35 | 44.20 | 7.90 | 29.70 | -6.60 | 32.75 | 74.00 | -41.25 | PK | Horizontal |
| 3982.46 | 36.21 | 44.20 | 7.90 | 29.70 | -6.60 | 29.61 | 54.00 | -24.39 | AV | Horizontal |
| 7218.89 | 36.58 | 43.50 | 11.40 | 35.50 | 3.40 | 39.98 | 74.00 | -34.02 | PK | Vertical |
| 7218.89 | 34.00 | 43.50 | 11.40 | 35.50 | 3.40 | 37.40 | 54.00 | -16.60 | AV | Vertical |
| 7229.75 | 36.56 | 43.50 | 11.40 | 35.50 | 3.40 | 39.96 | 74.00 | -34.04 | PK | Horizontal |
| 7229.75 | 34.79 | 43.50 | 11.40 | 35.50 | 3.40 | 38.19 | 54.00 | -15.81 | AV | Horizontal |
| 10639.33 | 38.80 | 44.50 | 13.80 | 38.80 | 8.10 | 46.90 | 74.00 | -27.10 | PK | Vertical |
| 10639.33 | 37.07 | 44.50 | 13.80 | 38.80 | 8.10 | 45.17 | 54.00 | -8.83 | AV | Vertical |
| 10640.22 | 38.95 | 44.50 | 13.80 | 38.80 | 8.10 | 47.05 | 74.00 | -26.95 | PK | Horizontal |
| 10640.22 | 36.16 | 44.50 | 13.80 | 38.80 | 8.10 | 44.26 | 54.00 | -9.74 | AV | Horizontal |
| 11650.40 | 34.12 | 43.60 | 14.30 | 39.50 | 10.20 | 44.32 | 74.00 | -29.68 | PK | Vertical |
| 11650.40 | 30.04 | 43.60 | 14.30 | 39.50 | 10.20 | 40.24 | 54.00 | -13.76 | AV | Vertical |
| 11650.09 | 33.95 | 43.60 | 14.30 | 39.50 | 10.20 | 44.15 | 74.00 | -29.85 | PK | Horizontal |
| 11650.09 | 30.71 | 43.60 | 14.30 | 39.50 | 10.20 | 40.91 | 54.00 | -13.09 | AV | Horizontal |
| 13284.79 | 31.56 | 42.70 | 18.00 | 37.10 | 12.40 | 43.96 | 74.00 | -30.04 | PK | Vertical |
| 13284.79 | 28.66 | 42.70 | 18.00 | 37.10 | 12.40 | 41.06 | 54.00 | -12.94 | AV | Vertical |
| 13293.24 | 32.41 | 42.70 | 18.00 | 37.10 | 12.40 | 44.81 | 74.00 | -29.19 | PK | Horizontal |
| 13293.24 | 29.25 | 42.70 | 18.00 | 37.10 | 12.40 | 41.65 | 54.00 | -12.35 | AV | Horizontal |

Remark:

1. Factor = Antenna Factor + Cable Loss – Pre-amplifier.
2. Scan with 802.11a, 802.11n (HT-20), 802.11n (HT-40), the worst case is 802.11a.
3. The frequency emission of peak points that did not show above the forms are at least 20dB below the limit, the frequency emission is mainly from the environment noise.



3.2.9 Band Edge

Band I&II(5.15-5.35)GHz

| Band I&II(5.15-5.35)GHz | | | | | | | | | | |
|-------------------------|---------------|-----------|------|----------------|------------------|----------------|----------|--------|----------|------------|
| Frequency | Meter Reading | Amplifier | Loss | Antenna Factor | Corrected Factor | Emission Level | Limits | Margin | Detector | Comment |
| (MHz) | (dBμV) | (dB) | (dB) | (dB/m) | (dB) | (dBμV/m) | (dBμV/m) | (dB) | Type | |
| 802.11a BW20MHz | | | | | | | | | | |
| 5150 | 41.43 | 44.20 | 8.98 | 31.60 | -3.62 | 37.81 | 74 | 5150 | Peak | Vertical |
| 5150 | 28.98 | 44.20 | 8.98 | 31.60 | -3.62 | 25.36 | 54 | 5150 | AVG | Vertical |
| 5150 | 42.15 | 44.20 | 8.98 | 31.60 | -3.62 | 38.53 | 74 | 5150 | Peak | Horizontal |
| 5150 | 30.69 | 44.20 | 8.98 | 31.60 | -3.62 | 27.07 | 54 | 5150 | AVG | Horizontal |
| 5350 | 46.05 | 44.20 | 9.35 | 31.60 | -3.25 | 42.80 | 74 | 5350 | Peak | Vertical |
| 5350 | 28.92 | 44.20 | 9.35 | 31.60 | -3.25 | 25.67 | 54 | 5350 | AVG | Vertical |
| 5350 | 38.84 | 44.20 | 9.35 | 31.60 | -3.25 | 35.59 | 74 | 5350 | Peak | Horizontal |
| 5350 | 28.15 | 44.20 | 9.35 | 31.60 | -3.25 | 24.90 | 54 | 5350 | AVG | Horizontal |
| 802.11n BW20MHz | | | | | | | | | | |
| 5150 | 40.49 | 44.20 | 8.98 | 31.60 | -3.62 | 36.87 | 74 | -37.13 | Peak | Vertical |
| 5150 | 28.40 | 44.20 | 8.98 | 31.60 | -3.62 | 24.78 | 54 | -29.22 | AVG | Vertical |
| 5150 | 42.16 | 44.20 | 8.98 | 31.60 | -3.62 | 38.54 | 74 | -35.46 | Peak | Horizontal |
| 5150 | 30.59 | 44.20 | 8.98 | 31.60 | -3.62 | 26.97 | 54 | -27.03 | AVG | Horizontal |
| 5350 | 44.98 | 44.20 | 9.35 | 31.60 | -3.25 | 41.73 | 74 | -32.27 | Peak | Vertical |
| 5350 | 29.34 | 44.20 | 9.35 | 31.60 | -3.25 | 26.09 | 54 | -27.91 | AVG | Vertical |
| 5350 | 38.48 | 44.20 | 9.35 | 31.60 | -3.25 | 35.23 | 74 | -38.77 | Peak | Horizontal |
| 5350 | 30.51 | 44.20 | 9.35 | 31.60 | -3.25 | 27.26 | 54 | -26.74 | AVG | Horizontal |
| 802.11n BW40MHz | | | | | | | | | | |
| 5150 | 39.47 | 44.20 | 8.98 | 31.60 | -3.62 | 35.85 | 74 | -38.15 | Peak | Vertical |
| 5150 | 31.24 | 44.20 | 8.98 | 31.60 | -3.62 | 27.62 | 54 | -26.38 | AVG | Vertical |
| 5150 | 38.54 | 44.20 | 8.98 | 31.60 | -3.62 | 34.92 | 74 | -39.08 | Peak | Horizontal |
| 5150 | 29.09 | 44.20 | 8.98 | 31.60 | -3.62 | 25.47 | 54 | -28.53 | AVG | Horizontal |
| 5350 | 42.59 | 44.20 | 9.35 | 31.60 | -3.25 | 39.34 | 74 | -34.66 | Peak | Vertical |
| 5350 | 27.60 | 44.20 | 9.35 | 31.60 | -3.25 | 24.35 | 54 | -29.65 | AVG | Vertical |
| 5350 | 40.95 | 44.20 | 9.35 | 31.60 | -3.25 | 37.70 | 74 | -36.30 | Peak | Horizontal |
| 5350 | 28.28 | 44.20 | 9.35 | 31.60 | -3.25 | 25.03 | 54 | -28.97 | AVG | Horizontal |



Band III 5470-5725MHz

| Band III(5.47-5.725 GHz) | | | | | | | | | | |
|--------------------------|---------------|-----------|-------|----------------|------------------|----------------|----------|--------|----------|------------|
| Frequency | Meter Reading | Amplifier | Loss | Antenna Factor | Corrected Factor | Emission Level | Limits | Margin | Detector | Comment |
| (MHz) | (dBμV) | (dB) | (dB) | (dB/m) | (dB) | (dBμV/m) | (dBμV/m) | (dB) | Type | |
| 802.11a BW20MHz | | | | | | | | | | |
| 5470 | 40.45 | 44.20 | 9.67 | 32.00 | -2.53 | 37.92 | 74 | -36.08 | Peak | Vertical |
| 5470 | 28.97 | 44.20 | 9.67 | 32.00 | -2.53 | 26.44 | 54 | -27.56 | AVG | Vertical |
| 5470 | 41.97 | 44.20 | 9.67 | 32.00 | -2.53 | 39.44 | 74 | -34.56 | Peak | Horizontal |
| 5470 | 30.27 | 44.20 | 9.67 | 32.00 | -2.53 | 27.74 | 54 | -26.26 | AVG | Horizontal |
| 5725 | 46.49 | 44.20 | 10.00 | 32.00 | -2.20 | 44.29 | 74 | -29.71 | Peak | Vertical |
| 5725 | 31.71 | 44.20 | 10.00 | 32.00 | -2.20 | 29.51 | 54 | -24.49 | AVG | Vertical |
| 5725 | 41.65 | 44.20 | 10.00 | 32.00 | -2.20 | 39.45 | 74 | -34.55 | Peak | Horizontal |
| 5725 | 29.26 | 44.20 | 10.00 | 32.00 | -2.20 | 27.06 | 54 | -26.94 | AVG | Horizontal |
| 802.11n BW20MHz | | | | | | | | | | |
| 5470 | 38.60 | 44.20 | 9.67 | 32.00 | -2.53 | 36.07 | 74 | -37.93 | Peak | Vertical |
| 5470 | 27.44 | 44.20 | 9.67 | 32.00 | -2.53 | 24.91 | 54 | -29.09 | AVG | Vertical |
| 5470 | 41.37 | 44.20 | 9.67 | 32.00 | -2.53 | 38.84 | 74 | -35.16 | Peak | Horizontal |
| 5470 | 28.45 | 44.20 | 9.67 | 32.00 | -2.53 | 25.92 | 54 | -28.08 | AVG | Horizontal |
| 5725 | 43.61 | 44.20 | 10.00 | 32.00 | -2.20 | 41.41 | 74 | -32.59 | Peak | Vertical |
| 5725 | 29.61 | 44.20 | 10.00 | 32.00 | -2.20 | 27.41 | 54 | -26.59 | AVG | Vertical |
| 5725 | 41.02 | 44.20 | 10.00 | 32.00 | -2.20 | 38.82 | 74 | -35.18 | Peak | Horizontal |
| 5725 | 27.99 | 44.20 | 10.00 | 32.00 | -2.20 | 25.79 | 54 | -28.21 | AVG | Horizontal |
| 802.11n BW40MHz | | | | | | | | | | |
| 5470 | 38.56 | 44.20 | 9.67 | 32.00 | -2.53 | 36.03 | 74 | -37.97 | Peak | Vertical |
| 5470 | 30.11 | 44.20 | 9.67 | 32.00 | -2.53 | 27.58 | 54 | -26.42 | AVG | Vertical |
| 5470 | 38.06 | 44.20 | 9.67 | 32.00 | -2.53 | 35.53 | 74 | -38.47 | Peak | Horizontal |
| 5470 | 30.12 | 44.20 | 9.67 | 32.00 | -2.53 | 27.59 | 54 | -26.41 | AVG | Horizontal |
| 5725 | 45.92 | 44.20 | 10.00 | 32.00 | -2.20 | 43.72 | 74 | -30.28 | Peak | Vertical |
| 5725 | 28.06 | 44.20 | 10.00 | 32.00 | -2.20 | 25.86 | 54 | -28.14 | AVG | Vertical |
| 5725 | 38.69 | 44.20 | 10.00 | 32.00 | -2.20 | 36.49 | 74 | -37.51 | Peak | Horizontal |
| 5725 | 30.38 | 44.20 | 10.00 | 32.00 | -2.20 | 28.18 | 54 | -25.82 | AVG | Horizontal |



Band IV(5.725-5.85 GHz)

| Band IV(5.725-5.85 GHz) | | | | | | | | | | |
|-------------------------|---------------|-----------|-------|----------------|------------------|----------------|----------------|--------|----------|------------|
| Frequency | Meter Reading | Amplifier | Loss | Antenna Factor | Corrected Factor | Emission Level | Limits | Margin | Detector | Comment |
| (MHz) | (dB μ V) | (dB) | (dB) | (dB/m) | (dB) | (dB μ V/m) | (dB μ V/m) | (dB) | Type | |
| 802.11a BW20MHz | | | | | | | | | | |
| 5725 | 40.56 | 44.20 | 10.00 | 32.00 | -2.20 | 38.36 | 74 | -35.64 | Peak | Vertical |
| 5725 | 27.65 | 44.20 | 10.00 | 32.00 | -2.20 | 25.45 | 54 | -28.55 | AVG | Vertical |
| 5725 | 40.30 | 44.20 | 10.00 | 32.00 | -2.20 | 38.10 | 74 | -35.90 | Peak | Horizontal |
| 5725 | 28.71 | 44.20 | 10.00 | 32.00 | -2.20 | 26.51 | 54 | -27.49 | AVG | Horizontal |
| 5850 | 44.15 | 44.20 | 10.20 | 32.00 | -2.00 | 42.15 | 74 | -31.85 | Peak | Vertical |
| 5850 | 28.79 | 44.20 | 10.20 | 32.00 | -2.00 | 26.79 | 54 | -27.21 | AVG | Vertical |
| 5850 | 39.66 | 44.20 | 10.20 | 32.00 | -2.00 | 37.66 | 74 | -36.34 | Peak | Horizontal |
| 5850 | 29.47 | 44.20 | 10.20 | 32.00 | -2.00 | 27.47 | 54 | -26.53 | AVG | Horizontal |
| 802.11n BW20MHz | | | | | | | | | | |
| 5725 | 41.16 | 44.20 | 10.00 | 32.00 | -2.20 | 38.96 | 74 | -35.04 | Peak | Vertical |
| 5725 | 28.32 | 44.20 | 10.00 | 32.00 | -2.20 | 26.12 | 54 | -27.88 | AVG | Vertical |
| 5725 | 37.92 | 44.20 | 10.00 | 32.00 | -2.20 | 35.72 | 74 | -38.28 | Peak | Horizontal |
| 5725 | 28.98 | 44.20 | 10.00 | 32.00 | -2.20 | 26.78 | 54 | -27.22 | AVG | Horizontal |
| 5850 | 46.00 | 44.20 | 10.20 | 32.00 | -2.00 | 44.00 | 74 | -30.00 | Peak | Vertical |
| 5850 | 31.26 | 44.20 | 10.20 | 32.00 | -2.00 | 29.26 | 54 | -24.74 | AVG | Vertical |
| 5850 | 39.31 | 44.20 | 10.20 | 32.00 | -2.00 | 37.31 | 74 | -36.69 | Peak | Horizontal |
| 5850 | 29.37 | 44.20 | 10.20 | 32.00 | -2.00 | 27.37 | 54 | -26.63 | AVG | Horizontal |
| 802.11n BW40MHz | | | | | | | | | | |
| 5725 | 41.80 | 44.20 | 10.00 | 32.00 | -2.20 | 39.60 | 74 | -34.40 | Peak | Vertical |
| 5725 | 27.57 | 44.20 | 10.00 | 32.00 | -2.20 | 25.37 | 54 | -28.63 | AVG | Vertical |
| 5725 | 38.75 | 44.20 | 10.00 | 32.00 | -2.20 | 36.55 | 74 | -37.45 | Peak | Horizontal |
| 5725 | 31.00 | 44.20 | 10.00 | 32.00 | -2.20 | 28.80 | 54 | -25.20 | AVG | Horizontal |
| 5850 | 44.45 | 44.20 | 10.20 | 32.00 | -2.00 | 42.45 | 74 | -31.55 | Peak | Vertical |
| 5850 | 28.90 | 44.20 | 10.20 | 32.00 | -2.00 | 26.90 | 54 | -27.10 | AVG | Vertical |
| 5850 | 38.89 | 44.20 | 10.20 | 32.00 | -2.00 | 36.89 | 74 | -37.11 | Peak | Horizontal |
| 5850 | 28.38 | 44.20 | 10.20 | 32.00 | -2.00 | 26.38 | 54 | -27.62 | AVG | Horizontal |

4. CONDUCTED SPURIOUS EMISSIONS AND BANDEGE

4.1 APPLIED PROCEDURES / LIMIT

Undesirable emission limits. Except as shown in paragraph (b)(7) of this section, the maximum emissions outside of the frequency bands of operation shall be attenuated in accordance with the following limits:

- (1) For transmitters operating in the 5.15-5.25 GHz band: All emissions outside of the 5.15-5.35 GHz band shall not exceed an e.i.r.p. of -27 dBm/MHz.
- (2) For transmitters operating in the 5.25-5.35 GHz band: All emissions outside of the 5.15-5.35 GHz band shall not exceed an e.i.r.p. of -27 dBm/MHz.
- (3) For transmitters operating in the 5.47-5.725 GHz band: All emissions outside of the 5.47-5.725 GHz band shall not exceed an e.i.r.p. of -27 dBm/MHz.
- (4) For transmitters operating in the 5.725-5.85 GHz band:
 - (i) All emissions shall be limited to a level of -27 dBm/MHz at 75 MHz or more above or below the band edge increasing linearly to 10 dBm/MHz at 25 MHz above or below the band edge, and from 25 MHz above or below the band edge increasing linearly to a level of 15.6 dBm/MHz at 5 MHz above or below the band edge, and from 5 MHz above or below the band edge increasing linearly to a level of 27 dBm/MHz at the band edge.

4.1.1 TEST PROCEDURE

| Spectrum Parameter | Setting |
|---------------------------------------|---------------------------------|
| Detector | Peak |
| Start/Stop Frequency | 30 MHz to 10th carrier harmonic |
| RB / VB (emission in restricted band) | 1000 KHz/3000 KHz |
| Trace-Mode: | Max hold |

For Band edge

| Spectrum Parameter | Setting |
|---------------------------------------|--|
| Detector | Peak |
| Start/Stop Frequency | Lower Band Edge: 5700 to 5725 MHz Upper Band Edge: 5850 to 5870 MHz |
| RB / VB (emission in restricted band) | 1000 KHz/3000 KHz |
| Trace-Mode: | Max hold |

4.1.2 DEVIATION FROM STANDARD

No deviation.

4.1.3 TEST SETUP

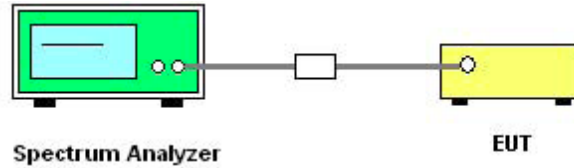

The EUT which is powered by the Battery, is coupled to the Spectrum Analyzer; the RF load attached to the EUT antenna terminal is 50Ohm; the path loss as the factor is calibrated to correct the reading.

Make the measurement with the spectrum analyzer's resolution bandwidth (RBW) = 1000 kHz. In order to make an accurate measurement, set the span greater than RBW.

4.1.4 EUT OPERATION CONDITIONS

The EUT tested system was configured as the statements of 2.3 Unless otherwise a special operating condition is specified in the follows during the testing.

4.1.5 TEST RESULTS

Data See Appendix A





5. POWER SPECTRAL DENSITY TEST

5.1 APPLIED PROCEDURES / LIMIT

1. For mobile and portable client devices in the 5.15-5.25 GHz band, , the maximum power spectral density shall not exceed 11 dBm in any 1 megahertz band. If transmitting antennas of directional gain greater than 6 dBi are used, both the maximum conducted output power and the maximum power spectral density shall be reduced by the amount in dB that the directional gain of the antenna exceeds 6 dBi.
2. For the 5.25-5.35 GHz and 5.47-5.725 GHz bands, the maximum power spectral density shall not exceed 11 dBm in any 1 megahertz band. If transmitting antennas of directional gain greater than 6 dBi are used, both the maximum conducted output power and the maximum power spectral density shall be reduced by the amount in dB that the directional gain of the antenna exceeds 6 dBi.
3. For the band 5.725-5.850 GHz, the peak power spectral density shall not exceed 30 dBm in any 500KHz band. If transmitting antenna directional gain is greater than 6 dBi, both the maximum conducted output power and the peak power spectral density shall be reduced by the amount in dB that the directional gain of the antenna exceeds 6 dBi.

5.1.1 TEST PROCEDURE

1. The setting follows Method SA-1 of FCC KDB D02 General UNII Test Procedures New Rules v01r03.

For devices operating in the band, the rules specify a measurement bandwidth of 500 kHz.

Many spectrum analyzers do not have 500 kHz RBW, thus a narrower RBW may need to be used.

The rules permit the use of a RBWs less than 1 MHz, or 500 kHz, "provided that the measured power is integrated over the full reference bandwidth" to show the total power over the specified measurement bandwidth (*i.e.*, 1 MHz, or 500 kHz). If measurements are performed using a reduced resolution bandwidth (< 1 MHz, or < 500 kHz) and integrated over 1 MHz, or 500 KHz bandwidth, the following adjustments to the procedures apply:

- a) Set $RBW \geq 1/T$, where T is defined in section II.B.I.a).
- b) Set $VBW \geq 3 RBW$.
- c) If measurement bandwidth of Maximum PSD is specified in 500 kHz, add $10 \log (500\text{kHz}/RBW)$ to the measured result, whereas $RBW (< 500 \text{ kHz})$ is the reduced resolution bandwidth of the spectrum analyzer set during measurement.
- d) If measurement bandwidth of Maximum PSD is specified in 1 MHz, add $10 \log (1\text{MHz}/RBW)$ to the measured result, whereas $RBW (< 1 \text{ MHz})$ is the reduced resolution bandwidth of spectrum analyzer set during measurement.
- e) Care must be taken to ensure that the measurements are performed during a period of continuous transmission or are corrected upward for duty cycle.

Note: As a practical matter, it is recommended to use reduced RBW of 100 kHz for the sections 5.c) and 5.d) above, since $RBW=100 \text{ KHZ}$ is available on nearly all spectrum analyzers.

5.1.2 DEVIATION FROM STANDARD

No deviation.

5.1.3 TEST SETUP



5.1.4 EUT OPERATION CONDITIONS

The EUT tested system was configured as the statements of 2.1 Unless otherwise a special operating condition is specified in the follows during the testing.

5.1.5 TEST RESULTS

Data see Appendix B



6. BANDWIDTH MEASUREMENT

6.1 EMISSION BANDWIDTH (EBW) 26 BANDWID PROCEDURES / LIMIT

See list of measuring instruments of this test report.

6.1.1 TEST PROCEDURE

1. The testing follows FCC KDB 789033 D02 General UNII Test Procedures New Rules v02r01
2. Set RBW = approximately 1% of the emission bandwidth.
3. Set the VBW \geq RBW.
4. Detector = Peak.
5. Trace mode = max hold.
6. Measure the maximum width of the emission that is 26 dB down from the peak of the emission. Compare this with the RBW setting of the analyzer. Readjust RBW and repeat measurement as needed until the RBW/EBW ratio is approximately 1%.

6.1.2 DEVIATION FROM STANDARD

No deviation.

6.1.3 TEST SETUP

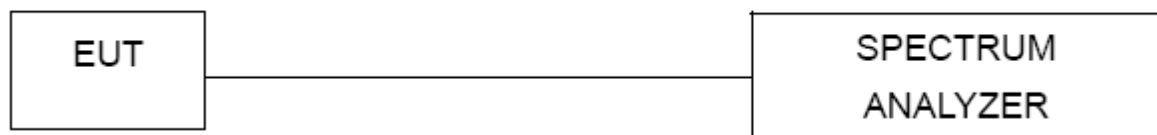

6.1.4 EUT OPERATION CONDITIONS

The EUT tested system was configured as the statements of 2.4 Unless otherwise a special operating condition is specified in the follows during the testing.

6.1.5 TEST RESULTS

Data see Appendix C

6.2 OCCUPIED BANDWIDTH (99%) TEST APPLIED PROCEDURES / LIMIT

The following procedure shall be used for measuring (99 %) power bandwidth:

6.2.1 TEST PROCEDURE

1. The testing follows FCC KDB 789033 D02 General UNII Test Procedures v02r01.

The following procedure shall be used for measuring (99 %) power bandwidth:

1. Set center frequency to the nominal EUT channel center frequency.
2. Set span = 1.5 times to 5.0 times the OBW.
3. Set RBW = 1 % to 5 % of the OBW
4. Set VBW $\geq 3 \cdot$ RBW
5. Video averaging is not permitted. Where practical, a sample detection and single sweep mode shall be used. Otherwise, peak detection and max hold mode (until the trace stabilizes) shall be used.
6. Use the 99 % power bandwidth function of the instrument (if available).
7. If the instrument does not have a 99 % power bandwidth function, the trace data points are recovered and directly summed in power units. The recovered amplitude data points, beginning at the lowest frequency, are placed in a running sum until 0.5 % of the total is reached; that frequency is recorded as the lower frequency. The process is repeated until 99.5 % of the total is reached; that frequency is recorded as the upper frequency. The 99% occupied bandwidth is the difference between these two frequencies.

6.2.2 DEVIATION FROM STANDARD

No deviation.

6.2.3 TEST SETUP



6.2.4 EUT OPERATION CONDITIONS

The EUT tested system was configured as the statements of 2.4 Unless otherwise a special operating condition is specified in the follows during the testing.

6.2.5 TEST RESULTS

Data See Appendix C

6.3 MINIMUM EMISSION BANDWIDTH(6 DB) PROCEDURES / LIMIT

Section 15.407(e) specifies the minimum 6 dB emission bandwidth of at least 500 KHz for the band 5.725-5.85 GHz. The following procedure shall be used for measuring this bandwidth:

6.3.1 TEST PROCEDURE

1. The testing follows FCC KDB 789033 D02 General UNII Test Procedures v02r01.
 - a) Set RBW = 100 kHz.
 - b) Set the video bandwidth (VBW) $\geq 3 \times$ RBW.
 - c) Detector = Peak.
 - d) Trace mode = max hold.
 - e) Sweep = auto couple.
 - f) Allow the trace to stabilize.
 - g) Measure the maximum width of the emission that is constrained by the frequencies associated with the two outermost amplitude points (upper and lower frequencies) that are attenuated by 6 dB relative to the maximum level measured in the fundamental emission.

6.3.2 DEVIATION FROM STANDARD

No deviation.

6.3.3 TEST SETUP



6.3.4 EUT OPERATION CONDITIONS

The EUT tested system was configured as the statements of 2.4 Unless otherwise a special operating condition is specified in the follows during the testing.

6.3.5 TEST RESULTS

Data see Appendix D

7. MAXIMUM CONDUCTED OUTPUT POWER

7.1 APPLIED PROCEDURES / LIMIT

For mobile and portable client devices in the 5.15-5.25 GHz band, the maximum conducted output power over the frequency band of operation shall not exceed 250 mW provided the maximum antenna gain does not exceed 6 dBi. If transmitting antennas of directional gain greater than 6 dBi are used, both the maximum conducted output power and the maximum power spectral density shall be reduced by the amount in dB that the directional gain of the antenna exceeds 6 dBi.

For the 5.25-5.35 GHz and 5.47-5.725 GHz bands, the maximum conducted output power over the frequency bands of operation shall not exceed the lesser of 250 mW or 11 dBm + 10 log B, where B is the 26 dB emission bandwidth in megahertz, If transmitting antennas of directional gain greater than 6 dBi are used.

For the band 5.725-5.85 GHz, the maximum conducted output power over the frequency band of operation shall not exceed 1 W. If transmitting antennas of directional gain greater than 6 dBi are used.

| FCC Part15 (15.407) , Subpart E | | | | |
|---------------------------------|-------------------|--|------------------------|--------|
| Section | Test Item | Limit | Frequency Range (MHz) | Result |
| 15.407(a) (1) (iv) | Peak Output Power | 0.25 watt | 5150-5250 | PASS |
| | | The lesser of 250 mW or 11 dBm + 10 log (26 dB emission bandwidth) | 5250-5350 5470-5725 | |
| 15.407(a) (3) | | 1 watt | 5725-5825 | |

7.1.1 TEST PROCEDURE

The EUT was directly connected to the Power Sensor&PC

7.1.2 DEVIATION FROM STANDARD

No deviation.

7.1.3 TEST SETUP

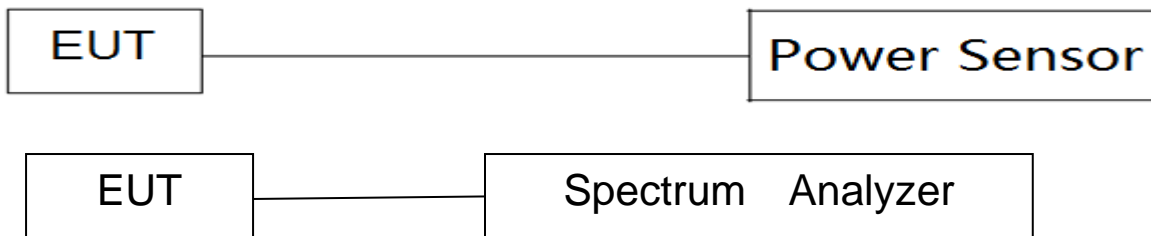

7.1.4 EUT OPERATION CONDITIONS

The EUT tested system was configured as the statements of 5 Unless otherwise a special operating condition is specified in the follows during the testing.



7.1.5 TEST RESULTS

Band I (5.15-5.25GHz)

| Band I (5.15-5.25GHz) | | | | |
|-----------------------|-----------------|----------------|----------------|-------------|
| Test Channel | Frequency (MHz) | PK Power (dBm) | AV Power (dBm) | LIMIT (dBm) |
| 802.11a | | | | |
| 36 | 5180 | 10.54 | 8.07 | 23.98 |
| 40 | 5200 | 10.91 | 9.02 | 23.98 |
| 48 | 5240 | 10.76 | 8.42 | 23.98 |
| 802.11n(HT20) | | | | |
| 36 | 5180 | 11.12 | 9.13 | 23.98 |
| 40 | 5200 | 11.45 | 9.62 | 23.98 |
| 48 | 5240 | 11.08 | 9.29 | 23.98 |
| 802.11n(HT40) | | | | |
| 38 | 5190 | 10.07 | 7.93 | 23.98 |
| 46 | 5230 | 9.34 | 7.22 | 23.98 |

Note:

1. For mobile and portable client devices in the 5.15-5.25 GHz band, the maximum conducted output power over the frequency band of operation shall not exceed the lesser of 0.25 W.

**Band II (5.25-5.35GHz)**

| Band II(5.25-5.35GHz) | | | | |
|------------------------------|-----------------|----------------|----------------|-------------|
| Test Channel | Frequency (MHz) | PK Power (dBm) | AV Power (dBm) | LIMIT (dBm) |
| 802.11a | | | | |
| 52 | 5260 | 11.02 | 8.93 | 23.98 |
| 60 | 5300 | 10.56 | 8.21 | 23.98 |
| 64 | 5320 | 10.64 | 8.57 | 23.98 |
| 802.11n(HT20) | | | | |
| 52 | 5260 | 11.34 | 9.78 | 23.98 |
| 60 | 5300 | 10.68 | 8.52 | 23.98 |
| 64 | 5320 | 10.91 | 9.14 | 23.98 |
| 802.11n(HT40) | | | | |
| 54 | 5270 | 10.12 | 7.84 | 23.98 |
| 62 | 5310 | 9.46 | 7.56 | 23.98 |

Note:

1. For mobile and portable client devices in the 5.25-5.35 GHz band, the maximum conducted output power over the frequency band of operation shall not exceed the lesser of 0.25 W.

**Band III (5.47-5.725GHz)**

| Band9 III(5.47-5.725GHz) | | | | |
|---------------------------------|-----------------|----------------|----------------|-------------|
| Test Channel | Frequency (MHz) | PK Power (dBm) | AV Power (dBm) | LIMIT (dBm) |
| 802.11a | | | | |
| 100 | 5500 | 10.64 | 8.93 | 23.98 |
| 116 | 5580 | 9.72 | 7.42 | 23.98 |
| 140 | 5700 | 9.26 | 6.82 | 23.98 |
| 802.11n(HT20) | | | | |
| 100 | 5500 | 10.67 | 8.71 | 23.98 |
| 116 | 5580 | 10.24 | 8.66 | 23.98 |
| 140 | 5700 | 9.37 | 7.26 | 23.98 |
| 802.11n(HT40) | | | | |
| 102 | 5510 | 9.72 | 7.35 | 23.98 |
| 110 | 5550 | 9.15 | 7.04 | 23.98 |
| 134 | 5670 | 9.07 | 7.55 | 23.98 |

Note:

1. For mobile and portable client devices in the 5.47-5.725 GHz band, the maximum conducted output power over the frequency band of operation shall not exceed the lesser of 0.25 W.

**Band IV (5.725-5.85GHz)**

| Band IV (5.725-5.85GHz) | | | | |
|--------------------------------|-----------------|----------------|----------------|-------------|
| Test Channel | Frequency (MHz) | PK Power (dBm) | AV Power (dBm) | LIMIT (dBm) |
| 802.11a | | | | |
| 149 | 5745 | 9.72 | 7.37 | 30 |
| 157 | 5785 | 8.26 | 6.02 | 30 |
| 165 | 5825 | 8.81 | 6.87 | 30 |
| 802.11n(HT20) | | | | |
| 149 | 5745 | 9.42 | 7.460 | 30 |
| 157 | 5785 | 8.37 | 6.140 | 30 |
| 165 | 5825 | 8.41 | 6.570 | 30 |
| 802.11n(HT40) | | | | |
| 151 | 5755 | 8.24 | 6.360 | 30 |
| 159 | 5795 | 8.07 | 5.940 | 30 |

Note:

1. For the band 5.745-5.850 GHz, the maximum conducted output power over the frequency band of operation shall not exceed the lesser of 1 W.



8. AUTOMATICALLY DISCONTINUE TRANSMISSION

8.1 LIMIT OF AUTOMATICALLY DISCONTINUE TRANSMISSION

The device shall automatically discontinue transmission in case of either absence of information to transmit or operational failure. These provisions are not intended to preclude the transmission of control or signaling information or the use of repetitive codes used by certain digital technologies to complete frame or burst intervals. Applicants shall include in their application for equipment authorization to describe how this requirement is met.

8.2 TEST RESULT OF AUTOMATICALLY DISCONTINUE TRANSMISSION

During no any information transmission, the EUT can automatically discontinue transmission and become standby mode for power saving. The EUT can detect the controlling signal of ACK message transmitting from remote device and verify whether it shall resend or discontinue transmission





9. ANTENNA REQUIREMENT

9.1 STANDARD REQUIREMENT

15.203 requirement: For intentional device, according to 15.203: an intentional radiator shall be designed to ensure that no antenna other than that furnished by the responsible party shall be used with the device.

9.2 EUT ANTENNA

The EUT antenna is PIFA Antenna. It comply with the standard requirement.



APPENDIX - PHOTOS OF TEST SETUP

Radiated Measurement Photos

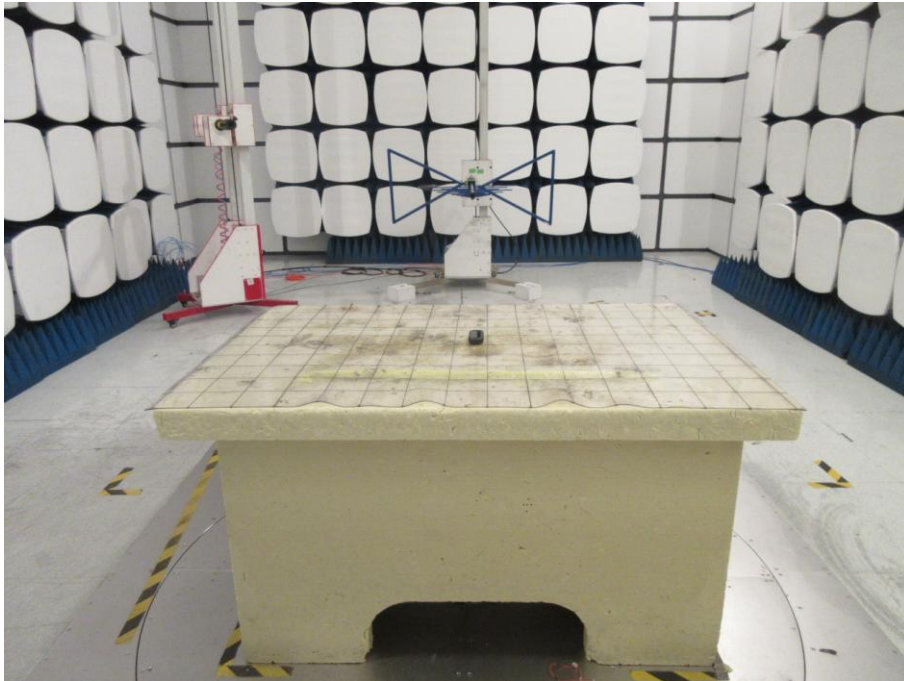

Conducted Measurement Photos



*****END OF THE REPORT*****