

FCC Test Report

(PART 27)

Report No.: RF200710D07-1

FCC ID: 2AK5B-I1

Test Model: INT1LFCNA1

Received Date: Jul. 10, 2020

Test Date: Jul. 23, 2020 ~ Jul. 30, 2020

Issued Date: Aug. 12, 2020

Applicant: Latchable, Inc.

Address: 508 West 26th Street Suite 6G New York, NY 10001 United States

Issued By: Bureau Veritas Consumer Products Services (H.K.) Ltd., Taoyuan Branch
Lin Kou Laboratories

Lab Address: No. 47-2, 14th Ling, Chia Pau Vil., Lin Kou Dist., New Taipei City, Taiwan

Test Location: No.19, Hwa Ya 2nd Rd., Wen Hwa Vil., Kwei Shan Dist., Taoyuan City
33383, Taiwan

**FCC Registration /
Designation Number:** 788550 / TW0003



This report is for your exclusive use. Any copying or replication of this report to or for any other person or entity, or use of our name or trademark, is permitted only with our prior written permission. This report sets forth our findings solely with respect to the test samples identified herein. The results set forth in this report are not indicative or representative of the quality or characteristics of the lot from which a test sample was taken or any similar or identical product unless specifically and expressly noted. Our report includes all of the tests requested by you and the results thereof based upon the information that you provided to us. You have 60 days from date of issuance of this report to notify us of any material error or omission caused by our negligence, provided, however, that such notice shall be in writing and shall specifically address the issue you wish to raise. A failure to raise such issue within the prescribed time shall constitute your unqualified acceptance of the completeness of this report, the tests conducted and the correctness of the report contents. Unless specific mention, the uncertainty of measurement has been explicitly taken into account to declare the compliance or non-compliance to the specification.

Table of Contents

Release Control Record	4
1 Certificate of Conformity	5
2 Summary of Test Results	6
2.1 Measurement Uncertainty	7
2.2 Test Site and Instruments	8
3 General Information	9
3.1 General Description of EUT	9
3.2 Configuration of System under Test	10
3.2.1 Description of Support Units	10
3.3 Test Mode Applicability and Tested Channel Detail	11
3.4 EUT Operating Conditions	14
3.5 General Description of Applied Standards and references	14
4 Test Types and Results	15
4.1 Output Power Measurement	15
4.1.1 Limits of Output Power Measurement	15
4.1.2 Test Procedures	15
4.1.3 Test Setup	16
4.1.4 Test Results	17
4.2 Modulation Characteristics Measurement	24
4.2.1 Limits of Modulation Characteristics	24
4.2.2 Test Setup	24
4.2.3 Test Procedure	24
4.2.4 Test Results	25
4.3 Frequency Stability Measurement	26
4.3.1 Limits of Frequency Stability Measurement	26
4.3.2 Test Procedure	26
4.3.3 Test Setup	26
4.3.4 Test Results	27
4.4 Occupied Bandwidth Measurement	37
4.4.1 Limits of Occupied Bandwidth Measurement	37
4.4.2 Test Procedure	37
4.4.3 Test Setup	37
4.4.4 Test Result	38
4.5 Band Edge Measurement	43
4.5.1 Limits of Band Edge Measurement	43
4.5.2 Test Setup	43
4.5.3 Test Procedures	43
4.5.4 Test Results	44
4.6 Peak to Average Ratio	54
4.6.1 Limits of Peak to Average Ratio Measurement	54
4.6.2 Test Setup	54
4.6.3 Test Procedures	54
4.6.4 Test Results	55
4.7 Conducted Spurious Emissions	60
4.7.1 Limits of Conducted Spurious Emissions Measurement	60
4.7.2 Test Setup	60
4.7.3 Test Procedure	60
4.7.4 Test Results	61
4.8 Radiated Emission Measurement	71
4.8.1 Limits of Radiated Emission Measurement	71
4.8.2 Test Procedure	71
4.8.3 Deviation from Test Standard	71
4.8.4 Test Setup	72

4.8.5 Test Results	73
5 Pictures of Test Arrangements.....	109
Appendix – Information of the Testing Laboratories	110

Release Control Record

Issue No.	Description	Date Issued
RF200710D07-1	Original Release	Aug. 12, 2020

1 Certificate of Conformity

Product: Apartment entry intercom device

Brand: Latch

Test Model: INT1LFCNA1

Sample Status: Engineering Sample

Applicant: Latchable, Inc.

Test Date: Jul. 23, 2020 ~ Jul. 30, 2020

Standards: FCC Part 27, Subpart C, H, L

The above equipment has been tested by **Bureau Veritas Consumer Products Services (H.K.) Ltd., Taoyuan Branch**, and found compliance with the requirement of the above standards. The test record, data evaluation & Equipment Under Test (EUT) configurations represented herein are true and accurate accounts of the measurements of the sample's RF characteristics under the conditions specified in this report.

Prepared by :  , Date: Aug. 12, 2020
Vera Huang / Specialist

Approved by :  , Date: Aug. 12, 2020
Dylan Chiou / Senior Project Engineer

2 Summary of Test Results

Applied Standard: FCC Part 27 & Part 2 (LTE 4)			
FCC Clause	Test Item	Result	Remarks
2.1046 27.50(d)(4)	Maximum Peak Output Power	Pass	Meet the requirement of limit.
2.1047	Modulation Characteristics	Pass	Meet the requirement.
2.1055 27.54	Frequency Stability	Pass	Meet the requirement of limit.
2.1049	Occupied Bandwidth	Pass	Meet the requirement of limit.
27.50(d)(5)	Peak to Average Ratio	Pass	Meet the requirement of limit.
27.53(h)	Band Edge Measurements	Pass	Meet the requirement of limit.
2.1051 27.53(h)	Conducted Spurious Emissions	Pass	Meet the requirement of limit.
2.1053 27.53(h)	Radiated Spurious Emissions	Pass	Meet the requirement of limit. Minimum passing margin is -20.97 dB at 5197.50 MHz.

Applied Standard: FCC Part 27 & Part 2 (LTE 12)			
FCC Clause	Test Item	Result	Remarks
2.1046 27.50(c)	Maximum Peak Output Power	Pass	Meet the requirement of limit.
2.1047	Modulation Characteristics	Pass	Meet the requirement.
2.1055 27.54	Frequency Stability	Pass	Meet the requirement of limit.
2.1049	Occupied Bandwidth	Pass	Meet the requirement of limit.
---	Peak to Average Ratio	Pass	Meet the requirement of limit.
27.53(g)	Band Edge Measurements	Pass	Meet the requirement of limit.
2.1051 27.53(g)	Conducted Spurious Emissions	Pass	Meet the requirement of limit.
2.1053 27.53(g)	Radiated Spurious Emissions	Pass	Meet the requirement of limit. Minimum passing margin is -31.92 dB at 3537.50 MHz.

Note: Determining compliance based on the results of the compliance measurement, not taking into account measurement instrumentation uncertainty.

2.1 Measurement Uncertainty

Where relevant, the following measurement uncertainty levels have been estimated for tests performed on the EUT as specified in CISPR 16-4-2:

Measurement	Frequency	Expanded Uncertainty (k=2) (\pm)
Radiated Emissions up to 1 GHz	9 kHz ~ 30 MHz	3.04 dB
	30 MHz ~ 200 MHz	2.93 dB
	200 MHz ~ 1000 MHz	2.95 dB
Radiated Emissions above 1 GHz	1 GHz ~ 18 GHz	2.26 dB
	18 GHz ~ 40 GHz	1.94 dB

2.2 Test Site and Instruments

Description & Manufacturer	Model No.	Serial No.	Date of Calibration	Due Date of Calibration
Test Receiver Agilent	N9038A	MY51210203	Mar. 18, 2020	Mar. 17, 2021
Spectrum Analyzer Agilent	N9010A	MY52220314	Dec. 12, 2019	Dec. 11, 2020
Spectrum Analyzer ROHDE & SCHWARZ	FSU43	101261	Apr. 16, 2020	Apr. 15, 2021
HORN Antenna SCHWARZBECK	BBHA 9120D	9120D-969	Nov. 24, 2019	Nov. 23, 2020
BILOG Antenna SCHWARZBECK	VULB 9168	9168-472	Nov. 08, 2019	Nov. 07, 2020
Fixed Attenuator WORKEN	MDCS18N-10	MDCS18N-10-01	Apr. 14, 2020	Apr. 13, 2021
MXG Vector signal generator Agilent	N5182B	MY53050430	Oct. 25, 2019	Oct. 24, 2020
Loop Antenna	EM-6879	269	Sep. 16, 2019	Sep. 15, 2020
Preamplifier EMCI	EMC001340	980201	Oct. 14, 2019	Oct. 13, 2020
Preamplifier EMCI	EMC 012645	980115	Oct. 08, 2019	Oct. 07, 2020
Preamplifier EMCI	EMC 330H	980112	Oct. 08, 2019	Oct. 07, 2020
Power Meter Anritsu	ML2495A	1012010	Sep. 04, 2019	Sep. 03, 2020
Power Sensor Anritsu	MA2411B	1315050	Sep. 04, 2019	Sep. 03, 2020
RF Coaxial Cable HUBER+SUHNNER	EMC104-SM-SM-800 0&3000	140811+170717	Oct. 08, 2019	Oct. 07, 2020
RF Coaxial Cable HUBER+SUHNNER	SUCOFLEX 104	EMC104-SM-SM- 1000(140807)	Oct. 08, 2019	Oct. 07, 2020
RF Coaxial Cable Worken	8D-FB	Cable-Ch10-01	Oct. 08, 2019	Oct. 07, 2020
Boresight Antenna Fixture	FBA-01	FBA-SIP01	NA	NA
Software BV ADT	E3 6.120103	NA	NA	NA
Antenna Tower MF	MFA-440H	NA	NA	NA
Turn Table MF	MFT-201SS	NA	NA	NA
Antenna Tower & Turn Table Controller MF	MF-7802	NA	NA	NA

Note: 1. The calibration interval of the above test instruments is 12 months and the calibrations are traceable to NML/ROC and NIST/USA.

2. The test was performed in HwaYa Chamber 10.

3 General Information

3.1 General Description of EUT

Product	Apartment entry intercom device	
Brand	Latch	
Test Model	INT1LFCNA1	
Status of EUT	Engineering Sample	
Power Supply Rating	12Vdc-24Vdc from Adapter or 54 Vdc from POE Adapter	
Modulation Type	LTE	QPSK, 16QAM
Frequency Range	LTE Band 4 (Channel Bandwidth: 1.4 MHz)	1710.7 ~ 1754.3 MHz
	LTE Band 4 (Channel Bandwidth: 3 MHz)	1711.5 ~ 1753.5 MHz
	LTE Band 4 (Channel Bandwidth: 5 MHz)	1712.5 ~ 1752.5 MHz
	LTE Band 4 (Channel Bandwidth: 10 MHz)	1715.0 ~ 1750.0 MHz
	LTE Band 4 (Channel Bandwidth: 15 MHz)	1717.5 ~ 1747.5 MHz
	LTE Band 4 (Channel Bandwidth: 20 MHz)	1720.0 ~ 1745.0 MHz
	LTE Band 12 (Channel Bandwidth: 1.4 MHz)	699.7 ~ 715.3 MHz
	LTE Band 12 (Channel Bandwidth: 3 MHz)	700.5 ~ 714.5 MHz
	LTE Band 12 (Channel Bandwidth: 5 MHz)	701.5 ~ 713.5 MHz
	LTE Band 12 (Channel Bandwidth: 10 MHz)	704.0 ~ 711.0 MHz
Emission Designator	LTE Band 4 (Channel Bandwidth: 1.4 MHz)	1M09G7D
	LTE Band 4 (Channel Bandwidth: 3 MHz)	2M70G7D
	LTE Band 4 (Channel Bandwidth: 5 MHz)	4M49D7W
	LTE Band 4 (Channel Bandwidth: 10 MHz)	8M96G7D
	LTE Band 4 (Channel Bandwidth: 15 MHz)	13M5G7D
	LTE Band 4 (Channel Bandwidth: 20 MHz)	18M0G7D
	LTE Band 12 (Channel Bandwidth: 1.4 MHz)	1M09D7W
	LTE Band 12 (Channel Bandwidth: 3 MHz)	2M70G7D
	LTE Band 12 (Channel Bandwidth: 5 MHz)	4M49D7W
	LTE Band 12 (Channel Bandwidth: 10 MHz)	8M98G7D
Max. ERP Power	LTE Band 12 (Channel Bandwidth: 1.4 MHz)	132.43 mW
	LTE Band 12 (Channel Bandwidth: 3 MHz)	140.28 mW
	LTE Band 12 (Channel Bandwidth: 5 MHz)	148.94 mW
	LTE Band 12 (Channel Bandwidth: 10 MHz)	157.04 mW
Max. EIRP Power	LTE Band 4 (Channel Bandwidth: 1.4 MHz)	363.16 mW
	LTE Band 4 (Channel Bandwidth: 3 MHz)	387.35 mW
	LTE Band 4 (Channel Bandwidth: 5 MHz)	410.30 mW
	LTE Band 4 (Channel Bandwidth: 10 MHz)	436.62 mW
	LTE Band 4 (Channel Bandwidth: 15 MHz)	463.55 mW
	LTE Band 4 (Channel Bandwidth: 20 MHz)	491.02 mW

Antenna Type	PIFA Antenna	
Antenna Gain	LTE Band 4	3.381 dBi
	LTE Band 12	0.576 dBi
Accessory Device	N/A	
Data Cable Supplied	N/A	

Note:

- 16QAM only support 25RB.
- The above Antenna information is declared by manufacturer and for more detailed features description, please refer to the manufacturer's specifications, the laboratory shall not be held responsible.
- The above EUT information is declared by manufacturer and for more detailed features description, please refers to the manufacturer's specifications or user's manual.

3.2 Configuration of System under Test

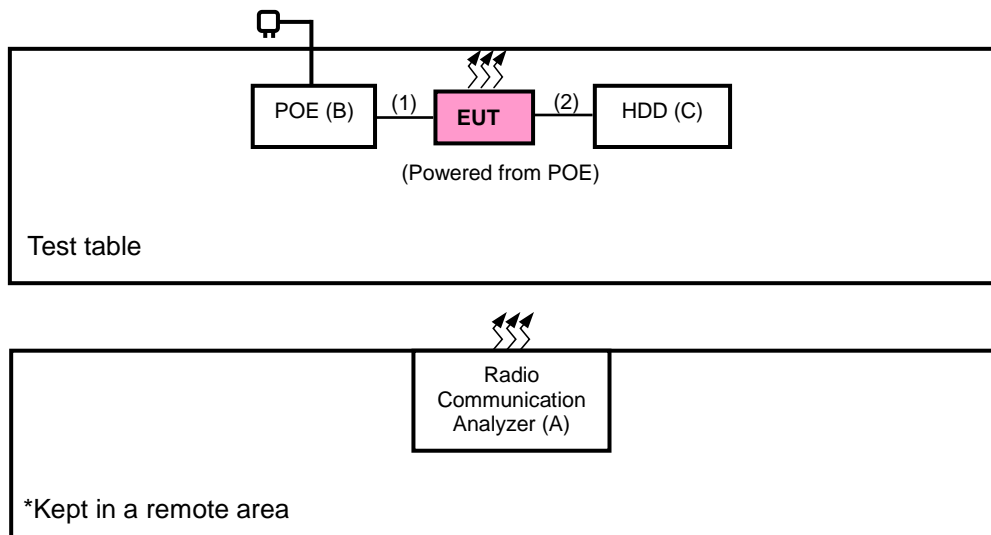

3.2.1 Description of Support Units

The EUT has been tested as an independent unit together with other necessary accessories or support units. The following support units or accessories were used to form a representative test configuration during the tests.

No.	Product	Brand	Model No.	Serial No.	FCC ID
A	Radio Communication Analyzer	Anritsu	MT8820C	6201300640	N/A
B	POE	N/A	N/A	N/A	N/A
C	HDD	TOSHIBA	DTB305	45TGCN0IT3ZB	N/A

Note: Item A acted as communication partner to transfer data.

ID	Cable Descriptions	Qty.	Length (m)	Shielding (Yes/No)	Cores (Qty.)	Remarks
1.	LAN Cable	1	1.5	N	0	--
2.	USB Cable	1	0.5	N	0	--

3.3 Test Mode Applicability and Tested Channel Detail

Pre-Scan has been conducted to determine the worst-case mode from all possible combinations between available modulations, data rates, XYZ axis, and antenna ports

The worst case was found when positioned as the table below. Following channel(s) was (were) selected for the final test as listed below:

Band	ERP / EIRP	Radiated Emission
LTE Band 4	X-plane	X-plane
LTE Band 12	Y-plane	Y-plane

LTE Band 4

EUT Configure Mode	Test Item	Available Channel	Tested Channel	Channel Bandwidth	Modulation	Mode
-	EIRP	19957 to 20393	19957, 20175, 20393	1.4 MHz	QPSK, 16QAM	1 RB / 0 RB Offset
		19965 to 20385	19965, 20175, 20385	3 MHz	QPSK, 16QAM	1 RB / 0 RB Offset
		19975 to 20375	19975, 20175, 20375	5 MHz	QPSK, 16QAM	1 RB / 0 RB Offset
		20000 to 20350	20000, 20175, 20350	10 MHz	QPSK	1 RB / 0 RB Offset
		20025 to 20325	20025, 20175, 20325	15 MHz	QPSK	1 RB / 0 RB Offset
		20050 to 20300	20050, 20175, 20300	20 MHz	QPSK	1 RB / 0 RB Offset
-	Modulation Characteristics	20050 to 20300	20175	20 MHz	QPSK, 16QAM	25 RB / 0 RB Offset
-	Frequency Stability	19957 to 20393	19957, 20393	1.4 MHz	QPSK	1 RB / 0 RB Offset
		19965 to 20385	19965, 20385	3 MHz	QPSK	1 RB / 0 RB Offset
		19975 to 20375	19975, 20375	5 MHz	QPSK	1 RB / 0 RB Offset
		20000 to 20350	20000, 20350	10 MHz	QPSK	1 RB / 0 RB Offset
		20025 to 20325	20025, 20325	15 MHz	QPSK	1 RB / 0 RB Offset
		20050 to 20300	20050, 20300	20 MHz	QPSK	1 RB / 0 RB Offset
-	Occupied Bandwidth	19957 to 20393	19957, 20175, 20393	1.4 MHz	QPSK, 16QAM	6 RB / 0 RB Offset
		19965 to 20385	19965, 20175, 20385	3 MHz	QPSK, 16QAM	15 RB / 0 RB Offset
		19975 to 20375	19975, 20175, 20375	5 MHz	QPSK, 16QAM	25 RB / 0 RB Offset
		20000 to 20350	20000, 20175, 20350	10 MHz	QPSK	50 RB / 0 RB Offset
		20025 to 20325	20025, 20175, 20325	15 MHz	QPSK	75 RB / 0 RB Offset
		20050 to 20300	20050, 20175, 20300	20 MHz	QPSK	100 RB / 0 RB Offset
-	Peak to Average Ratio	19957 to 20393	19957, 20175, 20393	1.4 MHz	QPSK, 16QAM	1 RB / 0 RB Offset
		19965 to 20385	19965, 20175, 20385	3 MHz	QPSK, 16QAM	1 RB / 0 RB Offset
		19975 to 20375	19975, 20175, 20375	5 MHz	QPSK, 16QAM	1 RB / 0 RB Offset
		20000 to 20350	20000, 20175, 20350	10 MHz	QPSK	1 RB / 0 RB Offset
		20025 to 20325	20025, 20175, 20325	15 MHz	QPSK	1 RB / 0 RB Offset
		20050 to 20300	20050, 20175, 20300	20 MHz	QPSK	1 RB / 0 RB Offset

EUT Configure Mode	Test Item	Available Channel	Tested Channel	Channel Bandwidth	Modulation	Mode		
-	Band Edge	19957 to 20393	19957	1.4 MHz	QPSK	1 RB / 0 RB Offset 6 RB / 0 RB Offset		
			20393	1.4 MHz	QPSK	1 RB / 5 RB Offset 6 RB / 0 RB Offset		
		19965 to 20385	19965	3 MHz	QPSK	1 RB / 0 RB Offset 15 RB / 0 RB Offset		
			20385	3 MHz	QPSK	1 RB / 14 RB Offset 15 RB / 0 RB Offset		
		19975 to 20375	19975	5 MHz	QPSK	1 RB / 0 RB Offset 25 RB / 0 RB Offset		
			20375	5 MHz	QPSK	1 RB / 24 RB Offset 25 RB / 0 RB Offset		
		20000 to 20350	20000	10 MHz	QPSK	1 RB / 0 RB Offset 50 RB / 0 RB Offset		
			20350	10 MHz	QPSK	1 RB / 49 RB Offset 50 RB / 0 RB Offset		
		20025 to 20325	20025	15 MHz	QPSK	1 RB / 0 RB Offset 75 RB / 0 RB Offset		
			20325	15 MHz	QPSK	1 RB / 74 RB Offset 75 RB / 0 RB Offset		
		20050 to 20300	20050	20 MHz	QPSK	1 RB / 0 RB Offset 100 RB / 0 RB Offset		
			20300	20 MHz	QPSK	1 RB / 99 RB Offset 100 RB / 0 RB Offset		
		-	Conducted Emission	19957 to 20393	19957, 20175, 20393	1.4 MHz	QPSK	1 RB / 0 RB Offset
				19965 to 20385	19965, 20175, 20385	3 MHz	QPSK	1 RB / 0 RB Offset
				19975 to 20375	19975, 20175, 20375	5 MHz	QPSK	1 RB / 0 RB Offset
				20000 to 20350	20000, 20175, 20350	10 MHz	QPSK	1 RB / 0 RB Offset
				20025 to 20325	20025, 20175, 20325	15 MHz	QPSK	1 RB / 0 RB Offset
				20050 to 20300	20050, 20175, 20300	20 MHz	QPSK	1 RB / 0 RB Offset
-	Radiated Emission	19957 to 20393	19957, 20175, 20393	1.4 MHz	QPSK	1 RB / 0 RB Offset		
		19975 to 20375	19975, 20175, 20375	5 MHz	QPSK	1 RB / 0 RB Offset		
		20050 to 20300	20050, 20175, 20300	20 MHz	QPSK	1 RB / 0 RB Offset		

Note:

1. This device was tested under all bandwidths, RB configurations and modulations. The worst case was found in QPSK modulation.
2. For radiated emission above 1 GHz, according to 3GPP 36.521 Section 6.6.3.1.4, choose the lowest, 5 MHz & highest channel bandwidth for final test.

LTE Band 12

EUT Configure Mode	Test Item	Available Channel	Tested Channel	Channel Bandwidth	Modulation	Mode		
-	ERP	23017 to 23173	23017, 23095, 23173	1.4 MHz	QPSK, 16QAM	1 RB / 0 RB Offset		
		23025 to 23165	23025, 23095, 23165	3 MHz	QPSK, 16QAM	1 RB / 0 RB Offset		
		23035 to 23155	23035, 23095, 23155	5 MHz	QPSK, 16QAM	1 RB / 0 RB Offset		
		23060 to 23130	23060, 23095, 23130	10 MHz	QPSK	1 RB / 0 RB Offset		
-	Modulation Characteristics	23060 to 23130	23095	10 MHz	QPSK, 16QAM	25 RB / 0 RB Offset		
-	Frequency Stability	23017 to 23173	23017, 23173	1.4 MHz	QPSK	1 RB / 0 RB Offset		
		23025 to 23165	23025, 23165	3 MHz	QPSK	1 RB / 0 RB Offset		
		23035 to 23155	23035, 23155	5 MHz	QPSK	1 RB / 0 RB Offset		
		23060 to 23130	23060, 23130	10 MHz	QPSK	1 RB / 0 RB Offset		
-	Occupied Bandwidth	23017 to 23173	23017, 23095, 23173	1.4 MHz	QPSK, 16QAM	6 RB / 0 RB Offset		
		23025 to 23165	23025, 23095, 23165	3 MHz	QPSK, 16QAM	15 RB / 0 RB Offset		
		23035 to 23155	23035, 23095, 23155	5 MHz	QPSK, 16QAM	25 RB / 0 RB Offset		
		23060 to 23130	23060, 23095, 23130	10 MHz	QPSK	50 RB / 0 RB Offset		
-	Peak to Average Ratio	23017 to 23173	23017, 23095, 23173	1.4 MHz	QPSK, 16QAM	1 RB / 0 RB Offset		
		23025 to 23165	23025, 23095, 23165	3 MHz	QPSK, 16QAM	1 RB / 0 RB Offset		
		23035 to 23155	23035, 23095, 23155	5 MHz	QPSK, 16QAM	1 RB / 0 RB Offset		
		23060 to 23130	23060, 23095, 23130	10 MHz	QPSK	1 RB / 0 RB Offset		
-	Band Edge	23017 to 23173	23017	1.4 MHz	QPSK	1 RB / 0 RB Offset		
			23173	1.4 MHz	QPSK	6 RB / 0 RB Offset		
		23025 to 23165	23025	3 MHz	QPSK	1 RB / 5 RB Offset		
			23165	3 MHz	QPSK	6 RB / 0 RB Offset		
		23035 to 23155	23035	5 MHz	QPSK	1 RB / 0 RB Offset		
			23155	5 MHz	QPSK	15 RB / 0 RB Offset		
		23060 to 23130	23060	10 MHz	QPSK	1 RB / 14 RB Offset		
			23130	10 MHz	QPSK	15 RB / 0 RB Offset		
		-	Conducted Emission	23017 to 23173	23017, 23095, 23173	1.4 MHz	QPSK	1 RB / 0 RB Offset
				23025 to 23165	23025, 23095, 23165	3 MHz	QPSK	1 RB / 0 RB Offset
				23035 to 23155	23035, 23095, 23155	5 MHz	QPSK	1 RB / 0 RB Offset
				23060 to 23130	23060, 23095, 23130	10 MHz	QPSK	1 RB / 0 RB Offset
-	Radiated Emission	23017 to 23173	23017, 23095, 23173	1.4 MHz	QPSK	1 RB / 0 RB Offset		
		23035 to 23155	23035, 23095, 23155	5 MHz	QPSK	1 RB / 0 RB Offset		
		23060 to 23130	23060, 23095, 23130	10 MHz	QPSK	1 RB / 0 RB Offset		

Note:

1. This device was tested under all bandwidths, RB configurations and modulations. The worst case was found in QPSK modulation.
2. For radiated emission above 1 GHz, according to 3GPP 36.521 Section 6.6.3.1.4, choose the lowest, 5 MHz & highest channel bandwidth for final test.

Test Condition:

Test Item	Environmental Conditions	Input Power	Tested By
ERP / EIRP	26 deg. C, 58 % RH	120 Vac, 60 Hz	Cyril Chen
Modulation Characteristics	26 deg. C, 58 % RH	120 Vac, 60 Hz	Getac Yang
Frequency Stability	26 deg. C, 58 % RH	120 Vac, 60 Hz	Getac Yang
Occupied Bandwidth	26 deg. C, 58 % RH	120 Vac, 60 Hz	Getac Yang
Band Edge	26 deg. C, 58 % RH	120 Vac, 60 Hz	Getac Yang
Peak to Average Ratio	26 deg. C, 58 % RH	120 Vac, 60 Hz	Getac Yang
Conducted Emission	26 deg. C, 58 % RH	120 Vac, 60 Hz	Getac Yang
Radiated Emission	25 deg. C, 65 % RH	120 Vac, 60 Hz	Cyril Chen

3.4 EUT Operating Conditions

The EUT makes a call to the communication simulator. The communication simulator station system controlled a EUT to export maximum output power under transmission mode and specific channel frequency

3.5 General Description of Applied Standards and references

The EUT is a RF Product. According to the specifications of the manufacturer, it must comply with the requirements of the following standards and references:

Test Standard:

FCC 47 CFR Part 2

FCC 47 CFR Part 27

ANSI 63.26-2015

Note: All test items have been performed and recorded as per the above standards.

References Test Guidance:

KDB 971168 D01 Power Meas License Digital Systems v03r01

ANSI/TIA/EIA-603-E 2016

Note: All test items have been performed as a reference to the above KDB test guidance.

4 Test Types and Results

4.1 Output Power Measurement

4.1.1 Limits of Output Power Measurement

Fixed, mobile, and portable (hand-held) stations operating in the 1710–1755 MHz band and mobile and portable stations operating in the 1695-1710 MHz and 1755-1780 MHz bands are limited to 1 watt EIRP.

Portable stations (hand-held devices) operating in the 746-757 MHz, 776-788 MHz and 805-806 MHz band are limited to 3 watts ERP

Portable stations (hand-held device) operating in the 600 MHz uplink band and the 698-746 MHz band, and fixed and mobile stations in the 600 MHz uplink band are limited to 3 watts ERP.

4.1.2 Test Procedures

EIRP / ERP Measurement:

- a. All measurements were done at low, middle and high operational frequency range. RBW and VBW is 10 MHz for LTE mode.
- b. Substitution method is used for E.I.R.P measurement. In the semi-anechoic chamber, EUT placed on the 0.8 m (below or equal 1 GHz) and/or 1.5 m (above 1 GHz) height of Turn Table, rotated the table around 360 degrees to search the maximum radiation power and receiver antenna shall be rotated vertical and horizontal polarization and moved height from 1 m to 4 m to find the maximum polar radiated power. The “Read Value” is the spectrum reading the maximum power value.
- c. The substitution horn antenna is substituted for EUT at the same position and signals generator export the CW signal to the substitution antenna via a tx cable. Rotated the Turn Table and moved receiving antenna to find the maximum radiation power. Adjust output power level of S.G to get a Value of spectrum reading equal to “Read Value” of step b. Record the power level of S.G.
- d. $EIRP = \text{Output power level of S.G} - \text{TX cable loss} + \text{Antenna gain of substitution horn}$. E.R.P power can be calculated form E.I.R.P power by subtracting the gain of dipole, $E.R.P \text{ power} = E.I.R.P \text{ power} - 2.15 \text{ dB}$.

Conducted Power Measurement:

- a. The EUT was set up for the maximum power with LTE link data modulation and link up with simulator.
- b. Set the EUT to transmit under low, middle and high channel and record the power level shown on simulator.

4.1.3 Test Setup

EIRP / ERP Measurement:

<Radiated Emission below or equal 1 GHz>

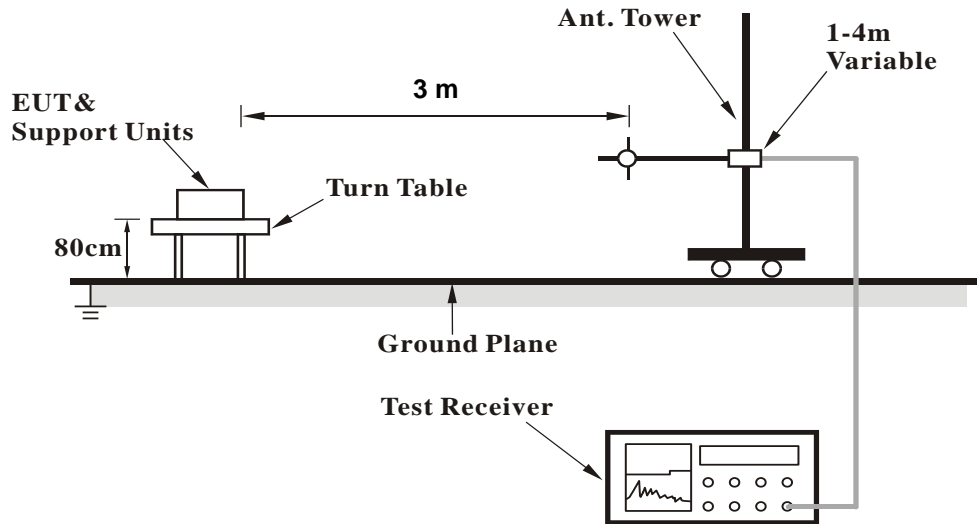

<Radiated Emission above 1 GHz>

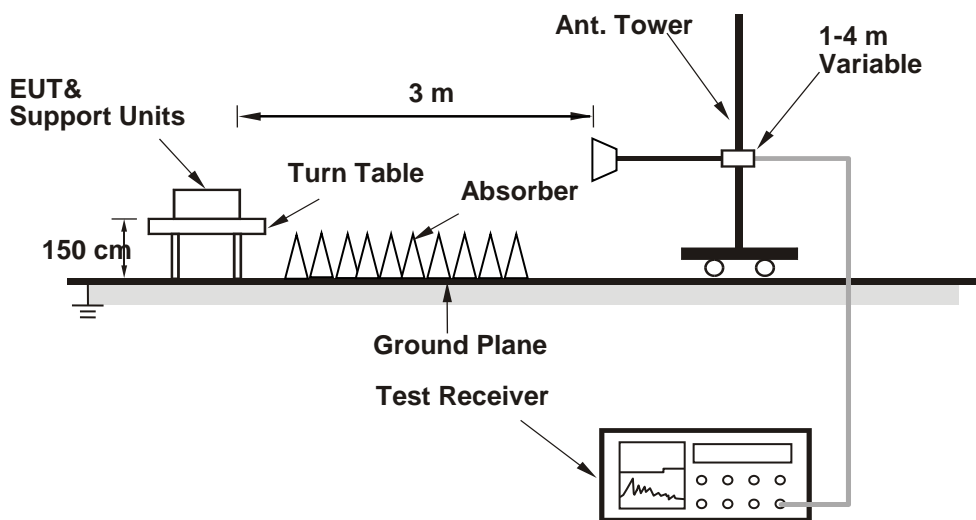

For the actual test configuration, please refer to the attached file (Test Setup Photo).

Conducted Power Measurement:



4.1.4 Test Results

Conducted Output Power (dBm)

LTE Band 4															
BW	MCS Index	RB Size	RB Offset	Low	Mid	High	3GPP MPR (dB)	BW	MCS Index	RB Size	RB Offset	Low	Mid	High	3GPP MPR (dB)
				20050	20175	20300						20025	20175	20325	
				Channel	20050	20175						20300	Channel	20025	
		Frequency (MHz)		1720.0	1732.5	1745.0			Frequency (MHz)		1717.5	1732.5	1747.5		
20M	QPSK	1	0	23.44	23.22	23.53	0	15M	QPSK	1	0	23.36	23.14	23.45	0
		1	50	23.29	23.13	23.37	0			1	37	23.32	23.02	23.31	0
		1	99	23.16	22.91	23.28	0			1	74	23.17	22.88	23.11	0
		50	0	22.31	22.12	22.38	1			36	0	22.26	22.03	22.36	1
		50	25	22.11	21.93	22.16	1			36	19	22.10	21.81	22.15	1
		50	50	22.02	21.82	22.07	1			36	39	21.98	21.74	22.03	1
		100	0	22.35	22.12	22.38	1			75	0	22.18	22.09	22.38	1
	16QAM	1	0	x	x	x	1		16QAM	1	0	x	x	x	1
		1	50	x	x	x	1			1	37	x	x	x	1
		1	99	x	x	x	1			1	74	x	x	x	1
		50	0	x	x	x	2			36	0	x	x	x	2
		50	25	x	x	x	2			36	19	x	x	x	2
		50	50	x	x	x	2			36	39	x	x	x	2
		100	0	x	x	x	2			75	0	x	x	x	2
10M	QPSK	1	0	23.33	23.10	23.42	0	5M	QPSK	1	0	23.26	23.02	23.36	0
		1	24	23.19	22.99	23.32	0			1	12	23.07	22.85	23.20	0
		1	49	23.03	22.79	23.23	0			1	24	22.90	22.66	23.14	0
		25	0	22.21	21.97	22.34	1			12	0	22.10	21.98	22.22	1
		25	12	22.05	21.81	22.18	1			12	6	21.90	21.74	22.03	1
		25	25	21.92	21.74	22.00	1			12	13	21.86	21.65	21.92	1
		50	0	22.12	21.94	22.33	1			25	0	22.22	21.84	22.20	1
	16QAM	1	0	x	x	x	1		16QAM	1	0	22.18	21.93	22.27	1
		1	24	x	x	x	1			1	12	21.98	21.82	22.14	1
		1	49	x	x	x	1			1	24	21.83	21.61	22.13	1
		25	0	x	x	x	2			12	0	20.94	20.97	21.12	2
		25	12	x	x	x	2			12	6	20.83	20.65	20.95	2
		25	25	x	x	x	2			12	13	20.77	20.63	20.89	2
		50	0	x	x	x	2			25	0	21.08	20.76	21.17	2
3M	QPSK	1	0	23.22	22.96	23.32	0	1.4M	QPSK	1	0	23.13	22.87	23.22	0
		1	7	23.14	22.94	23.23	0			1	2	23.06	22.84	23.16	0
		1	14	22.95	22.77	22.99	0			1	5	23.02	22.76	23.10	0
		8	0	22.20	21.92	22.16	1			3	0	22.96	22.68	23.05	0
		8	3	21.98	21.73	21.97	1			3	1	22.90	22.60	22.99	0
		8	7	21.87	21.61	21.89	1			3	3	22.85	22.53	22.94	0
		15	0	22.05	21.77	22.21	1			6	0	21.98	21.68	22.07	1
	16QAM	1	0	22.16	21.91	22.31	1		16QAM	1	0	22.11	21.82	22.20	1
		1	7	22.07	21.93	22.19	1			1	2	21.97	21.79	22.09	1
		1	14	21.87	21.69	21.98	1			1	5	21.98	21.70	22.08	1
		8	0	21.11	20.86	21.01	2			3	0	21.90	21.65	21.99	1
		8	3	20.97	20.72	20.93	2			3	1	21.87	21.58	21.93	1
		8	7	20.84	20.54	20.83	2			3	3	21.84	21.44	21.93	1
		15	0	21.02	20.74	21.02	2			6	0	20.93	20.62	20.98	2

LTE Band 12															
BW	MCS Index	RB Size	RB Offset	Low	Mid	High	3GPP MPR (dB)	BW	MCS Index	RB Size	RB Offset	Low	Mid	High	3GPP MPR (dB)
				23060	23095	23130						23035	23095	23155	
				Channel	23060	23095						23130	Channel	23035	
Frequency (MHz)	704.0	707.5	711.0	Frequency (MHz)	701.5	707.5	713.5								
10M	QPSK	1	0	23.51	23.43	23.59	0	5M	QPSK	1	0	23.45	23.37	23.55	0
		1	24	23.36	23.28	23.47	0			1	12	23.32	23.24	23.42	0
		1	49	23.27	23.15	23.33	0			1	24	23.21	23.06	23.18	0
		25	0	22.40	22.27	22.50	1			12	0	22.37	22.30	22.43	1
		25	12	22.22	22.07	22.33	1			12	6	22.20	22.07	22.22	1
		25	25	22.12	21.98	22.17	1			12	13	22.12	21.97	22.17	1
	16QAM	50	0	22.35	22.26	22.39	1		25	0	22.23	22.25	22.32	1	
		1	0	x	x	x	1		1	0	22.40	22.34	22.47	1	
		1	24	x	x	x	1		1	12	22.29	22.15	22.33	1	
		1	49	x	x	x	1		1	24	22.16	22.05	22.17	1	
		25	0	x	x	x	2		12	0	21.19	21.15	21.24	2	
		25	12	x	x	x	2		12	6	21.19	21.04	21.19	2	
		25	25	x	x	x	2		12	13	21.08	20.91	21.12	2	
		50	0	x	x	x	2		25	0	21.21	21.23	21.27	2	

BW	MCS Index	RB Size	RB Offset	Low	Mid	High	3GPP MPR (dB)	BW	MCS Index	RB Size	RB Offset	Low	Mid	High	3GPP MPR (dB)
				23025	23095	23165						23017	23095	23173	
				Channel	23025	23095						23165	Channel	23017	
Frequency (MHz)	700.5	707.5	714.5	Frequency (MHz)	699.7	707.5	715.3								
3M	QPSK	1	0	23.39	23.30	23.48	0	1.4M	QPSK	1	0	23.37	23.29	23.43	0
		1	7	23.27	23.24	23.38	0			1	2	23.22	23.14	23.27	0
		1	14	23.12	23.05	23.19	0			1	5	23.04	22.91	23.17	0
		8	0	22.23	22.14	22.34	1			3	0	22.23	22.20	22.32	0
		8	3	22.07	21.95	22.20	1			3	1	22.01	21.99	22.14	0
		8	7	21.97	21.86	22.03	1			3	3	21.97	21.93	22.07	0
	16QAM	15	0	22.32	22.09	22.40	1		6	0	22.30	22.20	22.24	1	
		1	0	22.33	22.29	22.47	1		1	0	22.28	22.22	22.34	1	
		1	7	22.25	22.16	22.33	1		1	2	22.21	22.09	22.24	1	
		1	14	22.07	21.98	22.13	1		1	5	22.03	21.88	22.09	1	
		8	0	21.22	20.95	21.29	2		3	0	21.01	21.18	21.12	1	
		8	3	21.06	20.91	21.11	2		3	1	20.98	20.92	21.11	1	
		8	7	20.96	20.82	21.01	2		3	3	20.92	20.87	20.99	1	
		15	0	21.30	21.05	21.36	2		6	0	21.19	21.16	21.21	2	

ERP Power (dBm)

LTE Band 12							
Channel Bandwidth: 1.4 MHz / QPSK							
Plane	Channel	Frequency (MHz)	Reading (dBm)	Correction Factor (dB)	ERP (dBm)	ERP (mW)	Polarization (H/V)
Y	23017	699.7	-9.24	30.36	21.12	129.42	H
	23095	707.5	-9.11	30.17	21.06	127.64	
	23173	715.3	-8.95	30.17	21.22	132.43	
	23017	699.7	-18.29	32.03	13.74	23.66	V
	23095	707.5	-18.46	31.98	13.52	22.49	
	23173	715.3	-18.10	32.06	13.96	24.89	
Channel Bandwidth: 1.4 MHz / 16QAM							
Y	23017	699.7	-10.23	30.36	20.13	103.04	H
	23095	707.5	-10.10	30.17	20.07	101.62	
	23173	715.3	-9.94	30.17	20.23	105.44	
	23017	699.7	-19.28	32.03	12.75	18.84	V
	23095	707.5	-19.45	31.98	12.53	17.91	
	23173	715.3	-19.09	32.06	12.97	19.82	

Note: ERP (dBm) = Reading (dBm) + Correction Factor (dB)

LTE Band 12							
Channel Bandwidth: 3 MHz / QPSK							
Plane	Channel	Frequency (MHz)	Reading (dBm)	Correction Factor (dB)	ERP (dBm)	ERP (mW)	Polarization (H/V)
Y	23025	700.5	-8.80	30.17	21.37	137.09	H
	23095	707.5	-8.86	30.17	21.31	135.21	
	23165	714.5	-8.71	30.18	21.47	140.28	
	23025	700.5	-17.97	31.96	13.99	25.06	V
	23095	707.5	-18.21	31.98	13.77	23.82	
	23165	714.5	-17.82	32.03	14.21	26.36	
Channel Bandwidth: 3 MHz / 16QAM							
Y	23025	700.5	-9.81	30.17	20.36	108.64	H
	23095	707.5	-9.87	30.17	20.30	107.15	
	23165	714.5	-9.72	30.18	20.46	111.17	
	23025	700.5	-18.98	31.96	12.98	19.86	V
	23095	707.5	-19.22	31.98	12.76	18.88	
	23165	714.5	-18.83	32.03	13.20	20.89	

Note: ERP (dBm) = Reading (dBm) + Correction Factor (dB)

LTE Band 12							
Channel Bandwidth: 5 MHz / QPSK							
Plane	Channel	Frequency (MHz)	Reading (dBm)	Correction Factor (dB)	ERP (dBm)	ERP (mW)	Polarization (H/V)
Y	23035	701.5	-8.54	30.17	21.63	145.55	H
	23095	707.5	-8.60	30.17	21.57	143.55	
	23155	713.5	-8.45	30.18	21.73	148.94	
	23035	701.5	-17.71	31.96	14.25	26.61	V
	23095	707.5	-17.95	31.98	14.03	25.29	
	23155	713.5	-17.56	32.03	14.47	27.99	
Channel Bandwidth: 5 MHz / 16QAM							
Y	23035	701.5	-9.57	30.17	20.60	114.82	H
	23095	707.5	-9.63	30.17	20.54	113.24	
	23155	713.5	-9.48	30.18	20.70	117.49	
	23035	701.5	-18.74	31.96	13.22	20.99	V
	23095	707.5	-18.98	31.98	13.00	19.95	
	23155	713.5	-18.59	32.03	13.44	22.08	

Note: ERP (dBm) = Reading (dBm) + Correction Factor (dB)

LTE Band 12							
Channel Bandwidth: 10 MHz / QPSK							
Plane	Channel	Frequency (MHz)	Reading (dBm)	Correction Factor (dB)	ERP (dBm)	ERP (mW)	Polarization (H/V)
Y	23060	704.0	-8.31	30.17	21.86	153.46	H
	23095	707.5	-8.37	30.17	21.80	151.36	
	23130	711.0	-8.22	30.18	21.96	157.04	
	23060	704.0	-17.48	31.96	14.48	28.05	V
	23095	707.5	-17.72	31.98	14.26	26.67	
	23130	711.0	-17.33	32.03	14.70	29.51	

Note: ERP (dBm) = Reading (dBm) + Correction Factor (dB)

EIRP Power (dBm)

LTE Band 4							
Channel Bandwidth: 1.4 MHz / QPSK							
Plane	Channel	Frequency (MHz)	Reading (dBm)	Correction Factor (dB)	EIRP (dBm)	EIRP (mW)	Polarization (H/V)
X	19957	1710.7	-21.41	36.45	15.04	31.92	H
	20175	1732.5	-21.91	36.80	14.89	30.83	
	20393	1754.3	-21.73	36.94	15.21	33.19	
	19957	1710.7	-11.77	37.28	25.51	355.71	V
	20175	1732.5	-12.34	37.63	25.29	338.14	
	20393	1754.3	-12.04	37.64	25.60	363.16	
Channel Bandwidth: 1.4 MHz / 16QAM							
X	19957	1710.7	-22.37	36.45	14.08	25.59	H
	20175	1732.5	-22.87	36.80	13.93	24.72	
	20393	1754.3	-22.69	36.94	14.25	26.61	
	19957	1710.7	-12.73	37.28	24.55	285.17	V
	20175	1732.5	-13.30	37.63	24.33	271.08	
	20393	1754.3	-13.00	37.64	24.64	291.14	

Note: EIRP (dBm) = Reading (dBm) + Correction Factor (dB)

LTE Band 4							
Channel Bandwidth: 3 MHz / QPSK							
Plane	Channel	Frequency (MHz)	Reading (dBm)	Correction Factor (dB)	EIRP (dBm)	EIRP (mW)	Polarization (H/V)
X	19965	1711.5	-21.13	36.45	15.32	34.04	H
	20175	1732.5	-21.63	36.80	15.17	32.89	
	20385	1753.5	-21.45	36.94	15.49	35.40	
	19965	1711.5	-11.49	37.28	25.79	379.40	V
	20175	1732.5	-12.06	37.63	25.57	360.66	
	20385	1753.5	-11.76	37.64	25.88	387.35	
Channel Bandwidth: 3 MHz / 16QAM							
X	19965	1711.5	-22.11	36.45	14.34	27.16	H
	20175	1732.5	-22.61	36.80	14.19	26.24	
	20385	1753.5	-22.43	36.94	14.51	28.25	
	19965	1711.5	-12.47	37.28	24.81	302.76	V
	20175	1732.5	-13.04	37.63	24.59	287.81	
	20385	1753.5	-12.74	37.64	24.90	309.10	

Note: EIRP (dBm) = Reading (dBm) + Correction Factor (dB)

LTE Band 4							
Channel Bandwidth: 5 MHz / QPSK							
Plane	Channel	Frequency (MHz)	Reading (dBm)	Correction Factor (dB)	EIRP (dBm)	EIRP (mW)	Polarization (H/V)
X	19975	1712.5	-20.88	36.45	15.57	36.06	H
	20175	1732.5	-21.38	36.80	15.42	34.83	
	20375	1752.5	-21.20	36.94	15.74	37.50	
	19975	1712.5	-11.24	37.28	26.04	401.88	V
	20175	1732.5	-11.81	37.63	25.82	382.03	
	20375	1752.5	-11.51	37.64	26.13	410.30	
Channel Bandwidth: 5 MHz / 16QAM							
X	19975	1712.5	-21.84	36.45	14.61	28.91	H
	20175	1732.5	-22.34	36.80	14.46	27.93	
	20375	1752.5	-22.16	36.94	14.78	30.06	
	19975	1712.5	-12.20	37.28	25.08	322.18	V
	20175	1732.5	-12.77	37.63	24.86	306.27	
	20375	1752.5	-12.47	37.64	25.17	328.93	

Note: EIRP (dBm) = Reading (dBm) + Correction Factor (dB)

LTE Band 4							
Channel Bandwidth: 10 MHz / QPSK							
Plane	Channel	Frequency (MHz)	Reading (dBm)	Correction Factor (dB)	EIRP (dBm)	EIRP (mW)	Polarization (H/V)
X	20000	1715.0	-20.80	36.64	15.84	38.37	H
	20175	1732.5	-21.11	36.80	15.69	37.07	
	20350	1750.0	-20.79	36.80	16.01	39.90	
	20000	1715.0	-11.13	37.44	26.31	427.66	V
	20175	1732.5	-11.54	37.63	26.09	406.54	
	20350	1750.0	-11.23	37.64	26.40	436.62	

Note: EIRP (dBm) = Reading (dBm) + Correction Factor (dB)

LTE Band 4							
Channel Bandwidth: 15 MHz / QPSK							
Plane	Channel	Frequency (MHz)	Reading (dBm)	Correction Factor (dB)	EIRP (dBm)	EIRP (mW)	Polarization (H/V)
X	20025	1717.5	-20.35	36.45	16.10	40.74	H
	20175	1732.5	-20.85	36.80	15.95	39.36	
	20325	1747.5	-20.67	36.94	16.27	42.36	
	20025	1717.5	-10.71	37.28	26.57	454.05	V
	20175	1732.5	-11.28	37.63	26.35	431.62	
	20325	1747.5	-10.98	37.64	26.66	463.55	

Note: EIRP (dBm) = Reading (dBm) + Correction Factor (dB)

LTE Band 4							
Channel Bandwidth: 20 MHz / QPSK							
Plane	Channel	Frequency (MHz)	Reading (dBm)	Correction Factor (dB)	EIRP (dBm)	EIRP (mW)	Polarization (H/V)
X	20050	1720.0	-20.10	36.45	16.35	43.15	H
	20175	1732.5	-20.60	36.80	16.20	41.69	
	20300	1745.0	-20.42	36.94	16.52	44.87	
	20050	1720.0	-10.46	37.28	26.82	480.95	V
	20175	1732.5	-11.03	37.63	26.60	457.19	
	20300	1745.0	-10.73	37.64	26.91	491.02	

Note: EIRP (dBm) = Reading (dBm) + Correction Factor (dB)

4.2 Modulation Characteristics Measurement

4.2.1 Limits of Modulation Characteristics

N/A

4.2.2 Test Setup



4.2.3 Test Procedure

Connect the EUT to Communication Simulator via the antenna connector. The frequency band is set as EUT supported Modulation and Channels, the EUT output is matched with 50 ohm load, the waveform quality and constellation of the EUT was tested.

4.2.4 Test Results

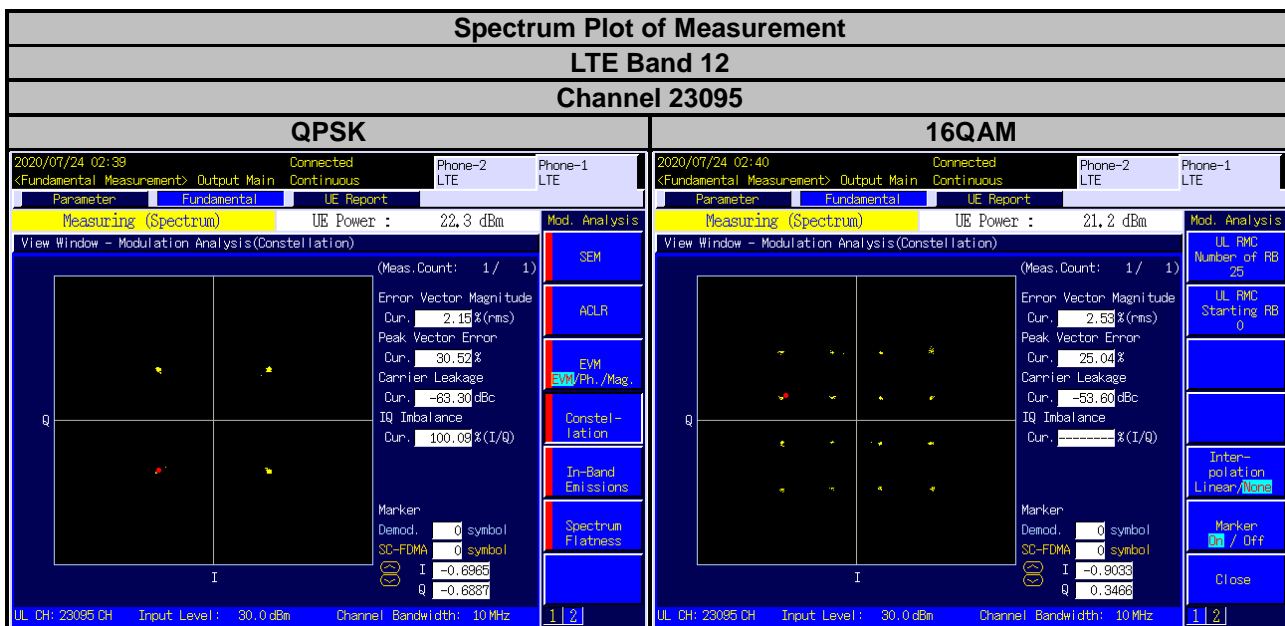
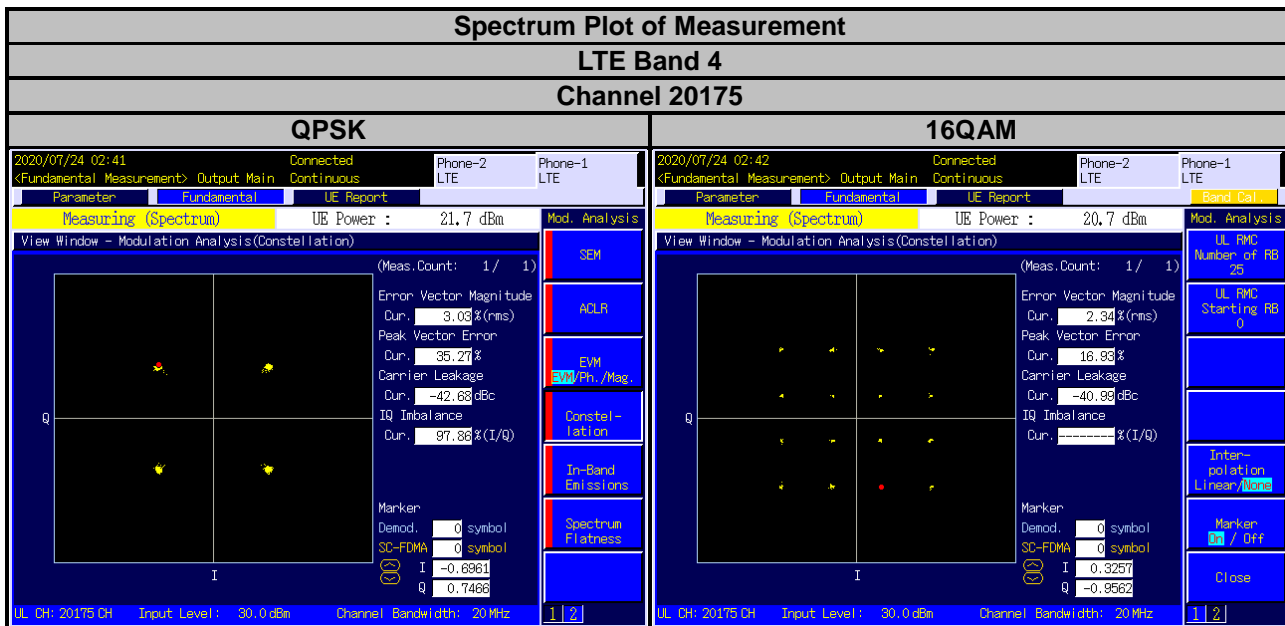

4.3 Frequency Stability Measurement

4.3.1 Limits of Frequency Stability Measurement

The frequency stability shall be sufficient to ensure that the fundamental emissions stay within the authorized bands of operation.

4.3.2 Test Procedure

- Device is placed at the oven room. The oven room could control the temperatures and humidity. Power warm up is at least 15 min and power applied should perform before recording frequency error.
- EUT is connected the external power supply to control the AC input power. The test voltage range is from minimum to maximum working voltage. Each step shall be record the frequency error rate.
- The temperature range step is 10 degrees in this test items. All temperature levels shall be hold the $\pm 0.5^{\circ}\text{C}$ during the measurement testing. The each temperature step shall be at least 0.5 hours, consider the EUT could be test under the stability condition.

Note: The frequency error was recorded frequency error from the communication simulator.

4.3.3 Test Setup

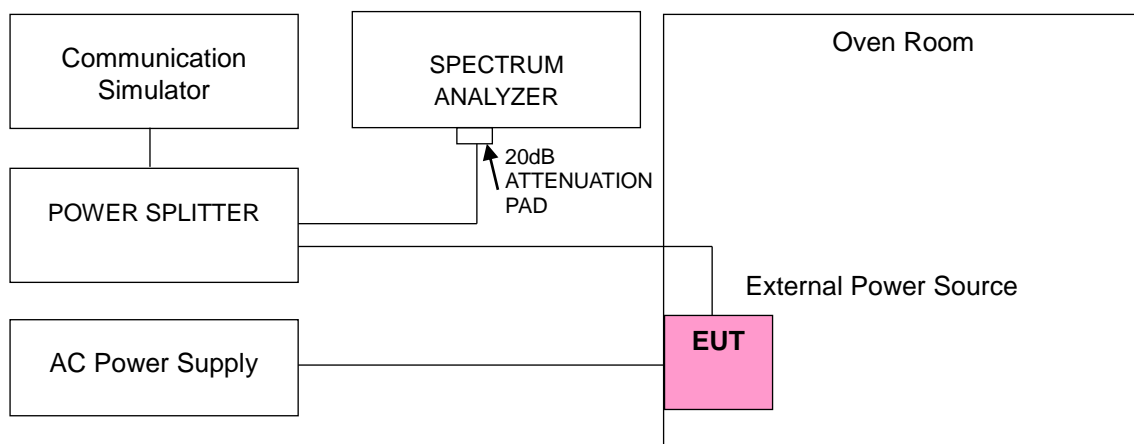

4.3.4 Test Results

Frequency Error vs. Voltage

Voltage (Volts)	LTE Band 4			
	Channel Bandwidth: 1.4 MHz			
	Low Channel		High Channel	
	Frequency (MHz)	Frequency Error (ppm)	Frequency (MHz)	Frequency Error (ppm)
120	1710.700001	0.001	1754.300001	0.001
102	1710.700002	0.001	1754.300003	0.002
138	1710.700004	0.002	1754.300004	0.002

Note: The applicant defined the normal working voltage is from 102 Vac to 138 Vac.

Frequency Error vs. Temperature

Temp. (°C)	LTE Band 4			
	Channel Bandwidth: 1.4 MHz			
	Low Channel		High Channel	
	Frequency (MHz)	Frequency Error (ppm)	Frequency (MHz)	Frequency Error (ppm)
-30	1710.700002	0.001	1754.300004	0.002
-20	1710.700004	0.002	1754.300003	0.002
-10	1710.700003	0.002	1754.300002	0.001
0	1710.700003	0.002	1754.300002	0.001
10	1710.700003	0.002	1754.300002	0.001
20	1710.699997	-0.002	1754.299996	-0.002
30	1710.699999	-0.001	1754.299997	-0.002
40	1710.699999	-0.001	1754.299996	-0.002
50	1710.699997	-0.002	1754.299997	-0.002

Frequency Error vs. Voltage

Voltage (Volts)	LTE Band 4			
	Channel Bandwidth: 3 MHz			
	Low Channel		High Channel	
	Frequency (MHz)	Frequency Error (ppm)	Frequency (MHz)	Frequency Error (ppm)
120	1711.500003	0.001	1753.500003	0.001
102	1711.500002	0.001	1753.500001	0.001
138	1711.500002	0.001	1753.500002	0.001

Note: The applicant defined the normal working voltage is from 102 Vac to 138 Vac.

Frequency Error vs. Temperature

Temp. (°C)	LTE Band 4			
	Channel Bandwidth: 3 MHz			
	Low Channel		High Channel	
	Frequency (MHz)	Frequency Error (ppm)	Frequency (MHz)	Frequency Error (ppm)
-30	1711.500003	0.002	1753.500004	0.002
-20	1711.500004	0.002	1753.500004	0.002
-10	1711.500003	0.001	1753.500003	0.001
0	1711.500002	0.001	1753.500001	0.001
10	1711.500002	0.001	1753.500003	0.002
20	1711.499998	-0.001	1753.499998	-0.001
30	1711.499998	-0.001	1753.499998	-0.001
40	1711.499999	-0.001	1753.499998	-0.001
50	1711.499997	-0.002	1753.499999	-0.001

Frequency Error vs. Voltage

Voltage (Volts)	LTE Band 4			
	Channel Bandwidth: 5 MHz			
	Low Channel		High Channel	
	Frequency (MHz)	Frequency Error (ppm)	Frequency (MHz)	Frequency Error (ppm)
120	1712.500003	0.002	1752.500004	0.002
102	1712.500003	0.002	1752.500001	0.001
138	1712.500004	0.002	1752.500003	0.002

Note: The applicant defined the normal working voltage is from 102 Vac to 138 Vac.

Frequency Error vs. Temperature

Temp. (°C)	LTE Band 4			
	Channel Bandwidth: 5 MHz			
	Low Channel		High Channel	
	Frequency (MHz)	Frequency Error (ppm)	Frequency (MHz)	Frequency Error (ppm)
-30	1712.500003	0.002	1752.500002	0.001
-20	1712.500001	0.001	1752.500001	0.001
-10	1712.500002	0.001	1752.500004	0.002
0	1712.500002	0.001	1752.500004	0.002
10	1712.500002	0.001	1752.500003	0.002
20	1712.499996	-0.002	1752.499996	-0.002
30	1712.499996	-0.002	1752.499999	-0.001
40	1712.499996	-0.002	1752.499996	-0.002
50	1712.499998	-0.001	1752.499998	-0.001

Frequency Error vs. Voltage

Voltage (Volts)	LTE Band 4			
	Channel Bandwidth: 10 MHz			
	Low Channel		High Channel	
	Frequency (MHz)	Frequency Error (ppm)	Frequency (MHz)	Frequency Error (ppm)
120	1715.000001	0.001	1750.000004	0.002
102	1715.000004	0.002	1750.000003	0.002
138	1715.000002	0.001	1750.000003	0.002

Note: The applicant defined the normal working voltage is from 102 Vac to 138 Vac.

Frequency Error vs. Temperature

Temp. (°C)	LTE Band 4			
	Channel Bandwidth: 10 MHz			
	Low Channel		High Channel	
	Frequency (MHz)	Frequency Error (ppm)	Frequency (MHz)	Frequency Error (ppm)
-30	1715.000003	0.002	1750.000003	0.002
-20	1715.000002	0.001	1750.000001	0.001
-10	1715.000004	0.002	1750.000004	0.002
0	1715.000001	0.001	1750.000002	0.001
10	1715.000003	0.002	1750.000002	0.001
20	1714.999999	-0.001	1749.999998	-0.001
30	1714.999999	-0.001	1749.999998	-0.001
40	1714.999999	-0.001	1749.999997	-0.002
50	1714.999998	-0.001	1749.999997	-0.002

Frequency Error vs. Voltage

Voltage (Volts)	LTE Band 4			
	Channel Bandwidth: 15 MHz			
	Low Channel		High Channel	
	Frequency (MHz)	Frequency Error (ppm)	Frequency (MHz)	Frequency Error (ppm)
120	1717.500003	0.002	1747.500004	0.002
102	1717.500003	0.002	1747.500003	0.002
138	1717.500003	0.002	1747.500001	0.001

Note: The applicant defined the normal working voltage is from 102 Vac to 138 Vac.

Frequency Error vs. Temperature

Temp. (°C)	LTE Band 4			
	Channel Bandwidth: 15 MHz			
	Low Channel		High Channel	
	Frequency (MHz)	Frequency Error (ppm)	Frequency (MHz)	Frequency Error (ppm)
-30	1717.500002	0.001	1747.500002	0.001
-20	1717.500003	0.002	1747.500004	0.002
-10	1717.500002	0.001	1747.500001	0.001
0	1717.500004	0.002	1747.500003	0.001
10	1717.500002	0.001	1747.500002	0.001
20	1717.499997	-0.002	1747.499999	-0.001
30	1717.499997	-0.002	1747.499997	-0.002
40	1717.499997	-0.002	1747.499999	-0.001
50	1717.499997	-0.002	1747.499999	-0.001

Frequency Error vs. Voltage

Voltage (Volts)	LTE Band 4			
	Channel Bandwidth: 20 MHz			
	Low Channel		High Channel	
	Frequency (MHz)	Frequency Error (ppm)	Frequency (MHz)	Frequency Error (ppm)
120	1720.000001	0.001	1745.000002	0.001
102	1720.000003	0.002	1745.000003	0.002
138	1720.000002	0.001	1745.000002	0.001

Note: The applicant defined the normal working voltage is from 102 Vac to 138 Vac.

Frequency Error vs. Temperature

Temp. (°C)	LTE Band 4			
	Channel Bandwidth: 20 MHz			
	Low Channel		High Channel	
	Frequency (MHz)	Frequency Error (ppm)	Frequency (MHz)	Frequency Error (ppm)
-30	1720.000003	0.002	1745.000004	0.002
-20	1720.000002	0.001	1745.000002	0.001
-10	1720.000004	0.002	1745.000002	0.001
0	1720.000002	0.001	1745.000004	0.002
10	1720.000004	0.002	1745.000001	0.001
20	1719.999999	-0.001	1744.999999	-0.001
30	1719.999997	-0.002	1744.999999	-0.001
40	1719.999998	-0.001	1744.999999	-0.001
50	1719.999998	-0.001	1744.999997	-0.002

Frequency Error vs. Voltage

Voltage (Volts)	LTE Band 12			
	Channel Bandwidth: 1.4 MHz			
	Low Channel		High Channel	
	Frequency (MHz)	Frequency Error (ppm)	Frequency (MHz)	Frequency Error (ppm)
120	699.700001	0.001	715.300003	0.004
102	699.700003	0.004	715.300002	0.003
138	699.700001	0.002	715.300001	0.002

Note: The applicant defined the normal working voltage is from 102 Vac to 138 Vac.

Frequency Error vs. Temperature

Temp. (°C)	LTE Band 12			
	Channel Bandwidth: 1.4 MHz			
	Low Channel		High Channel	
	Frequency (MHz)	Frequency Error (ppm)	Frequency (MHz)	Frequency Error (ppm)
-30	699.700002	0.002	715.300001	0.002
-20	699.700002	0.002	715.300002	0.003
-10	699.700001	0.002	715.300003	0.004
0	699.700002	0.002	715.300003	0.004
10	699.700001	0.002	715.300002	0.002
20	699.699997	-0.004	715.299997	-0.004
30	699.699997	-0.005	715.299997	-0.004
40	699.699999	-0.002	715.299999	-0.002
50	699.699999	-0.002	715.299999	-0.002

Frequency Error vs. Voltage

Voltage (Volts)	LTE Band 12			
	Channel Bandwidth: 3 MHz			
	Low Channel		High Channel	
	Frequency (MHz)	Frequency Error (ppm)	Frequency (MHz)	Frequency Error (ppm)
120	700.500003	0.004	714.500002	0.003
102	700.500002	0.003	714.500003	0.004
138	700.500001	0.002	714.500002	0.002

Note: The applicant defined the normal working voltage is from 102 Vac to 138 Vac.

Frequency Error vs. Temperature

Temp. (°C)	LTE Band 12			
	Channel Bandwidth: 3 MHz			
	Low Channel		High Channel	
	Frequency (MHz)	Frequency Error (ppm)	Frequency (MHz)	Frequency Error (ppm)
-30	700.500003	0.005	714.500004	0.005
-20	700.500001	0.002	714.500004	0.005
-10	700.500002	0.003	714.500003	0.004
0	700.500001	0.002	714.500002	0.003
10	700.500001	0.001	714.500001	0.002
20	700.499997	-0.004	714.499998	-0.003
30	700.499999	-0.002	714.499999	-0.002
40	700.499997	-0.004	714.499999	-0.002
50	700.499996	-0.005	714.499996	-0.005

Frequency Error vs. Voltage

Voltage (Volts)	LTE Band 12			
	Channel Bandwidth: 5 MHz			
	Low Channel		High Channel	
	Frequency (MHz)	Frequency Error (ppm)	Frequency (MHz)	Frequency Error (ppm)
120	701.500004	0.006	713.500003	0.004
102	701.500002	0.002	713.500001	0.002
138	701.500001	0.002	713.500003	0.004

Note: The applicant defined the normal working voltage is from 102 Vac to 138 Vac.

Frequency Error vs. Temperature

Temp. (°C)	LTE Band 12			
	Channel Bandwidth: 5 MHz			
	Low Channel		High Channel	
	Frequency (MHz)	Frequency Error (ppm)	Frequency (MHz)	Frequency Error (ppm)
-30	701.500001	0.002	713.500002	0.003
-20	701.500001	0.002	713.500003	0.004
-10	701.500001	0.002	713.500003	0.004
0	701.500004	0.006	713.500002	0.003
10	701.500004	0.006	713.500003	0.005
20	701.499997	-0.004	713.499996	-0.006
30	701.499999	-0.002	713.499999	-0.002
40	701.499998	-0.003	713.499998	-0.004
50	701.499998	-0.003	713.499998	-0.003

Frequency Error vs. Voltage

Voltage (Volts)	LTE Band 12			
	Channel Bandwidth: 10 MHz			
	Low Channel		High Channel	
	Frequency (MHz)	Frequency Error (ppm)	Frequency (MHz)	Frequency Error (ppm)
120	704.000004	0.005	711.000002	0.003
102	704.000002	0.003	711.000001	0.001
138	704.000002	0.002	711.000003	0.004

Note: The applicant defined the normal working voltage is from 102 Vac to 138 Vac.

Frequency Error vs. Temperature

Temp. (°C)	LTE Band 12			
	Channel Bandwidth: 10 MHz			
	Low Channel		High Channel	
	Frequency (MHz)	Frequency Error (ppm)	Frequency (MHz)	Frequency Error (ppm)
-30	704.000002	0.003	711.000004	0.005
-20	704.000003	0.004	711.000004	0.005
-10	704.000002	0.002	711.000004	0.005
0	704.000001	0.002	711.000002	0.003
10	704.000002	0.003	711.000004	0.005
20	703.999998	-0.003	710.999999	-0.002
30	703.999997	-0.004	710.999997	-0.005
40	703.999999	-0.002	710.999997	-0.005
50	703.999998	-0.002	710.999996	-0.005

4.4 Occupied Bandwidth Measurement

4.4.1 Limits of Occupied Bandwidth Measurement

The width of a frequency band such that, below the lower and above the upper frequency limits, the mean powers emitted are each equal to a specified percentage 0.5 % of the total mean power of a given emission.

4.4.2 Test Procedure

- The conducted occupied bandwidth used the power splitter via EUT RF power connector between simulation base station and spectrum analyzer.
- Use OBW measurement function of Spectrum analyzer to measure 99 % occupied bandwidth.

4.4.3 Test Setup

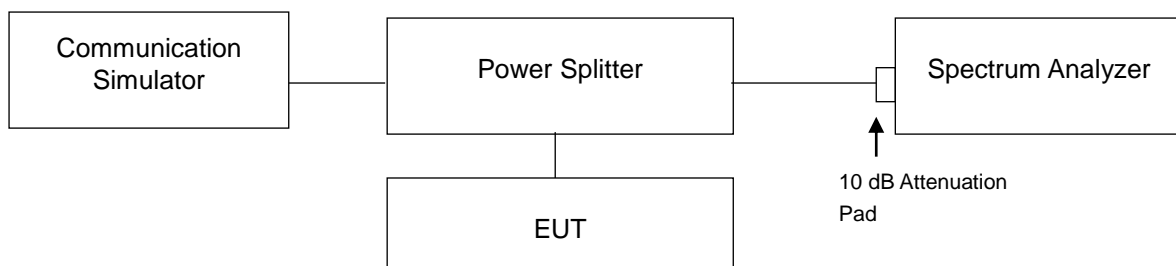

4.4.4 Test Result

LTE Band 4					
Channel Bandwidth: 1.4 MHz					
Channel	Frequency (MHz)	99 % Occupied Bandwidth (MHz)		26 dB Bandwidth (MHz)	
		QPSK	16QAM	QPSK	16QAM
19957	1710.7	1.0925	1.0900	1.261	1.256
20175	1732.5	1.0911	1.0899	1.259	1.277
20393	1754.3	1.0894	1.0900	1.248	1.237

Channel Bandwidth: 3 MHz					
Channel	Frequency (MHz)	99 % Occupied Bandwidth (MHz)		26 dB Bandwidth (MHz)	
		QPSK	16QAM	QPSK	16QAM
19965	1711.5	2.7001	2.6965	2.922	2.931
20175	1732.5	2.6994	2.6961	2.916	2.932
20385	1753.5	2.6993	2.6977	2.913	2.931



LTE Band 4					
Channel Bandwidth: 5 MHz					
Channel	Frequency (MHz)	99 % Occupied Bandwidth (MHz)		26 dB Bandwidth (MHz)	
		QPSK	16QAM	QPSK	16QAM
19975	1712.5	4.4885	4.4926	4.811	4.820
20175	1732.5	4.4892	4.4893	4.818	4.806
20375	1752.5	4.4888	4.4921	4.828	4.812

Channel Bandwidth: 10 MHz			
Channel	Frequency (MHz)	99 % Occupied Bandwidth (MHz)	26 dB Bandwidth (MHz)
		QPSK	QPSK
20000	1715.0	8.9500	9.507
20175	1732.5	8.9369	9.486
20350	1750.0	8.9597	9.522



LTE Band 4			
Channel Bandwidth: 15 MHz			
Channel	Frequency (MHz)	99 % Occupied Bandwidth (MHz)	26 dB Bandwidth (MHz)
		QPSK	QPSK
20025	1717.5	13.438	14.23
20175	1732.5	13.385	14.20
20325	1747.5	13.458	14.26
Channel Bandwidth: 20 MHz			
Channel	Frequency (MHz)	99 % Occupied Bandwidth (MHz)	26 dB Bandwidth (MHz)
		QPSK	QPSK
20050	1720.0	17.908	19.00
20175	1732.5	17.797	18.96
20300	1745.0	17.965	19.03



LTE Band 12					
Channel Bandwidth: 1.4 MHz					
Channel	Frequency (MHz)	99 % Occupied Bandwidth (MHz)		26 dB Bandwidth (MHz)	
		QPSK	16QAM	QPSK	16QAM
23017	699.7	1.0886	1.0883	1.249	1.244
23095	707.5	1.0889	1.0884	1.253	1.253
23173	715.3	1.0887	1.0902	1.247	1.248
Channel Bandwidth: 3 MHz					
Channel	Frequency (MHz)	99 % Occupied Bandwidth (MHz)		26 dB Bandwidth (MHz)	
		QPSK	16QAM	QPSK	16QAM
23025	700.5	2.6986	2.6934	2.906	2.909
23095	707.5	2.7007	2.6966	2.904	2.910
23165	714.5	2.7010	2.6993	2.909	2.925

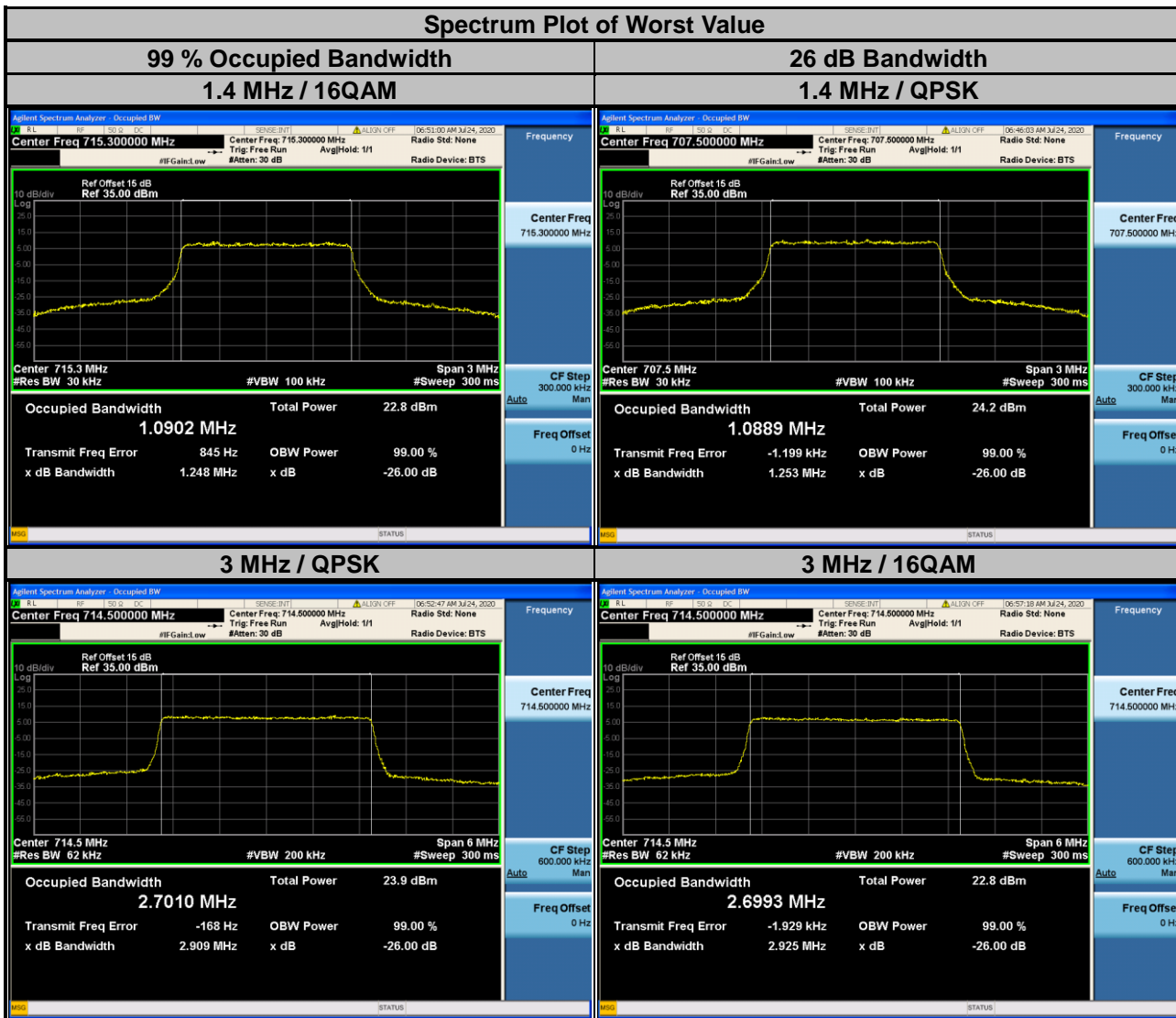

LTE Band 12					
Channel Bandwidth: 5 MHz					
Channel	Frequency (MHz)	99 % Occupied Bandwidth (MHz)		26 dB Bandwidth (MHz)	
		QPSK	16QAM	QPSK	16QAM
23035	701.5	4.4867	4.4868	4.826	4.802
23095	707.5	4.4873	4.4898	4.807	4.800
23155	713.5	4.4887	4.4913	4.814	4.805

Channel Bandwidth: 10 MHz					
Channel	Frequency (MHz)	99 % Occupied Bandwidth (MHz)		26 dB Bandwidth (MHz)	
		QPSK		QPSK	
23060	704.0	8.9764		9.538	
23095	707.5	8.9476		9.500	
23130	711.0	8.9213		9.467	



4.5 Band Edge Measurement

4.5.1 Limits of Band Edge Measurement

For operations in the 698-746 MHz band, the power of any emission outside a licensee's frequency band(s) of operation shall be attenuated below the transmitter power (P) within the licensed band(s) of operation, measured in watts, by at least $43 + 10 \log (P)$ dB. Compliance with this provision is based on the use of measurement instrumentation employing a resolution bandwidth of 100 kilohertz or greater.

However, in the 100 kilohertz bands immediately outside and adjacent to a licensee's frequency block, a resolution bandwidth of at least 30 kHz may be employed.

For operations in the 1710–1755 MHz bands, the power of any emission outside a licensee's frequency block shall be attenuated below the transmitter power (P) by at least $43 + 10 \log (P)$ dB.

4.5.2 Test Setup

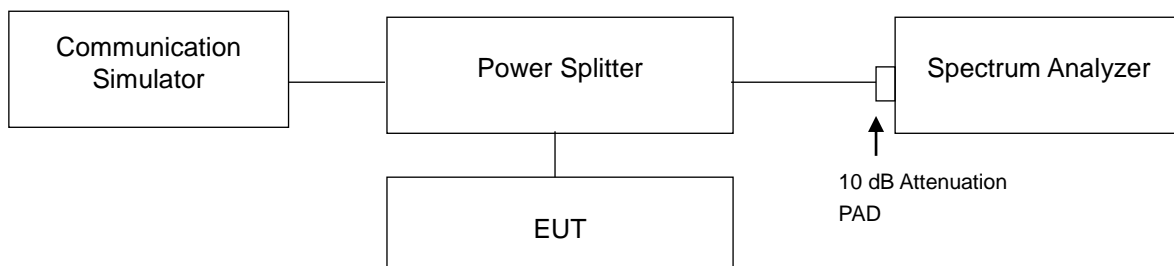

4.5.3 Test Procedures

- a. All measurements were done at low and high operational frequency range.
- b. The center frequency of spectrum is the band edge frequency and span is 1 MHz. RB of the spectrum is 15 kHz and VB of the spectrum is 51 kHz (LTE Bandwidth 1.4 MHz).
- c. The center frequency of spectrum is the band edge frequency and span is 1 MHz. RB of the spectrum is 30 kHz and VB of the spectrum is 100 kHz (LTE Bandwidth 3 MHz).
- d. The center frequency of spectrum is the band edge frequency and span is 1 MHz. RB of the spectrum is 51 kHz and VB of the spectrum is 160 kHz (LTE Bandwidth 5 MHz).
- e. The center frequency of spectrum is the band edge frequency and span is 1 MHz. RB of the spectrum is 100 kHz and VB of the spectrum is 300 kHz (LTE Bandwidth 10 MHz).
- f. The center frequency of spectrum is the band edge frequency and span is 1 MHz. RB of the spectrum is 150 kHz and VB of the spectrum is 470 kHz (LTE Bandwidth 15 MHz).
- g. The center frequency of spectrum is the band edge frequency and span is 1 MHz. RB of the spectrum is 200 kHz and VB of the spectrum is 1 MHz (LTE Bandwidth 20 MHz).
- h. Record the max. trace plot into the test report.

4.5.4 Test Results

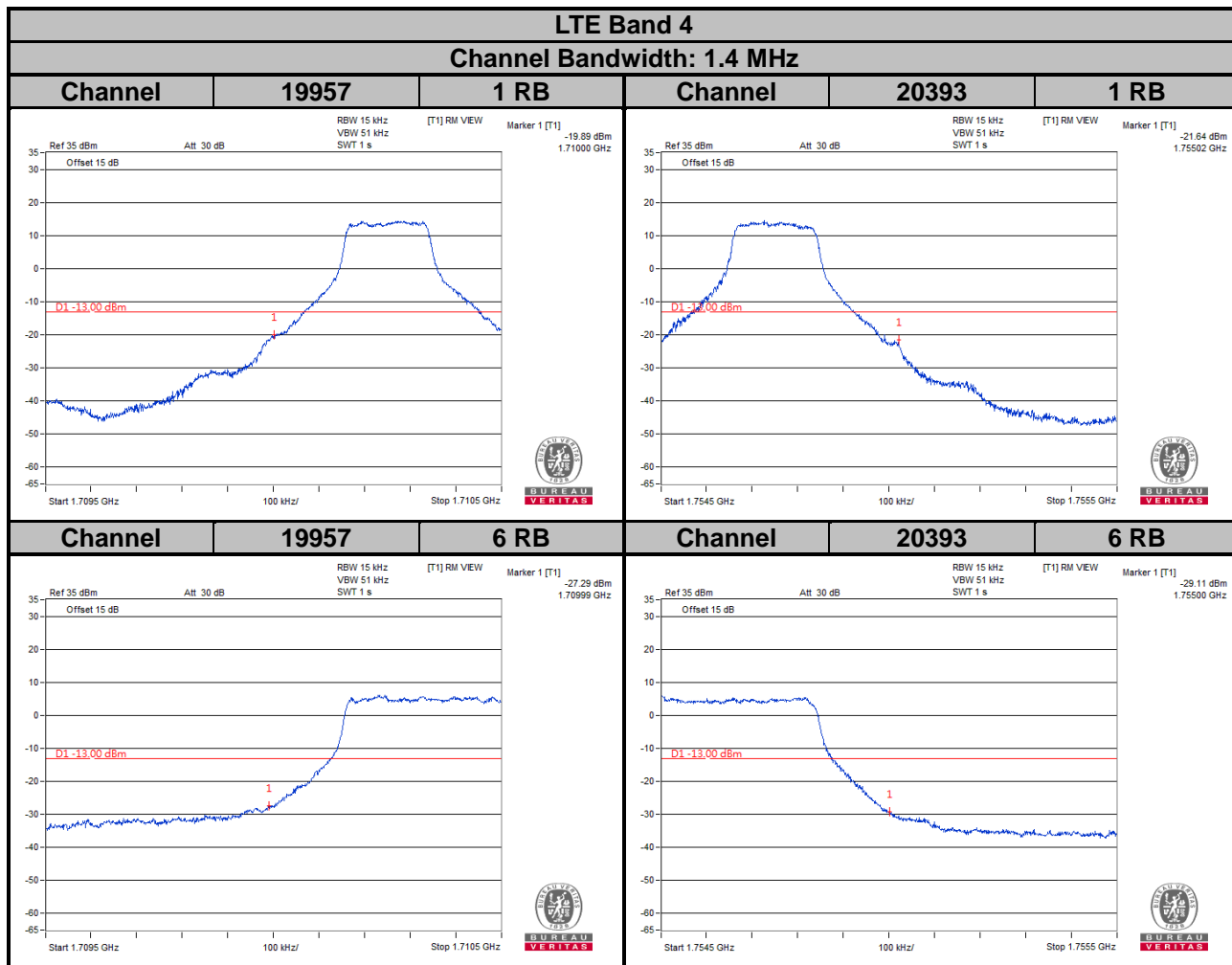

LTE Band 4

Channel Bandwidth: 3 MHz

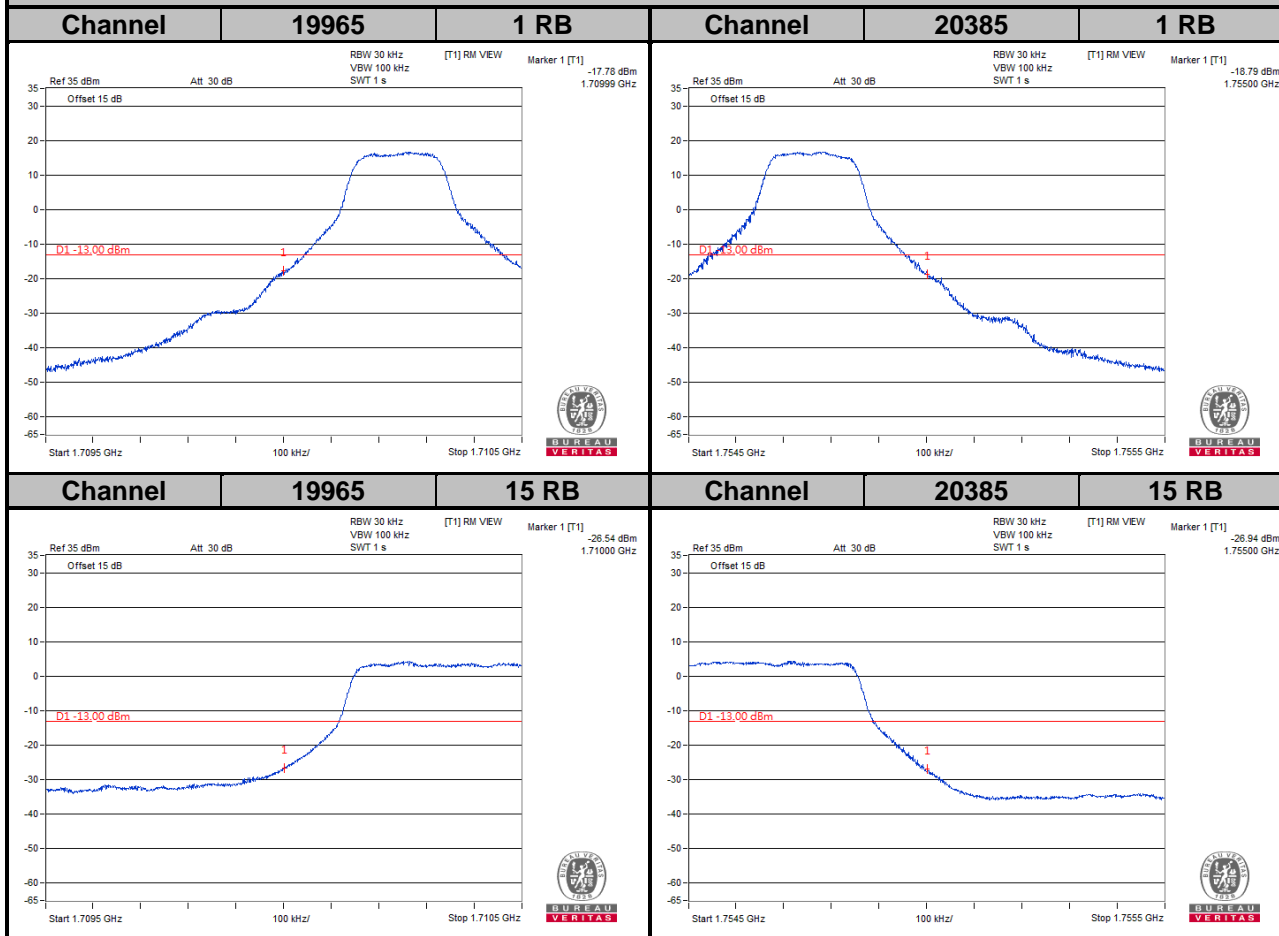

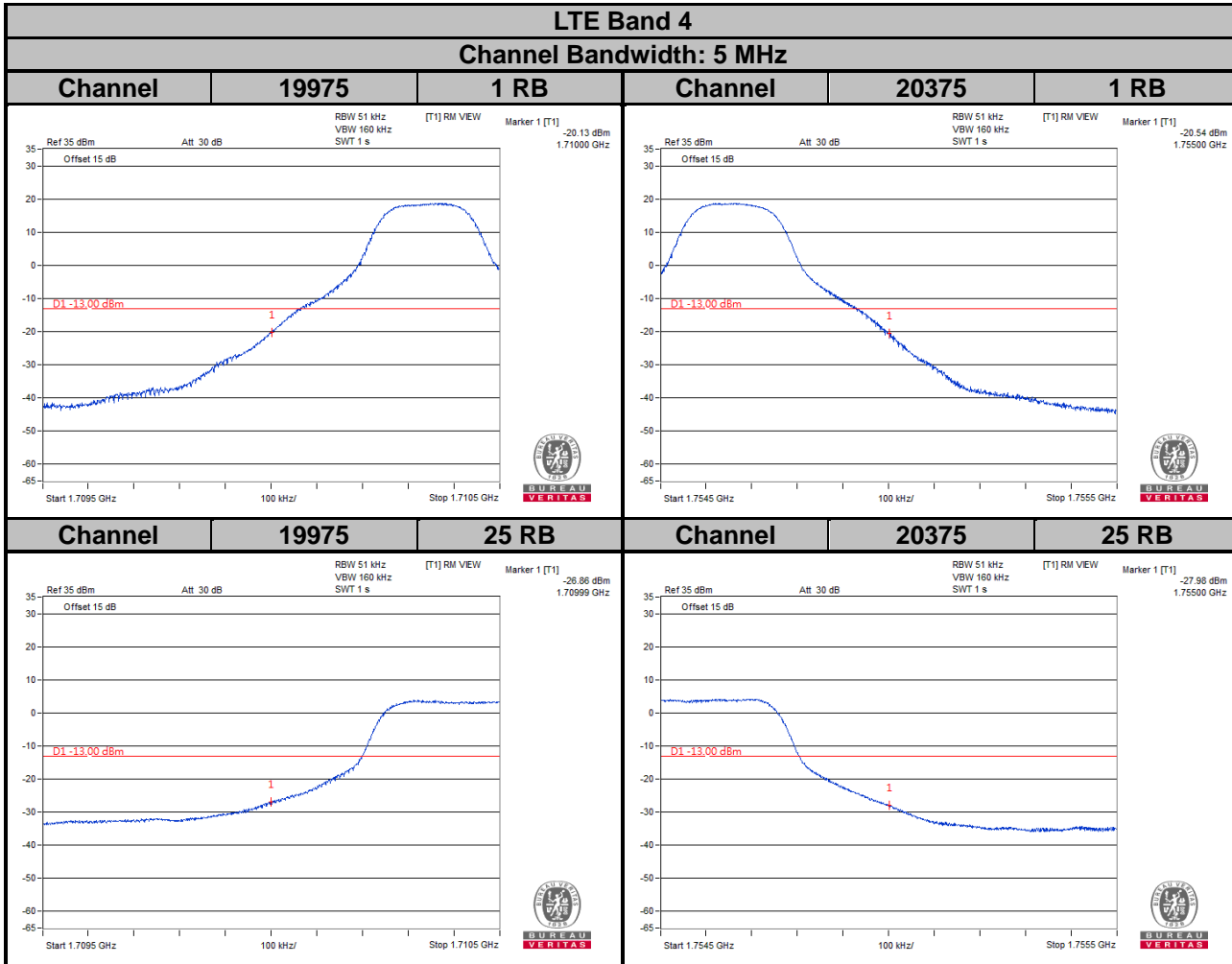

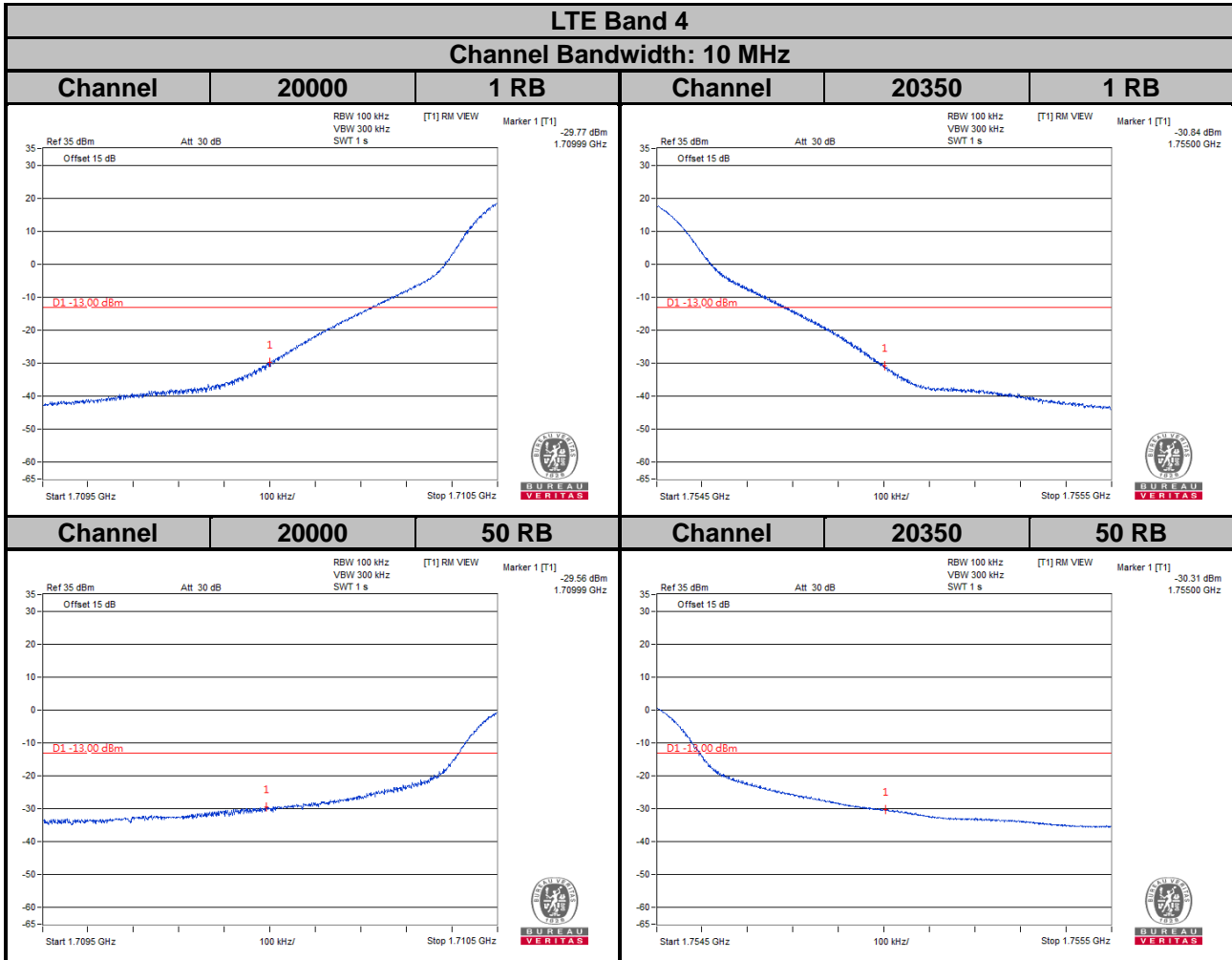

LTE Band 4
Channel Bandwidth: 15 MHz

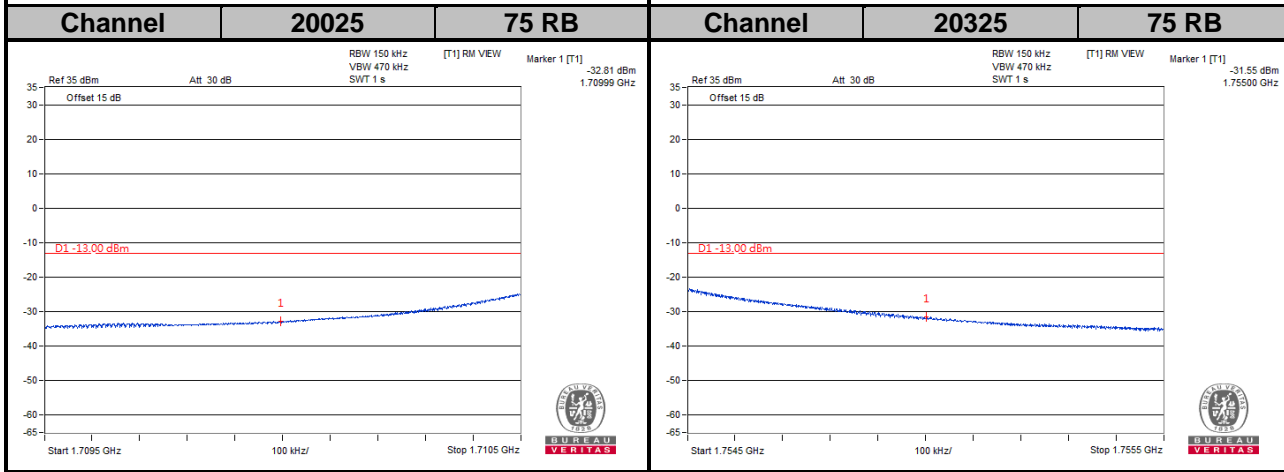
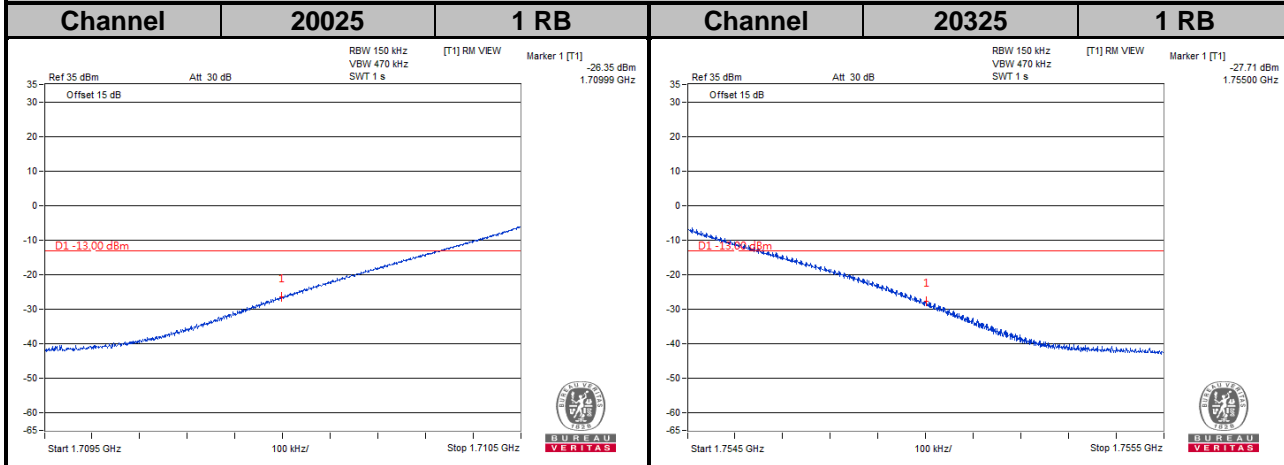

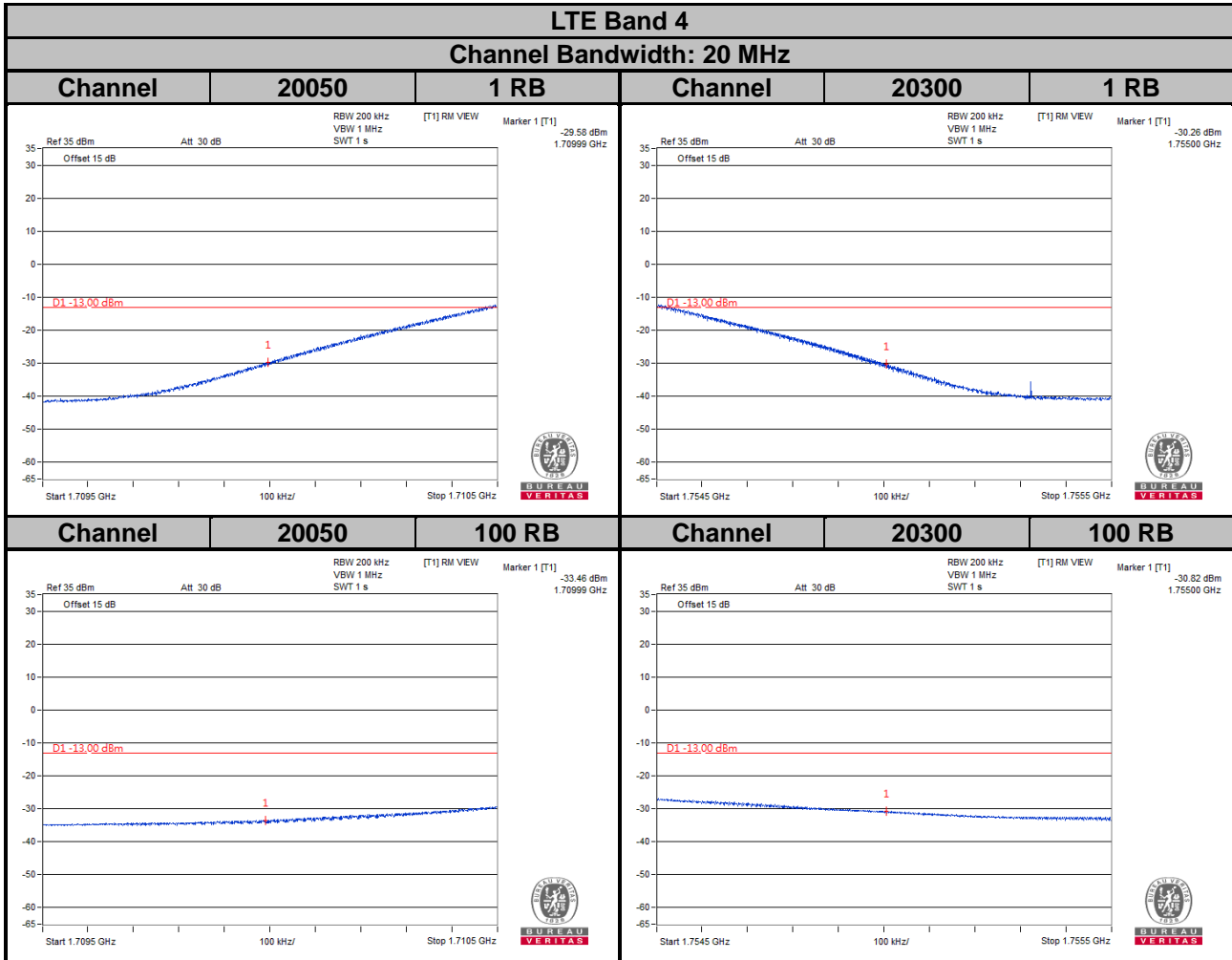

LTE Band 12
Channel Bandwidth: 1.4 MHz

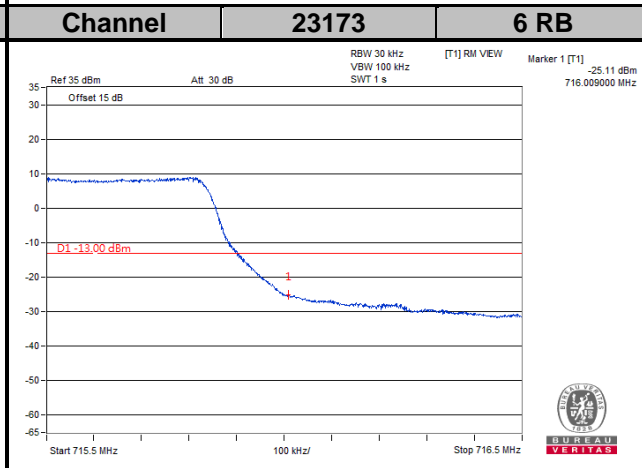
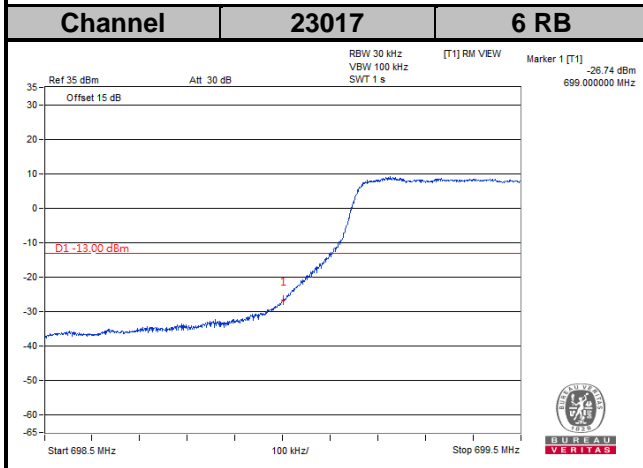
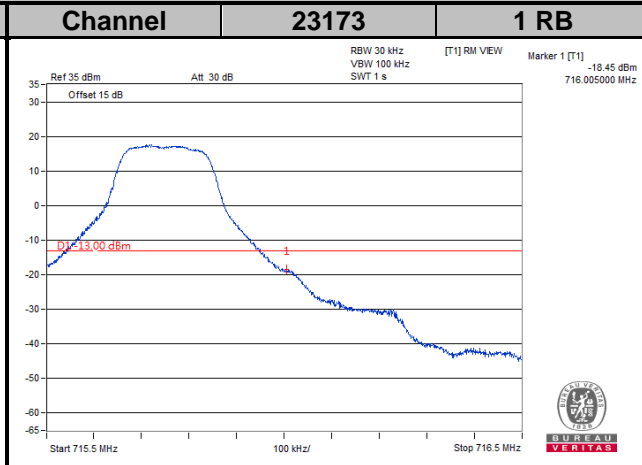
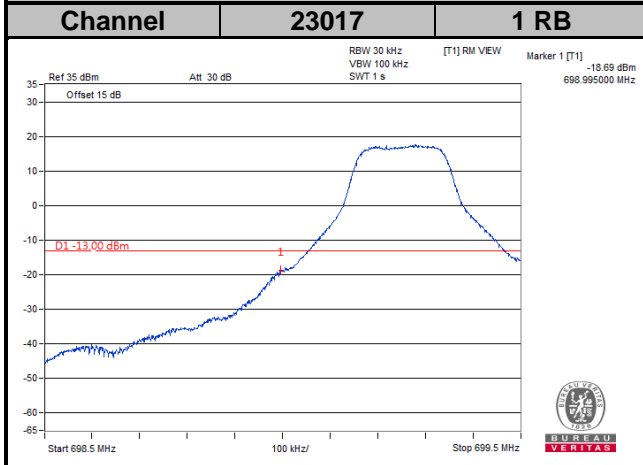

LTE Band 12
Channel Bandwidth: 3 MHz

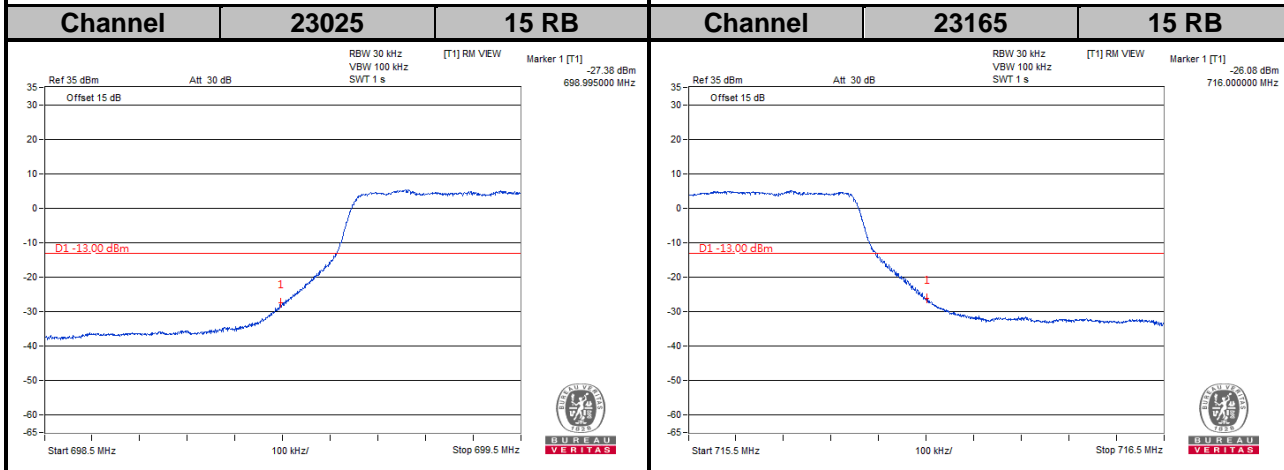
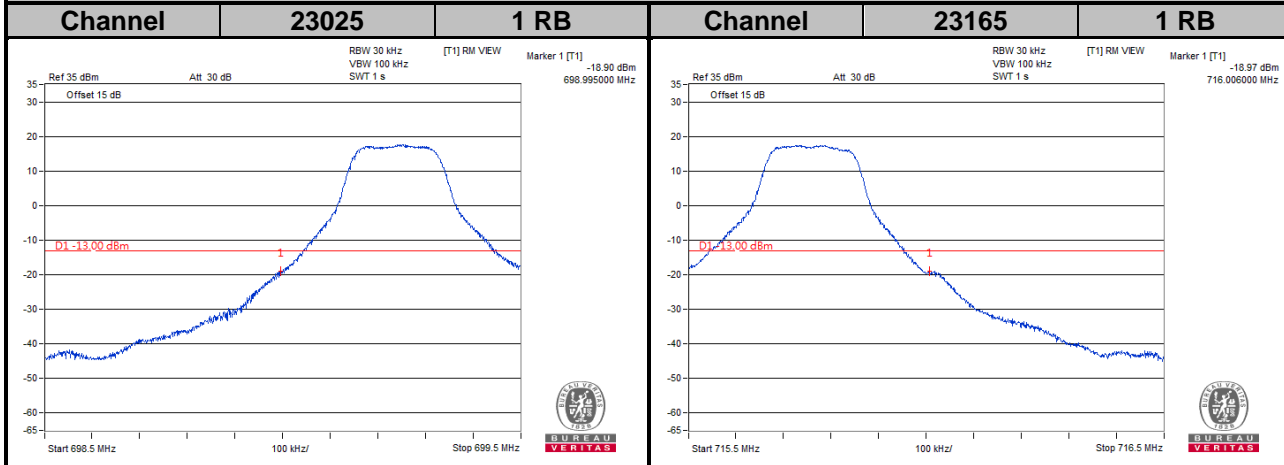

LTE Band 12

Channel Bandwidth: 5 MHz

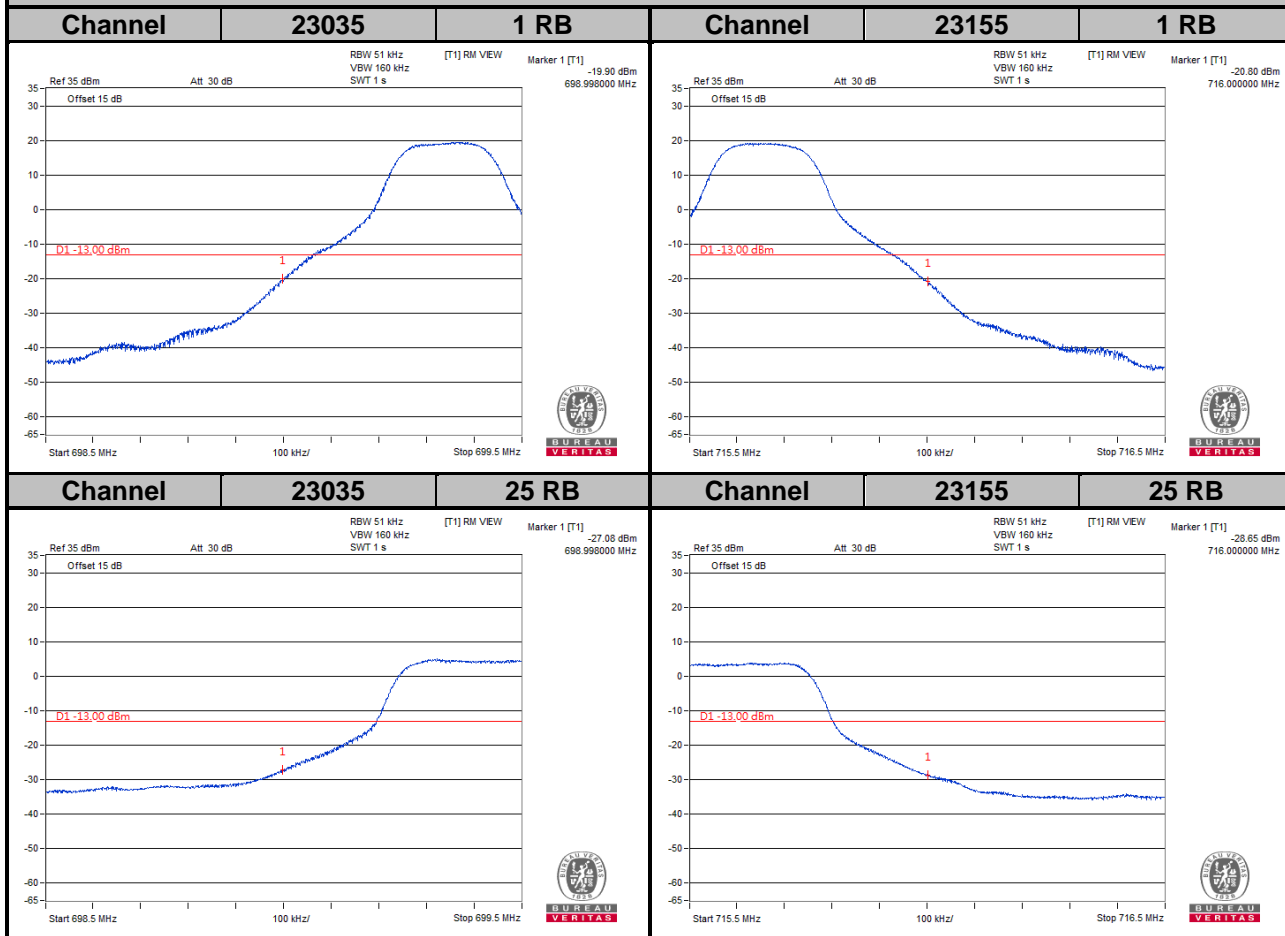

LTE Band 12
Channel Bandwidth: 10 MHz

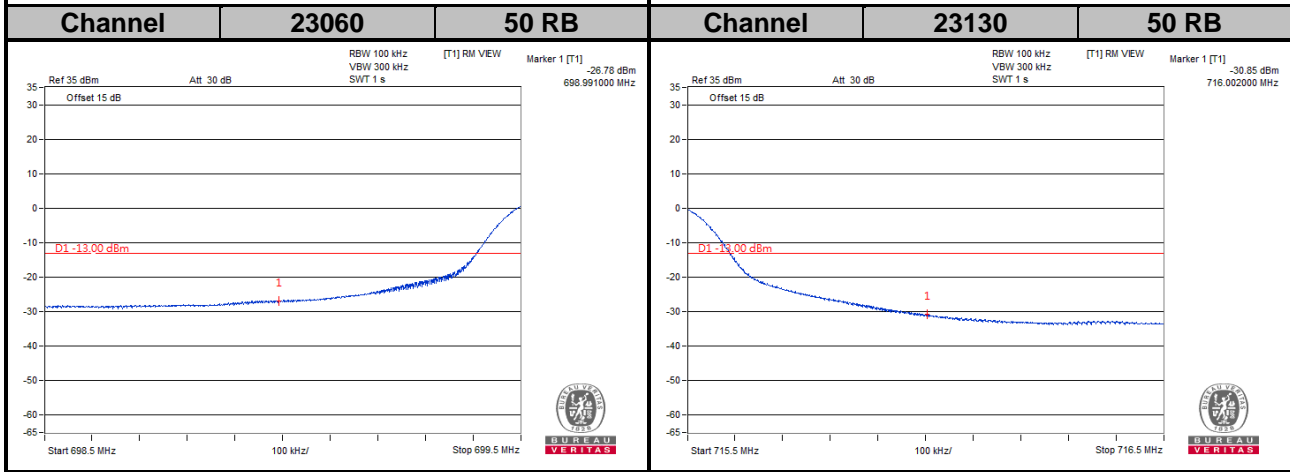
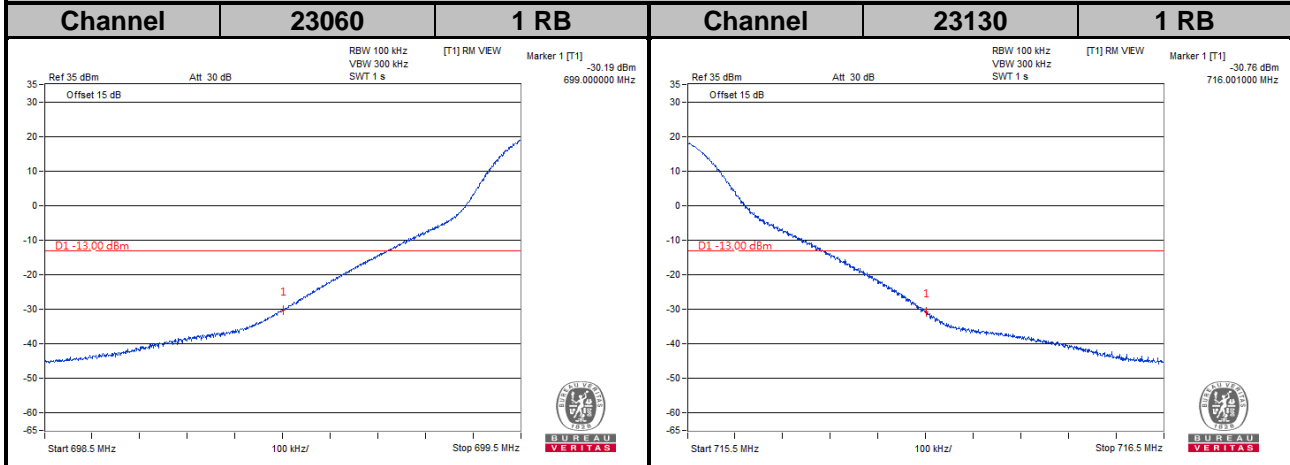

4.6 Peak to Average Ratio

4.6.1 Limits of Peak to Average Ratio Measurement

In measuring transmissions in this band using an average power technique, the peak to-average ratio (PAR) of the transmission may not exceed 13 dB.

4.6.2 Test Setup

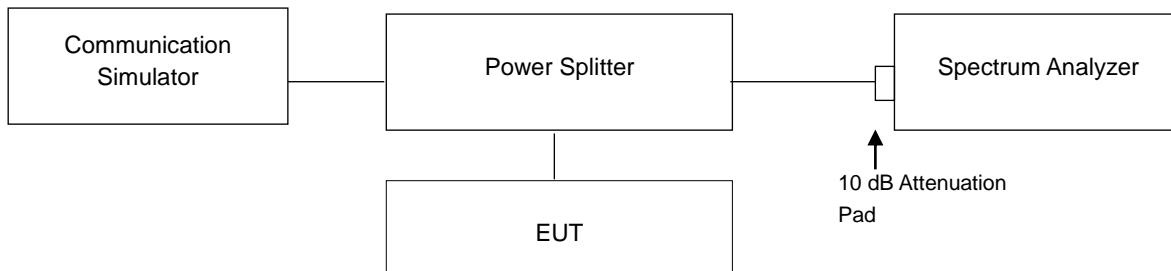

4.6.3 Test Procedures

1. Set resolution/measurement bandwidth \geq signal's occupied bandwidth;
2. Set the number of counts to a value that stabilizes the measured CCDF curve;
3. Record the maximum PAPR level associated with a probability of 0.1 %.

4.6.4 Test Results

LTE Band 4							
Channel Bandwidth: 1.4 MHz				Channel Bandwidth: 3 MHz			
Channel	Frequency (MHz)	Peak to Average Ratio (dB)		Channel	Frequency (MHz)	Peak to Average Ratio (dB)	
		QPSK	16QAM			QPSK	16QAM
19957	1710.7	3.25	4.25	19965	1711.5	3.36	4.29
20175	1732.5	3.81	4.60	20175	1732.5	3.83	4.89
20393	1754.3	4.07	5.01	20385	1753.5	4.13	5.05

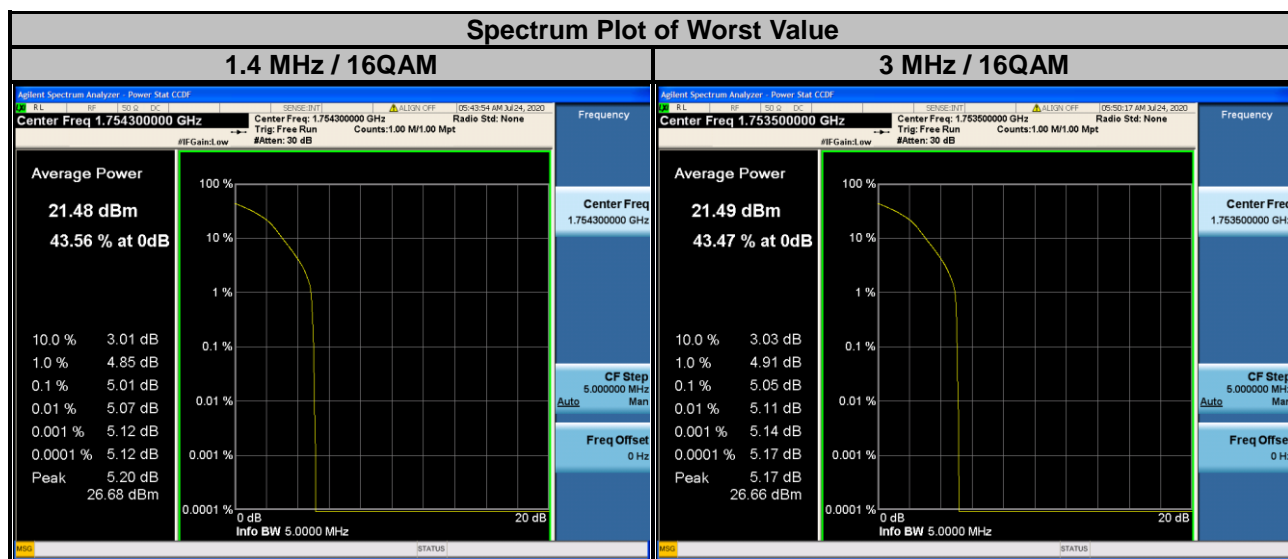

LTE Band 4						
Channel Bandwidth: 5 MHz				Channel Bandwidth: 10 MHz		
Channel	Frequency (MHz)	Peak to Average Ratio (dB)		Channel	Frequency (MHz)	Peak to Average Ratio (dB)
		QPSK	16QAM			QPSK
19975	1712.5	3.40	4.39	20000	1715.0	3.28
20175	1732.5	3.86	4.88	20175	1732.5	4.22
20375	1752.5	3.93	4.67	20350	1750.0	3.55

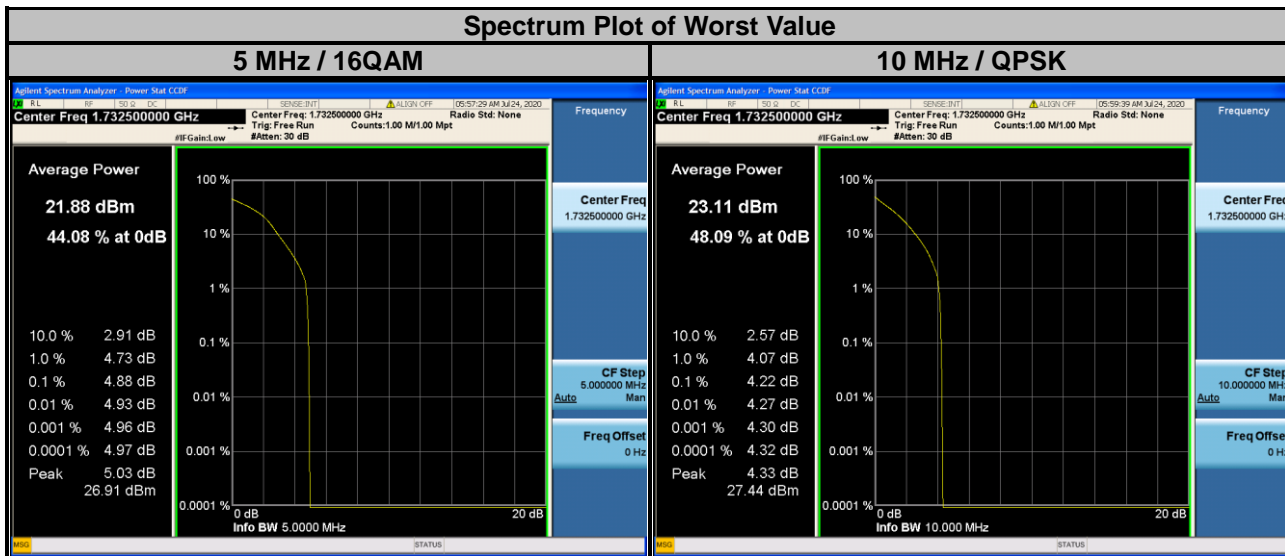

LTE Band 4					
Channel Bandwidth: 15 MHz			Channel Bandwidth: 20 MHz		
Channel	Frequency (MHz)	Peak to Average Ratio (dB)	Channel	Frequency (MHz)	Peak to Average Ratio (dB)
		QPSK			QPSK
20025	1717.5	3.36	20050	1720.0	3.29
20175	1732.5	4.36	20175	1732.5	4.34
20325	1747.5	3.24	20300	1745.0	3.25

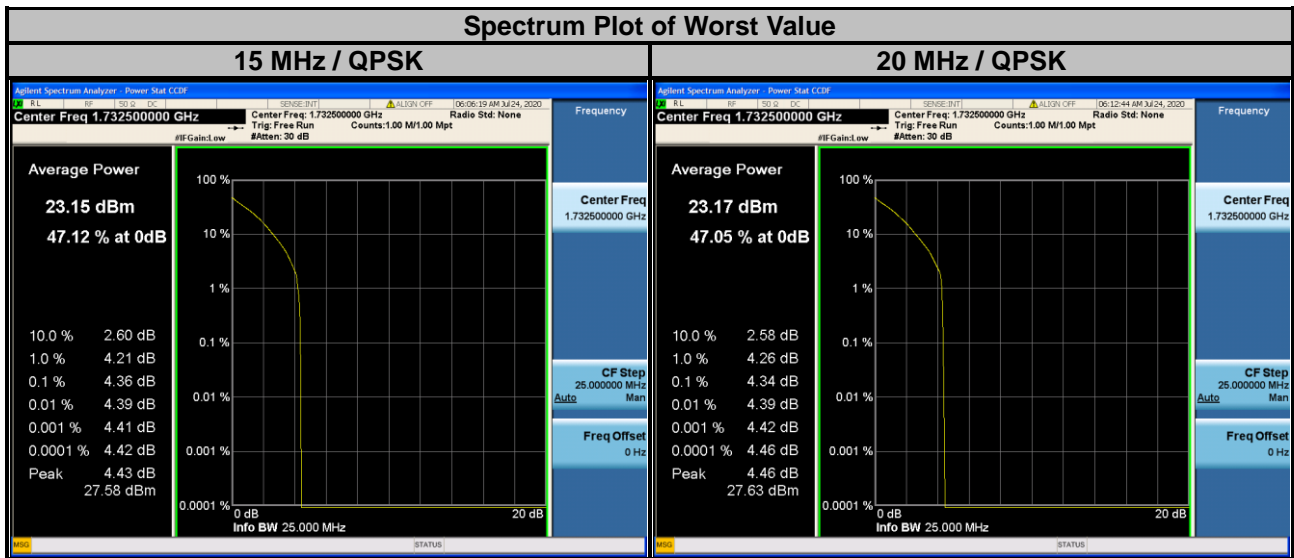

LTE Band 12							
Channel Bandwidth: 1.4 MHz				Channel Bandwidth: 3 MHz			
Channel	Frequency (MHz)	Peak to Average Ratio (dB)		Channel	Frequency (MHz)	Peak to Average Ratio (dB)	
		QPSK	16QAM			QPSK	16QAM
23017	699.7	4.23	5.14	23025	700.5	4.23	4.98
23095	707.5	4.81	5.68	23095	707.5	4.82	5.67
23173	715.3	4.34	5.29	23165	714.5	4.01	4.98

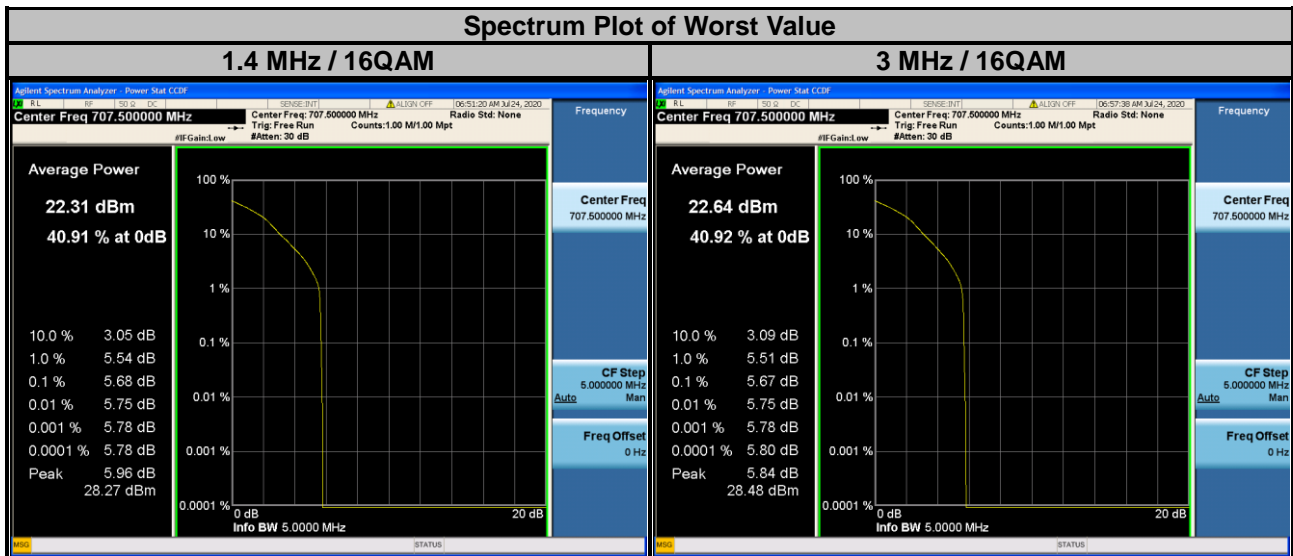

LTE Band 12						
Channel Bandwidth: 5 MHz				Channel Bandwidth: 10 MHz		
Channel	Frequency (MHz)	Peak to Average Ratio (dB)		Channel	Frequency (MHz)	Peak to Average Ratio (dB)
		QPSK	16QAM			QPSK
23035	701.5	4.16	5.15	23060	704.0	4.18
23095	707.5	4.74	5.66	23095	707.5	4.56
23155	713.5	4.02	4.93	23130	711.0	4.77

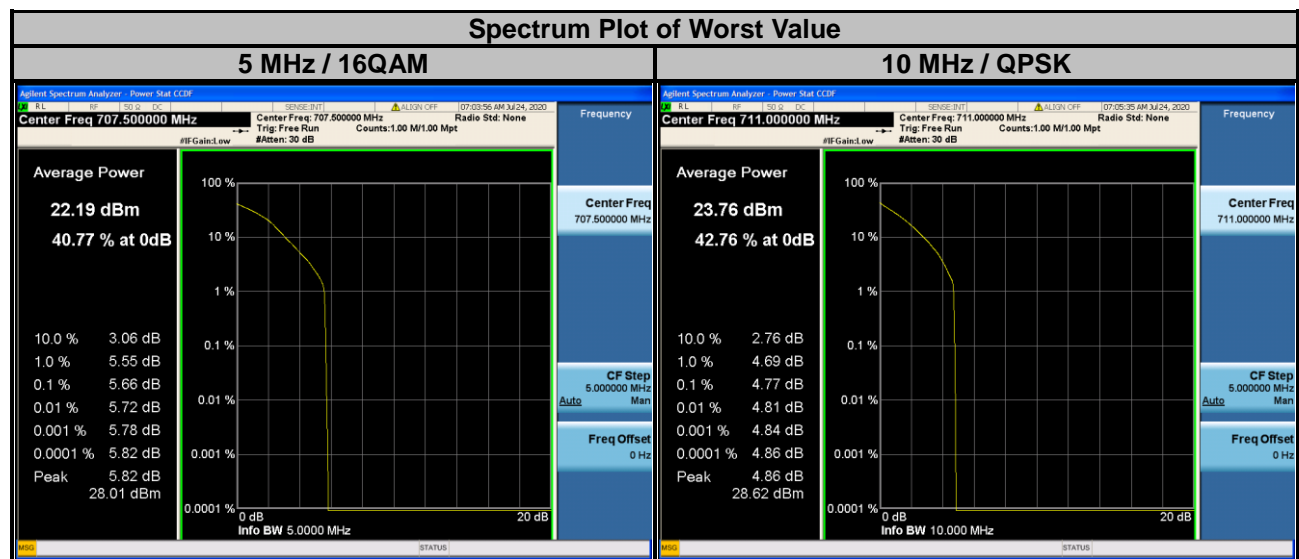

4.7 Conducted Spurious Emissions

4.7.1 Limits of Conducted Spurious Emissions Measurement

The power of any emission outside a licensee's frequency block shall be attenuated below the transmitter power (P) by at least $43 + 10 \log (P)$ dB. The limit of emission is equal to -13 dBm.

4.7.2 Test Setup

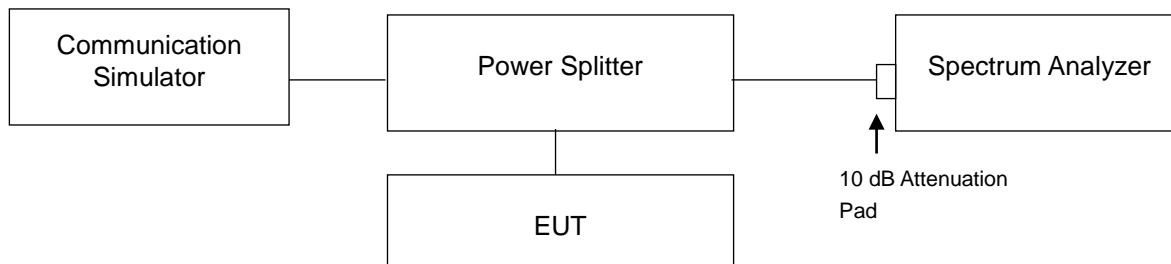

4.7.3 Test Procedure

- The EUT makes a phone call to the communication simulator. All measurements were done at low, middle and high operational frequency range.
- Measuring frequency range is from 9 kHz to 1 GHz. 10 dB attenuation pad is connected with spectrum. RBW = 1 MHz, VBW = 3 MHz for LTE Band 4 and RBW = 100 kHz, VBW = 300 kHz for LTE Band 12, are used for conducted emission measurement.
- Measuring frequency range is from 1 GHz to 8 GHz / 18 GHz. 10 dB attenuation pad is connected with spectrum. RBW = 1 MHz and VBW = 3 MHz is used for conducted emission measurement.

4.7.4 Test Results

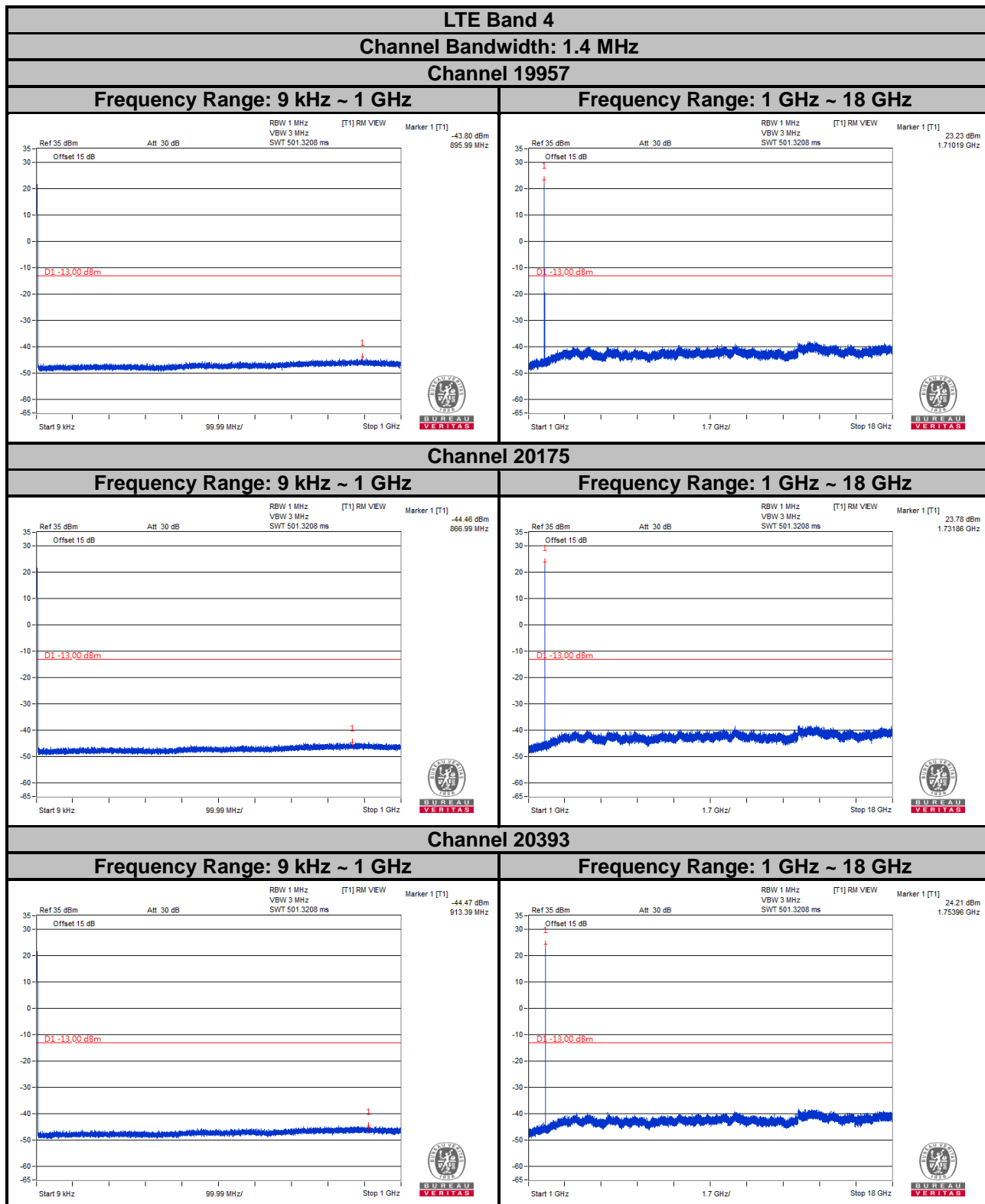

Note: The signal over the limit in 9 kHz is from spectrum analyzer.

LTE Band 4
Channel Bandwidth: 3 MHz
Channel 19965

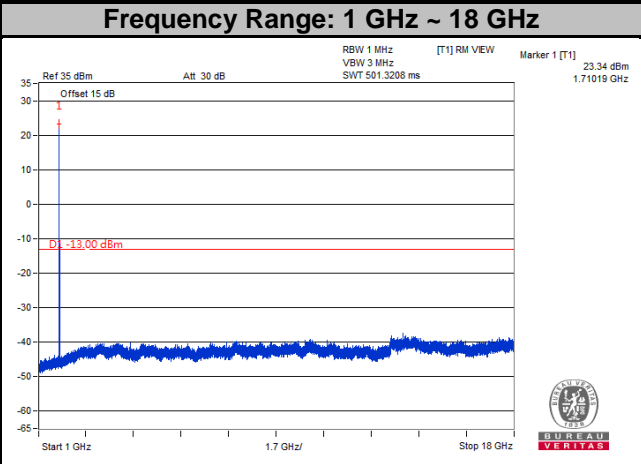
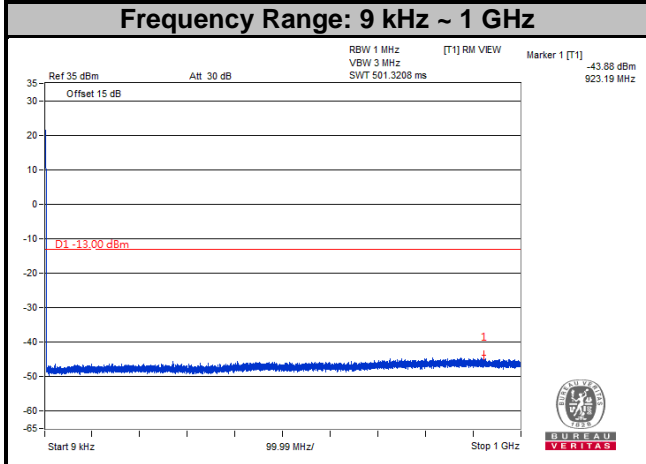

Channel 20175

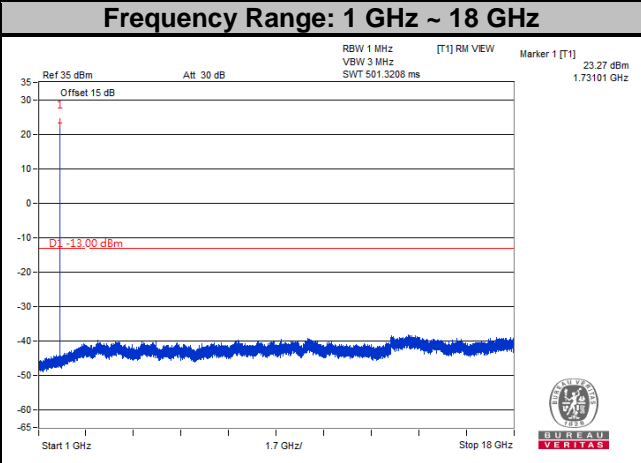
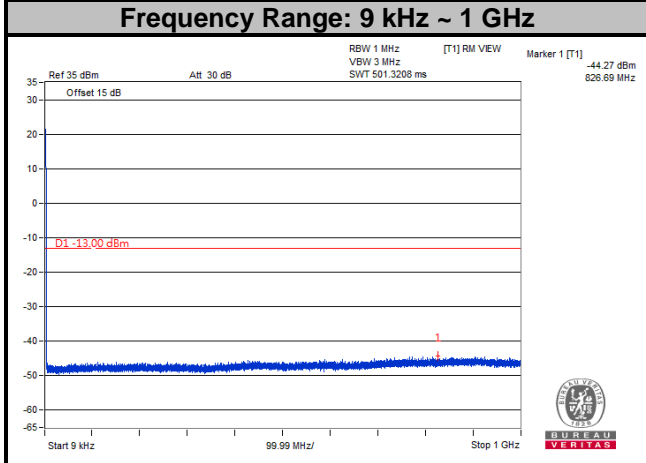

Channel 20385

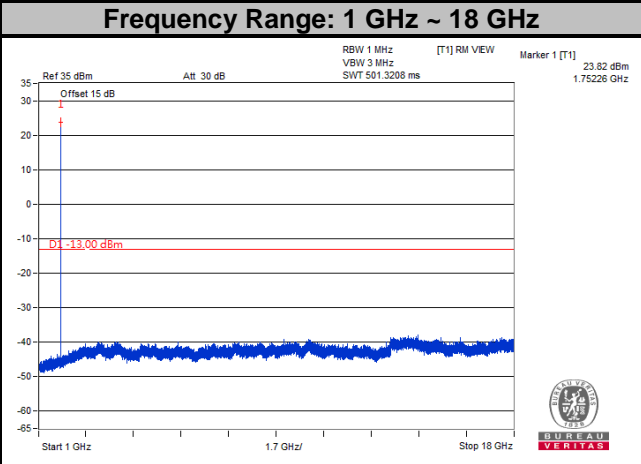
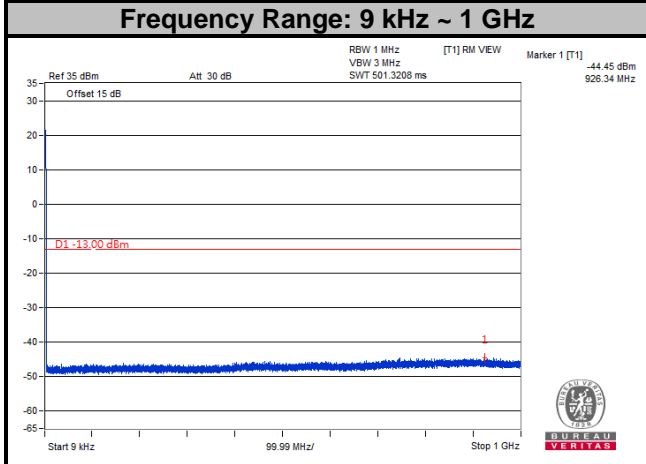

LTE Band 4

Channel Bandwidth: 5 MHz

Channel 19975

Frequency Range: 9 kHz ~ 1 GHz

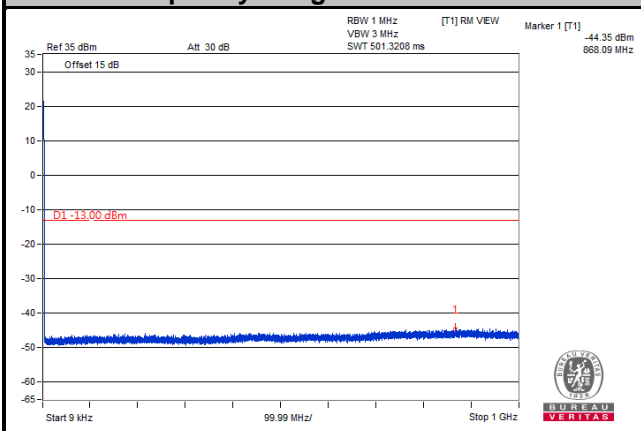

Frequency Range: 1 GHz ~ 18 GHz

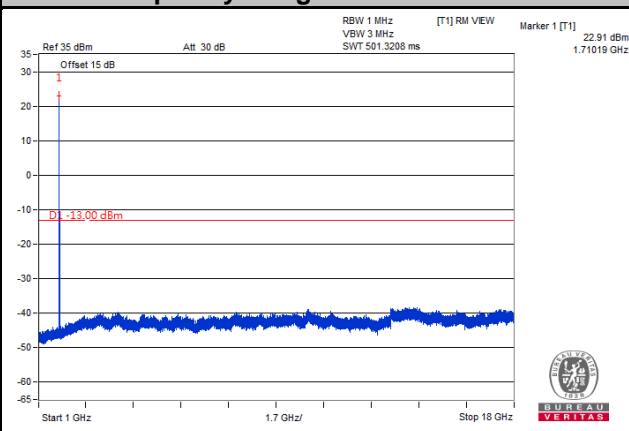

Channel 20175

Frequency Range: 9 kHz ~ 1 GHz

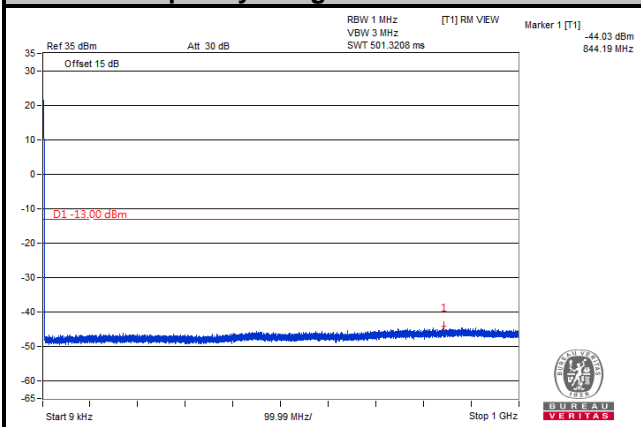

Frequency Range: 1 GHz ~ 18 GHz

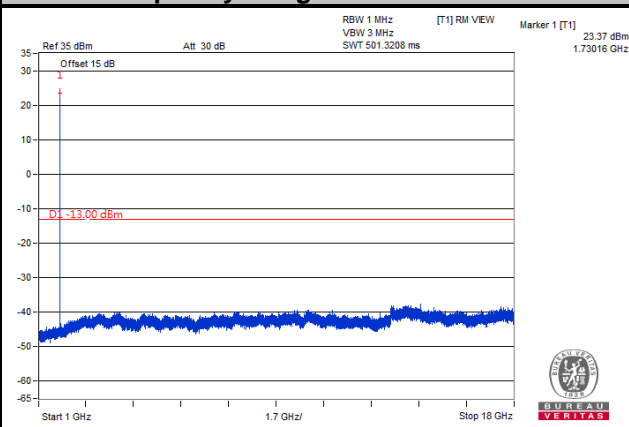

Channel 20375

Frequency Range: 9 kHz ~ 1 GHz

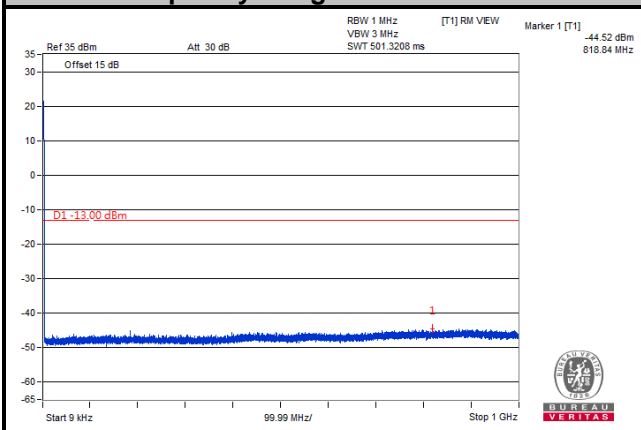

Frequency Range: 1 GHz ~ 18 GHz

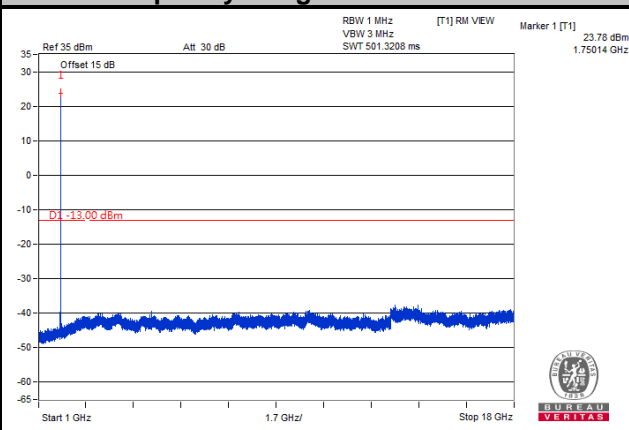

Note: The signal over the limit in 9 kHz is from spectrum analyzer.

LTE Band 4
Channel Bandwidth: 10 MHz
Channel 20000

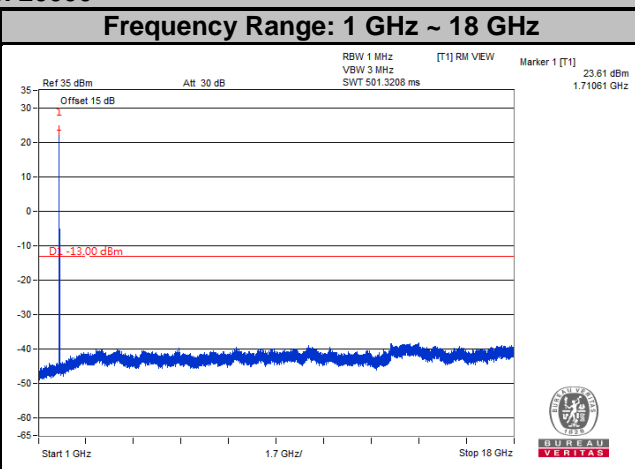
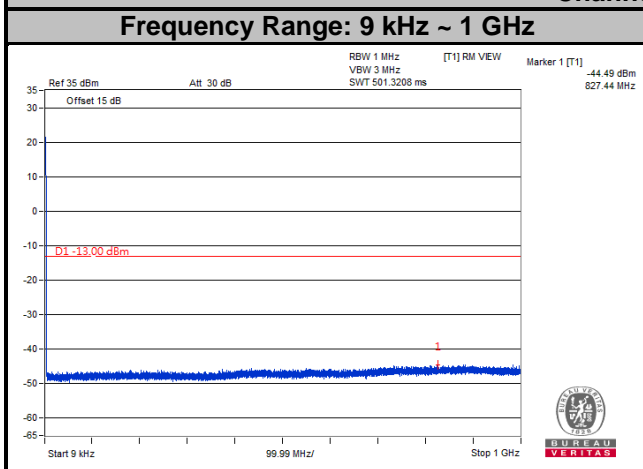

Channel 1715

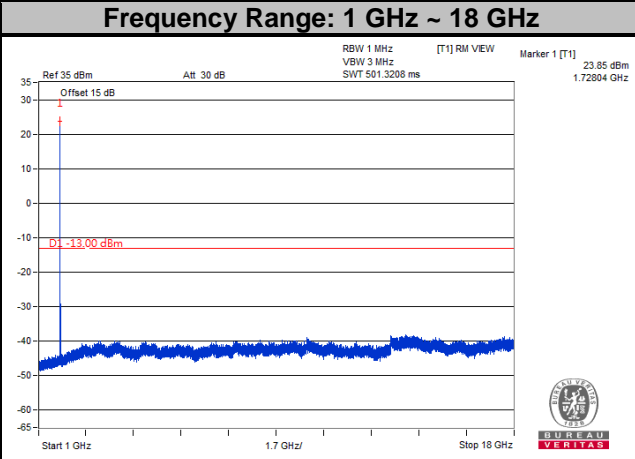
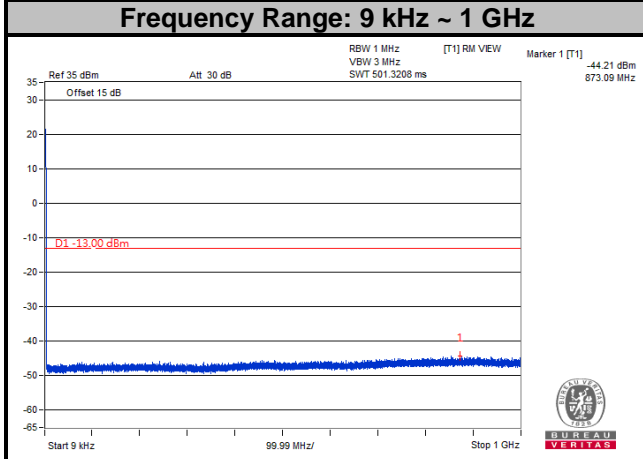

Channel 20350

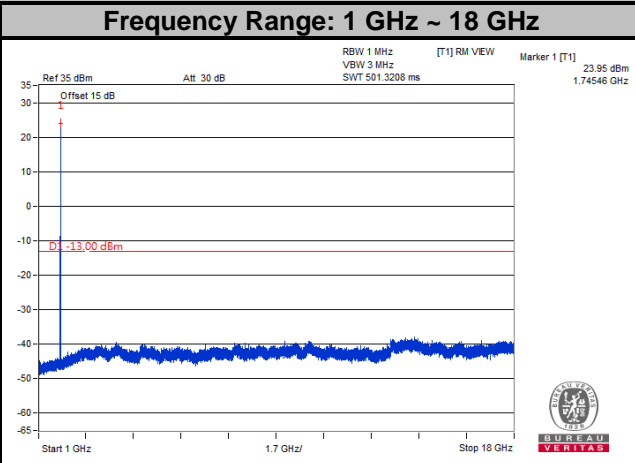
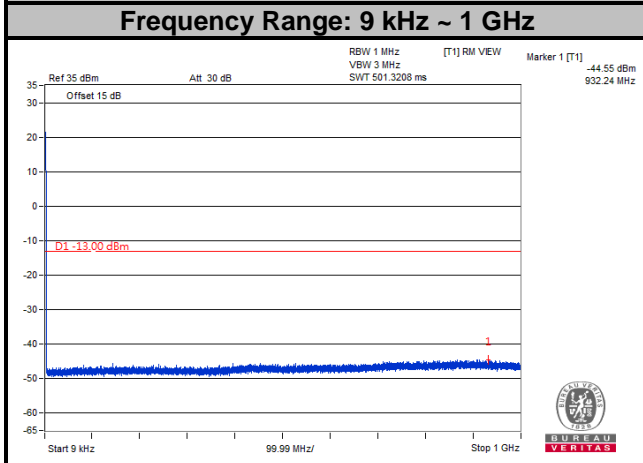

Note: The signal over the limit in 9 kHz is from spectrum analyzer.

LTE Band 4
Channel Bandwidth: 15 MHz
Channel 20025

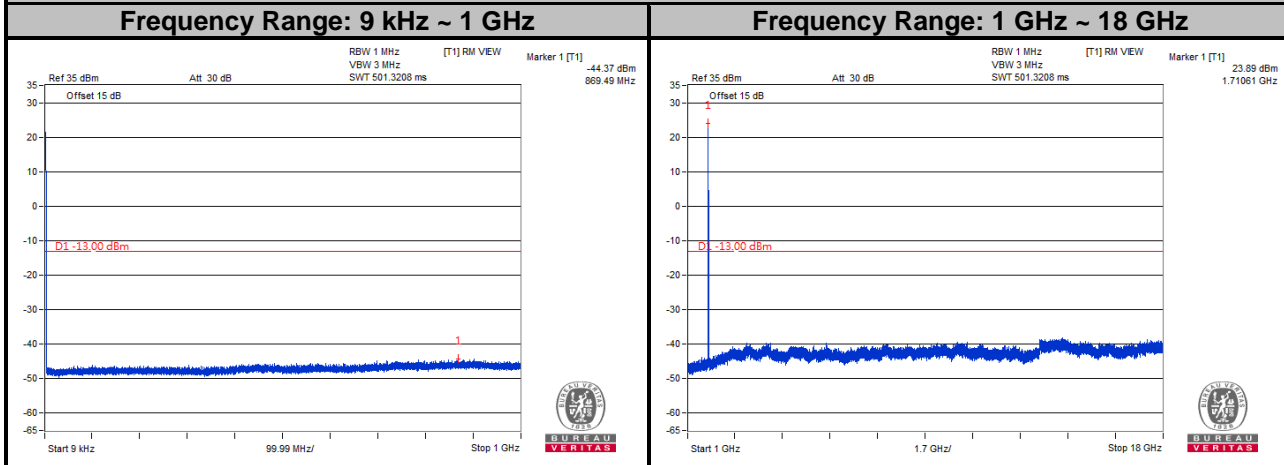

Channel 20175

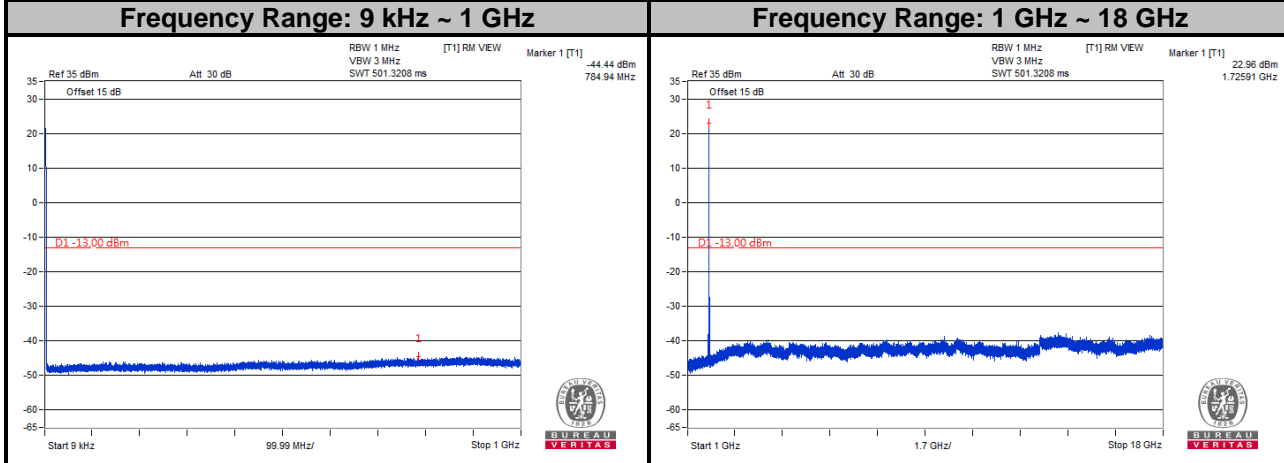

Channel 20325

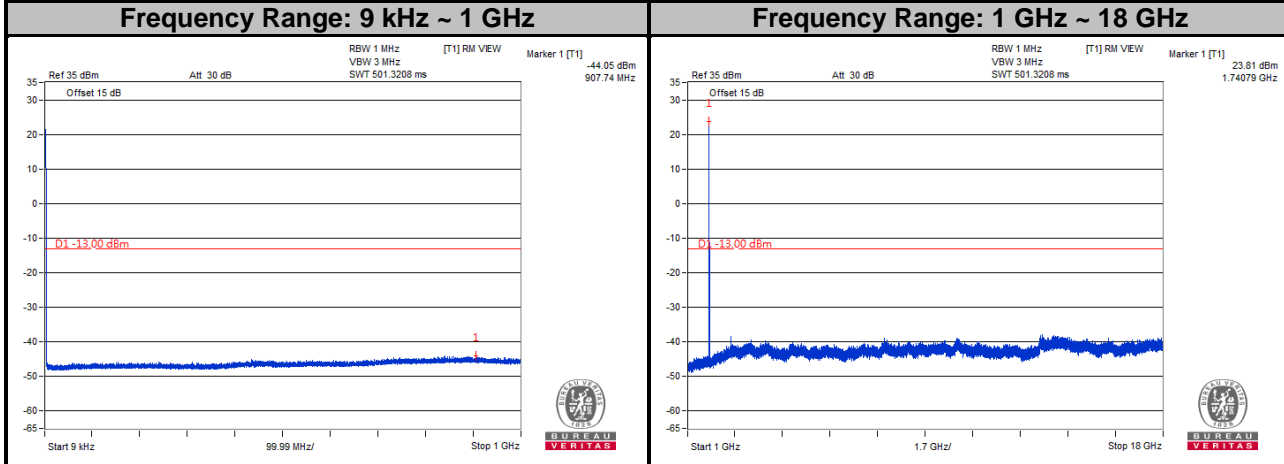

Note: The signal over the limit in 9 kHz is from spectrum analyzer.

LTE Band 4
Channel Bandwidth: 20 MHz
Channel 20050

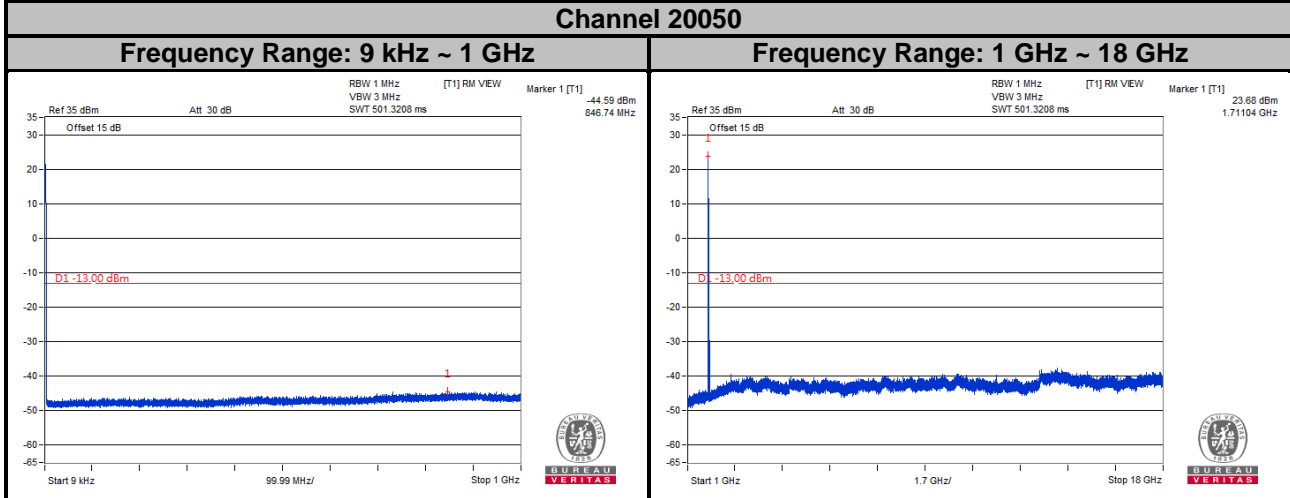

Channel 20175

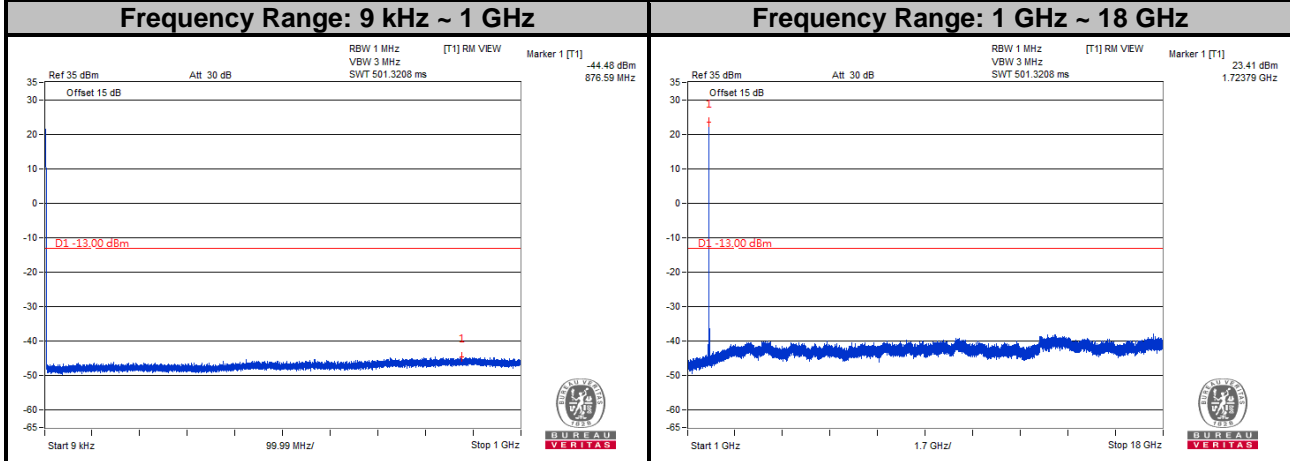

Channel 20300

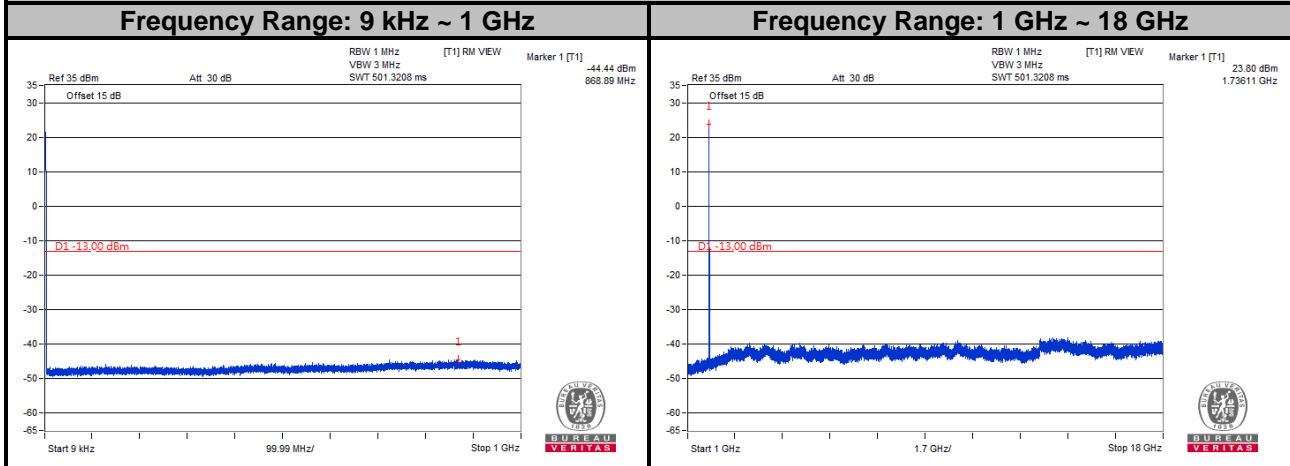

Note: The signal over the limit in 9 kHz is from spectrum analyzer.

LTE Band 12
Channel Bandwidth: 1.4 MHz
Channel 23017

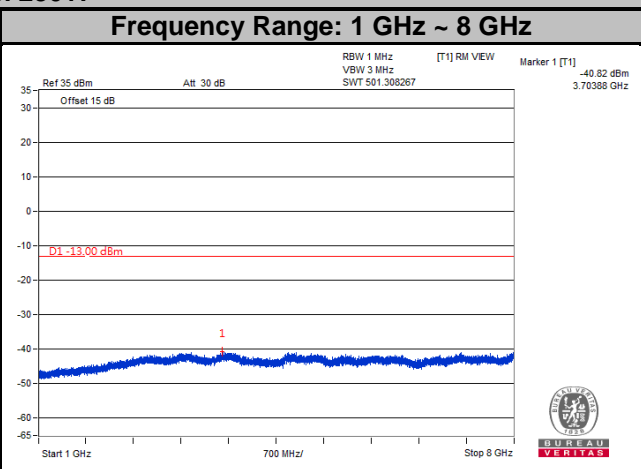
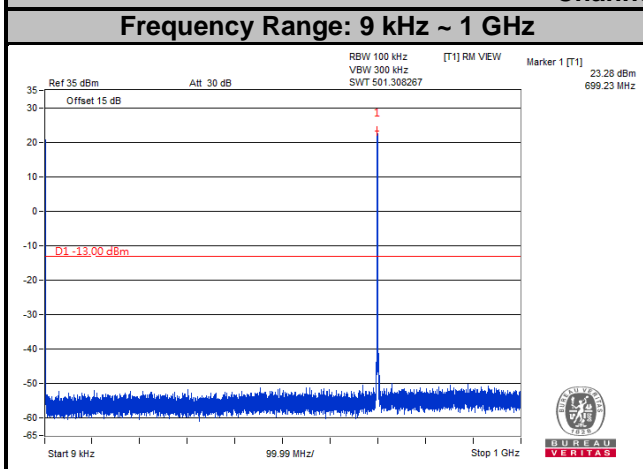

Channel 23095

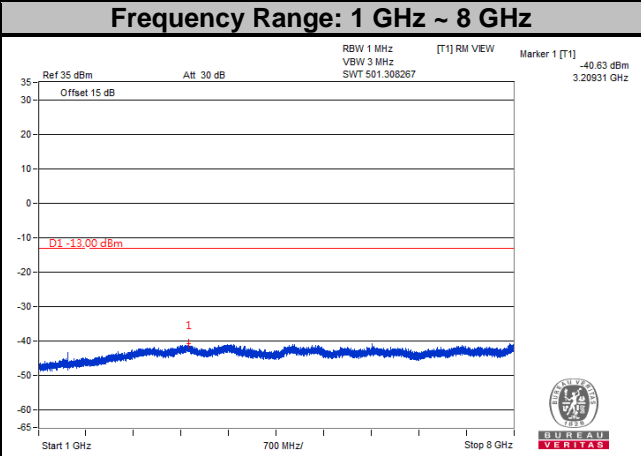
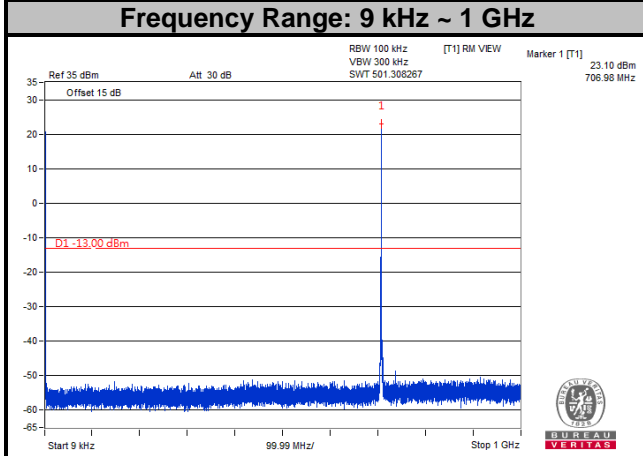

Channel 23173

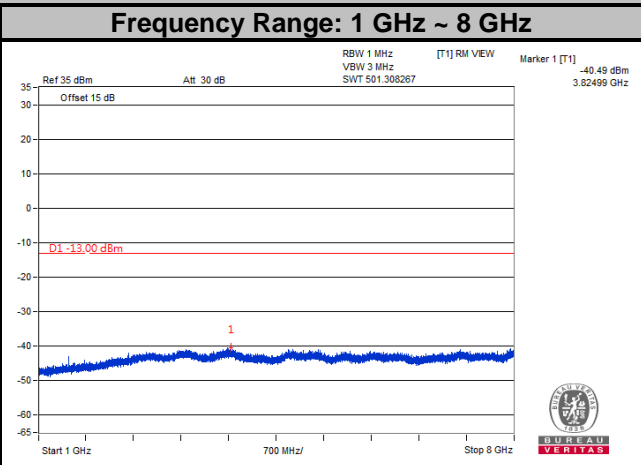
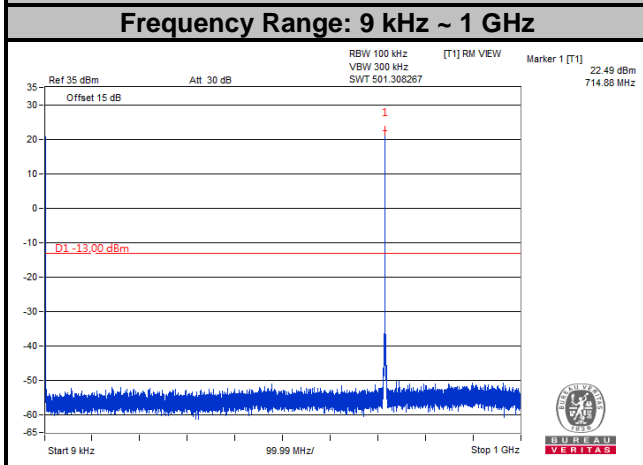

Note: The signal over the limit in 9 kHz is from spectrum analyzer.

LTE Band 12
Channel Bandwidth: 3 MHz
Channel 23025

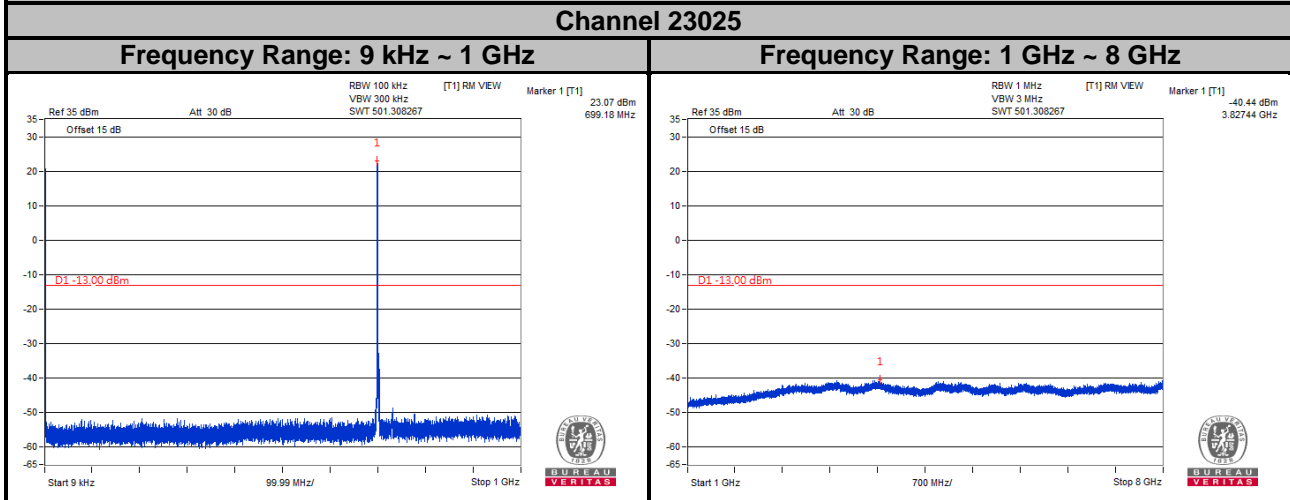

Channel 23095

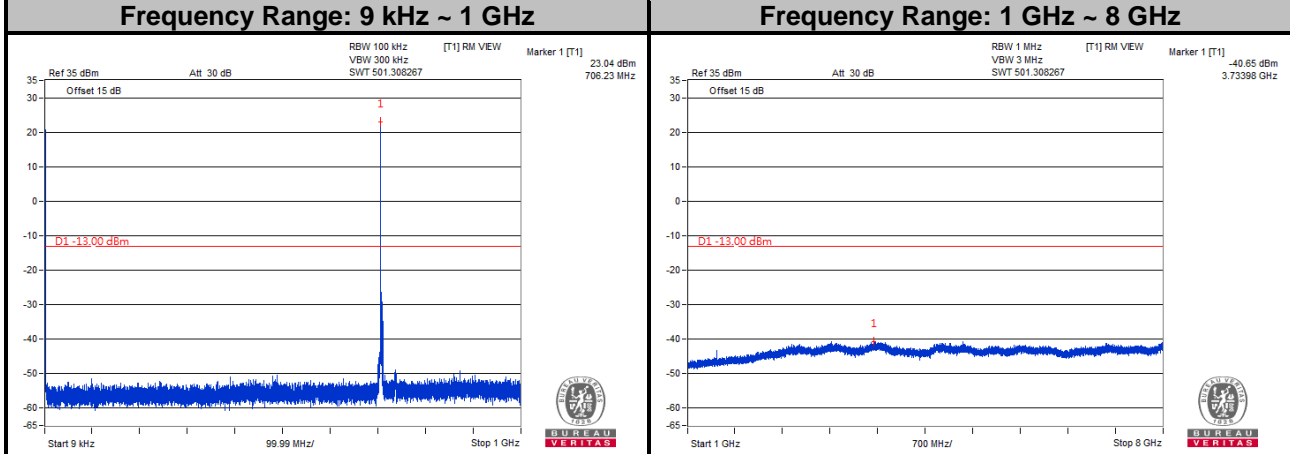

Channel 23165

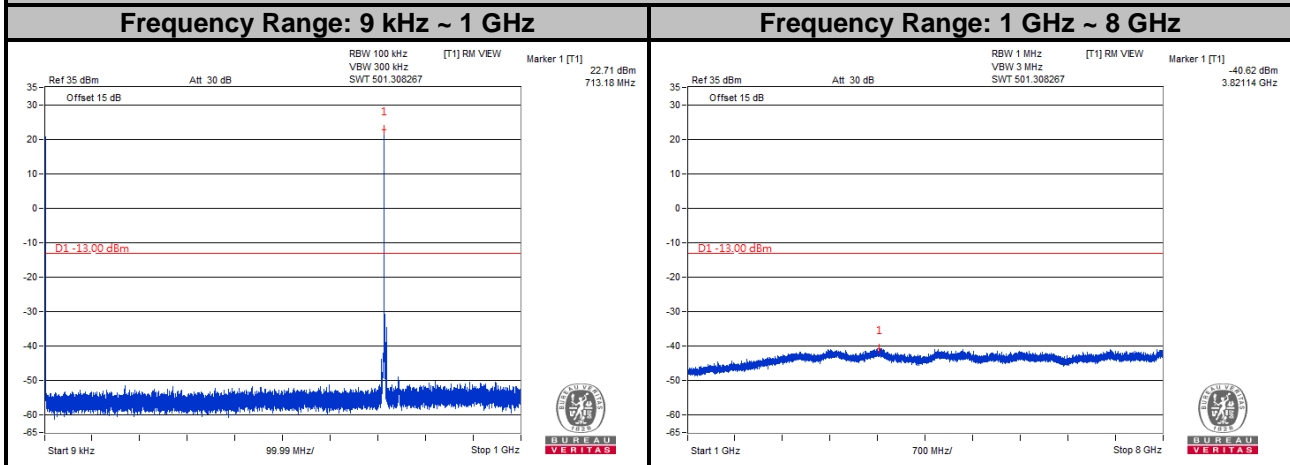

Note: The signal over the limit in 9 kHz is from spectrum analyzer.

LTE Band 12
Channel Bandwidth: 5 MHz
Channel 23035

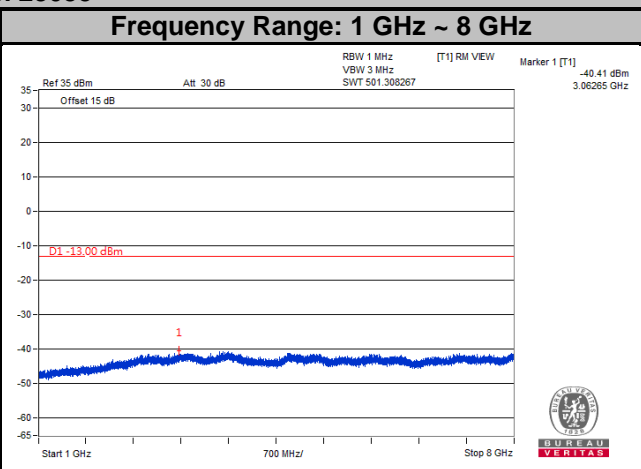
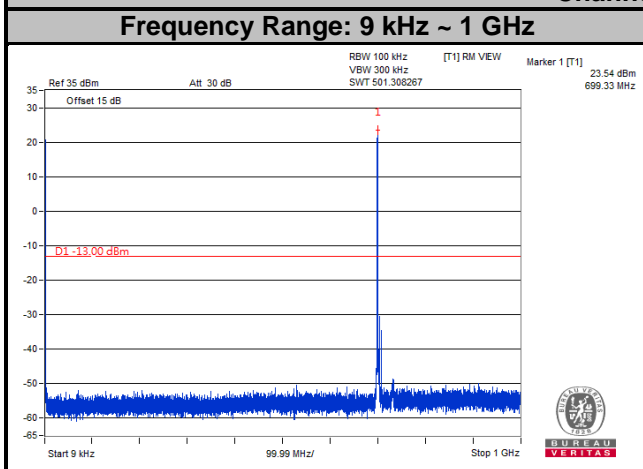

Channel 23095

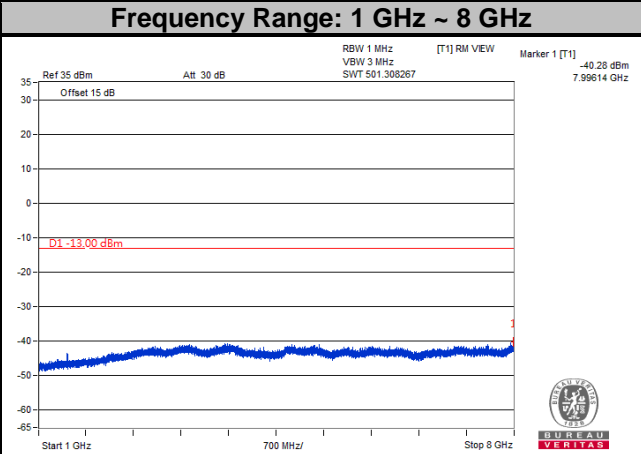
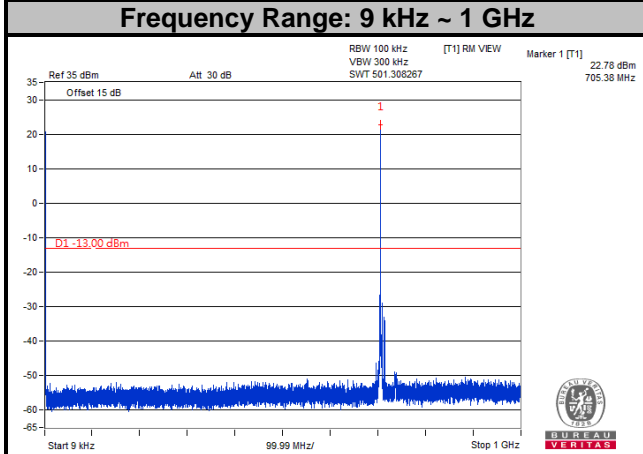

Channel 23155

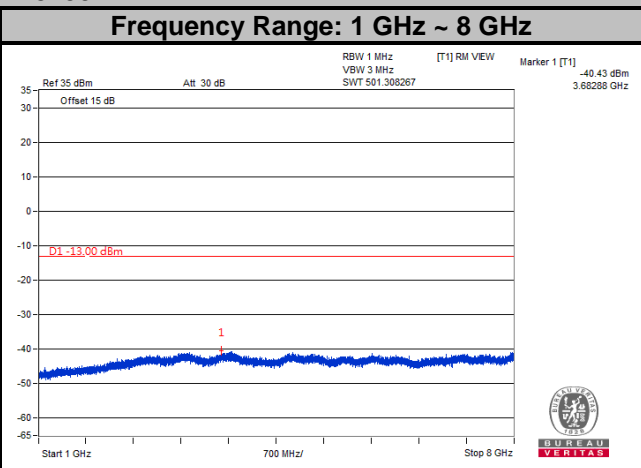
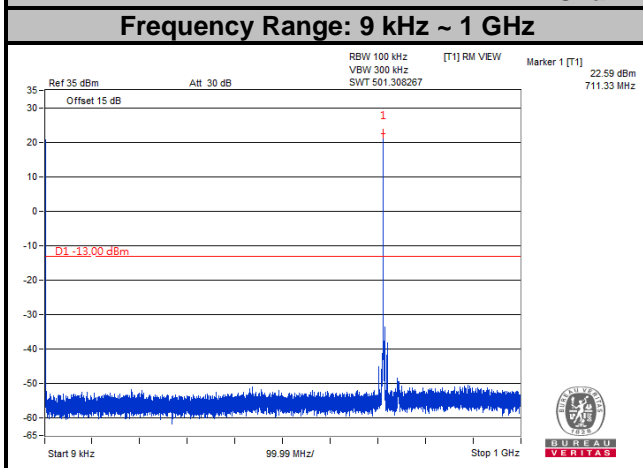

Note: The signal over the limit in 9 kHz is from spectrum analyzer.

LTE Band 12
Channel Bandwidth: 10 MHz
Channel 23060

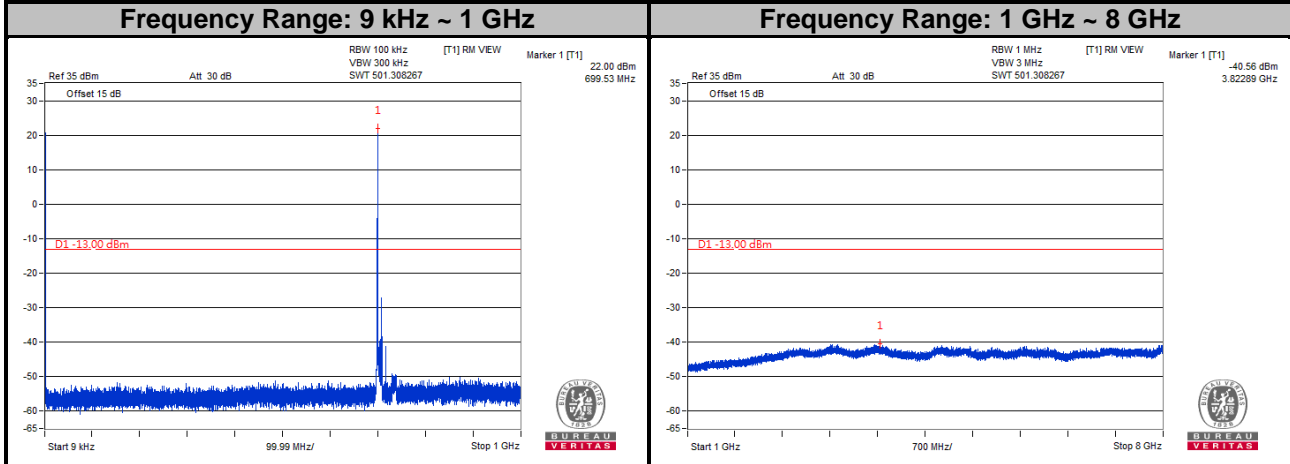

Channel 23095

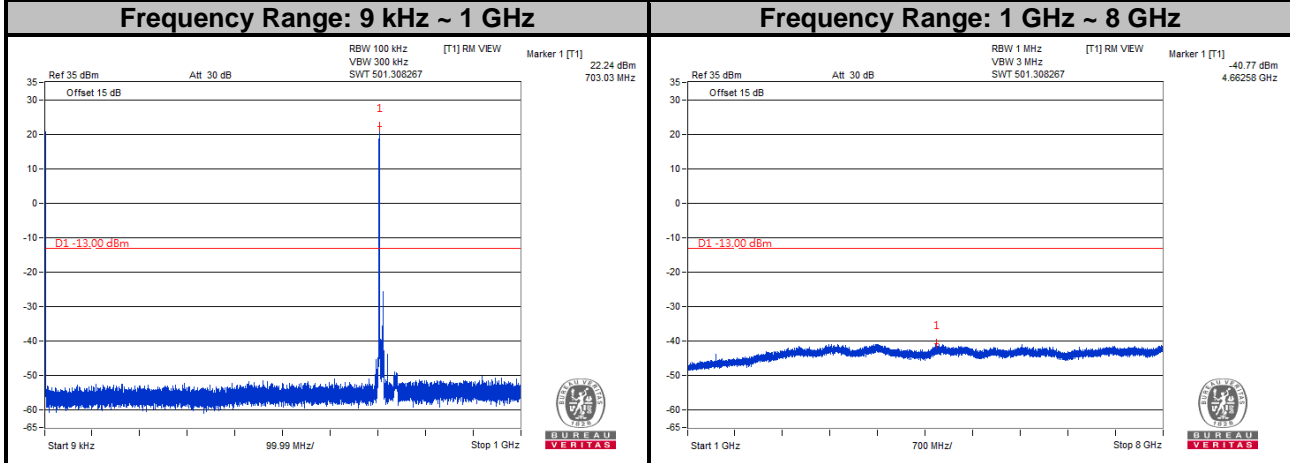

Channel 23130

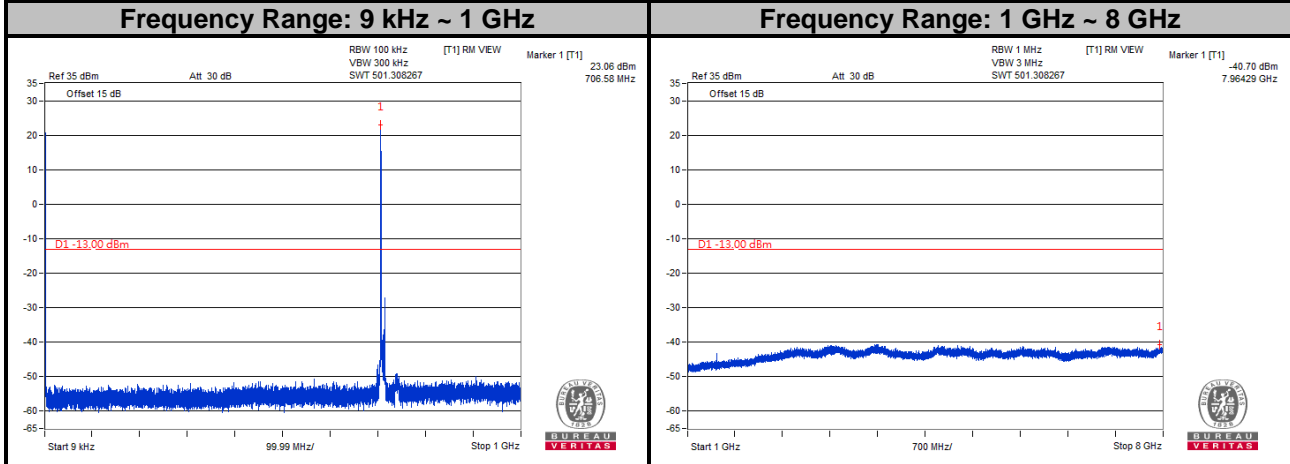

Note: The signal over the limit in 9 kHz is from spectrum analyzer.

4.8 Radiated Emission Measurement

4.8.1 Limits of Radiated Emission Measurement

- a. The power of any emission outside a licensee's frequency block shall be attenuated below the transmitter power (P) by at least $43 + 10 \log (P)$ dB. The limit of emission is equal to -13 dBm.

4.8.2 Test Procedure

- a. Substitution method is used for E.I.R.P measurement. In the semi-anechoic chamber, EUT placed on the 0.8 m (below or equal 1 GHz) and/or 1.5 m (above 1 GHz) height of Turn Table, rotated the table around 360 degrees to search the maximum radiation power and receiver antenna shall be rotated vertical and horizontal polarization and moved height from 1 m to 4 m to find the maximum polar radiated power. The "Read Value" is the spectrum reading the maximum power value.
- b. The substitution horn antenna is substituted for EUT at the same position and signals generator export the CW signal to the substitution antenna via a TX cable. Rotated the Turn Table and moved receiving antenna to find the maximum radiation power. Adjust output power level of S.G to get a Value of spectrum reading equal to "Read Value" of step a. Record the power level of S.G.
- c. $EIRP = \text{Output power level of S.G} - \text{TX cable loss} + \text{Antenna gain of substitution horn}$.
- d. E.R.P power can be calculated form E.I.R.P power by subtracting the gain of dipole, $E.R.P \text{ power} = E.I.R.P \text{ power} - 2.15 \text{ dB}$.

Note: The resolution bandwidth of spectrum analyzer is 1 MHz and the video bandwidth is 3 MHz.

4.8.3 Deviation from Test Standard

No deviation.

4.8.4 Test Setup

<Radiated Emission below or equal 1 GHz>

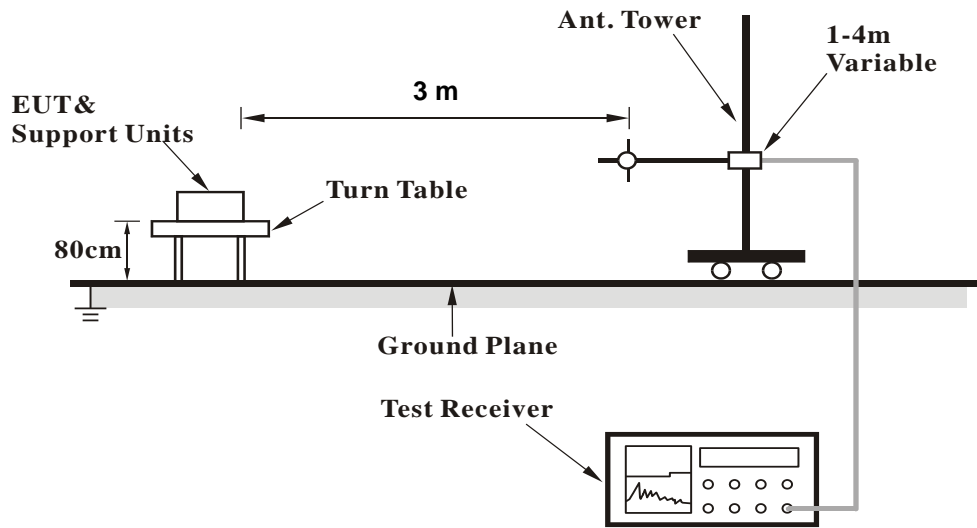

<Radiated Emission above 1 GHz>

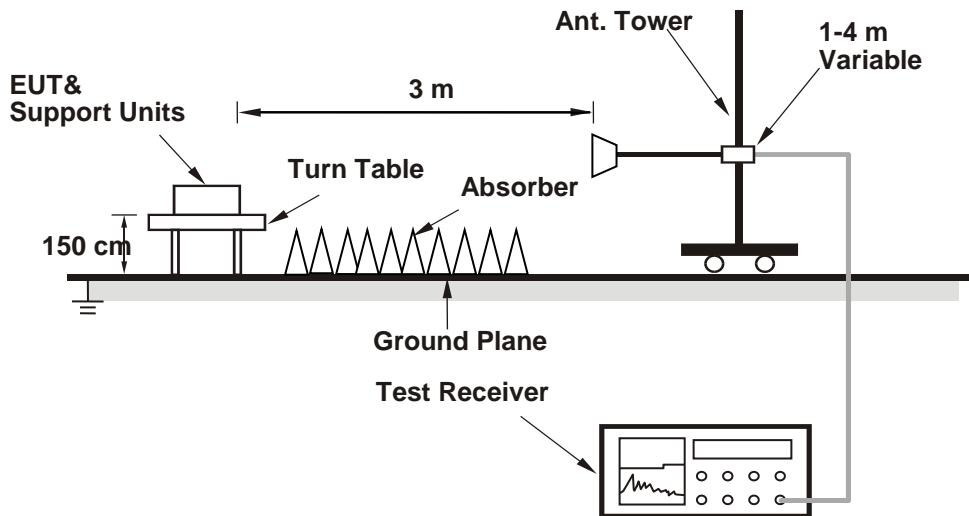

For the actual test configuration, please refer to the attached file (Test Setup Photo).

4.8.5 Test Results

LTE Band 4

Channel Bandwidth: 1.4 MHz / QPSK

Low Channel



Bureau Veritas Consumer Products Services Ltd., Taoyuan Branch

A D T

Data: 3

Date: 2020-07-27

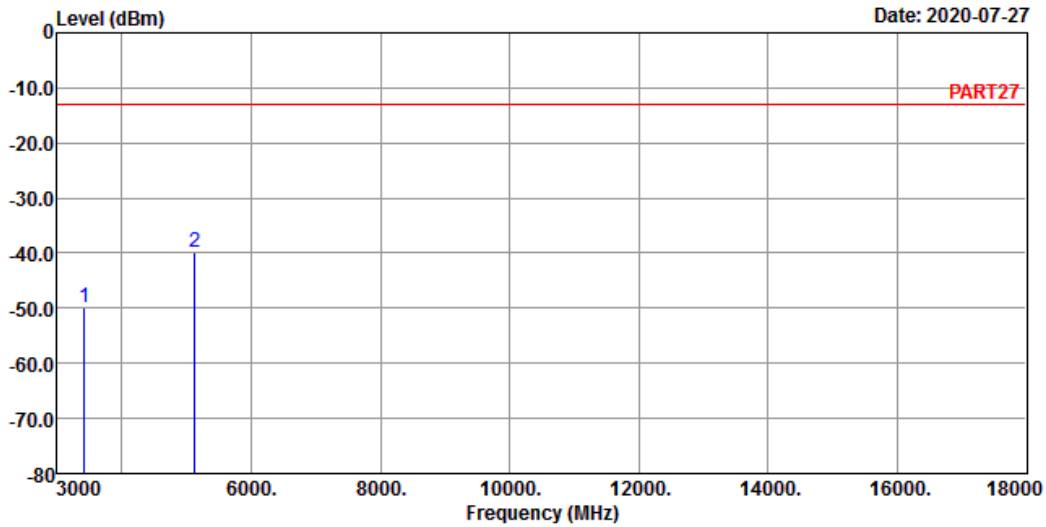

Site : 966 Chamber 5
 Condition: PART27 HORIZONTAL
 Remak : LTE Band 4 QPSK_1.4M Link_L-CH
 Tested by: Cyril Chen

	Freq	Level	Read Level	Limit	Line Factor	Over Limit	Remark
	MHz	dBm	dBm	dBm	dB	dB	
1	3421.40	-49.85	-41.51	-13.00	-8.34	-36.85	Peak
2 pp	5132.10	-39.88	-38.14	-13.00	-1.74	-26.88	Peak



Bureau Veritas Consumer Products Services Ltd., Taoyuan Branch

A D T

Data: 4

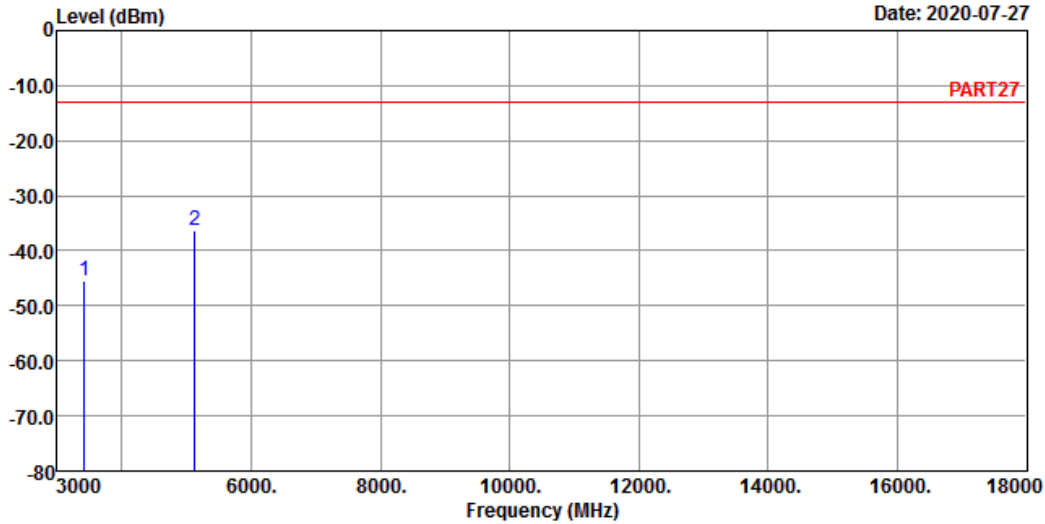

Site : 966 Chamber 5
 Condition: PART27 VERTICAL
 Remak : LTE Band 4 QPSK_1.4M Link_L-CH
 Tested by: Cyril Chen

	Freq	Level	Read Level	Limit	Line Factor	Over Limit	Remark
	MHz	dBm	dBm	dBm	dB	dB	
1	3421.40	-45.33	-36.99	-13.00	-8.34	-32.33	Peak
2 pp	5132.10	-36.17	-34.43	-13.00	-1.74	-23.17	Peak

Middle Channel



Bureau Veritas Consumer Products Services Ltd., Taoyuan Branch

A D T

Data: 3

Date: 2020-07-27

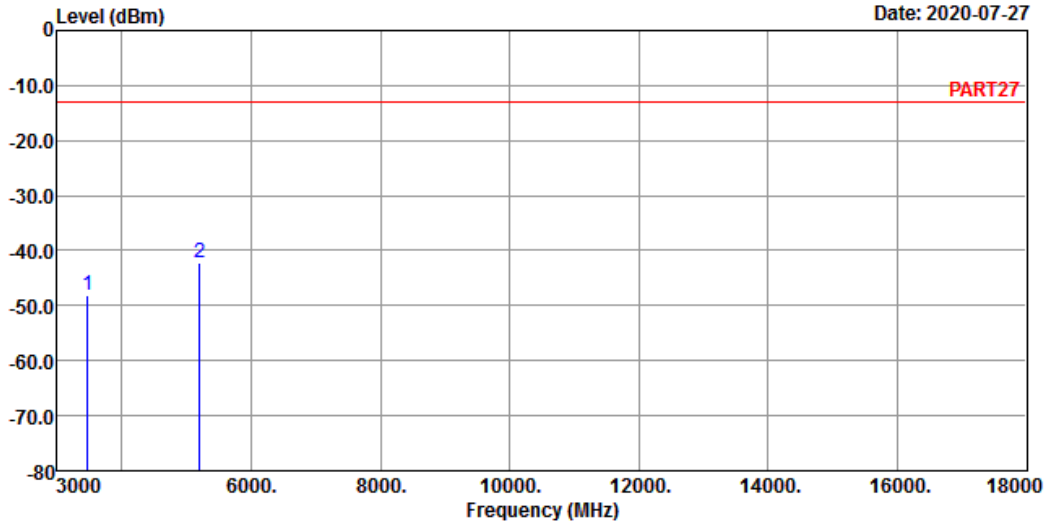

Site : 966 Chamber 5
 Condition: PART27 HORIZONTAL
 Remak : LTE Band 4 QPSK_1.4M Link_M-CH
 Tested by: Cyril Chen

	Freq	Level	Read Level	Limit	Line Factor	Over Limit	Remark
	MHz	dBm	dBm	dBm	dB	dB	
1	3465.00	-48.06	-40.18	-13.00	-7.88	-35.06	Peak
2 pp	5197.50	-42.19	-40.12	-13.00	-2.07	-29.19	Peak



Bureau Veritas Consumer Products Services Ltd., Taoyuan Branch

A D T

Data: 4

Date: 2020-07-27

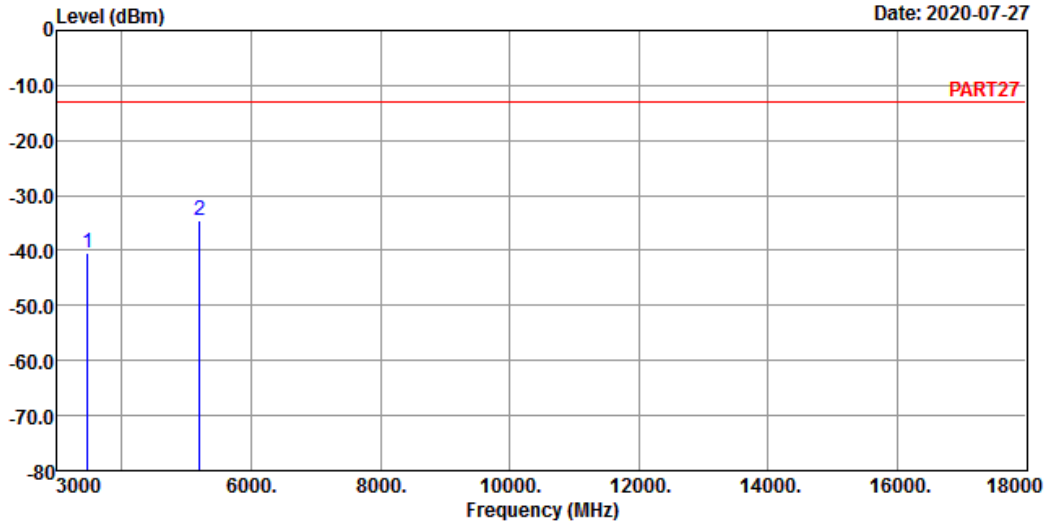

Site : 966 Chamber 5
 Condition: PART27 VERTICAL
 Remak : LTE Band 4 QPSK_1.4M Link_M-CH
 Tested by: Cyril Chen

	Freq	Level	Read Level	Limit	Line Factor	Over Limit	Remark
	MHz	dBm	dBm	dBm	dB	dB	
1	3465.00	-40.48	-32.60	-13.00	-7.88	-27.48	Peak
2 pp	5197.50	-34.58	-32.51	-13.00	-2.07	-21.58	Peak

High Channel



Bureau Veritas Consumer Products Services Ltd., Taoyuan Branch

A D T

Data: 3

Date: 2020-07-27

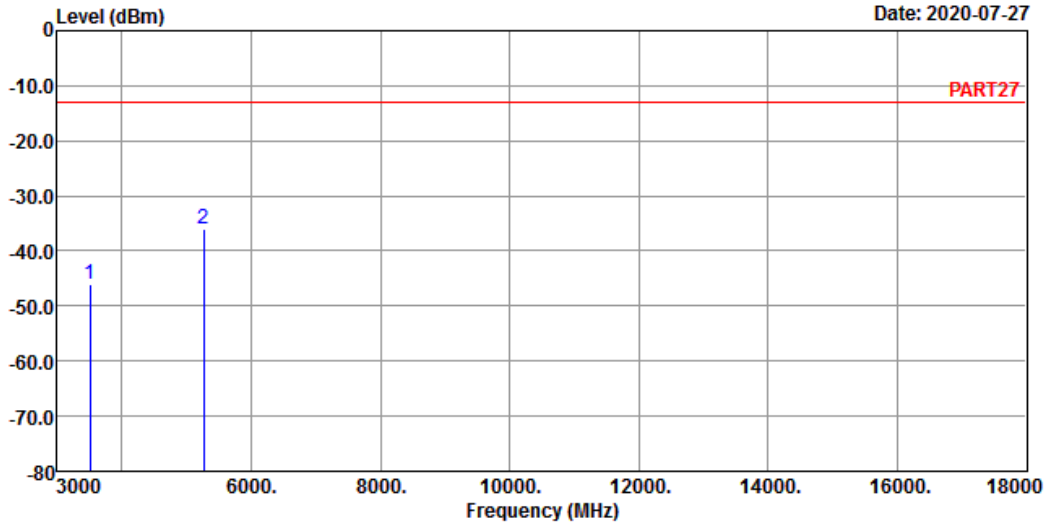

Site : 966 Chamber 5
 Condition: PART27 HORIZONTAL
 Remak : LTE Band 4 QPSK_1.4M Link_H-CH
 Tested by: Cyril Chen

	Freq	Level	Read Level	Limit	Line Factor	Over Limit	Remark
	MHz	dBm	dBm	dBm	dB	dB	
1	3508.60	-46.01	-38.56	-13.00	-7.45	-33.01	Peak
2 pp	5262.90	-36.10	-33.58	-13.00	-2.52	-23.10	Peak



Bureau Veritas Consumer Products Services Ltd., Taoyuan Branch

A D T

Data: 4

Date: 2020-07-27

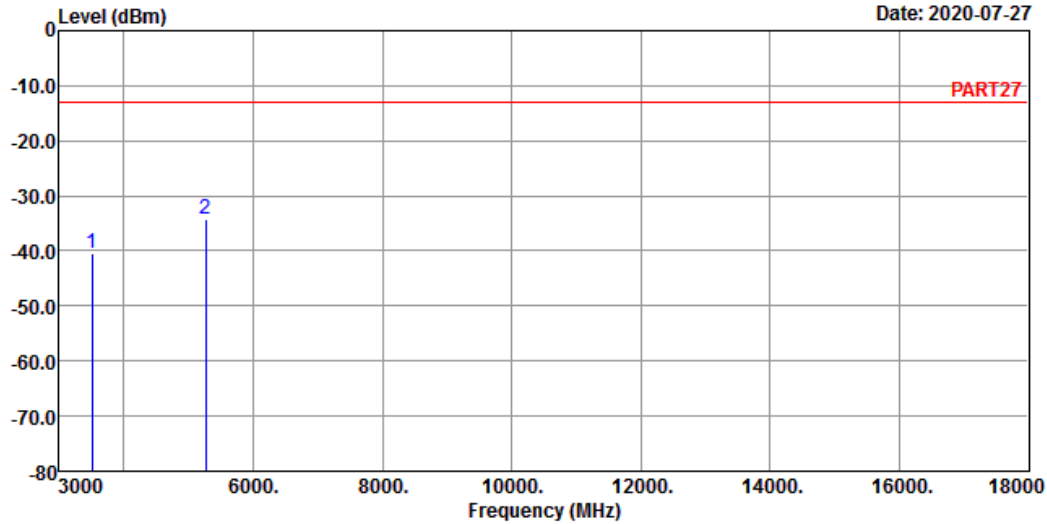

Site : 966 Chamber 5
 Condition: PART27 VERTICAL
 Remak : LTE Band 4 QPSK_1.4M Link_H-CH
 Tested by: Cyril Chen

	Freq	Level	Read Level	Limit	Line Factor	Over Limit	Remark
	MHz	dBm	dBm	dBm	dB	dB	
1	3508.60	-40.51	-33.06	-13.00	-7.45	-27.51	Peak
2 pp	5262.90	-34.15	-31.63	-13.00	-2.52	-21.15	Peak

Channel Bandwidth: 5 MHz / QPSK
Low Channel



Bureau Veritas Consumer Products Services Ltd., Taoyuan Branch

A D T

Data: 3

Date: 2020-07-27

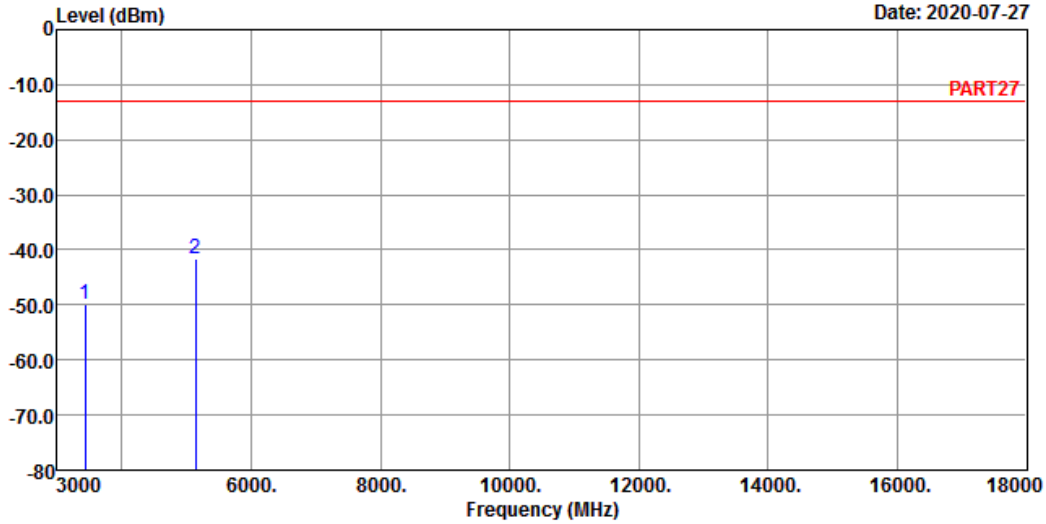

Site : 966 Chamber 5
Condition: PART27 HORIZONTAL
Remak : LTE Band 4 QPSK_5M Link_L-CH
Tested by: Cyril Chen

	Freq	Level	Read Level	Limit	Line Factor	Over Limit	Remark
	MHz	dBm	dBm	dBm	dB	dB	
1	3425.00	-49.74	-41.40	-13.00	-8.34	-36.74	Peak
2	5137.50	-41.51	-39.77	-13.00	-1.74	-28.51	Peak



Bureau Veritas Consumer Products Services Ltd., Taoyuan Branch

A D T

Data: 4

Date: 2020-07-27

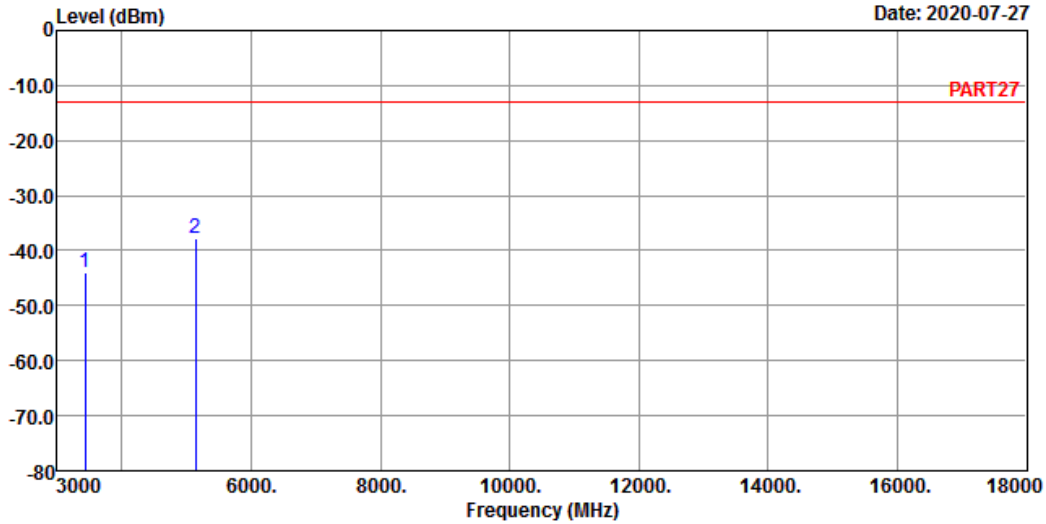

Site : 966 Chamber 5
 Condition: PART27 VERTICAL
 Remak : LTE Band 4 QPSK_5M Link_L-CH
 Tested by: Cyril Chen

	Freq	Level	Read Level	Limit Line	Factor	Over Limit	Remark
	MHz	dBm	dBm	dBm	dB	dB	
1	3425.00	-43.99	-35.65	-13.00	-8.34	-30.99	Peak
2	5137.50	-37.92	-36.18	-13.00	-1.74	-24.92	Peak

Middle Channel



Bureau Veritas Consumer Products Services Ltd., Taoyuan Branch

A D T

Data: 3

Date: 2020-07-27

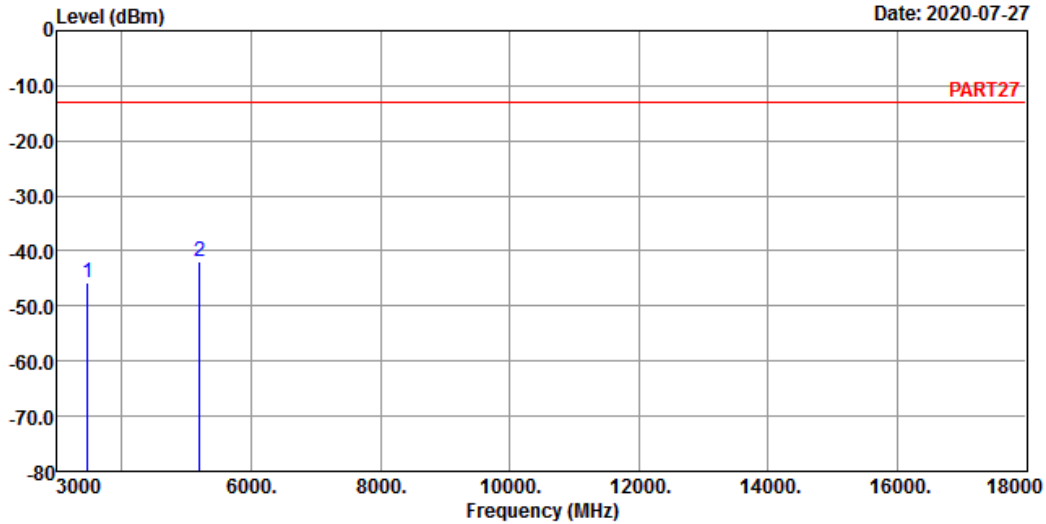

Site : 966 Chamber 5
 Condition: PART27 HORIZONTAL
 Remak : LTE Band 4 QPSK_5M Link_M-CH
 Tested by: Cyril Chen

	Freq	Level	Read Level	Limit Line	Over Factor	Over Limit	Remark
	MHz	dBm	dBm	dBm	dB	dB	
1	3465.00	-45.89	-38.01	-13.00	-7.88	-32.89	Peak
2 pp	5197.50	-41.91	-39.84	-13.00	-2.07	-28.91	Peak



Bureau Veritas Consumer Products Services Ltd., Taoyuan Branch

A D T

Data: 4

Date: 2020-07-27

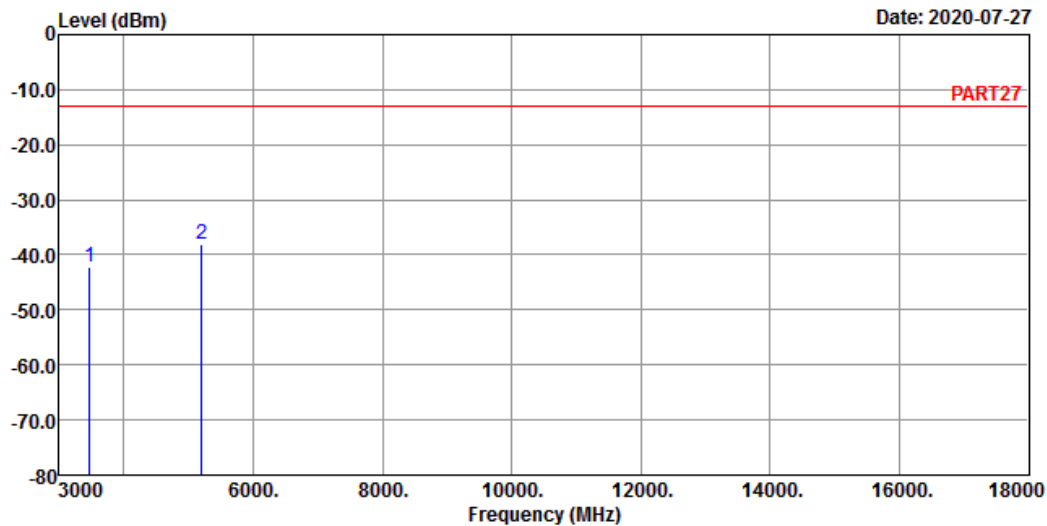

Site : 966 Chamber 5
 Condition: PART27 VERTICAL
 Remak : LTE Band 4 QPSK_5M Link_M-CH
 Tested by: Cyril Chen

	Freq	Level	Read Level	Limit Line	Factor	Over Limit	Remark
	MHz	dBm	dBm	dBm	dB	dB	
1	3465.00	-42.34	-34.46	-13.00	-7.88	-29.34	Peak
2 pp	5197.50	-38.16	-36.09	-13.00	-2.07	-25.16	Peak

High Channel



Bureau Veritas Consumer Products Services Ltd., Taoyuan Branch

A D T

Data: 3

Date: 2020-07-27

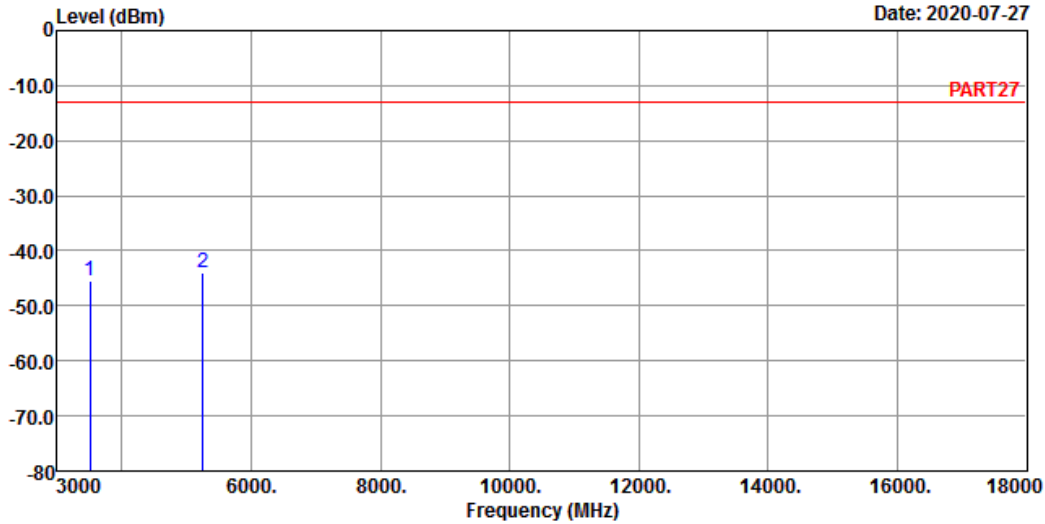

Site : 966 Chamber 5
 Condition: PART27 HORIZONTAL
 Remak : LTE Band 4 QPSK_5M Link_H-CH
 Tested by: Cyril Chen

	Freq	Level	Read Level	Limit Line	Over Factor	Over Limit	Remark
	MHz	dBm	dBm	dBm	dB	dB	
1	3505.00	-45.40	-37.95	-13.00	-7.45	-32.40	Peak
2 pp	5257.50	-44.04	-41.52	-13.00	-2.52	-31.04	Peak



Bureau Veritas Consumer Products Services Ltd., Taoyuan Branch

A D T

Data: 4

Date: 2020-07-27

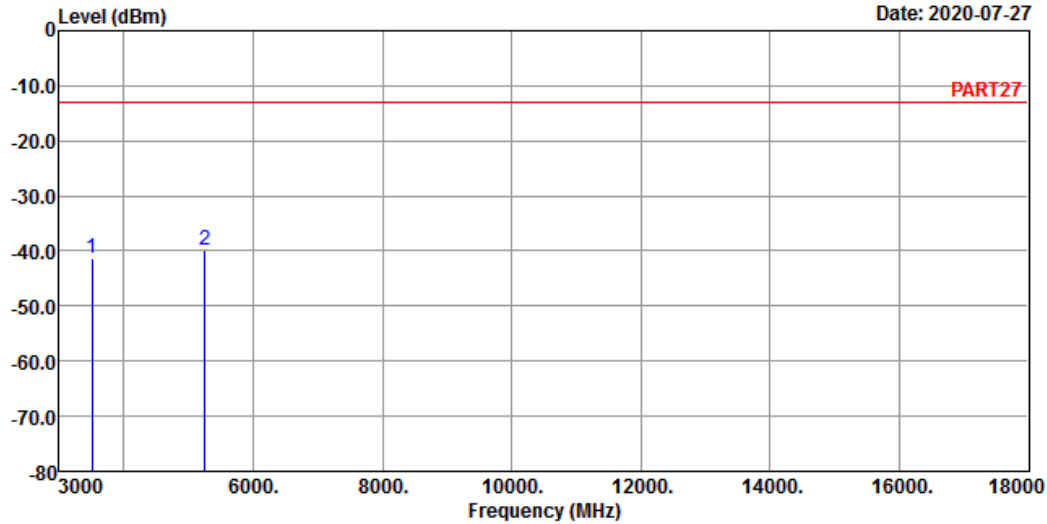

Site : 966 Chamber 5
 Condition: PART27 VERTICAL
 Remak : LTE Band 4 QPSK_5M Link_H-CH
 Tested by: Cyril Chen

	Freq	Level	Read Level	Limit Line	Factor	Over Limit	Remark
	MHz	dBm	dBm	dBm	dB	dB	
1	3505.00	-41.37	-33.92	-13.00	-7.45	-28.37	Peak
2	5257.50	-39.81	-37.29	-13.00	-2.52	-26.81	Peak

Channel Bandwidth: 20 MHz / QPSK
Low Channel



Bureau Veritas Consumer Products Services Ltd., Taoyuan Branch

A D T

Data: 3

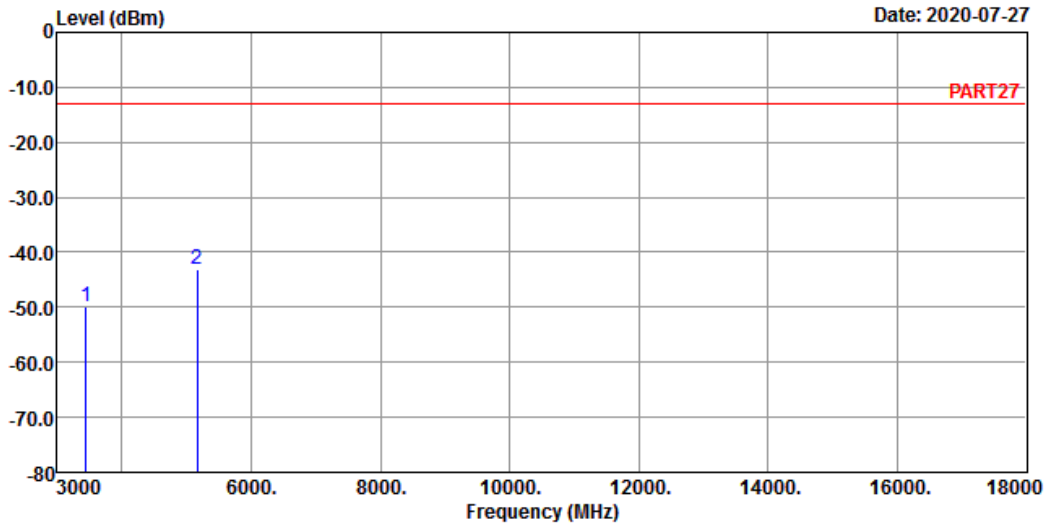

Site : 966 Chamber 5
Condition: PART27 HORIZONTAL
Remak : LTE Band 4 QPSK_20M Link_L-CH
Tested by: Cyril Chen

	Freq	Level	Read Level	Limit	Line Factor	Over Limit	Remark
	MHz	dBm	dBm	dBm	dB	dB	
1	3440.00	-49.85	-41.63	-13.00	-8.22	-36.85	Peak
2 pp	5160.00	-43.01	-41.10	-13.00	-1.91	-30.01	Peak



Bureau Veritas Consumer Products Services Ltd., Taoyuan Branch

A D T

Data: 4

Date: 2020-07-27

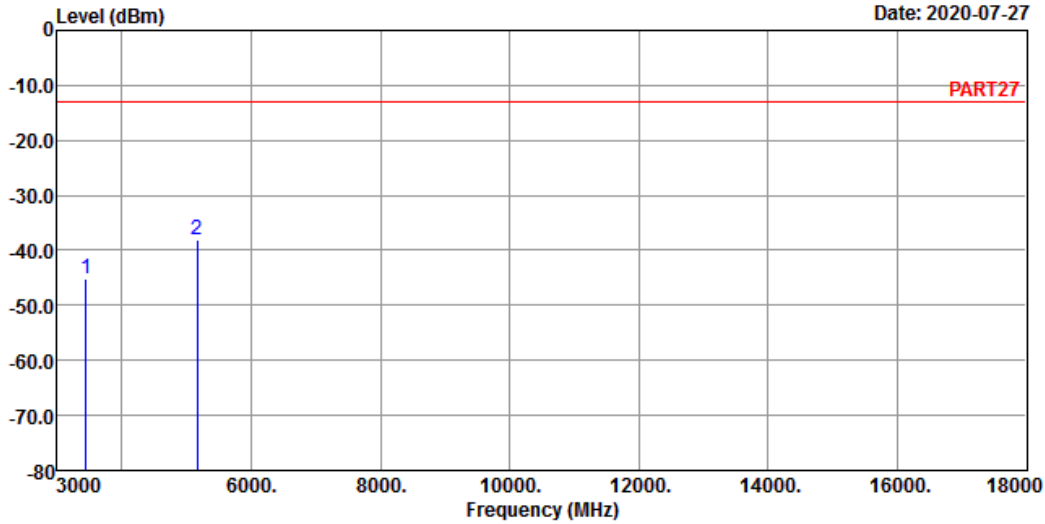

Site : 966 Chamber 5
 Condition: PART27 VERTICAL
 Remak : LTE Band 4 QPSK_20M Link_L-CH
 Tested by: Cyril Chen

	Freq	Level	Read Level	Limit Line	Factor	Over Limit	Remark
	MHz	dBm	dBm	dBm	dB	dB	
1	3440.00	-45.14	-36.92	-13.00	-8.22	-32.14	Peak
2	5160.00	-38.13	-36.22	-13.00	-1.91	-25.13	Peak

Middle Channel



Bureau Veritas Consumer Products Services Ltd., Taoyuan Branch

A D T

Data: 7

Date: 2020-07-27

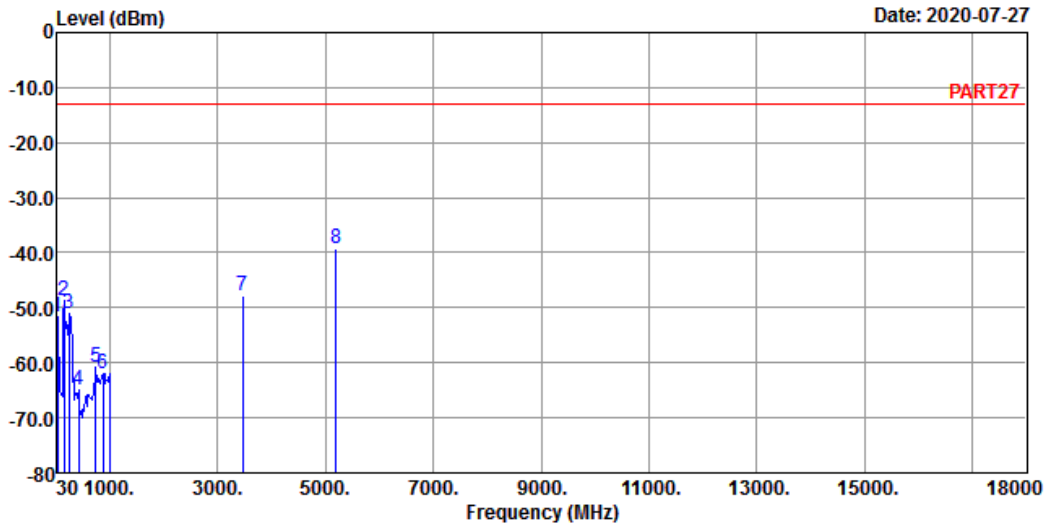

Site : 966 Chamber 5
 Condition: PART27 HORIZONTAL
 Remak : LTE Band 4 QPSK_20M Link_M-CH
 Tested by: Cyril Chen

	Freq	Level	Read Level	Limit Line	Over Factor	Over Limit	Remark
	MHz	dBm	dBm	dBm	dB	dB	
1	30.00	-51.77	-52.15	-13.00	0.38	-38.77	QP
2	156.10	-48.57	-42.63	-13.00	-5.94	-35.57	QP
3	250.19	-51.13	-45.14	-13.00	-5.99	-38.13	QP
4	425.76	-64.97	-59.23	-13.00	-5.74	-51.97	QP
5	746.83	-60.88	-61.70	-13.00	0.82	-47.88	QP
6	883.60	-61.97	-62.45	-13.00	0.48	-48.97	QP
7	3465.00	-47.77	-39.89	-13.00	-7.88	-34.77	Peak
8	5197.50	-39.27	-37.20	-13.00	-2.07	-26.27	Peak



Bureau Veritas Consumer Products Services Ltd., Taoyuan Branch

A D T

Data: 8

Date: 2020-07-27

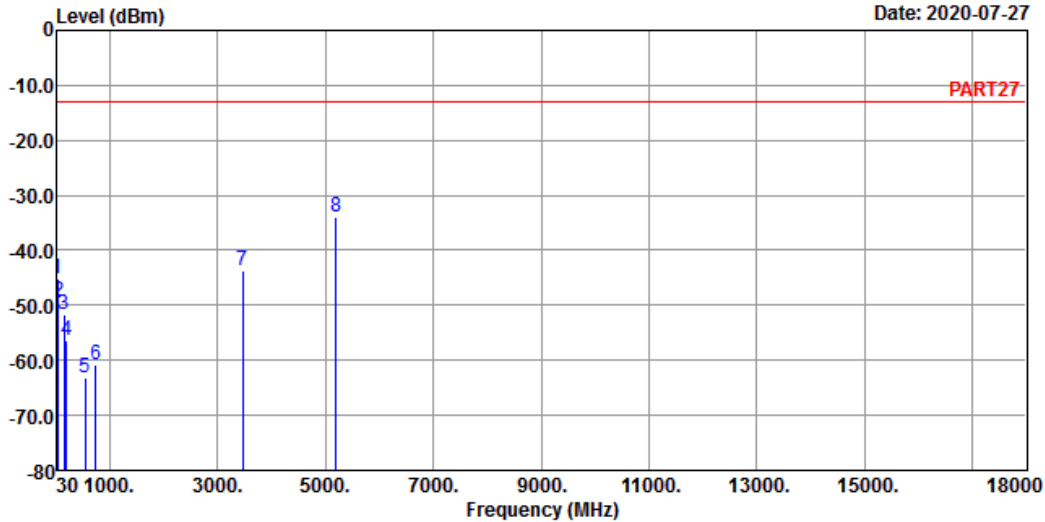

Site : 966 Chamber 5
 Condition: PART27 VERTICAL
 Remak : LTE Band 4 QPSK_20M Link_M-CH
 Tested by: Cyril Chen

	Freq	Level	Read Level	Limit Line	Over Factor	Over Limit	Remark
	MHz	dBm	dBm	dBm	dB	dB	
1	qp	30.00	-45.18	-45.56	-13.00	0.38	-32.18 QP
2		45.52	-49.16	-46.66	-13.00	-2.50	-36.16 QP
3		154.16	-51.58	-45.10	-13.00	-6.48	-38.58 QP
4		202.66	-56.51	-48.61	-13.00	-7.90	-43.51 QP
5		547.01	-63.18	-60.23	-13.00	-2.95	-50.18 QP
6		746.83	-60.85	-61.67	-13.00	0.82	-47.85 QP
7		3465.00	-43.78	-35.90	-13.00	-7.88	-30.78 Peak
8	pp	5197.50	-33.97	-31.90	-13.00	-2.07	-20.97 Peak

High Channel



Bureau Veritas Consumer Products Services Ltd., Taoyuan Branch

A D T

Data: 3

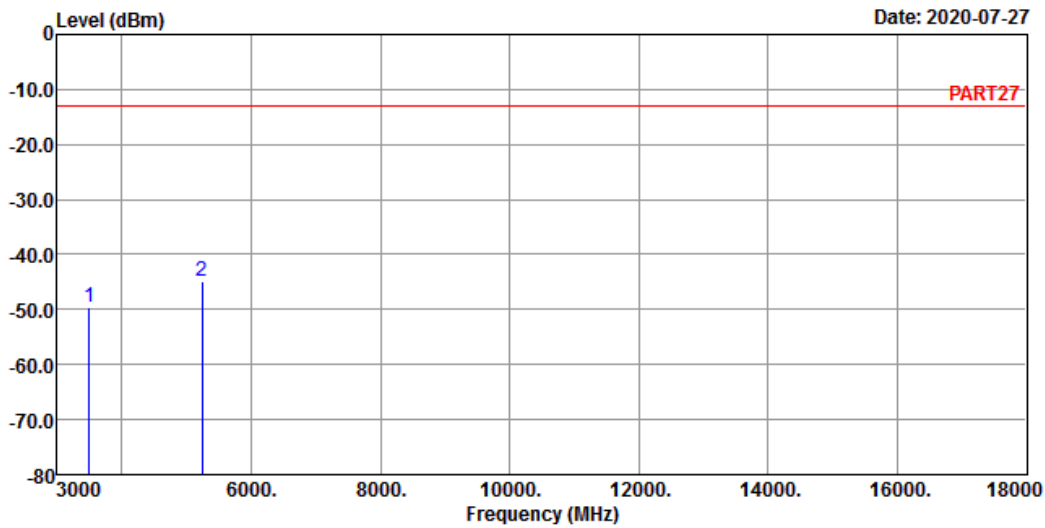

Site : 966 Chamber 5
 Condition: PART27 HORIZONTAL
 Remak : LTE Band 4 QPSK_20M Link_H-CH
 Tested by: Cyril Chen

	Freq	Level	Read Level	Limit Line	Over Factor	Over Limit	Remark
	MHz	dBm	dBm	dBm	dB	dB	
1	3490.00	-49.53	-41.88	-13.00	-7.65	-36.53	Peak
2 pp	5235.00	-44.93	-42.52	-13.00	-2.41	-31.93	Peak



Bureau Veritas Consumer Products Services Ltd., Taoyuan Branch

A D T

Data: 4

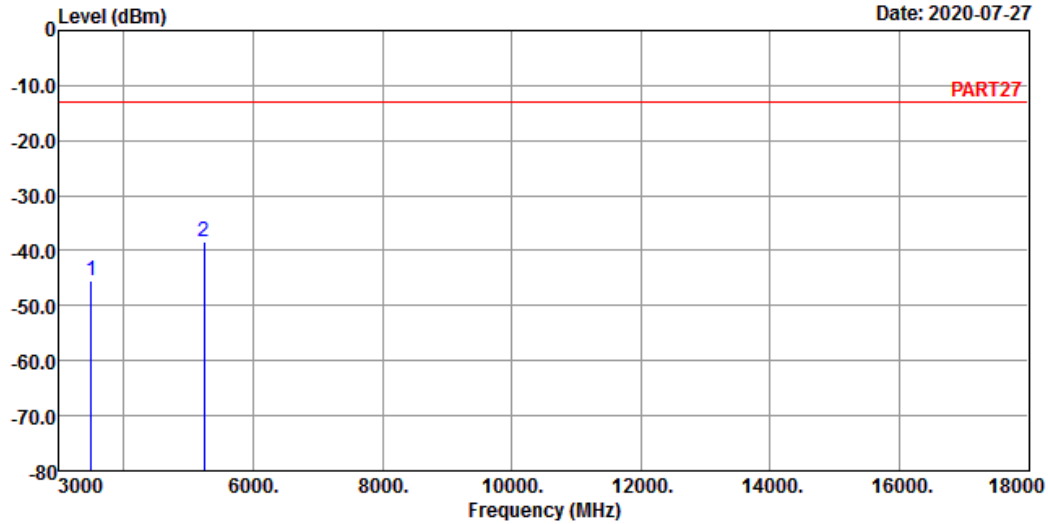

Site : 966 Chamber 5
 Condition: PART27 VERTICAL
 Remak : LTE Band 4 QPSK_20M Link_H-CH
 Tested by: Cyril Chen

	Freq	Level	Read Level	Limit Line	Factor	Over Limit	Remark
	MHz	dBm	dBm	dBm	dB	dB	
1	3490.00	-45.47	-37.82	-13.00	-7.65	-32.47	Peak
2	5235.00	-38.47	-36.06	-13.00	-2.41	-25.47	Peak

LTE Band 12
 Channel Bandwidth: 1.4 MHz / QPSK
 Low Channel



Bureau Veritas Consumer Products Services Ltd., Taoyuan Branch

A D T

Data: 3

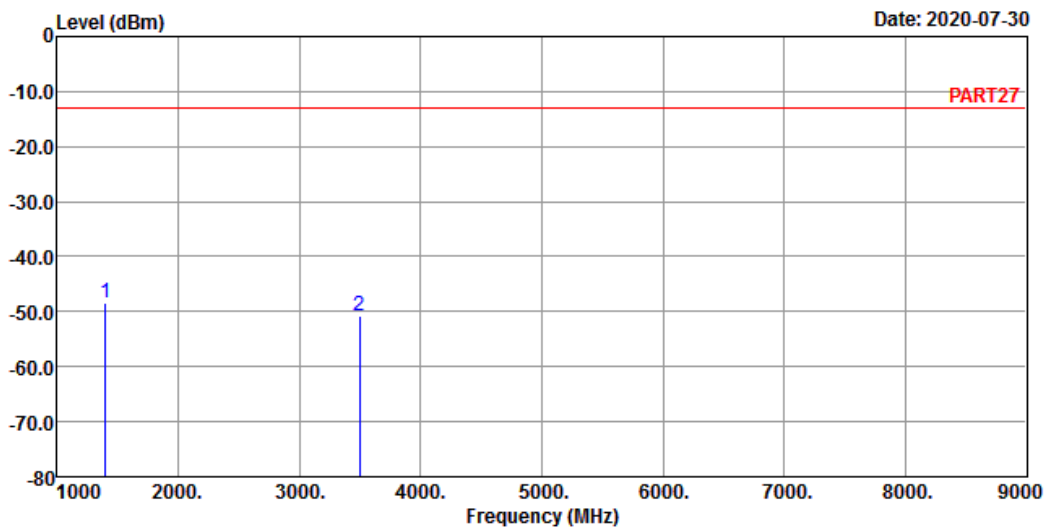

Site : 966 Chamber 5
 Condition: PART27 HORIZONTAL
 Remark : LTE Band 12 QPSK_1.4M Link_L-CH
 Tested by: Cyril Chen

	Freq	Level	Read Level	Limit	Line Factor	Over Limit	Remark
	MHz	dBm	dBm	dBm	dB	dB	
1 pp	1399.40	-48.53	-36.68	-13.00	-11.85	-35.53	Peak
2	3498.50	-50.84	-43.31	-13.00	-7.53	-37.84	Peak



Bureau Veritas Consumer Products Services Ltd., Taoyuan Branch

A D T

Data: 4

Date: 2020-07-30

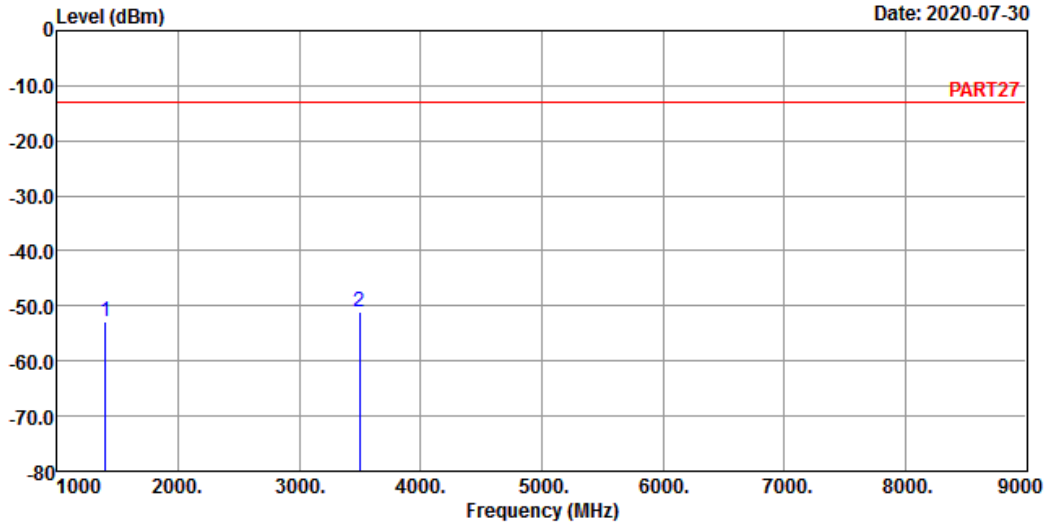

Site : 966 Chamber 5
 Condition: PART27 VERTICAL
 Remak : LTE Band 12 QPSK_1.4M Link_L-CH
 Tested by: Cyril Chen

	Freq	Level	Read Level	Limit Line	Factor	Over Limit	Remark
	MHz	dBm	dBm	dBm	dB	dB	
1	1399.40	-52.81	-40.96	-13.00	-11.85	-39.81	Peak
2	3498.50	-50.98	-43.45	-13.00	-7.53	-37.98	Peak

Middle Channel



Bureau Veritas Consumer Products Services Ltd., Taoyuan Branch

A D T

Data: 3

Date: 2020-07-30

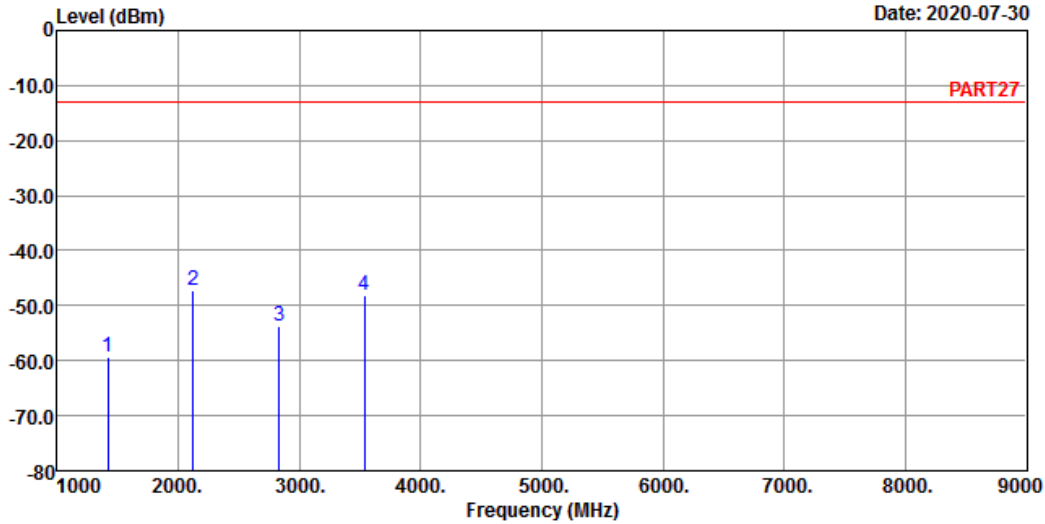

Site : 966 Chamber 5
 Condition: PART27 HORIZONTAL
 Remak : LTE Band 12 QPSK_1.4M Link_M-CH
 Tested by: Cyril Chen

	Freq	Level	Read Level	Limit Line	Over Factor	Over Limit	Remark
	MHz	dBm	dBm	dBm	dB	dB	
1	1415.00	-59.32	-47.24	-13.00	-12.08	-46.32	Peak
2 pp	2122.50	-47.30	-37.43	-13.00	-9.87	-34.30	Peak
3	2830.00	-53.86	-45.38	-13.00	-8.48	-40.86	Peak
4	3537.50	-48.00	-40.78	-13.00	-7.22	-35.00	Peak



Bureau Veritas Consumer Products Services Ltd., Taoyuan Branch

A D T

Data: 4

Date: 2020-07-30

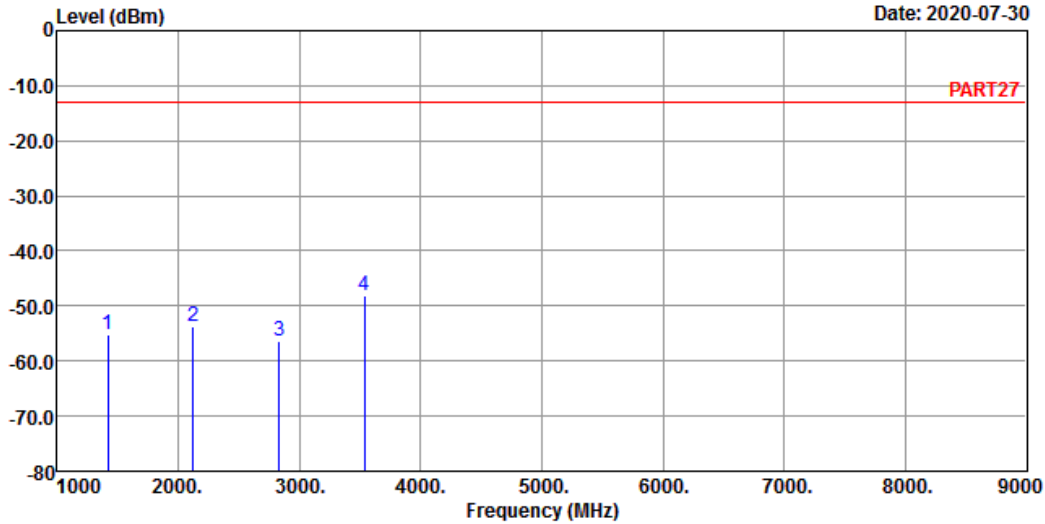

Site : 966 Chamber 5
 Condition: PART27 VERTICAL
 Remak : LTE Band 12 QPSK_1.4M Link_M-CH
 Tested by: Cyril Chen

	Freq	Level	Read Level	Limit Line	Factor	Over Limit	Remark
	MHz	dBm	dBm	dBm	dB	dB	
1	1415.00	-55.29	-43.21	-13.00	-12.08	-42.29	Peak
2	2122.50	-53.79	-43.92	-13.00	-9.87	-40.79	Peak
3	2830.00	-56.44	-47.96	-13.00	-8.48	-43.44	Peak
4 pp	3537.50	-47.99	-40.77	-13.00	-7.22	-34.99	Peak

High Channel



Bureau Veritas Consumer Products Services Ltd., Taoyuan Branch

A D T

Data: 3

Date: 2020-07-30

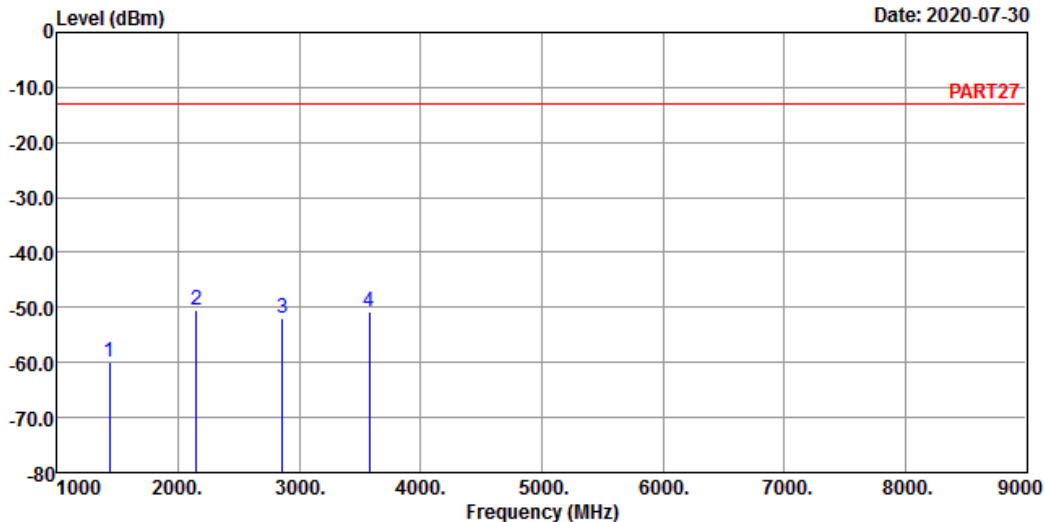

Site : 966 Chamber 5
 Condition: PART27 HORIZONTAL
 Remak : LTE Band 12 QPSK_1.4M Link_H-CH
 Tested by: Cyril Chen

	Freq	Level	Read Level	Limit Line	Over Factor	Over Limit	Remark
	MHz	dBm	dBm	dBm	dB	dB	
1	1430.60	-60.01	-47.70	-13.00	-12.31	-47.01	Peak
2 pp	2145.90	-50.60	-41.13	-13.00	-9.47	-37.60	Peak
3	2861.20	-51.85	-43.42	-13.00	-8.43	-38.85	Peak
4	3576.50	-50.86	-43.87	-13.00	-6.99	-37.86	Peak



Bureau Veritas Consumer Products Services Ltd., Taoyuan Branch

A D T

Data: 4

Date: 2020-07-30

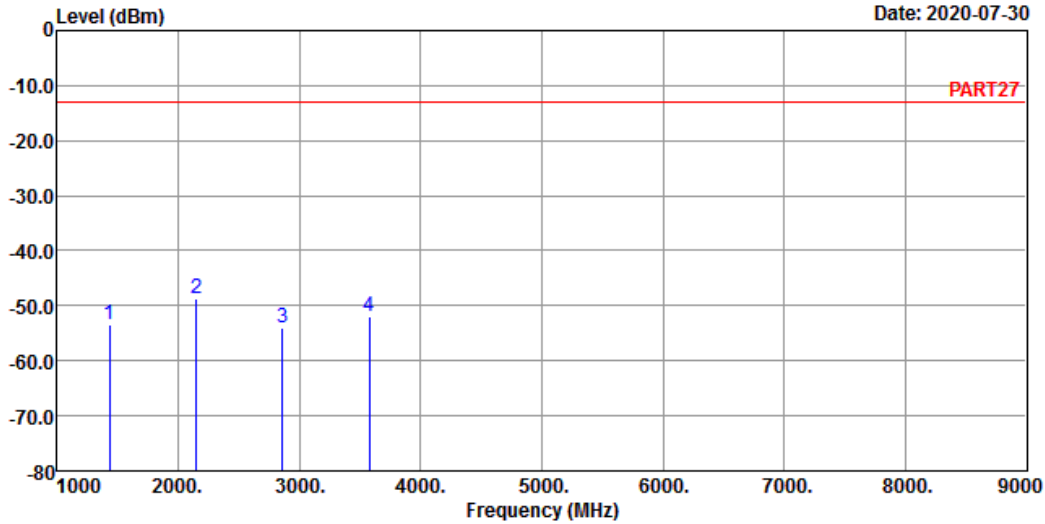

Site : 966 Chamber 5
 Condition: PART27 VERTICAL
 Remak : LTE Band 12 QPSK_1.4M Link_H-CH
 Tested by: Cyril Chen

	Freq	Level	Read Level	Limit Line	Factor	Over Limit	Remark
	MHz	dBm	dBm	dBm	dB	dB	
1	1430.60	-53.36	-41.05	-13.00	-12.31	-40.36	Peak
2	2145.90	-48.79	-39.32	-13.00	-9.47	-35.79	Peak
3	2861.20	-54.16	-45.73	-13.00	-8.43	-41.16	Peak
4	3576.50	-52.04	-45.05	-13.00	-6.99	-39.04	Peak

Channel Bandwidth: 5 MHz / QPSK
Low Channel



Bureau Veritas Consumer Products Services Ltd., Taoyuan Branch

A D T

Data: 3

Date: 2020-07-28

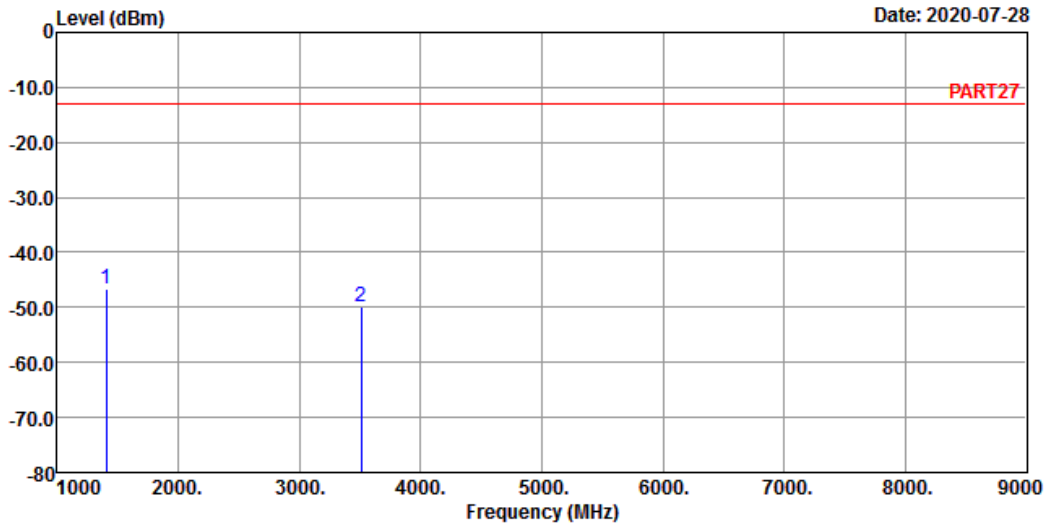

Site : 966 Chamber 5
Condition: PART27 HORIZONTAL
Remak : LTE Band 12 QPSK_5M Link_L-CH
Tested by: Cyril Chen

	Freq	Level	Read Level	Limit	Line Factor	Over Limit	Remark
	MHz	dBm	dBm	dBm	dB	dB	
1 pp	1403.00	-46.53	-34.62	-13.00	-11.91	-33.53	Peak
2	3507.50	-49.84	-42.39	-13.00	-7.45	-36.84	Peak



Bureau Veritas Consumer Products Services Ltd., Taoyuan Branch

A D T

Data: 4

Date: 2020-07-28

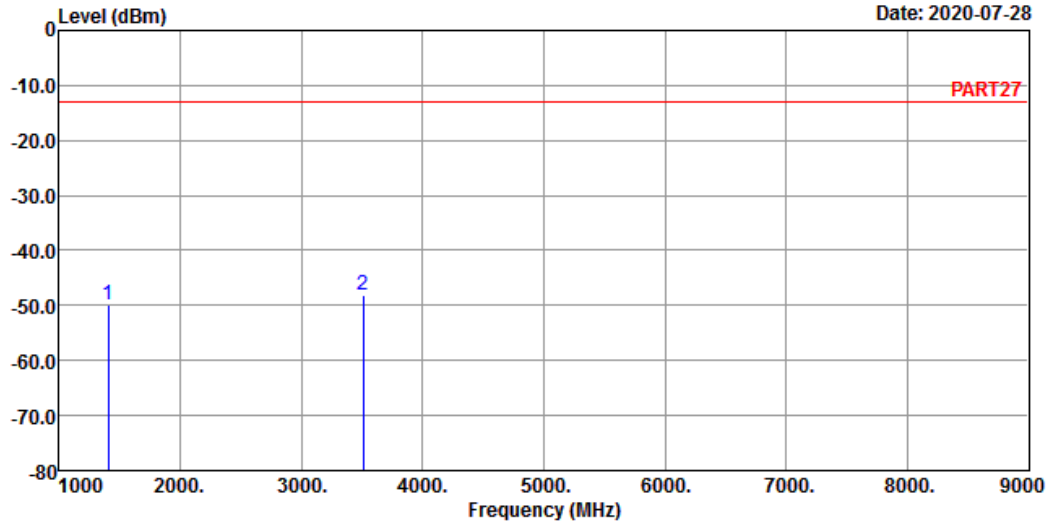

Site : 966 Chamber 5
 Condition: PART27 VERTICAL
 Remak : LTE Band 12 QPSK_5M Link_L-CH
 Tested by: Cyril Chen

	Freq	Level	Read Level	Limit	Line Factor	Over Limit	Remark
	MHz	dBm	dBm	dBm	dB	dB	
1	1403.00	-49.81	-37.90	-13.00	-11.91	-36.81	Peak
2	3507.50	-47.98	-40.53	-13.00	-7.45	-34.98	Peak

Middle Channel



Bureau Veritas Consumer Products Services Ltd., Taoyuan Branch

A D T

Data: 3

Date: 2020-07-28

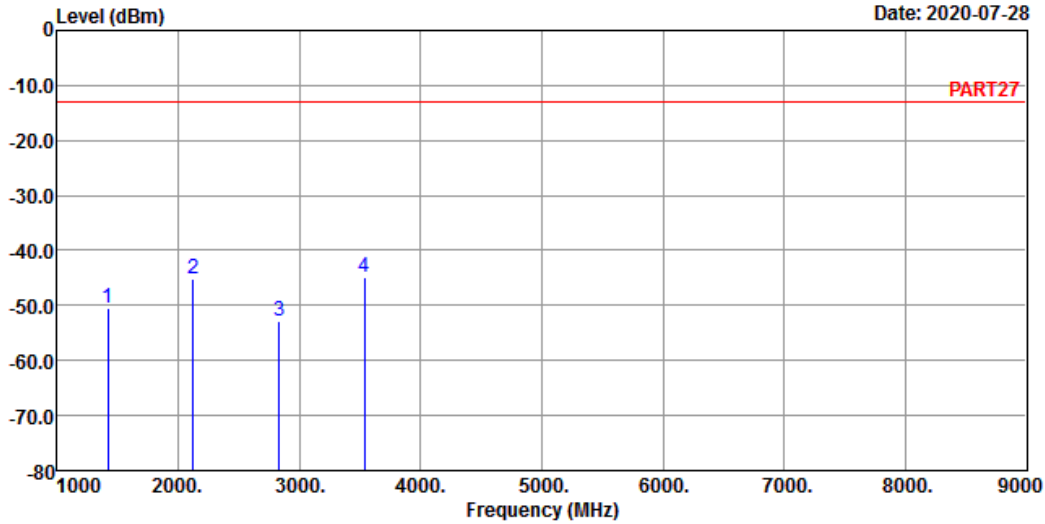

Site : 966 Chamber 5
 Condition: PART27 HORIZONTAL
 Remak : LTE Band 12 QPSK_5M Link_M-CH
 Tested by: Cyril Chen

	Freq	Level	Read Level	Limit Line	Over Factor	Over Limit	Remark
	MHz	dBm	dBm	dBm	dB	dB	
1	1415.00	-50.42	-38.34	-13.00	-12.08	-37.42	Peak
2	2122.50	-45.30	-35.43	-13.00	-9.87	-32.30	Peak
3	2830.00	-52.86	-44.38	-13.00	-8.48	-39.86	Peak
4 pp	3537.50	-44.92	-37.70	-13.00	-7.22	-31.92	Peak



Bureau Veritas Consumer Products Services Ltd., Taoyuan Branch

A D T

Data: 4

Date: 2020-07-28

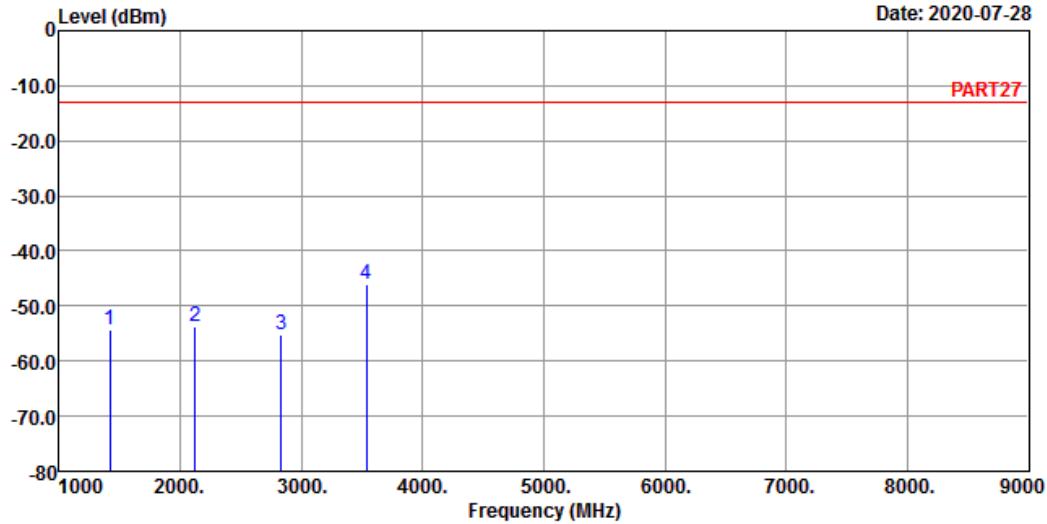

Site : 966 Chamber 5
 Condition: PART27 VERTICAL
 Remak : LTE Band 12 QPSK_5M Link_M-CH
 Tested by: Cyril Chen

	Freq	Level	Read Level	Limit Line	Factor	Over Limit	Remark
	MHz	dBm	dBm	dBm	dB	dB	
1	1415.00	-54.29	-42.21	-13.00	-12.08	-41.29	Peak
2	2122.50	-53.63	-43.76	-13.00	-9.87	-40.63	Peak
3	2830.00	-55.20	-46.72	-13.00	-8.48	-42.20	Peak
4 pp	3537.50	-45.99	-38.77	-13.00	-7.22	-32.99	Peak

High Channel



Bureau Veritas Consumer Products Services Ltd., Taoyuan Branch

A D T

Data: 3

Date: 2020-07-28

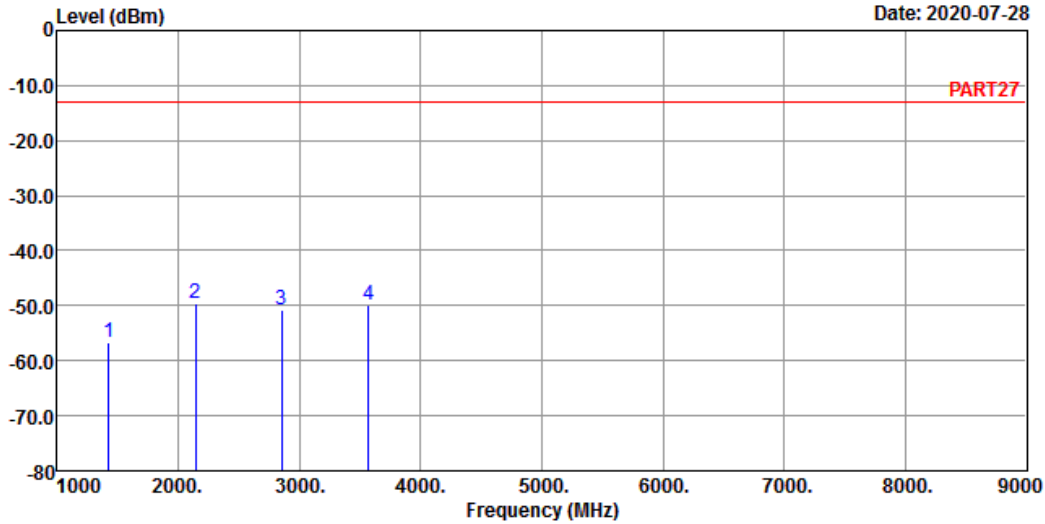

Site : 966 Chamber 5
 Condition: PART27 HORIZONTAL
 Remak : LTE Band 12 QPSK_5M Link_H-CH
 Tested by: Cyril Chen

	Freq	Level	Read Level	Limit Line	Over Factor	Over Limit	Remark
	MHz	dBm	dBm	dBm	dB	dB	
1	1427.00	-56.65	-44.40	-13.00	-12.25	-43.65	Peak
2 pp	2140.50	-49.60	-40.03	-13.00	-9.57	-36.60	Peak
3	2854.00	-50.85	-42.41	-13.00	-8.44	-37.85	Peak
4	3567.50	-49.86	-42.87	-13.00	-6.99	-36.86	Peak



Bureau Veritas Consumer Products Services Ltd., Taoyuan Branch

A D T

Data: 4

Date: 2020-07-28

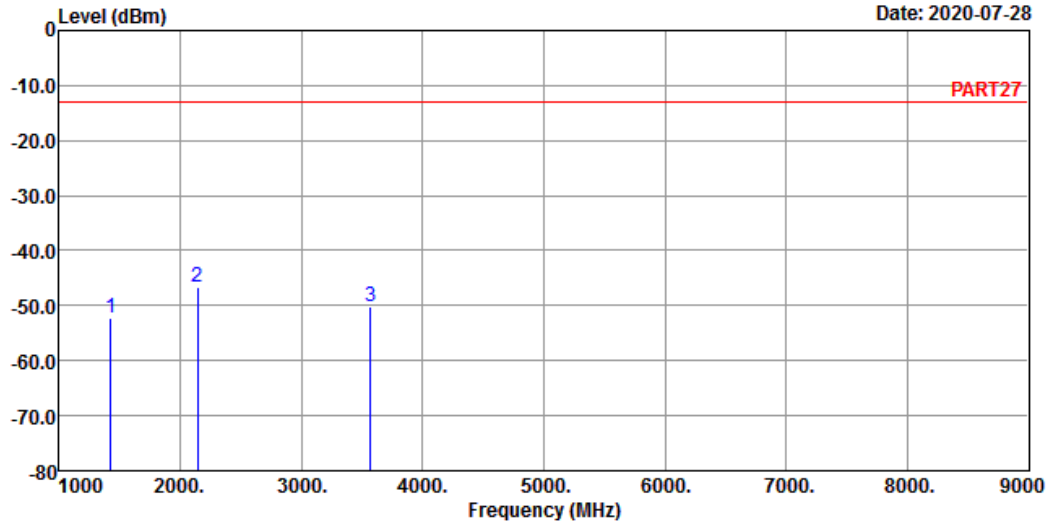

Site : 966 Chamber 5
 Condition: PART27 VERTICAL
 Remak : LTE Band 12 QPSK_5M Link_H-CH
 Tested by: Cyril Chen

	Freq	Level	Read Level	Limit Line	Factor	Over Limit	Remark
	MHz	dBm	dBm	dBm	dB	dB	
1	1427.00	-52.36	-40.11	-13.00	-12.25	-39.36	Peak
2	pp 2140.50	-46.79	-37.22	-13.00	-9.57	-33.79	Peak
3	3567.50	-50.04	-43.05	-13.00	-6.99	-37.04	Peak

Channel Bandwidth: 10 MHz / QPSK
Low Channel



Bureau Veritas Consumer Products Services Ltd., Taoyuan Branch

A D T

Data: 3

Date: 2020-07-28

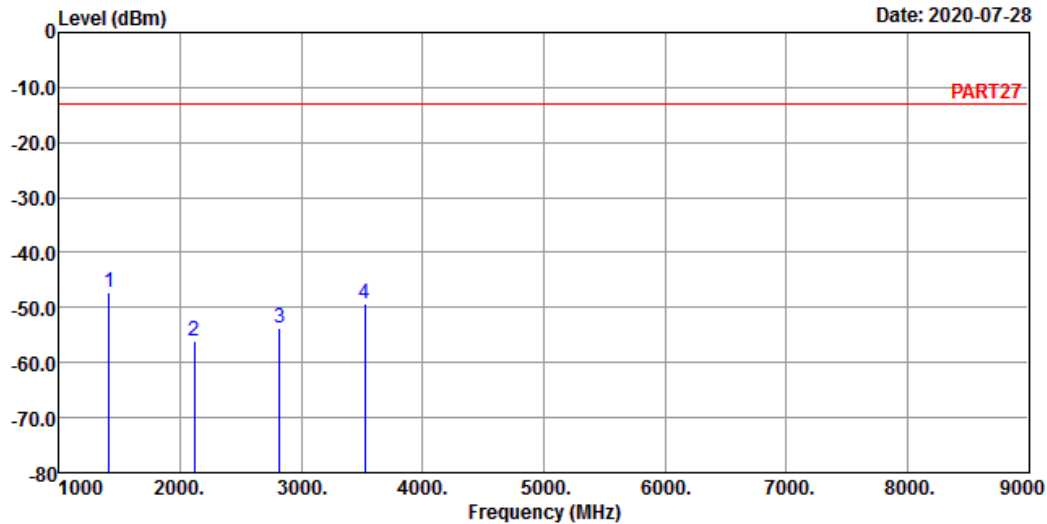

Site : 966 Chamber 5
Condition: PART27 HORIZONTAL
Remak : LTE Band 12 QPSK_10M Link_L-CH
Tested by: Cyril Chen

	Freq	Level	Read Level	Limit	Line Factor	Over Limit	Remark
	MHz	dBm	dBm	dBm	dB	dB	
1 pp	1408.00	-47.21	-35.25	-13.00	-11.96	-34.21	Peak
2	2112.00	-56.20	-46.24	-13.00	-9.96	-43.20	Peak
3	2816.00	-53.82	-45.33	-13.00	-8.49	-40.82	Peak
4	3520.00	-49.24	-41.86	-13.00	-7.38	-36.24	Peak



Bureau Veritas Consumer Products Services Ltd., Taoyuan Branch

A D T

Data: 4

Date: 2020-07-28

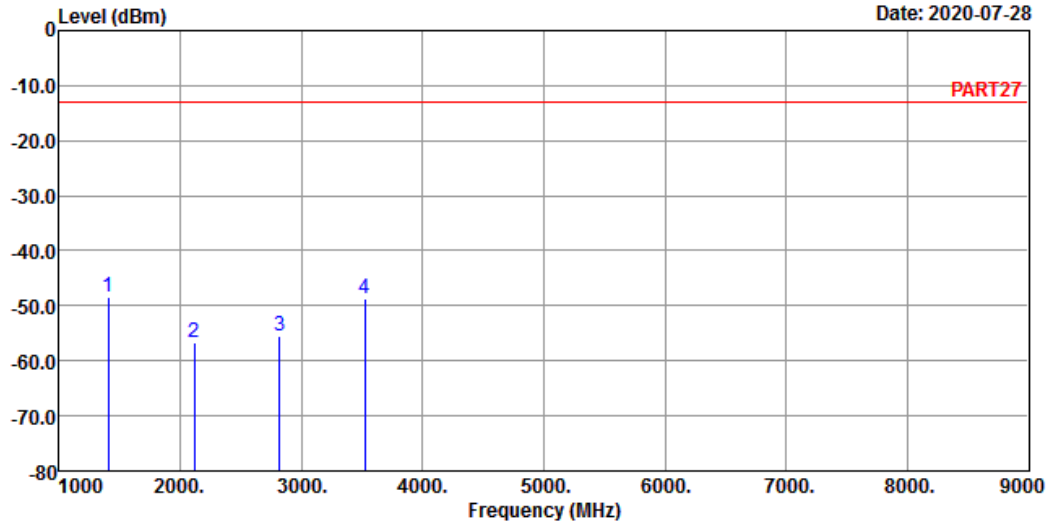

Site : 966 Chamber 5
 Condition: PART27 VERTICAL
 Remak : LTE Band 12 QPSK_10M Link_L-CH
 Tested by: Cyril Chen

	Freq	Level	Read Level	Limit	Line Factor	Over Limit	Remark
	MHz	dBm	dBm	dBm	dB	dB	
1 pp	1406.00	-48.30	-36.34	-13.00	-11.96	-35.30	Peak
2	2112.00	-56.76	-46.80	-13.00	-9.96	-43.76	Peak
3	2816.00	-55.43	-46.94	-13.00	-8.49	-42.43	Peak
4	3520.00	-48.63	-41.25	-13.00	-7.38	-35.63	Peak

Middle Channel



Bureau Veritas Consumer Products Services Ltd., Taoyuan Branch

A D T

Data: 5

Date: 2020-07-28

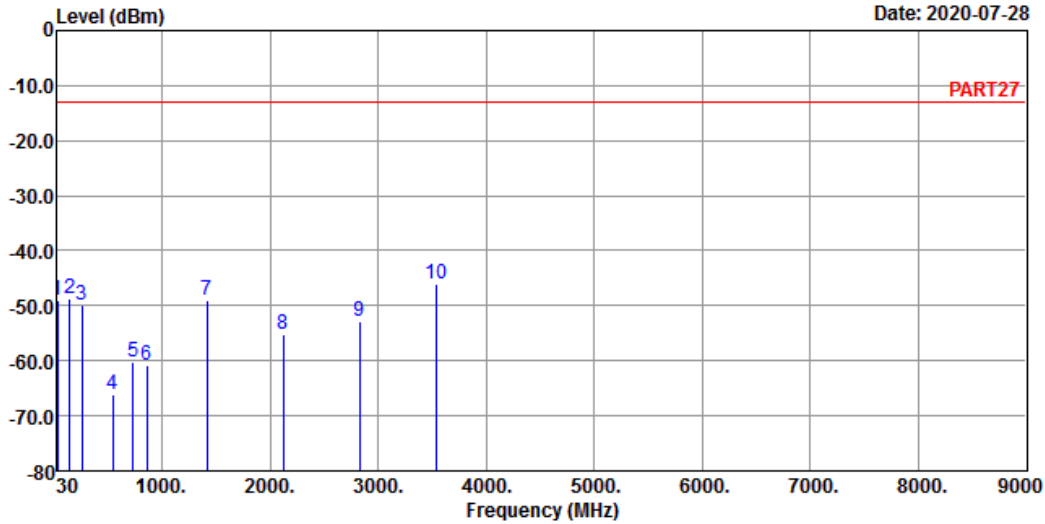

Site : 966 Chamber 5
 Condition: PART27 HORIZONTAL
 Remak : LTE Band 12 QPSK_10M Link_M-CH
 Tested by: Cyril Chen

	Freq	Level	Read Level	Limit	Line Factor	Over Limit	Remark
	MHz	dBm	dBm	dBm	dB	dB	
1	30.00	-49.05	-49.43	-13.00	0.38	-36.05	QP
2	148.34	-48.84	-41.07	-13.00	-7.77	-35.84	QP
3	256.98	-49.90	-43.77	-13.00	-6.13	-36.90	QP
4	547.01	-66.18	-63.23	-13.00	-2.95	-53.18	QP
5	729.37	-60.26	-60.74	-13.00	0.48	-47.26	QP
6	861.29	-60.93	-61.29	-13.00	0.36	-47.93	QP
7	1415.00	-48.92	-36.84	-13.00	-12.08	-35.92	Peak
8	2122.50	-55.10	-45.23	-13.00	-9.87	-42.10	Peak
9	2830.00	-52.72	-44.24	-13.00	-8.48	-39.72	Peak
10	3537.50	-46.13	-38.91	-13.00	-7.22	-33.13	Peak



Bureau Veritas Consumer Products Services Ltd., Taoyuan Branch

A D T

Data: 6

Date: 2020-07-28

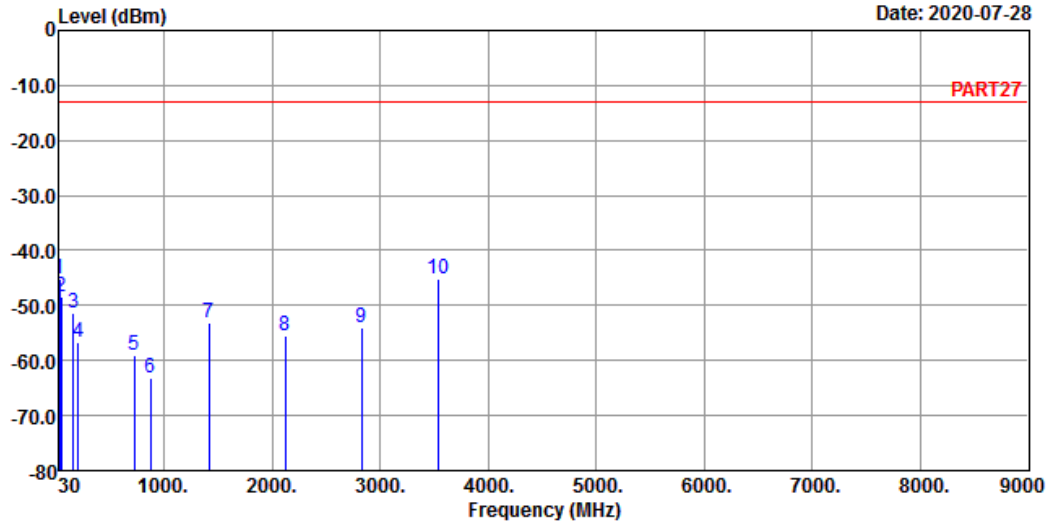

Site : 966 Chamber 5
 Condition: PART27 VERTICAL
 Remak : LTE Band 12 QPSK_10M Link_M-CH
 Tested by: Cyril Chen

	Read	Limit	Over			
Freq	Level	Level	Line	Factor	Limit	Remark
MHz	dBm	dBm	dBm	dB	dB	
1 qp	30.00	-45.17	-45.55	-13.00	0.38	-32.17 QP
2	44.55	-48.47	-46.48	-13.00	-1.99	-35.47 QP
3	158.04	-51.34	-45.95	-13.00	-5.39	-38.34 QP
4	204.60	-56.70	-48.87	-13.00	-7.83	-43.70 QP
5	721.61	-59.18	-59.50	-13.00	0.32	-46.18 QP
6	875.84	-63.17	-63.61	-13.00	0.44	-50.17 QP
7	1415.00	-53.09	-41.01	-13.00	-12.08	-40.09 Peak
8	2122.50	-55.46	-45.59	-13.00	-9.87	-42.46 Peak
9	2830.00	-54.04	-45.56	-13.00	-8.48	-41.04 Peak
10 pp	3537.50	-45.05	-37.83	-13.00	-7.22	-32.05 Peak

High Channel



Bureau Veritas Consumer Products Services Ltd., Taoyuan Branch

A D T

Data: 3

Date: 2020-07-28

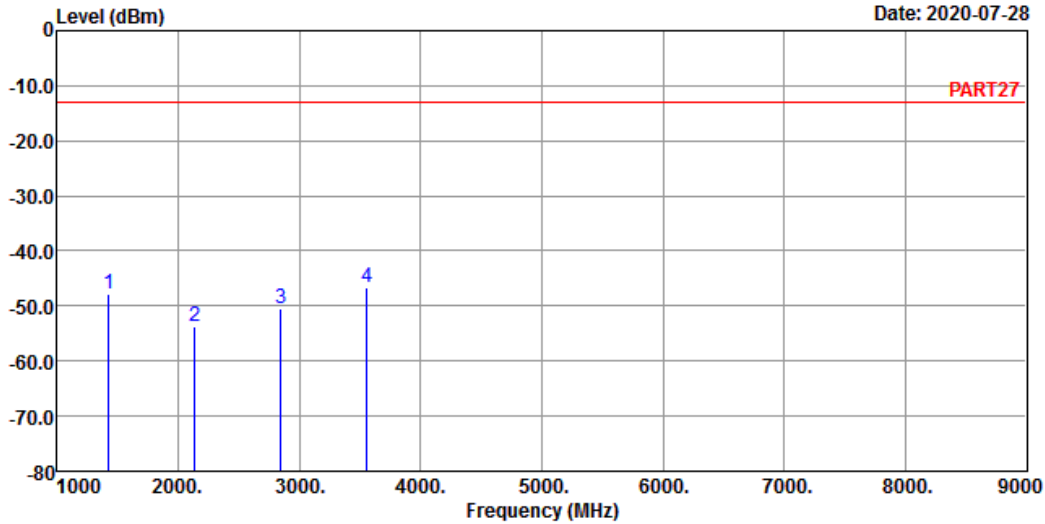

Site : 966 Chamber 5
 Condition: PART27 HORIZONTAL
 Remak : LTE Band 12 QPSK_10M Link_H-CH
 Tested by: Cyril Chen

	Freq	Level	Read Level	Limit	Line Factor	Over Limit	Remark
	MHz	dBm	dBm	dBm	dB	dB	
1	1422.00	-47.97	-35.78	-13.00	-12.19	-34.97	Peak
2	2133.00	-53.82	-44.15	-13.00	-9.67	-40.82	Peak
3	2844.00	-50.40	-41.94	-13.00	-8.46	-37.40	Peak
4 pp	3555.00	-46.69	-39.54	-13.00	-7.15	-33.69	Peak



Bureau Veritas Consumer Products Services Ltd., Taoyuan Branch

A D T

Data: 4

Date: 2020-07-28

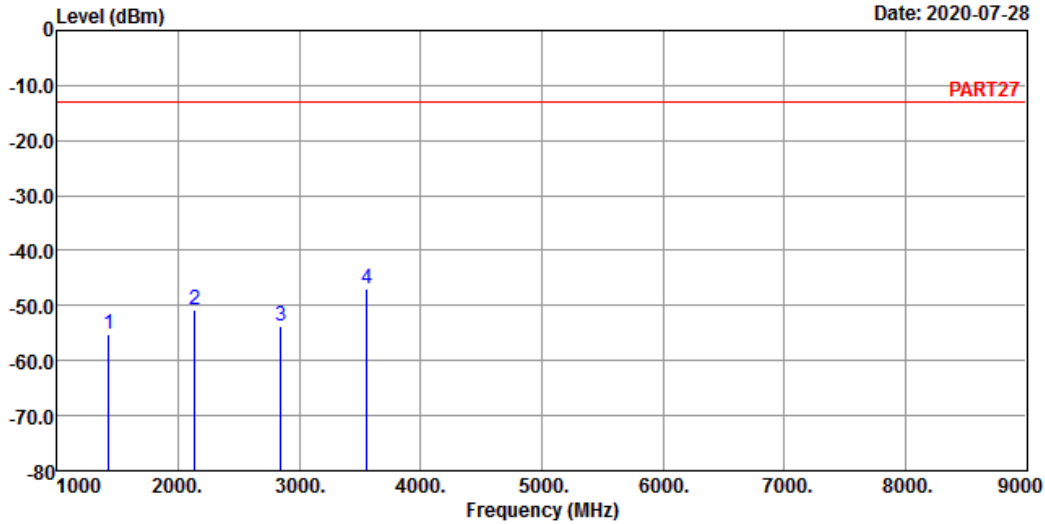

Site : 966 Chamber 5
 Condition: PART27 VERTICAL
 Remak : LTE Band 12 QPSK_10M Link_H-CH
 Tested by: Cyril Chen

	Freq	Level	Read Level	Limit Line	Factor	Over Limit	Remark
	MHz	dBm	dBm	dBm	dB	dB	
1	1422.00	-55.22	-43.03	-13.00	-12.19	-42.22	Peak
2	2133.00	-50.71	-41.04	-13.00	-9.67	-37.71	Peak
3	2844.00	-53.77	-45.31	-13.00	-8.46	-40.77	Peak
4 pp	3555.00	-46.84	-39.69	-13.00	-7.15	-33.84	Peak

5 Pictures of Test Arrangements

Please refer to the attached file (Test Setup Photo).

Appendix – Information of the Testing Laboratories

We, Bureau Veritas Consumer Products Services (H.K.) Ltd., Taoyuan Branch, were founded in 1988 to provide our best service in EMC, Radio, Telecom and Safety consultation. Our laboratories are FCC recognized accredited test firms and accredited according to ISO/IEC 17025.

If you have any comments, please feel free to contact us at the following:

Lin Kou EMC/RF Lab

Tel: 886-2-26052180

Fax: 886-2-26051924

Hsin Chu EMC/RF/Telecom Lab

Tel: 886-3-6668565

Fax: 886-3-6668323

Hwa Ya EMC/RF/Safety Lab

Tel: 886-3-3183232

Fax: 886-3-3270892

Email: service.adt@tw.bureauveritas.com

Web Site: www.bureauveritas-adt.com

The address and road map of all our labs can be found in our web site also.

--- END ---