

## FCC Test Report (5GHz WLAN)

**Report No.:** RF200709D02-4

**FCC ID:** 2AK5B-HB1

**Test Model:** HB1LW1NA1

**Received Date:** Jul. 9, 2020

**Test Date:** Jul. 10 to Aug. 17, 2020

**Issued Date:** Aug. 20, 2020

**Applicant:** Latchable, Inc.

**Address:** 508 West 26th Street Suite 6G New York, NY 10001

**Issued By:** Bureau Veritas Consumer Products Services (H.K.) Ltd., Taoyuan Branch  
Lin Kou Laboratories

**Lab Address:** No. 47-2, 14th Ling, Chia Pau Vil., Lin Kou Dist., New Taipei City, Taiwan

**FCC Registration /  
Designation Number:** 198487 / TW2021



This report is for your exclusive use. Any copying or replication of this report to or for any other person or entity, or use of our name or trademark, is permitted only with our prior written permission. This report sets forth our findings solely with respect to the test samples identified herein. The results set forth in this report are not indicative or representative of the quality or characteristics of the lot from which a test sample was taken or any similar or identical product unless specifically and expressly noted. Our report includes all of the tests requested by you and the results thereof based upon the information that you provided to us. You have 60 days from date of issuance of this report to notify us of any material error or omission caused by our negligence, provided, however, that such notice shall be in writing and shall specifically address the issue you wish to raise. A failure to raise such issue within the prescribed time shall constitute your unqualified acceptance of the completeness of this report, the tests conducted and the correctness of the report contents. Unless specifically mentioned, the uncertainty of measurement has been explicitly taken into account to declare the compliance or non-compliance to the specification.

## Table of Contents

<b>Release Control Record</b> .....	<b>4</b>
<b>1 Certificate of Conformity</b> .....	<b>5</b>
<b>2 Summary of Test Results</b> .....	<b>6</b>
2.1 Measurement Uncertainty.....	6
2.2 Modification Record.....	6
<b>3 General Information</b> .....	<b>7</b>
3.1 General Description of EUT.....	7
3.2 Description of Test Modes.....	9
3.2.1 Test Mode Applicability and Tested Channel Detail.....	10
3.3 Duty Cycle of Test Signal.....	12
3.4 Description of Support Units.....	13
3.4.1 Configuration of System under Test.....	13
3.5 General Description of Applied Standard and References.....	14
<b>4 Test Types and Results</b> .....	<b>15</b>
4.1 Radiated Emission and Bandedge Measurement.....	15
4.1.1 Limits of Radiated Emission and Bandedge Measurement.....	15
4.1.2 Test Instruments.....	16
4.1.3 Test Procedure.....	17
4.1.4 Deviation from Test Standard.....	17
4.1.5 Test Setup.....	18
4.1.6 EUT Operating Condition.....	19
4.1.7 Test Results.....	20
4.2 Conducted Emission Measurement.....	40
4.2.1 Limits of Conducted Emission Measurement.....	40
4.2.2 Test Instruments.....	40
4.2.3 Test Procedure.....	41
4.2.4 Deviation from Test Standard.....	41
4.2.5 Test Setup.....	41
4.2.6 EUT Operating Condition.....	41
4.2.7 Test Results.....	42
4.3 Transmit Power Measurement.....	44
4.3.1 Limits of Transmit Power Measurement.....	44
4.3.2 Test Setup.....	45
4.3.3 Test Instruments.....	45
4.3.4 Test Procedure.....	45
4.3.5 Deviation from Test Standard.....	45
4.3.6 EUT Operating Condition.....	45
4.3.7 Test Result.....	46
4.4 Occupied Bandwidth Measurement.....	47
4.4.1 Test Setup.....	47
4.4.2 Test Instruments.....	47
4.4.3 Test Procedure.....	47
4.4.4 Test Results.....	48
4.5 Peak Power Spectral Density Measurement.....	52
4.5.1 Limits of Peak Power Spectral Density Measurement.....	52
4.5.2 Test Setup.....	52
4.5.3 Test Instruments.....	52
4.5.4 Test Procedure.....	52
4.5.5 Deviation from Test Standard.....	52
4.5.6 EUT Operating Condition.....	52
4.5.7 Test Results.....	53
4.6 Frequency Stability Measurement.....	58

4.6.1	Limits of Frequency Stability Measurement .....	58
4.6.2	Test Setup.....	58
4.6.3	Test Instruments .....	58
4.6.4	Test Procedure .....	58
4.6.5	Deviation from Test Standard .....	58
4.6.6	EUT Operating Condition .....	58
4.6.7	Test Results .....	59
4.7	6dB Bandwidth Measurement.....	60
4.7.1	Limits of 6dB Bandwidth Measurement.....	60
4.7.2	Test Setup.....	60
4.7.3	Test Instruments .....	60
4.7.4	Test Procedure .....	60
4.7.5	Deviation from Test Standard .....	60
4.7.6	EUT Operating Condition .....	60
4.7.7	Test Results .....	61
<b>5</b>	<b>Pictures of Test Arrangements.....</b>	<b>63</b>
	<b>Annex A- Radiated Out of Band Emission (OOBE) Measurement (For U-NII-3 band).....</b>	<b>64</b>
	<b>Annex B- Band Edge Measurement.....</b>	<b>67</b>
	<b>Appendix – Information of the Testing Laboratories .....</b>	<b>71</b>

### Release Control Record

Issue No.	Description	Date Issued
RF200709D02-4	Original release.	Aug. 20, 2020

## 1 Certificate of Conformity

**Product:** Hub

**Brand:** LATCH

**Test Model:** HB1LW1NA1

**Sample Status:** Engineering sample

**Applicant:** Latchable, Inc.

**Test Date:** Jul. 10 to Aug. 17, 2020

**Standard:** 47 CFR FCC Part 15, Subpart E (Section 15.407)  
ANSI C63.10: 2013

The above equipment has been tested by **Bureau Veritas Consumer Products Services (H.K.) Ltd., Taoyuan Branch**, and found compliance with the requirement of the above standards. The test record, data evaluation & Equipment Under Test (EUT) configurations represented herein are true and accurate accounts of the measurements of the sample's RF characteristics under the conditions specified in this report.

**Prepared by :** Celia Chen , **Date:** Aug. 20, 2020  
Celia Chen / Supervisor

**Approved by :** Rex Lai , **Date:** Aug. 20, 2020  
Rex Lai / Associate Technical Manager

## 2 Summary of Test Results

47 CFR FCC Part 15, Subpart E (Section 15.407)			
FCC Clause	Test Item	Result	Remarks
15.407(b)(6)	AC Power Conducted Emissions	Pass	Meet the requirement of limit. Minimum passing margin is -13.72dB at 0.34141MHz.
15.407(b)(1/2/3/4(i/ii)/6)	Radiated Emissions & Band Edge Measurement	Pass	Meet the requirement of limit. Minimum passing margin is -1.00dB at 5924.68MHz.
15.407(a)(1/2/3)	Max Average Transmit Power	Pass	Meet the requirement of limit.
---	Occupied Bandwidth Measurement	Reference only.	
15.407(a)(1/2/3)	Peak Power Spectral Density	Pass	Meet the requirement of limit.
15.407(e)	6dB bandwidth	Pass	Meet the requirement of limit. (U-NII-3 Band only)
15.407(g)	Frequency Stability	Pass	Meet the requirement of limit.
15.203	Antenna Requirement	Pass	Antenna connector is I-PEX not a standard connector.

### Note:

- Determining compliance based on the results of the compliance measurement, not taking into account measurement instrumentation uncertainty.
- For U-NII-3 band compliance with rule part 15.407(b)(4)(i), the OOB test plots were recorded in Annex A.
- For U-NII-1 band compliance with rule 15.407(b) of the band-edge items, the test plots were recorded in Annex B. Test Procedures refer to report 4.1.3.

### 2.1 Measurement Uncertainty

Where relevant, the following measurement uncertainty levels have been estimated for tests performed on the EUT as specified in CISPR 16-4-2:

Measurement	Frequency	Expanded Uncertainty (k=2) ( $\pm$ )
Conducted Emissions at mains ports	150kHz ~ 30MHz	3.00 dB
Conducted Emissions	9kHz ~ 40GHz	2.63 dB
Radiated Emissions up to 1 GHz	9kHz ~ 30MHz	2.61 dB
	30MHz ~ 1GHz	5.43 dB
Radiated Emissions above 1 GHz	Above 1GHz	5.42 dB

### 2.2 Modification Record

There were no modifications required for compliance.

### 3 General Information

#### 3.1 General Description of EUT

Product	Hub
Brand	LATCH
Test Model	HB1LW1NA1
Status of EUT	Engineering sample
Power Supply Rating	12Vdc from adapter or 7.5Vdc from battery
Modulation Type	256QAM, 64QAM, 16QAM, QPSK, BPSK
Modulation Technology	OFDM
Transfer Rate	802.11a: up to 54Mbps 802.11n: up to 300Mbps 802.11ac: up to 866.7Mbps
Operating Frequency	5180 ~ 5240MHz, 5745 ~ 5825MHz
Number of Channel	<b>5180 ~ 5240MHz</b> 802.11a, 802.11n (20MHz), 802.11ac (20MHz): 4 802.11n (40MHz), 802.11ac (40MHz): 2 802.11ac (80MHz): 1 <b>5745 ~ 5825MHz</b> 802.11a, 802.11n (20MHz), 802.11ac (20MHz): 5 802.11n (40MHz), 802.11ac (40MHz): 2 802.11ac (80MHz): 1
Output Power	<b>5180 ~ 5240MHz:</b> 71.703mW <b>5745 ~ 5825MHz:</b> 241.053mW
Antenna Type	<b>5180 ~ 5240MHz:</b> Ant. 4: Dipole Antenna with 3.3dBi gain Ant. 5: Dipole Antenna with 3.1dBi gain <b>5745 ~ 5825MHz:</b> Ant. 4: Dipole Antenna with 2.5dBi gain Ant. 5: Dipole Antenna with 2.4dBi gain
Antenna Connector	I-PEX
Accessory Device	Adapter
Data Cable Supplied	N/A

Note:

- The EUT provides 2 completed transmitters and 2 receivers.

Modulation Mode	TX FUNCTION
802.11a	2TX
802.11n (20MHz)	2TX
802.11n (40MHz)	2TX
802.11ac (20MHz)	2TX
802.11ac (40MHz)	2TX
802.11ac (80MHz)	2TX

\* The modulation and bandwidth are similar for 802.11n mode for 20MHz (40MHz) and 802.11ac mode for 20MHz (40MHz), therefore investigated worst case to representative mode in test report. (Final test mode refer section 3.2.1)

2. The EUT was pre-tested with the following modes:

- ✧ Operating Mode (EUT + Battery)
- ✧ Operating + Charging Mode (EUT + Adapter)

The worst emission level was found when the EUT tested under **Operating + Charging Mode (EUT + Adapter)**, therefore, only its test data was recorded in this report.

3. The EUT uses following adapter or battery.

Item	Adapter	Battery
Brand	APD	Simplo
Model	WB-24J12FU	NA50X
AC I/P Rating	100-240V, 50-60Hz, 0.7A	-
DC O/P Rating	12V, 2A	7.5V, 2500mAh, 18Wh
Power cord	AC 2 Pin, Non-shielded DC cable (1.5m)	-

4. 2.4GHz & 5GHz WLAN technologies cannot transmit at same time.

WCDMA & LTE technologies cannot transmit at same time.

WLAN, WWAN, Bluetooth, Zigbee & Z-Wave technologies can transmit at same time.

5. The above Antenna information is declared by manufacturer and for more detailed features description, please refer to the manufacturer's specifications, the laboratory shall not be held responsible.

6. The above EUT information is declared by manufacturer and for more detailed features description, please refers to the manufacturer's specifications or user's manual.



### 3.2 Description of Test Modes

#### 5180~5240MHz:

4 channels are provided for 802.11a, 802.11n (20MHz), 802.11ac (20MHz):

Channel	Frequency	Channel	Frequency
36	5180 MHz	44	5220 MHz
40	5200 MHz	48	5240 MHz

2 channels are provided for 802.11n (40MHz), 802.11ac (40MHz):

Channel	Frequency	Channel	Frequency
38	5190 MHz	46	5230 MHz

1 channel is provided for 802.11ac (80MHz):

Channel	Frequency
42	5210MHz

#### 5745~5825MHz:

5 channels are provided for 802.11a, 802.11n (20MHz), 802.11ac (20MHz):

Channel	Frequency	Channel	Frequency
149	5745MHz	161	5805MHz
153	5765MHz	165	5825MHz
157	5785MHz		

2 channels are provided for 802.11n (40MHz), 802.11ac (40MHz):

Channel	Frequency	Channel	Frequency
151	5755MHz	159	5795MHz

1 channel is provided for 802.11ac (80MHz):

Channel	Frequency
155	5775MHz

### 3.2.1 Test Mode Applicability and Tested Channel Detail

EUT Configure Mode	Applicable To				Description
	RE≥1G	RE<1G	PLC	APCM	
-	√	√	√	√	Operating + Charging Mode (EUT + Adapter)

Where **RE≥1G**: Radiated Emission above 1GHz      **RE<1G**: Radiated Emission below 1GHz  
**PLC**: Power Line Conducted Emission      **APCM**: Antenna Port Conducted Measurement

**NOTE:** The EUT had been pre-tested on the positioned of each 3 axis. The worst case was found when positioned on **Z-plane**.

#### **Radiated Emission Test (Above 1GHz):**

- Pre-Scan has been conducted to determine the worst-case mode from all possible combinations between available modulations, data rates and antenna ports (if EUT with antenna diversity architecture).
- Following channel(s) was (were) selected for the final test as listed below.

EUT Configure Mode	Mode	Frequency Band (MHz)	Available Channel	Tested Channel	Modulation Technology	Data Rate (Mbps)
-	802.11a	5180-5240	36 to 48	36, 40, 48	OFDM	6.0
	802.11ac (20MHz)		36 to 48	36, 40, 48	OFDM	6.5
	802.11ac (40MHz)		38 to 46	38, 46	OFDM	13.5
	802.11ac (80MHz)		42	42	OFDM	29.3
-	802.11a	5745-5825	149 to 165	149, 157, 165	OFDM	6.0
	802.11ac (20MHz)		149 to 165	149, 157, 165	OFDM	6.5
	802.11ac (40MHz)		151 to 159	151, 159	OFDM	13.5
	802.11ac (80MHz)		155	155	OFDM	29.3

#### **Radiated Emission Test (Below 1GHz):**

- Pre-Scan has been conducted to determine the worst-case mode from all possible combinations between available modulations, data rates and antenna ports (if EUT with antenna diversity architecture).
- Following channel(s) was (were) selected for the final test as listed below.

EUT Configure Mode	Mode	Frequency Band (MHz)	Available Channel	Tested Channel	Modulation Technology	Data Rate (Mbps)
-	802.11a	5180-5240	36 to 48	165	OFDM	6.0
-	802.11a	5745-5825	149 to 165		OFDM	6.0

#### **Power Line Conducted Emission Test:**

- Pre-Scan has been conducted to determine the worst-case mode from all possible combinations between available modulations, data rates and antenna ports (if EUT with antenna diversity architecture).
- Following channel(s) was (were) selected for the final test as listed below.

EUT Configure Mode	Mode	Frequency Band (MHz)	Available Channel	Tested Channel	Modulation Technology	Data Rate (Mbps)
-	802.11a	5180-5240	36 to 48	165	OFDM	6.0
-	802.11a	5745-5825	149 to 165		OFDM	6.0

**Antenna Port Conducted Measurement:**

- This item includes all test value of each mode, but only includes spectrum plot of worst value of each mode.
- Pre-Scan has been conducted to determine the worst-case mode from all possible combinations between available modulations, data rates and antenna ports (if EUT with antenna diversity architecture).
- Following channel(s) was (were) selected for the final test as listed below.

EUT Configure Mode	Mode	Frequency Band (MHz)	Available Channel	Tested Channel	Modulation Technology	Data Rate (Mbps)
-	802.11a	5180-5240	36 to 48	36, 40, 48	OFDM	6.0
	802.11ac (20MHz)		36 to 48	36, 40, 48	OFDM	6.5
	802.11ac (40MHz)		38 to 46	38, 46	OFDM	13.5
	802.11ac (80MHz)		42	42	OFDM	29.3
-	802.11a	5745-5825	149 to 165	149, 157, 165	OFDM	6.0
	802.11ac (20MHz)		149 to 165	149, 157, 165	OFDM	6.5
	802.11ac (40MHz)		151 to 159	151, 159	OFDM	13.5
	802.11ac (80MHz)		155	155	OFDM	29.3

**Test Condition:**

Applicable To	Environmental Conditions	Input Power	Tested By
<b>RE≥1G</b>	22deg. C, 69%RH	120Vac, 60Hz	Dalen Dai
<b>RE&lt;1G</b>	22deg. C, 69%RH	120Vac, 60Hz	Ian Chang
<b>PLC</b>	25deg. C, 75%RH	120Vac, 60Hz	Ian Chang
<b>APCM</b>	25deg. C, 76%RH	120Vac, 60Hz	Saxon Lee

### 3.3 Duty Cycle of Test Signal

Duty cycle of test signal is < 98%, duty factor shall be considered.

**802.11a:** Duty cycle = 2.094/2.275 = 0.92, Duty factor =  $10 * \log(1/0.92) = 0.36$

**802.11ac (20MHz):** Duty cycle = 1.944/2.072 = 0.938, Duty factor =  $10 * \log(1/0.938) = 0.28$

**802.11ac (40MHz):** Duty cycle = 0.96/1.206 = 0.796, Duty factor =  $10 * \log(1/0.796) = 0.99$

**802.11ac (80MHz):** Duty cycle = 0.476/0.634 = 0.751, Duty factor =  $10 * \log(1/0.751) = 1.24$

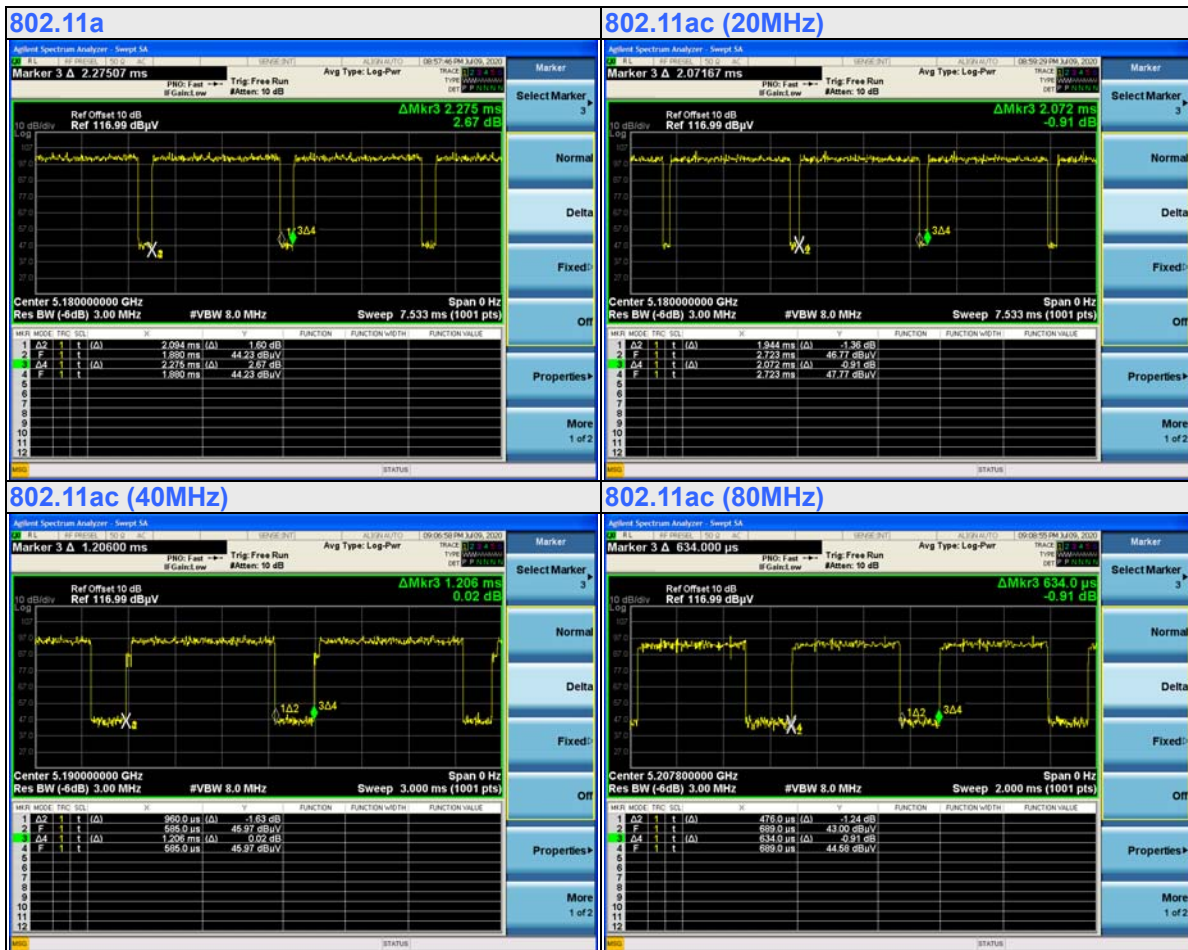

### 3.4 Description of Support Units

The EUT has been tested as an independent unit together with other necessary accessories or support units. The following support units or accessories were used to form a representative test configuration during the tests.

ID	Product	Brand	Model No.	Serial No.	FCC ID	Remarks
A.	Notebook PC	ASUS	PU401L	E9NXBC002007372	NA	Provided by Lab

Note:

1. All power cords of the above support units are non-shielded (1.8m).
2. Item A acted as communication partners to transfer data.

ID	Cable Descriptions	Qty.	Length (m)	Shielding (Yes/ No)	Cores (Qty.)	Remarks
1.	DC cable	1	1.5	N	0	Supplied by client
2.	LAN cable	1	10	N	0	Provided by Lab (RJ45, Cat.5e)

Note: The core(s) is(are) originally attached to the cable(s).

#### 3.4.1 Configuration of System under Test

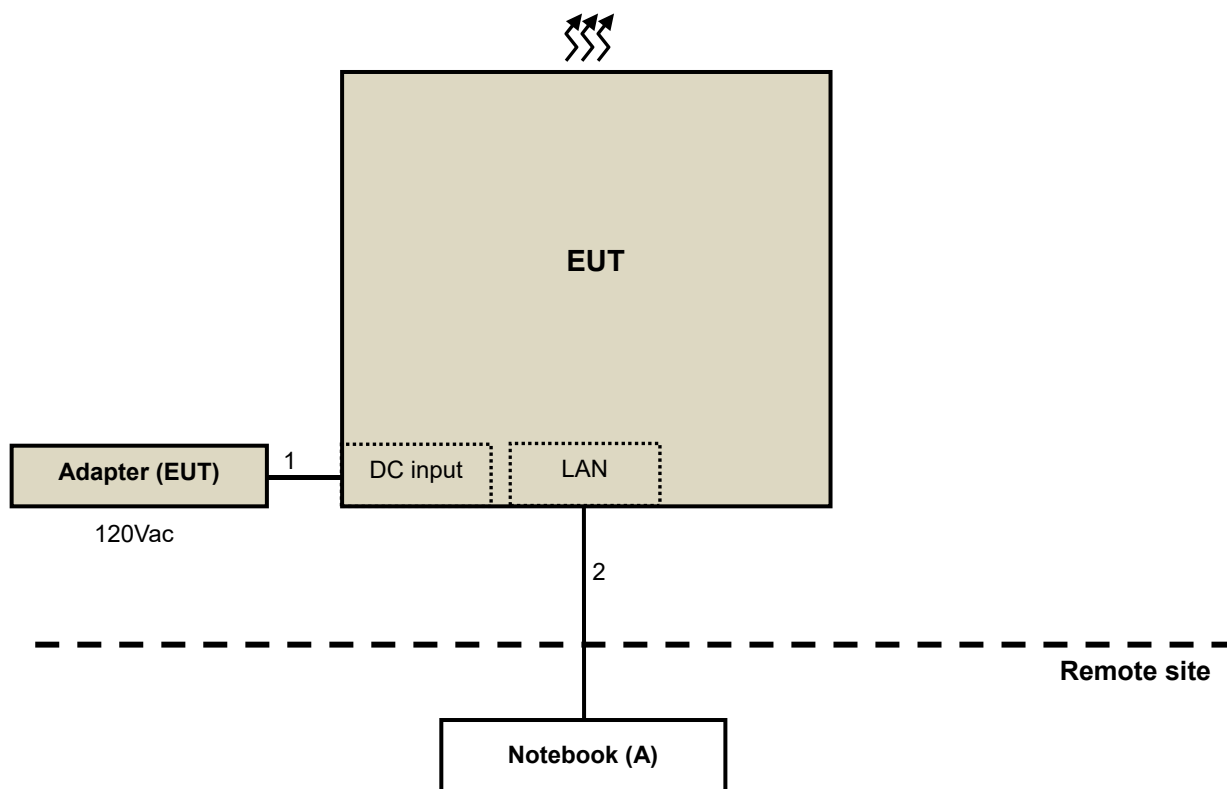

### 3.5 General Description of Applied Standard and References

The EUT is a RF Product. According to the specifications of the manufacturer, it must comply with the requirements of the following standards and references:

**Test standard:**

**FCC Part 15, Subpart E (15.407)**  
**ANSI C63.10-2013**

All test items have been performed and recorded as per the above standards.

**References Test Guidance:**

**KDB 789033 D02 General UNII Test Procedure New Rules v02r01**  
**KDB 662911 D01 Multiple Transmitter Output v02r01**

All test items have been performed as a reference to the above KDB test guidance.

## 4 Test Types and Results

### 4.1 Radiated Emission and Bandedge Measurement

#### 4.1.1 Limits of Radiated Emission and Bandedge Measurement

Radiated emissions which fall in the restricted bands must comply with the radiated emission limits specified as below table.

Frequencies (MHz)	Field Strength (microvolts/meter)	Measurement Distance (meters)
0.009 ~ 0.490	2400/F(kHz)	300
0.490 ~ 1.705	24000/F(kHz)	30
1.705 ~ 30.0	30	30
30 ~ 88	100	3
88 ~ 216	150	3
216 ~ 960	200	3
Above 960	500	3

#### NOTE:

- The lower limit shall apply at the transition frequencies.
- Emission level (dBuV/m) = 20 log Emission level (uV/m).
- For frequencies above 1000MHz, the field strength limits are based on average detector, however, the peak field strength of any emission shall not exceed the maximum permitted average limits, specified above by more than 20dB under any condition of modulation.

#### Limits of unwanted emission out of the restricted bands

Applicable To		Limit	
789033 D02 General UNII Test Procedure New Rules v02r01		Field Strength at 3m	
		PK:74 (dBµV/m)	AV:54 (dBµV/m)
Frequency Band	Applicable To	EIRP Limit	Equivalent Field Strength at 3m
5150~5250 MHz	15.407(b)(1)	PK:-27 (dBm/MHz)	PK:68.2(dBµV/m)
5250~5350 MHz	15.407(b)(2)		
5470~5725 MHz	15.407(b)(3)		
5725~5850 MHz	<input checked="" type="checkbox"/> 15.407(b)(4)(i)	PK:-27 (dBm/MHz) <sup>*1</sup> PK:10 (dBm/MHz) <sup>*2</sup> PK:15.6 (dBm/MHz) <sup>*3</sup> PK:27 (dBm/MHz) <sup>*4</sup>	PK: 68.2(dBµV/m) <sup>*1</sup> PK:105.2 (dBµV/m) <sup>*2</sup> PK: 110.8(dBµV/m) <sup>*3</sup> PK:122.2 (dBµV/m) <sup>*4</sup>
	<input type="checkbox"/> 15.407(b)(4)(ii)	Emission limits in section 15.247(d)	
<sup>*1</sup> beyond 75 MHz or more above of the band edge. <sup>*3</sup> below the band edge increasing linearly to a level of 15.6 dBm/MHz at 5 MHz above.		<sup>*2</sup> below the band edge increasing linearly to 10 dBm/MHz at 25 MHz above. <sup>*4</sup> from 5 MHz above or below the band edge increasing linearly to a level of 27 dBm/MHz at the band edge.	

#### Note:

The following formula is used to convert the equipment isotropic radiated power (eirp) to field strength:

$$E = \frac{1000000\sqrt{30P}}{3} \mu\text{V/m, where P is the eirp (Watts).}$$

#### 4.1.2 Test Instruments

DESCRIPTION & MANUFACTURER	MODEL NO.	SERIAL NO.	CALIBRATED DATE	CALIBRATED UNTIL
HP Preamplifier	8447D	2432A03504	Feb. 19, 2020	Feb. 18, 2021
HP Preamplifier	8449B	3008A01201	Feb. 20, 2020	Feb. 19, 2021
MITEQ Preamplifier	AMF-6F-260400-33-8P	892164	Feb. 19, 2020	Feb. 18, 2021
Agilent TEST RECEIVER	N9038A	MY51210129	Mar. 18, 2020	Mar. 17, 2021
Schwarzbeck Antenna	VULB 9168	139	Nov. 7, 2019	Nov. 6, 2020
Schwarzbeck Antenna	VHBA 9123	480	Jun. 3, 2019	Jun. 2, 2021
Schwarzbeck Horn Antenna	BBHA-9170	212	Nov. 24, 2019	Nov. 23, 2020
Schwarzbeck Horn Antenna	BBHA 9120-D1	D130	Nov. 24, 2019	Nov. 23, 2020
ADT. Turn Table	TT100	0306	NA	NA
ADT. Tower	AT100	0306	NA	NA
Software	Radiated_V7.6.15.9.5	NA	NA	NA
SUHNER RF cable With 4dB PAD	SF102	Cable-CH6-01	Jul. 9, 2020	Jul. 8, 2021
SUHNER RF cable With 3/4dB PAD	SF102	Cable-CH8-3.6m	Jul. 9, 2020	Jul. 8, 2021
KEYSIGHT MIMO Powermeasurement Test set	U2021XA	U2021XA-001	Jun. 16, 2020	Jun. 15, 2021
KEYSIGHT Spectrum Analyzer	N9030A	MY54490260	Jul. 22, 2019	Jul. 21, 2020
			Jul. 22, 2020	Jul. 21, 2021
Loop Antenna EMCI	LPA600	270	Aug. 23, 2019	Aug. 22, 2021
EMCO Horn Antenna	3115	00028257	Nov. 24, 2019	Nov. 23, 2020
Highpass filter Wainwright Instruments	WHK 3.1/18G-10SS	SN 8	NA	NA
ROHDE & SCHWARZ Spectrum Analyzer	FSV40	101042	Sep. 23, 2019	Sep. 22, 2020
Anritsu Power Sensor	MA2411B	0738404	Apr. 13, 2020	Apr. 12, 2021
Anritsu Power Meter	ML2495A	0842014	Apr. 13, 2020	Apr. 12, 2021
Temperature & Humidity Chamber	MHU-225AU	920409	May 22, 2020	May 21, 2021
DIGITAL POWER METER IDRC	CP-240	240515	Sep. 11, 2019	Sep. 10, 2020
AC Power Source ExTech	CFW-105	E000603	NA	NA

- NOTE:**
1. The calibration interval of the above test instruments is 12/24 months. And the calibrations are traceable to NML/ROC and NIST/USA.
  2. The horn antenna and HP preamplifier (model: 8449B) are used only for the measurement of emission frequency above 1GHz if tested.
  3. The test was performed in Chamber No. 6.



#### 4.1.3 Test Procedure

##### **For Radiated emission below 30MHz**

- a. The EUT was placed on the top of a rotating table 0.8 meters above the ground at a 3 meter chamber room. The table was rotated 360 degrees to determine the position of the highest radiation.
- b. The EUT was set 3 meters away from the interference-receiving antenna, which was mounted on the top of a variable-height antenna tower.
- c. Parallel, perpendicular, and ground-parallel orientations of the antenna are set to make the measurement.
- d. For each suspected emission, the EUT was arranged to its worst case and the rotatable table was turned from 0 degrees to 360 degrees to find the maximum reading.
- e. The test-receiver system was set to Quasi-Peak Detect Function and Specified Bandwidth with Maximum Hold Mode.

##### **NOTE:**

1. The resolution bandwidth and video bandwidth of test receiver/spectrum analyzer is 9kHz at frequency below 30MHz.

##### **For Radiated emission above 30MHz**

- a. The EUT was placed on the top of a rotating table 0.8 meters (for 30MHz ~ 1GHz) / 1.5 meters (for above 1GHz) above the ground at 3 meter chamber room for test. The table was rotated 360 degrees to determine the position of the highest radiation.
- b. The EUT was set 3 meters away from the interference-receiving antenna, which was mounted on the top of a variable-height antenna tower.
- c. The height of antenna is varied from one meter to four meters above the ground to determine the maximum value of the field strength. Both horizontal and vertical polarizations of the antenna are set to make the measurement.
- d. For each suspected emission, the EUT was arranged to its worst case and then the antenna was tuned to heights from 1 meter to 4 meters and the rotatable table was turned from 0 degrees to 360 degrees to find the maximum reading.
- e. The test-receiver system was set to quasi-peak detect function and specified bandwidth with maximum hold mode when the test frequency is below 1 GHz.
- f. The test-receiver system was set to peak and average detects function and specified bandwidth with maximum hold mode when the test frequency is above 1 GHz. If the peak reading value also meets average limit, measurement with the average detector is unnecessary.

##### **Note:**

1. The resolution bandwidth and video bandwidth of test receiver/spectrum analyzer is 120kHz for Quasi-peak detection (QP) at frequency below 1GHz.
2. The resolution bandwidth of test receiver/spectrum analyzer is 1 MHz and the video bandwidth is 3 MHz for Peak detection (PK) at frequency above 1GHz.
3. The resolution bandwidth of test receiver/spectrum analyzer is 1MHz and the video bandwidth is  $\geq 1/T$  (Duty cycle  $< 98\%$ ) or 10Hz (Duty cycle  $\geq 98\%$ ) for Average detection (AV) at frequency above 1GHz.  
(802.11a: RBW = 1MHz, VBW = 510Hz; 802.11ac (20MHz): RBW = 1MHz, VBW = 560Hz;  
802.11ac (40MHz): RBW = 1MHz, VBW = 1.1kHz; 802.11ac (80MHz): RBW = 1MHz, VBW = 2.2kHz)
4. All modes of operation were investigated and the worst-case emissions are reported.

#### 4.1.4 Deviation from Test Standard

No deviation.

#### 4.1.5 Test Setup

##### For Radiated emission below 30MHz

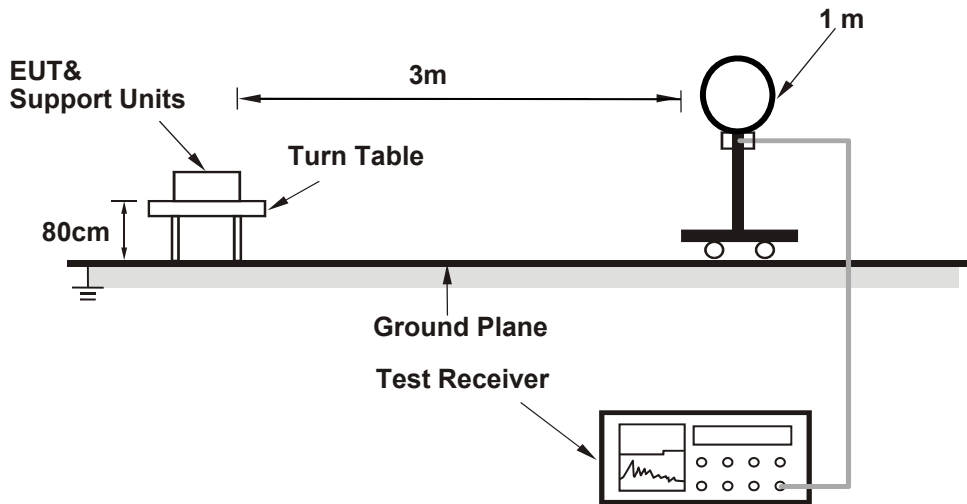

##### For Radiated emission 30MHz to 1GHz

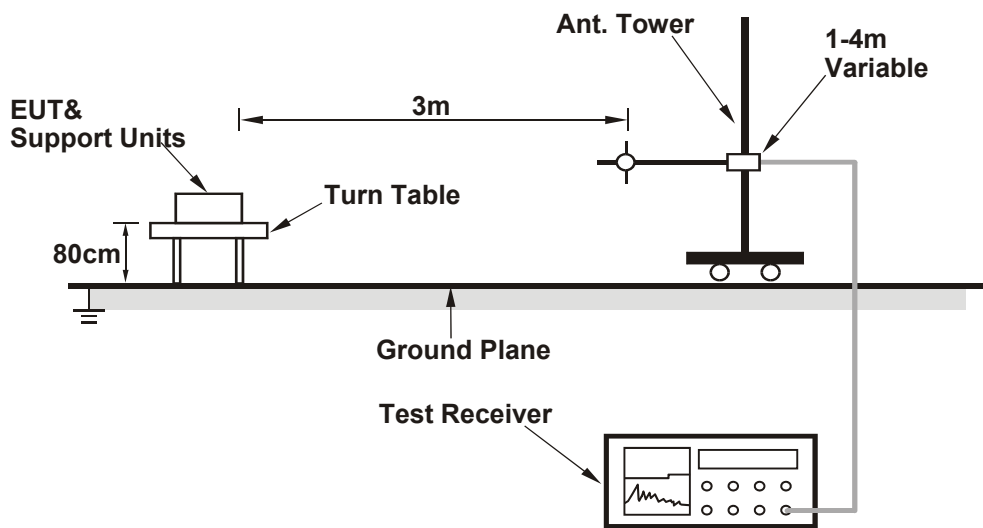

**For Radiated emission above 1GHz**

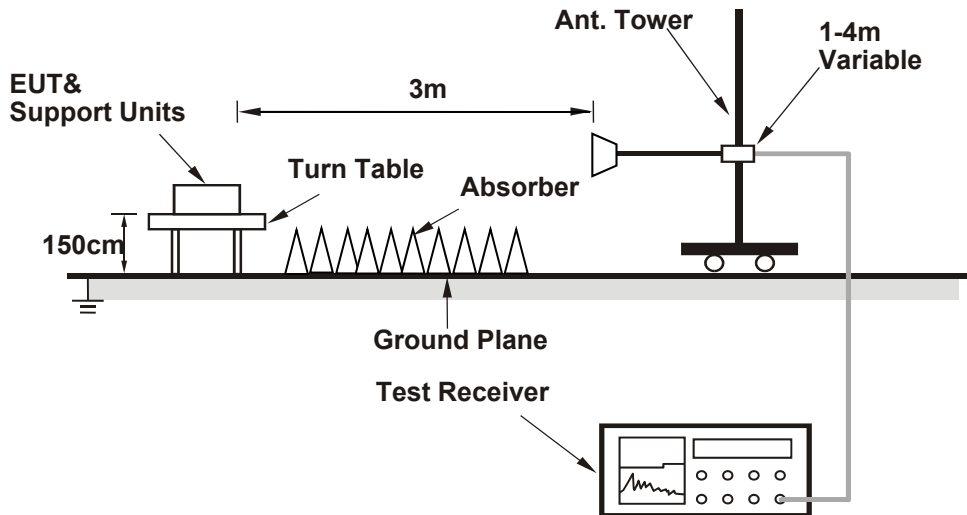

For the actual test configuration, please refer to the attached file (Test Setup Photo).

**4.1.6 EUT Operating Condition**

- a. Placed the EUT on the testing table.
- b. Prepared notebook to act as communication partner and placed it outside of testing area.
- c. The communication partner connected with EUT via a RJ45 cable and ran a test program (provided by manufacturer) to enable EUT under transmission condition continuously at specific channel frequency.
- d. The necessary accessories enable the system in full functions.

#### 4.1.7 Test Results

#### ABOVE 1GHz DATA

#### 802.11a

<b>Channel</b>	TX Channel 36	<b>Detector Function</b>	Peak (PK)
<b>Frequency Range</b>	1GHz ~ 40GHz		Average (AV)

Antenna Polarity & Test Distance : Horizontal at 3 m								
No	Frequency (MHz)	Emission Level (dBuV/m)	Limit (dBuV/m)	Margin (dB)	Antenna Height (m)	Table Angle (Degree)	Raw Value (dBuV)	Correction Factor (dB/m)
1	5150.00	65.96 PK	74.00	-8.04	2.48 H	271	57.62	8.34
2	5150.00	48.90 AV	54.00	-5.10	2.48 H	271	40.56	8.34
3	*5180.00	111.39 PK			2.48 H	271	102.98	8.41
4	*5180.00	101.18 AV			2.48 H	271	92.77	8.41
5	#10360.00	57.92 PK	68.20	-10.28	1.47 H	240	43.68	14.24

Antenna Polarity & Test Distance : Vertical at 3 m								
No	Frequency (MHz)	Emission Level (dBuV/m)	Limit (dBuV/m)	Margin (dB)	Antenna Height (m)	Table Angle (Degree)	Raw Value (dBuV)	Correction Factor (dB/m)
1	5150.00	62.76 PK	74.00	-11.24	1.83 V	298	54.42	8.34
2	5150.00	47.60 AV	54.00	-6.40	1.83 V	298	39.26	8.34
3	*5180.00	108.02 PK			1.83 V	298	99.61	8.41
4	*5180.00	97.78 AV			1.83 V	298	89.37	8.41
5	#10360.00	60.28 PK	68.20	-7.92	1.38 V	201	46.04	14.24

#### Remarks:

1. Emission Level(dBuV/m) = Raw Value(dBuV) + Correction Factor(dB/m)
2. Correction Factor(dB/m) = Antenna Factor(dB/m) + Cable Factor(dB) – Pre-Amplifier Factor(dB)
3. Margin value = Emission Level – Limit value
4. The other emission levels were very low against the limit.
5. " \* ": Fundamental frequency.
6. " # ": The radiated frequency is out of the restricted band.

<b>Channel</b>	TX Channel 40	<b>Detector Function</b>	Peak (PK)
<b>Frequency Range</b>	1GHz ~ 40GHz		Average (AV)

Antenna Polarity & Test Distance : Horizontal at 3 m								
No	Frequency (MHz)	Emission Level (dBuV/m)	Limit (dBuV/m)	Margin (dB)	Antenna Height (m)	Table Angle (Degree)	Raw Value (dBuV)	Correction Factor (dB/m)
1	*5200.00	110.50 PK			2.38 H	272	102.06	8.44
2	*5200.00	100.45 AV			2.38 H	272	92.01	8.44
3	#10400.00	57.83 PK	68.20	-10.37	1.54 H	250	43.53	14.30

Antenna Polarity & Test Distance : Vertical at 3 m								
No	Frequency (MHz)	Emission Level (dBuV/m)	Limit (dBuV/m)	Margin (dB)	Antenna Height (m)	Table Angle (Degree)	Raw Value (dBuV)	Correction Factor (dB/m)
1	*5200.00	108.01 PK			1.85 V	302	99.57	8.44
2	*5200.00	97.60 AV			1.85 V	302	89.16	8.44
3	#10400.00	60.18 PK	68.20	-8.02	1.37 V	215	45.88	14.30

**Remarks:**

1. Emission Level(dBuV/m) = Raw Value(dBuV) + Correction Factor(dB/m)
2. Correction Factor(dB/m) = Antenna Factor(dB/m) + Cable Factor(dB) – Pre-Amplifier Factor(dB)
3. Margin value = Emission Level – Limit value
4. The other emission levels were very low against the limit.
5. " \* " : Fundamental frequency.
6. " # " : The radiated frequency is out of the restricted band.

<b>Channel</b>	TX Channel 48	<b>Detector Function</b>	Peak (PK)
<b>Frequency Range</b>	1GHz ~ 40GHz		Average (AV)

**Antenna Polarity & Test Distance : Horizontal at 3 m**

No	Frequency (MHz)	Emission Level (dBuV/m)	Limit (dBuV/m)	Margin (dB)	Antenna Height (m)	Table Angle (Degree)	Raw Value (dBuV)	Correction Factor (dB/m)
1	*5240.00	112.93 PK			2.66 H	272	104.29	8.64
2	*5240.00	102.66 AV			2.66 H	272	94.02	8.64
3	5350.00	61.20 PK	74.00	-12.80	2.66 H	272	52.01	9.19
4	5350.00	47.81 AV	54.00	-6.19	2.66 H	272	38.62	9.19
5	#10480.00	57.50 PK	68.20	-10.70	1.46 H	234	43.34	14.16

**Antenna Polarity & Test Distance : Vertical at 3 m**

No	Frequency (MHz)	Emission Level (dBuV/m)	Limit (dBuV/m)	Margin (dB)	Antenna Height (m)	Table Angle (Degree)	Raw Value (dBuV)	Correction Factor (dB/m)
1	*5240.00	108.85 PK			1.88 V	294	100.21	8.64
2	*5240.00	99.28 AV			1.88 V	294	90.64	8.64
3	5350.00	60.65 PK	74.00	-13.35	1.88 V	294	51.46	9.19
4	5350.00	47.31 AV	54.00	-6.69	1.88 V	294	38.12	9.19
5	#10480.00	60.39 PK	68.20	-7.81	1.44 V	195	46.23	14.16

**Remarks:**

1. Emission Level(dBuV/m) = Raw Value(dBuV) + Correction Factor(dB/m)
2. Correction Factor(dB/m) = Antenna Factor(dB/m) + Cable Factor(dB) – Pre-Amplifier Factor(dB)
3. Margin value = Emission Level – Limit value
4. The other emission levels were very low against the limit.
5. " \* ": Fundamental frequency.
6. " # ": The radiated frequency is out of the restricted band.

<b>Channel</b>	TX Channel 149	<b>Detector Function</b>	Peak (PK)
<b>Frequency Range</b>	1GHz ~ 40GHz		Average (AV)

**Antenna Polarity & Test Distance : Horizontal at 3 m**

No	Frequency (MHz)	Emission Level (dBuV/m)	Limit (dBuV/m)	Margin (dB)	Antenna Height (m)	Table Angle (Degree)	Raw Value (dBuV)	Correction Factor (dB/m)
1	#5650.81	66.67 PK	68.80	-2.13	1.98 H	320	57.38	9.29
2	*5745.00	117.78 PK			1.98 H	320	108.71	9.07
3	*5745.00	106.64 AV			1.98 H	320	97.57	9.07
4	#6011.47	61.51 PK	68.20	-6.69	1.98 H	320	52.11	9.40
5	11490.00	60.93 PK	74.00	-13.07	1.50 H	238	44.67	16.26
6	11490.00	48.37 AV	54.00	-5.63	1.50 H	238	32.11	16.26

**Antenna Polarity & Test Distance : Vertical at 3 m**

No	Frequency (MHz)	Emission Level (dBuV/m)	Limit (dBuV/m)	Margin (dB)	Antenna Height (m)	Table Angle (Degree)	Raw Value (dBuV)	Correction Factor (dB/m)
1	#5636.69	64.86 PK	68.20	-3.34	2.98 V	319	55.55	9.31
2	*5745.00	113.27 PK			2.98 V	319	104.20	9.07
3	*5745.00	102.16 AV			2.98 V	319	93.09	9.07
4	#5996.57	61.80 PK	68.20	-6.40	2.98 V	319	52.41	9.39
5	11490.00	61.79 PK	74.00	-12.21	1.50 V	175	45.53	16.26
6	11490.00	48.60 AV	54.00	-5.40	1.50 V	175	32.34	16.26

**Remarks:**

1. Emission Level(dBuV/m) = Raw Value(dBuV) + Correction Factor(dB/m)
2. Correction Factor(dB/m) = Antenna Factor(dB/m) + Cable Factor(dB) – Pre-Amplifier Factor(dB)
3. Margin value = Emission Level – Limit value
4. The other emission levels were very low against the limit.
5. " \* ": Fundamental frequency.
6. " # ": The radiated frequency is out of the restricted band.

<b>Channel</b>	TX Channel 157	<b>Detector Function</b>	Peak (PK)
<b>Frequency Range</b>	1GHz ~ 40GHz		Average (AV)

**Antenna Polarity & Test Distance : Horizontal at 3 m**

No	Frequency (MHz)	Emission Level (dBuV/m)	Limit (dBuV/m)	Margin (dB)	Antenna Height (m)	Table Angle (Degree)	Raw Value (dBuV)	Correction Factor (dB/m)
1	#5641.66	60.59 PK	68.20	-7.61	2.01 H	320	51.28	9.31
2	*5785.00	118.45 PK			2.01 H	320	109.46	8.99
3	*5785.00	107.63 AV			2.01 H	320	98.64	8.99
4	#5927.91	61.63 PK	68.20	-6.57	2.01 H	320	52.63	9.00
5	11570.00	61.04 PK	74.00	-12.96	1.52 H	245	44.52	16.52
6	11570.00	48.60 AV	54.00	-5.40	1.52 H	245	32.08	16.52

**Antenna Polarity & Test Distance : Vertical at 3 m**

No	Frequency (MHz)	Emission Level (dBuV/m)	Limit (dBuV/m)	Margin (dB)	Antenna Height (m)	Table Angle (Degree)	Raw Value (dBuV)	Correction Factor (dB/m)
1	#5629.63	61.36 PK	68.20	-6.84	3.02 V	322	52.05	9.31
2	*5785.00	114.25 PK			3.02 V	322	105.26	8.99
3	*5785.00	103.35 AV			3.02 V	322	94.36	8.99
4	#5928.47	62.15 PK	68.20	-6.05	3.02 V	322	53.14	9.01
5	11570.00	62.15 PK	74.00	-11.85	1.47 V	178	45.63	16.52
6	11570.00	49.21 AV	54.00	-4.79	1.47 V	178	32.69	16.52

**Remarks:**

1. Emission Level(dBuV/m) = Raw Value(dBuV) + Correction Factor(dB/m)
2. Correction Factor(dB/m) = Antenna Factor(dB/m) + Cable Factor(dB) – Pre-Amplifier Factor(dB)
3. Margin value = Emission Level – Limit value
4. The other emission levels were very low against the limit.
5. " \* ": Fundamental frequency.
6. " # ": The radiated frequency is out of the restricted band.



<b>Channel</b>	TX Channel 165	<b>Detector Function</b>	Peak (PK)
<b>Frequency Range</b>	1GHz ~ 40GHz		Average (AV)

**Antenna Polarity & Test Distance : Horizontal at 3 m**

No	Frequency (MHz)	Emission Level (dBuV/m)	Limit (dBuV/m)	Margin (dB)	Antenna Height (m)	Table Angle (Degree)	Raw Value (dBuV)	Correction Factor (dB/m)
1	#5594.53	61.38 PK	68.20	-6.82	1.96 H	317	52.01	9.37
2	*5825.00	118.81 PK			1.96 H	317	109.87	8.94
3	*5825.00	107.80 AV			1.96 H	317	98.86	8.94
4	#5924.38	66.87 PK	68.66	-1.79	1.96 H	317	57.88	8.99
5	11650.00	61.03 PK	74.00	-12.97	1.54 H	233	44.74	16.29
6	11650.00	48.25 AV	54.00	-5.75	1.54 H	233	31.96	16.29

**Antenna Polarity & Test Distance : Vertical at 3 m**

No	Frequency (MHz)	Emission Level (dBuV/m)	Limit (dBuV/m)	Margin (dB)	Antenna Height (m)	Table Angle (Degree)	Raw Value (dBuV)	Correction Factor (dB/m)
1	#5635.94	59.82 PK	68.20	-8.38	2.95 V	311	50.52	9.30
2	*5825.00	114.81 PK			2.95 V	311	105.87	8.94
3	*5825.00	103.63 AV			2.95 V	311	94.69	8.94
4	#5928.50	65.82 PK	68.20	-2.38	2.95 V	311	56.81	9.01
5	11650.00	61.91 PK	74.00	-12.09	1.52 V	180	45.62	16.29
6	11650.00	49.15 AV	54.00	-4.85	1.52 V	180	32.86	16.29

**Remarks:**

1. Emission Level(dBuV/m) = Raw Value(dBuV) + Correction Factor(dB/m)
2. Correction Factor(dB/m) = Antenna Factor(dB/m) + Cable Factor(dB) – Pre-Amplifier Factor(dB)
3. Margin value = Emission Level – Limit value
4. The other emission levels were very low against the limit.
5. " \* ": Fundamental frequency.
6. " # ": The radiated frequency is out of the restricted band.

802.11ac (20MHz)

<b>Channel</b>	TX Channel 36	<b>Detector Function</b>	Peak (PK)
<b>Frequency Range</b>	1GHz ~ 40GHz		Average (AV)

Antenna Polarity & Test Distance : Horizontal at 3 m								
No	Frequency (MHz)	Emission Level (dBuV/m)	Limit (dBuV/m)	Margin (dB)	Antenna Height (m)	Table Angle (Degree)	Raw Value (dBuV)	Correction Factor (dB/m)
1	5150.00	66.91 PK	74.00	-7.09	2.81 H	273	58.57	8.34
2	5150.00	50.41 AV	54.00	-3.59	2.81 H	273	42.07	8.34
3	*5180.00	109.94 PK			2.81 H	273	101.53	8.41
4	*5180.00	99.79 AV			2.81 H	273	91.38	8.41
5	#10360.00	58.20 PK	68.20	-10.00	1.52 H	239	43.96	14.24

Antenna Polarity & Test Distance : Vertical at 3 m								
No	Frequency (MHz)	Emission Level (dBuV/m)	Limit (dBuV/m)	Margin (dB)	Antenna Height (m)	Table Angle (Degree)	Raw Value (dBuV)	Correction Factor (dB/m)
1	5150.00	63.80 PK	74.00	-10.20	1.85 V	296	55.46	8.34
2	5150.00	49.22 AV	54.00	-4.78	1.85 V	296	40.88	8.34
3	*5180.00	107.17 PK			1.85 V	296	98.76	8.41
4	*5180.00	97.00 AV			1.85 V	296	88.59	8.41
5	#10360.00	60.12 PK	68.20	-8.08	1.41 V	205	45.88	14.24

**Remarks:**

1. Emission Level(dBuV/m) = Raw Value(dBuV) + Correction Factor(dB/m)
2. Correction Factor(dB/m) = Antenna Factor(dB/m) + Cable Factor(dB) – Pre-Amplifier Factor(dB)
3. Margin value = Emission Level – Limit value
4. The other emission levels were very low against the limit.
5. " \* ": Fundamental frequency.
6. " # ": The radiated frequency is out of the restricted band.

<b>Channel</b>	TX Channel 40	<b>Detector Function</b>	Peak (PK)
<b>Frequency Range</b>	1GHz ~ 40GHz		Average (AV)

**Antenna Polarity & Test Distance : Horizontal at 3 m**

No	Frequency (MHz)	Emission Level (dBuV/m)	Limit (dBuV/m)	Margin (dB)	Antenna Height (m)	Table Angle (Degree)	Raw Value (dBuV)	Correction Factor (dB/m)
1	*5200.00	110.95 PK			2.79 H	271	102.51	8.44
2	*5200.00	100.78 AV			2.79 H	271	92.34	8.44
3	#10400.00	57.61 PK	68.20	-10.59	1.47 H	242	43.31	14.30

**Antenna Polarity & Test Distance : Vertical at 3 m**

No	Frequency (MHz)	Emission Level (dBuV/m)	Limit (dBuV/m)	Margin (dB)	Antenna Height (m)	Table Angle (Degree)	Raw Value (dBuV)	Correction Factor (dB/m)
1	*5200.00	108.18 PK			1.86 V	294	99.74	8.44
2	*5200.00	98.07 AV			1.86 V	294	89.63	8.44
3	#10400.00	60.11 PK	68.20	-8.09	1.33 V	202	45.81	14.30

**Remarks:**

1. Emission Level(dBuV/m) = Raw Value(dBuV) + Correction Factor(dB/m)
2. Correction Factor(dB/m) = Antenna Factor(dB/m) + Cable Factor(dB) – Pre-Amplifier Factor(dB)
3. Margin value = Emission Level – Limit value
4. The other emission levels were very low against the limit.
5. " \* " : Fundamental frequency.
6. " # " : The radiated frequency is out of the restricted band.

<b>Channel</b>	TX Channel 48	<b>Detector Function</b>	Peak (PK)
<b>Frequency Range</b>	1GHz ~ 40GHz		Average (AV)

**Antenna Polarity & Test Distance : Horizontal at 3 m**

No	Frequency (MHz)	Emission Level (dBuV/m)	Limit (dBuV/m)	Margin (dB)	Antenna Height (m)	Table Angle (Degree)	Raw Value (dBuV)	Correction Factor (dB/m)
1	*5240.00	111.98 PK			2.67 H	271	103.34	8.64
2	*5240.00	101.50 AV			2.67 H	271	92.86	8.64
3	5350.00	61.04 PK	74.00	-12.96	2.67 H	271	51.85	9.19
4	5350.00	47.94 AV	54.00	-6.06	2.67 H	271	38.75	9.19
5	#10480.00	57.39 PK	68.20	-10.81	1.48 H	241	43.23	14.16

**Antenna Polarity & Test Distance : Vertical at 3 m**

No	Frequency (MHz)	Emission Level (dBuV/m)	Limit (dBuV/m)	Margin (dB)	Antenna Height (m)	Table Angle (Degree)	Raw Value (dBuV)	Correction Factor (dB/m)
1	*5240.00	108.80 PK			1.84 V	299	100.16	8.64
2	*5240.00	99.05 AV			1.84 V	299	90.41	8.64
3	5350.00	60.42 PK	74.00	-13.58	1.84 V	299	51.23	9.19
4	5350.00	47.33 AV	54.00	-6.67	1.84 V	299	38.14	9.19
5	#10480.00	60.27 PK	68.20	-7.93	1.36 V	203	46.11	14.16

**Remarks:**

1. Emission Level(dBuV/m) = Raw Value(dBuV) + Correction Factor(dB/m)
2. Correction Factor(dB/m) = Antenna Factor(dB/m) + Cable Factor(dB) – Pre-Amplifier Factor(dB)
3. Margin value = Emission Level – Limit value
4. The other emission levels were very low against the limit.
5. " \* " : Fundamental frequency.
6. " # " : The radiated frequency is out of the restricted band.

<b>Channel</b>	TX Channel 149	<b>Detector Function</b>	Peak (PK)
<b>Frequency Range</b>	1GHz ~ 40GHz		Average (AV)

**Antenna Polarity & Test Distance : Horizontal at 3 m**

No	Frequency (MHz)	Emission Level (dBuV/m)	Limit (dBuV/m)	Margin (dB)	Antenna Height (m)	Table Angle (Degree)	Raw Value (dBuV)	Correction Factor (dB/m)
1	#5643.39	65.37 PK	68.20	-2.83	1.50 H	299	56.08	9.29
2	*5745.00	115.62 PK			1.50 H	299	106.55	9.07
3	*5745.00	105.25 AV			1.50 H	299	96.18	9.07
4	#5941.87	61.50 PK	68.20	-6.70	1.50 H	299	52.41	9.09
5	11490.00	60.54 PK	74.00	-13.46	2.26 H	238	44.28	16.26
6	11490.00	48.44 AV	54.00	-5.56	2.26 H	238	32.18	16.26

**Antenna Polarity & Test Distance : Vertical at 3 m**

No	Frequency (MHz)	Emission Level (dBuV/m)	Limit (dBuV/m)	Margin (dB)	Antenna Height (m)	Table Angle (Degree)	Raw Value (dBuV)	Correction Factor (dB/m)
1	#5643.30	63.97 PK	68.20	-4.23	2.34 V	306	54.68	9.29
2	*5745.00	112.63 PK			2.34 V	306	103.56	9.07
3	*5745.00	102.48 AV			2.34 V	306	93.41	9.07
4	#5968.65	61.89 PK	68.20	-6.31	2.34 V	306	52.65	9.24
5	11490.00	61.47 PK	74.00	-12.53	1.57 V	128	45.21	16.26
6	11490.00	49.49 AV	54.00	-4.51	1.57 V	128	33.23	16.26

**Remarks:**

1. Emission Level(dBuV/m) = Raw Value(dBuV) + Correction Factor(dB/m)
2. Correction Factor(dB/m) = Antenna Factor(dB/m) + Cable Factor(dB) – Pre-Amplifier Factor(dB)
3. Margin value = Emission Level – Limit value
4. The other emission levels were very low against the limit.
5. " \* ": Fundamental frequency.
6. " # ": The radiated frequency is out of the restricted band.

<b>Channel</b>	TX Channel 157	<b>Detector Function</b>	Peak (PK)
<b>Frequency Range</b>	1GHz ~ 40GHz		Average (AV)

**Antenna Polarity & Test Distance : Horizontal at 3 m**

No	Frequency (MHz)	Emission Level (dBuV/m)	Limit (dBuV/m)	Margin (dB)	Antenna Height (m)	Table Angle (Degree)	Raw Value (dBuV)	Correction Factor (dB/m)
1	#5608.08	60.92 PK	68.20	-7.28	1.48 H	302	51.60	9.32
2	*5785.00	115.88 PK			1.48 H	302	106.89	8.99
3	*5785.00	105.54 AV			1.48 H	302	96.55	8.99
4	#5957.68	61.84 PK	68.20	-6.36	1.48 H	302	52.67	9.17
5	11570.00	60.80 PK	74.00	-13.20	2.30 H	241	44.28	16.52
6	11570.00	48.71 AV	54.00	-5.29	2.30 H	241	32.19	16.52

**Antenna Polarity & Test Distance : Vertical at 3 m**

No	Frequency (MHz)	Emission Level (dBuV/m)	Limit (dBuV/m)	Margin (dB)	Antenna Height (m)	Table Angle (Degree)	Raw Value (dBuV)	Correction Factor (dB/m)
1	#5633.15	59.86 PK	68.20	-8.34	2.30 V	315	50.55	9.31
2	*5785.00	112.54 PK			2.30 V	315	103.55	8.99
3	*5785.00	102.33 AV			2.30 V	315	93.34	8.99
4	#5932.36	64.03 PK	68.20	-4.17	2.30 V	315	55.00	9.03
5	11570.00	61.85 PK	74.00	-12.15	1.61 V	130	45.33	16.52
6	11570.00	50.15 AV	54.00	-3.85	1.61 V	130	33.63	16.52

**Remarks:**

1. Emission Level(dBuV/m) = Raw Value(dBuV) + Correction Factor(dB/m)
2. Correction Factor(dB/m) = Antenna Factor(dB/m) + Cable Factor(dB) – Pre-Amplifier Factor(dB)
3. Margin value = Emission Level – Limit value
4. The other emission levels were very low against the limit.
5. " \* ": Fundamental frequency.
6. " # ": The radiated frequency is out of the restricted band.

<b>Channel</b>	TX Channel 165	<b>Detector Function</b>	Peak (PK)
<b>Frequency Range</b>	1GHz ~ 40GHz		Average (AV)

**Antenna Polarity & Test Distance : Horizontal at 3 m**

No	Frequency (MHz)	Emission Level (dBuV/m)	Limit (dBuV/m)	Margin (dB)	Antenna Height (m)	Table Angle (Degree)	Raw Value (dBuV)	Correction Factor (dB/m)
1	#5637.87	60.05 PK	68.20	-8.15	1.47 H	295	50.74	9.31
2	*5825.00	114.81 PK			1.47 H	295	105.87	8.94
3	*5825.00	104.83 AV			1.47 H	295	95.89	8.94
4	#5926.22	66.64 PK	68.20	-1.56	1.47 H	295	57.65	8.99
5	11650.00	59.44 PK	74.00	-14.56	2.32 H	230	43.15	16.29
6	11650.00	47.34 AV	54.00	-6.66	2.32 H	230	31.05	16.29

**Antenna Polarity & Test Distance : Vertical at 3 m**

No	Frequency (MHz)	Emission Level (dBuV/m)	Limit (dBuV/m)	Margin (dB)	Antenna Height (m)	Table Angle (Degree)	Raw Value (dBuV)	Correction Factor (dB/m)
1	#5633.48	60.08 PK	68.20	-8.12	2.29 V	241	50.77	9.31
2	*5825.00	111.52 PK			2.29 V	241	102.58	8.94
3	*5825.00	101.30 AV			2.29 V	241	92.36	8.94
4	#5933.34	62.29 PK	68.20	-5.91	2.29 V	241	53.26	9.03
5	11650.00	60.44 PK	74.00	-13.56	1.44 V	132	44.15	16.29
6	11650.00	48.91 AV	54.00	-5.09	1.44 V	132	32.62	16.29

**Remarks:**

1. Emission Level(dBuV/m) = Raw Value(dBuV) + Correction Factor(dB/m)
2. Correction Factor(dB/m) = Antenna Factor(dB/m) + Cable Factor(dB) – Pre-Amplifier Factor(dB)
3. Margin value = Emission Level – Limit value
4. The other emission levels were very low against the limit.
5. " \* " : Fundamental frequency.
6. " # " : The radiated frequency is out of the restricted band.

802.11ac (40MHz)

<b>Channel</b>	TX Channel 38	<b>Detector Function</b>	Peak (PK)
<b>Frequency Range</b>	1GHz ~ 40GHz		Average (AV)

**Antenna Polarity & Test Distance : Horizontal at 3 m**

No	Frequency (MHz)	Emission Level (dBuV/m)	Limit (dBuV/m)	Margin (dB)	Antenna Height (m)	Table Angle (Degree)	Raw Value (dBuV)	Correction Factor (dB/m)
1	5150.00	65.76 PK	74.00	-8.24	2.70 H	267	57.42	8.34
2	5150.00	52.66 AV	54.00	-1.34	2.70 H	267	44.32	8.34
3	*5190.00	105.44 PK			2.70 H	267	97.02	8.42
4	*5190.00	95.95 AV			2.70 H	267	87.53	8.42
5	#10380.00	55.79 PK	68.20	-12.41	1.47 H	242	41.52	14.27

**Antenna Polarity & Test Distance : Vertical at 3 m**

No	Frequency (MHz)	Emission Level (dBuV/m)	Limit (dBuV/m)	Margin (dB)	Antenna Height (m)	Table Angle (Degree)	Raw Value (dBuV)	Correction Factor (dB/m)
1	5150.00	62.70 PK	74.00	-11.30	1.83 V	303	54.36	8.34
2	5150.00	50.53 AV	54.00	-3.47	1.83 V	303	42.19	8.34
3	*5190.00	103.26 PK			1.83 V	303	94.84	8.42
4	*5190.00	92.68 AV			1.83 V	303	84.26	8.42
5	#10380.00	58.43 PK	68.20	-9.77	1.38 V	199	44.16	14.27

**Remarks:**

1. Emission Level(dBuV/m) = Raw Value(dBuV) + Correction Factor(dB/m)
2. Correction Factor(dB/m) = Antenna Factor(dB/m) + Cable Factor(dB) – Pre-Amplifier Factor(dB)
3. Margin value = Emission Level – Limit value
4. The other emission levels were very low against the limit.
5. " \* ": Fundamental frequency.
6. " # ": The radiated frequency is out of the restricted band.



<b>Channel</b>	TX Channel 46	<b>Detector Function</b>	Peak (PK)
<b>Frequency Range</b>	1GHz ~ 40GHz		Average (AV)

**Antenna Polarity & Test Distance : Horizontal at 3 m**

No	Frequency (MHz)	Emission Level (dBuV/m)	Limit (dBuV/m)	Margin (dB)	Antenna Height (m)	Table Angle (Degree)	Raw Value (dBuV)	Correction Factor (dB/m)
1	*5230.00	108.83 PK			2.66 H	273	100.24	8.59
2	*5230.00	99.07 AV			2.66 H	273	90.48	8.59
3	5350.00	60.96 PK	74.00	-13.04	2.66 H	273	51.77	9.19
4	5350.00	48.26 AV	54.00	-5.74	2.66 H	273	39.07	9.19
5	#10460.00	55.28 PK	68.20	-12.92	1.52 H	237	41.09	14.19

**Antenna Polarity & Test Distance : Vertical at 3 m**

No	Frequency (MHz)	Emission Level (dBuV/m)	Limit (dBuV/m)	Margin (dB)	Antenna Height (m)	Table Angle (Degree)	Raw Value (dBuV)	Correction Factor (dB/m)
1	*5230.00	106.44 PK			1.85 V	301	97.85	8.59
2	*5230.00	96.24 AV			1.85 V	301	87.65	8.59
3	5350.00	50.21 PK	74.00	-23.79	1.85 V	301	41.02	9.19
4	5350.00	47.97 AV	54.00	-6.03	1.85 V	301	38.78	9.19
5	#10460.00	57.53 PK	68.20	-10.67	1.40 V	194	43.34	14.19

**Remarks:**

1. Emission Level(dBuV/m) = Raw Value(dBuV) + Correction Factor(dB/m)
2. Correction Factor(dB/m) = Antenna Factor(dB/m) + Cable Factor(dB) – Pre-Amplifier Factor(dB)
3. Margin value = Emission Level – Limit value
4. The other emission levels were very low against the limit.
5. " \* " : Fundamental frequency.
6. " # " : The radiated frequency is out of the restricted band.

<b>Channel</b>	TX Channel 151	<b>Detector Function</b>	Peak (PK)
<b>Frequency Range</b>	1GHz ~ 40GHz		Average (AV)

**Antenna Polarity & Test Distance : Horizontal at 3 m**

No	Frequency (MHz)	Emission Level (dBuV/m)	Limit (dBuV/m)	Margin (dB)	Antenna Height (m)	Table Angle (Degree)	Raw Value (dBuV)	Correction Factor (dB/m)
1	#5639.40	67.12 PK	68.20	-1.08	1.81 H	317	57.82	9.30
2	*5755.00	113.01 PK			1.81 H	317	103.97	9.04
3	*5755.00	103.10 AV			1.81 H	317	94.06	9.04
4	#5924.50	63.65 PK	68.57	-4.92	1.81 H	317	54.66	8.99
5	11510.00	58.86 PK	74.00	-15.14	1.57 H	142	42.52	16.34
6	11510.00	46.56 AV	54.00	-7.44	1.57 H	142	30.22	16.34

**Antenna Polarity & Test Distance : Vertical at 3 m**

No	Frequency (MHz)	Emission Level (dBuV/m)	Limit (dBuV/m)	Margin (dB)	Antenna Height (m)	Table Angle (Degree)	Raw Value (dBuV)	Correction Factor (dB/m)
1	#5650.80	65.18 PK	68.79	-3.61	4.00 V	334	55.89	9.29
2	*5755.00	108.98 PK			4.00 V	334	99.94	9.04
3	*5755.00	99.03 AV			4.00 V	334	89.99	9.04
4	#5989.65	61.85 PK	68.20	-6.35	4.00 V	334	52.50	9.35
5	11510.00	59.50 PK	74.00	-14.50	1.62 V	234	43.16	16.34
6	11510.00	47.98 AV	54.00	-6.02	1.62 V	234	31.64	16.34

**Remarks:**

1. Emission Level(dBuV/m) = Raw Value(dBuV) + Correction Factor(dB/m)
2. Correction Factor(dB/m) = Antenna Factor(dB/m) + Cable Factor(dB) – Pre-Amplifier Factor(dB)
3. Margin value = Emission Level – Limit value
4. The other emission levels were very low against the limit.
5. " \* ": Fundamental frequency.
6. " # ": The radiated frequency is out of the restricted band.

<b>Channel</b>	TX Channel 159	<b>Detector Function</b>	Peak (PK)
<b>Frequency Range</b>	1GHz ~ 40GHz		Average (AV)

**Antenna Polarity & Test Distance : Horizontal at 3 m**

No	Frequency (MHz)	Emission Level (dBuV/m)	Limit (dBuV/m)	Margin (dB)	Antenna Height (m)	Table Angle (Degree)	Raw Value (dBuV)	Correction Factor (dB/m)
1	#5647.16	62.42 PK	68.20	-5.78	1.71 H	320	53.13	9.29
2	*5795.00	113.49 PK			1.71 H	320	104.52	8.97
3	*5795.00	103.33 AV			1.71 H	320	94.36	8.97
4	#5925.21	66.65 PK	68.20	-1.55	1.71 H	320	57.66	8.99
5	11590.00	59.08 PK	74.00	-14.92	1.47 H	155	42.51	16.57
6	11590.00	46.93 AV	54.00	-7.07	1.47 H	155	30.36	16.57

**Antenna Polarity & Test Distance : Vertical at 3 m**

No	Frequency (MHz)	Emission Level (dBuV/m)	Limit (dBuV/m)	Margin (dB)	Antenna Height (m)	Table Angle (Degree)	Raw Value (dBuV)	Correction Factor (dB/m)
1	#5643.86	60.97 PK	68.20	-7.23	3.94 V	341	51.68	9.29
2	*5795.00	109.23 PK			3.94 V	341	100.26	8.97
3	*5795.00	99.33 AV			3.94 V	341	90.36	8.97
4	#5940.49	64.92 PK	68.20	-3.28	3.94 V	341	55.84	9.08
5	11590.00	60.11 PK	74.00	-13.89	1.36 V	269	43.54	16.57
6	11590.00	47.99 AV	54.00	-6.01	1.36 V	269	31.42	16.57

**Remarks:**

1. Emission Level(dBuV/m) = Raw Value(dBuV) + Correction Factor(dB/m)
2. Correction Factor(dB/m) = Antenna Factor(dB/m) + Cable Factor(dB) – Pre-Amplifier Factor(dB)
3. Margin value = Emission Level – Limit value
4. The other emission levels were very low against the limit.
5. " \* ": Fundamental frequency.
6. " # ": The radiated frequency is out of the restricted band.

802.11ac (80MHz)

<b>Channel</b>	TX Channel 42	<b>Detector Function</b>	Peak (PK)
<b>Frequency Range</b>	1GHz ~ 40GHz		Average (AV)

Antenna Polarity & Test Distance : Horizontal at 3 m								
No	Frequency (MHz)	Emission Level (dBuV/m)	Limit (dBuV/m)	Margin (dB)	Antenna Height (m)	Table Angle (Degree)	Raw Value (dBuV)	Correction Factor (dB/m)
1	5150.00	68.44 PK	74.00	-5.56	2.78 H	271	60.10	8.34
2	5150.00	52.81 AV	54.00	-1.19	2.78 H	271	44.47	8.34
3	*5210.00	103.35 PK			2.78 H	271	94.87	8.48
4	*5210.00	93.49 AV			2.78 H	271	85.01	8.48
5	5350.00	62.44 PK	74.00	-11.56	2.78 H	271	53.25	9.19
6	5350.00	48.57 AV	54.00	-5.43	2.78 H	271	39.38	9.19
7	#10420.00	55.78 PK	68.20	-12.42	1.45 H	236	41.52	14.26

Antenna Polarity & Test Distance : Vertical at 3 m								
No	Frequency (MHz)	Emission Level (dBuV/m)	Limit (dBuV/m)	Margin (dB)	Antenna Height (m)	Table Angle (Degree)	Raw Value (dBuV)	Correction Factor (dB/m)
1	5150.00	65.76 PK	74.00	-8.24	1.81 V	292	57.42	8.34
2	5150.00	50.53 AV	54.00	-3.47	1.81 V	292	42.19	8.34
3	*5210.00	99.89 PK			1.81 V	292	91.41	8.48
4	*5210.00	89.81 AV			1.81 V	292	81.33	8.48
5	5350.00	61.32 PK	74.00	-12.68	1.81 V	292	52.13	9.19
6	5350.00	47.96 AV	54.00	-6.04	1.81 V	292	38.77	9.19
7	#10420.00	57.59 PK	68.20	-10.61	1.62 V	234	43.33	14.26

**Remarks:**

1. Emission Level(dBuV/m) = Raw Value(dBuV) + Correction Factor(dB/m)
2. Correction Factor(dB/m) = Antenna Factor(dB/m) + Cable Factor(dB) – Pre-Amplifier Factor(dB)
3. Margin value = Emission Level – Limit value
4. The other emission levels were very low against the limit.
5. " \* ": Fundamental frequency.
6. " # ": The radiated frequency is out of the restricted band.

<b>Channel</b>	TX Channel 155	<b>Detector Function</b>	Peak (PK)
<b>Frequency Range</b>	1GHz ~ 40GHz		Average (AV)

**Antenna Polarity & Test Distance : Horizontal at 3 m**

No	Frequency (MHz)	Emission Level (dBuV/m)	Limit (dBuV/m)	Margin (dB)	Antenna Height (m)	Table Angle (Degree)	Raw Value (dBuV)	Correction Factor (dB/m)
1	#5649.33	66.50 PK	68.20	-1.70	1.86 H	320	57.20	9.30
2	*5775.00	106.64 PK			1.86 H	320	97.63	9.01
3	*5775.00	97.27 AV			1.86 H	320	88.26	9.01
<b>4</b>	<b>#5924.68</b>	<b>67.44 PK</b>	<b>68.44</b>	<b>-1.00</b>	<b>1.86 H</b>	<b>320</b>	<b>58.45</b>	<b>8.99</b>
5	11550.00	57.70 PK	74.00	-16.30	1.47 H	145	41.25	16.45
6	11550.00	46.34 AV	54.00	-7.66	1.47 H	145	29.89	16.45

**Antenna Polarity & Test Distance : Vertical at 3 m**

No	Frequency (MHz)	Emission Level (dBuV/m)	Limit (dBuV/m)	Margin (dB)	Antenna Height (m)	Table Angle (Degree)	Raw Value (dBuV)	Correction Factor (dB/m)
1	#5649.94	63.62 PK	68.20	-4.58	3.97 V	339	54.32	9.30
2	*5775.00	103.27 PK			3.97 V	339	94.26	9.01
3	*5775.00	94.43 AV			3.97 V	339	85.42	9.01
4	#5934.35	64.96 PK	68.20	-3.24	3.97 V	339	55.93	9.03
5	11550.00	59.01 PK	74.00	-14.99	1.23 V	264	42.56	16.45
6	11550.00	47.14 AV	54.00	-6.86	1.23 V	264	30.69	16.45

**Remarks:**

1. Emission Level(dBuV/m) = Raw Value(dBuV) + Correction Factor(dB/m)
2. Correction Factor(dB/m) = Antenna Factor(dB/m) + Cable Factor(dB) – Pre-Amplifier Factor(dB)
3. Margin value = Emission Level – Limit value
4. The other emission levels were very low against the limit.
5. " \* ": Fundamental frequency.
6. " # ": The radiated frequency is out of the restricted band.

## BELOW 1GHz WORST-CASE DATA

### 802.11a

<b>Channel</b>	TX Channel 165	<b>Detector Function</b>	Quasi-Peak (QP)
<b>Frequency Range</b>	9kHz ~ 1GHz		

Antenna Polarity & Test Distance : Horizontal at 3 m								
No	Frequency (MHz)	Emission Level (dBuV/m)	Limit (dBuV/m)	Margin (dB)	Antenna Height (m)	Table Angle (Degree)	Raw Value (dBuV)	Correction Factor (dB/m)
1	149.02	27.90 QP	43.50	-15.60	2.25 H	260	34.46	-6.56
2	250.00	29.69 QP	46.00	-16.31	2.15 H	221	36.12	-6.43
3	375.03	35.98 QP	46.00	-10.02	1.84 H	96	38.46	-2.48
4	500.01	40.54 QP	46.00	-5.46	1.66 H	153	40.56	-0.02
5	625.00	39.84 QP	46.00	-6.16	1.42 H	251	36.81	3.03
6	749.98	41.12 QP	46.00	-4.88	1.08 H	240	36.14	4.98
7	875.02	41.02 QP	46.00	-4.98	1.74 H	238	34.14	6.88

#### Remarks:

1. Emission Level(dBuV/m) = Raw Value(dBuV) + Correction Factor(dB/m)
2. Correction Factor(dB/m) = Antenna Factor(dB/m) + Cable Factor(dB) – Pre-Amplifier Factor(dB)
3. Margin value = Emission Level – Limit value
4. The other emission levels were very low against the limit of frequency range 30MHz~1000MHz.
5. The emission levels were very low against the limit of frequency range 9kHz~30MHz: the amplitude of spurious emissions attenuated more than 20 dB below the permissible value to be report.

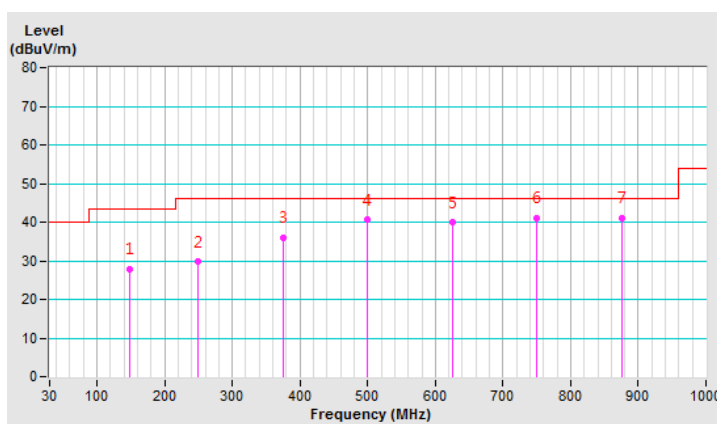

<b>Channel</b>	TX Channel 165	<b>Detector Function</b>	Quasi-Peak (QP)
<b>Frequency Range</b>	9kHz ~ 1GHz		

Antenna Polarity & Test Distance : Vertical at 3 m								
No	Frequency (MHz)	Emission Level (dBuV/m)	Limit (dBuV/m)	Margin (dB)	Antenna Height (m)	Table Angle (Degree)	Raw Value (dBuV)	Correction Factor (dB/m)
1	33.06	33.35 QP	40.00	-6.65	1.58 V	175	41.78	-8.43
2	149.16	26.70 QP	43.50	-16.80	1.14 V	219	33.25	-6.55
3	375.03	33.79 QP	46.00	-12.21	1.06 V	166	36.27	-2.48
4	500.01	40.34 QP	46.00	-5.66	1.22 V	124	40.36	-0.02
5	625.00	41.94 QP	46.00	-4.06	1.81 V	145	38.91	3.03
6	750.03	40.65 QP	46.00	-5.35	1.21 V	149	35.67	4.98
7	875.02	41.82 QP	46.00	-4.18	1.55 V	152	34.94	6.88

**Remarks:**

1. Emission Level(dBuV/m) = Raw Value(dBuV) + Correction Factor(dB/m)
2. Correction Factor(dB/m) = Antenna Factor(dB/m) + Cable Factor(dB) – Pre-Amplifier Factor(dB)
3. Margin value = Emission Level – Limit value
4. The other emission levels were very low against the limit of frequency range 30MHz~1000MHz.
5. The emission levels were very low against the limit of frequency range 9kHz~30MHz: the amplitude of spurious emissions attenuated more than 20 dB below the permissible value to be report.

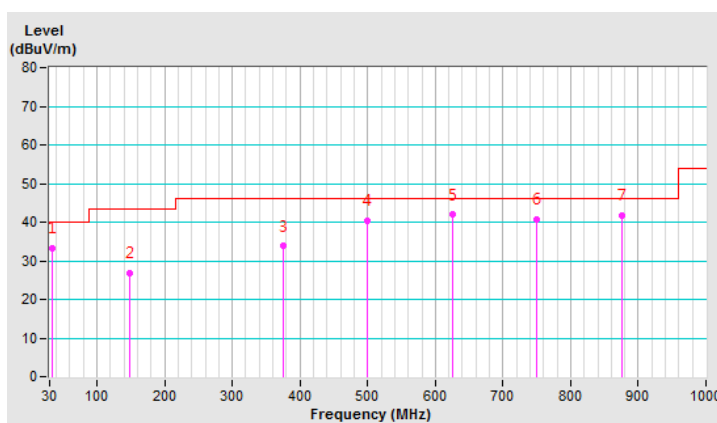

## 4.2 Conducted Emission Measurement

### 4.2.1 Limits of Conducted Emission Measurement

Frequency (MHz)	Conducted Limit (dBuV)	
	Quasi-peak	Average
0.15 - 0.5	66 - 56	56 - 46
0.50 - 5.0	56	46
5.0 - 30.0	60	50

Note: 1. The lower limit shall apply at the transition frequencies.

2. The limit decreases in line with the logarithm of the frequency in the range of 0.15 to 0.50MHz.

### 4.2.2 Test Instruments

Description & Manufacturer	Model No.	Serial No.	Cal. Date	Cal. Due
ROHDE & SCHWARZ TEST RECEIVER	ESCS30	100276	Apr. 16, 2020	Apr. 15, 2021
SCHWARZBECK Artificial Mains Network (for EUT)	NSLK 8128	8128-244	Nov. 11, 2019	Nov. 10, 2020
LISN With Adapter (for EUT)	AD10	C05Ada-001	Nov. 11, 2019	Nov. 10, 2020
ROHDE & SCHWARZ Artificial Mains Network (for peripheral)	ESH3-Z5	100220	Nov. 18, 2019	Nov. 17, 2020
Software	Cond_V7.3.7.4	NA	NA	NA
RF cable (JYEBAO) With 10dB PAD	5D-FB	Cable-C05.01	Jan. 30, 2020	Jan. 29, 2021
LYNICS Terminator (For R&S LISN)	0900510	E1-01-305	Feb. 17, 2020	Feb. 16, 2021

Note: 1. The calibration interval of the above test instruments is 12 months and the calibrations are traceable to NML/ROC and NIST/USA.

2. The test was performed in Shielded Room No. 5. (Conduction 5)



#### 4.2.3 Test Procedure

- The EUT was placed 0.4 meters from the conducting wall of the shielded room with EUT being connected to the power mains through a line impedance stabilization network (LISN). Other support units were connected to the power mains through another LISN. The two LISNs provide 50 ohm/ 50uH of coupling impedance for the measuring instrument.
- Both lines of the power mains connected to the EUT were checked for maximum conducted interference.
- The frequency range from 150kHz to 30MHz was searched. Emission levels under (Limit - 20dB) was not recorded.

**NOTE:** All modes of operation were investigated and the worst-case emissions are reported.

#### 4.2.4 Deviation from Test Standard

No deviation.

#### 4.2.5 Test Setup

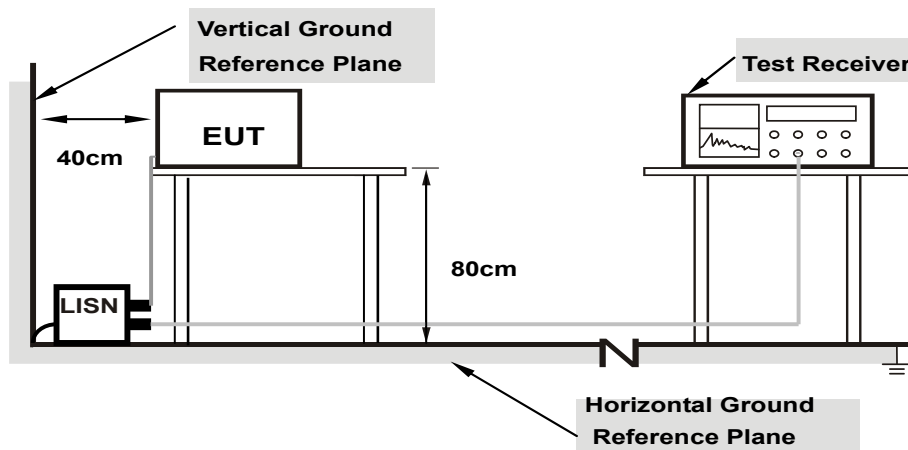

**Note: 1.Support units were connected to second LISN.**

For the actual test configuration, please refer to the attached file (Test Setup Photo).

#### 4.2.6 EUT Operating Condition

Same as Item 4.1.6.

#### 4.2.7 Test Results

<b>Frequency Range</b>	150kHz ~ 30MHz	<b>Detector Function &amp; Resolution Bandwidth</b>	Quasi-Peak (QP) / Average (AV), 9kHz
------------------------	----------------	---	--------------------------------------

Phase Of Power : Line (L)										
No	Frequency (MHz)	Correction Factor (dB)	Reading Value (dBuV)		Emission Level (dBuV)		Limit (dBuV)		Margin (dB)	
			Q.P.	AV.	Q.P.	AV.	Q.P.	AV.	Q.P.	AV.
1	0.16172	9.88	34.49	21.90	44.37	31.78	65.38	55.38	-21.01	-23.60
2	0.18125	9.88	31.78	20.31	41.66	30.19	64.43	54.43	-22.77	-24.24
<b>3</b>	<b>0.34141</b>	<b>9.89</b>	<b>31.54</b>	<b>25.56</b>	<b>41.43</b>	<b>35.45</b>	<b>59.17</b>	<b>49.17</b>	<b>-17.74</b>	<b>-13.72</b>
4	0.71250	9.92	11.82	5.31	21.74	15.23	56.00	46.00	-34.26	-30.77
5	10.99219	10.38	14.53	6.20	24.91	16.58	60.00	50.00	-35.09	-33.42
6	19.09766	10.78	22.36	11.55	33.14	22.33	60.00	50.00	-26.86	-27.67

**Remarks:**

1. Q.P. and AV. are abbreviations of quasi-peak and average individually.
2. The emission levels of other frequencies were very low against the limit.
3. Margin value = Emission level – Limit value
4. Correction factor = Insertion loss + Cable loss
5. Emission Level = Correction Factor + Reading Value

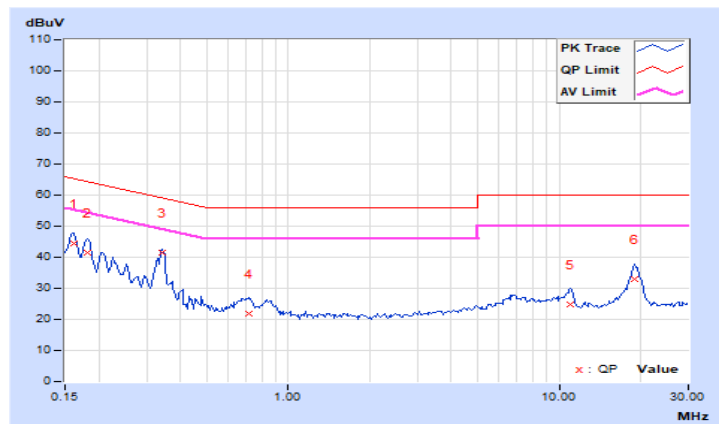

<b>Frequency Range</b>	150kHz ~ 30MHz	<b>Detector Function &amp; Resolution Bandwidth</b>	Quasi-Peak (QP) / Average (AV), 9kHz
------------------------	----------------	---	--------------------------------------

Phase Of Power : Neutral (N)										
No	Frequency (MHz)	Correction Factor (dB)	Reading Value (dBuV)		Emission Level (dBuV)		Limit (dBuV)		Margin (dB)	
			Q.P.	AV.	Q.P.	AV.	Q.P.	AV.	Q.P.	AV.
1	0.15781	9.89	33.49	19.72	43.38	29.61	65.58	55.58	-22.20	-25.97
2	0.18125	9.88	30.19	18.54	40.07	28.42	64.43	54.43	-24.36	-26.01
3	0.34141	9.89	25.90	19.23	35.79	29.12	59.17	49.17	-23.38	-20.05
4	0.71250	9.93	11.56	5.04	21.49	14.97	56.00	46.00	-34.51	-31.03
5	11.00000	10.44	14.41	6.48	24.85	16.92	60.00	50.00	-35.15	-33.08
6	19.16406	10.93	22.70	12.96	33.63	23.89	60.00	50.00	-26.37	-26.11

**Remarks:**

1. Q.P. and AV. are abbreviations of quasi-peak and average individually.
2. The emission levels of other frequencies were very low against the limit.
3. Margin value = Emission level – Limit value
4. Correction factor = Insertion loss + Cable loss
5. Emission Level = Correction Factor + Reading Value

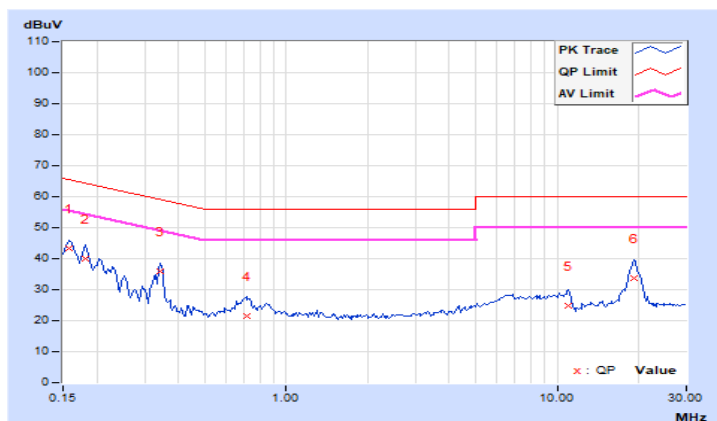

### 4.3 Transmit Power Measurement

#### 4.3.1 Limits of Transmit Power Measurement

Operation Band	EUT Category		Limit
U-NII-1		Outdoor Access Point	1 Watt (30 dBm) (Max. e.i.r.p $\leq$ 125mW(21 dBm) at any elevation angle above 30 degrees as measured from the horizon)
		Fixed point-to-point Access Point	1 Watt (30 dBm)
		Indoor Access Point	1 Watt (30 dBm)
	√	Client device	250mW (24 dBm)
U-NII-2A	--		250mW (24 dBm) or 11 dBm+10 log B*
U-NII-2C	--		250mW (24 dBm) or 11 dBm+10 log B*
U-NII-3	√		1 Watt (30 dBm)

\*B is the 26 dB emission bandwidth in megahertz

Per KDB 662911 Method of conducted output power measurement on IEEE 802.11 devices,

Array Gain = 0 dB (i.e., no array gain) for  $N_{ANT} \leq 4$ ;

Array Gain = 0 dB (i.e., no array gain) for channel widths  $\geq 40$  MHz for any  $N_{ANT}$ ;

Array Gain =  $5 \log(N_{ANT}/N_{SS})$  dB or 3 dB, whichever is less for 20-MHz channel widths with  $N_{ANT} \geq 5$ .

For power measurements on all other devices: Array Gain =  $10 \log(N_{ANT}/N_{SS})$  dB.

#### 4.3.2 Test Setup

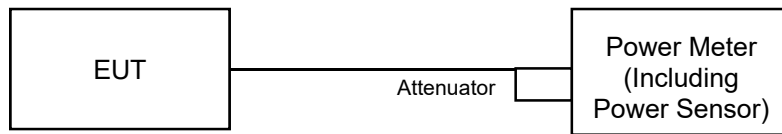

#### 4.3.3 Test Instruments

Refer to section 4.1.2 to get information of above instrument.

#### 4.3.4 Test Procedure

##### For Average Power Measurement

Method PM is used to perform output power measurement, trigger and gating function of wide band power meter is enabled to measure max output power of TX on burst and set the detector to average. Duty factor is not added to measured value.

#### 4.3.5 Deviation from Test Standard

No deviation.

#### 4.3.6 EUT Operating Condition

The software provided by client to enable the EUT under transmission condition continuously at lowest, middle and highest channel frequencies individually.

#### 4.3.7 Test Result

##### 802.11a

CHAN.	FREQ. (MHz)	Maximum Conducted Power (dBm)		Total Power (mW)	Total Power (dBm)	Power Limit (dBm)	Pass/Fail
		Chain 0	Chain 1				
36	5180	15.52	15.57	<b>71.703</b>	18.56	24	Pass
40	5200	15.53	15.49	71.127	18.52	24	Pass
48	5240	15.51	15.46	70.719	18.50	24	Pass
149	5745	20.52	20.91	236.03	23.73	30	Pass
157	5785	20.57	20.97	239.051	23.78	30	Pass
165	5825	20.55	20.93	237.381	23.75	30	Pass

##### 802.11ac (20MHz)

CHAN.	FREQ. (MHz)	Maximum Conducted Power (dBm)		Total Power (mW)	Total Power (dBm)	Power Limit (dBm)	Pass/Fail
		Chain 0	Chain 1				
36	5180	15.46	15.43	70.07	18.46	24	Pass
40	5200	15.50	15.47	70.718	18.50	24	Pass
48	5240	15.53	15.48	71.045	18.52	24	Pass
149	5745	20.48	20.83	232.746	23.67	30	Pass
157	5785	20.58	21.03	<b>241.053</b>	23.82	30	Pass
165	5825	20.54	20.95	237.691	23.76	30	Pass

##### 802.11ac (40MHz)

CHAN.	FREQ. (MHz)	Maximum Conducted Power (dBm)		Total Power (mW)	Total Power (dBm)	Power Limit (dBm)	Pass/Fail
		Chain 0	Chain 1				
38	5190	14.29	14.21	53.216	17.26	24	Pass
46	5230	15.54	15.52	71.455	18.54	24	Pass
151	5755	19.66	20.05	193.628	22.87	30	Pass
159	5795	19.72	20.13	196.795	22.94	30	Pass

##### 802.11ac (80MHz)

CHAN.	FREQ. (MHz)	Maximum Conducted Power (dBm)		Total Power (mW)	Total Power (dBm)	Power Limit (dBm)	Pass/Fail
		Chain 0	Chain 1				
42	5210	14.92	14.88	61.807	17.91	24	Pass
155	5775	19.71	20.11	196.106	22.92	30	Pass

## 4.4 Occupied Bandwidth Measurement

### 4.4.1 Test Setup

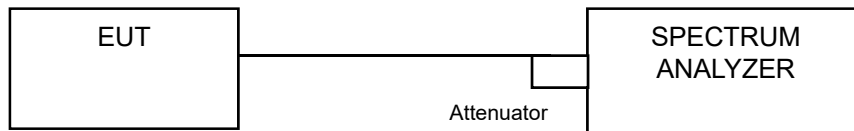

### 4.4.2 Test Instruments

Refer to section 4.1.2 to get information of above instrument.

### 4.4.3 Test Procedure

The transmitter output was connected to the spectrum analyzer through an attenuator. The bandwidth of the fundamental frequency was measured by spectrum analyzer with resolution bandwidth in the range of 1% to 5% of the anticipated emission bandwidth, and a video bandwidth at least 3x the resolution bandwidth and set the detector to SAMPLE. The width of a frequency band such that, below the lower and above the upper frequency limits, the mean powers emitted are each equal to a specified percentage 0.5 %of the total mean power of a given emission.

#### 4.4.4 Test Results

##### 802.11a

Channel	Channel Frequency (MHz)	Occupied Bandwidth (MHz)	
		Chain 0	Chain 1
36	5180	16.44	16.44
40	5200	16.44	16.44
48	5240	16.56	16.44
149	5745	28.35	28.80
157	5785	29.30	29.60
165	5825	29.60	28.20

##### 802.11ac (20MHz)

Channel	Channel Frequency (MHz)	Occupied Bandwidth (MHz)	
		Chain 0	Chain 1
36	5180	17.64	17.64
40	5200	17.64	17.64
48	5240	17.64	17.64
149	5745	29.73	29.90
157	5785	29.90	29.90
165	5825	29.10	28.80

##### 802.11ac (40MHz)

Channel	Channel Frequency (MHz)	Occupied Bandwidth (MHz)	
		Chain 0	Chain 1
38	5190	36.20	36.20
46	5230	36.40	36.40
151	5755	46.23	45.83
159	5795	48.16	49.50

##### 802.11ac (80MHz)

Channel	Channel Frequency (MHz)	Occupied Bandwidth (MHz)	
		Chain 0	Chain 1
42	5210	74.88	74.88
155	5775	80.96	85.96



### Spectrum Plot of Worst Value

#### 802.11a\_Chain0 / CH165

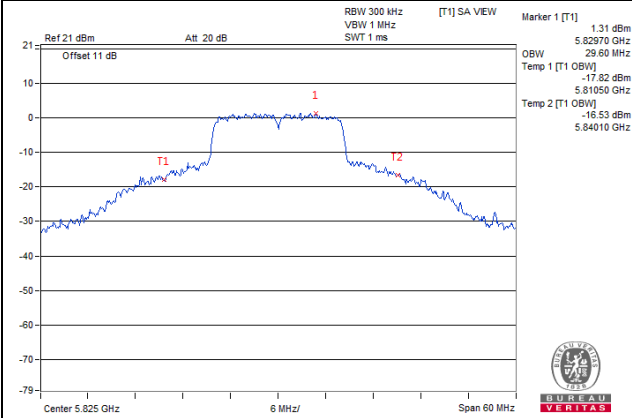

#### 802.11ac (20MHz)\_Chain0 / CH157

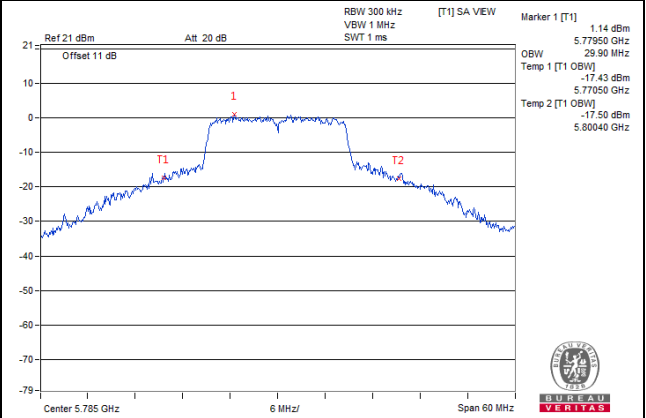

#### 802.11ac (40MHz)\_Chain1 / CH159

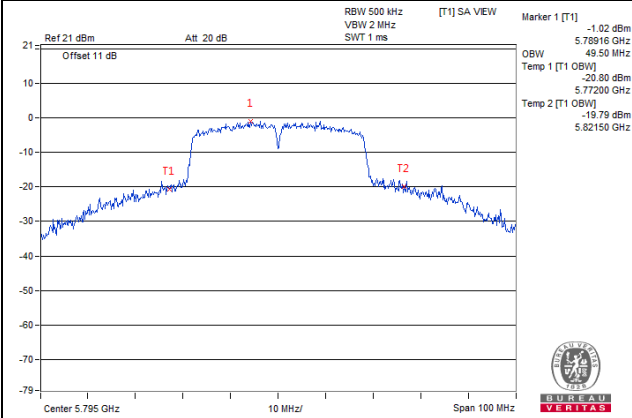

#### 802.11ac (80MHz)\_Chain1 / CH155

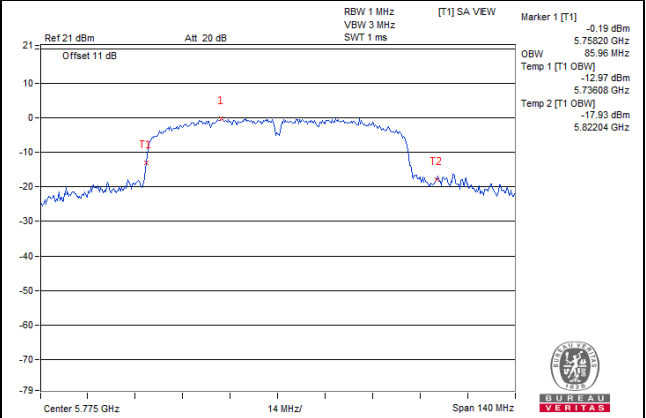

### Spectrum Plot for near by DFS band

#### 802.11a\_Chain0 / CH48

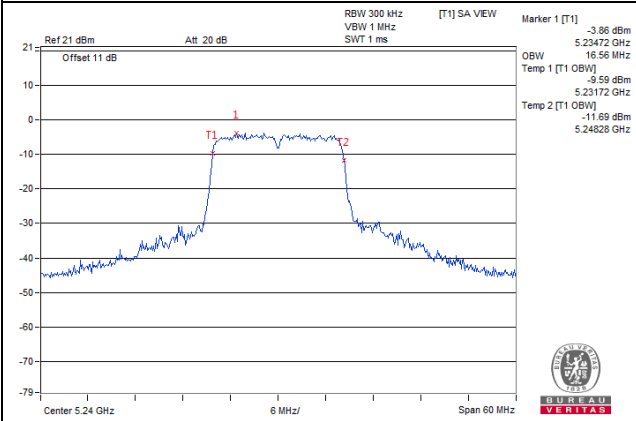

#### 802.11ac (20MHz)\_Chain0 / CH48

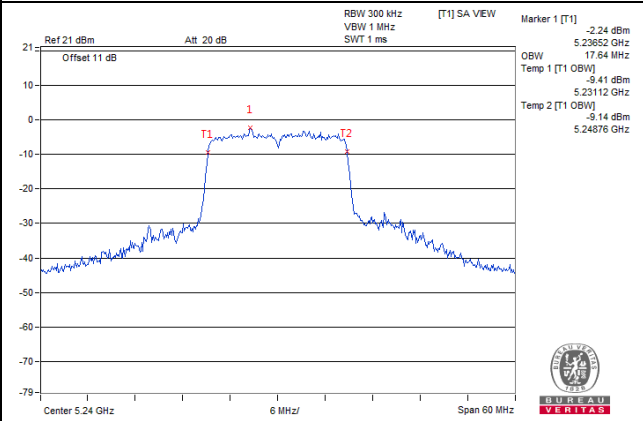

#### 802.11ac (40MHz)\_Chain0 / CH46

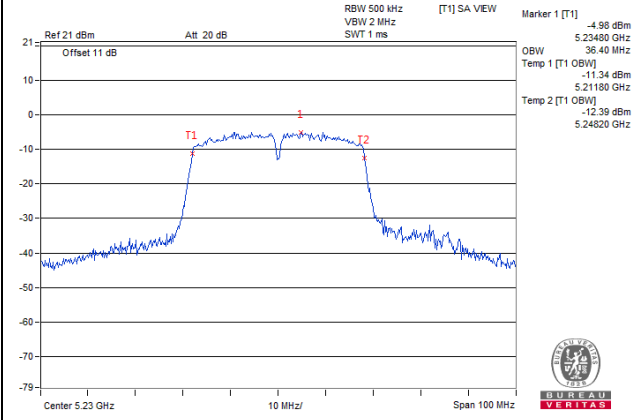

#### 802.11ac (80MHz)\_Chain0 / CH42

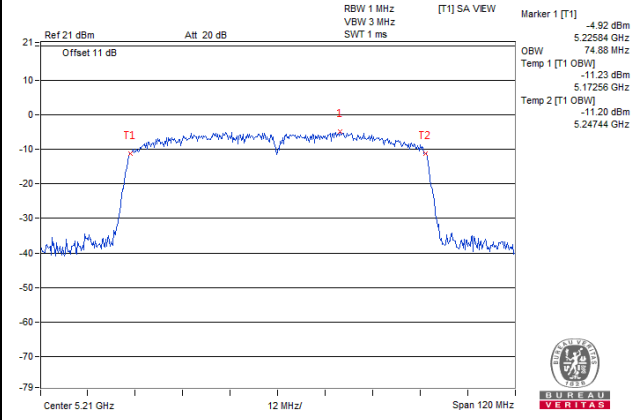

### Spectrum Plot for near by DFS band

#### 802.11a\_Chain1 / CH149

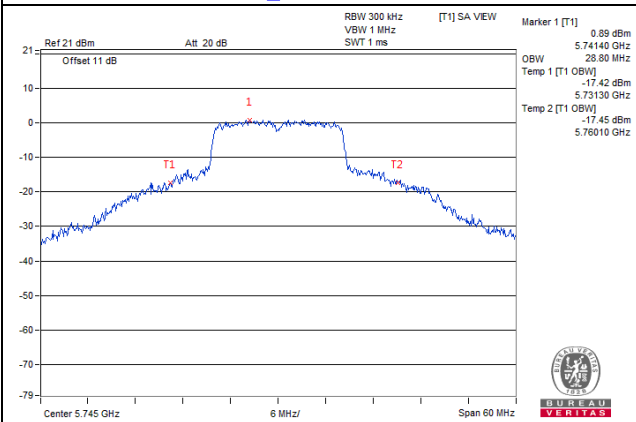

#### 802.11ac (20MHz)\_Chain1 / CH149

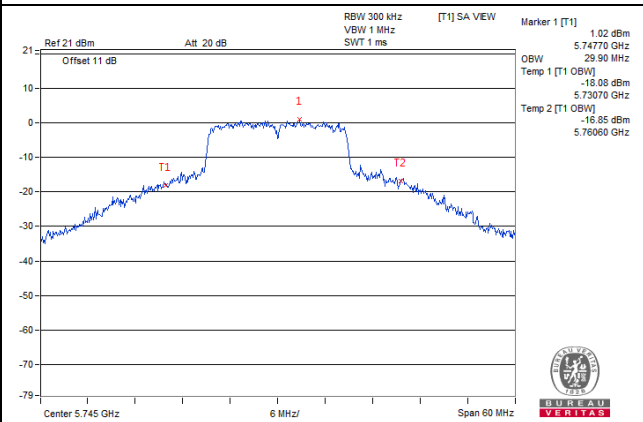

#### 802.11ac (40MHz)\_Chain0 / CH151

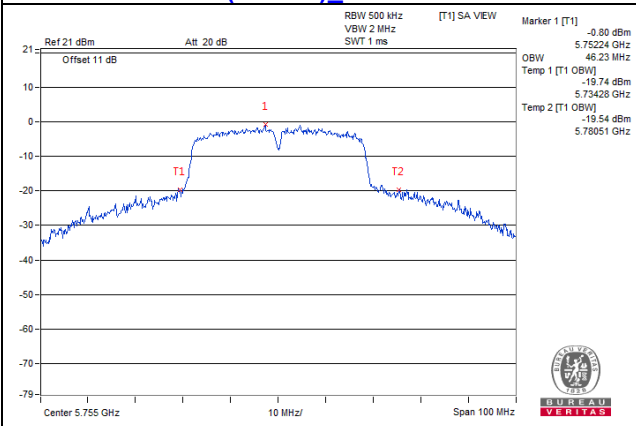

#### 802.11ac (80MHz)\_Chain1 / CH155

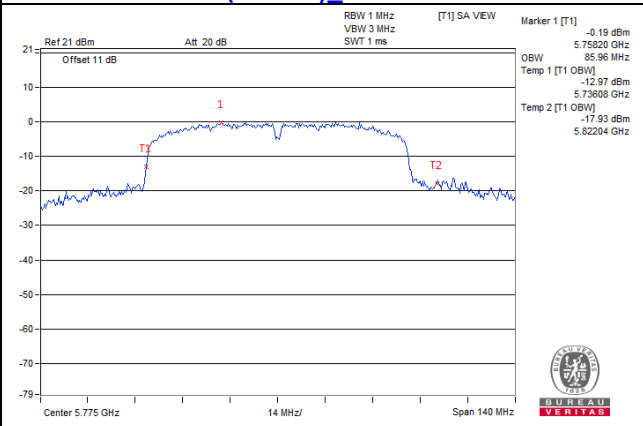

## 4.5 Peak Power Spectral Density Measurement

### 4.5.1 Limits of Peak Power Spectral Density Measurement

Operation Band	EUT Category		Limit
U-NII-1		Outdoor Access Point	17dBm/ MHz
		Fixed point-to-point Access Point	
		Indoor Access Point	
	√	Client device	11dBm/ MHz
U-NII-2A	--		11dBm/ MHz
U-NII-2C	--		11dBm/ MHz
U-NII-3	√		30dBm/ 500kHz

### 4.5.2 Test Setup

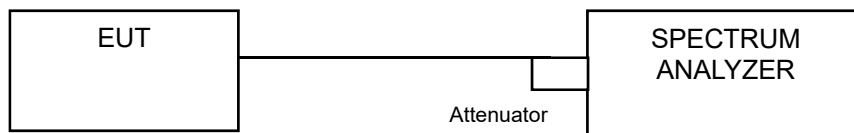

### 4.5.3 Test Instruments

Refer to section 4.1.2 to get information of above instrument.

### 4.5.4 Test Procedure

#### For U-NII-1 band:

Using method SA-2

- 1) Set span to encompass the entire emission bandwidth (EBW) of the signal.
- 2) Set RBW = 30 kHz, Set VBW ≥ 1 MHz, Detector = RMS
- 3) Set Channel power measure = 1MHz
- 4) Sweep time = auto, trigger set to “free run”.
- 5) Trace average at least 100 traces in power averaging mode.
- 6) Record the max value and add 10 log (1/duty cycle)

#### For U-NII-3 band:

- 1) Set span to encompass the entire emission bandwidth (EBW) of the signal.
- 2) Set RBW = 500 kHz, Set VBW ≥ 3 RBW, Detector = RMS
- 3) Sweep time = auto, trigger set to “free run”.
- 4) Trace average at least 100 traces in power averaging mode.
- 5) Record the max value and add 10 log (1/duty cycle)

### 4.5.5 Deviation from Test Standard

No deviation.

### 4.5.6 EUT Operating Condition

Same as Item 4.3.6.

#### 4.5.7 Test Results

#### For U-NII-1:

#### 802.11a

Chan.	Chan. Freq. (MHz)	PSD W/O Duty Factor (dBm)		Duty Factor (dB)	Total PSD With Duty Factor (dBm)	MAX. Limit (dBm)	Pass / Fail
		Chain 0	Chain 1				
36	5180	-8.22	-8.19	0.36	-4.83	10.69	Pass
40	5200	-8.11	-7.98	0.36	-4.67	10.69	Pass
48	5240	-7.82	-7.98	0.36	-4.53	10.69	Pass

- Note:**
1. Method E) 2) a) of power density measurement of KDB 662911 is using for calculating total power density. Total power density is summing entire spectra across corresponding frequency bins on the various outputs by computer.
  2. Directional gain =  $3.3\text{dBi} + 10\log(2) = 6.31\text{dBi} > 6\text{dBi}$  , so the power density limit shall be reduced to  $11-(6.31-6) = 10.69\text{dBm}$ .
  3. Refer to section 3.3 for duty cycle spectrum plot.

#### 802.11ac (20MHz)

Chan.	Chan. Freq. (MHz)	PSD W/O Duty Factor (dBm)		Duty Factor (dB)	Total PSD With Duty Factor (dBm)	MAX. Limit (dBm)	Pass / Fail
		Chain 0	Chain 1				
36	5180	-8.40	-8.31	0.28	-5.06	10.69	Pass
40	5200	-8.39	-8.38	0.28	-5.09	10.69	Pass
48	5240	-7.55	-7.83	0.28	-4.40	10.69	Pass

- Note:**
1. Method E) 2) a) of power density measurement of KDB 662911 is using for calculating total power density. Total power density is summing entire spectra across corresponding frequency bins on the various outputs by computer.
  2. Directional gain =  $3.3\text{dBi} + 10\log(2) = 6.31\text{dBi} > 6\text{dBi}$  , so the power density limit shall be reduced to  $11-(6.31-6) = 10.69\text{dBm}$ .
  3. Refer to section 3.3 for duty cycle spectrum plot.

#### 802.11ac (40MHz)

Chan.	Chan. Freq. (MHz)	PSD W/O Duty Factor (dBm)		Duty Factor (dB)	Total PSD With Duty Factor (dBm)	MAX. Limit (dBm)	Pass / Fail
		Chain 0	Chain 1				
38	5190	-14.57	-13.16	0.99	-9.81	10.69	Pass
46	5230	-11.70	-11.74	0.99	-7.72	10.69	Pass

- Note:**
1. Method E) 2) a) of power density measurement of KDB 662911 is using for calculating total power density. Total power density is summing entire spectra across corresponding frequency bins on the various outputs by computer.
  2. Directional gain =  $3.3\text{dBi} + 10\log(2) = 6.31\text{dBi} > 6\text{dBi}$  , so the power density limit shall be reduced to  $11-(6.31-6) = 10.69\text{dBm}$ .
  3. Refer to section 3.3 for duty cycle spectrum plot.

### 802.11ac (80MHz)

Chan.	Chan. Freq. (MHz)	PSD W/O Duty Factor (dBm)		Duty Factor (dB)	Total PSD With Duty Factor (dBm)	MAX. Limit (dBm)	Pass / Fail
		Chain 0	Chain 1				
42	5210	-15.97	-16.19	1.24	-11.83	10.69	Pass

- Note:**
- Method E) 2) a) of power density measurement of KDB 662911 is using for calculating total power density. Total power density is summing entire spectra across corresponding frequency bins on the various outputs by computer.
  - Directional gain =  $3.3\text{dBi} + 10\log(2) = 6.31\text{dBi} > 6\text{dBi}$ , so the power density limit shall be reduced to  $11 - (6.31 - 6) = 10.69\text{dBm}$ .
  - Refer to section 3.3 for duty cycle spectrum plot.

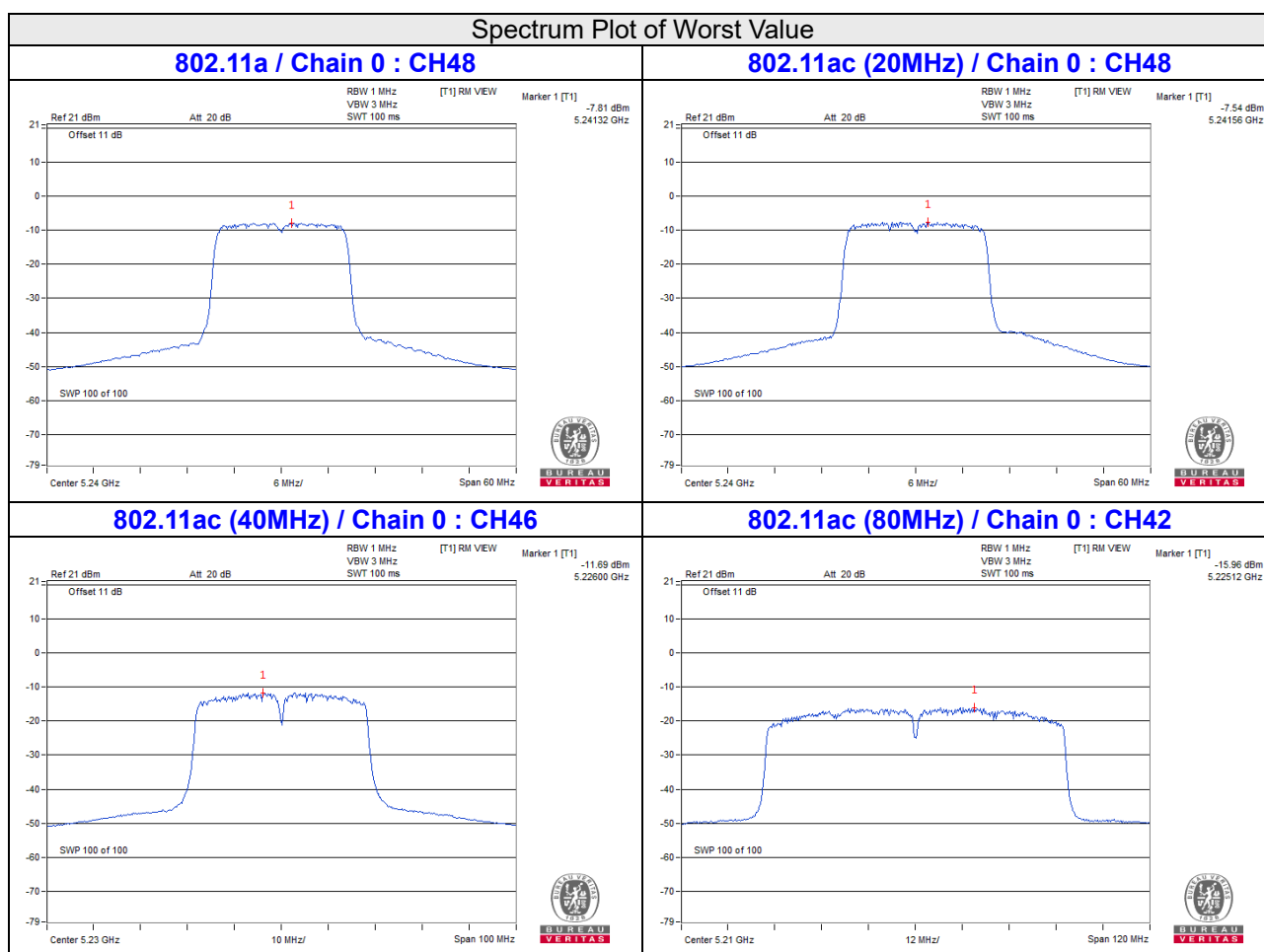

**For U-NII-3:**

**802.11a**

TX chain	Chan.	Chan. Freq. (MHz)	PSD W/O Duty Factor (dBm/500kHz)	10 log (N=2) dB	Duty Factor (dB)	Total PSD With Duty Factor (dBm/500kHz)	Limit (dBm/500kHz)	Pass /Fail
0	149	5745	-11.53	3.01	0.36	-8.16	29.69	Pass
	157	5785	-11.81	3.01	0.36	-8.44	29.69	Pass
	165	5825	-11.56	3.01	0.36	-8.19	29.69	Pass
1	149	5745	-11.50	3.01	0.36	-8.13	29.69	Pass
	157	5785	-11.72	3.01	0.36	-8.35	29.69	Pass
	165	5825	-11.69	3.01	0.36	-8.32	29.69	Pass

- Note:**
- Method E) 2) c) of power density measurement of KDB 662911 is using for calculating total power density.
  - Directional gain =  $3.3\text{dBi} + 10\log(2) = 6.31\text{dBi} > 6\text{dBi}$  , so the power density limit shall be reduced to  $30-(6.31-6) = 29.69\text{dBm}$ .
  - Refer to section 3.3 for duty cycle spectrum plot.

**802.11ac (20MHz)**

TX chain	Chan.	Chan. Freq. (MHz)	PSD W/O Duty Factor (dBm/500kHz)	10 log (N=2) dB	Duty Factor (dB)	Total PSD With Duty Factor (dBm/500kHz)	Limit (dBm/500kHz)	Pass /Fail
0	149	5745	-11.70	3.01	0.28	-8.41	29.69	Pass
	157	5785	-12.18	3.01	0.28	-8.89	29.69	Pass
	165	5825	-12.11	3.01	0.28	-8.82	29.69	Pass
1	149	5745	-11.84	3.01	0.28	-8.55	29.69	Pass
	157	5785	-12.25	3.01	0.28	-8.96	29.69	Pass
	165	5825	-12.28	3.01	0.28	-8.99	29.69	Pass

- Note:**
- Method E) 2) c) of power density measurement of KDB 662911 is using for calculating total power density.
  - Directional gain =  $3.3\text{dBi} + 10\log(2) = 6.31\text{dBi} > 6\text{dBi}$  , so the power density limit shall be reduced to  $30-(6.31-6) = 29.69\text{dBm}$ .
  - Refer to section 3.3 for duty cycle spectrum plot.

### 802.11ac (40MHz)

TX chain	Chan.	Chan. Freq. (MHz)	PSD W/O Duty Factor (dBm/500kHz)	10 log (N=2) dB	Duty Factor (dB)	Total PSD With Duty Factor (dBm/500kHz)	Limit (dBm/500kHz)	Pass /Fail
0	151	5755	-16.17	3.01	0.99	-12.17	29.69	Pass
	159	5795	-17.04	3.01	0.99	-13.04	29.69	Pass
1	151	5755	-16.62	3.01	0.99	-12.62	29.69	Pass
	159	5795	-16.92	3.01	0.99	-12.92	29.69	Pass

- Note:**
1. Method E) 2) c) of power density measurement of KDB 662911 is using for calculating total power density.
  2. Directional gain =  $3.3\text{dBi} + 10\log(2) = 6.31\text{dBi} > 6\text{dBi}$  , so the power density limit shall be reduced to  $30-(6.31-6) = 29.69\text{dBm}$ .
  3. Refer to section 3.3 for duty cycle spectrum plot.

### 802.11ac (80MHz)

TX chain	Chan.	Chan. Freq. (MHz)	PSD W/O Duty Factor (dBm/500kHz)	10 log (N=2) dB	Duty Factor (dB)	Total PSD With Duty Factor (dBm/500kHz)	Limit (dBm/500kHz)	Pass /Fail
0	155	5775	-19.99	3.01	1.24	-15.74	29.69	Pass
1	155	5775	-20.52	3.01	1.24	-16.27	29.69	Pass

- Note:**
1. Method E) 2) c) of power density measurement of KDB 662911 is using for calculating total power density.
  2. Directional gain =  $3.3\text{dBi} + 10\log(2) = 6.31\text{dBi} > 6\text{dBi}$  , so the power density limit shall be reduced to  $30-(6.31-6) = 29.69\text{dBm}$ .
  3. Refer to section 3.3 for duty cycle spectrum plot.



### Spectrum Plot of Worst Value

**802.11a / Chain 1 : CH149**

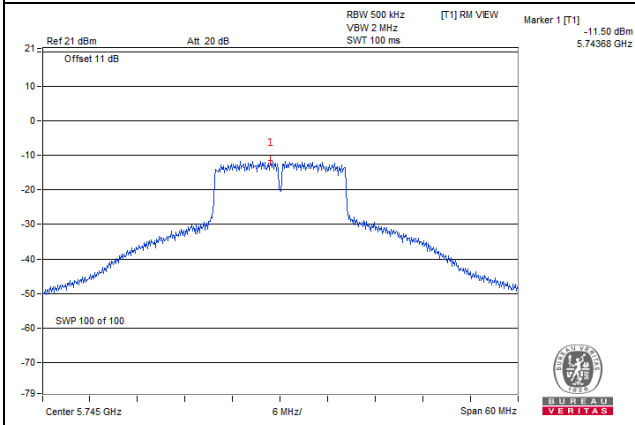

**802.11ac (20MHz) / Chain 0 : CH149**

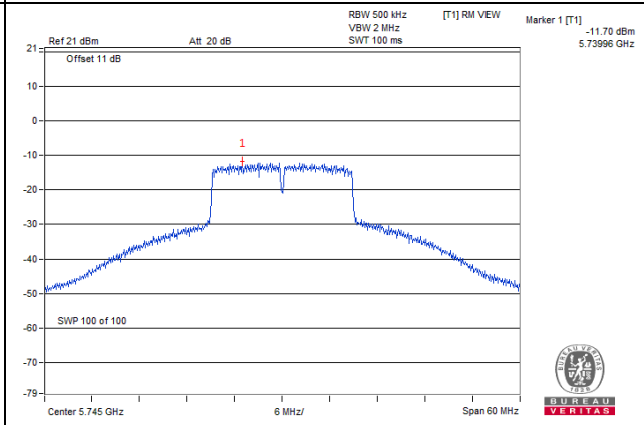

**802.11ac (40MHz) / Chain 0 : CH151**

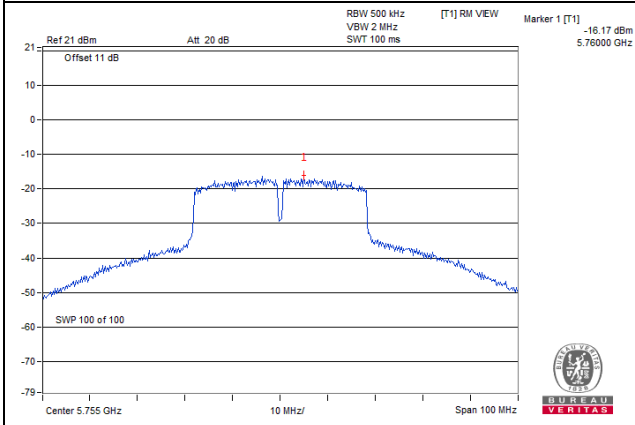

**802.11ac (80MHz) / Chain 0 : CH155**

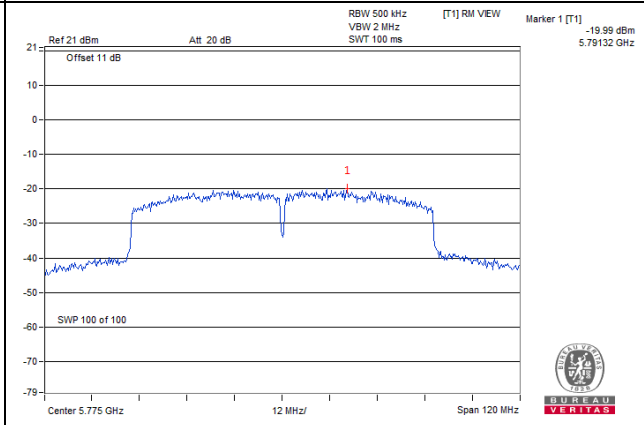

## 4.6 Frequency Stability Measurement

### 4.6.1 Limits of Frequency Stability Measurement

The frequency of the carrier signal shall be maintained within band of operation

### 4.6.2 Test Setup

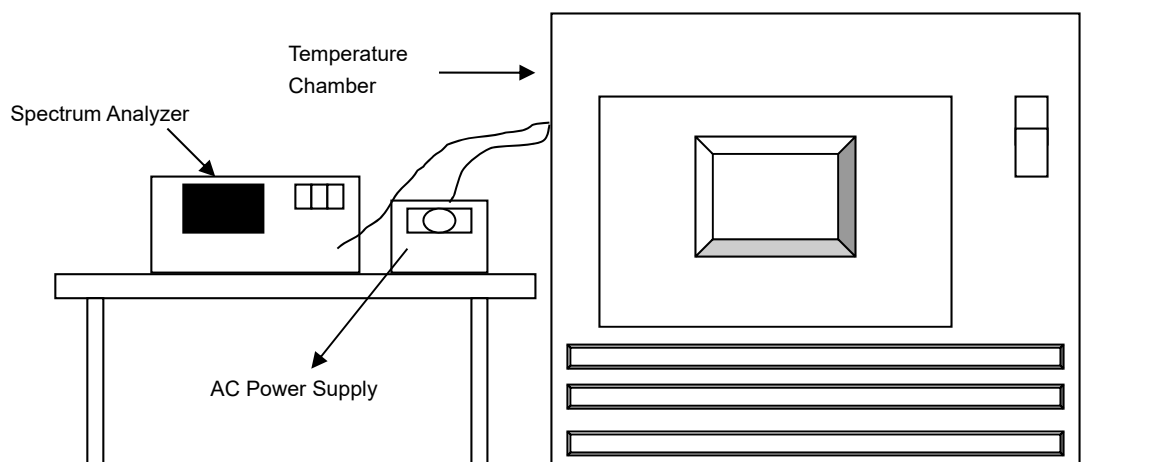

### 4.6.3 Test Instruments

Refer to section 4.1.2 to get information of above instrument.

### 4.6.4 Test Procedure

- The EUT was placed inside the environmental test chamber and powered by nominal AC voltage.
- Turn the EUT on and couple its output to a spectrum analyzer.
- Turn the EUT off and set the chamber to the highest temperature specified.
- Allow sufficient time (approximately 30 min) for the temperature of the chamber to stabilize, turn the EUT on and measure the operating frequency after 2, 5, and 10 minutes.
- Repeat step d with the temperature chamber set to the next desired temperature.
- The test chamber was allowed to stabilize at +20 degree C for a minimum of 30 minutes. The supply voltage was then adjusted on the EUT from 85% to 115% and the frequency record.

### 4.6.5 Deviation from Test Standard

No deviation.

### 4.6.6 EUT Operating Condition

Set the EUT transmit at un-modulation mode to test frequency stability.

4.6.7 Test Results

Frequency Stability Versus Temp.									
Operating Frequency: 5180 MHz									
TEMP. (°C)	Power Supply (Vac)	0 Minute		2 Minute		5 Minute		10 Minute	
		Measured Frequency (MHz)	Pass/Fail	Measured Frequency (MHz)	Pass/Fail	Measured Frequency (MHz)	Pass/Fail	Measured Frequency (MHz)	Pass/Fail
40	120	5180.0149	Pass	5180.0116	Pass	5180.0141	Pass	5180.0145	Pass
30	120	5179.9907	Pass	5179.9887	Pass	5179.9892	Pass	5179.9908	Pass
20	120	5179.9731	Pass	5179.9769	Pass	5179.9757	Pass	5179.9731	Pass
10	120	5180.0235	Pass	5180.0242	Pass	5180.0265	Pass	5180.0268	Pass
0	120	5180.0062	Pass	5180.0075	Pass	5180.0076	Pass	5180.0068	Pass

Frequency Stability Versus Voltage									
Operating Frequency: 5180 MHz									
TEMP. (°C)	Power Supply (Vac)	0 Minute		2 Minute		5 Minute		10 Minute	
		Measured Frequency (MHz)	Pass/Fail	Measured Frequency (MHz)	Pass/Fail	Measured Frequency (MHz)	Pass/Fail	Measured Frequency (MHz)	Pass/Fail
20	138	5179.9733	Pass	5179.9769	Pass	5179.9766	Pass	5179.9733	Pass
	120	5179.9731	Pass	5179.9769	Pass	5179.9757	Pass	5179.9731	Pass
	102	5179.9736	Pass	5179.9768	Pass	5179.9748	Pass	5179.9741	Pass

## 4.7 6dB Bandwidth Measurement

### 4.7.1 Limits of 6dB Bandwidth Measurement

The minimum of 6dB Bandwidth Measurement is 0.5MHz.

### 4.7.2 Test Setup

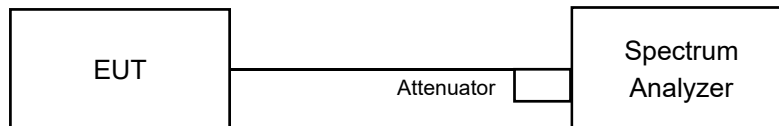

### 4.7.3 Test Instruments

Refer to section 4.3.3 to get information of above instrument.

### 4.7.4 Test Procedure

#### MEASUREMENT PROCEDURE REF

- Set resolution bandwidth (RBW) = 100kHz
- Set the video bandwidth (VBW)  $\geq 3 \times$  RBW, Detector = Peak.
- Trace mode = max hold.
- Sweep = auto couple.
- Measure the maximum width of the emission that is constrained by the frequencies associated with the two amplitude points (upper and lower) that are attenuated by 6 dB relative to the maximum level measured in the fundamental emission

### 4.7.5 Deviation from Test Standard

No deviation.

### 4.7.6 EUT Operating Condition

The software provided by client to enable the EUT under transmission condition continuously at lowest, middle and highest channel frequencies individually.

#### 4.7.7 Test Results

##### 802.11a

Channel	Frequency (MHz)	6dB Bandwidth (MHz)		Minimum Limit (MHz)	Pass / Fail
		Chain 0	Chain 1		
149	5745	16.36	16.37	0.5	PASS
157	5785	16.39	16.39	0.5	PASS
165	5825	16.38	16.35	0.5	PASS

##### 802.11ac (20MHz)

Channel	Frequency (MHz)	6dB Bandwidth (MHz)		Minimum Limit (MHz)	Pass / Fail
		Chain 0	Chain 1		
149	5745	17.58	17.56	0.5	PASS
157	5785	17.55	17.57	0.5	PASS
165	5825	17.56	17.56	0.5	PASS

##### 802.11ac (40MHz)

Channel	Frequency (MHz)	6dB Bandwidth (MHz)		Minimum Limit (MHz)	Pass / Fail
		Chain 0	Chain 1		
151	5755	35.17	35.22	0.5	PASS
159	5795	35.22	35.21	0.5	PASS

##### 802.11ac (80MHz)

Channel	Frequency (MHz)	6dB Bandwidth (MHz)		Minimum Limit (MHz)	Pass / Fail
		Chain 0	Chain 1		
155	5775	73.93	75.22	0.5	PASS

Spectrum Plot of Worst Value

802.11a\_Chain 1 / CH165

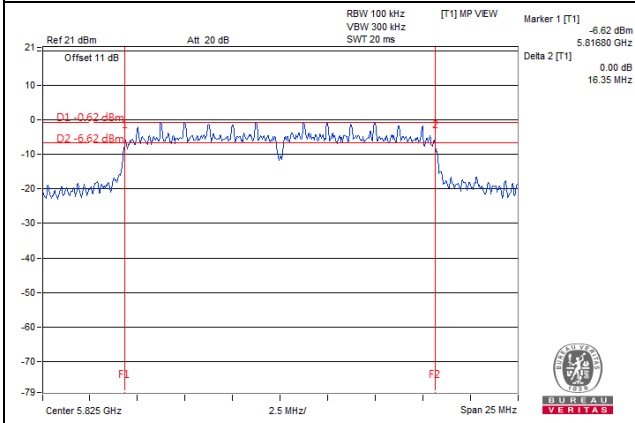

802.11ac (20MHz)\_Chain 0 / CH157

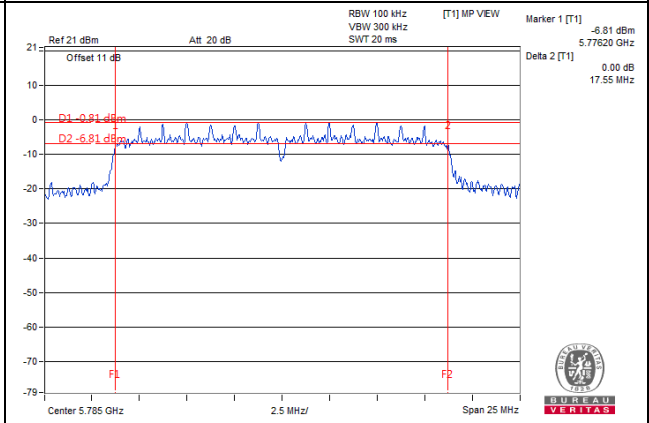

802.11ac (40MHz)\_Chain 0 / CH151

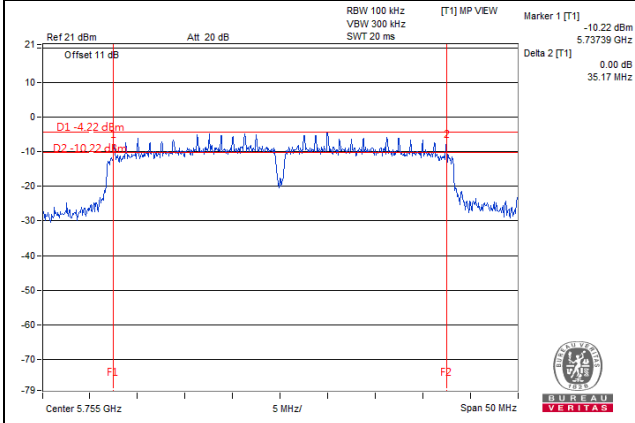

802.11ac (80MHz)\_Chain 0 / CH155

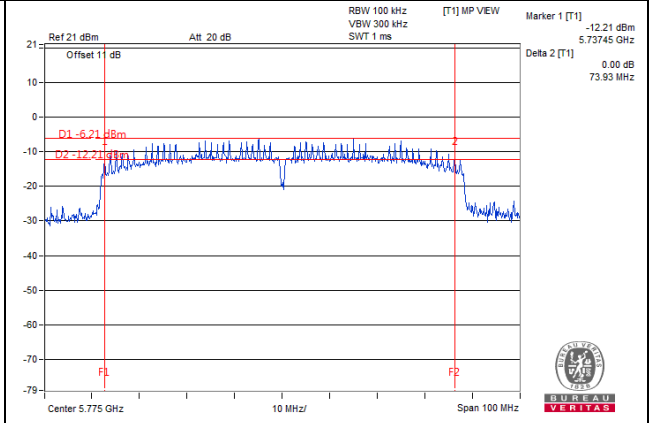

## 5 Pictures of Test Arrangements

Please refer to the attached file (Test Setup Photo).

### Annex A- Radiated Out of Band Emission (OOBE) Measurement (For U-NII-3 band)

802.11a

**CH 149 5745 MHz**

**Horizontal**

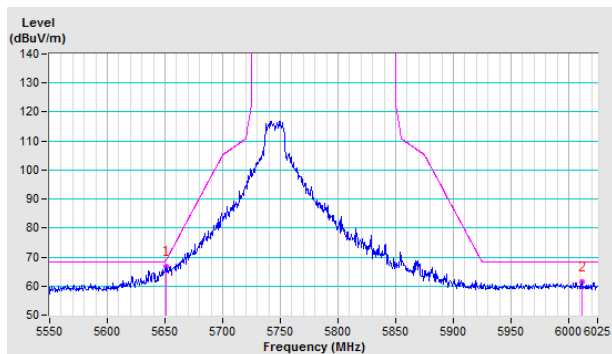

**Vertical**

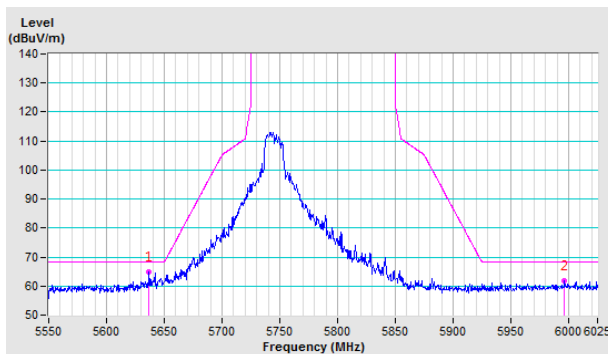

**CH 157 5785 MHz**

**Horizontal**

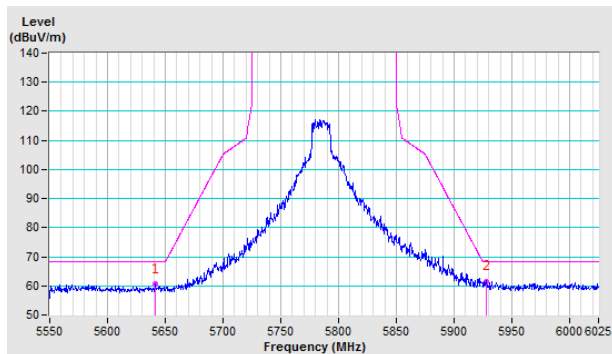

**Vertical**

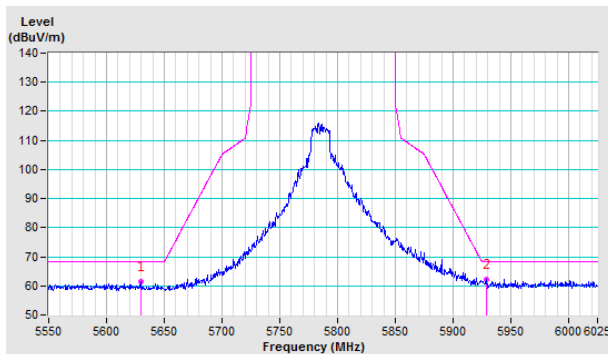

**CH 165 5825 MHz**

**Horizontal**

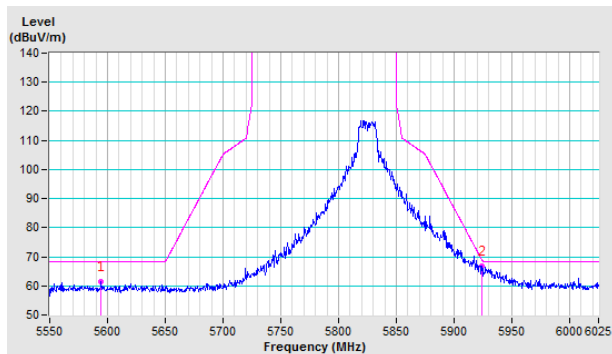

**Vertical**

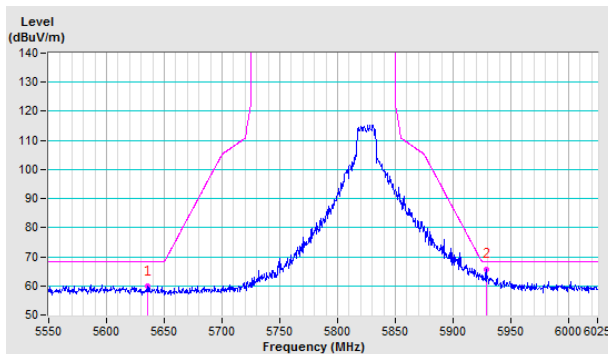



802.11ac (20MHz)

CH 149 5745 MHz

Horizontal

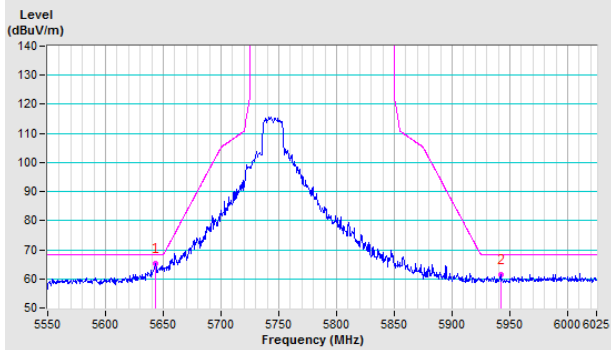

Vertical

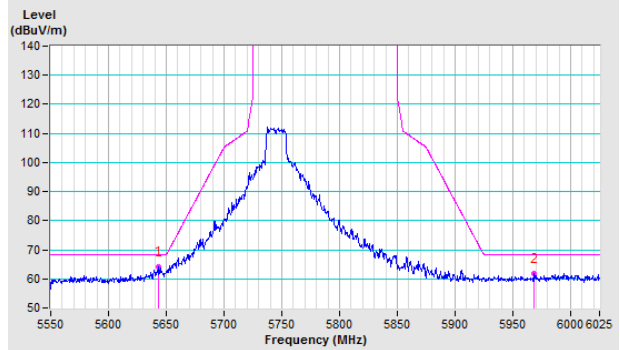

CH 157 5785 MHz

Horizontal

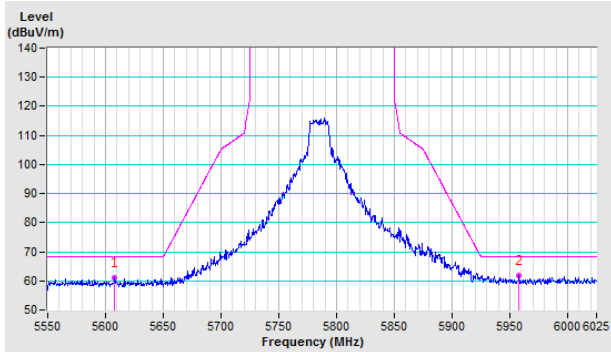

Vertical

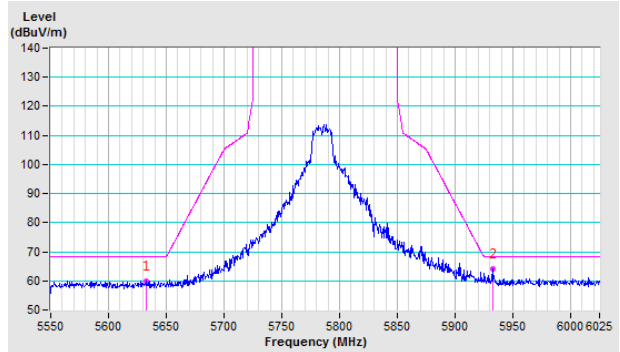

CH 165 5825 MHz

Horizontal

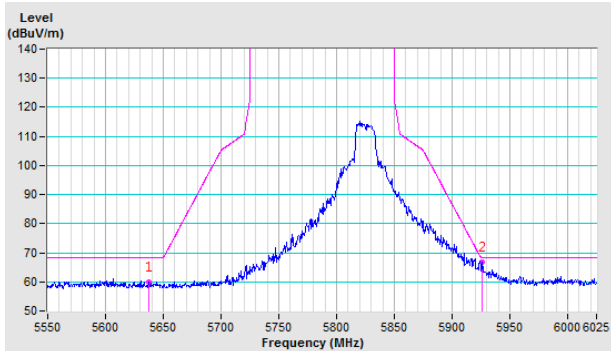

Vertical

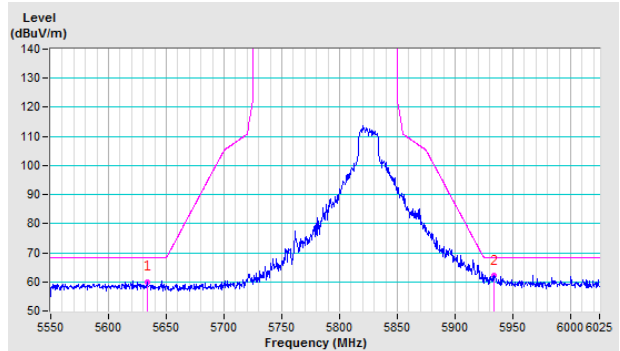

### 802.11ac (40MHz)

**CH 151 5755 MHz**

**Horizontal**

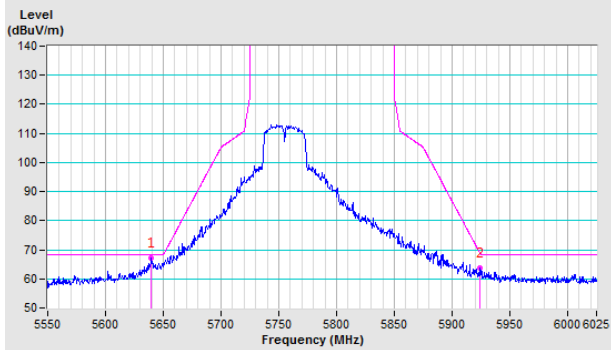

**Vertical**

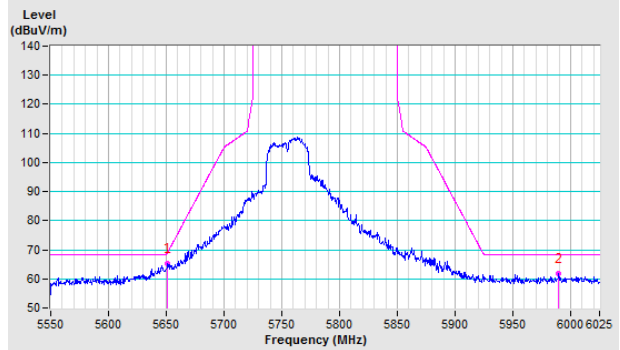

**CH 159 5795 MHz**

**Horizontal**

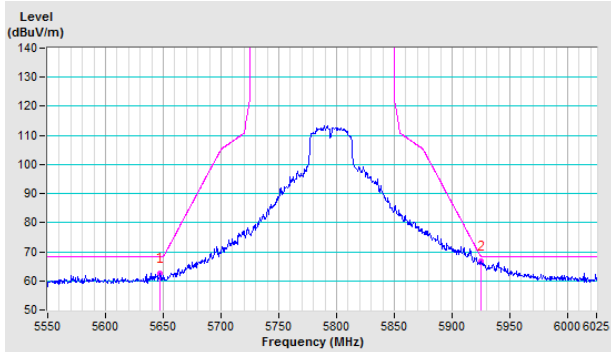

**Vertical**

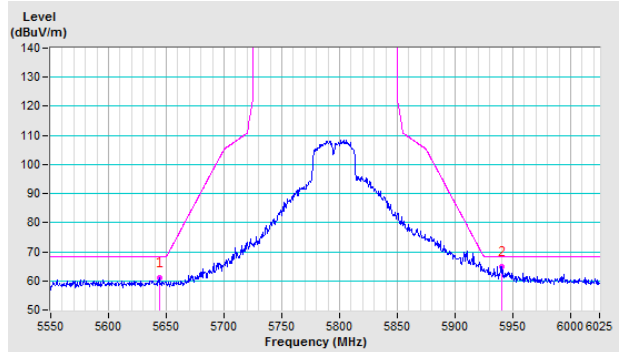

### 802.11ac (80MHz)

**CH 155 5775 MHz**

**Horizontal**

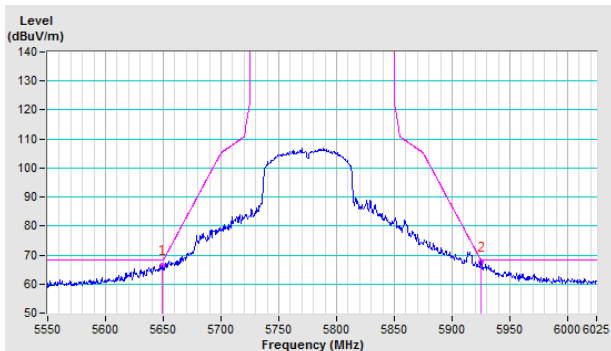

**Vertical**

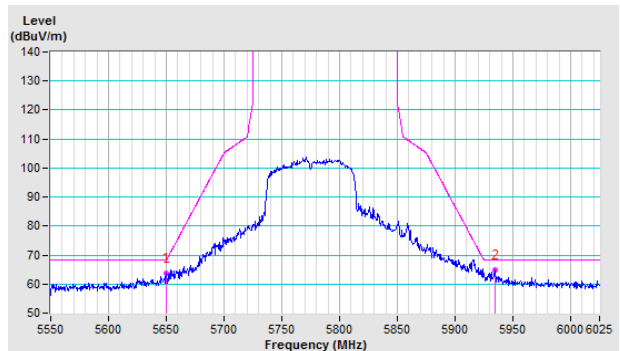

# Annex B- Band Edge Measurement

802.11a

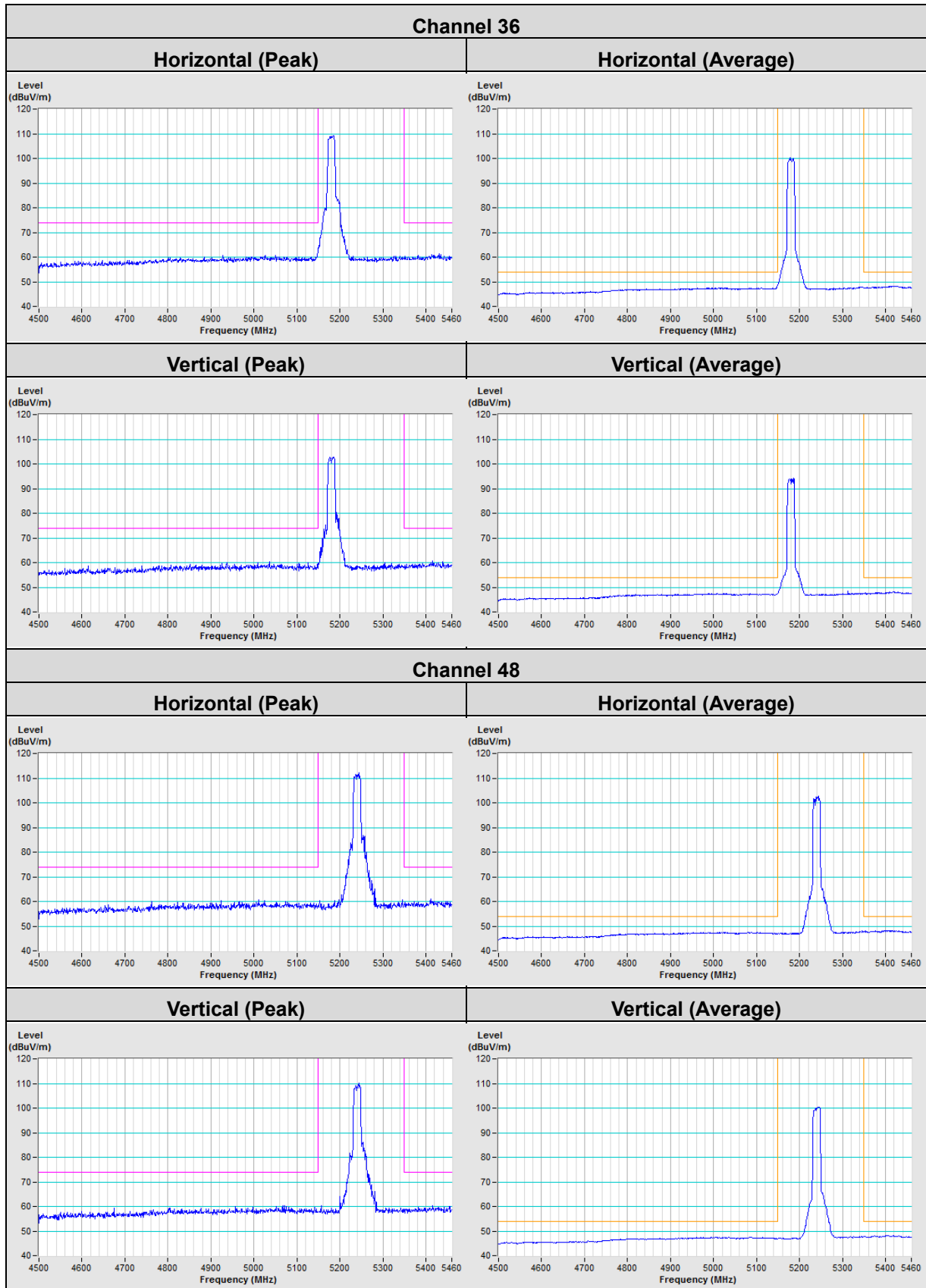

802.11ac (20MHz)

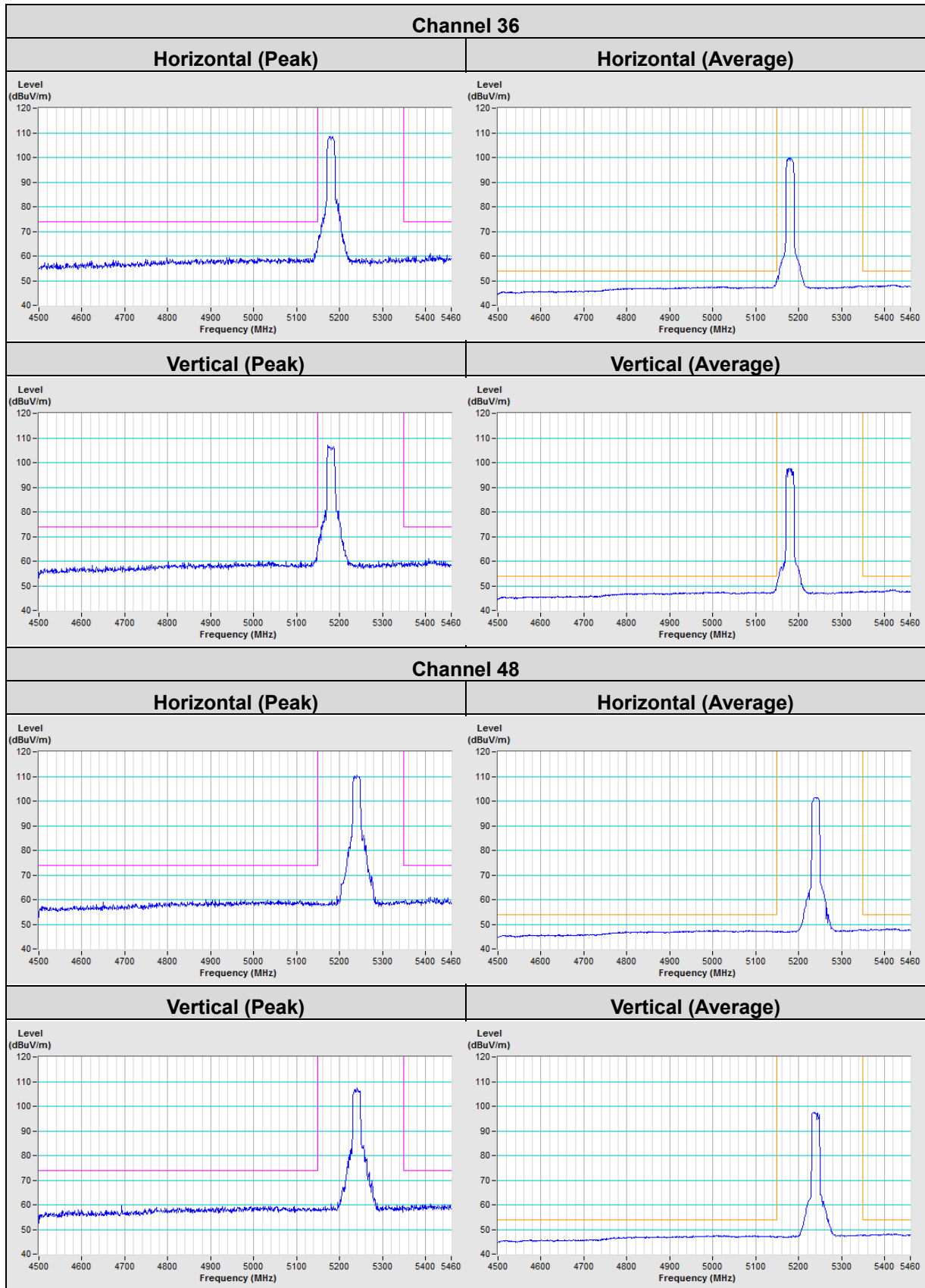

802.11ac (40MHz)

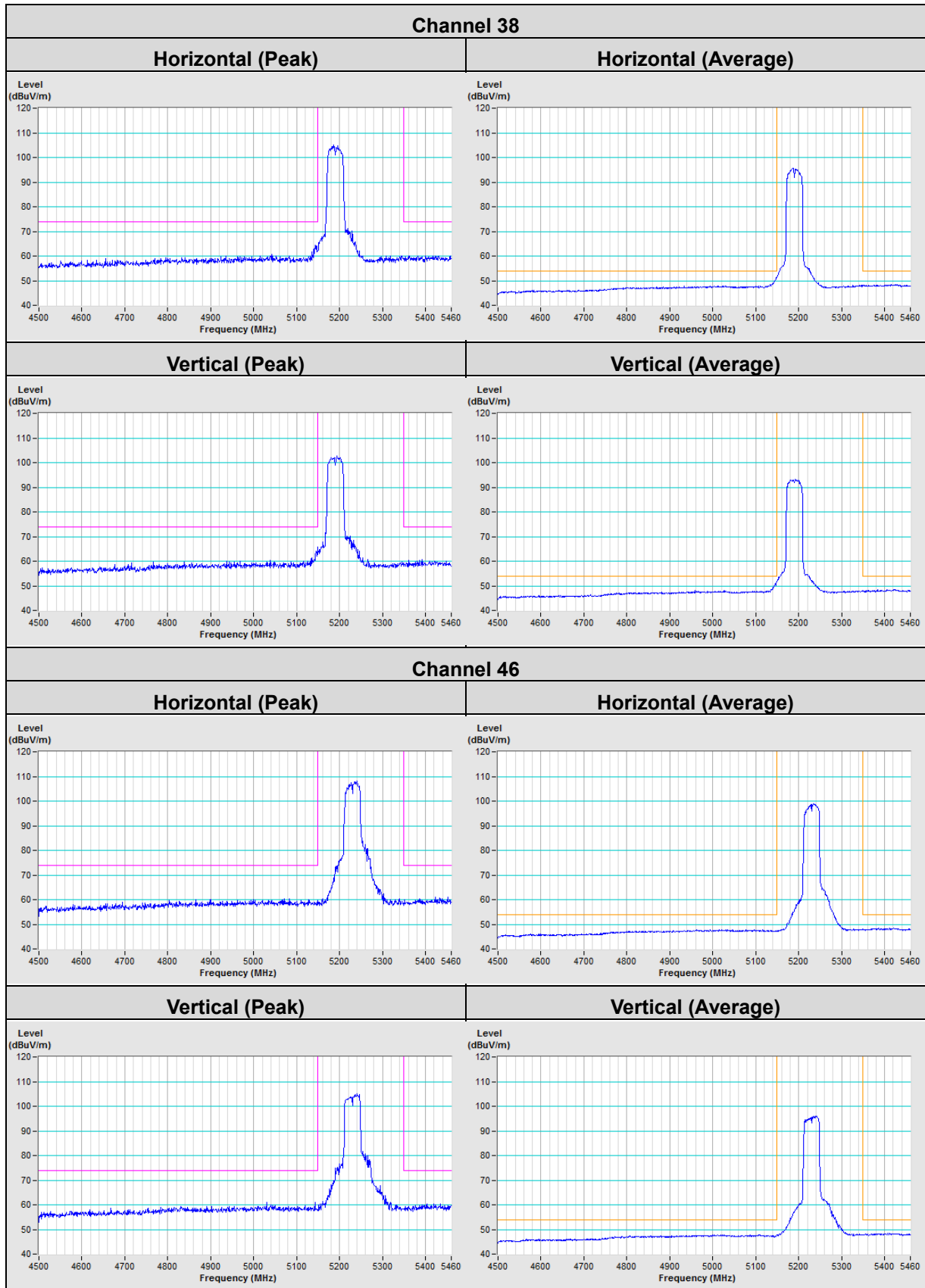

802.11ac (80MHz)

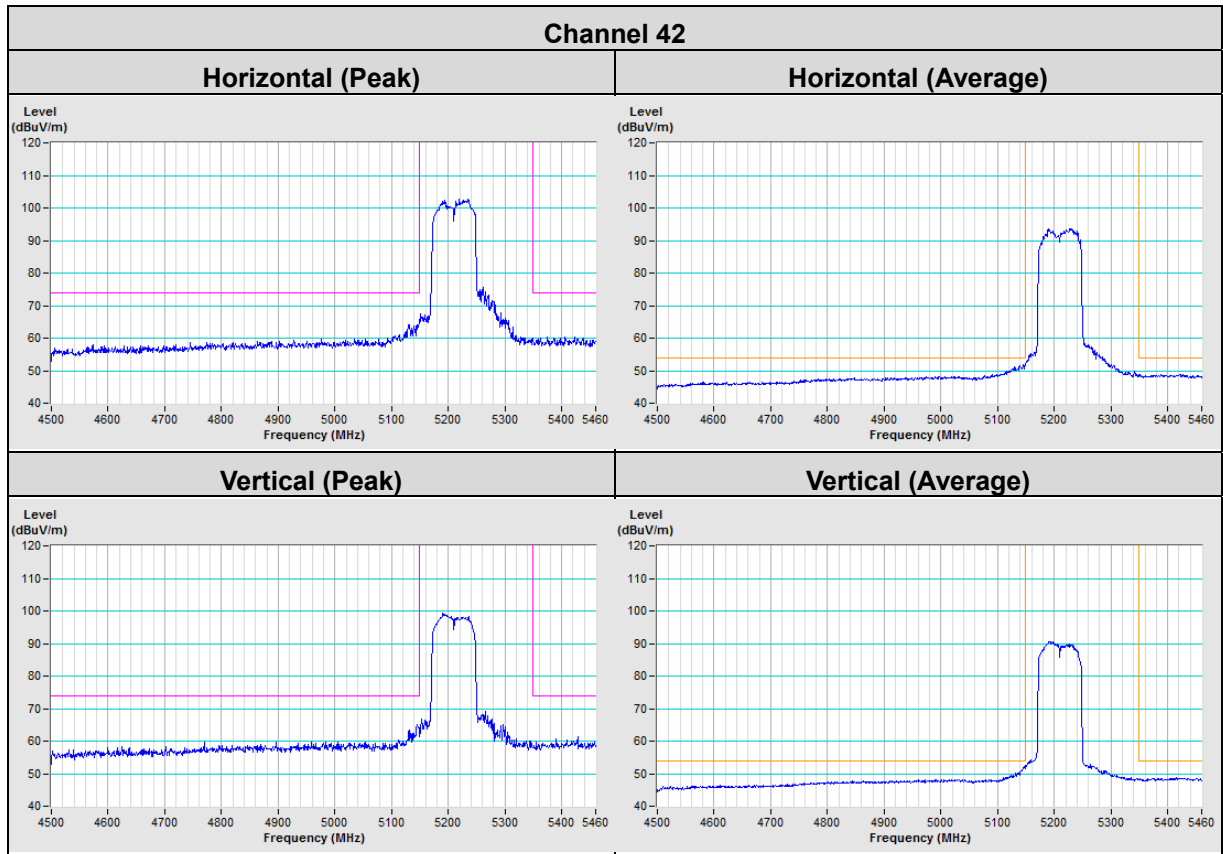

## Appendix – Information of the Testing Laboratories

We, Bureau Veritas Consumer Products Services (H.K.) Ltd., Taoyuan Branch, were founded in 1988 to provide our best service in EMC, Radio, Telecom and Safety consultation. Our laboratories are FCC recognized accredited test firms and accredited according to ISO/IEC 17025.

If you have any comments, please feel free to contact us at the following:

**Lin Kou EMC/RF Lab**

Tel: 886-2-26052180

Fax: 886-2-26051924

**Hsin Chu EMC/RF/Telecom Lab**

Tel: 886-3-6668565

Fax: 886-3-6668323

**Hwa Ya EMC/RF/Safety Lab**

Tel: 886-3-3183232

Fax: 886-3-3270892

**Email:** [service.adt@tw.bureauveritas.com](mailto:service.adt@tw.bureauveritas.com)

**Web Site:** [www.bureauveritas-adt.com](http://www.bureauveritas-adt.com)

The address and road map of all our labs can be found in our web site also.

--- END ---