



TEST REPORT

Report Reference No...... : **TRE1710010202** R/C.....: 40666

FCC ID..... : 2AK4CPP211NV5LRV

Applicant's name..... : **Petcube, Inc.**

Address..... : 2711 Centerville Road,Suite 400,Wilmington,Delaware19808, USA

Manufacturer..... : Yitoe Digital Technology Co.,LTD.

Address..... : 6/F,Yitoe Building,KejiSouth Road 5th,Hi-tech Industrial Park, Nanshan District,Shenzhen

Test item description : **Petcube Play**

Trade Mark : Petcube

Model/Type reference..... : PP211NV5LRV

Listed Model(s)..... : -

Standard : **FCC CFR Title 47 Part 15 Subpart C Section 15.247**

Date of receipt of test sample..... : Oct.20,2017

Date of testing..... : Oct.21,2017- Nov.01,2017

Date of issue..... : Nov.02,2017

Result..... : **PASS**

Compiled by
(Position+Printed name+Signature): File administrators Candy Liu *Candy Liu*

Supervised by
(Position+Printed name+Signature): Project Engineer : Edward Pan *Edward Pan*

Approved by
(Position+Printed name+Signature): RF Manager Hans Hu *Hans Hu*

Testing Laboratory Name : **Shenzhen Huatongwei International Inspection Co., Ltd.**

Address..... : 1/F, Bldg 3, Hongfa Hi-tech Industrial Park, Genyu Road, Tianliao, Gongming, Shenzhen, China

Shenzhen Huatongwei International Inspection Co., Ltd. All rights reserved.

This publication may be reproduced in whole or in part for non-commercial purposes as long as the Shenzhen Huatongwei International Inspection Co., Ltd. is acknowledged as copyright owner and source of the material. Shenzhen Huatongwei International Inspection Co., Ltd. takes no responsibility for and will not assume liability for damages resulting from the reader's interpretation of the reproduced material due to its placement and context.

The test report merely correspond to the test sample.

Contents

1.	<u>TEST STANDARDS AND REPORT VERSION</u>	3
1.1.	Test Standards	3
1.2.	Report version	3
2.	<u>TEST DESCRIPTION</u>	4
3.	<u>SUMMARY</u>	5
3.1.	Client Information	5
3.2.	Product Description	5
3.3.	Operation state	6
3.4.	EUT configuration	6
3.5.	Modifications	6
4.	<u>TEST ENVIRONMENT</u>	7
4.1.	Address of the test laboratory	7
4.2.	Test Facility	7
4.3.	Environmental conditions	8
4.4.	Statement of the measurement uncertainty	8
4.5.	Equipments Used during the Test	9
5.	<u>TEST CONDITIONS AND RESULTS</u>	10
5.1.	Antenna requirement	10
5.2.	Conducted Emissions (AC Main)	11
5.3.	Conducted Peak Output Power	14
5.4.	20 dB Bandwidth	18
5.5.	Carrier Frequencies Separation	22
5.6.	Hopping Channel Number	24
5.7.	Dwell Time	26
5.8.	Pseudorandom Frequency Hopping Sequence	30
5.9.	Restricted band (radiated)	31
5.10.	Band edge and Spurious Emissions (conducted)	33
5.11.	Spurious Emissions (radiated)	55
6.	<u>TEST SETUP PHOTOS</u>	59
7.	<u>EXTERANAL AND INTERNAL PHOTOS</u>	60

1. TEST STANDARDS AND REPORT VERSION

1.1. Test Standards

The tests were performed according to following standards:

[FCC Rules Part 15.247](#): Frequency Hopping, Direct Spread Spectrum and Hybrid Systems that are in operation within the bands of 902-928 MHz, 2400-2483.5 MHz, and 5725-5850 MHz

[ANSI C63.10-2013](#): American National Standard for Testing Unlicensed Wireless Devices

1.2. Report version

Version No.	Date of issue	Description
00	Nov.02,2017	Original

2. TEST DESCRIPTION

Test Item	Section in CFR 47	Result	Test Engineer
Antenna Requirement	15.203/15.247 (c)	Pass	William Wang
AC Power Line Conducted Emissions	15.207	Pass	William Wang
Conducted Peak Output Power	15.247 (b)(1)	Pass	William Wang
20 dB Bandwidth	15.247 (a)(1)	Pass	William Wang
Carrier Frequencies Separation	15.247 (a)(1)	Pass	William Wang
Hopping Channel Number	15.247 (a)(1)	Pass	William Wang
Dwell Time	15.247 (a)(1)	Pass	William Wang
Pseudorandom Frequency Hopping Sequence	15.247(b)(4)	Pass	William Wang
Restricted band	15.247(d)/15.205	Pass	William Wang
Radiated Emissions	15.247(d)/15.209	Pass	William Wang

Note: The measurement uncertainty is not included in the test result.

3. SUMMARY

3.1. Client Information

Applicant:	Petcube, Inc.
Address:	2711 Centerville Road, Suite 400, Wilmington, Delaware 19808, USA
Manufacturer:	Yitoe Digital Technology Co., LTD.
Address:	6/F, Yitoe Building, Keji South Road 5th, Hi-tech Industrial Park, Nanshan District, Shenzhen

3.2. Product Description

Name of EUT:	Petcube Play
Trade Mark:	Petcube
Model No.:	PP211NV5LRV
Listed Model(s):	-
Power supply:	DC 5.0V from adapter
Adapter information:	Model: ASSA41w-050200 Input: 100-240V a.c., 50-60Hz, 0.5A Output: 5V d.c., 2A
Hardware version:	RV1108-YT-V2.0
Software version:	v2.6.0.1317
Bluetooth	
Version:	Supported BT4.0+EDR
Modulation:	GFSK, $\pi/4$ DQPSK, 8DPSK
Operation frequency:	2402MHz~2480MHz
Channel number:	79
Channel separation:	1MHz
Antenna type:	Integral Antenna
Antenna gain:	3.41 dBi

3.3. Operation state

➤ **Test frequency list**

According to section 15.31(m), regards to the operating frequency range over 10 MHz, must select three channel which were tested. the Lowest frequency, the middle frequency, and the highest frequency of channel were selected to perform the test, please see the above gray bottom.

Channel	Frequency (MHz)
00	2402
01	2403
⋮	⋮
39	2441
⋮	⋮
77	2479
78	2480

➤ **TEST MODE**

For RF test items:
The engineering test program was provided and enabled to make EUT continuous transmit
For AC power line conducted emissions:
The EUT was set to connect with the Bluetooth instrument under large package sizes transmission.
For Radiated suprious emissions test item:
The EUT in each of three orthogonal axis emissions had been tested ,but only the worst case (X axis) data recorded in the report.

3.4. EUT configuration

The following peripheral devices and interface cables were connected during the measurement:

- - supplied by the manufacturer
- - supplied by the lab

/	Manufacturer:	/
	Model No.:	/
/	Manufacturer:	/
	Model No.:	/

3.5. Modifications

No modifications were implemented to meet testing criteria.

4. TEST ENVIRONMENT

4.1. Address of the test laboratory

Laboratory: Shenzhen Huatongwei International Inspection Co., Ltd.

Address: 1/F, Bldg 3, Hongfa Hi-tech Industrial Park, Genyu Road, Tianliao, Gongming, Shenzhen, China

4.2. Test Facility

CNAS-Lab Code: L1225

Shenzhen Huatongwei International Inspection Co., Ltd. has been assessed and proved to be in compliance with CNAS-CL01 Accreditation Criteria for Testing and Calibration Laboratories (identical to ISO/IEC17025: 2005 General Requirements) for the Competence of Testing and Calibration Laboratories.

A2LA-Lab Cert. No.: 3902.01

Shenzhen Huatongwei International Inspection Co., Ltd. EMC Laboratory has been accredited by A2LA for technical competence in the field of electrical testing, and proved to be in compliance with ISO/IEC 17025: 2005 General Requirements for the Competence of Testing and Calibration Laboratories and any additional program requirements in the identified field of testing.

FCC-Registration No.: 762235

Shenzhen Huatongwei International Inspection Co., Ltd. EMC Laboratory has been registered and fully described in a report filed with the FCC (Federal Communications Commission). The acceptance letter from the FCC is maintained in our files.

IC-Registration No.:5377B-1

Two 3m Alternate Test Site of Shenzhen Huatongwei International Inspection Co., Ltd. has been registered by Certification and Engineering Bureau of Industry Canada for the performance of radiated measurements with Registration No.: 5377B-1.

ACA

Shenzhen Huatongwei International Inspection Co., Ltd. EMC Laboratory can also perform testing for the Australian C-Tick mark as a result of our A2LA accreditation.

4.3. Environmental conditions

During the measurement the environmental conditions were within the listed ranges:

Temperature:	15~35°C
Relative Humidity:	30~60 %
Air Pressure:	950~1050mba

4.4. Statement of the measurement uncertainty

The data and results referenced in this document are true and accurate. The reader is cautioned that there may be errors in calibration limits of the equipment and facilities. The measurement uncertainty was calculated for all measurements listed in this test report according to TR-100028-01 "Electromagnetic compatibility and Radio spectrum Matters (ERM); Uncertainties in the measurement of mobile radio equipment characteristics; Part 1" and TR-100028-02 "Electromagnetic compatibility and Radio spectrum Matters (ERM); Uncertainties in the measurement of mobile radio equipment characteristics; Part 2" and is documented in the Shenzhen Huatongwei International Inspection Co., Ltd. quality system according to ISO/IEC 17025. Furthermore, component and process variability of devices similar to that tested may result in additional deviation. The manufacturer has the sole responsibility of continued compliance of the device.

Here after the best measurement capability for Shenzhen Huatongwei International Inspection Co., Ltd. is reported:

Test Items	Measurement Uncertainty	Notes
Transmitter power conducted	0.57 dB	(1)
Transmitter power Radiated	2.20 dB	(1)
Conducted spurious emissions 9kHz~40GHz	1.60 dB	(1)
Radiated spurious emissions 9kHz~40GHz	2.20 dB	(1)
Conducted Emissions 9kHz~30MHz	3.39 dB	(1)
Radiated Emissions 30~1000MHz	4.24 dB	(1)
Radiated Emissions 1~18GHz	5.16 dB	(1)
Radiated Emissions 18~40GHz	5.54 dB	(1)
Occupied Bandwidth	-----	(1)

(1) This uncertainty represents an expanded uncertainty expressed at approximately the 95% confidence level using a coverage factor of k=1.96.

4.5. Equipments Used during the Test

Conducted Emissions					
Item	Test Equipment	Manufacturer	Model No.	Serial No.	Last Cal.
1	Artificial Mains	Rohde&Schwarz	ESH2-Z5	100028	2016/11/13
2	EMI Test Receiver	Rohde&Schwarz	ESCI3	100038	2016/11/13
3	Pulse Limiter	Rohde&Schwarz	ESHSZ2	100044	2016/11/13
4	EMI Test Software	Rohde&Schwarz	ES-K1 V1.71	-	-

Radiated Emissions					
Item	Test Equipment	Manufacturer	Model No.	Serial No.	Last Cal.
1	EMI test receiver	Rohde&Schwarz	ESI 26	100009	2016/11/13
2	Loop Antenna	Rohde&Schwarz	HFH2-Z2	100020	2016/11/13
3	Ultra-Broadband Antenna	ShwarzBeck	VULB9163	538	2016/11/13
4	Horn antenna	ShwarzBeck	9120D	1011	2016/11/13
5	Horn Antenna	SCHWARZBECK	BBHA9170	25841	2016/11/13
6	Amplifier	Sonoma	310N	E009-13	2016/11/13
7	JS Amplifier	Rohde&Schwarz	JS4-00101800-28-5A	F201504	2016/11/13
8	Amplifier	Compliance Direction systems	PAP1-4060	120	2016/11/13
9	High pass filter	Compliance Direction systems	BSU-6	34202	2016/11/13
10	EMI test Software	Rohde&Schwarz	ESK1	-	-
11	EMI test Software	Audix	E3	-	-
12	TURNTABLE	MATURO	TT2.0	-	-
13	ANTENNA MAST	MATURO	TAM-4.0-P	-	-

RF Conducted methods					
Item	Test Equipment	Manufacturer	Model No.	Serial No.	Last Cal.
1	Spectrum Analyzer	Rohde&Schwarz	FSP	1164.4391.40	2016/11/13
2	MXA Signal Analyzer	Agilent Technologies	N9020A	MY5050187	2016/11/13

The Cal.Interval was one year.

5. TEST CONDITIONS AND RESULTS

5.1. Antenna requirement

Requirement

FCC CFR Title 47 Part 15 Subpart C Section 15.203:

An intentional radiator shall be designed to ensure that no antenna other than that furnished by the responsible party shall be used with the device. The use of a permanently attached antenna or of an antenna that uses a unique coupling to the intentional radiator, the manufacturer may design the unit so that a broken antenna can be replaced by the user, but the use of a standard antenna jack or electrical connector is prohibited.

FCC CFR Title 47 Part 15 Subpart C Section 15.247(c) (1)(i):

(i) Systems operating in the 2400~2483.5 MHz band that is used exclusively for fixed. Point-to-point operations may employ transmitting antennas with directional gain greater than 6 dBi provided the maximum conducted output power of the intentional radiator is reduced by 1 dB for every 3 dB that the directional gain of the antenna exceeds 6 dBi.

Test Result:

Passed **Not Applicable**

Please refer to the below antenna photo.



5.2. Conducted Emissions (AC Main)

LIMIT

FCC CFR Title 47 Part 15 Subpart C Section 15.207

Frequency range (MHz)	Limit (dBuV)	
	Quasi-peak	Average
0.15-0.5	66 to 56*	56 to 46*
0.5-5	56	46
5-30	60	50

* Decreases with the logarithm of the frequency.

TEST CONFIGURATION

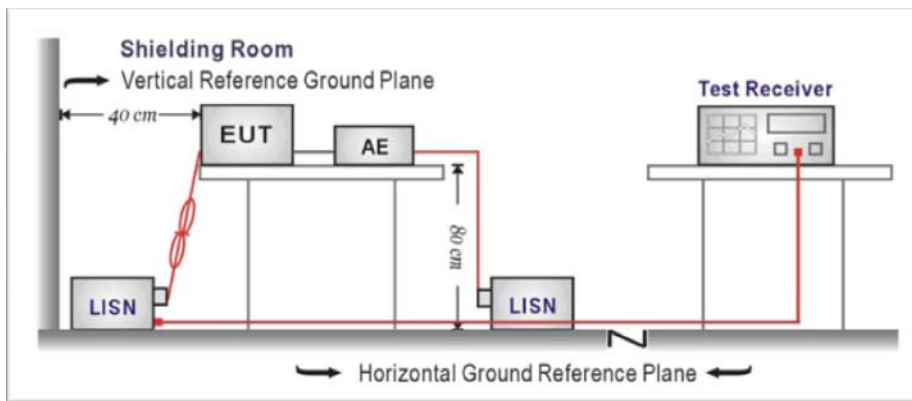

TEST PROCEDURE

1. The EUT was setup according to ANSI C63.10:2013 requirements.
2. The EUT was placed on a platform of nominal size, 1 m by 1.5 m, raised 80 cm above the conducting ground plane. The vertical conducting plane was located 40 cm to the rear of the EUT. All other surfaces of EUT were at least 80 cm from any other grounded conducting surface.
3. The EUT and simulators are connected to the main power through a line impedances stabilization network (LISN). The LISN provides a 50 ohm /50uH coupling impedance for the measuring equipment.
4. The peripheral devices are also connected to the main power through a LISN. (Please refer to the block diagram of the test setup and photographs)
5. Each current-carrying conductor of the EUT power cord, except the ground (safety) conductor, was individually connected through a LISN to the input power source.
6. The excess length of the power cord between the EUT and the LISN receptacle were folded back and forth at the center of the lead to form a bundle not exceeding 40 cm in length.
7. Conducted emissions were investigated over the frequency range from 0.15MHz to 30MHz using a receiver bandwidth of 9 kHz.
8. During the above scans, the emissions were maximized by cable manipulation.

TEST RESULTS

Passed Not Applicable

Note:

- 1) Transd= Cable lose + Pulse Limiter Factor + Artificial Mains Factor
- 2) Margin= Limit - Level

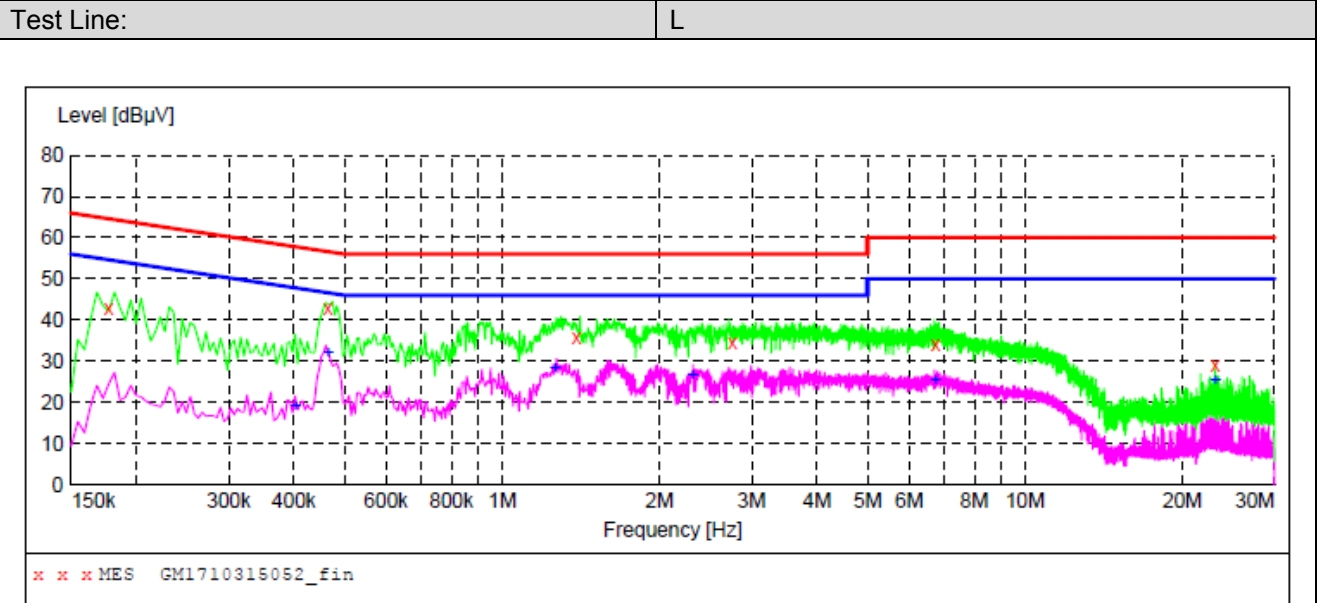

MEASUREMENT RESULT: "GM1710315052_fin"

10/31/2017 9:20PM

Frequency MHz	Level dBµV	Transd dB	Limit dBµV	Margin dB	Detector	Line	PE
0.177000	43.00	10.4	65	21.6	QP	L1	GND
0.465000	42.80	10.2	57	13.8	QP	L1	GND
1.387500	35.60	10.2	56	20.4	QP	L1	GND
2.760000	34.70	10.2	56	21.3	QP	L1	GND
6.747000	33.90	10.3	60	26.1	QP	L1	GND
23.127000	29.10	10.7	60	30.9	QP	L1	GND

MEASUREMENT RESULT: "GM1710315052_fin2"

10/31/2017 9:20PM

Frequency MHz	Level dBµV	Transd dB	Limit dBµV	Margin dB	Detector	Line	PE
0.402000	19.20	10.2	48	28.6	AV	L1	GND
0.465000	31.90	10.2	47	14.7	AV	L1	GND
1.261500	28.20	10.2	46	17.8	AV	L1	GND
2.310000	26.60	10.2	46	19.4	AV	L1	GND
6.738000	25.50	10.3	50	24.5	AV	L1	GND
23.127000	25.20	10.7	50	24.8	AV	L1	GND

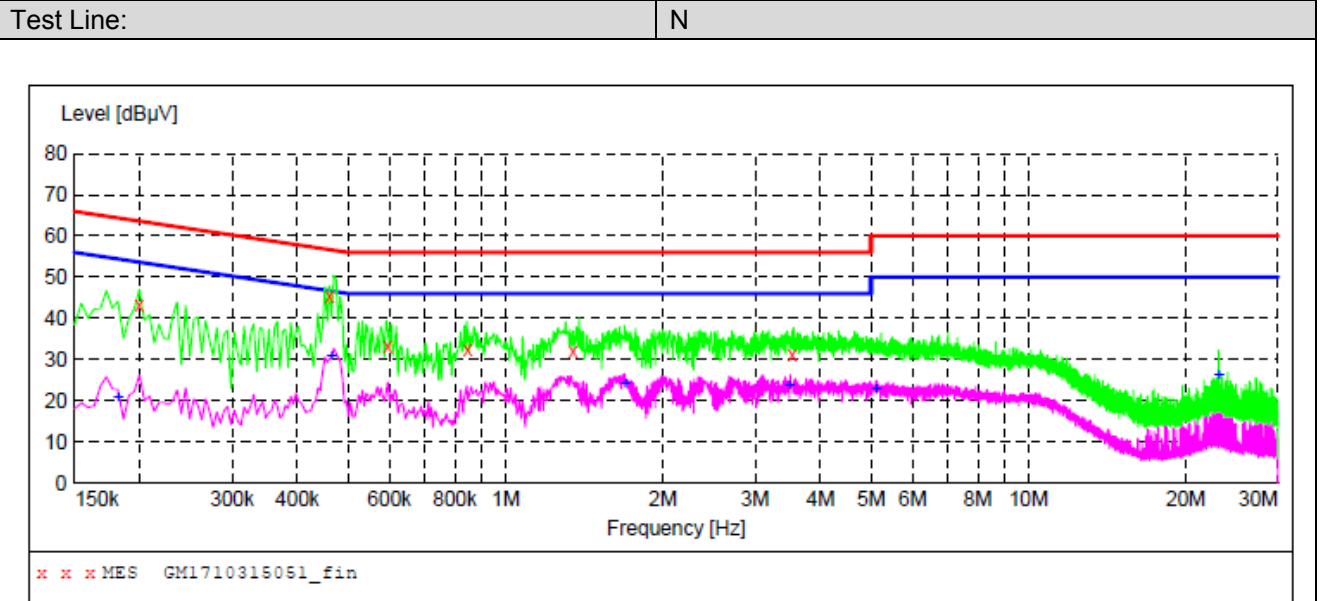

MEASUREMENT RESULT: "GM1710315051_fin"

10/31/2017 9:18PM

Frequency MHz	Level dBµV	Transd dB	Limit dBµV	Margin dB	Detector	Line	PE
0.199500	43.40	10.3	64	20.2	QP	N	GND
0.460500	45.20	10.2	57	11.5	QP	N	GND
0.595500	33.10	10.2	56	22.9	QP	N	GND
0.847500	32.50	10.1	56	23.5	QP	N	GND
1.347000	32.00	10.2	56	24.0	QP	N	GND
3.534000	31.10	10.3	56	24.9	QP	N	GND

MEASUREMENT RESULT: "GM1710315051_fin2"

10/31/2017 9:18PM

Frequency MHz	Level dBµV	Transd dB	Limit dBµV	Margin dB	Detector	Line	PE
0.181500	20.70	10.3	54	33.7	AV	N	GND
0.465000	30.80	10.2	47	15.8	AV	N	GND
1.693500	24.00	10.2	46	22.0	AV	N	GND
3.480000	23.80	10.3	46	22.2	AV	N	GND
5.118000	22.70	10.3	50	27.3	AV	N	GND
23.127000	26.20	10.7	50	23.8	AV	N	GND

5.3. Conducted Peak Output Power

LIMIT

FCC CFR Title 47 Part 15 Subpart C Section 15.247 (b)(1): For frequency hopping systems operating in the 2400-2483.5 MHz band employing at least 75 non-overlapping hopping channels, and all frequency hopping systems in the 5725-5850 MHz band: 1 watt. For all other frequency hopping systems in the 2400-2483.5 MHz band: 0.125 watts.

TEST CONFIGURATION

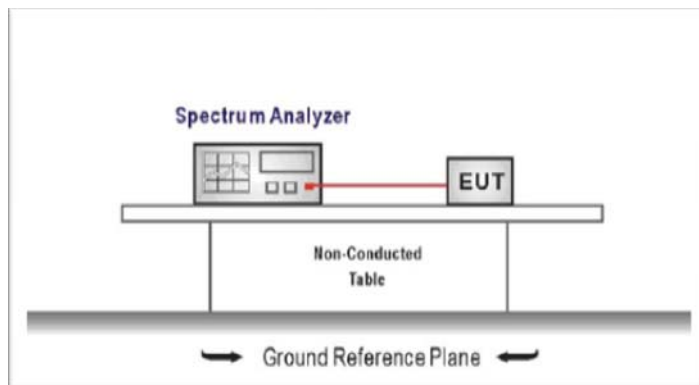

TEST PROCEDURE

1. The transmitter output was connected to the spectrum analyzer through an attenuator, the pathloss was compensated to the results for each measurement.
2. Set to the maximum power setting and enable the EUT transmit continuously
3. Use the following spectrum analyzer settings:
Span = approximately 5 times the 20 dB bandwidth, centered on a hopping channel
RBW \geq the 20 dB bandwidth of the emission being measured, VBW \geq RBW
Sweep = auto, Detector function = peak, Trace = max hold
4. Measure and record the results in the test report.



TEST MODE:

Please refer to the clause 3.3

TEST RESULTS

Passed Not Applicable

Modulation type	Channel	PK Output power (dBm)	Limit (dBm)	Result
GFSK	00	6.354	≤ 30.00	Pass
	39	6.191		
	78	4.891		
$\pi/4$ DQPSK	00	7.608	≤ 21.00	Pass
	39	7.436		
	78	6.144		
8DPSK	00	7.895	≤ 21.00	Pass
	39	7.645		
	78	6.343		

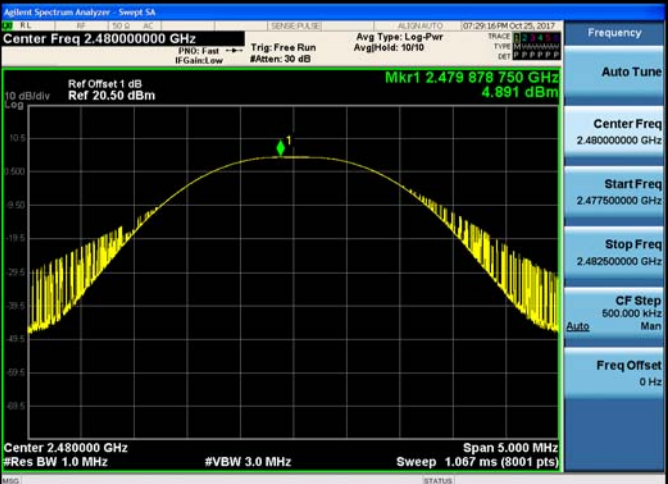
Modulation Type:		GFSK
CH00		
CH39		
CH78		

Modulation Type:		$\pi/4$ DQPSK
CH00	<p>Agilent Spectrum Analyzer - Sweep SA Center Freq 2.40200000 GHz Ref Offset 1 dB Ref 20.50 dBm Mkr1 2.401 913 750 GHz 7.608 dBm Span 5.000 MHz #Res BW 2.0 MHz #VBW 6.0 MHz Sweep 1.067 ms (8001 pts)</p>	<p>Frequency</p> <p>Auto Tune</p> <p>Center Freq 2.40200000 GHz</p> <p>Start Freq 2.39950000 GHz</p> <p>Stop Freq 2.40450000 GHz</p> <p>CF Step 500.000 kHz Auto Man</p> <p>Freq Offset 0 Hz</p>
CH39	<p>Agilent Spectrum Analyzer - Sweep SA Center Freq 2.44100000 GHz Ref Offset 1 dB Ref 20.50 dBm Mkr1 2.441 069 375 GHz 7.436 dBm Span 5.000 MHz #Res BW 2.0 MHz #VBW 6.0 MHz Sweep 1.067 ms (8001 pts)</p>	<p>Frequency</p> <p>Auto Tune</p> <p>Center Freq 2.44100000 GHz</p> <p>Start Freq 2.43850000 GHz</p> <p>Stop Freq 2.44350000 GHz</p> <p>CF Step 500.000 kHz Auto Man</p> <p>Freq Offset 0 Hz</p>
CH78	<p>Agilent Spectrum Analyzer - Sweep SA Center Freq 2.48000000 GHz Ref Offset 1 dB Ref 20.50 dBm Mkr1 2.480 106 250 GHz 6.144 dBm Span 5.000 MHz #Res BW 2.0 MHz #VBW 6.0 MHz Sweep 1.067 ms (8001 pts)</p>	<p>Frequency</p> <p>Auto Tune</p> <p>Center Freq 2.48000000 GHz</p> <p>Start Freq 2.47750000 GHz</p> <p>Stop Freq 2.48250000 GHz</p> <p>CF Step 500.000 kHz Auto Man</p> <p>Freq Offset 0 Hz</p>

Modulation Type:		8DPSK
CH00	<p>Agilent Spectrum Analyzer - Swept SA Center Freq 2.40200000 GHz Ref Offset 1 dB Ref 20.50 dBm Mkr1 2.401 973 750 GHz 7.895 dBm Span 5.000 MHz #Res BW 2.0 MHz #VBW 6.0 MHz Sweep 1.067 ms (8001 pts)</p>	<p>Frequency</p> <p>Auto Tune</p> <p>Center Freq 2.40200000 GHz</p> <p>Start Freq 2.399500000 GHz</p> <p>Stop Freq 2.404500000 GHz</p> <p>CF Step 500.000 kHz Auto Man</p> <p>Freq Offset 0 Hz</p>
CH39	<p>Agilent Spectrum Analyzer - Swept SA Center Freq 2.44100000 GHz Ref Offset 1 dB Ref 20.50 dBm Mkr1 2.440 946 250 GHz 7.645 dBm Span 5.000 MHz #Res BW 2.0 MHz #VBW 6.0 MHz Sweep 1.067 ms (8001 pts)</p>	<p>Frequency</p> <p>Auto Tune</p> <p>Center Freq 2.441000000 GHz</p> <p>Start Freq 2.438500000 GHz</p> <p>Stop Freq 2.443500000 GHz</p> <p>CF Step 500.000 kHz Auto Man</p> <p>Freq Offset 0 Hz</p>
CH78	<p>Agilent Spectrum Analyzer - Swept SA Center Freq 2.48000000 GHz Ref Offset 1 dB Ref 20.50 dBm Mkr1 2.480 018 750 GHz 6.343 dBm Span 5.000 MHz #Res BW 2.0 MHz #VBW 6.0 MHz Sweep 1.067 ms (8001 pts)</p>	<p>Frequency</p> <p>Auto Tune</p> <p>Center Freq 2.480000000 GHz</p> <p>Start Freq 2.477500000 GHz</p> <p>Stop Freq 2.482500000 GHz</p> <p>CF Step 500.000 kHz Auto Man</p> <p>Freq Offset 0 Hz</p>

5.4. 20 dB Bandwidth

LIMIT

N/A

TEST CONFIGURATION

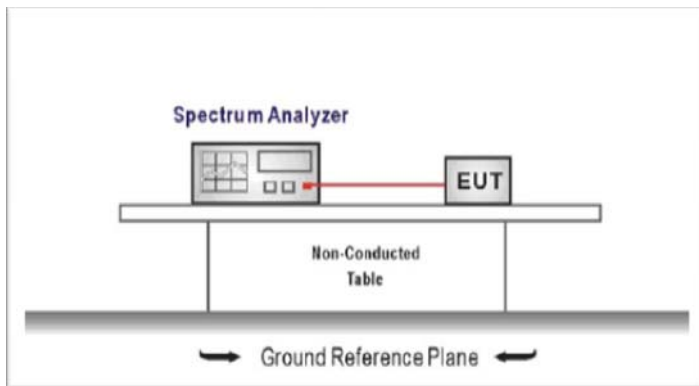

TEST PROCEDURE

1. The transmitter output was connected to the spectrum analyzer through an attenuator, the path loss was compensated to the results for each measurement.
2. Set to the maximum power setting and enable the EUT transmit continuously
3. Use the following spectrum analyzer settings:
 Span = approximately 2 to 3 times the 20 dB bandwidth, centered on a hopping channel
 RBW \geq 1% of the 20 dB bandwidth, VBW \geq RBW
 Sweep = auto, Detector function = peak, Trace = max hold
4. Measure and record the results in the test report.

TEST MODE:

Please refer to the clause 3.3

TEST RESULTS

Passed Not Applicable

Modulation type	Channel	20 dB Bandwidth (MHz)	Limit (MHz)	Result
GFSK	00	0.9364	-	Pass
	39	0.9206		
	78	0.9229		
$\pi/4$ DQPSK	00	1.311	-	Pass
	39	1.311		
	78	1.316		
8DPSK	00	1.313	-	Pass
	39	1.321		
	78	1.321		

Modulation Type:		GFSK
CH00	<p>Agilent Spectrum Analyzer - Occupied BW</p> <p>Center Freq 2.402000000 GHz</p> <p>Center Freq: 2.402000000 GHz</p> <p>Trig: Free Run</p> <p>Avg/Hold: 1/1</p> <p>Radio Std: None</p> <p>Radio Device: BTS</p> <p>Ref Offset 1 dB</p> <p>Ref 10.50 dBm</p> <p>Mkr1 2.401956 GHz</p> <p>1.1023 dBm</p> <p>Center 2.402 GHz</p> <p>#Res BW 10 kHz</p> <p>#VBW 30 kHz</p> <p>Span 2 MHz</p> <p>Sweep 19.13 ms</p> <p>Occupied Bandwidth 888.62 kHz</p> <p>Total Power 13.8 dBm</p> <p>Transmit Freq Error 1.060 kHz</p> <p>OBW Power 99.00 %</p> <p>x dB Bandwidth 936.4 kHz</p> <p>x dB -20.00 dB</p>	<p>Frequency</p> <p>Center Freq 2.402000000 GHz</p> <p>CF Step 200.000 kHz</p> <p>Man</p> <p>Freq Offset 0 Hz</p>
CH39	<p>Agilent Spectrum Analyzer - Occupied BW</p> <p>Center Freq 2.441000000 GHz</p> <p>Center Freq: 2.441000000 GHz</p> <p>Trig: Free Run</p> <p>Avg/Hold: 1/1</p> <p>Radio Std: None</p> <p>Radio Device: BTS</p> <p>Ref Offset 1 dB</p> <p>Ref 10.50 dBm</p> <p>Mkr1 2.440958 GHz</p> <p>0.98596 dBm</p> <p>Center 2.441 GHz</p> <p>#Res BW 10 kHz</p> <p>#VBW 30 kHz</p> <p>Span 2 MHz</p> <p>Sweep 19.13 ms</p> <p>Occupied Bandwidth 888.64 kHz</p> <p>Total Power 13.6 dBm</p> <p>Transmit Freq Error 475 Hz</p> <p>OBW Power 99.00 %</p> <p>x dB Bandwidth 920.6 kHz</p> <p>x dB -20.00 dB</p>	<p>Frequency</p> <p>Center Freq 2.441000000 GHz</p> <p>CF Step 200.000 kHz</p> <p>Man</p> <p>Freq Offset 0 Hz</p>
CH78	<p>Agilent Spectrum Analyzer - Occupied BW</p> <p>Center Freq 2.480000000 GHz</p> <p>Center Freq: 2.480000000 GHz</p> <p>Trig: Free Run</p> <p>Avg/Hold: 1/1</p> <p>Radio Std: None</p> <p>Radio Device: BTS</p> <p>Ref Offset 1 dB</p> <p>Ref 10.50 dBm</p> <p>Mkr1 2.479956 GHz</p> <p>-0.39447 dBm</p> <p>Center 2.48 GHz</p> <p>#Res BW 10 kHz</p> <p>#VBW 30 kHz</p> <p>Span 2 MHz</p> <p>Sweep 19.13 ms</p> <p>Occupied Bandwidth 888.23 kHz</p> <p>Total Power 12.2 dBm</p> <p>Transmit Freq Error 1.168 kHz</p> <p>OBW Power 99.00 %</p> <p>x dB Bandwidth 922.9 kHz</p> <p>x dB -20.00 dB</p>	<p>Frequency</p> <p>Center Freq 2.480000000 GHz</p> <p>CF Step 200.000 kHz</p> <p>Man</p> <p>Freq Offset 0 Hz</p>

Modulation Type:		$\pi/4$ DQPSK
CH00	<p>Agilent Spectrum Analyzer - Occupied BW</p> <p>Center Freq 2.40200000 GHz</p> <p>Center Freq: 2.40200000 GHz</p> <p>Trig: Free Run</p> <p>Avg/Hold: 1/1</p> <p>Radio Std: None</p> <p>Radio Device: BTS</p> <p>Ref Offset 1 dB</p> <p>Ref 10.50 dBm</p> <p>Mkr1 2.4020025 GHz</p> <p>3.3488 dBm</p> <p>Center 2.402 GHz</p> <p>#Res BW 30 kHz</p> <p>#VBW 100 kHz</p> <p>Span 2.5 MHz</p> <p>Sweep 2.667 ms</p> <p>Occupied Bandwidth 1.1963 MHz</p> <p>Total Power 13.9 dBm</p> <p>Transmit Freq Error 2.252 kHz</p> <p>OBW Power 99.00 %</p> <p>x dB Bandwidth 1.311 MHz</p> <p>x dB -20.00 dB</p>	<p>Frequency</p> <p>Center Freq 2.40200000 GHz</p> <p>CF Step 250.000 kHz</p> <p>Freq Offset 0 Hz</p>
CH39	<p>Agilent Spectrum Analyzer - Occupied BW</p> <p>Center Freq 2.44100000 GHz</p> <p>Center Freq: 2.44100000 GHz</p> <p>Trig: Free Run</p> <p>Avg/Hold: 1/1</p> <p>Radio Std: None</p> <p>Radio Device: BTS</p> <p>Ref Offset 1 dB</p> <p>Ref 10.50 dBm</p> <p>Mkr1 2.441 GHz</p> <p>3.0677 dBm</p> <p>Center 2.441 GHz</p> <p>#Res BW 30 kHz</p> <p>#VBW 100 kHz</p> <p>Span 2.5 MHz</p> <p>Sweep 2.667 ms</p> <p>Occupied Bandwidth 1.1967 MHz</p> <p>Total Power 13.6 dBm</p> <p>Transmit Freq Error 1.408 kHz</p> <p>OBW Power 99.00 %</p> <p>x dB Bandwidth 1.311 MHz</p> <p>x dB -20.00 dB</p>	<p>Frequency</p> <p>Center Freq 2.44100000 GHz</p> <p>CF Step 250.000 kHz</p> <p>Freq Offset 0 Hz</p>
CH78	<p>Agilent Spectrum Analyzer - Occupied BW</p> <p>Center Freq 2.48000000 GHz</p> <p>Center Freq: 2.48000000 GHz</p> <p>Trig: Free Run</p> <p>Avg/Hold: 1/1</p> <p>Radio Std: None</p> <p>Radio Device: BTS</p> <p>Ref Offset 1 dB</p> <p>Ref 10.50 dBm</p> <p>Mkr1 2.4799925 GHz</p> <p>1.2238 dBm</p> <p>Center 2.48 GHz</p> <p>#Res BW 30 kHz</p> <p>#VBW 100 kHz</p> <p>Span 2.5 MHz</p> <p>Sweep 2.667 ms</p> <p>Occupied Bandwidth 1.1968 MHz</p> <p>Total Power 12.2 dBm</p> <p>Transmit Freq Error 2.073 kHz</p> <p>OBW Power 99.00 %</p> <p>x dB Bandwidth 1.316 MHz</p> <p>x dB -20.00 dB</p>	<p>Frequency</p> <p>Center Freq 2.48000000 GHz</p> <p>CF Step 250.000 kHz</p> <p>Freq Offset 0 Hz</p>

Modulation Type:		8DPSK
CH00	<p>Agilent Spectrum Analyzer - Occupied BW</p> <p>Center Freq 2.40200000 GHz</p> <p>Center Freq: 2.40200000 GHz</p> <p>Trig: Free Run</p> <p>Avg/Hold: 1/1</p> <p>Radio Device: BTS</p> <p>Ref Offset 1 dB</p> <p>Ref 10.50 dBm</p> <p>Mkr1 2.402 GHz</p> <p>3.4537 dBm</p> <p>Center 2.402 GHz</p> <p>#Res BW 30 kHz</p> <p>#VBW 100 kHz</p> <p>Span 2.5 MHz</p> <p>Sweep 2.667 ms</p> <p>Occupied Bandwidth 1.1971 MHz</p> <p>Total Power 14.0 dBm</p> <p>Transmit Freq Error 7.035 kHz</p> <p>OBW Power 99.00 %</p> <p>x dB Bandwidth 1.313 MHz</p> <p>x dB -20.00 dB</p>	<p>Frequency</p> <p>Center Freq 2.40200000 GHz</p> <p>CF Step 250.000 kHz</p> <p>Freq Offset 0 Hz</p>
CH39	<p>Agilent Spectrum Analyzer - Occupied BW</p> <p>Center Freq 2.44100000 GHz</p> <p>Center Freq: 2.44100000 GHz</p> <p>Trig: Free Run</p> <p>Avg/Hold: 1/1</p> <p>Radio Device: BTS</p> <p>Ref Offset 1 dB</p> <p>Ref 10.50 dBm</p> <p>Mkr1 2.440995 GHz</p> <p>2.6966 dBm</p> <p>Center 2.441 GHz</p> <p>#Res BW 30 kHz</p> <p>#VBW 100 kHz</p> <p>Span 2.5 MHz</p> <p>Sweep 2.667 ms</p> <p>Occupied Bandwidth 1.1963 MHz</p> <p>Total Power 13.6 dBm</p> <p>Transmit Freq Error 6.777 kHz</p> <p>OBW Power 99.00 %</p> <p>x dB Bandwidth 1.321 MHz</p> <p>x dB -20.00 dB</p>	<p>Frequency</p> <p>Center Freq 2.44100000 GHz</p> <p>CF Step 250.000 kHz</p> <p>Freq Offset 0 Hz</p>
CH78	<p>Agilent Spectrum Analyzer - Occupied BW</p> <p>Center Freq 2.48000000 GHz</p> <p>Center Freq: 2.48000000 GHz</p> <p>Trig: Free Run</p> <p>Avg/Hold: 1/1</p> <p>Radio Device: BTS</p> <p>Ref Offset 1 dB</p> <p>Ref 10.50 dBm</p> <p>Mkr1 2.4799975 GHz</p> <p>1.6001 dBm</p> <p>Center 2.48 GHz</p> <p>#Res BW 30 kHz</p> <p>#VBW 100 kHz</p> <p>Span 2.5 MHz</p> <p>Sweep 2.667 ms</p> <p>Occupied Bandwidth 1.1965 MHz</p> <p>Total Power 12.3 dBm</p> <p>Transmit Freq Error 6.879 kHz</p> <p>OBW Power 99.00 %</p> <p>x dB Bandwidth 1.321 MHz</p> <p>x dB -20.00 dB</p>	<p>Frequency</p> <p>Center Freq 2.48000000 GHz</p> <p>CF Step 250.000 kHz</p> <p>Freq Offset 0 Hz</p>

5.5. Carrier Frequencies Separation

LIMIT

FCC CFR Title 47 Part 15 Subpart C Section 15.247 (a)(1): Frequency hopping systems shall have hopping channel carrier frequencies separated by minimum of 25 kHz or the $2/3 \times 20$ dB bandwidth of the hopping channel, whichever is greater.

TEST CONFIGURATION

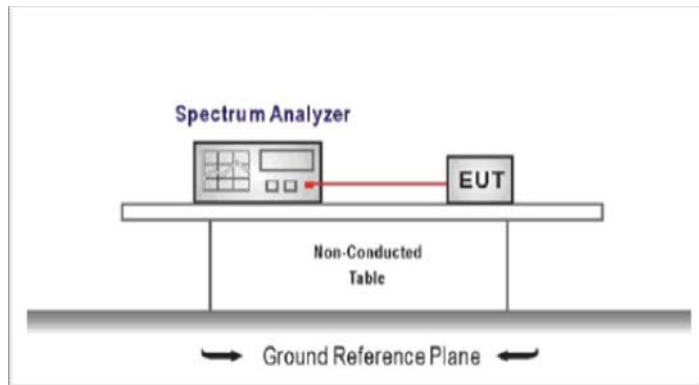

TEST PROCEDURE

1. The transmitter output was connected to the spectrum analyzer through an attenuator, the path loss was compensated to the results for each measurement.
2. Set to the maximum power setting and enable the EUT transmit continuously
3. Use the following spectrum analyzer settings:
Span = wide enough to capture the peaks of two adjacent channels
RBW \geq 1% of the span, VBW \geq RBW
Sweep = auto, Detector function = peak, Trace = max hold
4. Measure and record the results in the test report.

TEST MODE:

Please refer to the clause 3.3

TEST RESULTS

Passed Not Applicable

Modulation type	Channel	Carrier Frequencies Separation (MHz)	Limit (MHz) *	Result
GFSK	39	0.979	≥ 0.936	Pass
$\pi/4$ DQPSK	39	1.130	≥ 0.882	Pass
8DPSK	39	0.996	≥ 0.885	Pass

Note:

*: GFSK limit = The maximum 20 dB Bandwidth for GFSK modulation on the section 5.4.

$\pi/4$ DQPSK limit = $2/3 \times$ The maximum 20 dB Bandwidth for $\pi/4$ DQPSK modulation on the section 5.4.

8DPSK limit = $2/3 \times$ The maximum 20 dB Bandwidth for 8DPSK modulation on the section 5.4

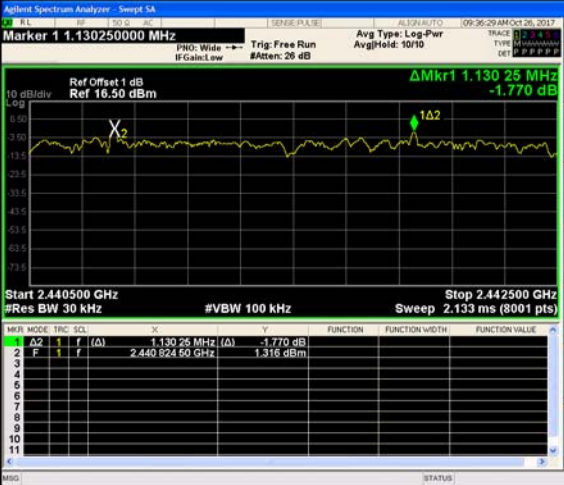
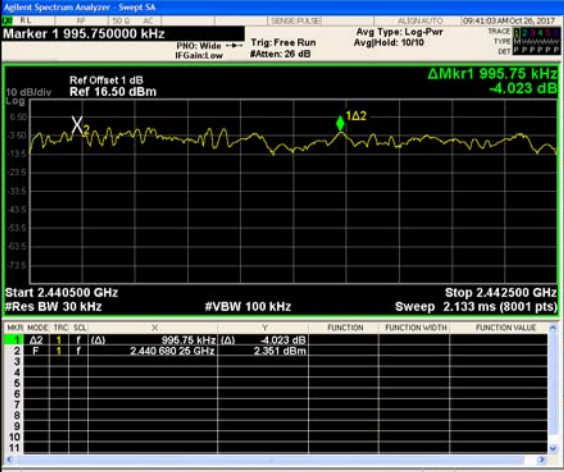
<p>GFSK</p>	 <table border="1" data-bbox="678 504 1244 660"><thead><tr><th>MKR</th><th>MODE</th><th>TRC</th><th>SCL</th><th>X</th><th>Y</th><th>FUNCTION</th><th>FUNCTION WIDTH</th><th>FUNCTION VALUE</th></tr></thead><tbody><tr><td>1</td><td>Δ2</td><td>f</td><td>f</td><td>979.25 MHz (Δ)</td><td>0.477 dB</td><td></td><td></td><td></td></tr><tr><td>2</td><td>F</td><td>f</td><td>f</td><td>2.441062 GHz</td><td>-0.411 dBm</td><td></td><td></td><td></td></tr></tbody></table>	MKR	MODE	TRC	SCL	X	Y	FUNCTION	FUNCTION WIDTH	FUNCTION VALUE	1	Δ2	f	f	979.25 MHz (Δ)	0.477 dB				2	F	f	f	2.441062 GHz	-0.411 dBm				<p>Peak Search</p> <p>Next Peak</p> <p>Next Pk Right</p> <p>Next Pk Left</p> <p>Marker Delta</p> <p>Mkr--CF</p> <p>Mkr--Ref Lvl</p> <p>More 1 of 2</p>
MKR	MODE	TRC	SCL	X	Y	FUNCTION	FUNCTION WIDTH	FUNCTION VALUE																					
1	Δ2	f	f	979.25 MHz (Δ)	0.477 dB																								
2	F	f	f	2.441062 GHz	-0.411 dBm																								
<p>π/4DQPSK</p>	 <table border="1" data-bbox="678 996 1244 1158"><thead><tr><th>MKR</th><th>MODE</th><th>TRC</th><th>SCL</th><th>X</th><th>Y</th><th>FUNCTION</th><th>FUNCTION WIDTH</th><th>FUNCTION VALUE</th></tr></thead><tbody><tr><td>1</td><td>Δ2</td><td>f</td><td>f</td><td>1.13025 MHz (Δ)</td><td>-1.770 dB</td><td></td><td></td><td></td></tr><tr><td>2</td><td>F</td><td>f</td><td>f</td><td>2.440824 GHz</td><td>1.316 dBm</td><td></td><td></td><td></td></tr></tbody></table>	MKR	MODE	TRC	SCL	X	Y	FUNCTION	FUNCTION WIDTH	FUNCTION VALUE	1	Δ2	f	f	1.13025 MHz (Δ)	-1.770 dB				2	F	f	f	2.440824 GHz	1.316 dBm				<p>Peak Search</p> <p>Next Peak</p> <p>Next Pk Right</p> <p>Next Pk Left</p> <p>Marker Delta</p> <p>Mkr--CF</p> <p>Mkr--Ref Lvl</p> <p>More 1 of 2</p>
MKR	MODE	TRC	SCL	X	Y	FUNCTION	FUNCTION WIDTH	FUNCTION VALUE																					
1	Δ2	f	f	1.13025 MHz (Δ)	-1.770 dB																								
2	F	f	f	2.440824 GHz	1.316 dBm																								
<p>8DPSK</p>	 <table border="1" data-bbox="678 1489 1244 1639"><thead><tr><th>MKR</th><th>MODE</th><th>TRC</th><th>SCL</th><th>X</th><th>Y</th><th>FUNCTION</th><th>FUNCTION WIDTH</th><th>FUNCTION VALUE</th></tr></thead><tbody><tr><td>1</td><td>Δ2</td><td>f</td><td>f</td><td>995.75 MHz (Δ)</td><td>-4.023 dB</td><td></td><td></td><td></td></tr><tr><td>2</td><td>F</td><td>f</td><td>f</td><td>2.440690 GHz</td><td>2.351 dBm</td><td></td><td></td><td></td></tr></tbody></table>	MKR	MODE	TRC	SCL	X	Y	FUNCTION	FUNCTION WIDTH	FUNCTION VALUE	1	Δ2	f	f	995.75 MHz (Δ)	-4.023 dB				2	F	f	f	2.440690 GHz	2.351 dBm				<p>Peak Search</p> <p>Next Peak</p> <p>Next Pk Right</p> <p>Next Pk Left</p> <p>Marker Delta</p> <p>Mkr--CF</p> <p>Mkr--Ref Lvl</p> <p>More 1 of 2</p>
MKR	MODE	TRC	SCL	X	Y	FUNCTION	FUNCTION WIDTH	FUNCTION VALUE																					
1	Δ2	f	f	995.75 MHz (Δ)	-4.023 dB																								
2	F	f	f	2.440690 GHz	2.351 dBm																								

5.6. Hopping Channel Number

LIMIT

FCC CFR Title 47 Part 15 Subpart C Section 15.247 (a)(1):Frequency hopping systems in the 2400–2483.5 MHz band shall use at least **15** channels.

TEST CONFIGURATION

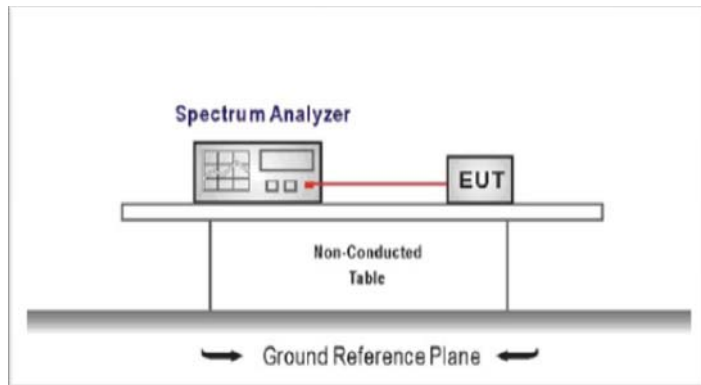

TEST PROCEDURE

1. The transmitter output was connected to the spectrum analyzer through an attenuator, the path loss was compensated to the results for each measurement.
2. Set to the maximum power setting and enable the EUT transmit continuously
3. Use the following spectrum analyzer settings:
 Span = the frequency band of operation
 RBW \geq 1% of the span, VBW \geq RBW
 Sweep = auto, Detector function = peak, Trace = max hold
4. Measure and record the results in the test report.

TEST MODE:

Please refer to the clause 3.3

TEST RESULTS

Passed Not Applicable

Modulation type	Channel number	Limit	Result
GFSK	79	≥ 15.00	Pass
$\pi/4$ DQPSK	79		
8DPSK	79		

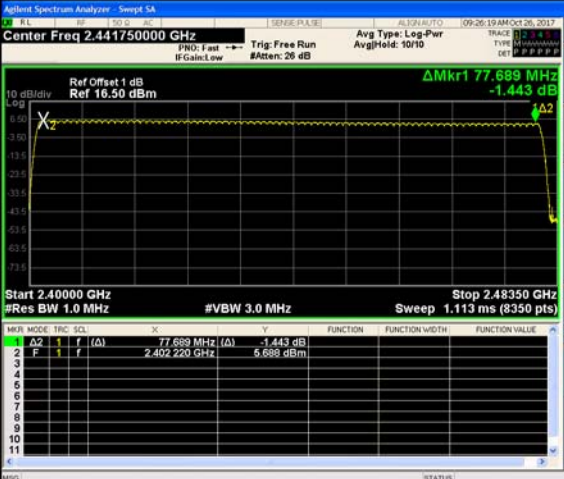
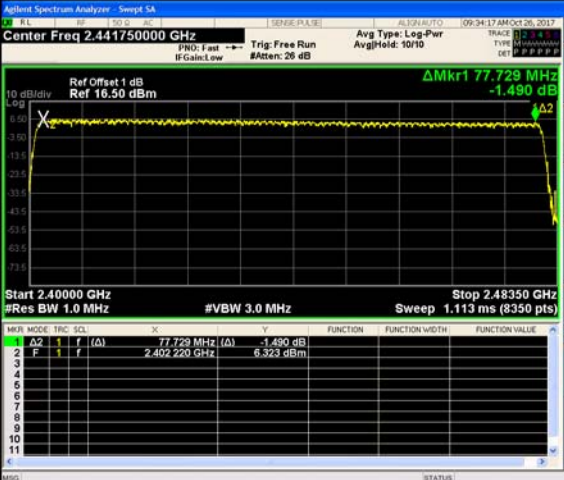
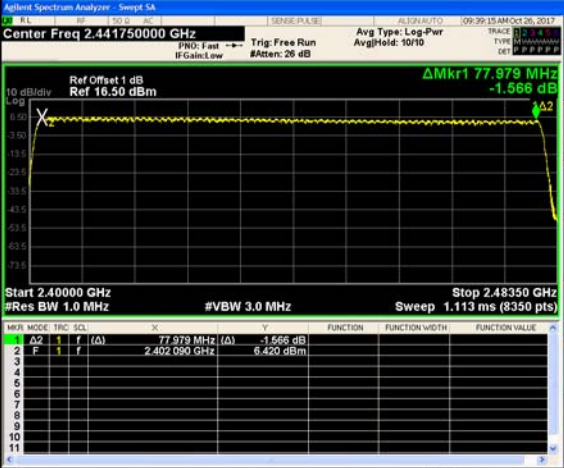
<p>GFSK</p>	 <p>Agilent Spectrum Analyzer - Sweep SA Center Freq 2.441750000 GHz Ref Offset 1 dB Ref 16.50 dBm Auto Tune Center Freq 2.441750000 GHz Start Freq 2.400000000 GHz Stop Freq 2.483500000 GHz CF Step 8.3500000 MHz Freq Offset 0 Hz</p> <table border="1"> <thead> <tr> <th>MRK</th> <th>MODE</th> <th>TRC</th> <th>SCL</th> <th>X</th> <th>Y</th> <th>FUNCTION</th> <th>FUNCTION WIDTH</th> <th>FUNCTION VALUE</th> </tr> </thead> <tbody> <tr> <td>1</td> <td>A2</td> <td>1</td> <td>f</td> <td>(Δ)</td> <td>77.689 MHz (Δ)</td> <td>-1.443 dB</td> <td></td> <td></td> </tr> <tr> <td>2</td> <td>F</td> <td>1</td> <td>f</td> <td></td> <td>2.402 220 GHz</td> <td>5.688 dBm</td> <td></td> <td></td> </tr> </tbody> </table>	MRK	MODE	TRC	SCL	X	Y	FUNCTION	FUNCTION WIDTH	FUNCTION VALUE	1	A2	1	f	(Δ)	77.689 MHz (Δ)	-1.443 dB			2	F	1	f		2.402 220 GHz	5.688 dBm		
MRK	MODE	TRC	SCL	X	Y	FUNCTION	FUNCTION WIDTH	FUNCTION VALUE																				
1	A2	1	f	(Δ)	77.689 MHz (Δ)	-1.443 dB																						
2	F	1	f		2.402 220 GHz	5.688 dBm																						
<p>$\pi/4$DQPSK</p>	 <p>Agilent Spectrum Analyzer - Sweep SA Center Freq 2.441750000 GHz Ref Offset 1 dB Ref 16.50 dBm Auto Tune Center Freq 2.441750000 GHz Start Freq 2.400000000 GHz Stop Freq 2.483500000 GHz CF Step 8.3500000 MHz Freq Offset 0 Hz</p> <table border="1"> <thead> <tr> <th>MRK</th> <th>MODE</th> <th>TRC</th> <th>SCL</th> <th>X</th> <th>Y</th> <th>FUNCTION</th> <th>FUNCTION WIDTH</th> <th>FUNCTION VALUE</th> </tr> </thead> <tbody> <tr> <td>1</td> <td>A2</td> <td>1</td> <td>f</td> <td>(Δ)</td> <td>77.729 MHz (Δ)</td> <td>-1.490 dB</td> <td></td> <td></td> </tr> <tr> <td>2</td> <td>F</td> <td>1</td> <td>f</td> <td></td> <td>2.402 220 GHz</td> <td>5.323 dBm</td> <td></td> <td></td> </tr> </tbody> </table>	MRK	MODE	TRC	SCL	X	Y	FUNCTION	FUNCTION WIDTH	FUNCTION VALUE	1	A2	1	f	(Δ)	77.729 MHz (Δ)	-1.490 dB			2	F	1	f		2.402 220 GHz	5.323 dBm		
MRK	MODE	TRC	SCL	X	Y	FUNCTION	FUNCTION WIDTH	FUNCTION VALUE																				
1	A2	1	f	(Δ)	77.729 MHz (Δ)	-1.490 dB																						
2	F	1	f		2.402 220 GHz	5.323 dBm																						
<p>8DPSK</p>	 <p>Agilent Spectrum Analyzer - Sweep SA Center Freq 2.441750000 GHz Ref Offset 1 dB Ref 16.50 dBm Auto Tune Center Freq 2.441750000 GHz Start Freq 2.400000000 GHz Stop Freq 2.483500000 GHz CF Step 8.3500000 MHz Freq Offset 0 Hz</p> <table border="1"> <thead> <tr> <th>MRK</th> <th>MODE</th> <th>TRC</th> <th>SCL</th> <th>X</th> <th>Y</th> <th>FUNCTION</th> <th>FUNCTION WIDTH</th> <th>FUNCTION VALUE</th> </tr> </thead> <tbody> <tr> <td>1</td> <td>A2</td> <td>1</td> <td>f</td> <td>(Δ)</td> <td>77.979 MHz (Δ)</td> <td>-1.566 dB</td> <td></td> <td></td> </tr> <tr> <td>2</td> <td>F</td> <td>1</td> <td>f</td> <td></td> <td>2.402 090 GHz</td> <td>6.420 dBm</td> <td></td> <td></td> </tr> </tbody> </table>	MRK	MODE	TRC	SCL	X	Y	FUNCTION	FUNCTION WIDTH	FUNCTION VALUE	1	A2	1	f	(Δ)	77.979 MHz (Δ)	-1.566 dB			2	F	1	f		2.402 090 GHz	6.420 dBm		
MRK	MODE	TRC	SCL	X	Y	FUNCTION	FUNCTION WIDTH	FUNCTION VALUE																				
1	A2	1	f	(Δ)	77.979 MHz (Δ)	-1.566 dB																						
2	F	1	f		2.402 090 GHz	6.420 dBm																						

5.7. Dwell Time

LIMIT

FCC CFR Title 47 Part 15 Subpart C Section 15.247 (a)(1):The average time of occupancy on any channel shall not be greater than 0.4 seconds within a pe-riod of 0.4 seconds multiplied by the number of hopping channels employed.

TEST CONFIGURATION

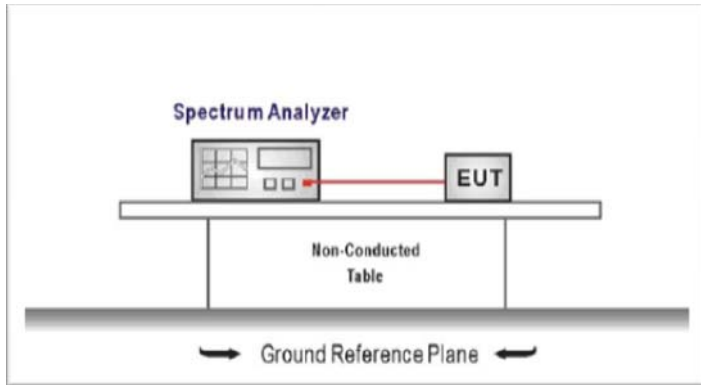

TEST PROCEDURE

1. The transmitter output was connected to the spectrum analyzer through an attenuator, the path loss was compensated to the results for each measurement.
2. Set to the maximum power setting and enable the EUT transmit continuously
3. Use the following spectrum analyzer settings:
 Span = zero span, centered on a hopping channel, RBW= 1 MHz, VBW ≥ RBW
 Sweep = as necessary to capture the entire dwell time per hopping channel,
 Detector function = peak, Trace = max hold
4. Measure and record the results in the test report.

TEST MODE:

Please refer to the clause 3.3

TEST RESULTS

Passed Not Applicable

Modulation type	Channel	Dwell time (Second)	Limit (Second)	Result
GFSK	DH1	0.119	≤ 0.40	Pass
	DH3	0.260		
	DH5	0.307		
π/4DQPSK	2DH1	0.122	≤ 0.40	Pass
	2DH3	0.261		
	2DH5	0.307		
8DPSK	3DH1	0.120	≤ 0.40	Pass
	3DH3	0.260		
	3DH5	0.307		

Note:

1. We have tested all mode at high,middle and low channel,and recoreded worst case at middle channel.
2. Dwell time=Pulse time (ms) × (1600 ÷ 2 ÷ 79) ×31.6 Second for DH1, 2DH1, 3DH1
 Dwell time=Pulse time (ms) × (1600 ÷ 4 ÷ 79) ×31.6 Second for DH3, 2DH3, 3DH3
 Dwell time=Pulse time (ms) × (1600 ÷ 6 ÷ 79) ×31.6 Second for DH5, 2DH5, 3DH5

Modulation Type:		GFSK	
DH1		<p>Frequency</p> <p>Auto Tune</p> <p>Center Freq 2.441000000 GHz</p> <p>Start Freq 2.441000000 GHz</p> <p>Stop Freq 2.441000000 GHz</p> <p>CF Step 1.000000 MHz Auto Man</p> <p>Freq Offset 0 Hz</p>	
DH3		<p>Frequency</p> <p>Auto Tune</p> <p>Center Freq 2.441000000 GHz</p> <p>Start Freq 2.441000000 GHz</p> <p>Stop Freq 2.441000000 GHz</p> <p>CF Step 1.000000 MHz Auto Man</p> <p>Freq Offset 0 Hz</p>	
DH5		<p>Frequency</p> <p>Auto Tune</p> <p>Center Freq 2.441000000 GHz</p> <p>Start Freq 2.441000000 GHz</p> <p>Stop Freq 2.441000000 GHz</p> <p>CF Step 1.000000 MHz Auto Man</p> <p>Freq Offset 0 Hz</p>	

Modulation Type:		$\pi/4$ DQPSK
2DH1		<p>Agilent Spectrum Analyzer - Sweep SA Center Freq 2.441000000 GHz Ref 20.00 dBm ΔMkr1 380.0 μs 13.12 dB Center 2.441000000 GHz Res BW 1.0 MHz #VBW 3.0 MHz Sweep 10.13 ms (8001 pts)</p>
2DH3		<p>Agilent Spectrum Analyzer - Sweep SA Center Freq 2.441000000 GHz Ref 20.00 dBm ΔMkr1 1.629 ms 4.00 dB Center 2.441000000 GHz Res BW 1.0 MHz #VBW 3.0 MHz Sweep 10.13 ms (8001 pts)</p>
2DH5		<p>Agilent Spectrum Analyzer - Sweep SA Center Freq 2.441000000 GHz Ref 20.00 dBm ΔMkr1 2.875 ms 0.16 dB Center 2.441000000 GHz Res BW 1.0 MHz #VBW 3.0 MHz Sweep 10.13 ms (8001 pts)</p>

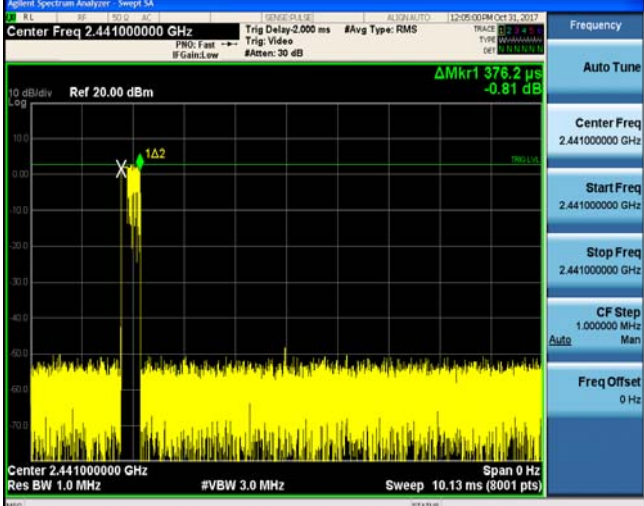
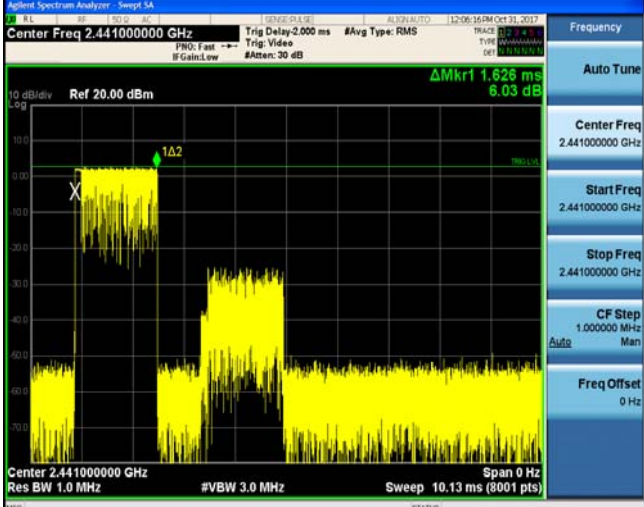
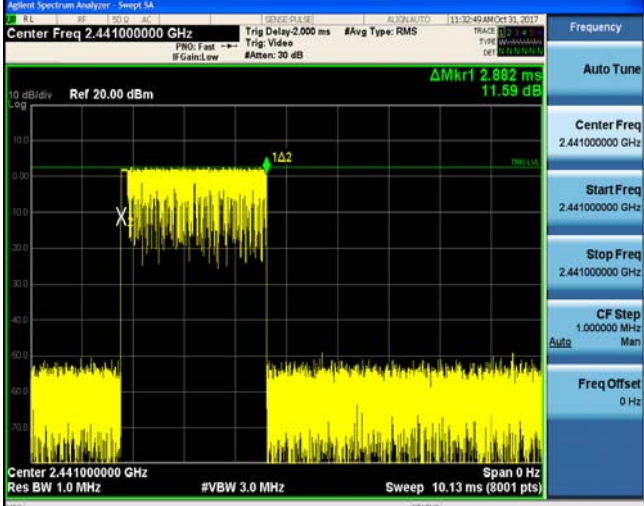
Modulation Type:		8DPSK
3DH1		 <p>Agilent Spectrum Analyzer - Sweep SA Center Freq 2.441000000 GHz Ref 20.00 dBm ΔMkr1 376.2 μs -0.81 dB Center 2.441000000 GHz Res BW 1.0 MHz #VBW 3.0 MHz Sweep 10.13 ms (8001 pts)</p>
3DH3		 <p>Agilent Spectrum Analyzer - Sweep SA Center Freq 2.441000000 GHz Ref 20.00 dBm ΔMkr1 1.626 ms 6.03 dB Center 2.441000000 GHz Res BW 1.0 MHz #VBW 3.0 MHz Sweep 10.13 ms (8001 pts)</p>
3DH5		 <p>Agilent Spectrum Analyzer - Sweep SA Center Freq 2.441000000 GHz Ref 20.00 dBm ΔMkr1 2.882 ms 11.59 dB Center 2.441000000 GHz Res BW 1.0 MHz #VBW 3.0 MHz Sweep 10.13 ms (8001 pts)</p>

5.8. Pseudorandom Frequency Hopping Sequence

LIMIT

FCC CFR Title 47 Part 15 Subpart C Section 15.247 (a)(1):Frequency hopping systems shall have hopping channel carrier frequencies separated by a minimum of 25 kHz or the 20 dB bandwidth of the hopping channel, whichever is greater. Alternatively, frequency hopping systems operating in the 2400–2483.5 MHz band may have hopping channel carrier frequencies that are separated by 25 kHz or two-thirds of the 20 dB bandwidth of the hopping channel, whichever is greater, provided the systems operate with an output power no greater than 125 mW. The system shall hop to channel frequencies that are selected at the system hopping rate from a pseudo randomly ordered list of hopping frequencies. Each frequency must be used equally on the average by each transmitter. The system receivers shall have input bandwidths that match the hopping channel bandwidths of their corresponding transmitters and shall shift frequencies in synchronization with the transmitted signals.

TEST RESULTS

The pseudorandom frequency hopping sequence may be generated in a nine-stage shift register whose 5th and 9th stage outputs are added in a modulo-two addition stage. And the result is fed back to the input of the first stage. The sequence begins with the first one of 9 consecutive ones, for example: the shift register is initialized with nine ones.

- Number of shift register stages: 9
- Length of pseudo-random sequence: $2^9 - 1 = 511$ bits
- Longest sequence of zeros: 8 (non-inverted signal)

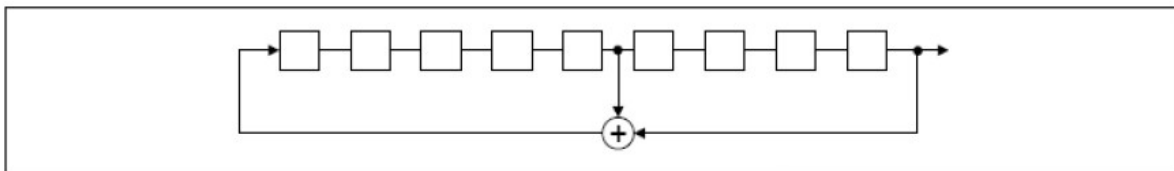

Linear Feedback Shift Register for Generation of the PRBS sequence

An example of pseudorandom frequency hopping sequence as follows:

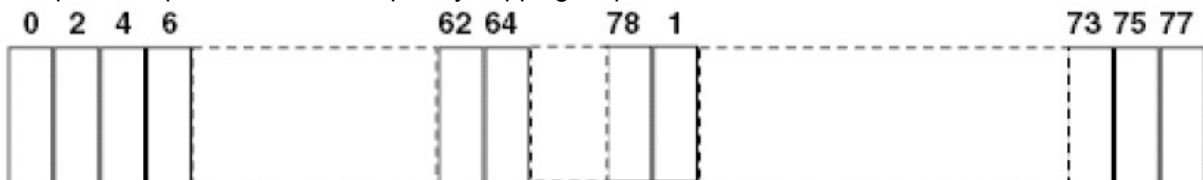

Each frequency used equally one the average by each transmitter. The system receiver have input bandwidths that match the hopping channel bandwidths of their corresponding transmitter and shift frequencies in synchronization with the transmitted signals.

5.9. Restricted band (radiated)

LIMIT

FCC CFR Title 47 Part 15 Subpart C Section 15.247 (d):

In any 100 kHz bandwidth outside the frequency band in which the spread spectrum or digitally modulated intentional radiator is operating, Radiated Emissions which fall in the restricted bands, as defined in §15.205(a), must also comply with the Radiated Emissions limits specified in §15.209(a) (see §15.205(c)).

TEST CONFIGURATION

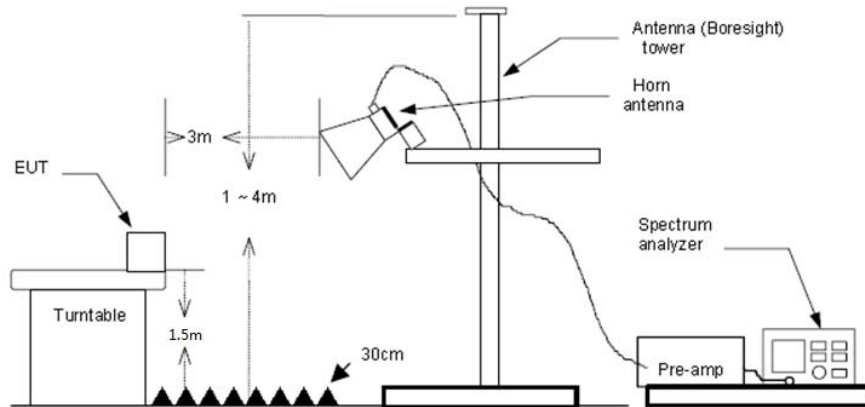

TEST PROCEDURE

1. The EUT was setup and tested according to ANSI C63.10:2013 for compliance to FCC 47CFR 15.247 requirements.
2. The EUT is placed on a turn table which is 1.5 meter above ground. The turn table is rotated 360 degrees to determine the position of the maximum emission level.
3. The EUT was positioned such that the distance from antenna to the EUT was 3 meters.
4. The antenna is scanned from 1 meter to 4 meters to find out the maximum emission level. This is repeated for both horizontal and vertical polarization of the antenna. In order to find the maximum emission, all of the interface cables were manipulated according to ANSI C63.10:2013 on radiated measurement.
5. The receiver set as follow:
 RBW=1 MHz, VBW=3 MHz Peak detector for Peak value
 RBW=1 MHz, VBW=10 Hz Peak detector for Average value.

TEST MODE:

Please refer to the clause 3.3

TEST RESULTS

Passed Not Applicable

Note:

- 1) Final level= Read level + Antenna Factor+ Cable Loss- Preamp Factor
- 2) Have pre-scan all modulation mode, found the GFSK modulation which it was worst case, so only the worst case's data on the test report.
- 3) The peak level is lower than average limit(54 dBuV/m), this data is the too weak instrument of signal is unable to test.

CH00									
Frequency (MHz)	Read Level (dBUV)	Antenna Factor (dB/m)	Cable Loss (dB)	Preamp Factor (dB)	Level (dBUV/m)	Limit Line (dBUV/m)	Over Limit (dB)	Polarization	Test value
2310.00	37.05	28.05	6.62	37.65	34.07	74.00	-39.93	Vertical	Peak
2322.10	45.71	27.99	6.64	37.68	42.66	74.00	-31.34	Vertical	Peak
2390.03	45.65	27.65	6.75	37.87	42.18	74.00	-31.82	Vertical	Peak
2310.00	36.71	28.05	6.62	37.65	33.73	74.00	-40.27	Horizontal	Peak
2322.00	48.49	27.99	6.64	37.68	45.44	74.00	-28.56	Horizontal	Peak
2390.03	40.98	27.65	6.75	37.87	37.51	74.00	-36.49	Horizontal	Peak
2310.00	24.12	28.05	6.62	37.65	21.14	54.00	-32.86	Vertical	Average
2321.91	40.74	27.99	6.64	37.68	37.69	54.00	-16.31	Vertical	Average
2390.03	26.84	27.65	6.75	37.87	23.37	54.00	-30.63	Vertical	Average
2310.00	23.57	28.05	6.62	37.65	20.59	54.00	-33.41	Horizontal	Average
2376.01	30.99	27.72	6.73	37.83	27.61	54.00	-26.39	Horizontal	Average
2390.03	24.09	27.65	6.75	37.87	20.62	54.00	-33.38	Horizontal	Average

CH78									
Frequency (MHz)	Read Level (dBUV)	Antenna Factor (dB/m)	Cable Loss (dB)	Preamp Factor (dB)	Level (dBUV/m)	Limit Line (dBUV/m)	Over Limit (dB)	Polarization	Test value
2483.50	55.66	27.26	6.83	37.87	51.88	74.00	-22.12	Vertical	Peak
2496.33	53.03	27.21	6.84	37.87	49.21	74.00	-24.79	Vertical	Peak
2500.00	36.13	27.20	6.84	37.87	32.30	74.00	-41.70	Vertical	Peak
2483.50	55.57	27.26	6.83	37.87	51.79	74.00	-22.21	Horizontal	Peak
2496.41	51.54	27.21	6.84	37.87	47.72	74.00	-26.28	Horizontal	Peak
2500.00	36.03	27.20	6.84	37.87	32.20	74.00	-41.80	Horizontal	Peak
2483.50	50.63	27.26	6.83	37.87	46.85	54.00	-7.15	Vertical	Average
2500.00	23.53	27.20	6.84	37.87	19.70	54.00	-34.30	Vertical	Average
2483.50	48.62	27.26	6.83	37.87	44.84	54.00	-9.16	Horizontal	Average
2500.00	23.25	27.20	6.84	37.87	19.42	54.00	-34.58	Horizontal	Average

5.10. Band edge and Spurious Emissions (conducted)

LIMIT

FCC CFR Title 47 Part 15 Subpart C Section 15.247 (d): In any 100 kHz bandwidth outside the frequency band in which the spread spectrum intentional radiator is operating, the radio frequency power that is produced by the intentional radiator shall be at least 20 dB below that in the 100 kHz bandwidth within the band that contains the highest level of the desired power, based on either an RF conducted or a radiated measurement.

TEST CONFIGURATION

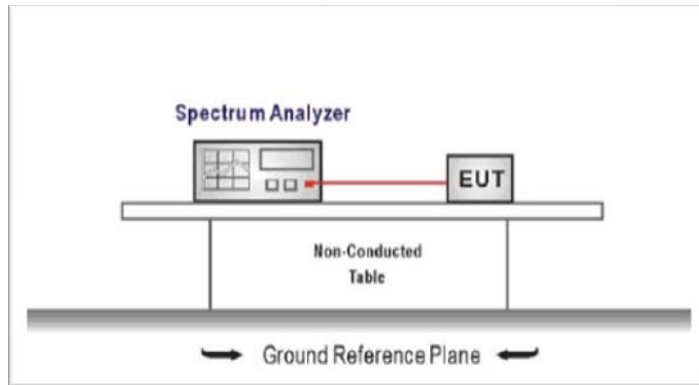

TEST PROCEDURE

1. The transmitter output was connected to the spectrum analyzer through an attenuator, the path loss was compensated to the results for each measurement.
2. Set to the maximum power setting and enable the EUT transmit continuously
3. Use the following spectrum analyzer settings:
RBW = 100 kHz, VBW \geq RBW
Sweep = auto, Detector function = peak, Trace = max hold
4. Measure and record the results in the test report.

TEST MODE:

Please refer to the clause 3.3

TEST RESULTS

Passed Not Applicable

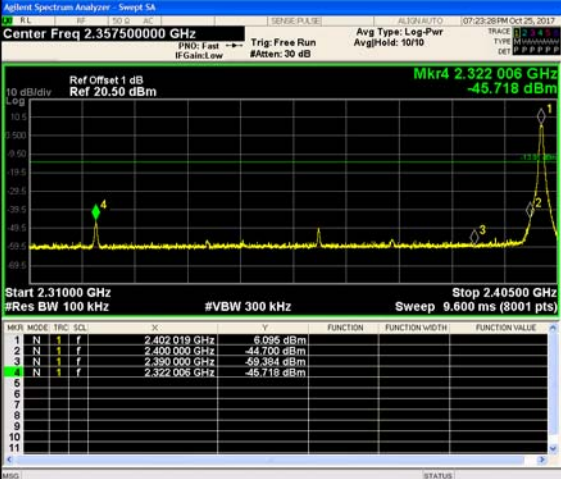
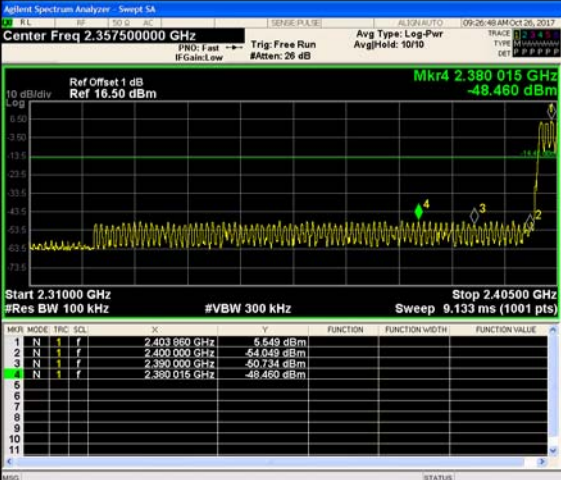
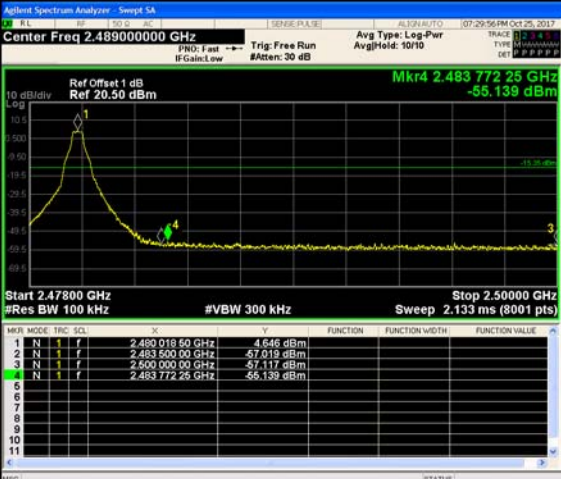
Test Item:	Band edge	Modulation type:	GFSK
<p>CH00 No hopping mode</p>			<p>Frequency</p> <p>Auto Tune</p> <p>Center Freq 2.357500000 GHz</p> <p>Start Freq 2.310000000 GHz</p> <p>Stop Freq 2.405000000 GHz</p> <p>CF Step 9.500000 MHz</p> <p>Freq Offset 0 Hz</p>
<p>CH00 Hopping mode</p>			<p>Frequency</p> <p>Auto Tune</p> <p>Center Freq 2.357500000 GHz</p> <p>Start Freq 2.310000000 GHz</p> <p>Stop Freq 2.405000000 GHz</p> <p>CF Step 9.500000 MHz</p> <p>Freq Offset 0 Hz</p>
<p>CH78 No hopping mode</p>			<p>Frequency</p> <p>Auto Tune</p> <p>Center Freq 2.489000000 GHz</p> <p>Start Freq 2.478000000 GHz</p> <p>Stop Freq 2.500000000 GHz</p> <p>CF Step 2.200000 MHz</p> <p>Freq Offset 0 Hz</p>

CH78
Hopping mode

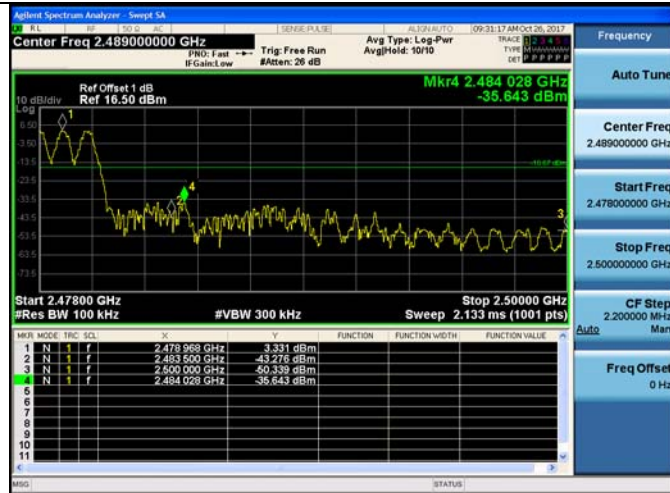

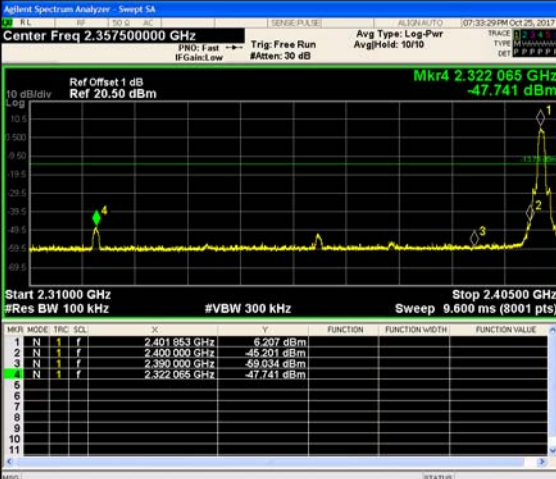
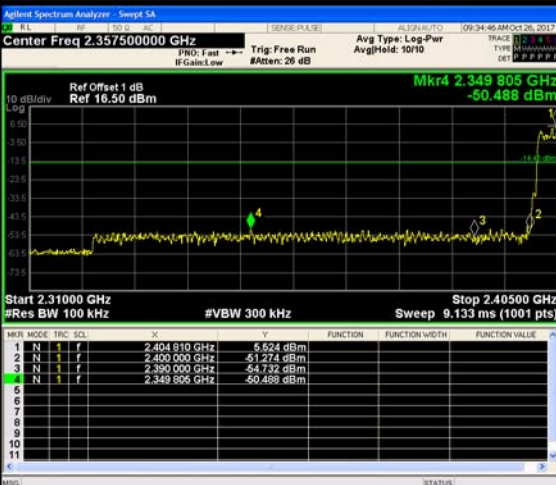
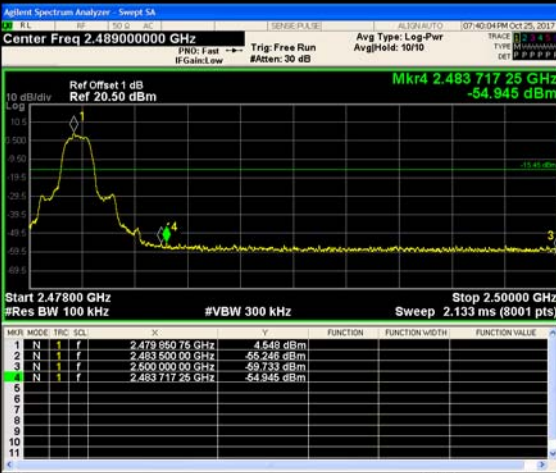
Test Item:	Band edge	Modulation type:	$\pi/4$ DQPSK
<p>CH00</p> <p>No hopping mode</p>		<p>Center Freq 2.357500000 GHz</p> <p>Start Freq 2.310000000 GHz</p> <p>Stop Freq 2.405000000 GHz</p> <p>CF Step 9.500000 MHz</p> <p>Freq Offset 0 Hz</p>	<p>Frequency</p> <p>Auto Tune</p> <p>Center Freq 2.357500000 GHz</p> <p>Start Freq 2.310000000 GHz</p> <p>Stop Freq 2.405000000 GHz</p> <p>CF Step 9.500000 MHz</p> <p>Freq Offset 0 Hz</p>
<p>CH00</p> <p>Hopping mode</p>		<p>Center Freq 2.357500000 GHz</p> <p>Start Freq 2.310000000 GHz</p> <p>Stop Freq 2.405000000 GHz</p> <p>CF Step 9.500000 MHz</p> <p>Freq Offset 0 Hz</p>	<p>Frequency</p> <p>Auto Tune</p> <p>Center Freq 2.357500000 GHz</p> <p>Start Freq 2.310000000 GHz</p> <p>Stop Freq 2.405000000 GHz</p> <p>CF Step 9.500000 MHz</p> <p>Freq Offset 0 Hz</p>
<p>CH78</p> <p>No hopping mode</p>		<p>Center Freq 2.489000000 GHz</p> <p>Start Freq 2.478000000 GHz</p> <p>Stop Freq 2.500000000 GHz</p> <p>CF Step 2.200000 MHz</p> <p>Freq Offset 0 Hz</p>	<p>Frequency</p> <p>Auto Tune</p> <p>Center Freq 2.489000000 GHz</p> <p>Start Freq 2.478000000 GHz</p> <p>Stop Freq 2.500000000 GHz</p> <p>CF Step 2.200000 MHz</p> <p>Freq Offset 0 Hz</p>

CH78
Hopping mode

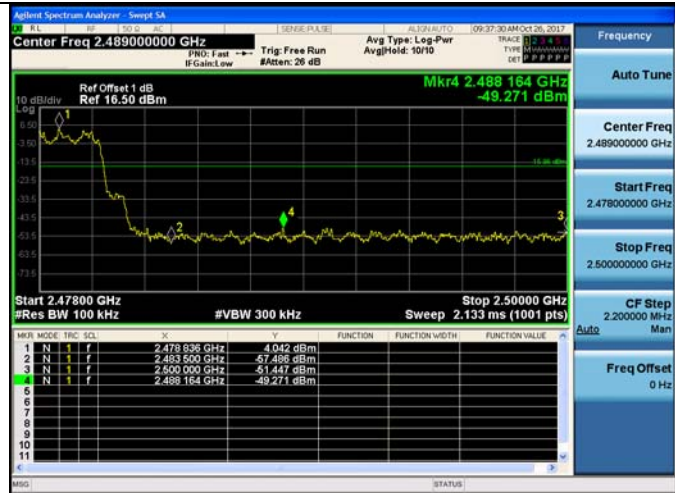

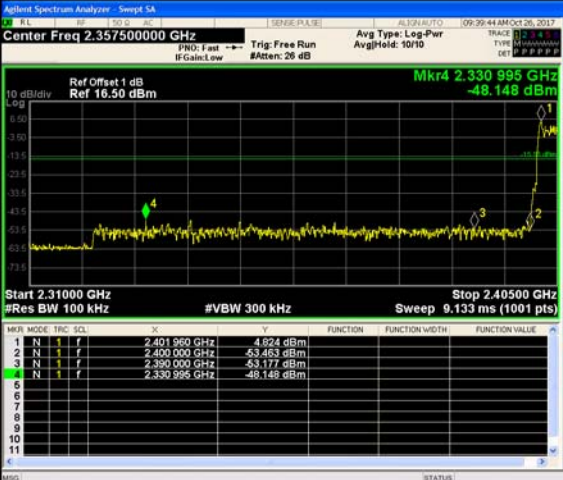
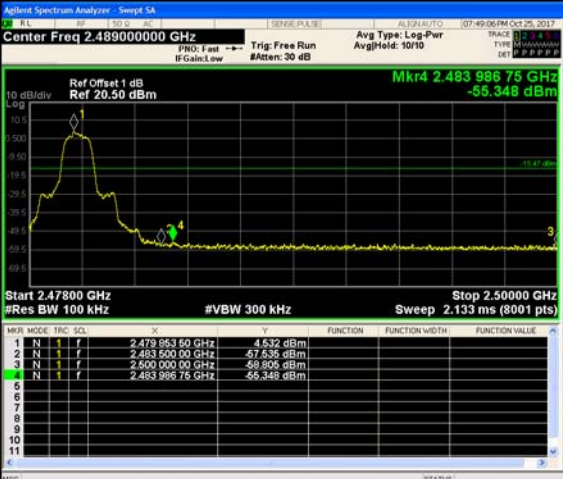

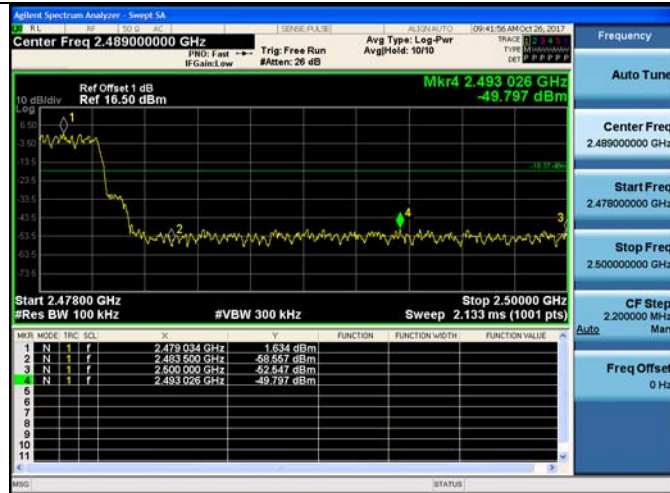

Test Item:	Band edge	Modulation type:	8DPSK
<p>CH00</p> <p>No hopping mode</p>			<p>Frequency</p> <p>Auto Tune</p> <p>Center Freq 2.357500000 GHz</p> <p>Start Freq 2.310000000 GHz</p> <p>Stop Freq 2.405000000 GHz</p> <p>CF Step 9.500000 MHz</p> <p>Freq Offset 0 Hz</p>
<p>CH00</p> <p>Hopping mode</p>			<p>Frequency</p> <p>Auto Tune</p> <p>Center Freq 2.357500000 GHz</p> <p>Start Freq 2.310000000 GHz</p> <p>Stop Freq 2.405000000 GHz</p> <p>CF Step 9.500000 MHz</p> <p>Freq Offset 0 Hz</p>
<p>CH78</p> <p>No hopping mode</p>			<p>Frequency</p> <p>Auto Tune</p> <p>Center Freq 2.489000000 GHz</p> <p>Start Freq 2.478000000 GHz</p> <p>Stop Freq 2.500000000 GHz</p> <p>CF Step 2.200000 MHz</p> <p>Freq Offset 0 Hz</p>

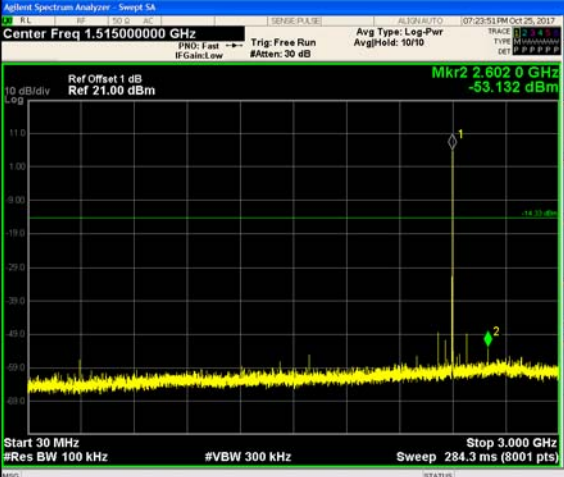
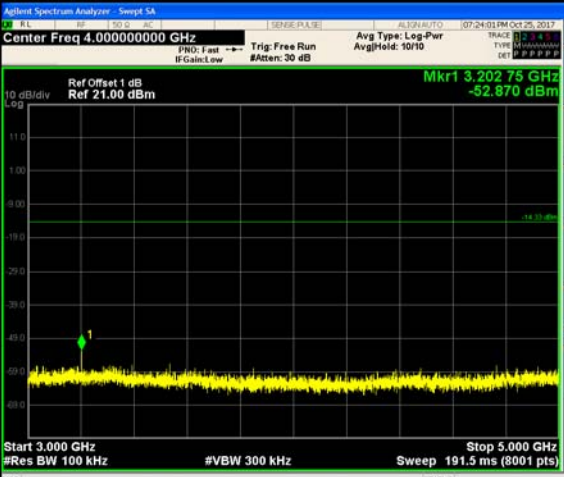
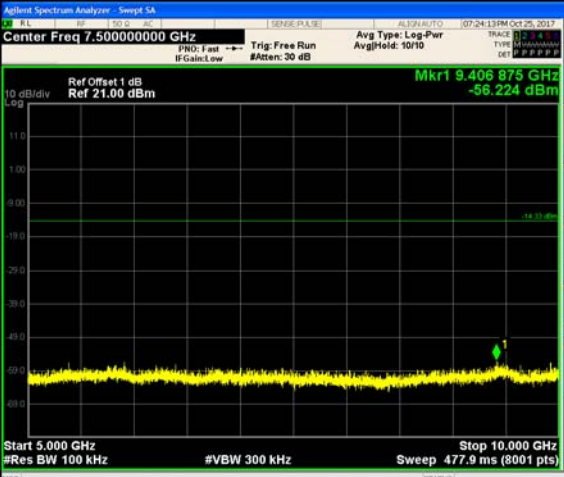
CH78
Hoppig mode

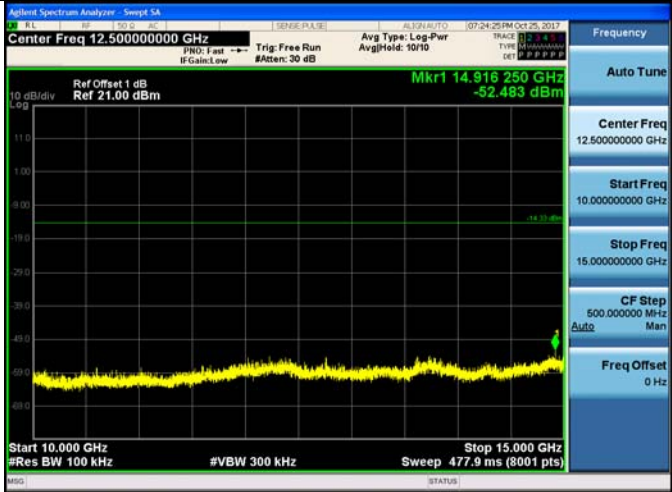

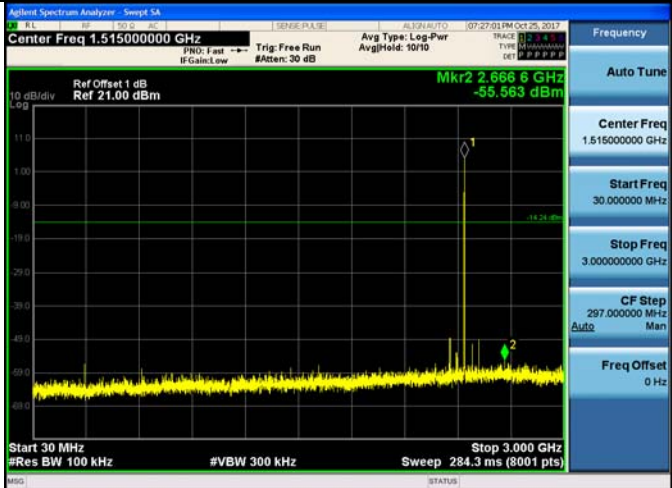
Test Item:	SE	Modulation type:	GFSK
<p>CH00 30MHz~3GHz</p>			<p>Frequency</p> <p>Auto Tune</p> <p>Center Freq 1.515000000 GHz</p> <p>Start Freq 30.0000000 MHz</p> <p>Stop Freq 3.000000000 GHz</p> <p>CF Step 297.000000 MHz Auto Man</p> <p>Freq Offset 0 Hz</p>
<p>CH00 3GHz~5GHz</p>			<p>Frequency</p> <p>Auto Tune</p> <p>Center Freq 4.000000000 GHz</p> <p>Start Freq 3.000000000 GHz</p> <p>Stop Freq 5.000000000 GHz</p> <p>CF Step 200.000000 MHz Auto Man</p> <p>Freq Offset 0 Hz</p>
<p>CH00 5GHz~10GHz</p>			<p>Frequency</p> <p>Auto Tune</p> <p>Center Freq 7.500000000 GHz</p> <p>Start Freq 5.000000000 GHz</p> <p>Stop Freq 10.000000000 GHz</p> <p>CF Step 500.000000 MHz Auto Man</p> <p>Freq Offset 0 Hz</p>

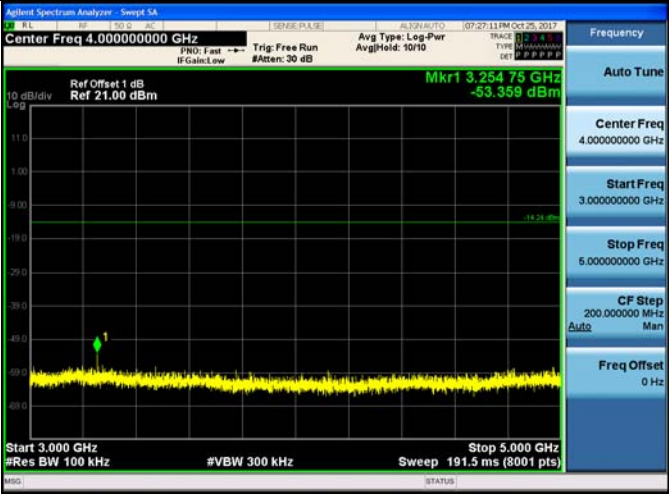

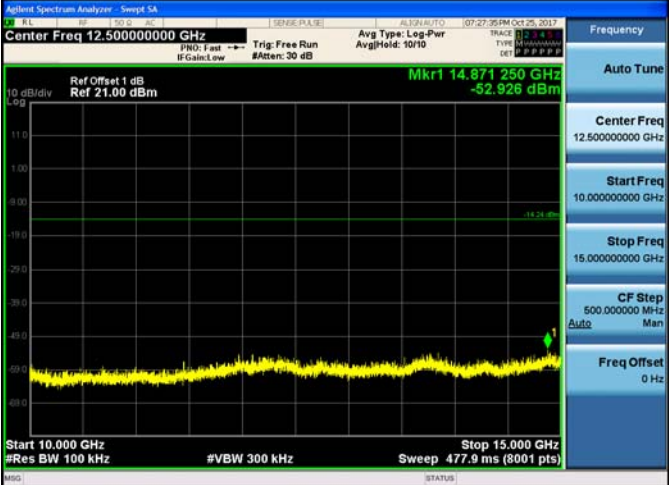
<p>CH00 10GHz~15GHz</p>	
<p>CH00 15GHz~25GHz</p>	
<p>CH39 30MHz~3GHz</p>	

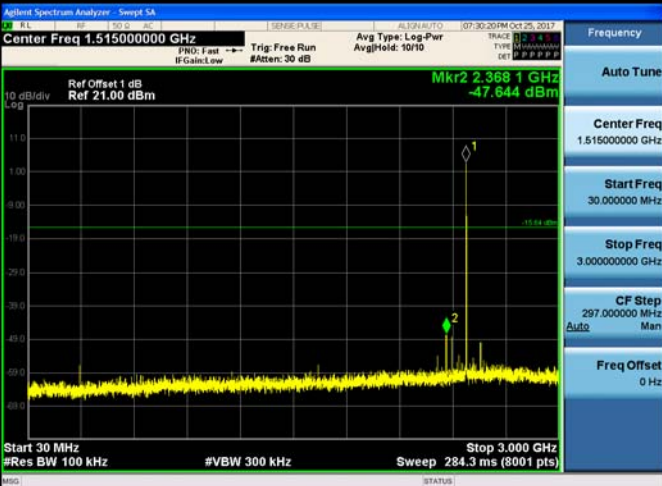
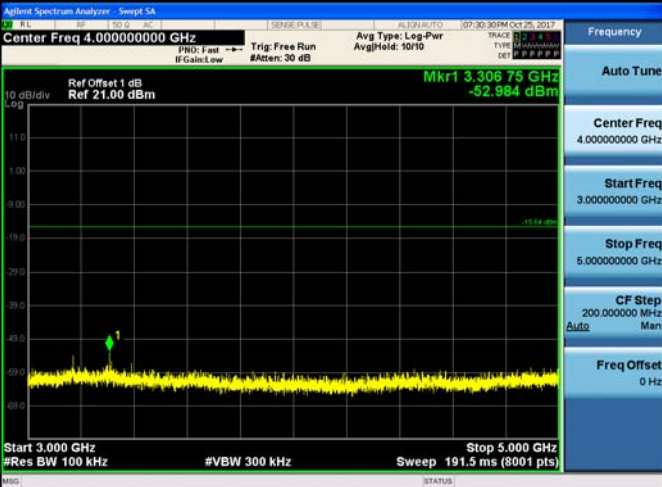
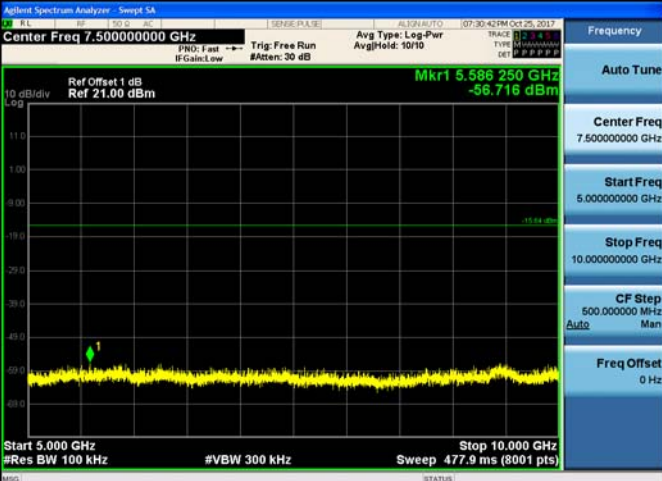

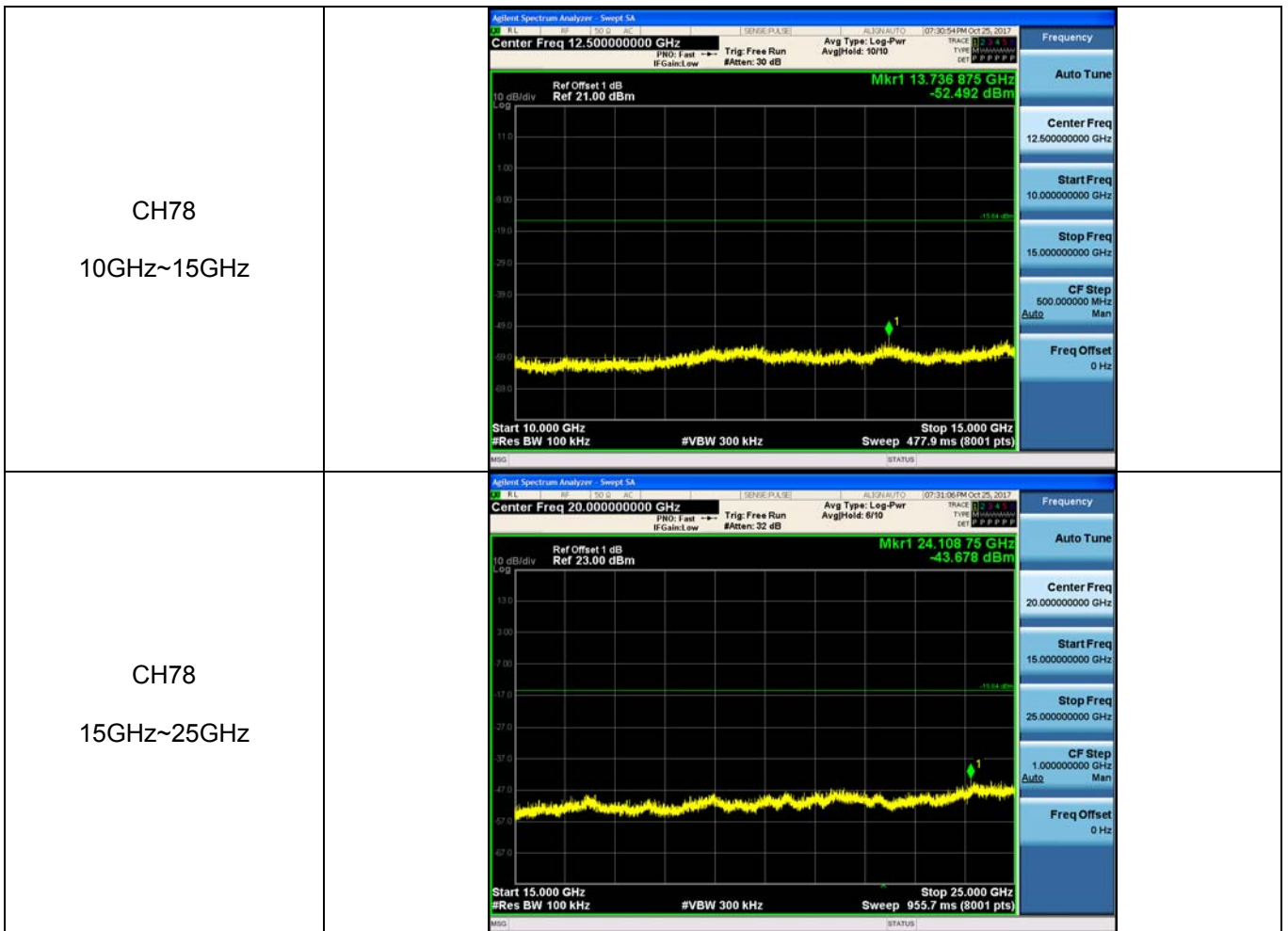
<p>CH39 3GHz~5GHz</p>	
<p>CH39 5GHz~10GHz</p>	
<p>CH39 10GHz~15GHz</p>	

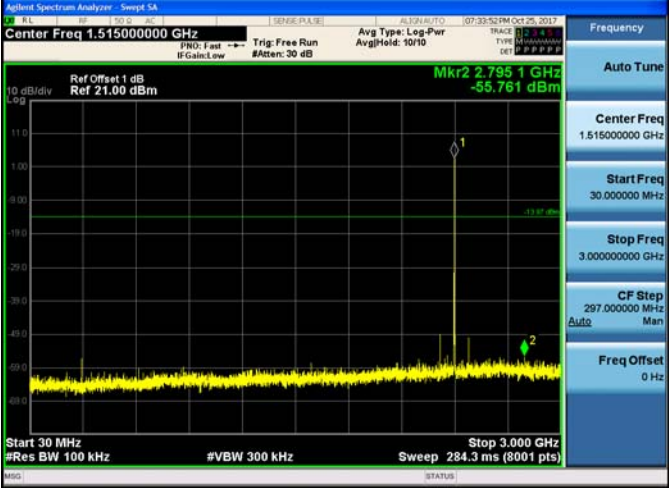
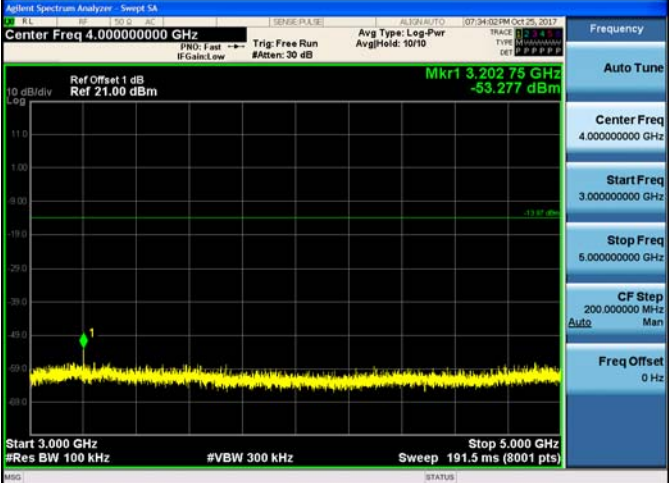
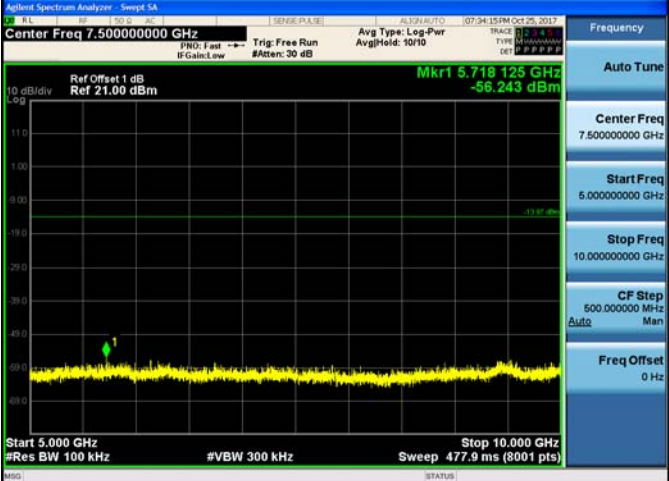
<p>CH39 15GHz~25GHz</p>	
<p>CH78 30MHz~3GHz</p>	
<p>CH78 3GHz~5GHz</p>	
<p>CH78 5GHz~10GHz</p>	

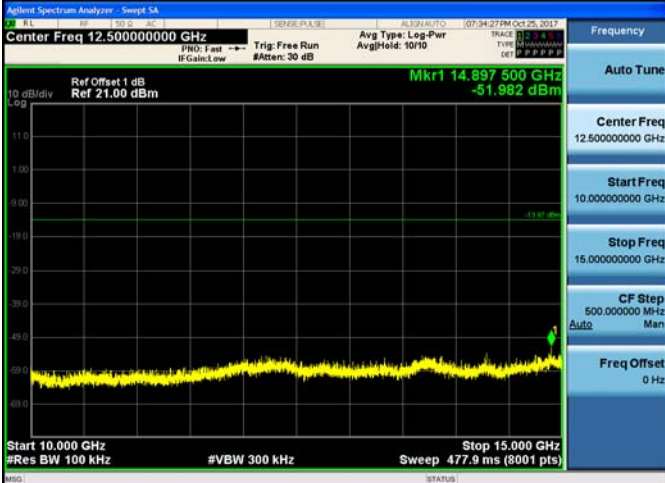

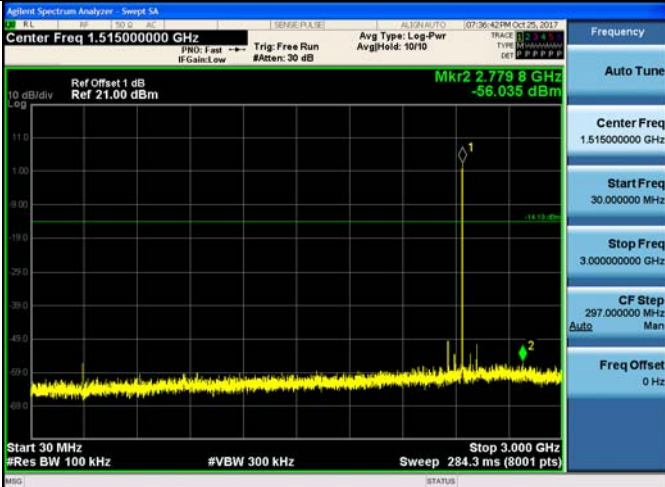
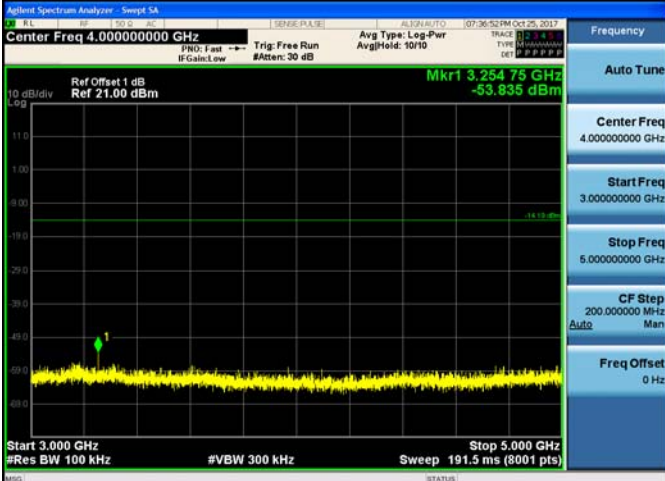
Test Item:	SE	Modulation type:	$\pi/4$ DQPSK
<p>CH00 30MHz~3GHz</p>			<p>Frequency</p> <p>Auto Tune</p> <p>Center Freq 1.515000000 GHz</p> <p>Start Freq 30.0000000 MHz</p> <p>Stop Freq 3.000000000 GHz</p> <p>CF Step 297.000000 MHz Auto Man</p> <p>Freq Offset 0 Hz</p>
<p>CH00 3GHz~5GHz</p>			<p>Frequency</p> <p>Auto Tune</p> <p>Center Freq 4.000000000 GHz</p> <p>Start Freq 3.000000000 GHz</p> <p>Stop Freq 5.000000000 GHz</p> <p>CF Step 200.000000 MHz Auto Man</p> <p>Freq Offset 0 Hz</p>
<p>CH00 5GHz~10GHz</p>			<p>Frequency</p> <p>Auto Tune</p> <p>Center Freq 7.500000000 GHz</p> <p>Start Freq 5.000000000 GHz</p> <p>Stop Freq 10.000000000 GHz</p> <p>CF Step 500.000000 MHz Auto Man</p> <p>Freq Offset 0 Hz</p>

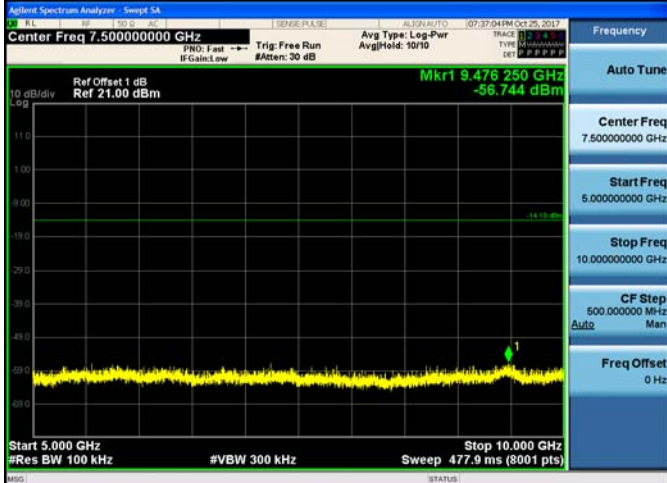
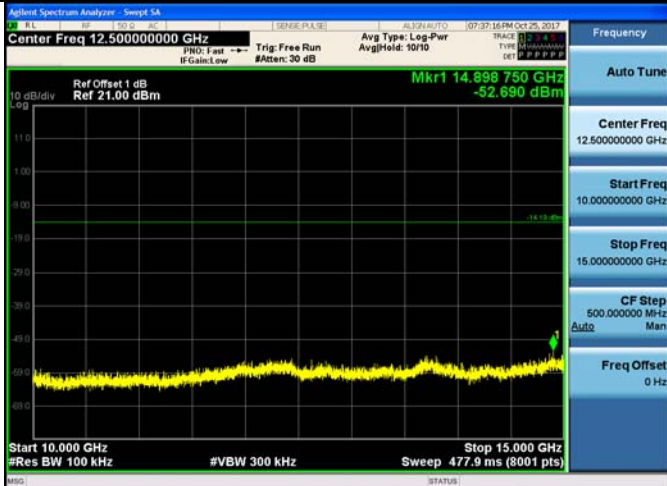

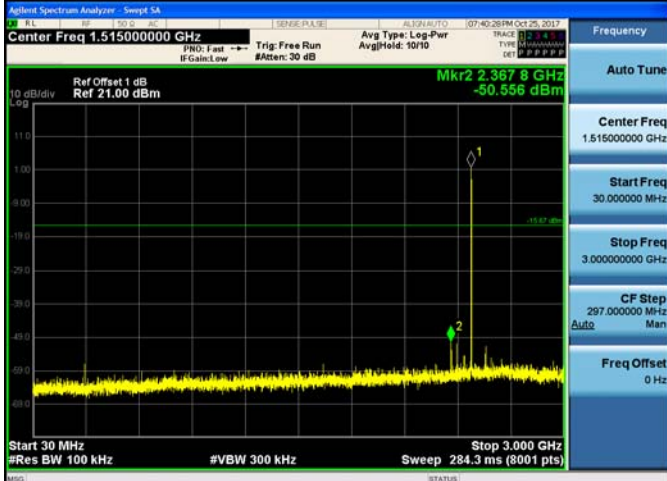
<p>CH00 10GHz~15GHz</p>	 <p>Agilent Spectrum Analyzer - Sweep SA Center Freq 12.500000000 GHz Mkr1 14.897 500 GHz -51.982 dBm Start 10.000 GHz Stop 15.000 GHz</p>
<p>CH00 15GHz~25GHz</p>	 <p>Agilent Spectrum Analyzer - Sweep SA Center Freq 20.000000000 GHz Mkr1 24.946 25 GHz -43.138 dBm Start 15.000 GHz Stop 25.000 GHz</p>
<p>CH39 30MHz~3GHz</p>	 <p>Agilent Spectrum Analyzer - Sweep SA Center Freq 1.515000000 GHz Mkr2 2.779 8 GHz -56.035 dBm Start 30 MHz Stop 3.000 GHz</p>
<p>CH39 3GHz~5GHz</p>	 <p>Agilent Spectrum Analyzer - Sweep SA Center Freq 4.000000000 GHz Mkr1 3.254 75 GHz -53.835 dBm Start 3.000 GHz Stop 5.000 GHz</p>

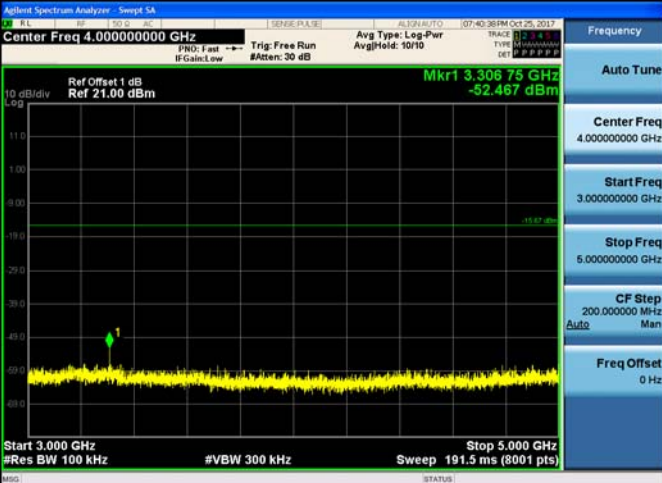
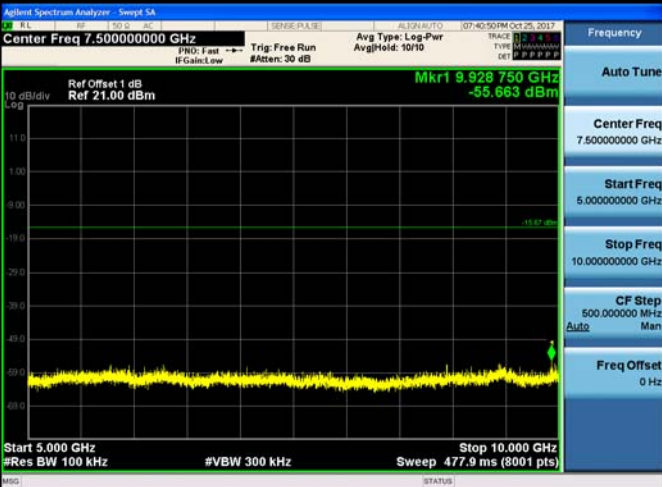
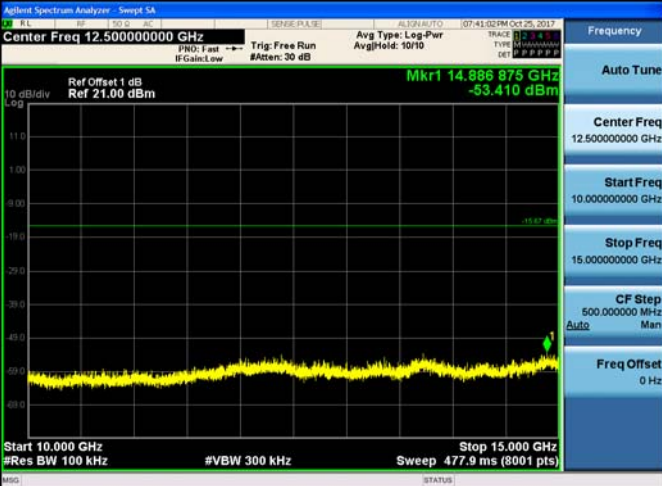

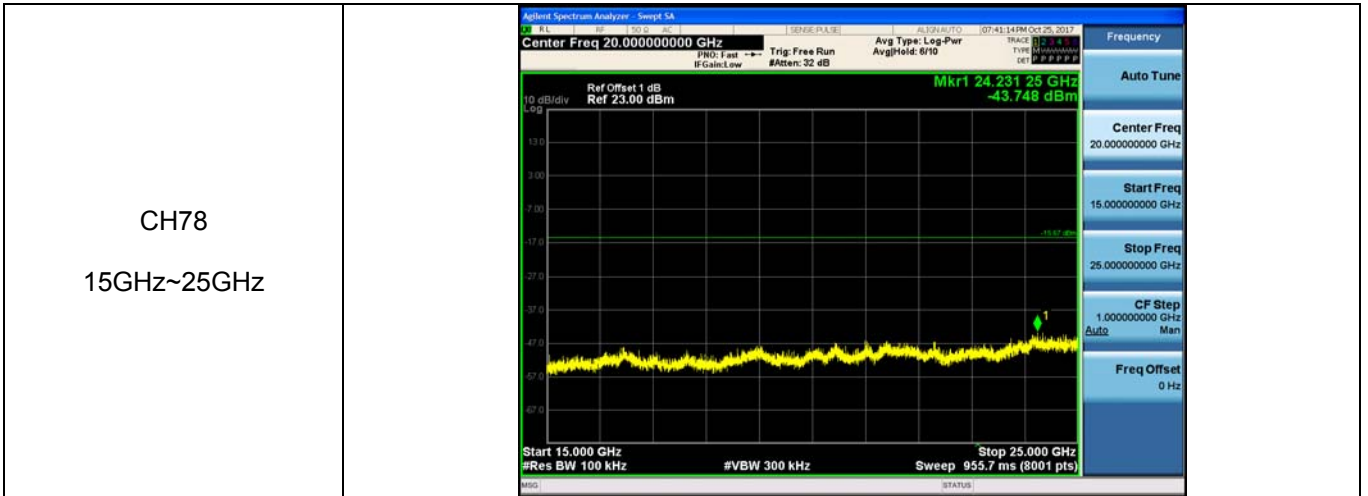
<p>CH39 5GHz~10GHz</p>	
<p>CH39 10GHz~15GHz</p>	
<p>CH39 15GHz~25GHz</p>	
<p>CH78 30MHz~3GHz</p>	

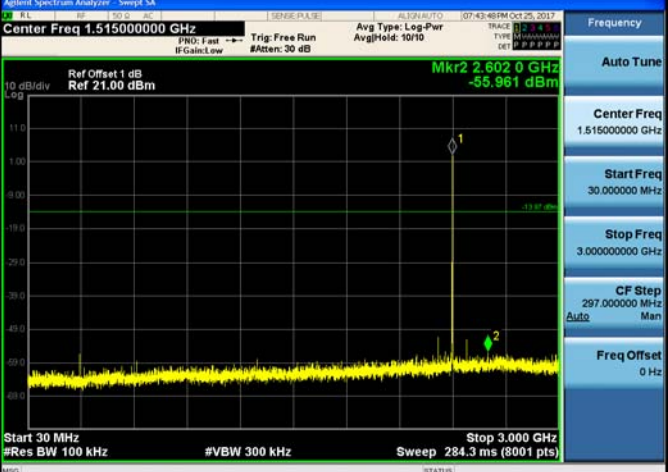
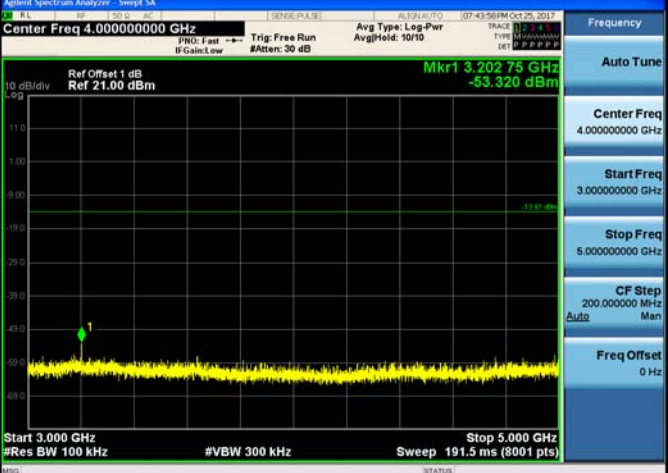
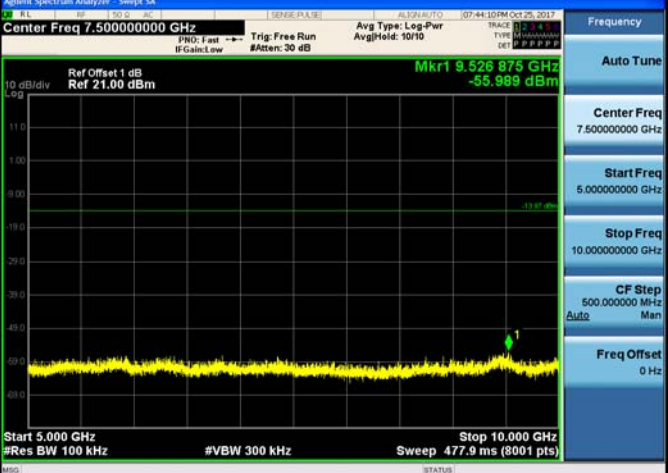
<p>CH78 3GHz~5GHz</p>		<p>Frequency</p> <p>Auto Tune</p> <p>Center Freq 4.00000000 GHz</p> <p>Start Freq 3.00000000 GHz</p> <p>Stop Freq 5.00000000 GHz</p> <p>CF Step 200.000000 MHz Auto Man</p> <p>Freq Offset 0 Hz</p>
<p>CH78 5GHz~10GHz</p>		<p>Frequency</p> <p>Auto Tune</p> <p>Center Freq 7.50000000 GHz</p> <p>Start Freq 5.00000000 GHz</p> <p>Stop Freq 10.00000000 GHz</p> <p>CF Step 500.000000 MHz Auto Man</p> <p>Freq Offset 0 Hz</p>
<p>CH78 10GHz~15GHz</p>		<p>Frequency</p> <p>Auto Tune</p> <p>Center Freq 12.50000000 GHz</p> <p>Start Freq 10.00000000 GHz</p> <p>Stop Freq 15.00000000 GHz</p> <p>CF Step 500.000000 MHz Auto Man</p> <p>Freq Offset 0 Hz</p>

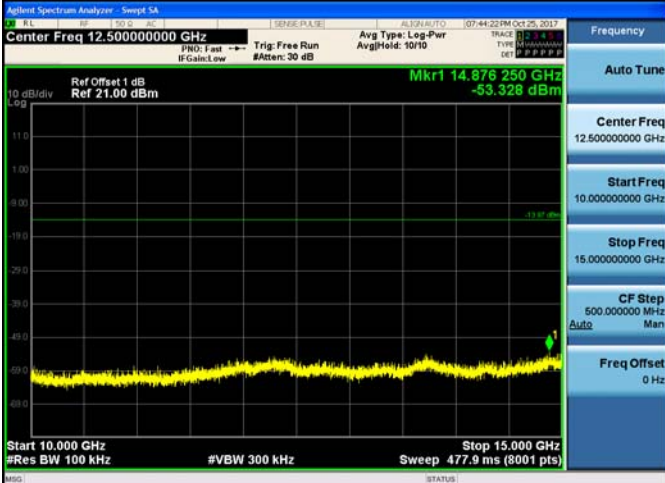

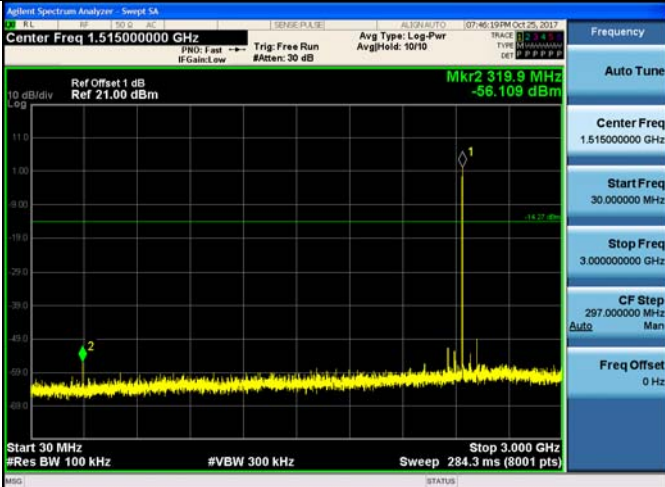
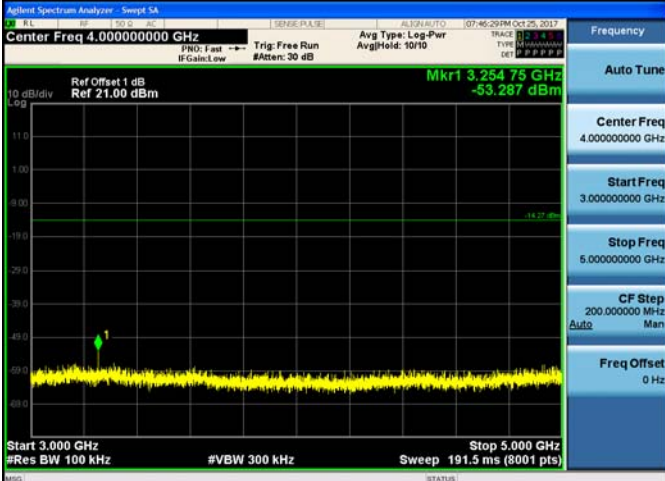
Test Item:	SE	Modulation type:	8DPSK
<p>CH00 30MHz~3GHz</p>			<p>Frequency</p> <p>Auto Tune</p> <p>Center Freq 1.515000000 GHz</p> <p>Start Freq 30.0000000 MHz</p> <p>Stop Freq 3.000000000 GHz</p> <p>CF Step 297.000000 MHz Auto Man</p> <p>Freq Offset 0 Hz</p>
<p>CH00 3GHz~5GHz</p>			<p>Frequency</p> <p>Auto Tune</p> <p>Center Freq 4.000000000 GHz</p> <p>Start Freq 3.000000000 GHz</p> <p>Stop Freq 5.000000000 GHz</p> <p>CF Step 200.000000 MHz Auto Man</p> <p>Freq Offset 0 Hz</p>
<p>CH00 5GHz~10GHz</p>			<p>Frequency</p> <p>Auto Tune</p> <p>Center Freq 7.500000000 GHz</p> <p>Start Freq 5.000000000 GHz</p> <p>Stop Freq 10.000000000 GHz</p> <p>CF Step 500.000000 MHz Auto Man</p> <p>Freq Offset 0 Hz</p>

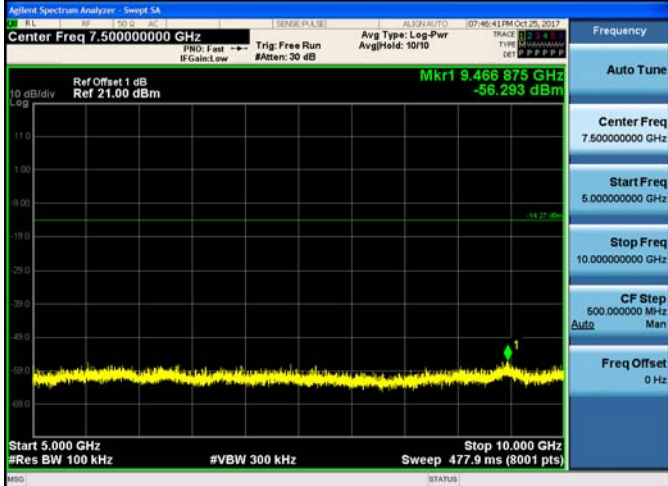
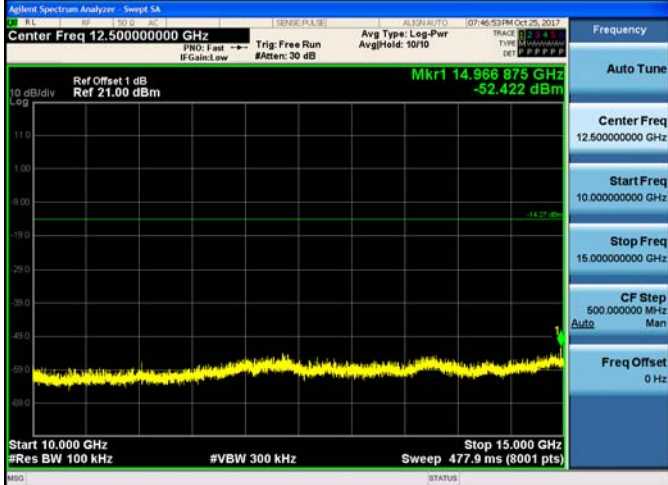
<p>CH00 10GHz~15GHz</p>	 <p>Agilent Spectrum Analyzer - Sweep SA Center Freq 12.500000000 GHz Ref Offset 1 dB Ref 21.00 dBm Mkr1 14.876 250 GHz -53.328 dBm Start 10.000 GHz #Res BW 100 kHz #VBW 300 kHz Sweep 477.9 ms (8001 pts)</p>
<p>CH00 15GHz~25GHz</p>	 <p>Agilent Spectrum Analyzer - Sweep SA Center Freq 20.000000000 GHz Ref Offset 1 dB Ref 23.00 dBm Mkr1 24.556 00 GHz -43.968 dBm Start 15.000 GHz #Res BW 100 kHz #VBW 300 kHz Sweep 955.7 ms (8001 pts)</p>
<p>CH39 30MHz~3GHz</p>	 <p>Agilent Spectrum Analyzer - Sweep SA Center Freq 1.515000000 GHz Ref Offset 1 dB Ref 21.00 dBm Mkr2 319.9 MHz -56.109 dBm Start 30 MHz #Res BW 100 kHz #VBW 300 kHz Sweep 284.3 ms (8001 pts)</p>
<p>CH39 3GHz~5GHz</p>	 <p>Agilent Spectrum Analyzer - Sweep SA Center Freq 4.000000000 GHz Ref Offset 1 dB Ref 21.00 dBm Mkr1 3.254 75 GHz -53.287 dBm Start 3.000 GHz #Res BW 100 kHz #VBW 300 kHz Sweep 191.5 ms (8001 pts)</p>

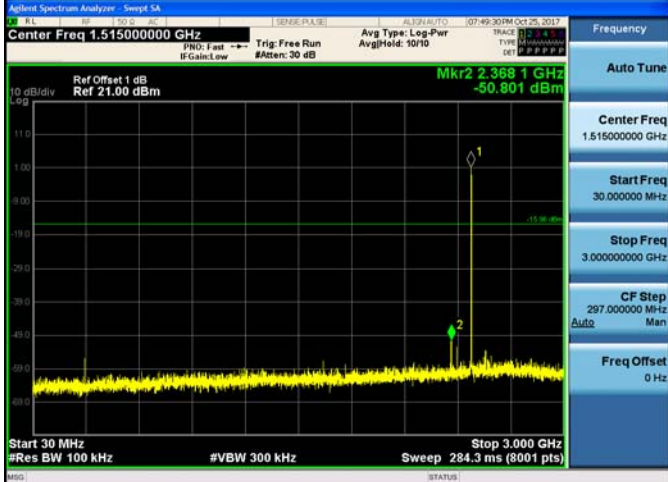
<p>CH39 5GHz~10GHz</p>	
<p>CH39 10GHz~15GHz</p>	
<p>CH39 15GHz~25GHz</p>	
<p>CH78 30MHz~3GHz</p>	

<p>CH78 3GHz~5GHz</p>		<p>Frequency</p> <p>Auto Tune</p> <p>Center Freq 4.00000000 GHz</p> <p>Start Freq 3.00000000 GHz</p> <p>Stop Freq 5.00000000 GHz</p> <p>CF Step 200.000000 MHz Auto Man</p> <p>Freq Offset 0 Hz</p>
<p>CH78 5GHz~10GHz</p>		<p>Frequency</p> <p>Auto Tune</p> <p>Center Freq 7.50000000 GHz</p> <p>Start Freq 5.00000000 GHz</p> <p>Stop Freq 10.00000000 GHz</p> <p>CF Step 500.000000 MHz Auto Man</p> <p>Freq Offset 0 Hz</p>
<p>CH78 10GHz~15GHz</p>		<p>Frequency</p> <p>Auto Tune</p> <p>Center Freq 12.50000000 GHz</p> <p>Start Freq 10.00000000 GHz</p> <p>Stop Freq 15.00000000 GHz</p> <p>CF Step 500.000000 MHz Auto Man</p> <p>Freq Offset 0 Hz</p>

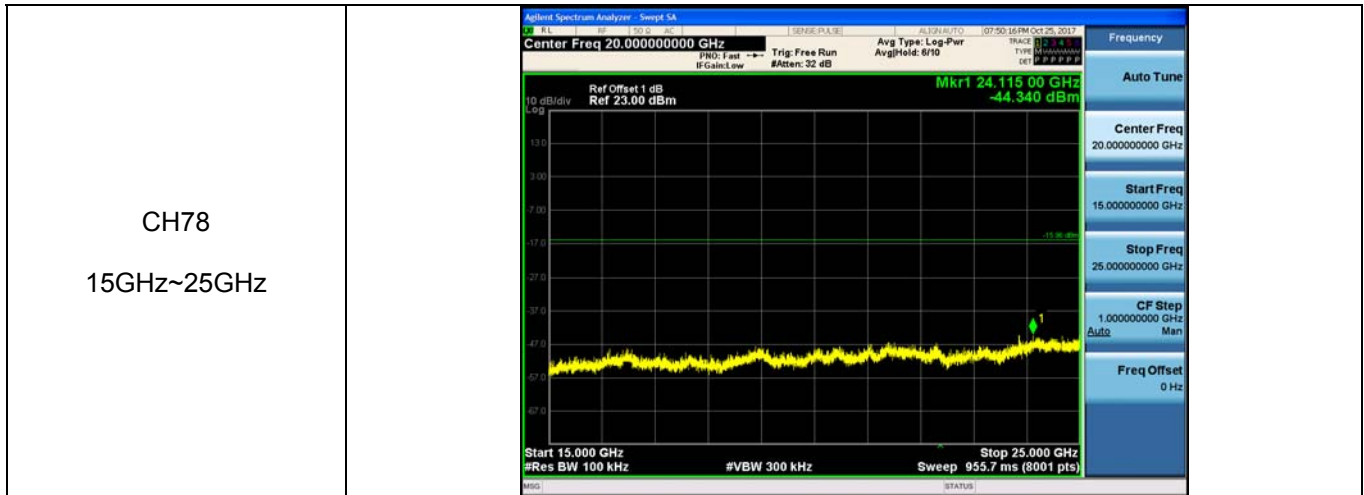

5.11. Spurious Emissions (radiated)

LIMIT

FCC CFR Title 47 Part 15 Subpart C Section 15.209

Frequency	Limit (dBuV/m @3m)	Value
30 MHz ~ 88 MHz	40.00	Quasi-peak
88 MHz ~ 216 MHz	43.50	Quasi-peak
216 MHz ~ 960 MHz	46.00	Quasi-peak
960 MHz ~ 1 GHz	54.00	Quasi-peak
Above 1 GHz	54.00	Average
	74.00	Peak

TEST CONFIGURATION

- Below 30 MHz

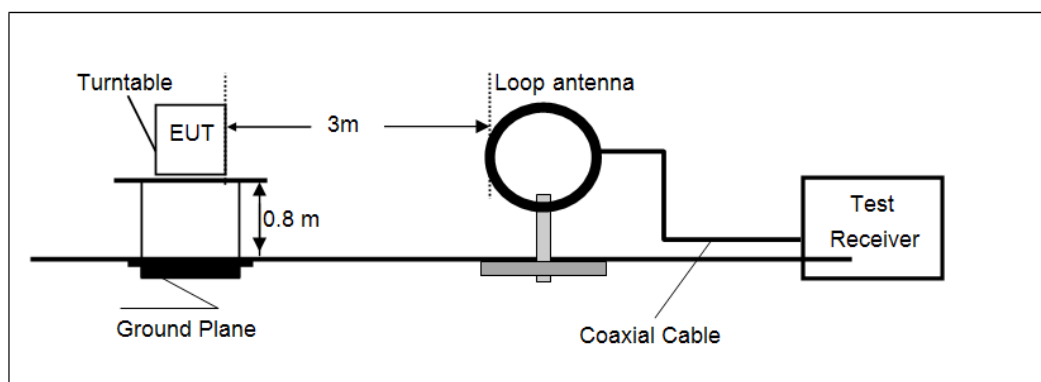

- 30 MHz ~1000 MHz

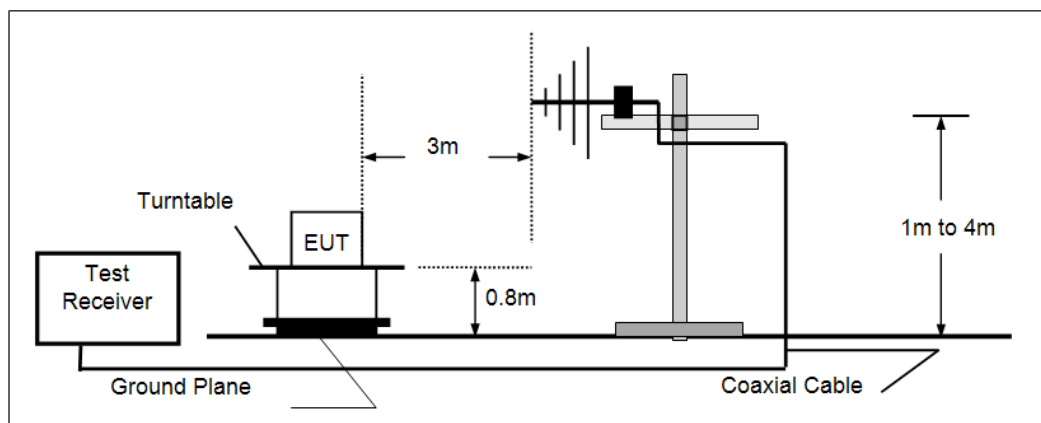

- Above 1 GHz

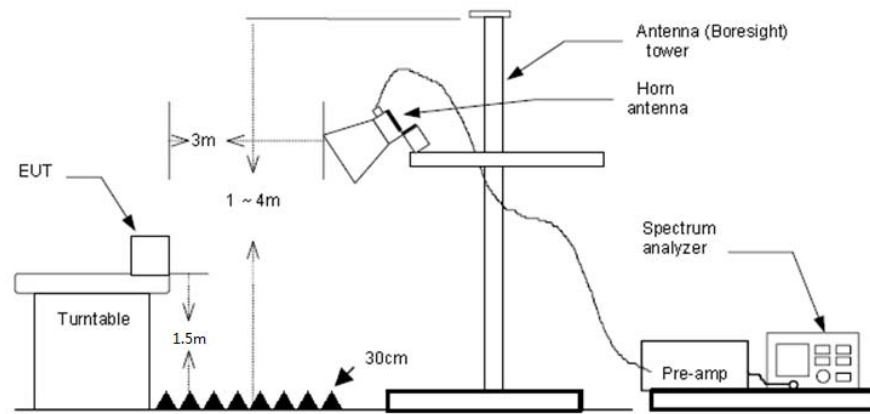

TEST PROCEDURE

1. The EUT was tested according to ANSI C63.10:2013.
2. The EUT is placed on a turn table which is 0.8 meter above ground. The turn table is rotated 360 degrees to determine the position of the maximum emission level.
3. The EUT was positioned such that the distance from antenna to the EUT was 3 meters.
4. The antenna is scanned from 1 meter to 4 meters to find out the maximum emission level. This is repeated for both horizontal and vertical polarization of the antenna.
5. Use the following spectrum analyzer settings
 - (1) Span shall wide enough to fully capture the emission being measured;
 - (2) Below 1 GHz, RBW=120 kHz, VBW=300 kHz, Sweep=auto, Detector function=QP, Trace=max hold; If the emission level of the EUT measured by the peak detector is 3 dB lower than the applicable limit, the peak emission level will be reported. Otherwise, the emission measurement will be repeated using the quasi-peak detector and reported.
 - (3) Above 1 GHz, RBW=1 MHz, VBW=3 MHz Peak detector for Peak value
RBW=1 MHz, VBW=10 Hz Peak detector for Average value.

TEST MODE:

Please refer to the clause 3.3

TEST RESULTS

Passed **Not Applicable**

Note:

- 1) Final Level = Receiver Read level + Antenna Factor + Cable Loss – Preamplifier Factor
- 2) The emission levels of other frequencies are very lower than the limit and not show in test report.
- 3) Below 1 GHz, Have pre-scan all modulation mode, found the GFSK modulation High channel which it was worst case, so only the worst case's data on the test report.
- 4) Above 1 GHz, Have pre-scan all modulation mode, found the GFSK modulation which it was worst case, so only the worst case's data on the test report
- 5) The peak level is lower than average limit (54 dBuV/m), this data is the too weak instrument of signal is unable to test.

➤ **9 kHz ~ 30 MHz**

The low frequency, which started from 9 kHz to 30 MHz, was pre-scanned and the result which was 20 dB lower than the limit line per 15.31(o) was not reported.

➤ 30 MHz ~ 1 GHz

Polarization: Vertical

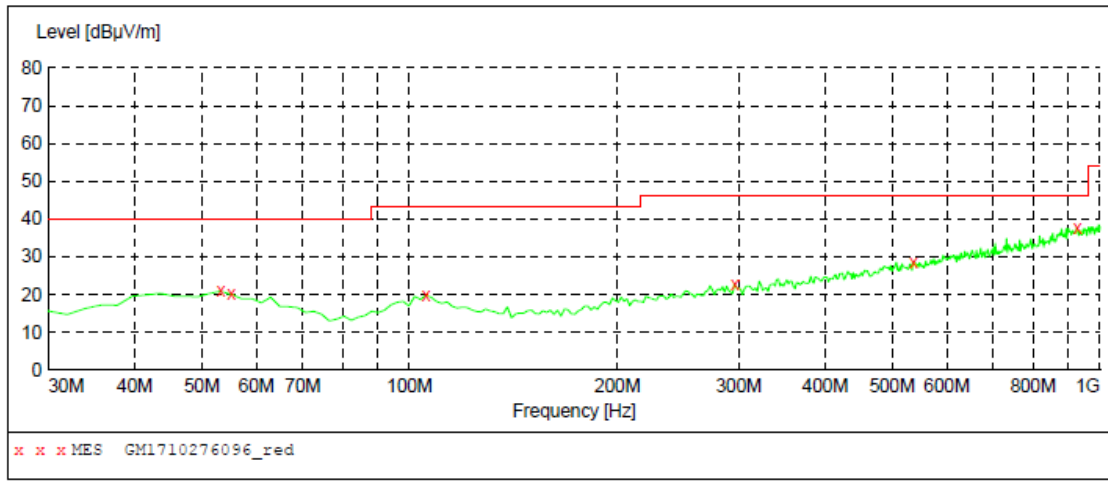

MEASUREMENT RESULT: "GM1710276096_red"

10/27/2017 8:57PM

Frequency MHz	Level dBuV/m	Transd dB	Limit dBuV/m	Margin dB	Det.	Height cm	Azimuth deg	Polarization
53.280000	20.90	-9.0	40.0	19.1	QP	100.0	204.00	VERTICAL
55.220000	20.10	-9.2	40.0	19.9	QP	100.0	164.00	VERTICAL
105.660000	19.80	-10.5	43.5	23.7	QP	100.0	359.00	VERTICAL
295.780000	22.80	-7.3	46.0	23.2	QP	100.0	0.00	VERTICAL
536.340000	28.70	-1.0	46.0	17.3	QP	100.0	29.00	VERTICAL
926.280000	37.60	7.1	46.0	8.4	QP	100.0	323.00	VERTICAL

Polarization: Horizontal

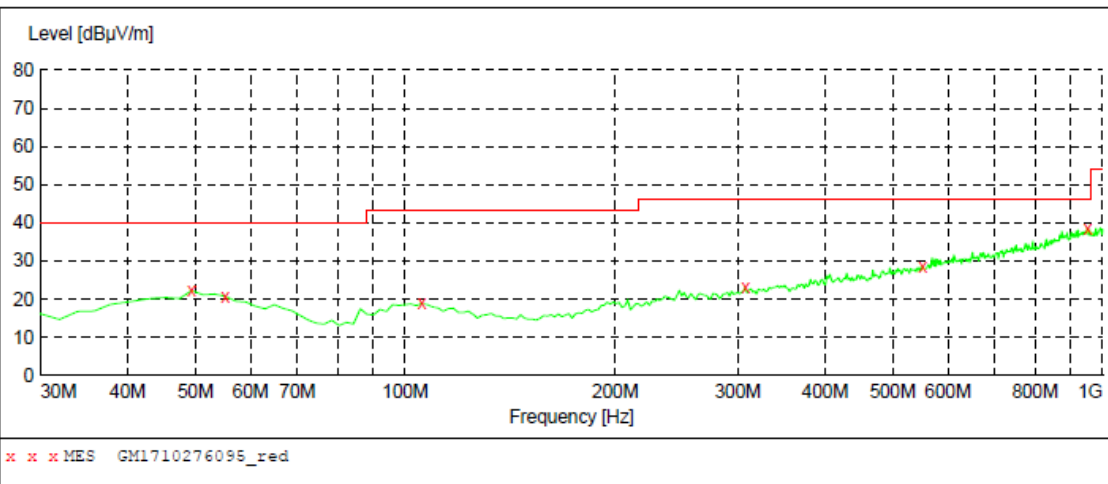

MEASUREMENT RESULT: "GM1710276095_red"

10/27/2017 8:55PM

Frequency MHz	Level dBuV/m	Transd dB	Limit dBuV/m	Margin dB	Det.	Height cm	Azimuth deg	Polarization
49.400000	22.30	-8.7	40.0	17.7	QP	100.0	109.00	HORIZONTAL
55.220000	20.80	-9.2	40.0	19.2	QP	300.0	36.00	HORIZONTAL
105.660000	18.90	-10.5	43.5	24.6	QP	100.0	232.00	HORIZONTAL
307.420000	23.00	-7.1	46.0	23.0	QP	100.0	150.00	HORIZONTAL
551.860000	28.60	-0.7	46.0	17.4	QP	300.0	296.00	HORIZONTAL
951.500000	38.60	7.3	46.0	7.4	QP	300.0	105.00	HORIZONTAL

➤ 1 GHz ~ 25 GHz

CH00									
Frequency (MHz)	Read Level (dBuV)	Antenna Factor (dB/m)	Cable Loss (dB)	Preamp Factor (dB)	Level (dBuV/m)	Limit Line (dBuV/m)	Over Limit (dB)	Polarization	Test value
1413.67	47.08	25.89	5.04	36.48	41.53	74.00	-32.47	Vertical	Peak
2571.25	49.45	27.63	6.89	37.85	46.12	74.00	-27.88	Vertical	Peak
4809.50	54.81	31.58	9.55	36.93	59.01	74.00	-14.99	Vertical	Peak
7209.02	38.07	36.21	11.87	35.07	51.08	74.00	-22.92	Vertical	Peak
4809.50	37.86	31.58	9.55	36.93	42.06	54.00	-11.94	Vertical	Average
1185.96	47.50	26.19	4.63	36.58	41.74	74.00	-32.26	Horizontal	Peak
2775.30	43.07	28.10	7.31	38.30	40.18	74.00	-33.82	Horizontal	Peak
4809.50	53.55	31.58	9.55	36.93	57.75	74.00	-16.25	Horizontal	Peak
7209.02	35.74	36.21	11.87	35.07	48.75	74.00	-25.25	Horizontal	Peak
4809.50	45.57	31.58	9.55	36.93	49.77	54.00	-4.23	Horizontal	Average

CH39									
Frequency (MHz)	Read Level (dBuV)	Antenna Factor (dB/m)	Cable Loss (dB)	Preamp Factor (dB)	Level (dBuV/m)	Limit Line (dBuV/m)	Over Limit (dB)	Polarization	Test value
1185.96	53.52	26.19	4.63	36.58	47.76	74.00	-26.24	Vertical	Peak
3963.52	39.29	29.70	8.73	38.13	39.59	74.00	-34.41	Vertical	Peak
4883.52	44.24	31.43	9.59	36.73	48.53	74.00	-25.47	Vertical	Peak
8549.59	33.26	37.10	12.88	34.45	48.79	74.00	-25.21	Vertical	Peak
1346.93	39.38	26.06	4.91	36.49	33.86	74.00	-40.14	Horizontal	Peak
2768.24	39.07	28.10	7.30	38.28	36.19	74.00	-37.81	Horizontal	Peak
4883.52	38.77	31.43	9.59	36.73	43.06	74.00	-30.94	Horizontal	Peak
7527.83	32.01	36.13	12.49	34.92	45.71	74.00	-28.29	Horizontal	Peak

CH78									
Frequency (MHz)	Read Level (dBuV)	Antenna Factor (dB/m)	Cable Loss (dB)	Preamp Factor (dB)	Level (dBuV/m)	Limit Line (dBuV/m)	Over Limit (dB)	Polarization	Test value
1491.30	50.30	25.81	5.26	36.58	44.79	74.00	-29.21	Vertical	Peak
2980.33	44.03	28.58	7.47	38.24	41.84	74.00	-32.16	Vertical	Peak
4958.68	48.09	31.46	9.64	36.52	52.67	74.00	-21.33	Vertical	Peak
7663.17	33.15	36.14	12.89	35.01	47.17	74.00	-26.83	Vertical	Peak
4958.68	34.94	31.46	9.64	36.52	39.52	54.00	-14.48	Vertical	Average
1746.25	52.03	25.29	5.86	37.03	46.15	74.00	-27.85	Horizontal	Peak
2775.30	45.06	28.10	7.31	38.30	42.17	74.00	-31.83	Horizontal	Peak
4958.68	50.33	31.46	9.64	36.52	54.91	74.00	-19.09	Horizontal	Peak
7741.59	34.09	36.10	13.10	35.04	48.25	74.00	-25.75	Horizontal	Peak
4958.68	34.72	31.46	9.64	36.52	39.30	54.00	-14.70	Horizontal	Average

Remark:

1. Final Level = Receiver Read level + Antenna Factor + Cable Loss – Preamplifier Factor
2. The peak level is lower than average limit(54 dBuV/m), this data is the too weak instrument of signal is unable to test.
3. The emission levels of other frequencies(test frequency band is 1GHz to 25GHz) are very lower than the limit and not show in test report.

6. TEST SETUP PHOTOS

Conducted Emissions



Radiated Emissions



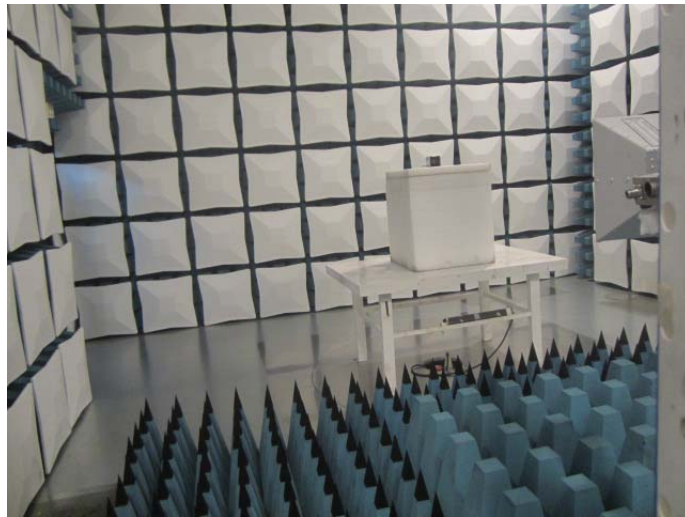

7. EXTERANAL AND INTERNAL PHOTOS

Reference to the test report No.: TRE1710010201.

.....**End of Report**.....