



TEST REPORT

Report Reference No...... : **TRE1608017402** R/C.....:66077

FCC ID..... : **2AK4CPP211NV5L**

Applicant's name..... : **Petcube, Inc.**

Address..... : 2711 Centerville Road, Suite 400, Wilmington, Delaware 19808, USA

Manufacturer..... : Shenzhen Ditai Precision Electronic Co., LTD

Address..... : 2/F, C block, No.18, Baihuayuan Rd, Guangming New District, Shenzhen city, China

Test item description : **Petcube Play**

Trade Mark : Petcube

Model/Type reference..... : PP211NV5L

Listed Model(s) : -

Standard : **FCC CFR Title 47 Part 15 Subpart C Section 15.247**

Date of receipt of test sample..... : Aug. 25, 2016

Date of testing..... : Aug. 26, 2016 - Sept.18, 2016

Date of issue..... : Sept. 19, 2016

Result..... : **PASS**

Compiled by
(position+printedname+signature).... : File administrators Candy Liu

Candy Liu

Supervised by
(position+printedname+signature)..... : Project Engineer Jeff Sun

Jeff Sun

Approved by
(position+printedname+signature)..... : RF Manager Hans Hu

Hans Hu

Testing Laboratory Name : **Shenzhen Huatongwei International Inspection Co., Ltd.**

Address..... : 1/F, Bldg 3, Hongfa Hi-tech Industrial Park, Genyu Road, Tianliao, Gongming, Shenzhen, China

Shenzhen Huatongwei International Inspection Co., Ltd. All rights reserved.

This publication may be reproduced in whole or in part for non-commercial purposes as long as the Shenzhen Huatongwei International Inspection Co., Ltd. is acknowledged as copyright owner and source of the material. Shenzhen Huatongwei International Inspection Co., Ltd. takes no responsibility for and will not assume liability for damages resulting from the reader's interpretation of the reproduced material due to its placement and context.

Contents

1.	<u>TEST STANDARDS AND TEST DESCRIPTION</u>	3
1.1.	Test Standards	3
1.2.	Report version	3
2.	<u>TEST DESCRIPTION</u>	4
3.	<u>SUMMARY</u>	5
3.1.	Client Information	5
3.2.	Product Description	5
3.3.	Operation state	6
3.4.	EUT configuration	6
3.5.	Modifications	6
4.	<u>TEST ENVIRONMENT</u>	7
4.1.	Address of the test laboratory	7
4.2.	Test Facility	7
4.3.	Environmental conditions	8
4.4.	Statement of the measurement uncertainty	8
4.5.	Equipments Used during the Test	9
5.	<u>TEST CONDITIONS AND RESULTS</u>	10
5.1.	Antenna requirement	10
5.2.	Conducted Emission (AC Main)	11
5.3.	Conducted Peak Output Power	14
5.4.	20dB Emission Bandwidth	17
5.5.	Carrier Frequencies Separation	20
5.6.	Hopping Channel Number	22
5.7.	Dwell Time	24
5.8.	Pseudorandom Frequency Hopping Sequence	27
5.9.	Restricted band (radiated)	28
5.10.	Bandedge and Spurious Emission (conducted)	30
5.11.	Spurious Emission (radiated)	34
6.	<u>TEST SETUP PHOTOS OF THE EUT</u>	40
7.	<u>EXTERNAL AND INTERNAL PHOTOS OF THE EUT</u>	41

1. TEST STANDARDS AND TEST DESCRIPTION

1.1. Test Standards

The tests were performed according to following standards:

[FCC Rules Part 15.247](#): Frequency Hopping, Direct Spread Spectrum and Hybrid Systems that are in operation within the bands of 902-928 MHz, 2400-2483.5 MHz, and 5725-5850 MHz.

[ANSI C63.10-2013](#): American National Standard for Testing Unlicensed Wireless Devices

1.2. Report version

Version No.	Date of issue	Description
00	September 19, 2016	Original

2. TEST DESCRIPTION

Test Item	Section in CFR 47	Result
Antenna Requirement	15.203/15.247 (c)	Pass
AC Power Line Conducted Emission	15.207	Pass
Conducted Peak Output Power	15.247 (b)(1)	Pass
20dB Occupied Bandwidth	15.247 (a)(1)	Pass
Carrier Frequencies Separation	15.247 (a)(1)	Pass
Hopping Channel Number	15.247 (a)(1)	Pass
Dwell Time	15.247 (a)(1)	Pass
Pseudorandom Frequency Hopping Sequence	15.247(b)(4)&TCB Exclusion List (7 July 2002)	Pass
Restricted band	15.247(d)/15.205	Pass
Radiated Emission	15.247(d)/15.209	Pass

Note: The measurement uncertainty is not included in the test result.

3. SUMMARY

3.1. Client Information

Applicant:	Petcube, Inc.
Address:	2711 Centerville Road, Suite 400, Wilmington, Delaware 19808, USA
Manufacturer:	Shenzhen Ditai Precision Electronic Co., LTD
Address:	2/F, C block, No.18, Baihuayuan Rd, Guangming New District, Shenzhen city, China

3.2. Product Description

Name of EUT	Petcube Play
Trade Mark:	Petcube
Model No.:	PP211NV5L
Listed Model(s):	-
Power supply:	DC 5V/2A
Adapter information:	-
Bluetooth	
Version:	Supported BT4.0+EDRcompatibility
Modulation:	GFSK, $\pi/4$ DQPSK, 8DPSK
Operation frequency:	2402MHz~2480MHz
Channel number:	79
Channel separation:	1MHz
Antenna type:	Internal Antenna
Antenna gain:	2.41dBi

3.3. Operation state

➤ Test frequency list

According to section 15.31(m), regards to the operating frequency range over 10 MHz, must select three channel which were tested. the Lowest frequency, the middle frequency, and the highest frequency of channel were selected to perform the test, please see the above gray bottom.

Channel	Frequency (MHz)
0	2402
1	2403
:	:
39	2441
:	:
77	2479
78	2480

➤ Test mode

For RF test items
The engineering test program was provided and enabled to make EUT continuous transmit/receive.
For AC power line conducted emissions:
the EUT was set to connect with the Bluetooth under large package sizes transmission.
For RF test axis
EUT in each of three orthogonal axis emissions had been tested ,but only the worst case (X axis) data Recorded in the report.

3.4. EUT configuration

The following peripheral devices and interface cables were connected during the measurement:

- - supplied by the manufacturer
- - supplied by the lab

<input type="radio"/>	PowerCable	Length (m) :	/
		Shield :	/
		Detachable :	/
<input type="radio"/>	Multimeter	Manufacturer :	/
		Model No. :	/

3.5. Modifications

No modifications were implemented to meet testing criteria.

4. Test Environment

4.1. Address of the test laboratory

Laboratory: Shenzhen Huatongwei International Inspection Co., Ltd.

Address: 1/F, Bldg 3, Hongfa Hi-tech Industrial Park, Genyu Road, Tianliao, Gongming, Shenzhen, China

Phone: 86-755-26748019 Fax: 86-755-26748089

4.2. Test Facility

The test facility is recognized, certified, or accredited by the following organizations:

CNAS-Lab Code: L1225

Shenzhen Huatongwei International Inspection Co., Ltd. has been assessed and proved to be in compliance with CNAS-CL01 Accreditation Criteria for Testing and Calibration Laboratories

(identical to ISO/IEC17025: 2005 General Requirements) for the Competence of Testing and Calibration Laboratories, Date of Registration: February 28, 2015. Valid time is until February 27, 2018.

A2LA-Lab Cert. No. 3902.01

Shenzhen Huatongwei International Inspection Co., Ltd. EMC Laboratory has been accredited by A2LA for technical competence in the field of electrical testing, and proved to be in compliance with ISO/IEC 17025: 2005 General Requirements for the Competence of Testing and Calibration Laboratories and any additional program requirements in the identified field of testing. Valid time is until December 31, 2016.

FCC-Registration No.: 317478

Shenzhen Huatongwei International Inspection Co., Ltd. EMC Laboratory has been registered and fully described in a report filed with the FCC (Federal Communications Commission). The acceptance letter from the FCC is maintained in our files. Registration 317478, Renewal date Jul. 18, 2014, valid time is until Jul. 18, 2017.

IC-Registration No.: 5377A&5377B

The 3m Alternate Test Site of Shenzhen Huatongwei International Inspection Co., Ltd. has been registered by Certification and Engineering Bureau of Industry Canada for the performance of radiated measurements with Registration No. 5377A on Dec. 31, 2013, valid time is until Dec. 31, 2016.

Two 3m Alternate Test Site of Shenzhen Huatongwei International Inspection Co., Ltd. has been registered by Certification and Engineering Bureau of Industry Canada for the performance of radiated measurements with Registration No. 5377B on Dec.03, 2014, valid time is until Dec.03, 2017.

ACA

Shenzhen Huatongwei International Inspection Co., Ltd. EMC Laboratory can also perform testing for the Australian C-Tick mark as a result of our A2LA accreditation.

4.3. Environmental conditions

During the measurement the environmental conditions were within the listed ranges:

Temperature:	15~35°C
Relative Humidity:	30~60 %
Air Pressure:	950~1050mbar

4.4. Statement of the measurement uncertainty

The data and results referenced in this document are true and accurate. The reader is cautioned that there may be errors within the calibration limits of the equipment and facilities. The measurement uncertainty was calculated for all measurements listed in this test report according to TR-100028-01 "Electromagnetic compatibility and Radio spectrum Matters (ERM); Uncertainties in the measurement of mobile radio equipment characteristics; Part 1" and TR-100028-02 "Electromagnetic compatibility and Radio spectrum Matters (ERM); Uncertainties in the measurement of mobile radio equipment characteristics; Part 2" and is documented in the Shenzhen Huatongwei International Inspection Co., Ltd quality system according to DIN EN ISO/IEC 17025. Furthermore, component and process variability of devices similar to that tested may result in additional deviation. The manufacturer has the sole responsibility of continued compliance of the device.

Hereafter the best measurement capability for Shenzhen Huatongwei laboratory is reported:

Test Items	Measurement Uncertainty	Notes
Transmitter power conducted	0.57 dB	(1)
Transmitter power Radiated	2.20 dB	(1)
Conducted spurious emission 9KHz-40 GHz	1.60 dB	(1)
Radiated spurious emission 9KHz-40 GHz	2.20 dB	(1)
Conducted Emission 9KHz-30MHz	3.39 dB	(1)
Radiated Emission 30~1000MHz	4.24 dB	(1)
Radiated Emission 1~18GHz	5.16 dB	(1)
Radiated Emission 18-40GHz	5.54 dB	(1)
Occupied Bandwidth	-----	(1)

(1) This uncertainty represents an expanded uncertainty expressed at approximately the 95% confidence level using a coverage factor of $k=1.96$.

4.5. Equipments Used during the Test

Line Conducted Emission (AC Main)					
Item	Test Equipment	Manufacturer	Model No.	Serial No.	Last Cal.
1	EMI Test Receiver	R&S	ESCI	101247	2015/11/03
2	Artificial Mains	Shwarzbeck	NNLK 8121	573	2015/11/03
3	Pulse Limiter	R&S	ESH3-Z2	101488	2015/11/03
4	Test Software	R&S	ES-K1	N/A	N/A

Maximum Peak Output Power / Power Spectral Density / 6dB Bandwidth / Band Edge Compliance of RF Emission / Spurious RF Conducted Emission					
Item	Test Equipment	Manufacturer	Model No.	Serial No.	Last Cal
1	Spectrum Analyzer	Rohde&Schwarz	FSP	1164.4391.40	2015/11/02
2	Power Meter	Anritsu	ML2480B	100798	2015/11/02
3	Power Sensor	Anritsu	MA2411B	100258	2015/11/02
4	Test cable	/	/	/	/
5	Temporary antenna connector	/	/	/	/

NOTE: The temporary antenna connector is soldered on the PCB board in order to perform conducted tests and this temporary antenna connector is listed in the equipment list.

Radiated Emission					
Item	Test Equipment	Manufacturer	Model No.	Serial No.	Last Cal.
1	EMI Test Receiver	Rohde&Schwarz	ESI 26	100009	2015/11/02
2	RF Test Panel	Rohde&Schwarz	TS / RSP	335015/0017	N/A
3	EMI Test Software	Rohde&Schwarz	ESK1	N/A	N/A
4	Loop Antenna	Rohde&Schwarz	HZ-9	838622\013	2015/11/08
5	Ultra-Broadband Antenna	ShwarzBeck	VULB9163	538	2015/11/08
6	Horn Antenna	ShwarzBeck	9120D	1011	2015/11/08
7	Broadband Horn Antenna	Shwarzbeck	BBHA9170	BBHA917047 2	2015/11/08
8	Preamplifier	Shwarzbeck	BBV9742	9742-196	2015/11/02
9	Broadband Preamplifier	Shwarzbeck	BBV 9721	9721-102	2015/11/02
10	Broadband Preamplifier	Shwarzbeck	BBV 9718	9718-247	2015/11/02
11	Turn Table	MATURO	TT2.0	/	N/A
12	Antenna Mast	MATURO	TAM-4.0-P	/	N/A
13	EMI Test Software	Audix	E3	N/A	N/A
14	Test Software	R&S	ES-K1	N/A	N/A
15	Test cable	Siva Cables Italy	RG 58A/U	W14.02	2015/12/05

The Cal.Interval was one year

5. TEST CONDITIONS AND RESULTS

5.1. Antenna requirement

Requirement

FCC CFR Title 47 Part 15 Subpart C Section 15.203:

An intentional radiator shall be designed to ensure that no antenna other than that furnished by the responsible party shall be used with the device. The use of a permanently attached antenna or of an antenna that uses a unique coupling to the intentional radiator, the manufacturer may design the unit so that a broken antenna can be replaced by the user, but the use of a standard antenna jack or electrical connector is prohibited.

FCC CFR Title 47 Part 15 Subpart C Section 15.247(c) (1)(i):

(i) Systems operating in the 2400-2483.5 MHz band that is used exclusively for fixed. Point-to-point operations may employ transmitting antennas with directional gain greater than 6dBi provided the maximum conducted output power of the intentional radiator is reduced by 1 dB for every 3 dB that the directional gain of the antenna exceeds 6dBi.

TEST RESULTS

Passed **Not Applicable**

The antenna is integral antenna, the best case gain of the antenna is 2.41dBi, please refer to the below antenna photo.



5.2. Conducted Emission (AC Main)

LIMIT

FCC CFR Title 47 Part 15 Subpart C Section 15.207:

Frequency range (MHz)	Limit (dBuV)	
	Quasi-peak	Average
0.15-0.5	66 to 56*	56 to 46*
0.5-5	56	46
5-30	60	50

* Decreases with the logarithm of the frequency.

TEST CONFIGURATION

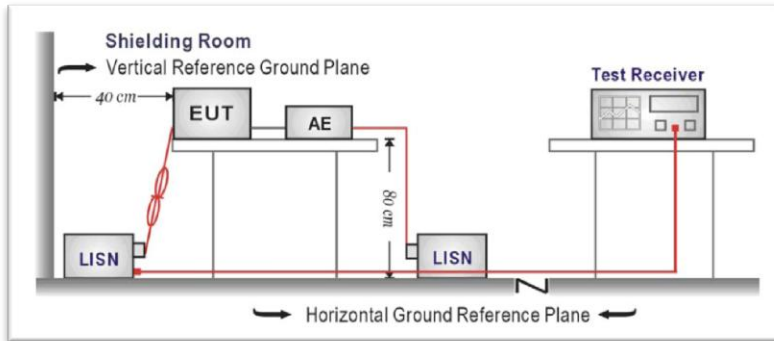

TEST PROCEDURE

1. The EUT was setup according to ANSI C63.10:2013 for compliance to FCC 47CFR 15.247 requirements.
2. The EUT was placed on a platform of nominal size, 1 m by 1.5 m, raised 80 cm above the conducting ground plane. The vertical conducting plane was located 40 cm to the rear of the EUT. All other surfaces of EUT were at least 80 cm from any other grounded conducting surface.
3. The EUT and simulators are connected to the main power through a line impedance stabilization network (LISN). The LISN provides a 50 ohm /50uH coupling impedance for the measuring equipment.
4. The peripheral devices are also connected to the main power through a LISN. (Please refer to the block diagram of the test setup and photographs)
5. Each current-carrying conductor of the EUT power cord, except the ground (safety) conductor, was individually connected through a LISN to the input power source.
6. The excess length of the power cord between the EUT and the LISN receptacle were folded back and forth at the center of the lead to form a bundle not exceeding 40 cm in length.
7. Conducted emissions were investigated over the frequency range from 0.15MHz to 30MHz using a receiver bandwidth of 9 kHz.
8. During the above scans, the emissions were maximized by cable manipulation.

TEST MODE:

Please refer to the clause 3.3

TEST RESULTS

Passed Not Applicable

Note:

- 1) Transd=Cable lose+Pulse Limiter Factor + Artificial Mains Factor
- 2) Margin= Limit -Level

Test Line:

L

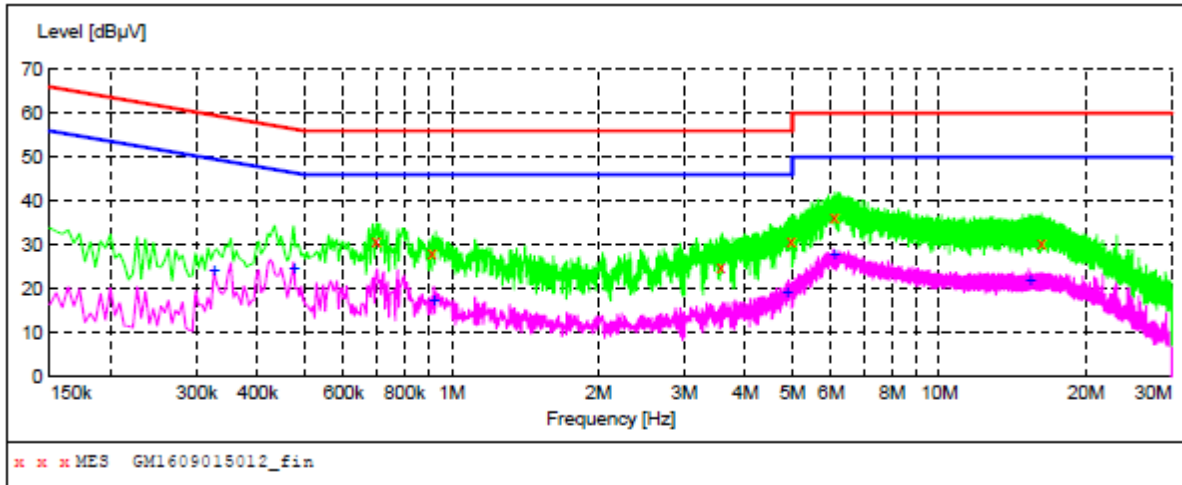

Frequency MHz	Level dBµV	Transd dB	Limit dBµV	Margin dB	Detector	Line	PE
0.699000	30.80	10.2	56	25.2	QP	L1	GND
0.910500	28.00	10.2	56	28.0	QP	L1	GND
3.565500	25.10	10.4	56	30.9	QP	L1	GND
4.960500	31.00	10.5	56	25.0	QP	L1	GND
6.081000	36.40	10.5	60	23.6	QP	L1	GND
16.206000	30.50	10.7	60	29.5	QP	L1	GND

Frequency MHz	Level dBµV	Transd dB	Limit dBµV	Margin dB	Detector	Line	PE
0.325500	24.20	10.2	50	25.4	AV	L1	GND
0.474000	24.60	10.2	46	21.8	AV	L1	GND
0.919500	17.50	10.2	46	28.5	AV	L1	GND
4.875000	19.20	10.5	46	26.8	AV	L1	GND
6.085500	27.60	10.5	50	22.4	AV	L1	GND
15.333000	22.00	10.7	50	28.0	AV	L1	GND

Test Line:

N

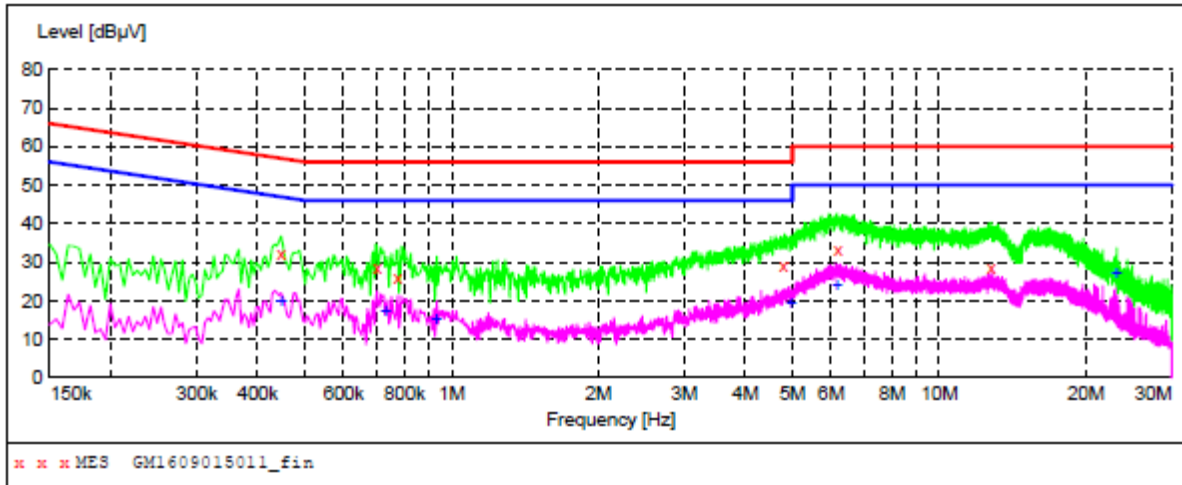

Frequency MHz	Level dBµV	Transd dB	Limit dBµV	Margin dB	Detector	Line	PE
0.447000	32.00	10.2	57	24.9	QP	N	GND
0.703500	28.50	10.2	56	27.5	QP	N	GND
0.775500	26.00	10.2	56	30.0	QP	N	GND
4.798500	29.00	10.5	56	27.0	QP	N	GND
6.202500	33.30	10.5	60	26.7	QP	N	GND
12.808500	28.80	10.7	60	31.2	QP	N	GND

Frequency MHz	Level dBµV	Transd dB	Limit dBµV	Margin dB	Detector	Line	PE
0.447000	19.60	10.2	47	27.3	AV	N	GND
0.730500	17.00	10.2	46	29.0	AV	N	GND
0.928500	15.30	10.3	46	30.7	AV	N	GND
4.969500	19.40	10.5	46	26.6	AV	N	GND
6.162000	23.90	10.5	50	26.1	AV	N	GND
23.131500	27.00	10.8	50	23.0	AV	N	GND

5.3. Conducted Peak Output Power

LIMIT

FCC CFR Title 47 Part 15 Subpart C Section 15.247 (b)(3): **30dBm**

TEST CONFIGURATION

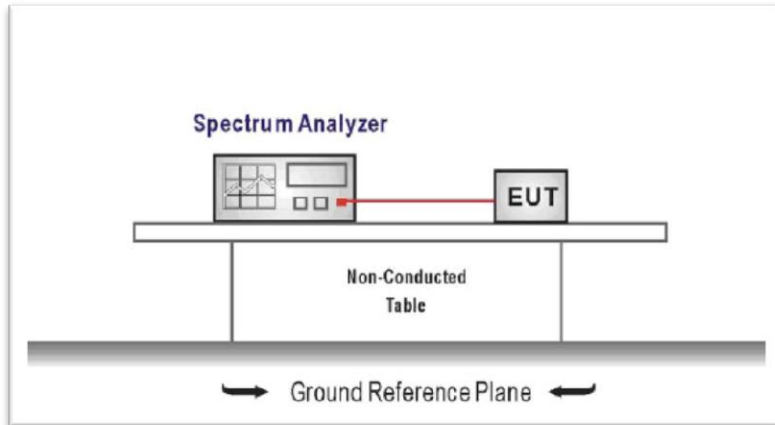

TEST PROCEDURE

1. The transmitter output was connected to the spectrum analyzer through an attenuator, the pathloss was compensated to the results for each measurement.
2. Set to the maximum power setting and enable the EUT transmit continuously
3. Use the following spectrum analyzer settings:
 Span = approximately 5 times the 20 dB bandwidth, centered on a hopping channel
 RBW ≥ the 20 dB bandwidth of the emission being measured, VBW ≥ RBW
 Sweep = auto, Detector function = peak, Trace = max hold
4. Measure and record the results in the test report.

TEST MODE:

Please refer to the clause 3.3

TEST RESULTS

Passed **Not Applicable**

Modulation type	Channel	Output power (dBm)	Limit (dBm)	Result
GFSK	00	-1.55	30.00	Pass
	39	-0.32		
	78	-0.57		
π/4DQPSK	00	-1.39	21.00	Pass
	39	-0.75		
	78	-0.85		
8DPSK	00	-1.44	21.00	Pass
	39	-0.76		
	78	-0.90		

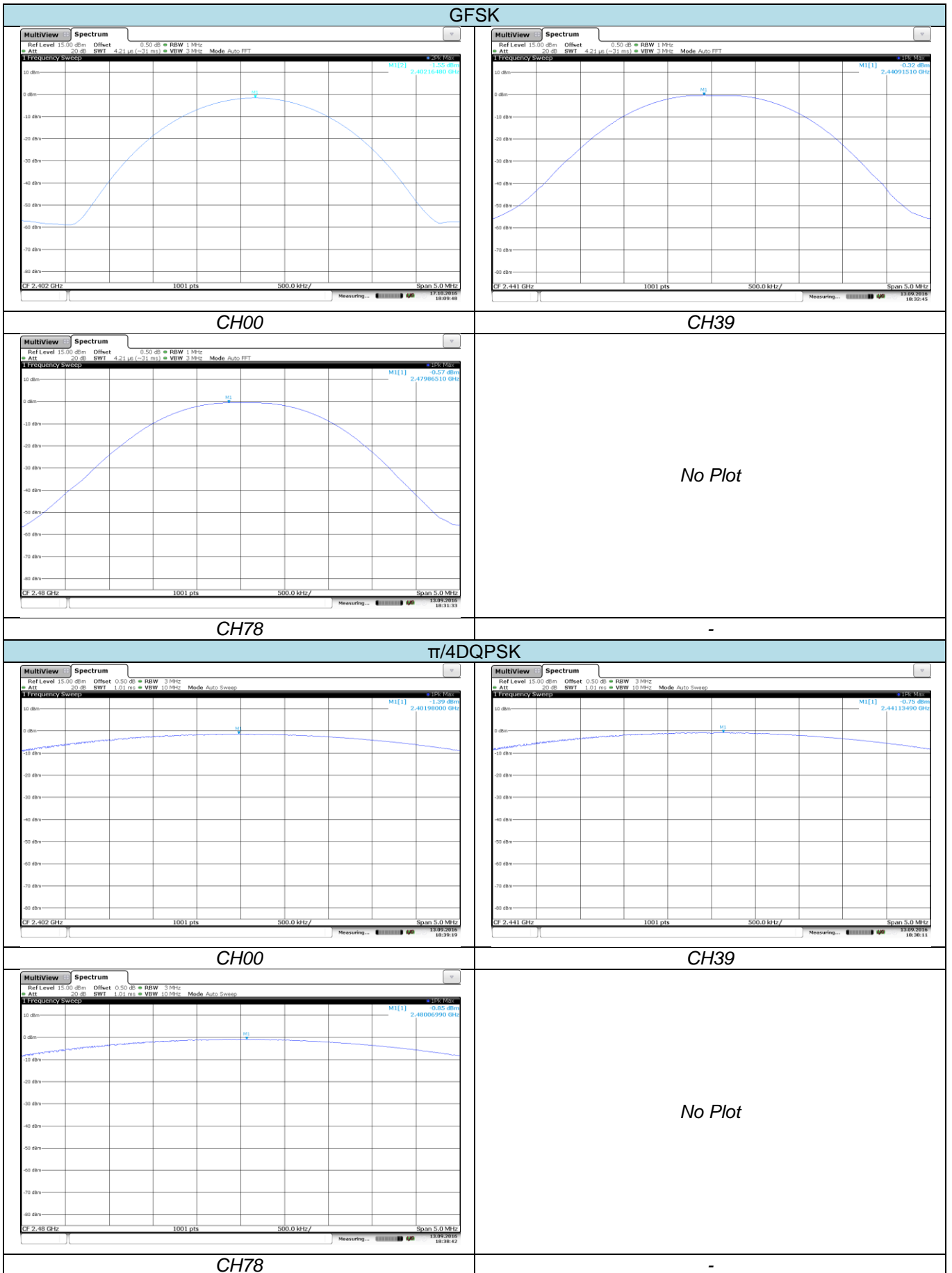

8DPSK

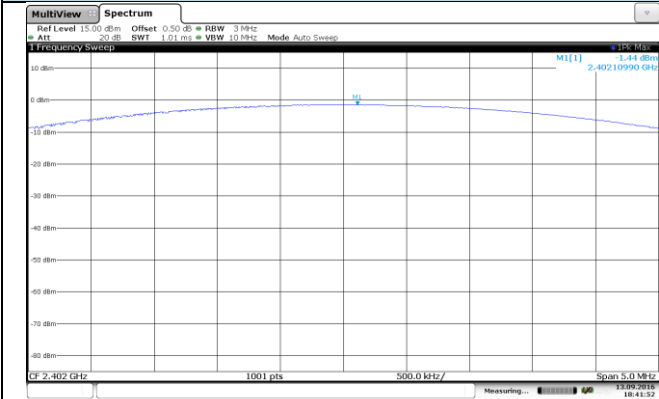

CH00

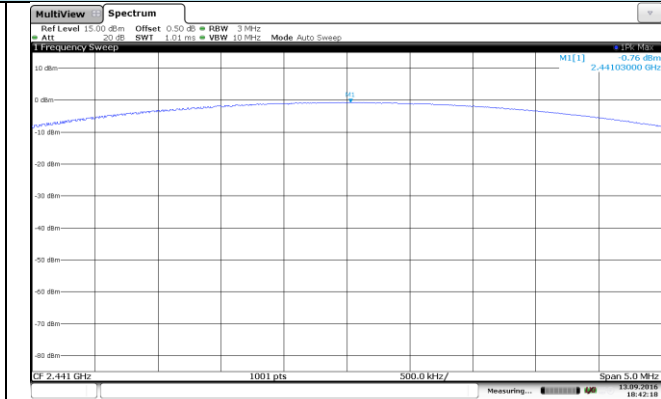

CH39

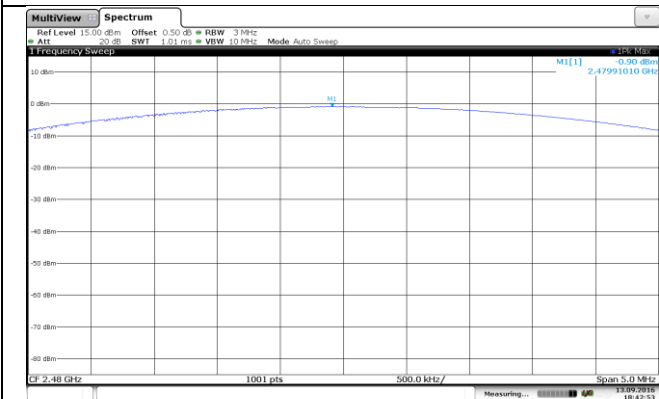

CH78

No Plot

-

5.4. 20dB Emission Bandwidth

LIMIT

N/A

TEST CONFIGURATION

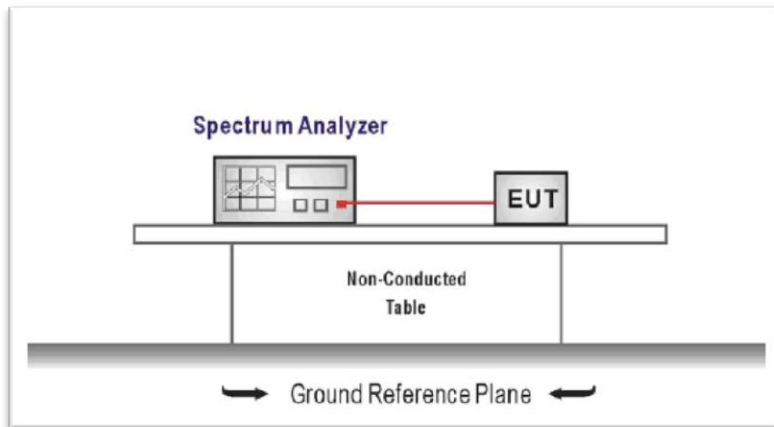

TEST PROCEDURE

1. The transmitter output was connected to the spectrum analyzer through an attenuator, the pathloss was compensated to the results for each measurement.
2. Set to the maximum power setting and enable the EUT transmit continuously
3. Use the following spectrum analyzer settings:
Span = approximately 2 to 3 times the 20 dB bandwidth, centered on a hopping channel
RBW \geq 1% of the 20 dB bandwidth, VBW \geq RBW
Sweep = auto, Detector function = peak, Trace = max hold
4. Measure and record the results in the test report.

TEST MODE:

Please refer to the clause 3.3

TEST RESULTS

 Passed **Not Applicable**

Modulation type	Channel	20dB Bandwidth (MHz)	Limit (MHz)	Result
GFSK	00	0.875	-	Pass
	39	0.876		
	78	0.870		
$\pi/4$ DQPSK	00	1.141	-	Pass
	39	1.138		
	78	1.131		
8DPSK	00	1.146	-	Pass
	39	1.145		
	78	1.147		

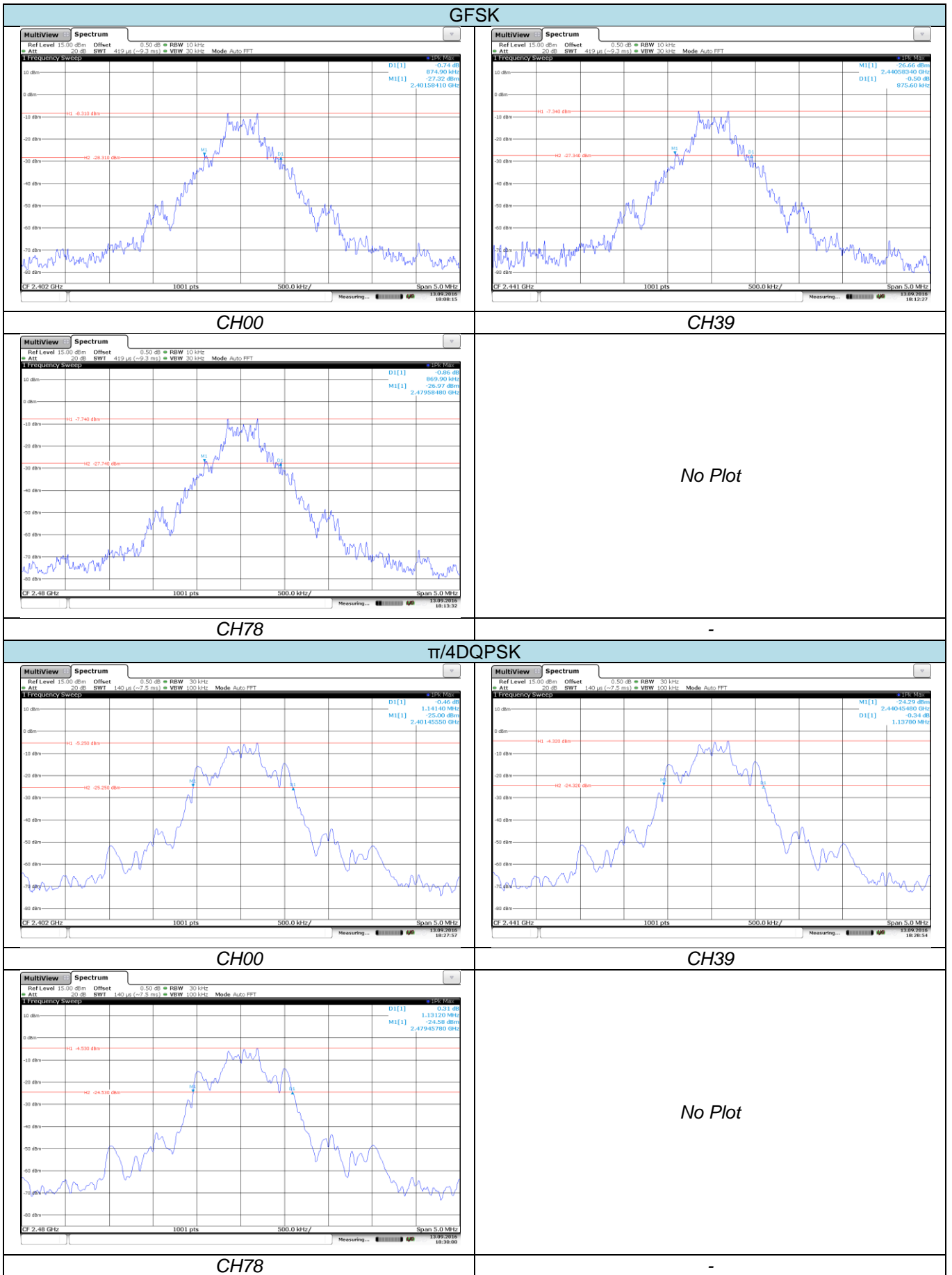

8DPSK

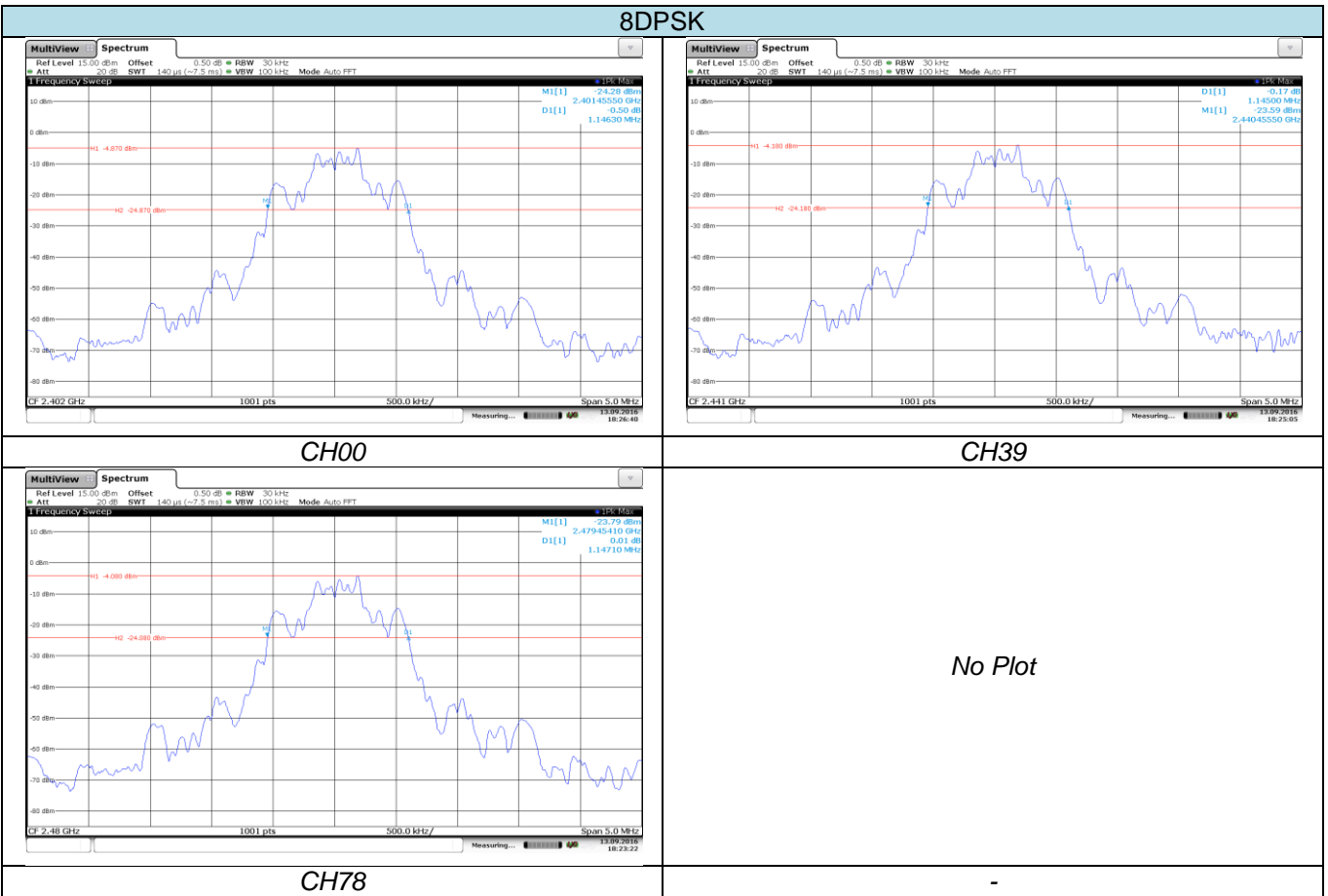

5.5. Carrier Frequencies Separation

LIMIT

FCC CFR Title 47 Part 15 Subpart C Section 15.247 (a)(1):

frequency hopping systems shall have hopping channel carrier frequencies separated by minimum of 25KHz or the $\frac{2}{3} * 20\text{dB}$ bandwidth of the hopping channel, whichever is greater.

TEST CONFIGURATION

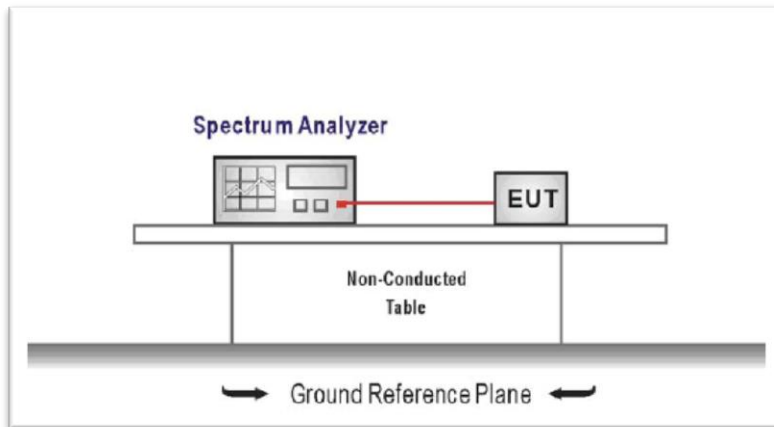

TEST PROCEDURE

1. The transmitter output was connected to the spectrum analyzer through an attenuator, the pathloss was compensated to the results for each measurement.
2. Set to the maximum power setting and enable the EUT transmit continuously
3. Use the following spectrum analyzer settings:
Span = wide enough to capture the peaks of two adjacent channels
RBW $\geq 1\%$ of the span, VBW \geq RBW
Sweep = auto, Detector function = peak, Trace = max hold
4. Measure and record the results in the test report.

TEST MODE:

Please refer to the clause 3.3

TEST RESULTS

Passed Not Applicable

Modulation type	Channel	Carrier Frequencies Separation (MHz)	Limit (MHz)	Result
GFSK	39	0.998	0.875	Pass
$\pi/4$ DQPSK	39	1.001	0.759	Pass
8DPSK	39	0.998	0.765	Pass

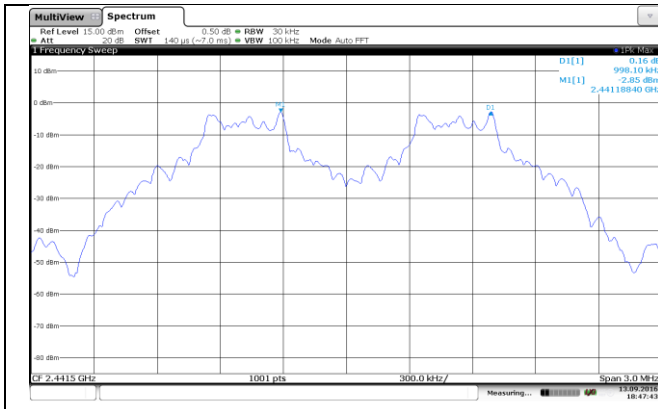

GFSK

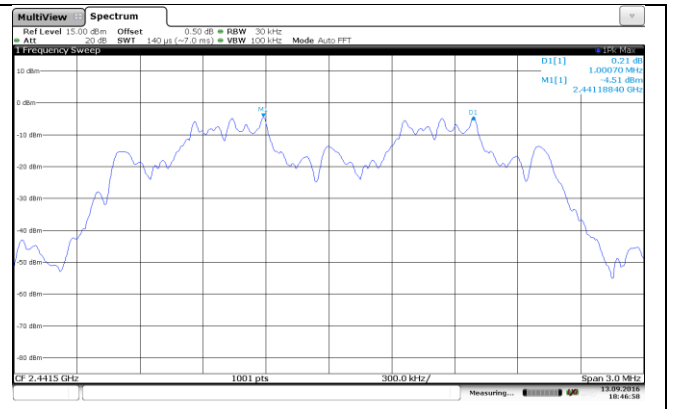

$\pi/4$ DQPSK

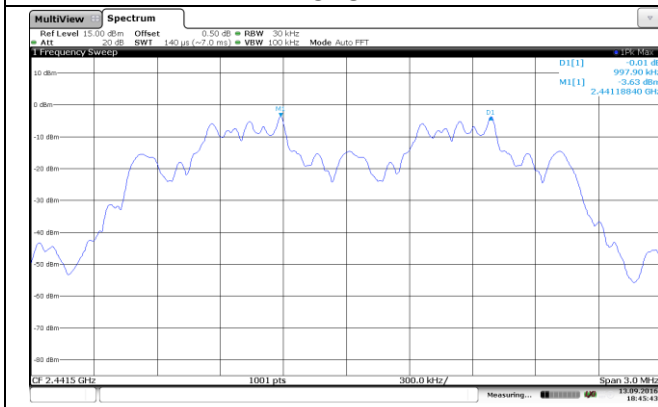

8DPSK

No Plot

5.6. Hopping Channel Number

LIMIT

FCC CFR Title 47 Part 15 Subpart C Section 15.247 (a)(1):

Frequency hopping systems in the 2400–2483.5 MHz band shall use at least **15** channels.

TEST CONFIGURATION

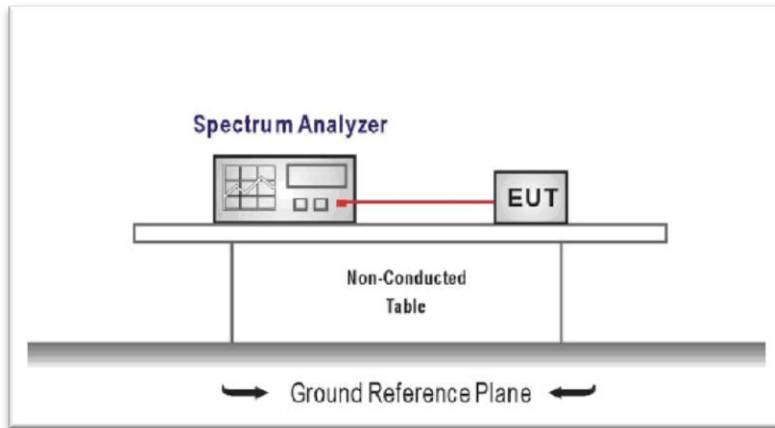

TEST PROCEDURE

1. The transmitter output was connected to the spectrum analyzer through an attenuator, the pathloss was compensated to the results for each measurement.
2. Set to the maximum power setting and enable the EUT transmit continuously
3. Use the following spectrum analyzer settings:
 Span = the frequency band of operation
 RBW \geq 1% of the span, VBW \geq RBW
 Sweep = auto, Detector function = peak, Trace = max hold
4. Measure and record the results in the test report.

TEST MODE:

Please refer to the clause 3.3

TEST RESULTS

Passed **Not Applicable**

Modulation type	Channel number	Limit	Result
GFSK	79	15	Pass
$\pi/4$ DQPSK	79		
8DPSK	79		

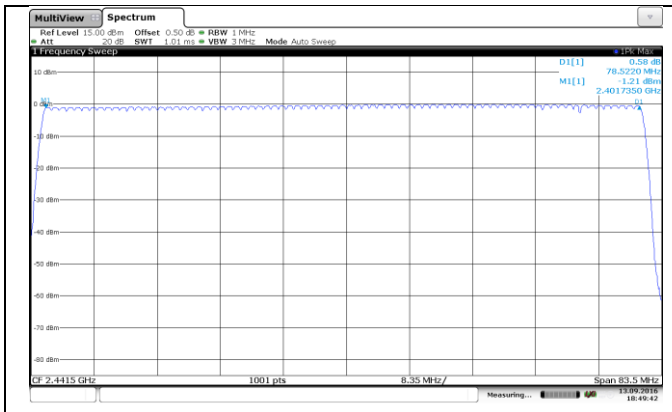

GFSK

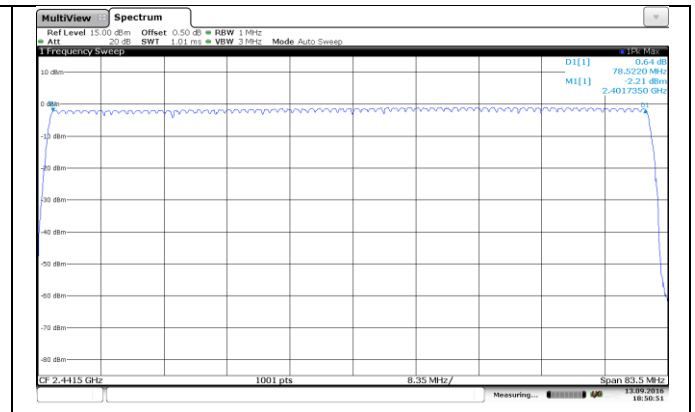

$\pi/4$ DQPSK

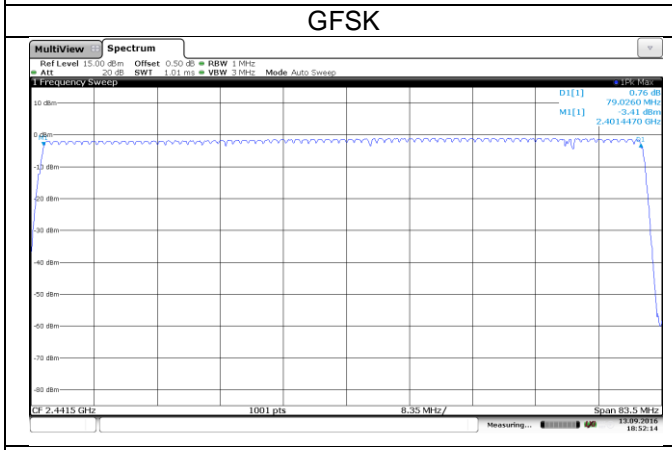

8DPSK

No Plot

5.7. Dwell Time

LIMIT

FCC CFR Title 47 Part 15 Subpart C Section 15.247 (a)(1):

The average time of occupancy on any channel shall not be greater than 0.4 seconds within a pe-riod of 0.4 seconds multiplied by the number of hopping channels employed.

TEST CONFIGURATION

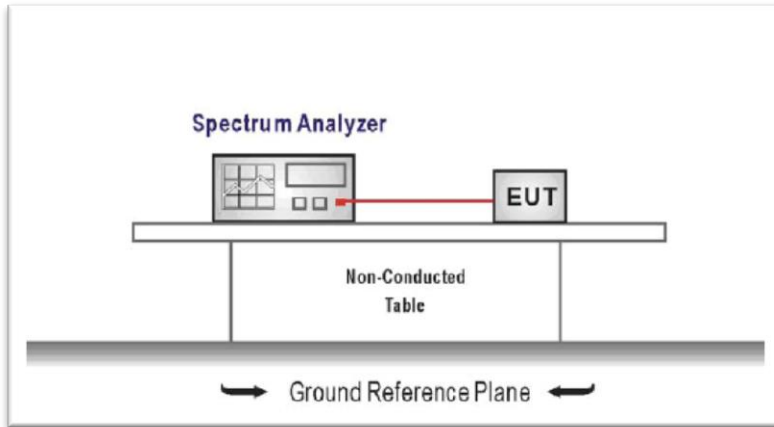

TEST PROCEDURE

1. The transmitter output was connected to the spectrum analyzer through an attenuator, the pathloss was compensated to the results for each measurement.
2. Set to the maximum power setting and enable the EUT transmit continuously
3. Use the following spectrum analyzer settings:
 Span = zero span, centered on a hopping channel, RBW= 1 MHz, VBW≥RBW
 Sweep = as necessary to capture the entire dwell time per hopping channel,
 Detector function = peak, Trace = max hold
4. Measure and record the results in the test report.

TEST MODE:

Please refer to the clause 3.3

TEST RESULTS

Passed Not Applicable

Modulation type	Channel	Dwell time (Second)	Limit (Second)	Result
GFSK	DH1	0.185	0.40	Pass
	DH3	0.294		
	DH5	0.329		
π/4DQPSK	2-DH1	0.188	0.40	Pass
	2-DH3	0.345		
	2-DH5	0.327		
8DPSK	3-DH1	0.182	0.40	Pass
	3-DH3	0.293		
	3-DH5	0.287		

Note:

1. We have tested all mode at high,middle and low channel,and recoreded worst case at middle channel.
2. Dwell time=Pulse time (ms) × (1600 ÷ 2 ÷ 79) ×31.6 Second for DH1, 2-DH1, 3-DH1
 Dwell time=Pulse time (ms) × (1600 ÷ 4 ÷ 79) ×31.6 Second for DH3, 2-DH3, 3-DH3
 Dwell time=Pulse time (ms) × (1600 ÷ 6 ÷ 79) ×31.6 Second for DH5, 2-DH5, 3-DH5

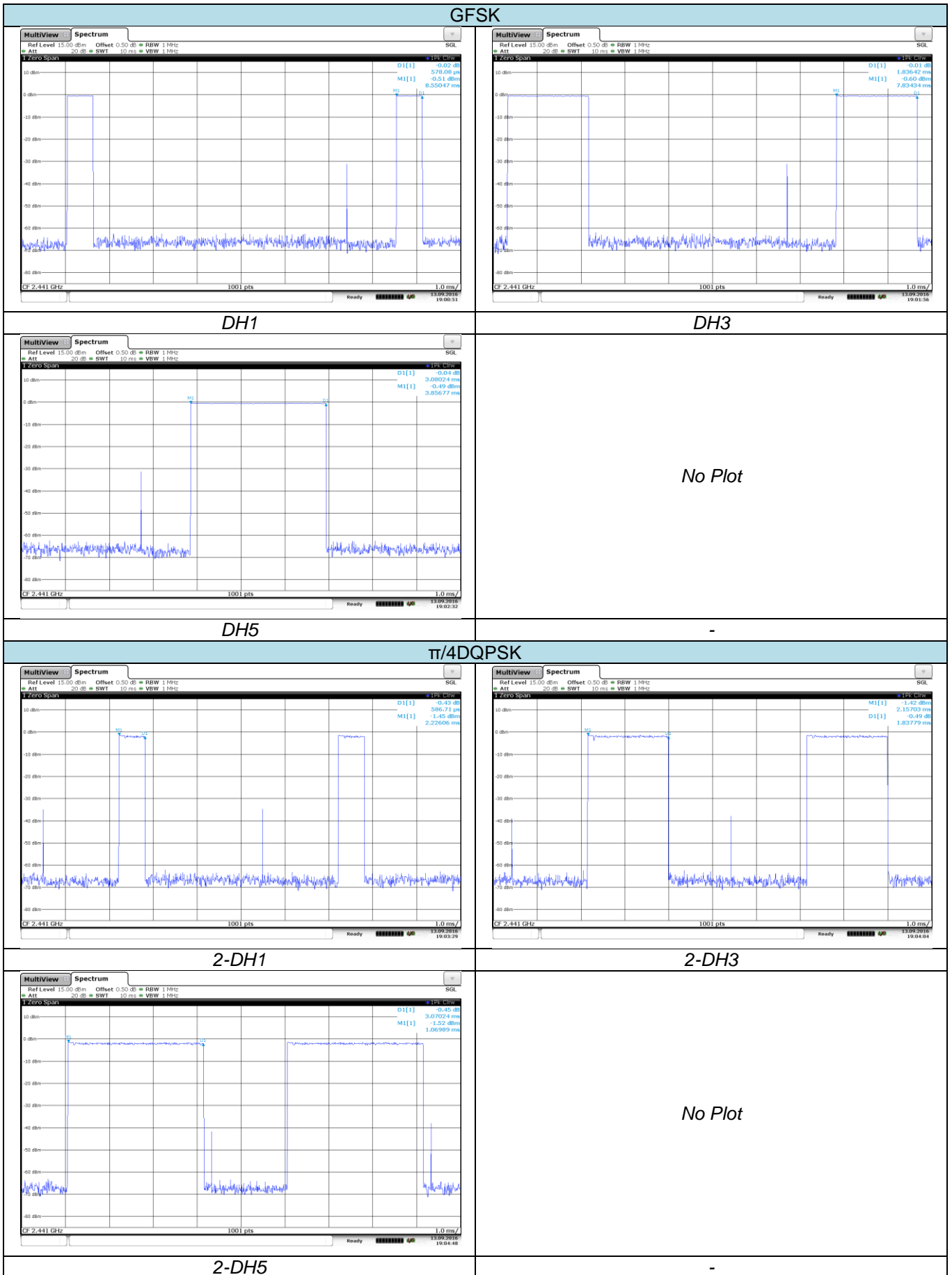

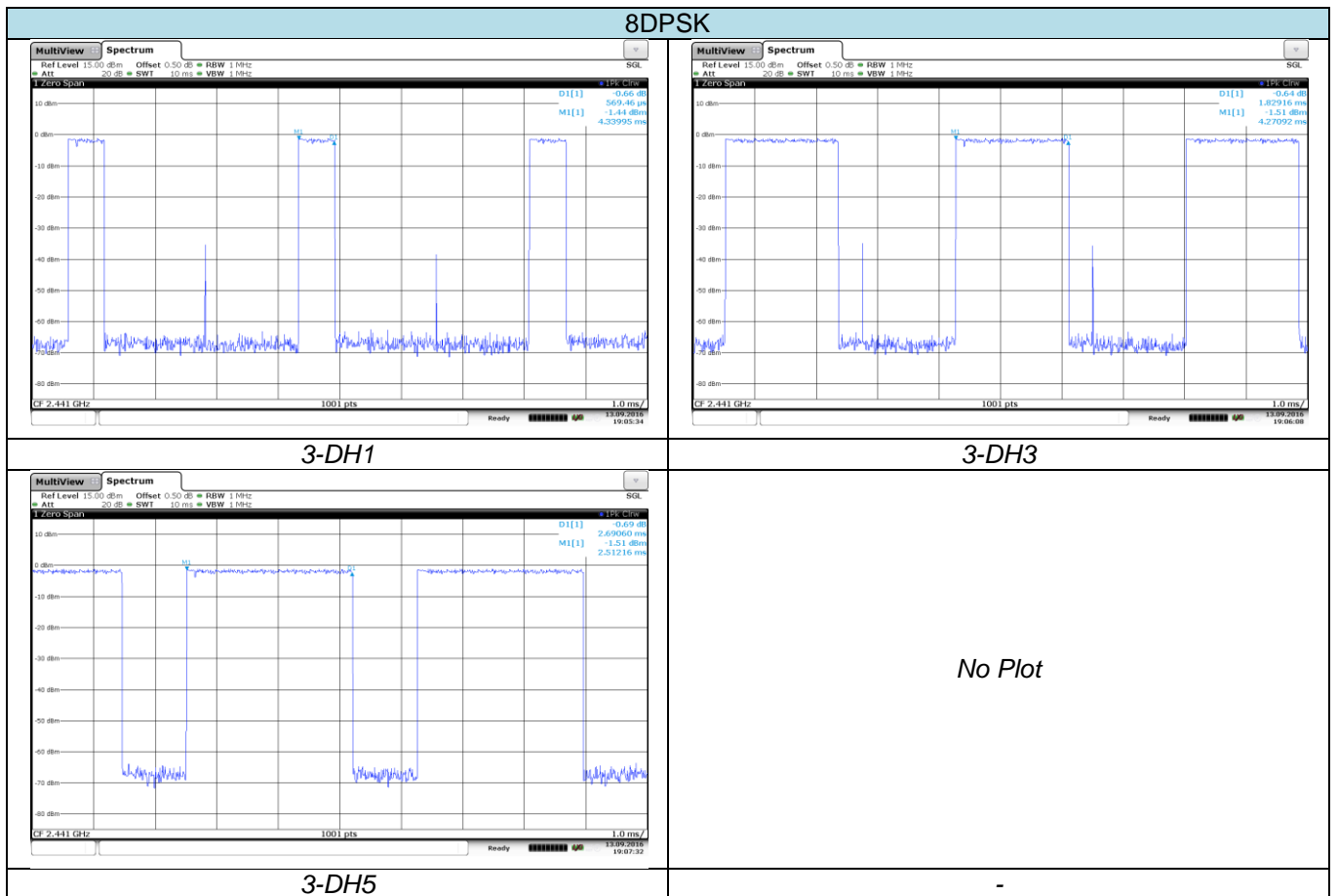

5.8. Pseudorandom Frequency Hopping Sequence

LIMIT

FCC CFR Title 47 Part 15 Subpart C Section 15.247 (a)(1):

Frequency hopping systems shall have hopping channel carrier frequencies separated by a minimum of 25 kHz or the 20 dB bandwidth of the hopping channel, whichever is greater. Alternatively, frequency hopping systems operating in the 2400–2483.5 MHz band may have hopping channel carrier frequencies that are separated by 25 kHz or two-thirds of the 20 dB bandwidth of the hopping channel, whichever is greater, provided the systems operate with an output power no greater than 125 mW. The system shall hop to channel frequencies that are selected at the system hopping rate from a pseudo randomly ordered list of hopping frequencies. Each frequency must be used equally on the average by each transmitter. The system receivers shall have input bandwidths that match the hopping channel bandwidths of their corresponding transmitters and shall shift frequencies in synchronization with the transmitted signals.

TEST RESULTS

The pseudorandom frequency hopping sequence may be generated in a nine-stage shift register whose 5th and 9th stage outputs are added in a modulo-two addition stage. And the result is fed back to the input of the first stage. The sequence begins with the first one of 9 consecutive ones, for example: the shift register is initialized with nine ones.

- Number of shift register stages:9
- Length of pseudo-random sequence:2⁹-1=511 bits
- Longest sequence of zeros:8(non-inverted signal)

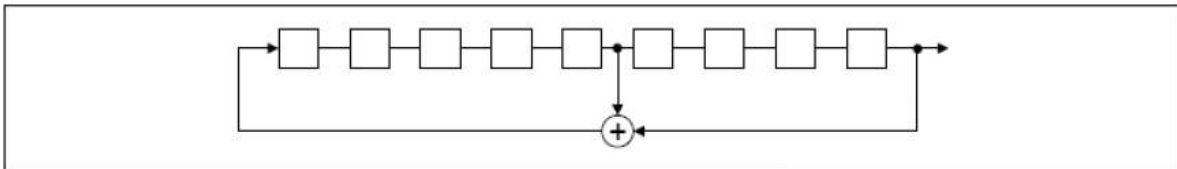

Linear Feedback Shift Register for Generation of the PRBS sequence

An example of pseudorandom frequency hopping sequence as follows:

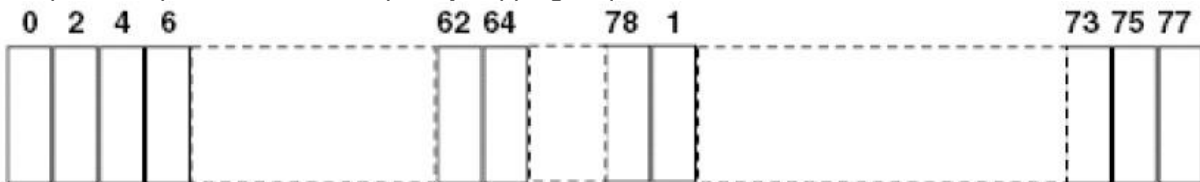

Each frequency used equally on the average by each transmitter. The system receiver has input bandwidths that match the hopping channel bandwidths of their corresponding transmitter and shift frequencies in synchronization with the transmitted signals.

5.9. Restricted band (radiated)

LIMIT

FCC CFR Title 47 Part 15 Subpart C Section 15.247 (d):

In any 100 kHz bandwidth outside the frequency band in which the spread spectrum or digitally modulated intentional radiator is operating, radiated emissions which fall in the restricted bands, as defined in §15.205(a), must also comply with the radiated emission limits specified in §15.209(a) (see §15.205(c)).

TEST CONFIGURATION

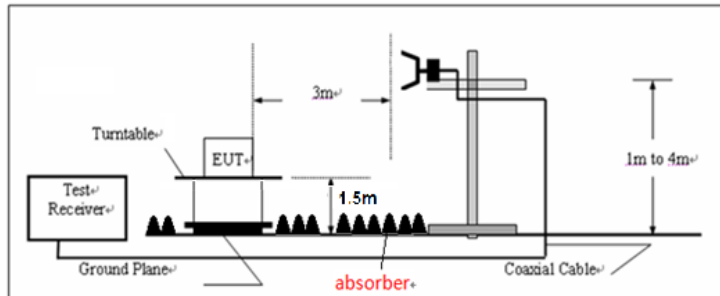

TEST PROCEDURE

1. The EUT was setup and tested according to ANSI C63.10:2013 for compliance to FCC 47CFR 15.247 requirements.
2. The EUT is placed on a turn table which is 1.5 meter above ground. The turn table is rotated 360 degrees to determine the position of the maximum emission level.
3. The EUT was positioned such that the distance from antenna to the EUT was 3 meters.
4. The antenna is scanned from 1 meter to 4 meters to find out the maximum emission level. This is repeated for both horizontal and vertical polarization of the antenna. In order to find the maximum emission, all of the interface cables were manipulated according to ANSI C63.10:2013 on radiated measurement.
5. The receiver set as follow:
 RBW=1MHz, VBW=3MHz for Peak value
 RBW=1MHz, VBW=10Hz for Average value.

TEST MODE:

Please refer to the clause 3.3

TEST RESULTS

Passed **Not Applicable**

Note:

- 1) *Final level = Read level + Antenna Factor + Cable Loss - Preamp Factor*
- 2) *Have pre-scan all modulation mode, found the GFSK modulation which it was worst case, so only the worst case's data on the test report.*

CH00									
Frequency (MHz)	Read Level (dBuV)	Antenna Factor (dB/m)	Cable Loss (dB)	Preamp Factor (dB)	Level (dBuV/m)	Limit Line (dBuV/m)	Margin Limit (dB)	Polarization	Test value
2390.02	50.48	27.53	6.81	37.57	47.25	74.00	-26.75	Vertical	Peak
2390.02	55.11	27.53	6.81	37.57	51.88	74.00	-22.12	Horizontal	
2390.02	27.81	27.53	6.81	37.57	24.58	54.00	-29.42	Vertical	Average
2390.02	27.58	27.53	6.81	37.57	24.35	54.00	-29.65	Horizontal	

CH78									
Frequency (MHz)	Read Level (dBuV)	Antenna Factor (dB/m)	Cable Loss (dB)	Preamp Factor (dB)	Level (dBuV/m)	Limit Line (dBuV/m)	Margin Limit (dB)	Polarization	Test value
2483.51	51.68	27.85	6.96	37.65	48.84	74.00	-25.16	Vertical	Peak
2483.51	55.68	27.85	6.96	37.65	52.84	74.00	-21.16	Horizontal	
2482.97	32.62	27.85	6.96	37.65	29.78	54.00	-24.22	Vertical	Average
2482.36	28.95	27.85	6.96	37.65	26.11	54.00	-27.89	Horizontal	

5.10. Bandedge and Spurious Emission (conducted)

LIMIT

FCC CFR Title 47 Part 15 Subpart C Section 15.247 (d):

In any 100 kHz bandwidth outside the frequency band in which the spread spectrum intentional radiator is operating, the radio frequency power that is produced by the intentional radiator shall be at least 20 dB below that in the 100 kHz bandwidth within the band that contains the highest level of the desired power, based on either an RF conducted or a radiated measurement.

TEST CONFIGURATION

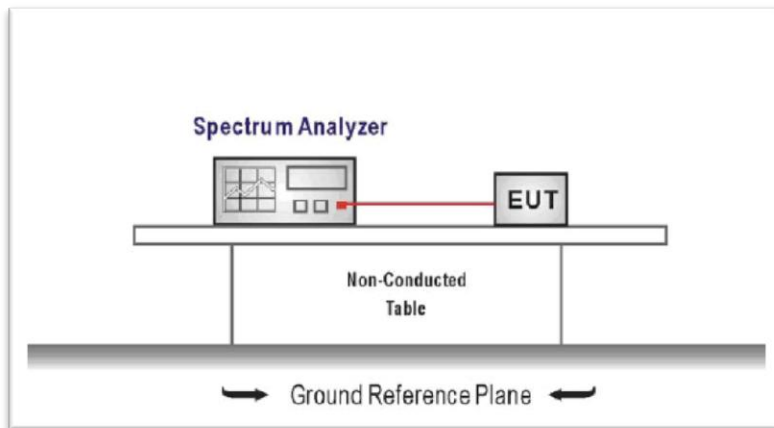

TEST PROCEDURE

1. The transmitter output was connected to the spectrum analyzer through an attenuator, the pathloss was compensated to the results for each measurement.
2. Set to the maximum power setting and enable the EUT transmit continuously
3. Use the following spectrum analyzer settings:
RBW= 100 KHz, VBW \geq RBW
Sweep = auto, Detector function = peak, Trace = max hold
4. Measure and record the results in the test report.

TEST MODE:

Please refer to the clause 3.3

TEST RESULTS

Passed Not Applicable

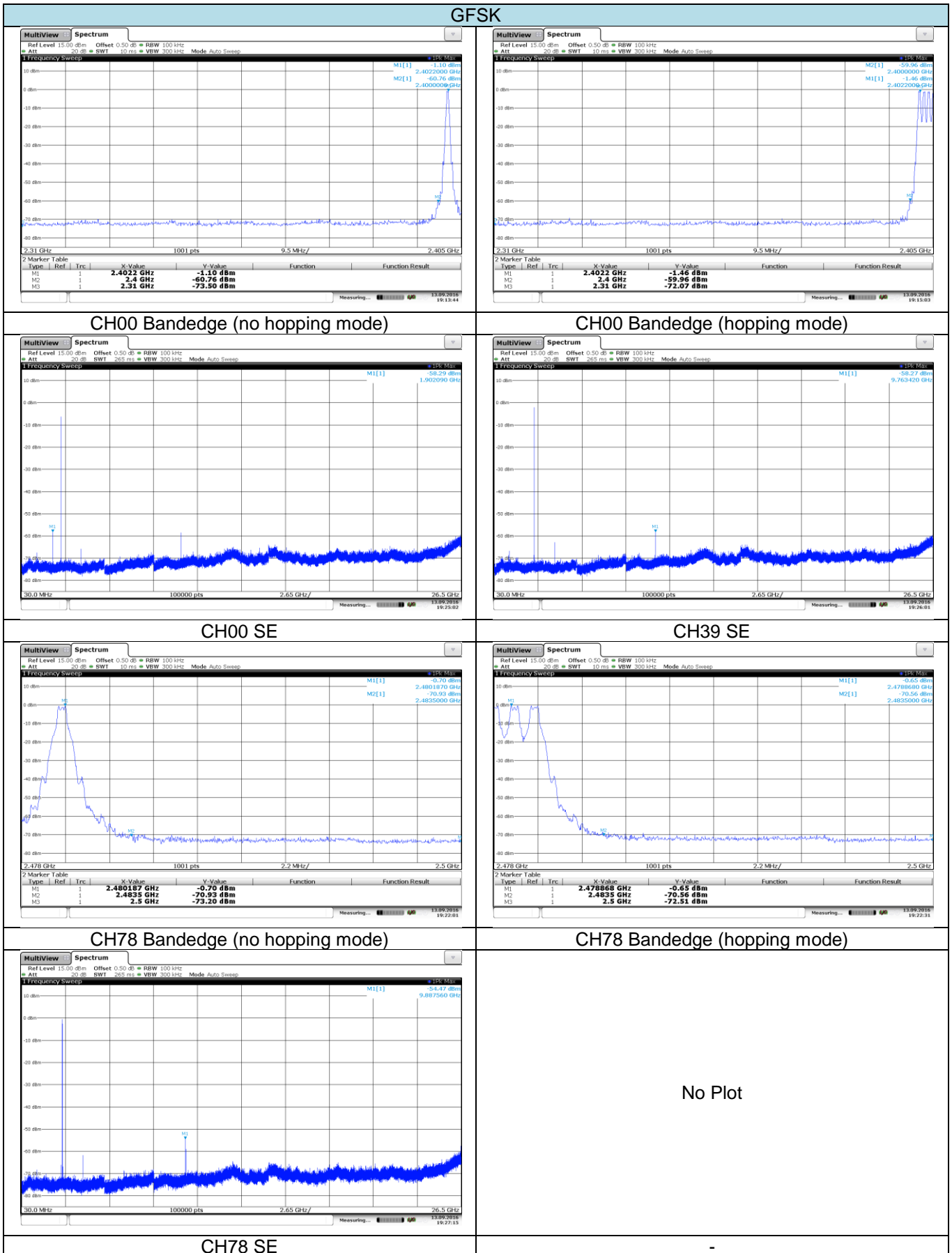

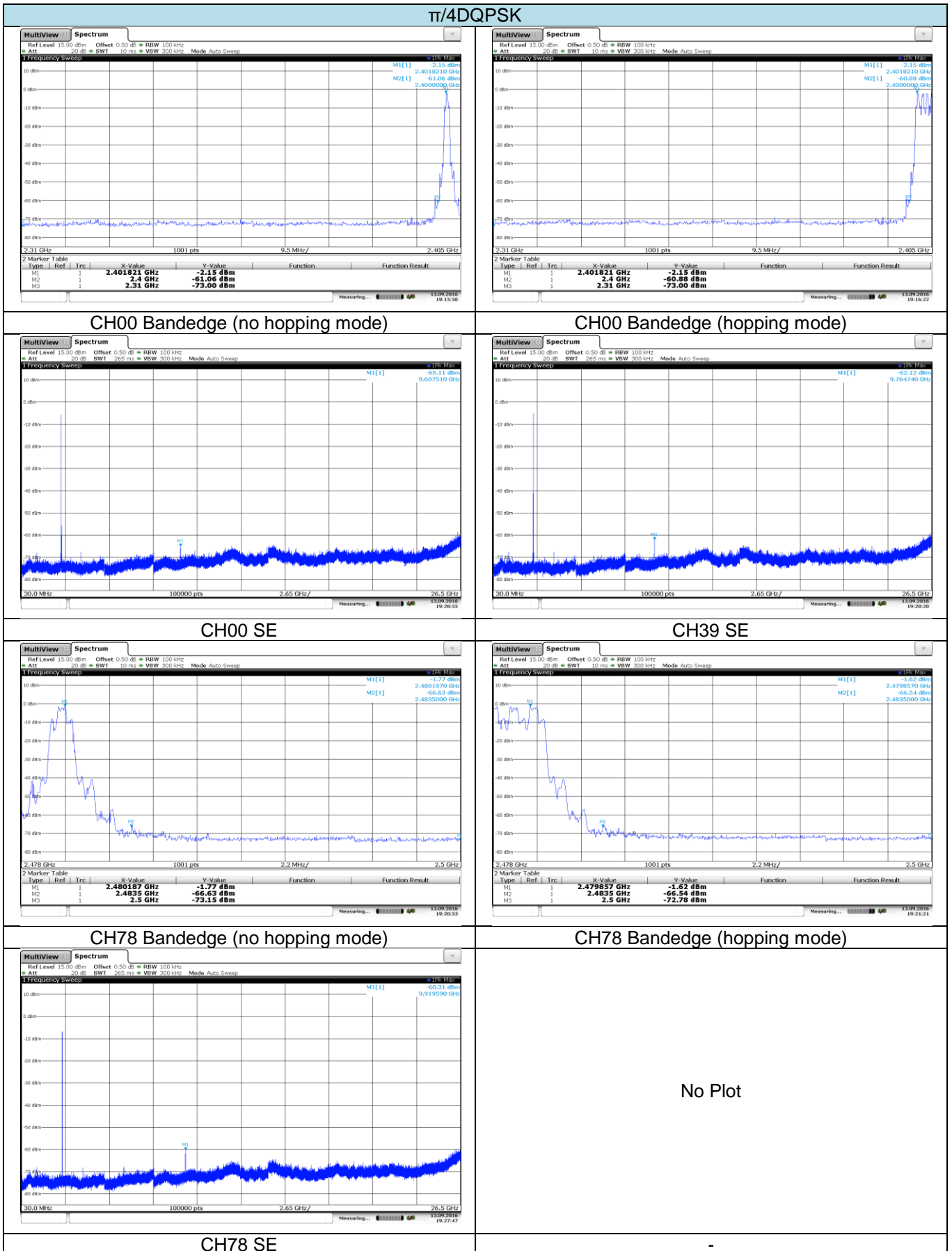

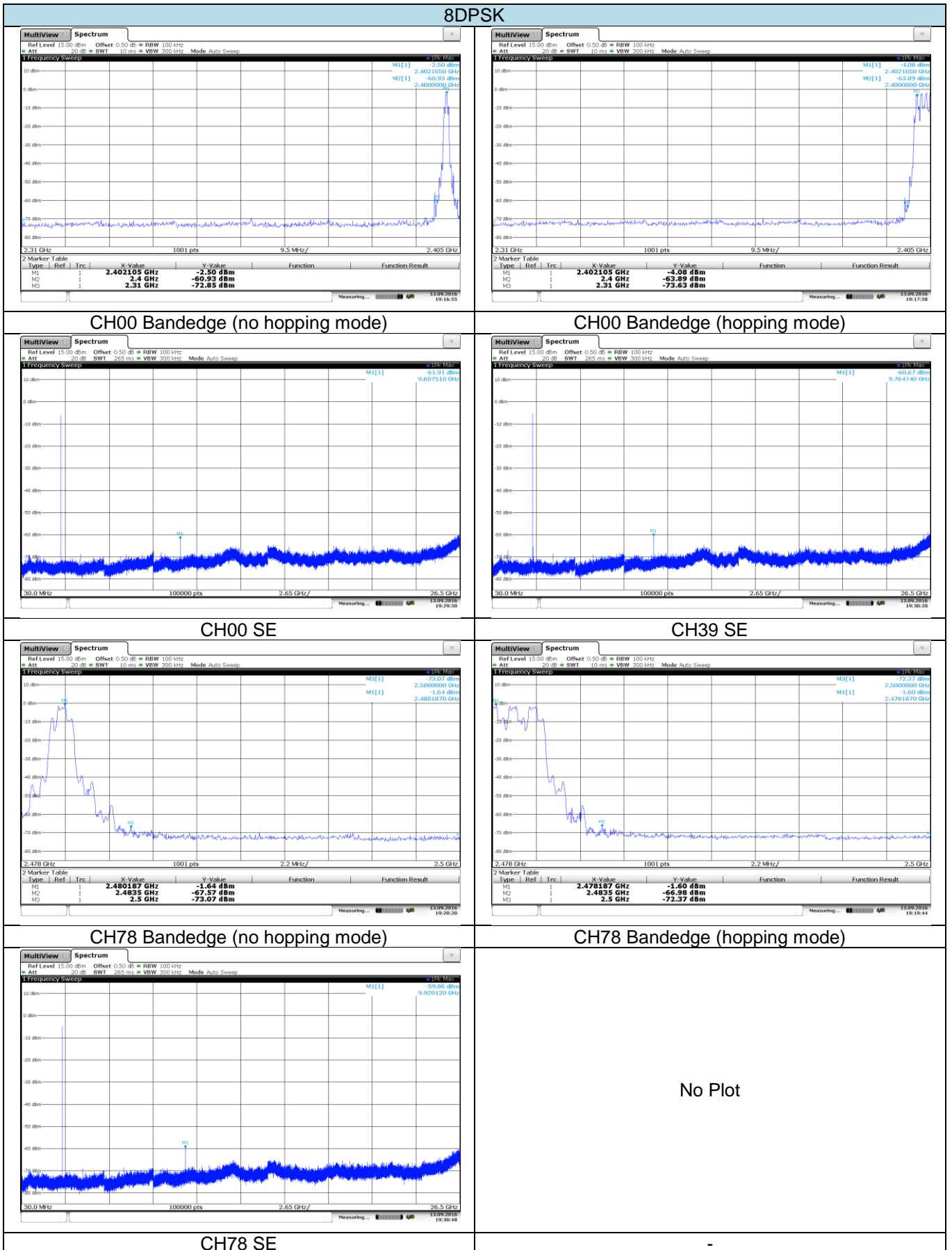

5.11. Spurious Emission (radiated)

LIMIT

FCC CFR Title 47 Part 15 Subpart C Section 15.209

Frequency	Limit (dBuV/m @3m)	Value
30MHz-88MHz	40.00	Quasi-peak
88MHz-216MHz	43.50	Quasi-peak
216MHz-960MHz	46.00	Quasi-peak
960MHz-1GHz	54.00	Quasi-peak
Above 1GHz	54.00	Average
	74.00	Peak

TEST CONFIGURATION

- 9KHz ~30MHz

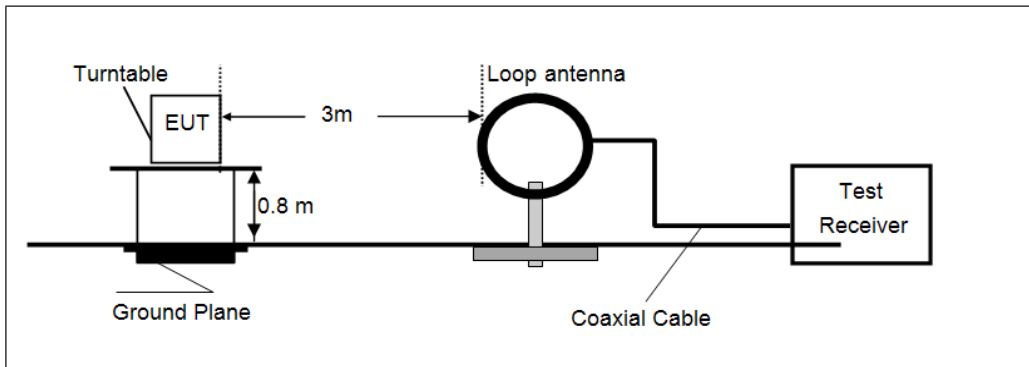

- 30MHz ~ 1GHz

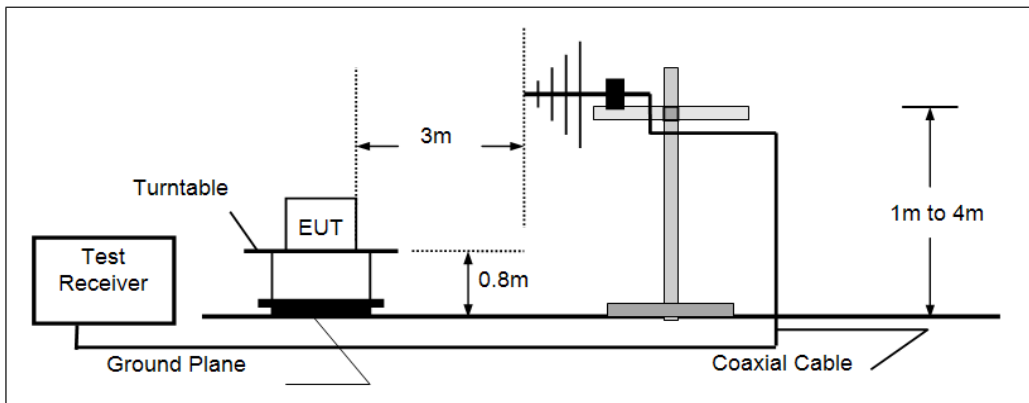

- Above 1GHz

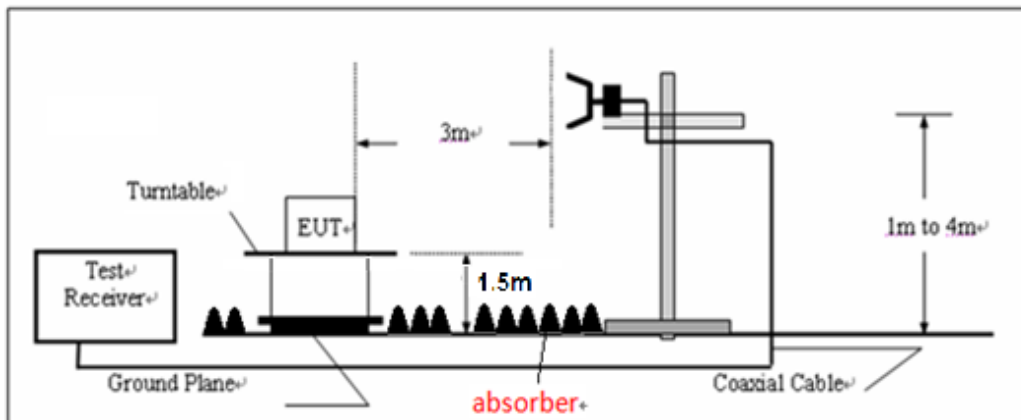

TEST PROCEDURE

1. The EUT was tested according to ANSI C63.10:2013 for compliance to FCC 47CFR 15.247 requirements.
2. The EUT is placed on a turn table which is 0.8 meter above ground. The turn table is rotated 360 degrees to determine the position of the maximum emission level.
3. The EUT was positioned such that the distance from antenna to the EUT was 3 meters.
4. The antenna is scanned from 1 meter to 4 meters to find out the maximum emission level. This is repeated for both horizontal and vertical polarization of the antenna.
5. Use the following spectrum analyzer settings
 - (1) Span shall be wide enough to fully capture the emission being measured;
 - (2) Below 1GHz, RBW=120KHz, VBW=300KHz, Sweep=auto, Detector function=peak, Trace=max hold;
If the emission level of the EUT measured by the peak detector is 3 dB lower than the applicable limit, the peak emission level will be reported. Otherwise, the emission measurement will be repeated using the quasi-peak detector and reported.
 - (3) Above 1GHz, RBW=1MHz, VBW=3MHz for Peak value
RBW=1MHz, VBW=10Hz for Average value.

TEST MODE:

Please refer to the clause 3.3

TEST RESULTS

Passed **Not Applicable**

Note:

- 1) *Final Level = Receiver Read level + Antenna Factor + Cable Loss – Preamplifier Factor*
- 2) *“**”, means this data is too weak; instrument or signal is unable to test.*
- 3) *The emission levels of other frequencies are very lower than the limit and not shown in the test report.*
- 4) *Have pre-scan all modulation modes, found the GFSK modulation which was the worst case, so only the worst case's data is shown in the test report.*

➤ **9kHz ~ 30MHz**

The EUT was pre-scanned the frequency band (9kHz~30MHz), found the radiated level lower than the limit, so don't show on the report.

➤ 30MHz ~ 1GHz

Polarization:

Vertical

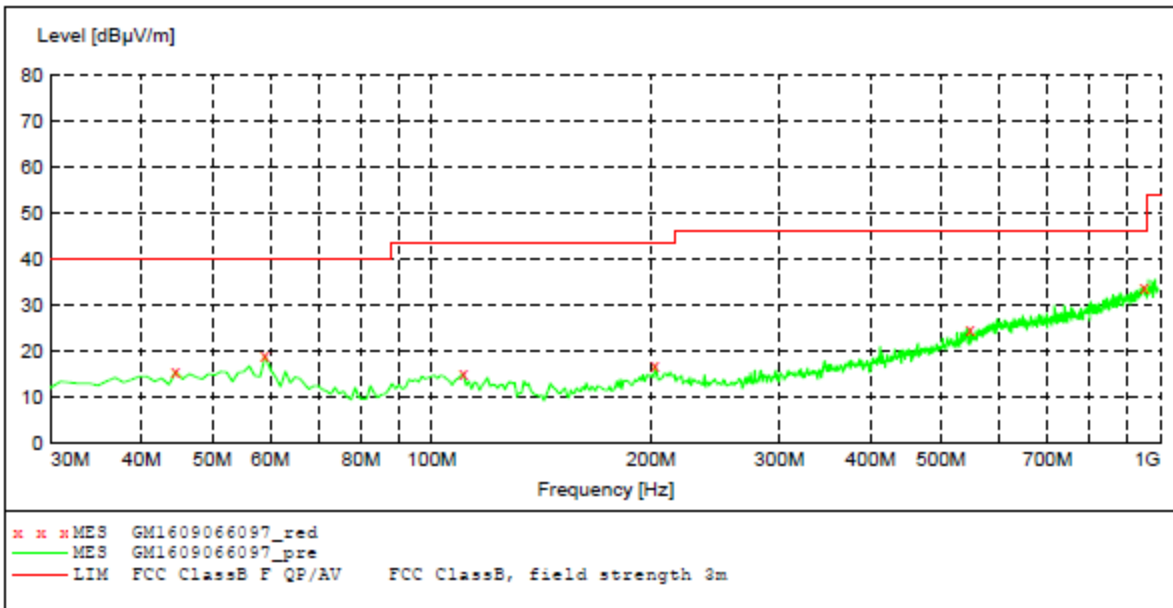

Frequency MHz	Level dBµV/m	Transd dB	Limit dBµV/m	Margin dB	Det.	Height cm	Azimuth deg	Polarization
44.550000	15.60	-14.8	40.0	24.4	QP	100.0	295.00	VERTICAL
59.100000	19.00	-14.8	40.0	21.0	QP	100.0	360.00	VERTICAL
110.510000	15.00	-15.1	43.5	28.5	QP	100.0	245.00	VERTICAL
202.660000	16.80	-13.7	43.5	26.7	QP	100.0	358.00	VERTICAL
547.980000	24.90	-4.9	46.0	21.1	QP	100.0	279.00	VERTICAL
948.590000	34.00	3.7	46.0	12.0	QP	100.0	231.00	VERTICAL

Polarization:

Horizontal

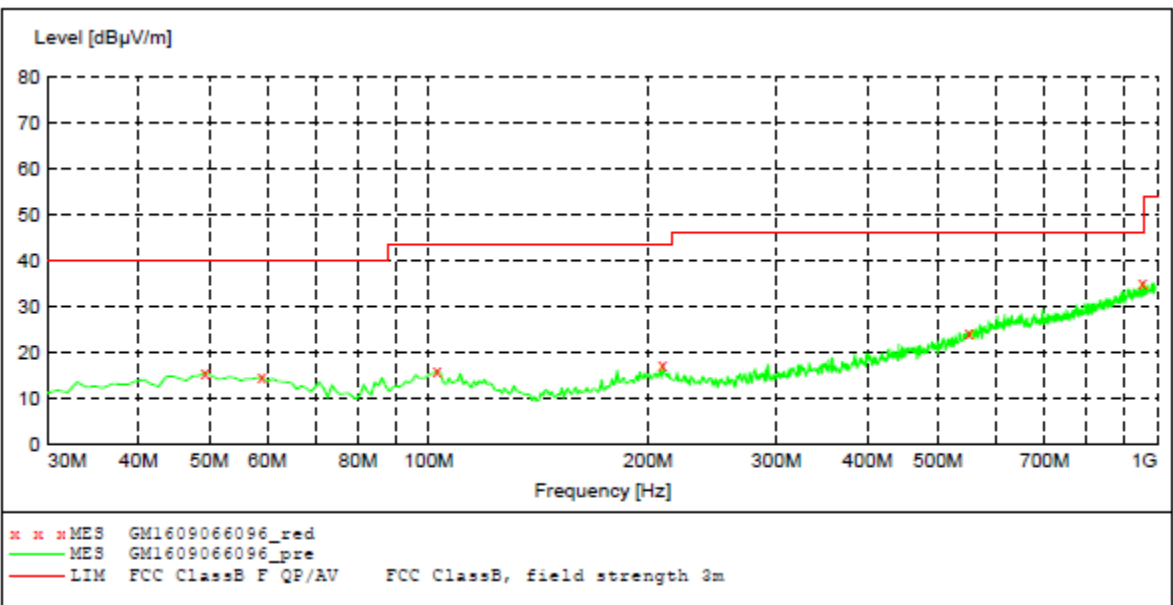

Frequency MHz	Level dBµV/m	Transd dB	Limit dBµV/m	Margin dB	Det.	Height cm	Azimuth deg	Polarization
49.400000	15.80	-14.4	40.0	24.2	QP	300.0	75.00	HORIZONTAL
59.100000	14.70	-14.8	40.0	25.3	QP	300.0	289.00	HORIZONTAL
102.750000	16.20	-14.5	43.5	27.3	QP	300.0	109.00	HORIZONTAL
209.450000	17.20	-14.0	43.5	26.3	QP	300.0	171.00	HORIZONTAL
551.860000	24.40	-4.7	46.0	21.6	QP	100.0	77.00	HORIZONTAL
954.410000	35.40	3.8	46.0	10.6	QP	300.0	0.00	HORIZONTAL

➤ Above 1GHz

CH00									
Frequency (MHz)	Read Level (dBuV)	Antenna Factor (dB/m)	Cable Loss (dB)	Preamp Factor (dB)	Level (dBuV/m)	Limit Line (dBuV/m)	Margin Limit (dB)	Polarization	Test value
1457.523	38.15	24.66	5.10	36.79	31.12	74.00	-42.88	Vertical	Peak
3534.541	37.96	28.77	8.79	37.99	37.53	74.00	-36.47	Vertical	
4946.072	38.20	31.17	9.31	38.62	40.06	74.00	-33.94	Vertical	
8125.215	32.45	36.84	11.24	38.21	42.32	74.00	-31.68	Vertical	
9636.161	33.11	38.18	12.14	38.07	45.36	74.00	-28.64	Vertical	
11312.310	33.19	39.14	13.40	37.98	47.75	74.00	-26.25	Vertical	
1207.279	37.39	24.43	4.55	36.52	29.85	74.00	-44.15	Horizontal	
1759.638	36.52	25.48	5.72	37.07	30.65	74.00	-43.35	Horizontal	
3543.550	35.58	28.79	8.78	37.99	35.16	74.00	-38.84	Horizontal	
5448.410	32.62	32.29	9.60	38.29	36.22	74.00	-37.78	Horizontal	
8441.459	31.44	37.15	11.25	38.11	41.73	74.00	-32.27	Horizontal	
11112.52	31.41	39.18	13.29	38.09	45.79	74.00	-28.21	Horizontal	

Remark:

1. Final Level = Receiver Read level + Antenna Factor + Cable Loss – Preamplifier Factor
2. The peak level is lower than average limit(54 dBuV/m), this data is the too weak instrument of signal is unable to test.
3. The emission levels of other frequencies are very lower than the limit and not show in test report.

CH39									
Frequency (MHz)	Read Level (dBuV)	Antenna Factor (dB/m)	Cable Loss (dB)	Preamp Factor (dB)	Level (dBuV/m)	Limit Line (dBuV/m)	Margin Limit (dB)	Polarization	Test value
1251.079	39.19	24.48	4.66	36.58	31.75	74.00	-42.25	Vertical	Peak
1759.638	38.48	25.48	5.72	37.07	32.61	74.00	-41.39	Vertical	
3104.217	37.66	28.55	8.31	37.99	36.53	74.00	-37.47	Vertical	
4883.519	43.54	31.14	9.26	38.58	45.36	74.00	-28.64	Vertical	
7009.956	31.90	35.82	10.77	38.06	40.43	74.00	-33.57	Vertical	
9228.060	32.64	37.99	11.82	38.00	44.45	74.00	-29.55	Vertical	
1487.509	37.68	24.69	5.15	36.82	30.70	74.00	-43.30	Horizontal	
1832.785	37.53	25.68	5.86	37.12	31.95	74.00	-42.05	Horizontal	
3561.636	37.26	28.80	8.77	37.99	36.84	74.00	-37.16	Horizontal	
4883.519	38.24	31.14	9.26	38.58	40.06	74.00	-33.94	Horizontal	
8593.224	32.47	37.34	11.32	38.07	43.06	74.00	-30.94	Horizontal	
11226.250	32.22	39.15	13.35	38.02	46.70	74.00	-27.30	Horizontal	

Remark:

1. Final Level = Receiver Read level + Antenna Factor + Cable Loss – Preamplifier Factor
2. The peak level is lower than average limit(54 dBuV/m), this data is the too weak instrument of signal is unable to test.
3. The emission levels of other frequencies are very lower than the limit and not show in test report.

CH78									
Frequency (MHz)	Read Level (dBuV)	Antenna Factor (dB/m)	Cable Loss (dB)	Preamp Factor (dB)	Level (dBuV/m)	Limit Line (dBuV/m)	Margin Limit (dB)	Polarization	Test value
1188.980	38.91	24.41	4.51	36.50	31.33	74.00	-42.67	Vertical	Peak
1823.477	37.74	25.65	5.84	37.12	32.11	74.00	-41.89	Vertical	
3249.760	37.52	28.61	8.50	37.99	36.64	74.00	-37.36	Vertical	
4107.316	36.21	29.82	8.69	38.07	36.65	74.00	-37.35	Vertical	
8506.170	32.25	37.24	11.25	38.09	42.65	74.00	-31.35	Vertical	
10750.81	32.20	38.95	13.06	38.14	46.07	74.00	-27.93	Vertical	
1267.104	37.30	24.49	4.69	36.59	29.89	74.00	-44.11	Horizontal	
1842.139	37.46	25.69	5.88	37.13	31.90	74.00	-42.10	Horizontal	
3747.656	36.15	29.11	8.70	37.99	35.97	74.00	-38.03	Horizontal	
4958.678	40.03	31.18	9.31	38.62	41.90	74.00	-32.10	Horizontal	
5703.861	33.08	32.72	9.68	38.11	37.37	74.00	-36.63	Horizontal	
9204.600	32.44	37.98	11.82	37.99	44.25	74.00	-29.75	Horizontal	

Remark:

1. Final Level = Receiver Read level + Antenna Factor + Cable Loss – Pre-amplifier Factor
2. The peak level is lower than average limit (54 dBuV/m), this data is the too weak instrument of signal is unable to test.
3. The emission levels of other frequencies are very lower than the limit and not show in test report.

6. Test Setup Photos of the EUT

Conducted Emission (AC Mains)



Radiated Emission



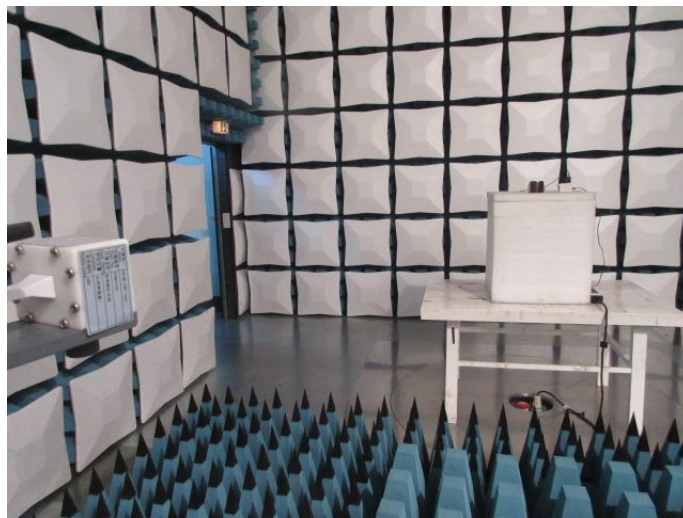

7. External and Internal Photos of the EUT

Reference to Test Report No.: TRE1608017401.

.....End of Report.....