







# TEST REPORT

**Report No.** ..... : **CHTEW19050088** Report Verification:   
**Project No.**..... : **SHT1904069802EW**  
**FCC ID**..... : **2AK4CBB20US**  
**Applicant's name**..... : **Petcube, Inc.**  
 Address..... : 2711 Centerville Road,Suite 400,Wilmington Delaware United States 19808  
 Manufacturer..... : Petcube, Inc.  
 Address..... : 2711 Centerville Road,Suite 400,Wilmington Delaware United States 19808  
**Test item description** ..... : **Petcube Bites 2**  
 Trade Mark ..... : Petcube  
 Model/Type reference..... : BB20US  
 Listed Model(s) ..... : -  
**Standard** ..... : **FCC CFR Title 47 Part 15 Subpart C Section 15.247**  
 Date of receipt of test sample..... : Apr.24, 2019  
 Date of testing..... : Apr.24, 2019- May.22, 2019  
 Date of issue..... : May.23, 2019  
**Result**..... : **PASS**

Compiled by  
 ( Position+Printed name+Signature): File administrators Fanghui Zhu   
 Supervised by  
 (Position+Printed name+Signature): Project Engineer Jerry Zhao   
 Approved by  
 (Position+Printed name+Signature): RF Manager Hans Hu 

**Testing Laboratory Name** ..... : **Shenzhen Huatongwei International Inspection Co., Ltd.**  
 Address..... : 1/F, Bldg 3, Hongfa Hi-tech Industrial Park, Genyu Road, Tianliao, Gongming, Shenzhen, China

**Shenzhen Huatongwei International Inspection Co., Ltd. All rights reserved.**

This publication may be reproduced in whole or in part for non-commercial purposes as long as the Shenzhen Huatongwei International Inspection Co., Ltd. is acknowledged as copyright owner and source of the material. Shenzhen Huatongwei International Inspection Co., Ltd. takes no responsibility for and will not assume liability for damages resulting from the reader's interpretation of the reproduced material due to its placement and context.

*The test report merely correspond to the test sample.*

## Contents

<b>1.</b>	<b><u>TEST STANDARDS AND REPORT VERSION</u></b>	<b>3</b>
1.1.	Test Standards	3
1.2.	Report version	3
<b>2.</b>	<b><u>TEST DESCRIPTION</u></b>	<b>4</b>
<b>3.</b>	<b><u>SUMMARY</u></b>	<b>5</b>
3.1.	Client Information	5
3.2.	Product Description	5
3.3.	Operation state	6
3.4.	EUT configuration	6
3.5.	Modifications	6
<b>4.</b>	<b><u>TEST ENVIRONMENT</u></b>	<b>7</b>
4.1.	Address of the test laboratory	7
4.2.	Test Facility	7
4.3.	Environmental conditions	8
4.4.	Statement of the measurement uncertainty	8
4.5.	Equipments Used during the Test	9
<b>5.</b>	<b><u>TEST CONDITIONS AND RESULTS</u></b>	<b>11</b>
5.1.	Antenna requirement	11
5.2.	Conducted Emissions (AC Main)	12
5.3.	Conducted Peak Output Power	15
5.4.	20 dB Bandwidth	19
5.5.	Carrier Frequencies Separation	23
5.6.	Hopping Channel Number	25
5.7.	Dwell Time	27
5.8.	Pseudorandom Frequency Hopping Sequence	34
5.9.	Restricted band (radiated)	35
5.10.	Band edge and Spurious Emissions (conducted)	37
5.11.	Spurious Emissions (radiated)	53
<b>6.</b>	<b><u>TEST SETUP PHOTOS</u></b>	<b>57</b>
<b>7.</b>	<b><u>EXTERANAL AND INTERNAL PHOTOS</u></b>	<b>59</b>

## 1. TEST STANDARDS AND REPORT VERSION

### 1.1. Test Standards

The tests were performed according to following standards:

[FCC Rules Part 15.247](#): Frequency Hopping, Direct Spread Spectrum and Hybrid Systems that are in operation within the bands of 902-928 MHz, 2400-2483.5 MHz, and 5725-5850 MHz

[ANSI C63.10-2013](#): American National Standard for Testing Unlicensed Wireless Devices

### 1.2. Report version

Revision No.	Date of issue	Description
N/A	2019-05-23	Original

## **2. TEST DESCRIPTION**

<b>Test Item</b>	<b>Section in CFR 47</b>	<b>Result</b>	<b>Test Engineer</b>
Antenna Requirement	15.203/15.247 (c)	PASS	Xiaokang Tan
AC Power Line Conducted Emissions	15.207	PASS	Zhiwei Liu
Conducted Peak Output Power	15.247 (b)(1)	PASS	Xiaokang Tan
20 dB Bandwidth	15.247 (a)(1)	PASS	Xiaokang Tan
Carrier Frequencies Separation	15.247 (a)(1)	PASS	Xiaokang Tan
Hopping Channel Number	15.247 (a)(1)	PASS	Xiaokang Tan
Dwell Time	15.247 (a)(1)	PASS	Xiaokang Tan
Pseudorandom Frequency Hopping Sequence	15.247(b)(4)	PASS	Xiaokang Tan
Restricted band	15.247(d)/15.205	PASS	Xiaokang Tan
Radiated Emissions	15.247(d)/15.209	PASS	Tony Duan

Note: The measurement uncertainty is not included in the test result.

### 3. SUMMARY

#### 3.1. Client Information

Applicant:	Petcube, Inc.
Address:	2711 Centerville Road,Suite 400,Wilmington Delaware United States 19808
Manufacturer:	Petcube, Inc.
Address:	2711 Centerville Road,Suite 400,Wilmington Delaware United States 19808

#### 3.2. Product Description

Name of EUT:	Petcube Bites 2
Trade Mark:	Petcube
Model No.:	BB20US
Listed Model(s):	-
IMEI:	-
Power supply:	DC 5V, 2A
Adapter information:	-
Hardware version:	v2.2.0.1.5
Software version:	v2.8.0.3560
<b>Bluetooth</b>	
Version:	Supported BT4.0+EDR
Modulation:	GFSK, $\pi/4$ DQPSK, 8DPSK
Operation frequency:	2402MHz~2480MHz
Channel number:	79
Channel separation:	1MHz
Antenna type:	PCB
Antenna gain:	0.5dbi

### 3.3. Operation state

➤ **Test frequency list**

According to section 15.31(m), regards to the operating frequency range over 10 MHz, must select three channel which were tested. the Lowest frequency, the middle frequency, and the highest frequency of channel were selected to perform the test, please see the above gray bottom.

Channel	Frequency (MHz)
00	2402
01	2403
⋮	⋮
39	2441
⋮	⋮
77	2479
78	2480

➤ **TEST MODE**

For RF test items:
The engineering test program was provided and enabled to make EUT continuous transmit
For AC power line conducted emissions:
The EUT was set to connect with the Bluetooth instrument under large package sizes transmission.
For Radiated suprious emissions test item:
The engineering test program was provided and enabled to make EUT continuous transmit. The EUT in each of three orthogonal axis emissions had been tested ,but only the worst case (X axis) data recorded in the report.

### 3.4. EUT configuration

The following peripheral devices and interface cables were connected during the measurement:

- - supplied by the manufacturer
- - supplied by the lab

/	Manufacturer:	/
	Model No.:	/
/	Manufacturer:	/
	Model No.:	/

### 3.5. Modifications

No modifications were implemented to meet testing criteria.

## **4. TEST ENVIRONMENT**

### **4.1. Address of the test laboratory**

Laboratory: Shenzhen Huatongwei International Inspection Co., Ltd.

Address: 1/F, Bldg 3, Hongfa Hi-tech Industrial Park, Genyu Road, Tianliao, Gongming, Shenzhen, China

### **4.2. Test Facility**

#### **CNAS-Lab Code: L1225**

Shenzhen Huatongwei International Inspection Co., Ltd. has been assessed and proved to be in compliance with CNAS-CL01 Accreditation Criteria for Testing and Calibration Laboratories (identical to ISO/IEC17025: 2005 General Requirements) for the Competence of Testing and Calibration Laboratories.

#### **A2LA-Lab Cert. No.: 3902.01**

Shenzhen Huatongwei International Inspection Co., Ltd. EMC Laboratory has been accredited by A2LA for technical competence in the field of electrical testing, and proved to be in compliance with ISO/IEC 17025: 2005 General Requirements for the Competence of Testing and Calibration Laboratories and any additional program requirements in the identified field of testing.

#### **FCC-Registration No.: 762235**

Shenzhen Huatongwei International Inspection Co., Ltd. EMC Laboratory has been registered and fully described in a report filed with the FCC (Federal Communications Commission). The acceptance letter from the FCC is maintained in our files.

#### **IC-Registration No.:5377B-1**

Two 3m Alternate Test Site of Shenzhen Huatongwei International Inspection Co., Ltd. has been registered by Certification and Engineering Bureau of Industry Canada for the performance of radiated measurements with Registration No.: 5377B-1.

#### **ACA**

Shenzhen Huatongwei International Inspection Co., Ltd. EMC Laboratory can also perform testing for the Australian C-Tick mark as a result of our A2LA accreditation.

### 4.3. Environmental conditions

During the measurement the environmental conditions were within the listed ranges:

Temperature:	15~35°C
Relative Humidity:	30~60 %
Air Pressure:	950~1050mba

### 4.4. Statement of the measurement uncertainty

The data and results referenced in this document are true and accurate. The reader is cautioned that there may be errors in calibration limits of the equipment and facilities. The measurement uncertainty was calculated for all measurements listed in this test report according to TR-100028-01 "Electromagnetic compatibility and Radio spectrum Matters (ERM); Uncertainties in the measurement of mobile radio equipment characteristics; Part 1" and TR-100028-02 "Electromagnetic compatibility and Radio spectrum Matters (ERM); Uncertainties in the measurement of mobile radio equipment characteristics; Part 2" and is documented in the Shenzhen Huatongwei International Inspection Co., Ltd. quality system according to ISO/IEC 17025. Furthermore, component and process variability of devices similar to that tested may result in additional deviation. The manufacturer has the sole responsibility of continued compliance of the device.

Here after the best measurement capability for Shenzhen Huatongwei International Inspection Co., Ltd. is reported:

Test Items	Measurement Uncertainty	Notes
Transmitter power conducted	0.51 dB	(1)
Conducted spurious emissions 9kHz~40GHz	0.63 dB	(1)
Conducted Disturbance 150kHz~30MHz	3.02 dB	(1)
Radiated Emissions below 1GHz	4.90 dB	(1)
Radiated Emissions above 1GHz	4.96 dB	(1)
Occupied Bandwidth	70 Hz	(1)

(1) This uncertainty represents an expanded uncertainty expressed at approximately the 95% confidence level using a coverage factor of  $k=1.96$



#### 4.5. Equipments Used during the Test

● Conducted Emission						
Used	Test Equipment	Manufacturer	Model No.	Serial No.	Last Cal. Date (YY-MM-DD)	Next Cal. Date (YY-MM-DD)
●	Shielded Room	Albatross projects	N/A	N/A	2018/09/28	2023/09/27
●	EMI Test Receiver	R&S	ESCI	101247	2018/10/27	2019/10/26
●	Artificial Mains	SCHWARZBECK	NNLK 8121	573	2018/10/27	2019/10/26
●	Pulse Limiter	R&S	ESH3-Z2	100499	2018/10/27	2019/10/26
●	RF Connection Cable	HUBER+SUHNER	EF400	N/A	2018/11/15	2019/11/14
●	Test Software	R&S	ES-K1	N/A	N/A	N/A
○	Single Balanced Telecom Pair ISN	FCC	FCC-TLISN-T2-02	20371	2018/10/28	2019/10/27
○	Two Balanced Telecom Pairs ISN	FCC	FCC-TLISN-T4-02	20373	2018/10/28	2019/10/27
○	Four Balanced Telecom Pairs ISN	FCC	FCC-TLISN-T8-02	20375	2018/10/28	2019/10/27
○	V-Network	R&S	ESH3-Z6	100211	2018/10/27	2019/10/26
○	V-Network	R&S	ESH3-Z6	100210	2018/10/27	2019/10/26
○	2-Line V-Network	R&S	ESH3-Z5	100049	2018/10/27	2019/10/26

● Radiated Emission-6th test site						
Used	Test Equipment	Manufacturer	Model No.	Serial No.	Last Cal. Date (YY-MM-DD)	Next Cal. Date (YY-MM-DD)
●	Semi-Anechoic Chamber	Albatross projects	SAC-3m-02	N/A	2018/09/30	2021/09/29
●	EMI Test Receiver	R&S	ESCI	100900	2018/10/28	2019/10/27
●	Loop Antenna	R&S	HFH2-Z2	100020	2017/11/20	2020/11/19
●	Ultra-Broadband Antenna	SCHWARZBECK	VULB9163	546	2017/04/05	2020/04/04
●	Pre-Amplifier	SCHWARZBECK	BBV 9742	N/A	2018/11/15	2019/11/14
●	RF Connection Cable	HUBER+SUHNER	N/A	N/A	2018/09/28	2019/09/27
●	RF Connection Cable	HUBER+SUHNER	SUCOFLEX104	501184/4	2018/09/28	2019/09/27
●	Test Software	R&S	ES-K1	N/A	N/A	N/A
●	Turntable	Maturo Germany	TT2.0-1T	N/A	N/A	N/A
●	Antenna Mast	Maturo Germany	CAM-4.0-P-12	N/A	N/A	N/A

● Radiated emission-7th test site						
Used	Test Equipment	Manufacturer	Model No.	Serial No.	Last Cal. Date (YY-MM-DD)	Next Cal. Date (YY-MM-DD)
●	Semi-Anechoic Chamber	Albatross projects	SAC-3m-01	N/A	2018/09/30	2021/09/29
●	Spectrum Analyzer	R&S	FSP40	100597	2018/10/27	2019/10/26
●	Horn Antenna	SCHWARZBECK	9120D	1011	2017/03/27	2020/03/26
●	Pre-amplifier	BONN	BLWA0160-2M	1811887	2018/11/14	2019/11/13
●	Pre-amplifier	CD	PAP-0102	12004	2018/11/14	2019/11/13
●	Broadband Pre-amplifier	SCHWARZBECK	BBV 9718	9718-248	2019/04/28	2020/04/27
●	RF Connection Cable	HUBER+SUHNER	RE-7-FH	N/A	2018/11/15	2019/11/14
●	RF Connection Cable	HUBER+SUHNER	RE-7-FL	N/A	2018/11/15	2019/11/14
●	Test Software	Audix	E3	N/A	N/A	N/A

●	Turntable	Maturo Germany	TT2.0-1T	N/A	N/A	N/A
●	Antenna Mast	Maturo Germany	CAM-4.0-P-12	N/A	N/A	N/A

● **RF Conducted Method**

Used	Test Equipment	Manufacturer	Model No.	Serial No.	Last Cal. Date (YY-MM-DD)	Next Cal. Date (YY-MM-DD)
●	Signal and spectrum Analyzer	R&S	FSV40	100048	2018/10/28	2019/10/27
●	Spectrum Analyzer	Agilent	N9020A	MY50510187	2018/09/29	2019/09/28
○	Radio communication tester	R&S	CMW500	137688-Lv	2018/09/29	2019/09/28
○	Test software	Tonscend	JS1120-1(LTE)	N/A	N/A	N/A
○	Test software	Tonscend	JS1120-2(WIFI)	N/A	N/A	N/A
○	Test software	Tonscend	JS1120-3(WCDMA)	N/A	N/A	N/A
○	Test software	Tonscend	JS1120-4(GSM)	N/A	N/A	N/A

## 5. TEST CONDITIONS AND RESULTS

### 5.1. Antenna requirement

#### Requirement

##### **FCC CFR Title 47 Part 15 Subpart C Section 15.203:**

An intentional radiator shall be designed to ensure that no antenna other than that furnished by the responsible party shall be used with the device. The use of a permanently attached antenna or of an antenna that uses a unique coupling to the intentional radiator, the manufacturer may design the unit so that a broken antenna can be replaced by the user, but the use of a standard antenna jack or electrical connector is prohibited.

##### **FCC CFR Title 47 Part 15 Subpart C Section 15.247(c) (1)(i):**

(i) Systems operating in the 2400~2483.5 MHz band that is used exclusively for fixed. Point-to-point operations may employ transmitting antennas with directional gain greater than 6 dBi provided the maximum conducted output power of the intentional radiator is reduced by 1 dB for every 3 dB that the directional gain of the antenna exceeds 6 dBi.

#### Test Result:

**Passed**       **Not Applicable**

The directional gain of the antenna less than 6 dBi, please refer to the below antenna photo.



## 5.2. Conducted Emissions (AC Main)

### LIMIT

FCC CFR Title 47 Part 15 Subpart C Section 15.207

Frequency range (MHz)	Limit (dBuV)	
	Quasi-peak	Average
0.15-0.5	66 to 56*	56 to 46*
0.5-5	56	46
5-30	60	50

\* Decreases with the logarithm of the frequency.

### TEST CONFIGURATION

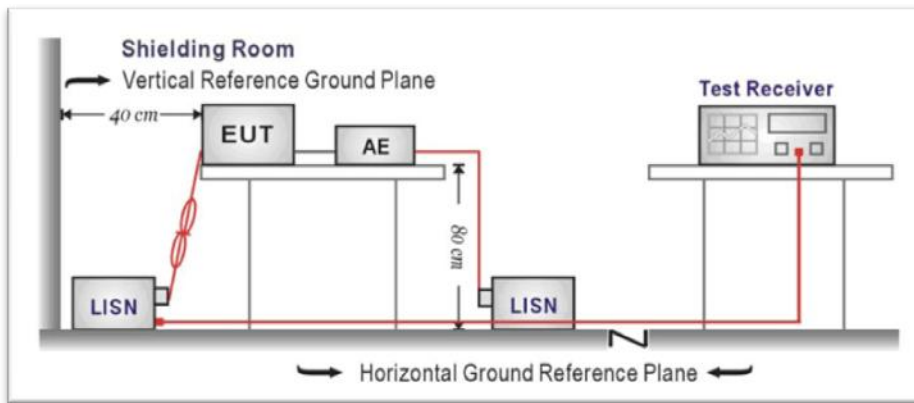

### TEST PROCEDURE

1. The EUT was setup according to ANSI C63.10:2013 requirements.
2. The EUT was placed on a platform of nominal size, 1 m by 1.5 m, raised 80 cm above the conducting ground plane. The vertical conducting plane was located 40 cm to the rear of the EUT. All other surfaces of EUT were at least 80 cm from any other grounded conducting surface.
3. The EUT and simulators are connected to the main power through a line impedances stabilization network (LISN). The LISN provides a 50 ohm /50uH coupling impedance for the measuring equipment.
4. The peripheral devices are also connected to the main power through a LISN. (Please refer to the block diagram of the test setup and photographs)
5. Each current-carrying conductor of the EUT power cord, except the ground (safety) conductor, was individually connected through a LISN to the input power source.
6. The excess length of the power cord between the EUT and the LISN receptacle were folded back and forth at the center of the lead to form a bundle not exceeding 40 cm in length.
7. Conducted emissions were investigated over the frequency range from 0.15MHz to 30MHz using a receiver bandwidth of 9 kHz.
8. During the above scans, the emissions were maximized by cable manipulation.

### TEST RESULTS

Passed       Not Applicable

Note:

- 1) Transd= Cable lose + Pulse Limiter Factor + Artificial Mains Factor
- 2) Margin= Limit - Level

Test Line:

L

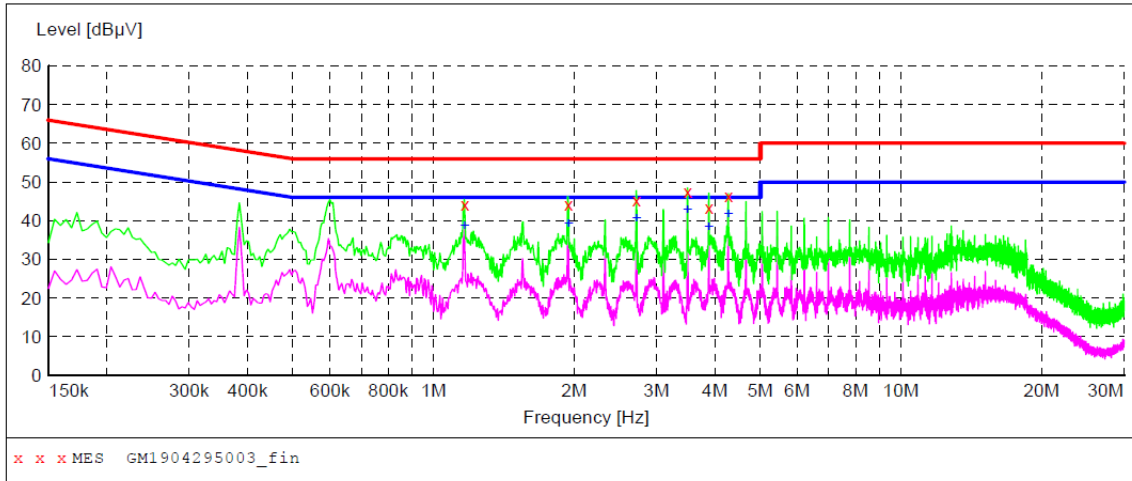

**MEASUREMENT RESULT: "GM1904295003\_fin"**

4/29/2019 9:32AM

Frequency MHz	Level dBµV	Transd dB	Limit dBµV	Margin dB	Detector	Line	PE
1.167000	44.10	9.9	56	11.9	QP	L1	GND
1.945500	44.10	9.9	56	11.9	QP	L1	GND
2.719500	45.40	9.9	56	10.6	QP	L1	GND
3.498000	47.40	9.9	56	8.6	QP	L1	GND
3.885000	43.40	9.9	56	12.6	QP	L1	GND
4.276500	46.40	9.9	56	9.6	QP	L1	GND

**MEASUREMENT RESULT: "GM1904295003\_fin2"**

4/29/2019 9:32AM

Frequency MHz	Level dBµV	Transd dB	Limit dBµV	Margin dB	Detector	Line	PE
1.167000	38.60	9.9	46	7.4	AV	L1	GND
1.945500	39.30	9.9	46	6.7	AV	L1	GND
2.719500	40.70	9.9	46	5.3	AV	L1	GND
3.498000	42.70	9.9	46	3.3	AV	L1	GND
3.885000	38.50	9.9	46	7.5	AV	L1	GND
4.276500	41.60	9.9	46	4.4	AV	L1	GND

Test Line:

N

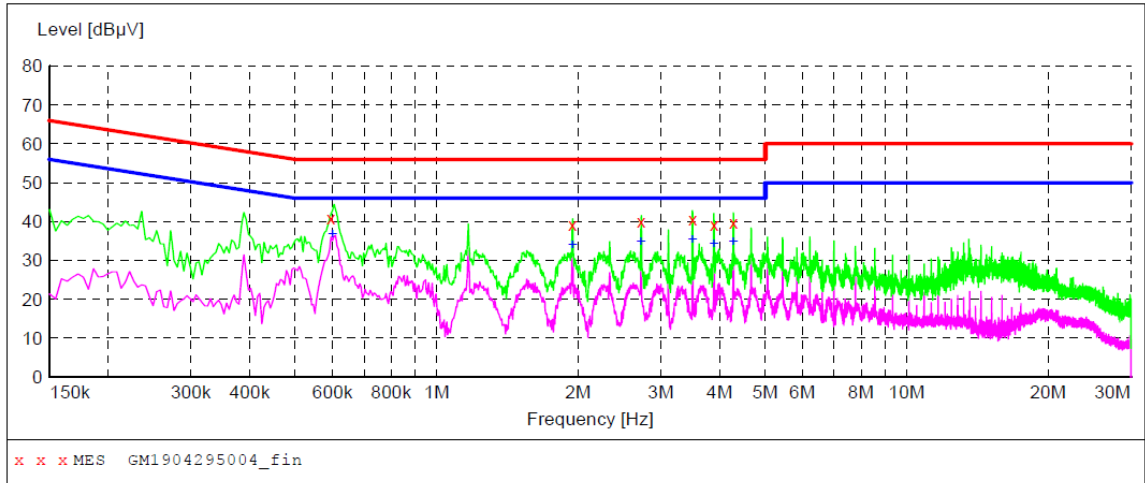

**MEASUREMENT RESULT: "GM1904295004\_fin"**

4/29/2019 9:35AM

Frequency MHz	Level dBµV	Transd dB	Limit dBµV	Margin dB	Detector	Line	PE
0.595500	40.90	9.9	56	15.1	QP	N	GND
1.945500	39.10	9.9	56	16.9	QP	N	GND
2.724000	40.10	9.9	56	15.9	QP	N	GND
3.502500	40.70	9.9	56	15.3	QP	N	GND
3.889500	39.20	9.9	56	16.8	QP	N	GND
4.276500	39.70	9.9	56	16.3	QP	N	GND

**MEASUREMENT RESULT: "GM1904295004\_fin2"**

4/29/2019 9:35AM

Frequency MHz	Level dBµV	Transd dB	Limit dBµV	Margin dB	Detector	Line	PE
0.600000	36.60	9.9	46	9.4	AV	N	GND
1.945500	34.10	9.9	46	11.9	AV	N	GND
2.724000	34.70	9.9	46	11.3	AV	N	GND
3.502500	35.40	9.9	46	10.6	AV	N	GND
3.889500	34.20	9.9	46	11.8	AV	N	GND
4.276500	34.90	9.9	46	11.1	AV	N	GND

### 5.3. Conducted Peak Output Power

#### LIMIT

FCC CFR Title 47 Part 15 Subpart C Section 15.247 (b)(1):

For frequency hopping systems operating in the 2400-2483.5 MHz band employing at least 75 non-overlapping hopping channels, and all frequency hopping systems in the 5725-5850 MHz band: 1 watt.  
 For all other frequency hopping systems in the 2400-2483.5 MHz band: 0.125 watts.

#### TEST CONFIGURATION

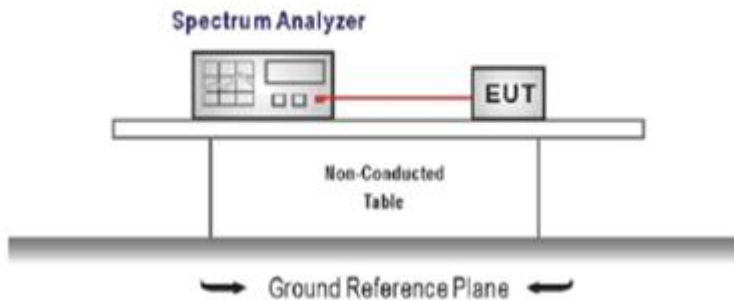

#### TEST PROCEDURE

1. The transmitter output was connected to the spectrum analyzer through an attenuator, the pathloss was compensated to the results for each measurement.
2. Set to the maximum power setting and enable the EUT transmit continuously
3. Use the following spectrum analyzer settings:  
 Span = approximately 5 times the 20 dB bandwidth, centered on a hopping channel  
 RBW ≥ the 20 dB bandwidth of the emission being measured, VBW ≥ RBW  
 Sweep = auto, Detector function = peak, Trace = max hold
4. Measure and record the results in the test report.

#### TEST MODE:

Please refer to the clause 3.3

#### TEST RESULTS

Passed       Not Applicable

Modulation type	Channel	Output power (dBm)	Limit (dBm)	Result
GFSK	00	2.15	≤ 30.00	Pass
	39	0.13		
	78	-1.98		
π/4DQPSK	00	-1.68	≤ 21.00	Pass
	39	-2.92		
	78	-5.21		
8DPSK	00	-2.04	≤ 21.00	Pass
	39	-3.52		
	78	-5.75		

Modulation Type: GFSK	
CH00	<p>Spectrum Ref Level 20.00 dBm Offset 1.00 dB RBW 1 MHz Att 30 dB SWT 1 ms VBW 3 MHz Mode Auto Sweep Count 500/500 IPK View M1[1] 2.15 dBm 2.40184080 GHz CF 2.402 GHz 691 pts Span 5.0 MHz Date: 16 MAY 2019 16:29:16</p>
CH39	<p>Spectrum Ref Level 20.00 dBm Offset 1.00 dB RBW 1 MHz Att 30 dB SWT 1 ms VBW 3 MHz Mode Auto Sweep Count 500/500 IPK View M1[1] 0.13 dBm 2.44086250 GHz CF 2.441 GHz 691 pts Span 5.0 MHz Date: 16 MAY 2019 16:54:58</p>
CH78	<p>Spectrum Ref Level 20.00 dBm Offset 1.00 dB RBW 1 MHz Att 30 dB SWT 1 ms VBW 3 MHz Mode Auto Sweep Count 500/500 IPK View M1[1] -1.98 dBm 2.48015920 GHz CF 2.48 GHz 691 pts Span 5.0 MHz Date: 16 MAY 2019 16:56:09</p>



Modulation Type: $\pi/4$ DQPSK	
CH00	<p>Spectrum</p> <p>Ref Level 20.00 dBm Offset 1.00 dB RBW 2 MHz Att 30 dB SWT 1 ms VBW 5 MHz Mode Auto Sweep Count 500/500</p> <p>IPK View</p> <p>M1[1] -1.68 dBm 2.40191320 GHz</p> <p>CF 2.402 GHz 691 pts Span 5.0 MHz</p> <p>Date: 16 MAY 2019 17:25:25</p>
CH39	<p>Spectrum</p> <p>Ref Level 20.00 dBm Offset 1.00 dB RBW 2 MHz Att 30 dB SWT 1 ms VBW 5 MHz Mode Auto Sweep Count 500/500</p> <p>IPK View</p> <p>M1[1] -2.92 dBm 2.44084080 GHz</p> <p>CF 2.441 GHz 691 pts Span 5.0 MHz</p> <p>Date: 16 MAY 2019 17:26:20</p>
CH78	<p>Spectrum</p> <p>Ref Level 20.00 dBm Offset 1.00 dB RBW 2 MHz Att 30 dB SWT 1 ms VBW 5 MHz Mode Auto Sweep Count 500/500</p> <p>IPK View</p> <p>M1[1] -5.21 dBm 2.47985530 GHz</p> <p>CF 2.48 GHz 691 pts Span 5.0 MHz</p> <p>Date: 16 MAY 2019 17:28:24</p>

Modulation Type: 8DPSK	
CH00	<p>Spectrum</p> <p>Ref Level 20.00 dBm Offset 1.00 dB RBW 2 MHz Att 30 dB SWT 1 ms VBW 5 MHz Mode Auto Sweep Count 500/500</p> <p>IPK View</p> <p>M1[1] -2.04 dBm 2.40205790 GHz</p> <p>CF 2.402 GHz 691 pts Span 5.0 MHz</p> <p>Date: 20 MAY 2019 18:28:41</p>
CH39	<p>Spectrum</p> <p>Ref Level 20.00 dBm Offset 1.00 dB RBW 2 MHz Att 30 dB SWT 1 ms VBW 5 MHz Mode Auto Sweep Count 500/500</p> <p>IPK View</p> <p>M1[1] -3.52 dBm 2.44102170 GHz</p> <p>CF 2.441 GHz 691 pts Span 5.0 MHz</p> <p>Date: 20 MAY 2019 18:30:27</p>
CH78	<p>Spectrum</p> <p>Ref Level 20.00 dBm Offset 1.00 dB RBW 2 MHz Att 30 dB SWT 1 ms VBW 5 MHz Mode Auto Sweep Count 500/500</p> <p>IPK View</p> <p>M1[1] -5.75 dBm 2.48007960 GHz</p> <p>CF 2.48 GHz 691 pts Span 5.0 MHz</p> <p>Date: 20 MAY 2019 18:31:41</p>

## 5.4. 20 dB Bandwidth

### LIMIT

N/A

### TEST CONFIGURATION

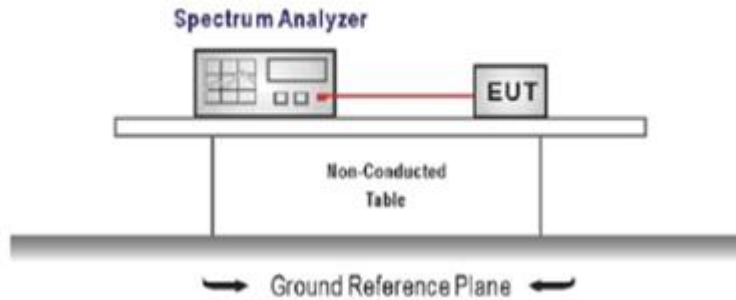

### TEST PROCEDURE

1. The transmitter output was connected to the spectrum analyzer through an attenuator, the path loss was compensated to the results for each measurement.
2. Set to the maximum power setting and enable the EUT transmit continuously
3. Use the following spectrum analyzer settings:  
Span = approximately 2 to 3 times the 20 dB bandwidth, centered on a hopping channel  
RBW  $\geq$  1% of the 20 dB bandwidth, VBW  $\geq$  RBW  
Sweep = auto, Detector function = peak, Trace = max hold
4. Measure and record the results in the test report.

### TEST MODE:

Please refer to the clause 3.3

### TEST RESULTS

 Passed       Not Applicable

Modulation type	Channel	20 dB Bandwidth (MHz)	Limit (MHz)	Result
GFSK	00	0.93	-	Pass
	39	0.93		
	78	0.93		
$\pi/4$ DQPSK	00	1.39	-	Pass
	39	1.39		
	78	1.39		
8DPSK	00	1.38	-	Pass
	39	1.39		
	78	1.40		

Modulation Type:		GFSK																												
CH00	<p>Ref Level 20.00 dBm Offset 1.00 dB RBW 10 kHz Att 30 dB SWT 189.6 μs VBW 30 kHz Mode Auto FFT Count 500/500 IPK View CF 2.402 GHz 1001 pts Span 2.5 MHz</p> <table border="1"> <thead> <tr> <th>Type</th> <th>Ref</th> <th>Trc</th> <th>X-value</th> <th>Y-value</th> <th>Function</th> <th>Function Result</th> </tr> </thead> <tbody> <tr> <td>M1</td> <td></td> <td>1</td> <td>2.40155 GHz</td> <td>-23.82 dBm</td> <td></td> <td></td> </tr> <tr> <td>M2</td> <td></td> <td>1</td> <td>2.40206 GHz</td> <td>-3.50 dBm</td> <td></td> <td></td> </tr> <tr> <td>D3</td> <td>M1</td> <td>1</td> <td>927.5 kHz</td> <td>-0.71 dB</td> <td></td> <td></td> </tr> </tbody> </table> <p>Date: 16 MAY 2019 16:29:07</p>		Type	Ref	Trc	X-value	Y-value	Function	Function Result	M1		1	2.40155 GHz	-23.82 dBm			M2		1	2.40206 GHz	-3.50 dBm			D3	M1	1	927.5 kHz	-0.71 dB		
Type	Ref	Trc	X-value	Y-value	Function	Function Result																								
M1		1	2.40155 GHz	-23.82 dBm																										
M2		1	2.40206 GHz	-3.50 dBm																										
D3	M1	1	927.5 kHz	-0.71 dB																										
CH39	<p>Ref Level 20.00 dBm Offset 1.00 dB RBW 10 kHz Att 30 dB SWT 189.6 μs VBW 30 kHz Mode Auto FFT Count 500/500 IPK View CF 2.441 GHz 1001 pts Span 2.5 MHz</p> <table border="1"> <thead> <tr> <th>Type</th> <th>Ref</th> <th>Trc</th> <th>X-value</th> <th>Y-value</th> <th>Function</th> <th>Function Result</th> </tr> </thead> <tbody> <tr> <td>M1</td> <td></td> <td>1</td> <td>2.4405525 GHz</td> <td>-26.17 dBm</td> <td></td> <td></td> </tr> <tr> <td>M2</td> <td></td> <td>1</td> <td>2.441065 GHz</td> <td>-5.52 dBm</td> <td></td> <td></td> </tr> <tr> <td>D3</td> <td>M1</td> <td>1</td> <td>927.5 kHz</td> <td>0.36 dB</td> <td></td> <td></td> </tr> </tbody> </table> <p>Date: 16 MAY 2019 16:24:49</p>		Type	Ref	Trc	X-value	Y-value	Function	Function Result	M1		1	2.4405525 GHz	-26.17 dBm			M2		1	2.441065 GHz	-5.52 dBm			D3	M1	1	927.5 kHz	0.36 dB		
Type	Ref	Trc	X-value	Y-value	Function	Function Result																								
M1		1	2.4405525 GHz	-26.17 dBm																										
M2		1	2.441065 GHz	-5.52 dBm																										
D3	M1	1	927.5 kHz	0.36 dB																										
CH78	<p>Ref Level 20.00 dBm Offset 1.00 dB RBW 10 kHz Att 30 dB SWT 189.6 μs VBW 30 kHz Mode Auto FFT Count 500/500 IPK View CF 2.48 GHz 1001 pts Span 2.5 MHz</p> <table border="1"> <thead> <tr> <th>Type</th> <th>Ref</th> <th>Trc</th> <th>X-value</th> <th>Y-value</th> <th>Function</th> <th>Function Result</th> </tr> </thead> <tbody> <tr> <td>M1</td> <td></td> <td>1</td> <td>2.4795575 GHz</td> <td>-28.40 dBm</td> <td></td> <td></td> </tr> <tr> <td>M2</td> <td></td> <td>1</td> <td>2.48007 GHz</td> <td>-7.65 dBm</td> <td></td> <td></td> </tr> <tr> <td>D3</td> <td>M1</td> <td>1</td> <td>927.5 kHz</td> <td>0.25 dB</td> <td></td> <td></td> </tr> </tbody> </table> <p>Date: 16 MAY 2019 16:26:00</p>		Type	Ref	Trc	X-value	Y-value	Function	Function Result	M1		1	2.4795575 GHz	-28.40 dBm			M2		1	2.48007 GHz	-7.65 dBm			D3	M1	1	927.5 kHz	0.25 dB		
Type	Ref	Trc	X-value	Y-value	Function	Function Result																								
M1		1	2.4795575 GHz	-28.40 dBm																										
M2		1	2.48007 GHz	-7.65 dBm																										
D3	M1	1	927.5 kHz	0.25 dB																										

Modulation Type:		$\pi/4$ DQPSK																																
CH00	<p><b>Spectrum</b>                  Ref Level 20.00 dBm Offset 1.00 dB RBW 30 kHz                  Att 30 dB SWT 63.1 <math>\mu</math>s VBW 100 kHz Mode Auto FFT                  Count 500/500                  IPK View</p> <p>CF 2.402 GHz 1001 pts Span 2.5 MHz</p> <table border="1"> <thead> <tr> <th>Marker</th> <th>Type</th> <th>Ref</th> <th>Trc</th> <th>X-value</th> <th>Y-value</th> <th>Function</th> <th>Function Result</th> </tr> </thead> <tbody> <tr> <td>M1</td> <td>M1</td> <td>1</td> <td>1</td> <td>2.4013025 GHz</td> <td>-30.35 dBm</td> <td></td> <td></td> </tr> <tr> <td>M2</td> <td>M1</td> <td>1</td> <td>1</td> <td>2.40182 GHz</td> <td>-10.07 dBm</td> <td></td> <td></td> </tr> <tr> <td>D3</td> <td>M1</td> <td>1</td> <td>1</td> <td>1.3925 MHz</td> <td>-0.37 dB</td> <td></td> <td></td> </tr> </tbody> </table> <p>Date: 16 MAY 2019 17:25:06</p>		Marker	Type	Ref	Trc	X-value	Y-value	Function	Function Result	M1	M1	1	1	2.4013025 GHz	-30.35 dBm			M2	M1	1	1	2.40182 GHz	-10.07 dBm			D3	M1	1	1	1.3925 MHz	-0.37 dB		
Marker	Type	Ref	Trc	X-value	Y-value	Function	Function Result																											
M1	M1	1	1	2.4013025 GHz	-30.35 dBm																													
M2	M1	1	1	2.40182 GHz	-10.07 dBm																													
D3	M1	1	1	1.3925 MHz	-0.37 dB																													
CH39	<p><b>Spectrum</b>                  Ref Level 20.00 dBm Offset 1.00 dB RBW 30 kHz                  Att 30 dB SWT 63.1 <math>\mu</math>s VBW 100 kHz Mode Auto FFT                  Count 500/500                  IPK View</p> <p>CF 2.441 GHz 1001 pts Span 2.5 MHz</p> <table border="1"> <thead> <tr> <th>Marker</th> <th>Type</th> <th>Ref</th> <th>Trc</th> <th>X-value</th> <th>Y-value</th> <th>Function</th> <th>Function Result</th> </tr> </thead> <tbody> <tr> <td>M1</td> <td>M1</td> <td>1</td> <td>1</td> <td>2.44031 GHz</td> <td>-31.36 dBm</td> <td></td> <td></td> </tr> <tr> <td>M2</td> <td>M1</td> <td>1</td> <td>1</td> <td>2.440825 GHz</td> <td>-11.24 dBm</td> <td></td> <td></td> </tr> <tr> <td>D3</td> <td>M1</td> <td>1</td> <td>1</td> <td>1.39 MHz</td> <td>-0.57 dB</td> <td></td> <td></td> </tr> </tbody> </table> <p>Date: 16 MAY 2019 17:26:41</p>		Marker	Type	Ref	Trc	X-value	Y-value	Function	Function Result	M1	M1	1	1	2.44031 GHz	-31.36 dBm			M2	M1	1	1	2.440825 GHz	-11.24 dBm			D3	M1	1	1	1.39 MHz	-0.57 dB		
Marker	Type	Ref	Trc	X-value	Y-value	Function	Function Result																											
M1	M1	1	1	2.44031 GHz	-31.36 dBm																													
M2	M1	1	1	2.440825 GHz	-11.24 dBm																													
D3	M1	1	1	1.39 MHz	-0.57 dB																													
CH78	<p><b>Spectrum</b>                  Ref Level 20.00 dBm Offset 1.00 dB RBW 30 kHz                  Att 30 dB SWT 63.1 <math>\mu</math>s VBW 100 kHz Mode Auto FFT                  Count 500/500                  IPK View</p> <p>CF 2.48 GHz 1001 pts Span 2.5 MHz</p> <table border="1"> <thead> <tr> <th>Marker</th> <th>Type</th> <th>Ref</th> <th>Trc</th> <th>X-value</th> <th>Y-value</th> <th>Function</th> <th>Function Result</th> </tr> </thead> <tbody> <tr> <td>M1</td> <td>M1</td> <td>1</td> <td>1</td> <td>2.479315 GHz</td> <td>-33.58 dBm</td> <td></td> <td></td> </tr> <tr> <td>M2</td> <td>M1</td> <td>1</td> <td>1</td> <td>2.47983 GHz</td> <td>-13.58 dBm</td> <td></td> <td></td> </tr> <tr> <td>D3</td> <td>M1</td> <td>1</td> <td>1</td> <td>1.39 MHz</td> <td>-0.79 dB</td> <td></td> <td></td> </tr> </tbody> </table> <p>Date: 16 MAY 2019 17:28:05</p>		Marker	Type	Ref	Trc	X-value	Y-value	Function	Function Result	M1	M1	1	1	2.479315 GHz	-33.58 dBm			M2	M1	1	1	2.47983 GHz	-13.58 dBm			D3	M1	1	1	1.39 MHz	-0.79 dB		
Marker	Type	Ref	Trc	X-value	Y-value	Function	Function Result																											
M1	M1	1	1	2.479315 GHz	-33.58 dBm																													
M2	M1	1	1	2.47983 GHz	-13.58 dBm																													
D3	M1	1	1	1.39 MHz	-0.79 dB																													

Modulation Type:		8DPSK																												
CH00	<p><b>Marker</b></p> <table border="1"> <thead> <tr> <th>Type</th> <th>Ref</th> <th>Trc</th> <th>X-value</th> <th>Y-value</th> <th>Function</th> <th>Function Result</th> </tr> </thead> <tbody> <tr> <td>M1</td> <td></td> <td>1</td> <td>2.4013325 GHz</td> <td>-30.73 dBm</td> <td></td> <td></td> </tr> <tr> <td>M2</td> <td></td> <td>1</td> <td>2.4019725 GHz</td> <td>-10.72 dBm</td> <td></td> <td></td> </tr> <tr> <td>D3</td> <td>M1</td> <td>1</td> <td>1.38 MHz</td> <td>0.01 dB</td> <td></td> <td></td> </tr> </tbody> </table> <p>Date: 20 MAY 2019 18:28:31</p>		Type	Ref	Trc	X-value	Y-value	Function	Function Result	M1		1	2.4013325 GHz	-30.73 dBm			M2		1	2.4019725 GHz	-10.72 dBm			D3	M1	1	1.38 MHz	0.01 dB		
Type	Ref	Trc	X-value	Y-value	Function	Function Result																								
M1		1	2.4013325 GHz	-30.73 dBm																										
M2		1	2.4019725 GHz	-10.72 dBm																										
D3	M1	1	1.38 MHz	0.01 dB																										
CH39	<p><b>Marker</b></p> <table border="1"> <thead> <tr> <th>Type</th> <th>Ref</th> <th>Trc</th> <th>X-value</th> <th>Y-value</th> <th>Function</th> <th>Function Result</th> </tr> </thead> <tbody> <tr> <td>M1</td> <td></td> <td>1</td> <td>2.440335 GHz</td> <td>-32.20 dBm</td> <td></td> <td></td> </tr> <tr> <td>M2</td> <td></td> <td>1</td> <td>2.4409775 GHz</td> <td>-12.14 dBm</td> <td></td> <td></td> </tr> <tr> <td>D3</td> <td>M1</td> <td>1</td> <td>1.385 MHz</td> <td>-0.10 dB</td> <td></td> <td></td> </tr> </tbody> </table> <p>Date: 20 MAY 2019 18:28:18</p>		Type	Ref	Trc	X-value	Y-value	Function	Function Result	M1		1	2.440335 GHz	-32.20 dBm			M2		1	2.4409775 GHz	-12.14 dBm			D3	M1	1	1.385 MHz	-0.10 dB		
Type	Ref	Trc	X-value	Y-value	Function	Function Result																								
M1		1	2.440335 GHz	-32.20 dBm																										
M2		1	2.4409775 GHz	-12.14 dBm																										
D3	M1	1	1.385 MHz	-0.10 dB																										
CH78	<p><b>Marker</b></p> <table border="1"> <thead> <tr> <th>Type</th> <th>Ref</th> <th>Trc</th> <th>X-value</th> <th>Y-value</th> <th>Function</th> <th>Function Result</th> </tr> </thead> <tbody> <tr> <td>M1</td> <td></td> <td>1</td> <td>2.479335 GHz</td> <td>-34.50 dBm</td> <td></td> <td></td> </tr> <tr> <td>M2</td> <td></td> <td>1</td> <td>2.480165 GHz</td> <td>-14.31 dBm</td> <td></td> <td></td> </tr> <tr> <td>D3</td> <td>M1</td> <td>1</td> <td>1.3975 MHz</td> <td>0.18 dB</td> <td></td> <td></td> </tr> </tbody> </table> <p>Date: 20 MAY 2019 18:31:32</p>		Type	Ref	Trc	X-value	Y-value	Function	Function Result	M1		1	2.479335 GHz	-34.50 dBm			M2		1	2.480165 GHz	-14.31 dBm			D3	M1	1	1.3975 MHz	0.18 dB		
Type	Ref	Trc	X-value	Y-value	Function	Function Result																								
M1		1	2.479335 GHz	-34.50 dBm																										
M2		1	2.480165 GHz	-14.31 dBm																										
D3	M1	1	1.3975 MHz	0.18 dB																										

### 5.5. Carrier Frequencies Separation

#### LIMIT

FCC CFR Title 47 Part 15 Subpart C Section 15.247 (a)(1):

Frequency hopping systems shall have hopping channel carrier frequencies separated by a minimum of 25 kHz or the 20 dB bandwidth of the hopping channel, whichever is greater. Alternatively, Frequency hopping systems operating in the 2400-2483.5 MHz band may have hopping channel carrier frequencies that are separated by 25 kHz or two-thirds of the 20 dB bandwidth of the hopping channel, whichever is greater, provided the systems operate with an output power no greater than 125 mW.

#### TEST CONFIGURATION

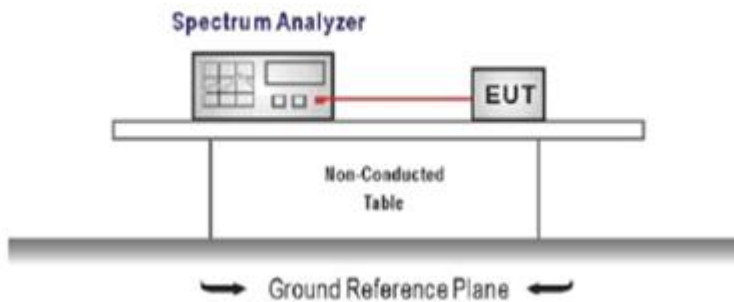

#### TEST PROCEDURE

1. The transmitter output was connected to the spectrum analyzer through an attenuator, the path loss was compensated to the results for each measurement.
2. Set to the maximum power setting and enable the EUT transmit continuously
3. Use the following spectrum analyzer settings:  
 Span = wide enough to capture the peaks of two adjacent channels  
 RBW ≥ 1% of the span, VBW ≥ RBW  
 Sweep = auto, Detector function = peak, Trace = max hold
4. Measure and record the results in the test report.

#### TEST MODE:

Please refer to the clause 3.3

#### TEST RESULTS

Passed       Not Applicable

Modulation type	Channel	Carrier Frequencies Separation (MHz)	Limit (MHz) *	Result
GFSK	39	1.00	≥0.93	Pass
π/4DQPSK	39	1.00	≥0.93	Pass
8DPSK	39	1.00	≥0.93	Pass

Note:

\*: GFSK limit = The maximum 20 dB Bandwidth for GFSK modulation on the section 5.4.

π/4DQPSK limit = 2/3 \* The maximum 20 dB Bandwidth for π/4DQPSK modulation on the section 5.4.

8DPSK limit = 2/3 \* The maximum 20 dB Bandwidth for 8DPSK modulation on the section 5.4

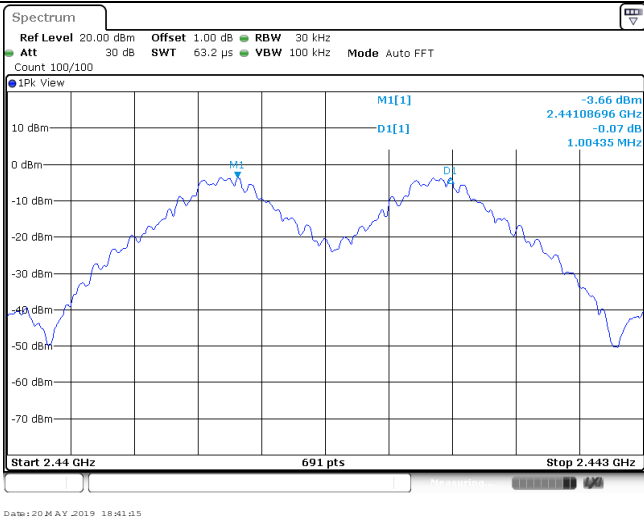
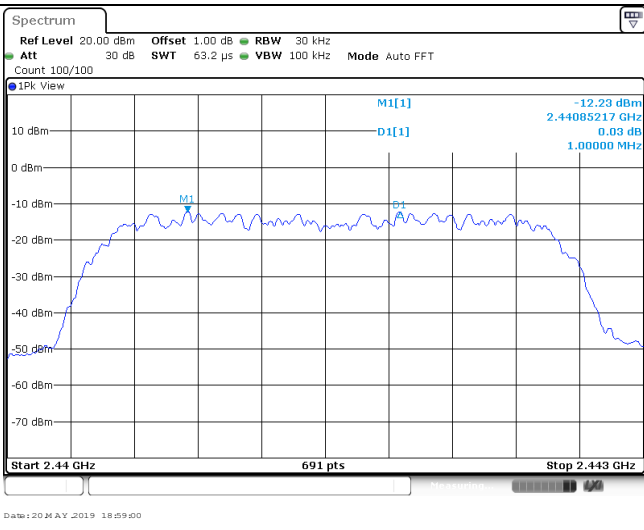
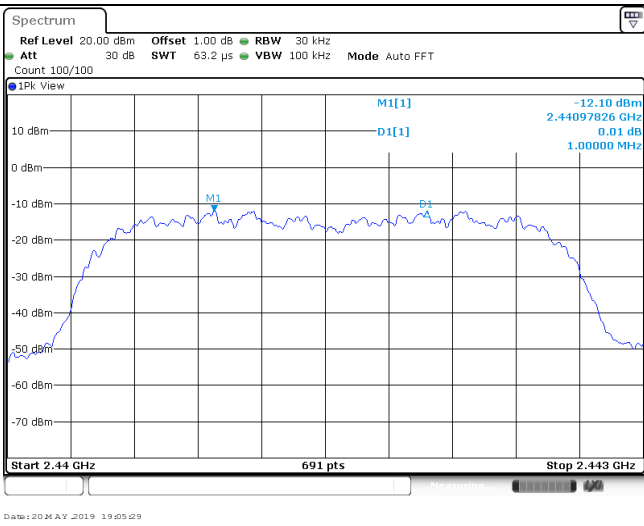
<p>GFSK</p>	 <p>Spectrum</p> <p>Ref Level 20.00 dBm Offset 1.00 dB RBW 30 kHz Att 30 dB SWT 63.2 μs VBW 100 kHz Mode Auto FFT Count 100/100</p> <p>1Pk View</p> <p>M1[1] -3.66 dBm 2.44108696 GHz -0.07 dB 1.00435 MHz</p> <p>D1[1]</p> <p>Start 2.44 GHz 691 pts Stop 2.443 GHz</p> <p>Date: 20 May 2019 18:41:15</p>
<p><math>\pi/4</math>DQPSK</p>	 <p>Spectrum</p> <p>Ref Level 20.00 dBm Offset 1.00 dB RBW 30 kHz Att 30 dB SWT 63.2 μs VBW 100 kHz Mode Auto FFT Count 100/100</p> <p>1Pk View</p> <p>M1[1] -12.23 dBm 2.44085217 GHz 0.03 dB 1.00000 MHz</p> <p>D1[1]</p> <p>Start 2.44 GHz 691 pts Stop 2.443 GHz</p> <p>Date: 20 May 2019 18:59:00</p>
<p>8DPSK</p>	 <p>Spectrum</p> <p>Ref Level 20.00 dBm Offset 1.00 dB RBW 30 kHz Att 30 dB SWT 63.2 μs VBW 100 kHz Mode Auto FFT Count 100/100</p> <p>1Pk View</p> <p>M1[1] -12.10 dBm 2.44097826 GHz 0.01 dB 1.00000 MHz</p> <p>D1[1]</p> <p>Start 2.44 GHz 691 pts Stop 2.443 GHz</p> <p>Date: 20 May 2019 19:05:29</p>



### 5.6. Hopping Channel Number

#### LIMIT

FCC CFR Title 47 Part 15 Subpart C Section 15.247 (a)(1):Frequency hopping systems in the 2400–2483.5 MHz band shall use at least **15** channels.

#### TEST CONFIGURATION

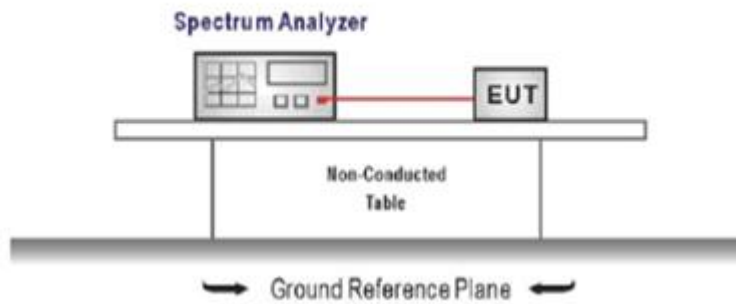

#### TEST PROCEDURE

1. The transmitter output was connected to the spectrum analyzer through an attenuator, the path loss was compensated to the results for each measurement.
2. Set to the maximum power setting and enable the EUT transmit continuously
3. Use the following spectrum analyzer settings:  
 Span = the frequency band of operation  
 RBW  $\geq$  1% of the span, VBW  $\geq$  RBW  
 Sweep = auto, Detector function = peak, Trace = max hold
4. Measure and record the results in the test report.

#### TEST MODE:

Please refer to the clause 3.3

#### TEST RESULTS

Passed       Not Applicable

Modulation type	Channel number	Limit	Result
GFSK	79	$\geq 15.00$	Pass
$\pi/4$ DQPSK	79		
8DPSK	79		

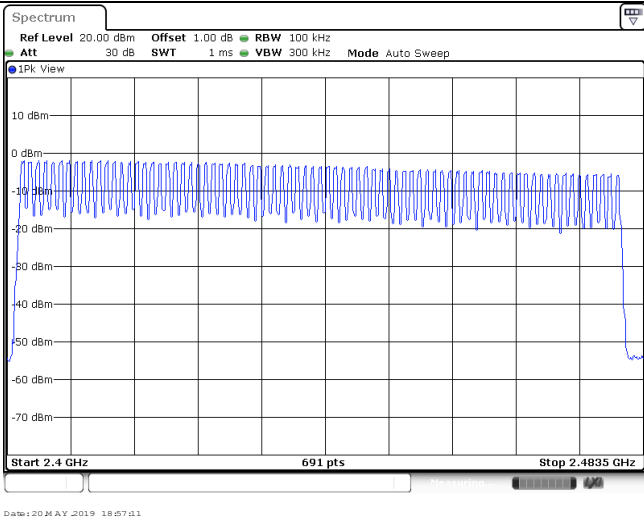
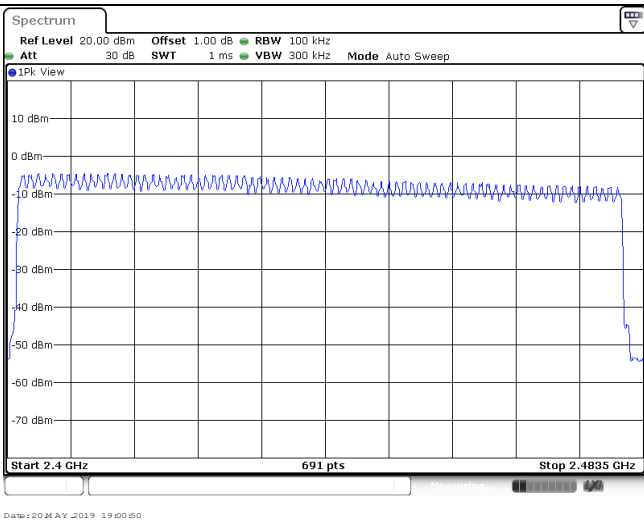
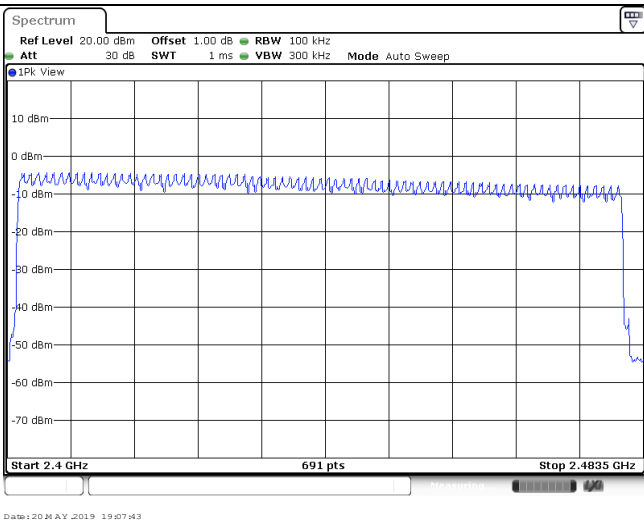
<p>GFSK</p>	
<p><math>\pi/4</math>DQPSK</p>	
<p>8DPSK</p>	

### 5.7. Dwell Time

#### LIMIT

FCC CFR Title 47 Part 15 Subpart C Section 15.247 (a)(1):The average time of occupancy on any channel shall not be greater than 0.4 seconds within a pe-riod of 0.4 seconds multiplied by the number of hopping channels employed.

#### TEST CONFIGURATION

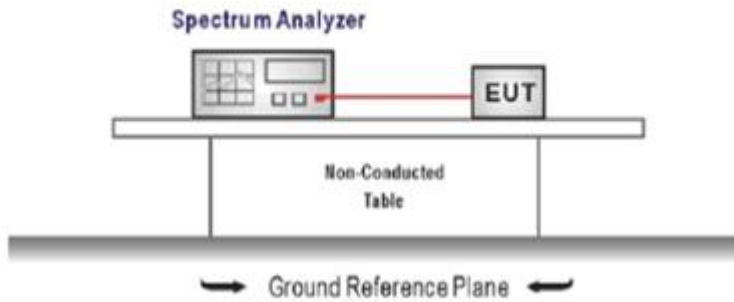

#### TEST PROCEDURE

1. The transmitter output was connected to the spectrum analyzer through an attenuator, the path loss was compensated to the results for each measurement.
2. Set to the maximum power setting and enable the EUT transmit continuously
3. Use the following spectrum analyzer settings:  
 Span = zero span, centered on a hopping channel, RBW= 1 MHz, VBW ≥ RBW  
 Sweep = as necessary to capture the entire dwell time per hopping channel,  
 Detector function = peak, Trace = max hold
4. Measure and record the results in the test report.

#### TEST MODE:

Please refer to the clause 3.3

#### TEST RESULTS

Passed       Not Applicable

Modulation type	Channel	Burst Width [ms/hop/ch]	Total Hops[hop*ch]	Dwell time (Second)	Limit (Second)	Result
GFSK	DH1	0.38	313.00	0.12	≤ 0.40	Pass
	DH3	1.64	150.00	0.25		
	DH5	2.89	108.00	0.31		
π/4DQPSK	2DH1	0.39	321.00	0.13	≤ 0.40	Pass
	2DH3	1.64	158.00	0.26		
	2DH5	2.89	101.00	0.29		
8DPSK	3DH1	0.39	316.00	0.12	≤ 0.40	Pass
	3DH3	1.64	160.00	0.26		
	3DH5	2.89	106.00	0.31		

<b>Modulation Type:</b>	<b>GFSK</b>
-------------------------	-------------

DH1  
Burst width

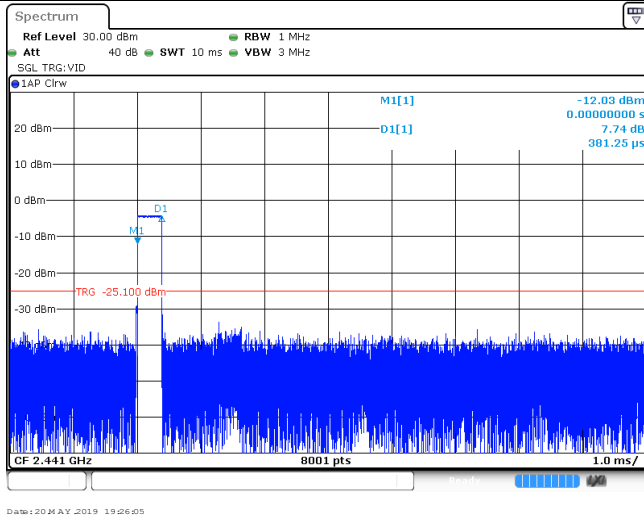

DH1  
Burst number

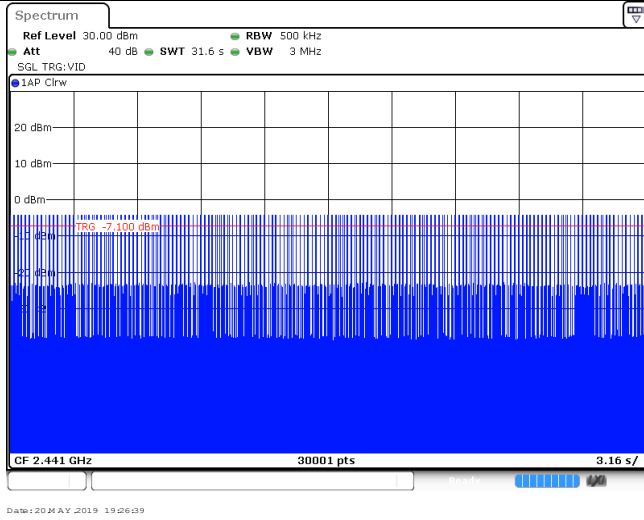

DH3  
Burst width

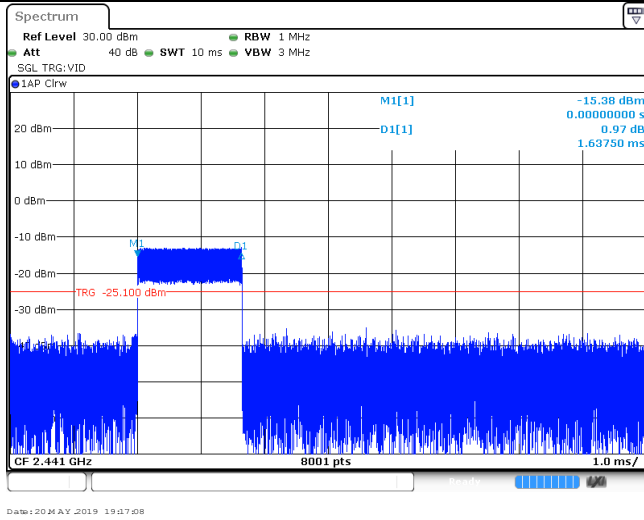

DH3  
Burst number

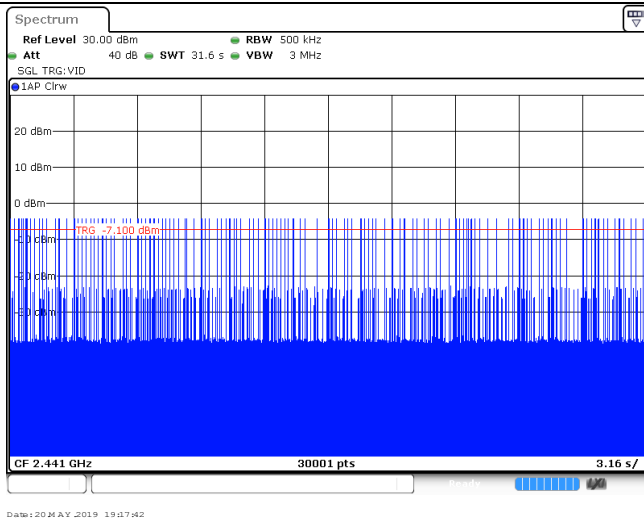

DH5  
Burst width

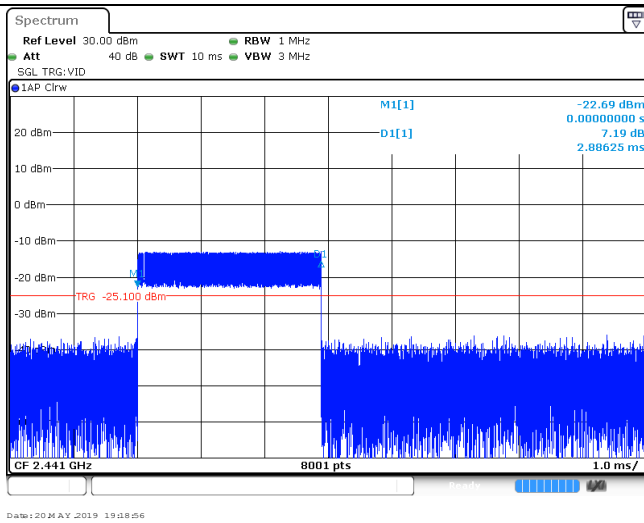

DH5  
Burst number

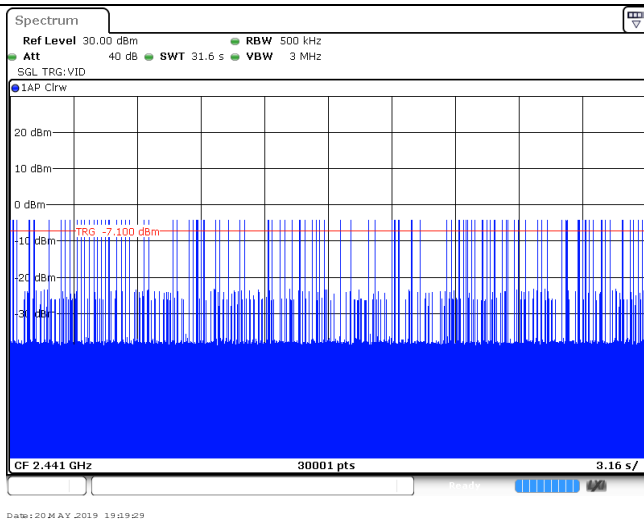

Modulation Type:		$\pi/4$ DQPSK
2DH1 Burst width		
2DH1 Burst number		
2DH3 Burst width		

2DH3  
Burst number

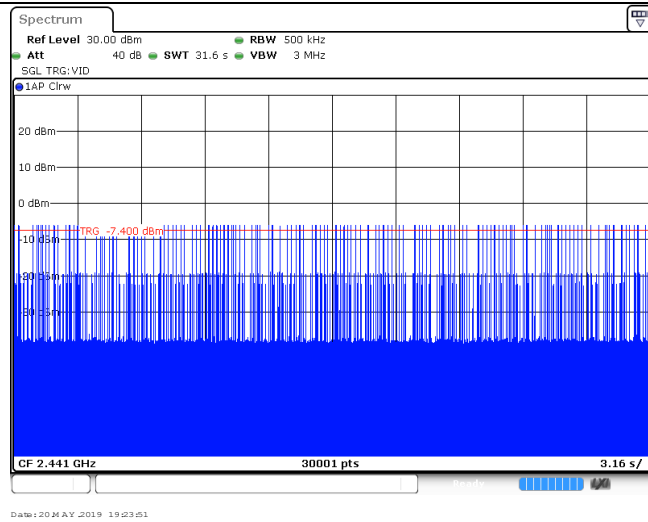

2DH5  
Burst width

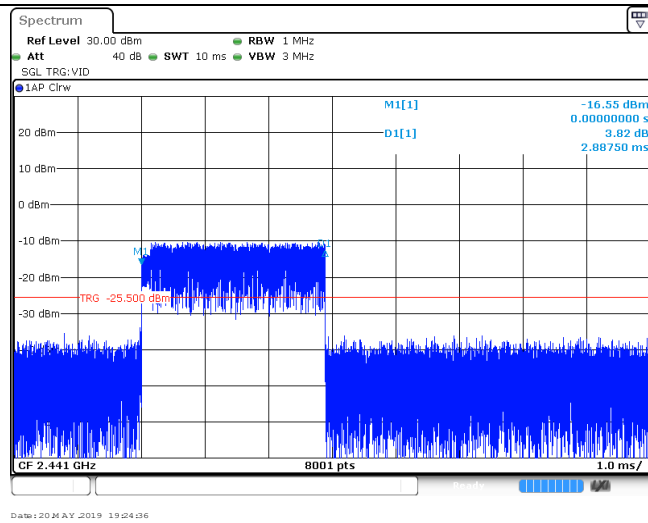

2DH5  
Burst number

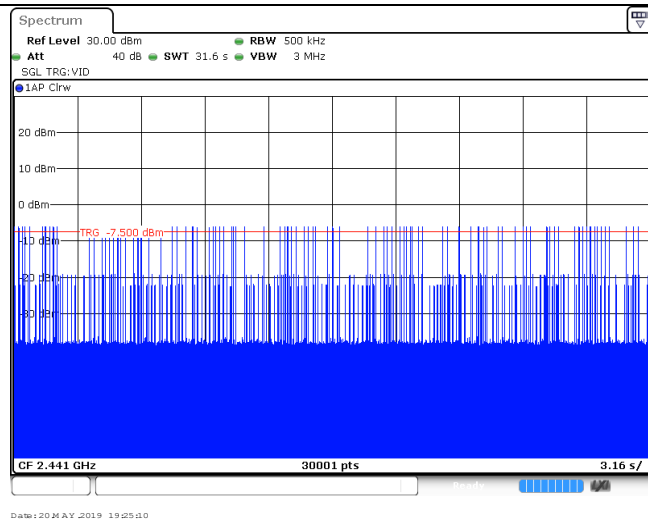

Modulation Type: $\pi/4$ DQPSK	
3DH1 Burst width	<p>Spectrum</p> <p>Ref Level 30.00 dBm   RBW 1 MHz Att 40 dB   SWT 10 ms   VBW 3 MHz</p> <p>SGL TRG:VID</p> <p>IAP Cirw</p> <p>M1[1] -17.60 dBm 0.00000000 s D1[1] 1.62 dB 387.50 ps</p> <p>TRG -25.100 dBm</p> <p>CF 2.441 GHz   8001 pts   1.0 ms/</p> <p>Date: 20 MAY 2019 19:36:53</p>
3DH1 Burst number	<p>Spectrum</p> <p>Ref Level 30.00 dBm   RBW 500 kHz Att 40 dB   SWT 31.6 s   VBW 3 MHz</p> <p>SGL TRG:VID</p> <p>IAP Cirw</p> <p>TRG -7.100 dBm</p> <p>CF 2.441 GHz   30001 pts   3.16 s/</p> <p>Date: 20 MAY 2019 19:37:26</p>
3DH3 Burst width	<p>Spectrum</p> <p>Ref Level 30.00 dBm   RBW 1 MHz Att 40 dB   SWT 10 ms   VBW 3 MHz</p> <p>SGL TRG:VID</p> <p>IAP Cirw</p> <p>M1[1] -18.06 dBm -462.50 ps D1[1] 1.59 dB 1.639875 ms</p> <p>TRG -25.000 dBm</p> <p>CF 2.441 GHz   8001 pts   1.0 ms/</p> <p>Date: 20 MAY 2019 19:38:13</p>



3DH3  
Burst number

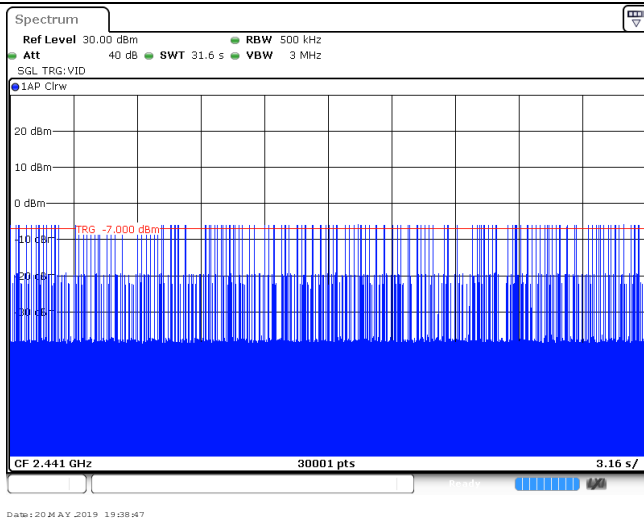

3DH5  
Burst width

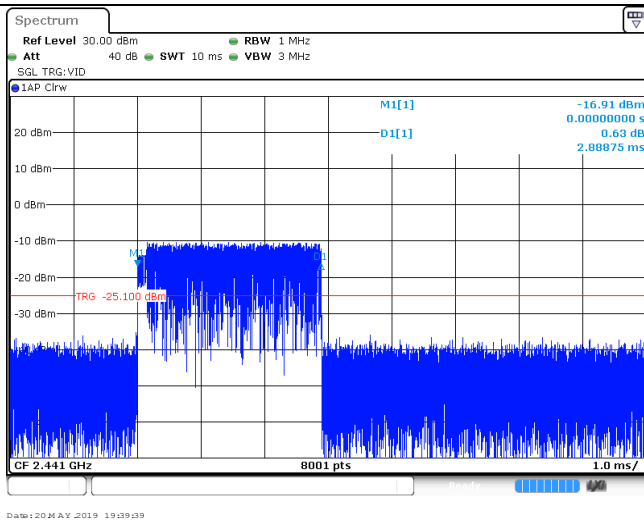

3DH5  
Burst number

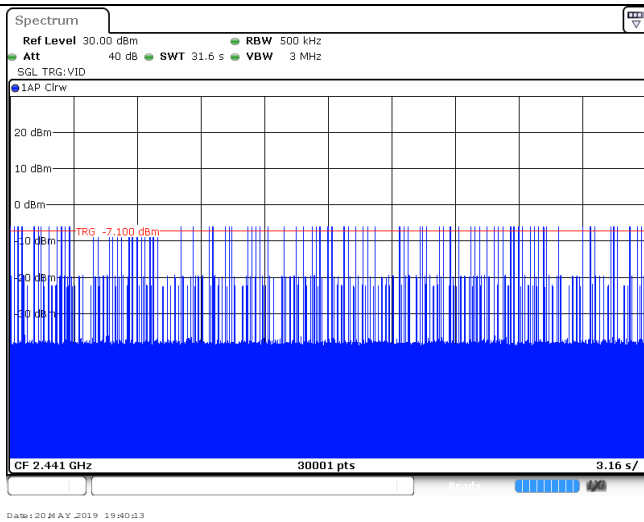

### 5.8. Pseudorandom Frequency Hopping Sequence

#### LIMIT

FCC CFR Title 47 Part 15 Subpart C Section 15.247 (a)(1):Frequency hopping systems shall have hopping channel carrier frequencies separated by a minimum of 25 kHz or the 20 dB bandwidth of the hopping channel, whichever is greater. Alternatively, frequency hopping systems operating in the 2400–2483.5 MHz band may have hopping channel carrier frequencies that are separated by 25 kHz or two-thirds of the 20 dB bandwidth of the hopping channel, whichever is greater, provided the systems operate with an output power no greater than 125 mW. The system shall hop to channel frequencies that are selected at the system hopping rate from a pseudo randomly ordered list of hopping frequencies. Each frequency must be used equally on the average by each transmitter. The system receivers shall have input bandwidths that match the hopping channel bandwidths of their corresponding transmitters and shall shift frequencies in synchronization with the transmitted signals.

#### TEST RESULTS

The pseudorandom frequency hopping sequence may be generated in a nine-stage shift register whose 5<sup>th</sup> and 9<sup>th</sup> stage outputs are added in a modulo-two addition stage. And the result is fed back to the input of the first stage. The sequence begins with the first one of 9 consecutive ones, for example: the shift register is initialized with nine ones.

- Number of shift register stages: 9
- Length of pseudo-random sequence:  $2^9 - 1 = 511$  bits
- Longest sequence of zeros: 8 (non-inverted signal)

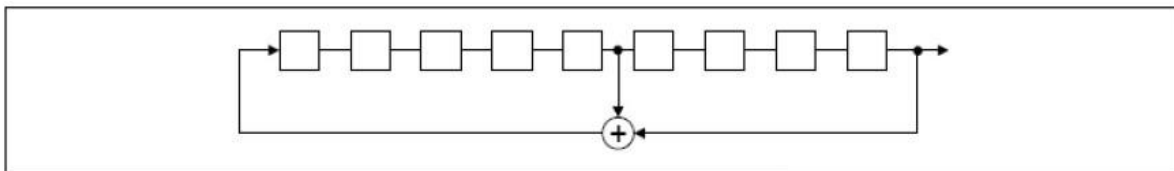

*Linear Feedback Shift Register for Generation of the PRBS sequence*

An example of pseudorandom frequency hopping sequence as follows:

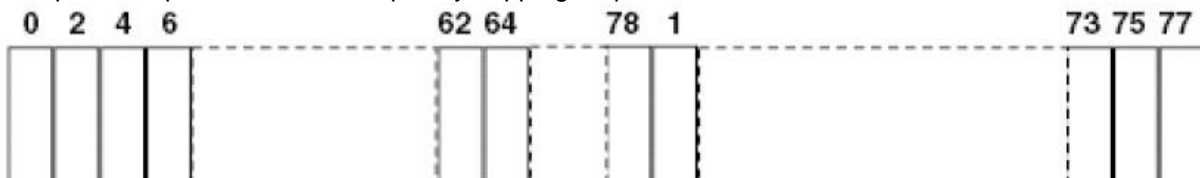

Each frequency used equally on the average by each transmitter. The system receiver has input bandwidths that match the hopping channel bandwidths of their corresponding transmitter and shift frequencies in synchronization with the transmitted signals.

### 5.9. Restricted band (radiated)

#### LIMIT

#### FCC CFR Title 47 Part 15 Subpart C Section 15.247 (d):

In any 100 kHz bandwidth outside the frequency band in which the spread spectrum or digitally modulated intentional radiator is operating, Radiated Emissions which fall in the restricted bands, as defined in §15.205(a), must also comply with the Radiated Emissions limits specified in §15.209(a) (see §15.205(c)).

#### TEST CONFIGURATION

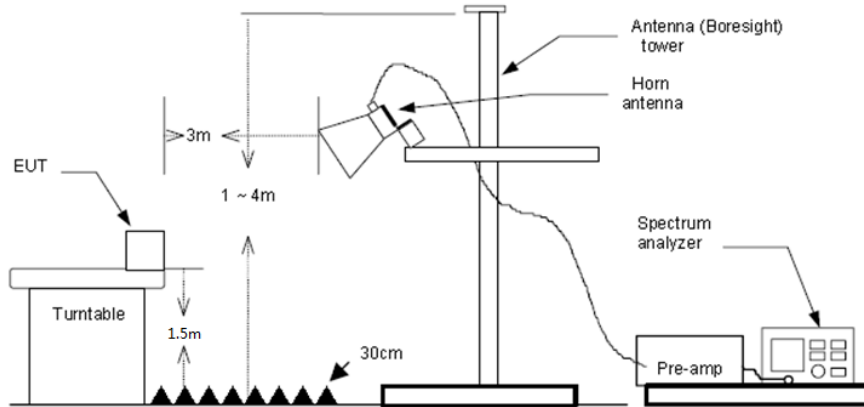

#### TEST PROCEDURE

1. The EUT was setup and tested according to ANSI C63.10:2013 for compliance to FCC 47CFR 15.247 requirements.
2. The EUT is placed on a turn table which is 1.5 meter above ground. The turn table is rotated 360 degrees to determine the position of the maximum emission level.
3. The EUT was positioned such that the distance from antenna to the EUT was 3 meters.
4. The antenna is scanned from 1 meter to 4 meters to find out the maximum emission level. This is repeated for both horizontal and vertical polarization of the antenna. In order to find the maximum emission, all of the interface cables were manipulated according to ANSI C63.10:2013 on radiated measurement.
5. The receiver set as follow:  
 RBW=1 MHz, VBW=3 MHz Peak detector for Peak value  
 RBW=1 MHz, VBW=10 Hz Peak detector for Average value.

#### TEST MODE:

Please refer to the clause 3.3

#### TEST RESULTS

Passed       Not Applicable

#### Note:

- 1) Final level= Read level + Antenna Factor+ Cable Loss- Preamp Factor
- 2) Have pre-scan all modulation mode, found the GFSK modulation which it was worst case, so only the worst case's data on the test report.
- 3) The peak level is lower than average limit(54 dBuV/m), this data is the too weak instrument of signal is unable to test.

Test channel:					CH00				
Frequency (MHz)	Read Level (dBuV)	Antenna Factor (dB/m)	Cable Loss (dB)	Preamp Factor (dB)	Level (dBuV/m)	Limit Line (dBuV/m)	Over Limit (dB)	Polarization	Test value
2310.00	44.90	28.05	7.73	37.59	43.09	74.00	-30.91	Horizontal	Peak
2390.01	45.61	27.65	7.84	37.59	43.51	74.00	-30.49	Horizontal	Peak
2310.00	44.90	28.05	7.73	37.59	43.09	74.00	-30.91	Vertical	Peak
2390.01	45.61	27.65	7.84	37.59	43.51	74.00	-30.49	Vertical	Peak
2310.00	32.56	28.05	7.73	37.59	30.75	54.00	-23.25	Horizontal	Average
2390.01	32.73	27.65	7.84	37.59	30.63	54.00	-23.37	Horizontal	Average
2310.00	32.58	28.05	7.73	37.59	30.77	54.00	-23.23	Vertical	Average
2390.01	32.92	27.65	7.84	37.59	30.82	54.00	-23.18	Vertical	Average

Test channel:					CH78				
Frequency (MHz)	Read Level (dBuV)	Antenna Factor (dB/m)	Cable Loss (dB)	Preamp Factor (dB)	Level (dBuV/m)	Limit Line (dBuV/m)	Over Limit (dB)	Polarization	Test value
2483.50	65.81	27.26	8.04	37.59	63.52	74.00	-10.48	Horizontal	Peak
2500.00	43.92	27.20	8.08	37.59	41.61	74.00	-32.39	Horizontal	Peak
2483.50	66.79	27.26	8.04	37.59	64.50	74.00	-9.50	Vertical	Peak
2500.00	44.10	27.20	8.08	37.59	41.79	74.00	-32.21	Vertical	Peak
2483.50	52.59	27.26	8.04	37.59	50.30	54.00	-3.70	Horizontal	Average
2500.00	32.24	27.20	8.08	37.59	29.93	54.00	-24.07	Horizontal	Average
2483.50	53.49	27.26	8.04	37.59	51.20	54.00	-2.80	Vertical	Average
2499.98	22.31	27.20	8.08	37.59	20.00	54.00	-34.00	Vertical	Average

## 5.10. Band edge and Spurious Emissions (conducted)

### LIMIT

FCC CFR Title 47 Part 15 Subpart C Section 15.247 (d): In any 100 kHz bandwidth outside the frequency band in which the spread spectrum intentional radiator is operating, the radio frequency power that is produced by the intentional radiator shall be at least 20 dB below that in the 100 kHz bandwidth within the band that contains the highest level of the desired power, based on either an RF conducted or a radiated measurement.

### TEST CONFIGURATION

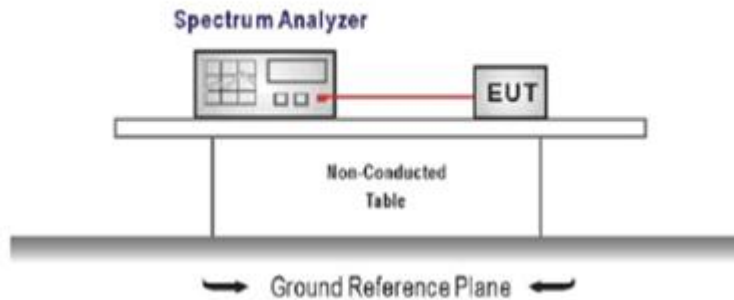

### TEST PROCEDURE

1. The transmitter output was connected to the spectrum analyzer through an attenuator, the path loss was compensated to the results for each measurement.
2. Set to the maximum power setting and enable the EUT transmit continuously
3. Use the following spectrum analyzer settings:  
RBW = 100 kHz, VBW  $\geq$  RBW, scan up through 10<sup>th</sup> harmonic.  
Sweep = auto, Detector function = peak, Trace = max hold
4. Measure and record the results in the test report.

### TEST MODE:

Please refer to the clause 3.3

### TEST RESULTS

Passed       Not Applicable

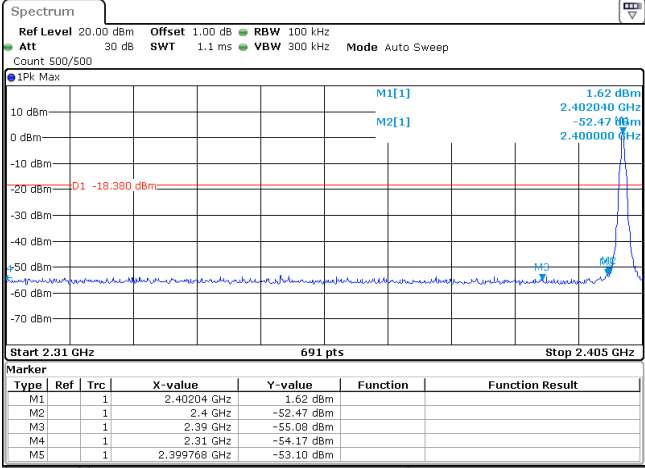
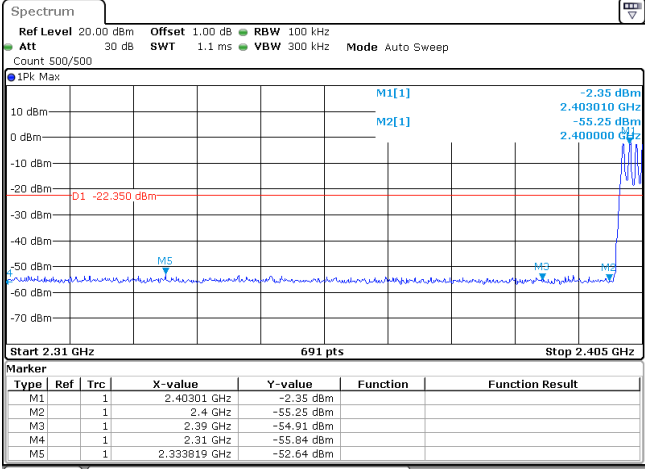
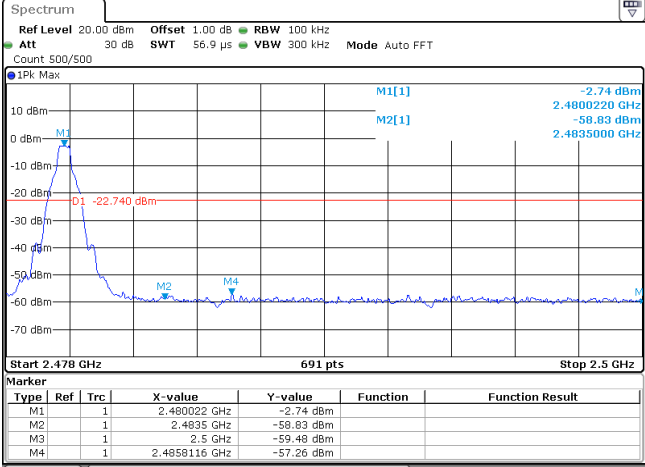
Test Item:	Band edge	Modulation type:	GFSK																																										
<p>CH00 No hopping mode</p>	 <p>Ref Level 20.00 dBm Offset 1.00 dB RBW 100 kHz Att 30 dB SWT 1.1 ms VBW 300 kHz Mode Auto Sweep Count 500/500</p> <p>IPK Max</p> <p>1.62 dBm 2.40204 GHz -52.47 dBm 2.40000 GHz</p> <p>-19.390 dBm</p> <p>Start 2.31 GHz 691 pts Stop 2.405 GHz</p> <table border="1"> <thead> <tr> <th>Type</th> <th>Ref</th> <th>Trc</th> <th>X-value</th> <th>Y-value</th> <th>Function</th> <th>Function Result</th> </tr> </thead> <tbody> <tr> <td>M1</td> <td>1</td> <td></td> <td>2.40204 GHz</td> <td>1.62 dBm</td> <td></td> <td></td> </tr> <tr> <td>M2</td> <td>1</td> <td></td> <td>2.4 GHz</td> <td>-52.47 dBm</td> <td></td> <td></td> </tr> <tr> <td>M3</td> <td>1</td> <td></td> <td>2.39 GHz</td> <td>-55.09 dBm</td> <td></td> <td></td> </tr> <tr> <td>M4</td> <td>1</td> <td></td> <td>2.31 GHz</td> <td>-54.17 dBm</td> <td></td> <td></td> </tr> <tr> <td>M5</td> <td>1</td> <td></td> <td>2.399768 GHz</td> <td>-53.10 dBm</td> <td></td> <td></td> </tr> </tbody> </table> <p>Date: 16 MAY 2019 16:29:30</p>			Type	Ref	Trc	X-value	Y-value	Function	Function Result	M1	1		2.40204 GHz	1.62 dBm			M2	1		2.4 GHz	-52.47 dBm			M3	1		2.39 GHz	-55.09 dBm			M4	1		2.31 GHz	-54.17 dBm			M5	1		2.399768 GHz	-53.10 dBm		
Type	Ref	Trc	X-value	Y-value	Function	Function Result																																							
M1	1		2.40204 GHz	1.62 dBm																																									
M2	1		2.4 GHz	-52.47 dBm																																									
M3	1		2.39 GHz	-55.09 dBm																																									
M4	1		2.31 GHz	-54.17 dBm																																									
M5	1		2.399768 GHz	-53.10 dBm																																									
<p>CH00 Hopping mode</p>	 <p>Ref Level 20.00 dBm Offset 1.00 dB RBW 100 kHz Att 30 dB SWT 1.1 ms VBW 300 kHz Mode Auto Sweep Count 500/500</p> <p>IPK Max</p> <p>-2.35 dBm 2.40301 GHz -55.25 dBm 2.40000 GHz</p> <p>-22.350 dBm</p> <p>Start 2.31 GHz 691 pts Stop 2.405 GHz</p> <table border="1"> <thead> <tr> <th>Type</th> <th>Ref</th> <th>Trc</th> <th>X-value</th> <th>Y-value</th> <th>Function</th> <th>Function Result</th> </tr> </thead> <tbody> <tr> <td>M1</td> <td>1</td> <td></td> <td>2.40301 GHz</td> <td>-2.35 dBm</td> <td></td> <td></td> </tr> <tr> <td>M2</td> <td>1</td> <td></td> <td>2.4 GHz</td> <td>-55.25 dBm</td> <td></td> <td></td> </tr> <tr> <td>M3</td> <td>1</td> <td></td> <td>2.39 GHz</td> <td>-54.91 dBm</td> <td></td> <td></td> </tr> <tr> <td>M4</td> <td>1</td> <td></td> <td>2.31 GHz</td> <td>-55.84 dBm</td> <td></td> <td></td> </tr> <tr> <td>M5</td> <td>1</td> <td></td> <td>2.333819 GHz</td> <td>-52.64 dBm</td> <td></td> <td></td> </tr> </tbody> </table> <p>Date: 20 MAY 2019 18:07:25</p>			Type	Ref	Trc	X-value	Y-value	Function	Function Result	M1	1		2.40301 GHz	-2.35 dBm			M2	1		2.4 GHz	-55.25 dBm			M3	1		2.39 GHz	-54.91 dBm			M4	1		2.31 GHz	-55.84 dBm			M5	1		2.333819 GHz	-52.64 dBm		
Type	Ref	Trc	X-value	Y-value	Function	Function Result																																							
M1	1		2.40301 GHz	-2.35 dBm																																									
M2	1		2.4 GHz	-55.25 dBm																																									
M3	1		2.39 GHz	-54.91 dBm																																									
M4	1		2.31 GHz	-55.84 dBm																																									
M5	1		2.333819 GHz	-52.64 dBm																																									
<p>CH78 No hopping mode</p>	 <p>Ref Level 20.00 dBm Offset 1.00 dB RBW 100 kHz Att 30 dB SWT 56.9 μs VBW 300 kHz Mode Auto FFT Count 500/500</p> <p>IPK Max</p> <p>-2.74 dBm 2.480022 GHz -58.83 dBm 2.4835000 GHz</p> <p>-22.740 dBm</p> <p>Start 2.478 GHz 691 pts Stop 2.5 GHz</p> <table border="1"> <thead> <tr> <th>Type</th> <th>Ref</th> <th>Trc</th> <th>X-value</th> <th>Y-value</th> <th>Function</th> <th>Function Result</th> </tr> </thead> <tbody> <tr> <td>M1</td> <td>1</td> <td></td> <td>2.480022 GHz</td> <td>-2.74 dBm</td> <td></td> <td></td> </tr> <tr> <td>M2</td> <td>1</td> <td></td> <td>2.4835 GHz</td> <td>-58.83 dBm</td> <td></td> <td></td> </tr> <tr> <td>M3</td> <td>1</td> <td></td> <td>2.5 GHz</td> <td>-59.48 dBm</td> <td></td> <td></td> </tr> <tr> <td>M4</td> <td>1</td> <td></td> <td>2.4858116 GHz</td> <td>-57.26 dBm</td> <td></td> <td></td> </tr> </tbody> </table> <p>Date: 16 MAY 2019 16:56:27</p>			Type	Ref	Trc	X-value	Y-value	Function	Function Result	M1	1		2.480022 GHz	-2.74 dBm			M2	1		2.4835 GHz	-58.83 dBm			M3	1		2.5 GHz	-59.48 dBm			M4	1		2.4858116 GHz	-57.26 dBm									
Type	Ref	Trc	X-value	Y-value	Function	Function Result																																							
M1	1		2.480022 GHz	-2.74 dBm																																									
M2	1		2.4835 GHz	-58.83 dBm																																									
M3	1		2.5 GHz	-59.48 dBm																																									
M4	1		2.4858116 GHz	-57.26 dBm																																									

CH78  
Hopping mode

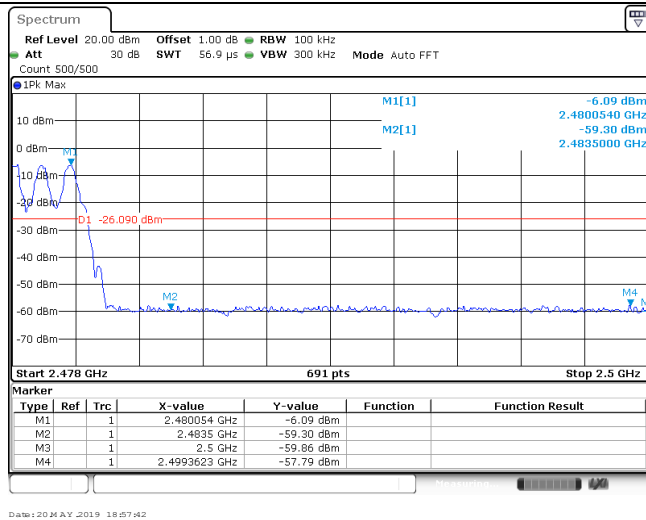

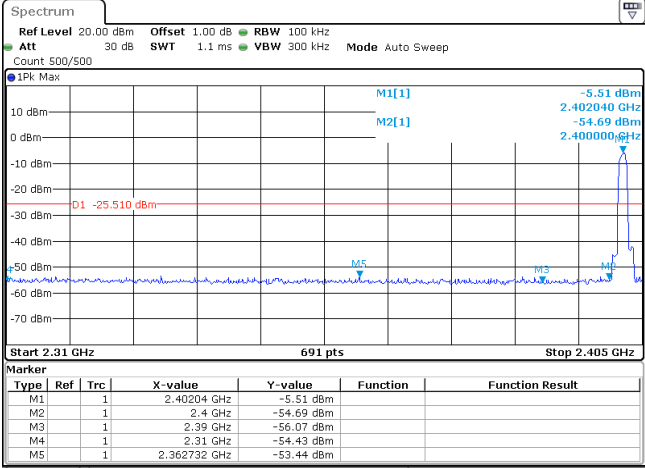
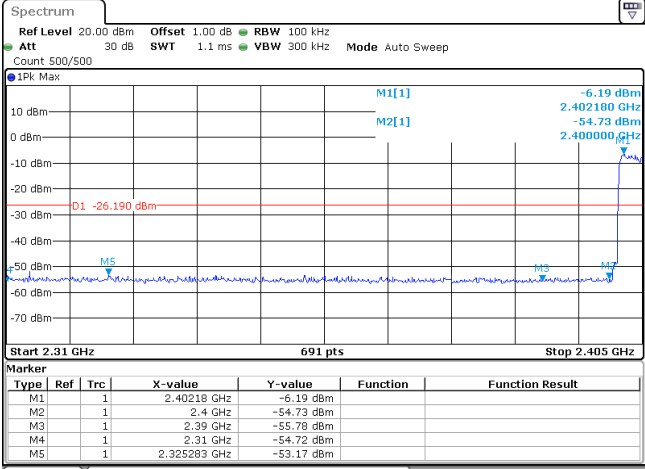
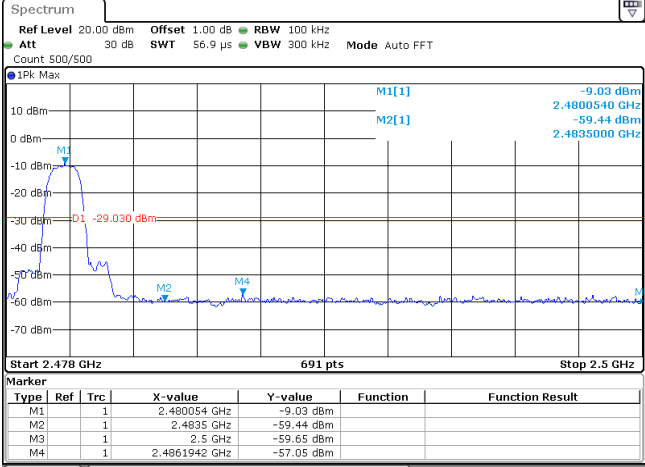
Test Item:	Band edge	Modulation type:	$\pi/4$ DQPSK																																										
<p>CH00 No hopping mode</p>	 <p>Ref Level 20.00 dBm Offset 1.00 dB RBW 100 kHz Att 30 dB SWT 1.1 ms VBW 300 kHz Mode Auto Sweep Count 500/500</p> <p>IPK Max</p> <p>10 dBm M1[1] -5.51 dBm 2.402040 GHz 0 dBm M2[1] -54.69 dBm 2.400000 GHz -10 dBm -20 dBm D1 -25.510 dBm -30 dBm -40 dBm M5 -50 dBm -60 dBm -70 dBm</p> <p>Start 2.31 GHz 691 pts Stop 2.405 GHz</p> <table border="1"> <thead> <tr> <th>Type</th> <th>Ref</th> <th>Trc</th> <th>X-value</th> <th>Y-value</th> <th>Function</th> <th>Function Result</th> </tr> </thead> <tbody> <tr> <td>M1</td> <td>1</td> <td></td> <td>2.40204 GHz</td> <td>-5.51 dBm</td> <td></td> <td></td> </tr> <tr> <td>M2</td> <td>1</td> <td></td> <td>2.4 GHz</td> <td>-54.69 dBm</td> <td></td> <td></td> </tr> <tr> <td>M3</td> <td>1</td> <td></td> <td>2.39 GHz</td> <td>-55.07 dBm</td> <td></td> <td></td> </tr> <tr> <td>M4</td> <td>1</td> <td></td> <td>2.31 GHz</td> <td>-54.43 dBm</td> <td></td> <td></td> </tr> <tr> <td>M5</td> <td>1</td> <td></td> <td>2.362732 GHz</td> <td>-53.44 dBm</td> <td></td> <td></td> </tr> </tbody> </table> <p>Date: 16 MAY 2019 17:25:29</p>			Type	Ref	Trc	X-value	Y-value	Function	Function Result	M1	1		2.40204 GHz	-5.51 dBm			M2	1		2.4 GHz	-54.69 dBm			M3	1		2.39 GHz	-55.07 dBm			M4	1		2.31 GHz	-54.43 dBm			M5	1		2.362732 GHz	-53.44 dBm		
Type	Ref	Trc	X-value	Y-value	Function	Function Result																																							
M1	1		2.40204 GHz	-5.51 dBm																																									
M2	1		2.4 GHz	-54.69 dBm																																									
M3	1		2.39 GHz	-55.07 dBm																																									
M4	1		2.31 GHz	-54.43 dBm																																									
M5	1		2.362732 GHz	-53.44 dBm																																									
<p>CH00 Hopping mode</p>	 <p>Ref Level 20.00 dBm Offset 1.00 dB RBW 100 kHz Att 30 dB SWT 1.1 ms VBW 300 kHz Mode Auto Sweep Count 500/500</p> <p>IPK Max</p> <p>10 dBm M1[1] -6.19 dBm 2.402180 GHz 0 dBm M2[1] -54.73 dBm 2.400000 GHz -10 dBm -20 dBm D1 -26.190 dBm -30 dBm -40 dBm M5 -50 dBm -60 dBm -70 dBm</p> <p>Start 2.31 GHz 691 pts Stop 2.405 GHz</p> <table border="1"> <thead> <tr> <th>Type</th> <th>Ref</th> <th>Trc</th> <th>X-value</th> <th>Y-value</th> <th>Function</th> <th>Function Result</th> </tr> </thead> <tbody> <tr> <td>M1</td> <td>1</td> <td></td> <td>2.40218 GHz</td> <td>-6.19 dBm</td> <td></td> <td></td> </tr> <tr> <td>M2</td> <td>1</td> <td></td> <td>2.4 GHz</td> <td>-54.73 dBm</td> <td></td> <td></td> </tr> <tr> <td>M3</td> <td>1</td> <td></td> <td>2.39 GHz</td> <td>-55.79 dBm</td> <td></td> <td></td> </tr> <tr> <td>M4</td> <td>1</td> <td></td> <td>2.31 GHz</td> <td>-54.72 dBm</td> <td></td> <td></td> </tr> <tr> <td>M5</td> <td>1</td> <td></td> <td>2.325283 GHz</td> <td>-53.17 dBm</td> <td></td> <td></td> </tr> </tbody> </table> <p>Date: 20 MAY 2019 19:01:10</p>			Type	Ref	Trc	X-value	Y-value	Function	Function Result	M1	1		2.40218 GHz	-6.19 dBm			M2	1		2.4 GHz	-54.73 dBm			M3	1		2.39 GHz	-55.79 dBm			M4	1		2.31 GHz	-54.72 dBm			M5	1		2.325283 GHz	-53.17 dBm		
Type	Ref	Trc	X-value	Y-value	Function	Function Result																																							
M1	1		2.40218 GHz	-6.19 dBm																																									
M2	1		2.4 GHz	-54.73 dBm																																									
M3	1		2.39 GHz	-55.79 dBm																																									
M4	1		2.31 GHz	-54.72 dBm																																									
M5	1		2.325283 GHz	-53.17 dBm																																									
<p>CH78 No hopping mode</p>	 <p>Ref Level 20.00 dBm Offset 1.00 dB RBW 100 kHz Att 30 dB SWT 56.9 <math>\mu</math>s VBW 300 kHz Mode Auto FFT Count 500/500</p> <p>IPK Max</p> <p>10 dBm M1[1] -9.03 dBm 2.4800540 GHz 0 dBm M2[1] -59.44 dBm 2.4835000 GHz -10 dBm M1 -20 dBm D1 -29.030 dBm -30 dBm -40 dBm M2 -50 dBm M4 -60 dBm -70 dBm</p> <p>Start 2.478 GHz 691 pts Stop 2.5 GHz</p> <table border="1"> <thead> <tr> <th>Type</th> <th>Ref</th> <th>Trc</th> <th>X-value</th> <th>Y-value</th> <th>Function</th> <th>Function Result</th> </tr> </thead> <tbody> <tr> <td>M1</td> <td>1</td> <td></td> <td>2.480054 GHz</td> <td>-9.03 dBm</td> <td></td> <td></td> </tr> <tr> <td>M2</td> <td>1</td> <td></td> <td>2.4835 GHz</td> <td>-59.44 dBm</td> <td></td> <td></td> </tr> <tr> <td>M3</td> <td>1</td> <td></td> <td>2.5 GHz</td> <td>-59.65 dBm</td> <td></td> <td></td> </tr> <tr> <td>M4</td> <td>1</td> <td></td> <td>2.4861942 GHz</td> <td>-57.05 dBm</td> <td></td> <td></td> </tr> </tbody> </table> <p>Date: 16 MAY 2019 17:28:28</p>			Type	Ref	Trc	X-value	Y-value	Function	Function Result	M1	1		2.480054 GHz	-9.03 dBm			M2	1		2.4835 GHz	-59.44 dBm			M3	1		2.5 GHz	-59.65 dBm			M4	1		2.4861942 GHz	-57.05 dBm									
Type	Ref	Trc	X-value	Y-value	Function	Function Result																																							
M1	1		2.480054 GHz	-9.03 dBm																																									
M2	1		2.4835 GHz	-59.44 dBm																																									
M3	1		2.5 GHz	-59.65 dBm																																									
M4	1		2.4861942 GHz	-57.05 dBm																																									



CH78  
Hopping mode

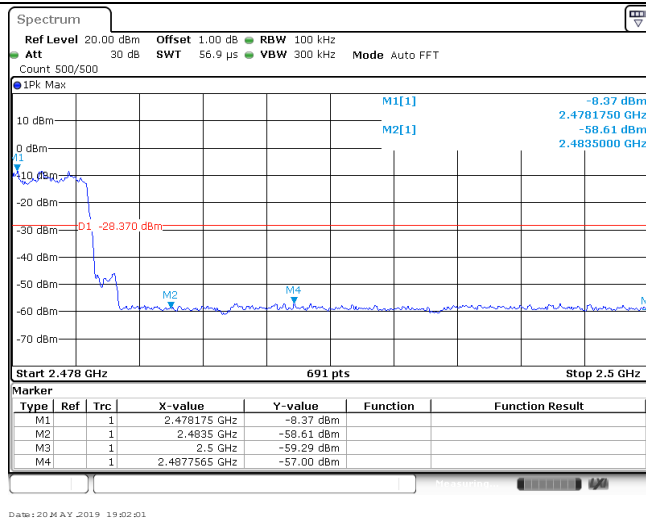

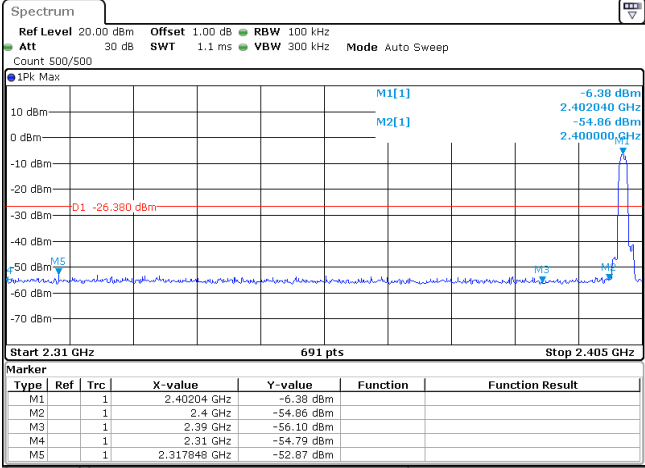
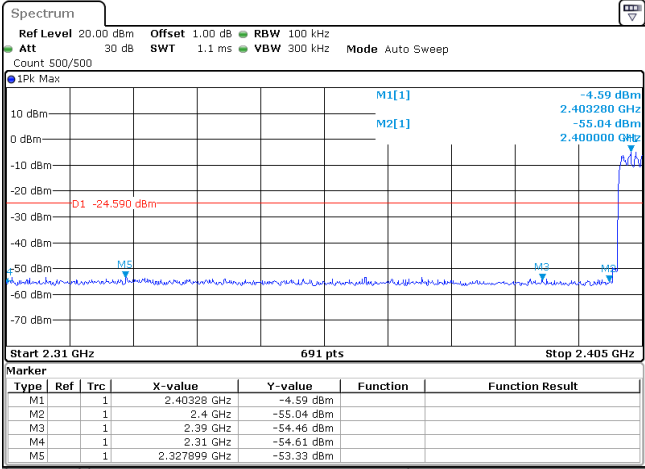
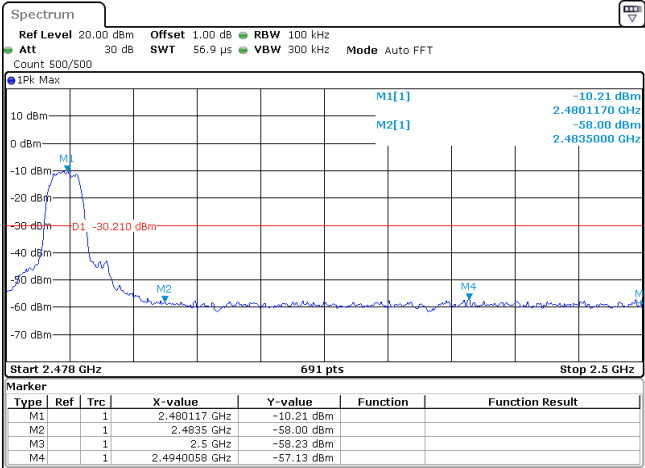
Test Item:	Band edge	Modulation type:	8DPSK																																																
<p>CH00 No hopping mode</p>	 <table border="1" data-bbox="687 595 1334 696"> <thead> <tr> <th>Marker</th> <th>Type</th> <th>Ref</th> <th>Trc</th> <th>X-value</th> <th>Y-value</th> <th>Function</th> <th>Function Result</th> </tr> </thead> <tbody> <tr> <td>M1</td> <td>1</td> <td></td> <td></td> <td>2.40204 GHz</td> <td>-6.38 dBm</td> <td></td> <td></td> </tr> <tr> <td>M2</td> <td>1</td> <td></td> <td></td> <td>2.4 GHz</td> <td>-54.86 dBm</td> <td></td> <td></td> </tr> <tr> <td>M3</td> <td>1</td> <td></td> <td></td> <td>2.39 GHz</td> <td>-55.10 dBm</td> <td></td> <td></td> </tr> <tr> <td>M4</td> <td>1</td> <td></td> <td></td> <td>2.31 GHz</td> <td>-54.79 dBm</td> <td></td> <td></td> </tr> <tr> <td>M5</td> <td>1</td> <td></td> <td></td> <td>2.317848 GHz</td> <td>-52.87 dBm</td> <td></td> <td></td> </tr> </tbody> </table> <p>Date: 20 MAY 2019 18:28:56</p>			Marker	Type	Ref	Trc	X-value	Y-value	Function	Function Result	M1	1			2.40204 GHz	-6.38 dBm			M2	1			2.4 GHz	-54.86 dBm			M3	1			2.39 GHz	-55.10 dBm			M4	1			2.31 GHz	-54.79 dBm			M5	1			2.317848 GHz	-52.87 dBm		
Marker	Type	Ref	Trc	X-value	Y-value	Function	Function Result																																												
M1	1			2.40204 GHz	-6.38 dBm																																														
M2	1			2.4 GHz	-54.86 dBm																																														
M3	1			2.39 GHz	-55.10 dBm																																														
M4	1			2.31 GHz	-54.79 dBm																																														
M5	1			2.317848 GHz	-52.87 dBm																																														
<p>CH00 Hopping mode</p>	 <table border="1" data-bbox="687 1122 1334 1223"> <thead> <tr> <th>Marker</th> <th>Type</th> <th>Ref</th> <th>Trc</th> <th>X-value</th> <th>Y-value</th> <th>Function</th> <th>Function Result</th> </tr> </thead> <tbody> <tr> <td>M1</td> <td>1</td> <td></td> <td></td> <td>2.40328 GHz</td> <td>-4.59 dBm</td> <td></td> <td></td> </tr> <tr> <td>M2</td> <td>1</td> <td></td> <td></td> <td>2.4 GHz</td> <td>-55.04 dBm</td> <td></td> <td></td> </tr> <tr> <td>M3</td> <td>1</td> <td></td> <td></td> <td>2.39 GHz</td> <td>-54.46 dBm</td> <td></td> <td></td> </tr> <tr> <td>M4</td> <td>1</td> <td></td> <td></td> <td>2.31 GHz</td> <td>-54.61 dBm</td> <td></td> <td></td> </tr> <tr> <td>M5</td> <td>1</td> <td></td> <td></td> <td>2.327899 GHz</td> <td>-53.33 dBm</td> <td></td> <td></td> </tr> </tbody> </table> <p>Date: 20 MAY 2019 19:07:57</p>			Marker	Type	Ref	Trc	X-value	Y-value	Function	Function Result	M1	1			2.40328 GHz	-4.59 dBm			M2	1			2.4 GHz	-55.04 dBm			M3	1			2.39 GHz	-54.46 dBm			M4	1			2.31 GHz	-54.61 dBm			M5	1			2.327899 GHz	-53.33 dBm		
Marker	Type	Ref	Trc	X-value	Y-value	Function	Function Result																																												
M1	1			2.40328 GHz	-4.59 dBm																																														
M2	1			2.4 GHz	-55.04 dBm																																														
M3	1			2.39 GHz	-54.46 dBm																																														
M4	1			2.31 GHz	-54.61 dBm																																														
M5	1			2.327899 GHz	-53.33 dBm																																														
<p>CH78 No hopping mode</p>	 <table border="1" data-bbox="687 1659 1334 1749"> <thead> <tr> <th>Marker</th> <th>Type</th> <th>Ref</th> <th>Trc</th> <th>X-value</th> <th>Y-value</th> <th>Function</th> <th>Function Result</th> </tr> </thead> <tbody> <tr> <td>M1</td> <td>1</td> <td></td> <td></td> <td>2.480117 GHz</td> <td>-10.21 dBm</td> <td></td> <td></td> </tr> <tr> <td>M2</td> <td>1</td> <td></td> <td></td> <td>2.4835 GHz</td> <td>-58.00 dBm</td> <td></td> <td></td> </tr> <tr> <td>M3</td> <td>1</td> <td></td> <td></td> <td>2.5 GHz</td> <td>-58.23 dBm</td> <td></td> <td></td> </tr> <tr> <td>M4</td> <td>1</td> <td></td> <td></td> <td>2.4940058 GHz</td> <td>-57.13 dBm</td> <td></td> <td></td> </tr> </tbody> </table> <p>Date: 20 MAY 2019 18:32:01</p>			Marker	Type	Ref	Trc	X-value	Y-value	Function	Function Result	M1	1			2.480117 GHz	-10.21 dBm			M2	1			2.4835 GHz	-58.00 dBm			M3	1			2.5 GHz	-58.23 dBm			M4	1			2.4940058 GHz	-57.13 dBm										
Marker	Type	Ref	Trc	X-value	Y-value	Function	Function Result																																												
M1	1			2.480117 GHz	-10.21 dBm																																														
M2	1			2.4835 GHz	-58.00 dBm																																														
M3	1			2.5 GHz	-58.23 dBm																																														
M4	1			2.4940058 GHz	-57.13 dBm																																														

CH78  
Hoppig mode

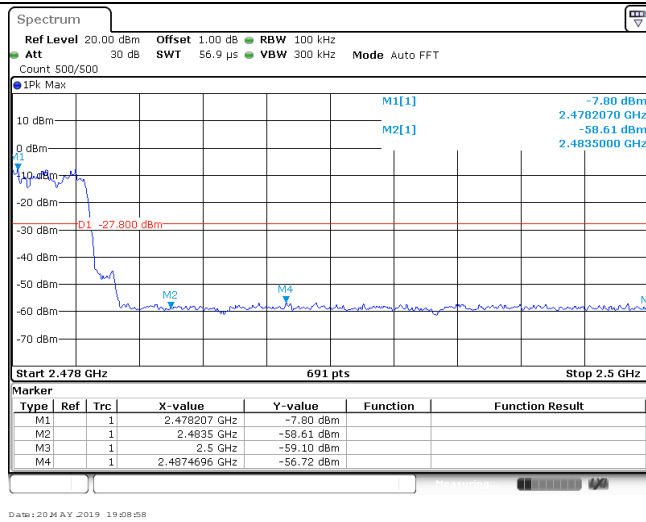

Test Item:	SE	Modulation type:	GFSK
CH00 Reference level			
CH00 30MHz~1000MHz			
CH00 1GHz~26GHz			

CH39  
Reference level

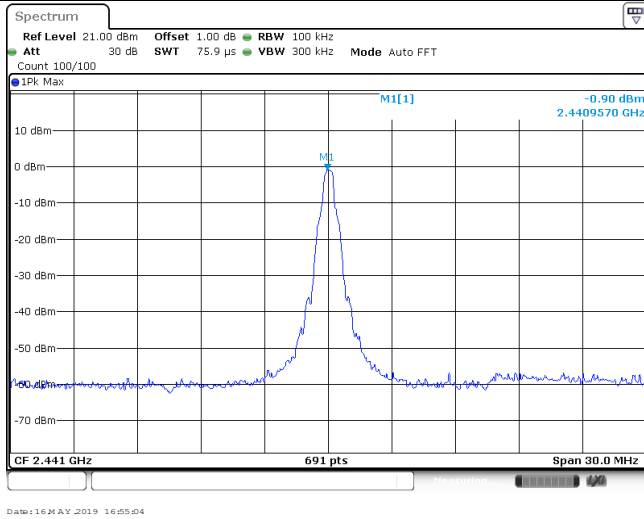

CH39  
30MHz~1000MHz

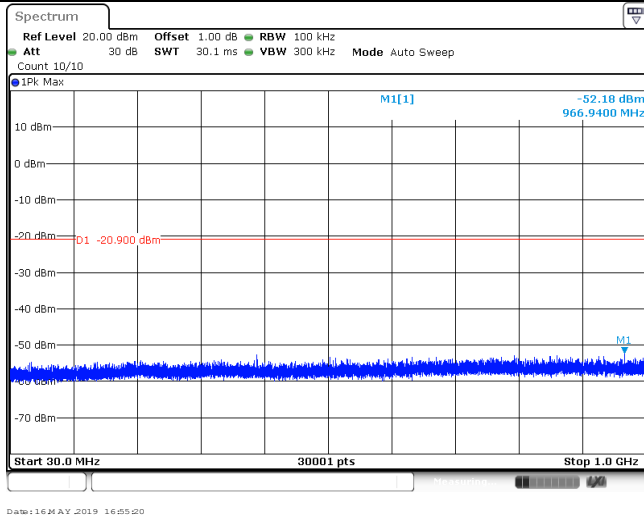

CH39  
1GHz~26GHz

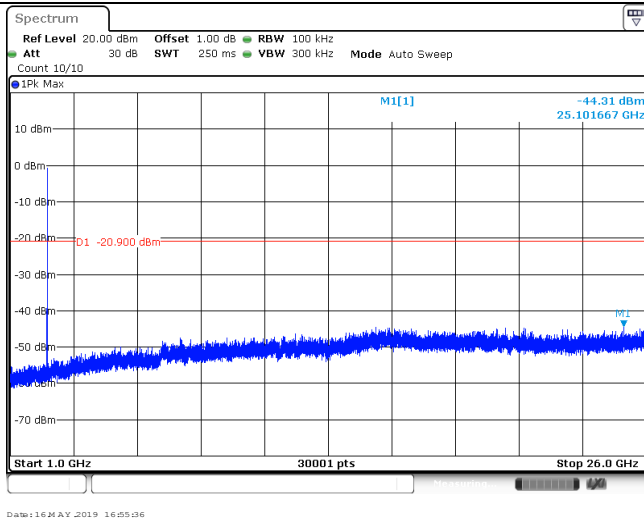

CH78  
Reference level

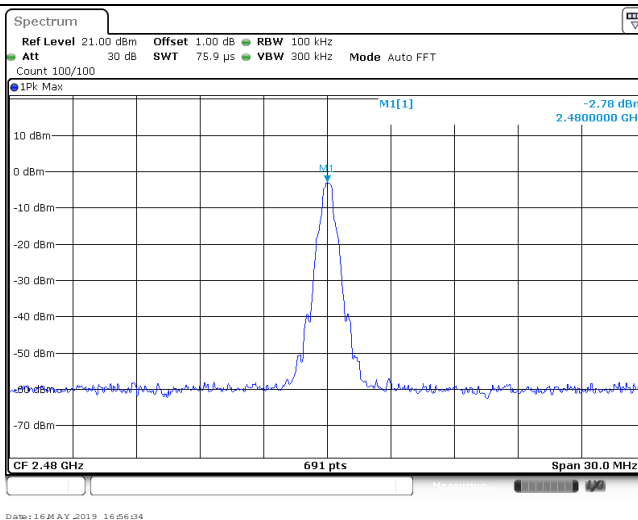

CH78  
30MHz~1000MHz

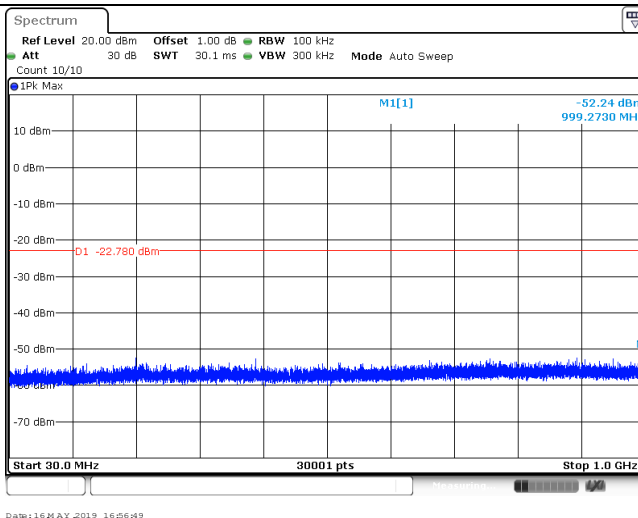

CH78  
1GHz~26GHz

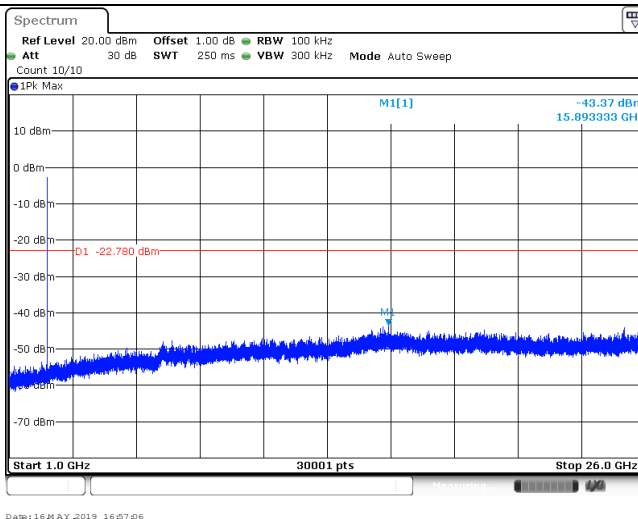

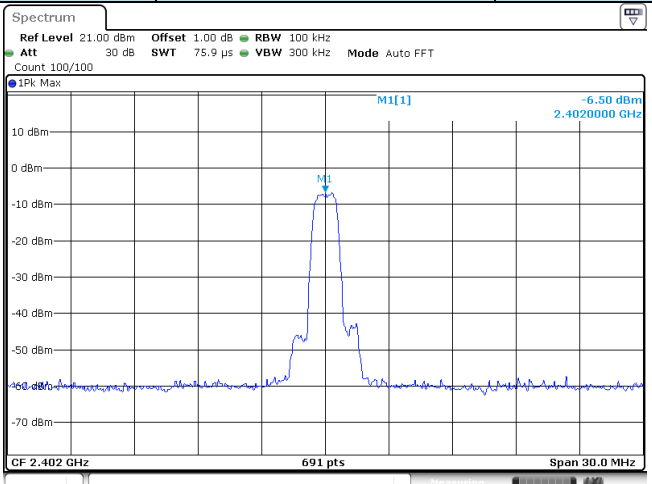
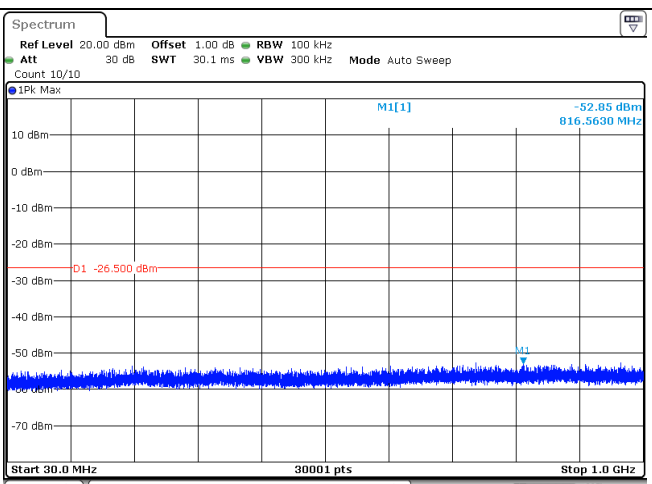
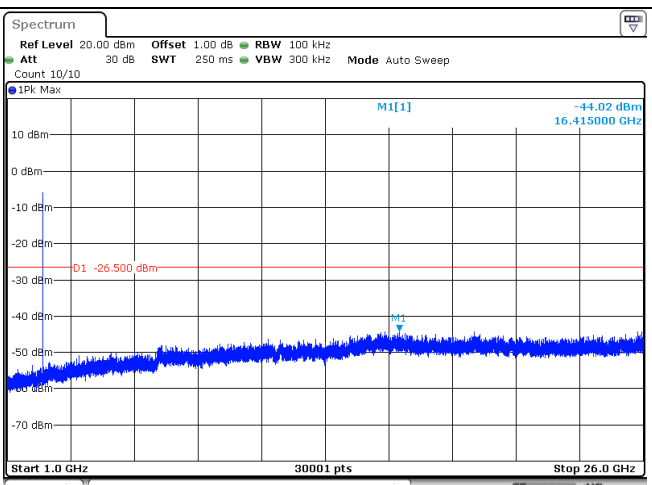
Test Item:	SE	Modulation type:	$\pi/4$ DQPSK
CH00 Reference level		 <p>Spectrum</p> <p>Ref Level 21.00 dBm Offset 1.00 dB RBW 100 kHz Att 30 dB SWT 75.9 <math>\mu</math>s VBW 300 kHz Mode Auto FFT Count 100/100</p> <p>1Pk Max</p> <p>M1[1] -6.50 dBm 2.402000 GHz</p> <p>CF 2.402 GHz 691 pts Span 30.0 MHz</p> <p>Date: 16 MAY 2019 17:25:40</p>	
CH00 30MHz~1000MHz		 <p>Spectrum</p> <p>Ref Level 20.00 dBm Offset 1.00 dB RBW 100 kHz Att 30 dB SWT 30.1 ms VBW 300 kHz Mode Auto Sweep Count 10/10</p> <p>1Pk Max</p> <p>M1[1] -52.85 dBm 816.5630 MHz</p> <p>D1 -26.500 dBm</p> <p>Start 30.0 MHz 30001 pts Stop 1.0 GHz</p> <p>Date: 16 MAY 2019 17:25:56</p>	
CH00 1GHz~26GHz		 <p>Spectrum</p> <p>Ref Level 20.00 dBm Offset 1.00 dB RBW 100 kHz Att 30 dB SWT 250 ms VBW 300 kHz Mode Auto Sweep Count 10/10</p> <p>1Pk Max</p> <p>M1[1] -44.02 dBm 16.415000 GHz</p> <p>D1 -26.500 dBm</p> <p>Start 1.0 GHz 30001 pts Stop 26.0 GHz</p> <p>Date: 16 MAY 2019 17:26:28</p>	

CH39  
Reference level

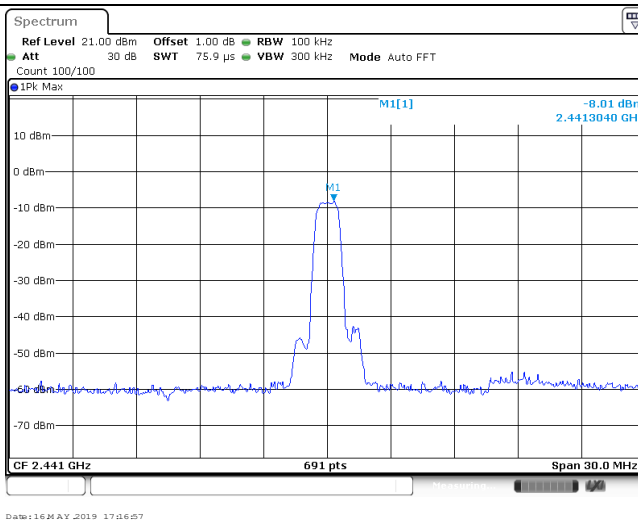

CH39  
30MHz~1000MHz

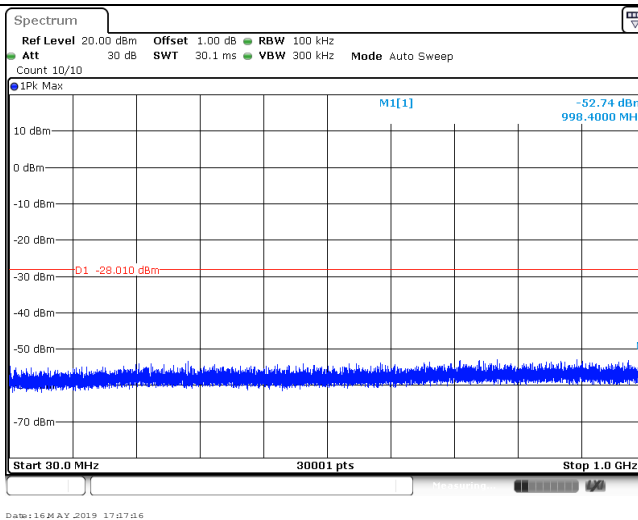

CH39  
1GHz~26GHz

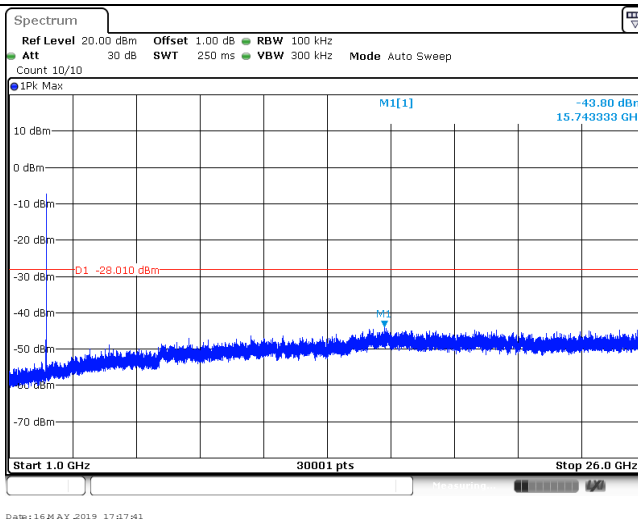



CH78  
Reference level

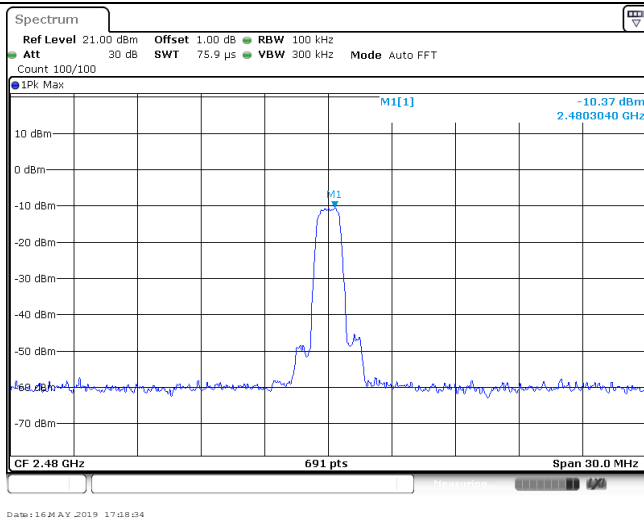

CH78  
30MHz~1000MHz

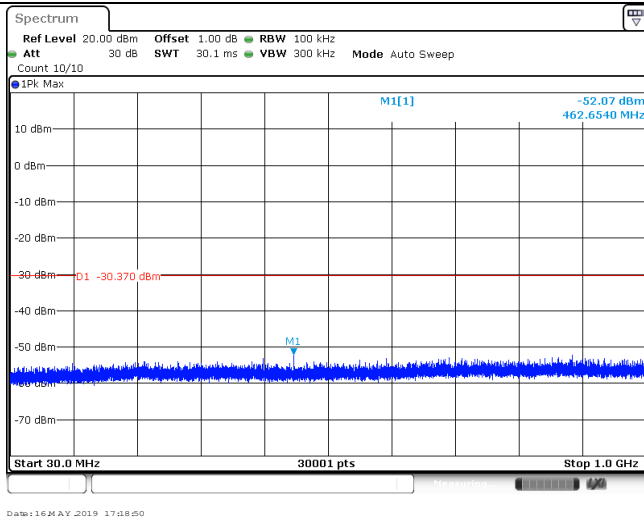

CH78  
1GHz~26GHz

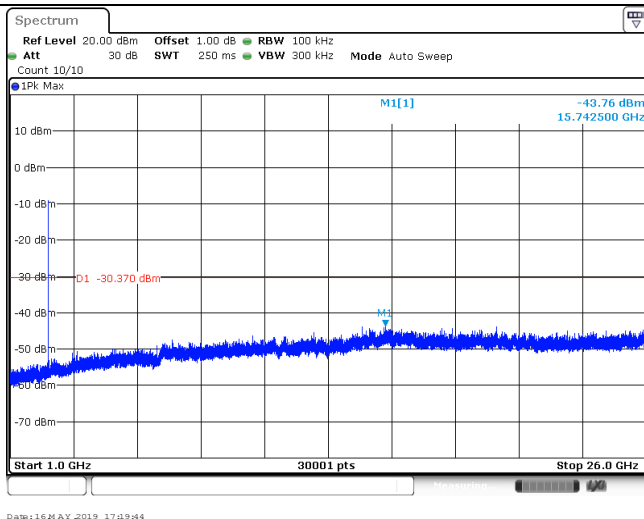

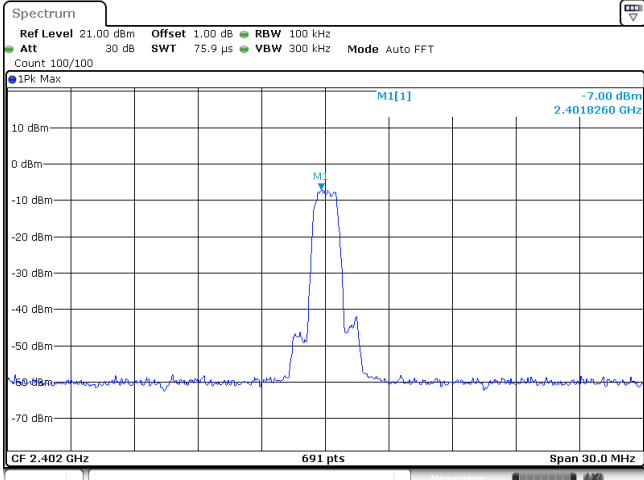
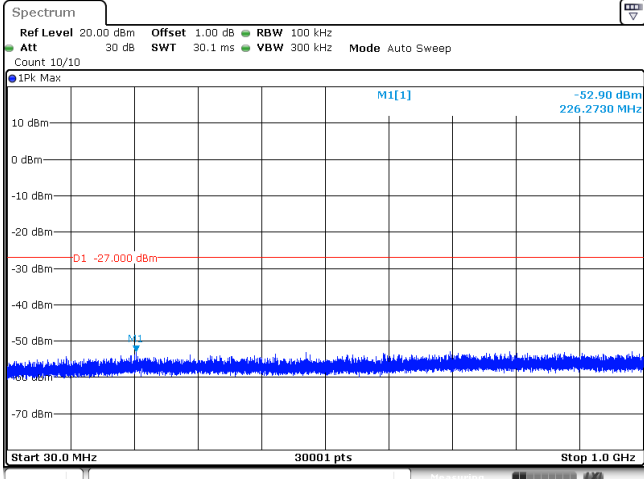
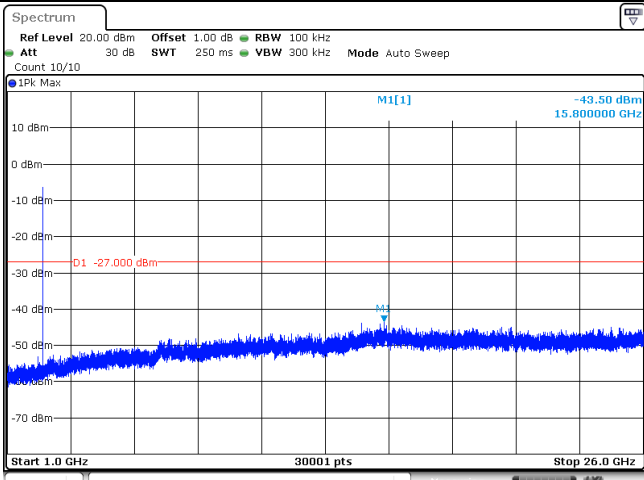
Test Item:	SE	Modulation type:	8DPSK
CH00 Reference level	 <p>Ref Level 21.00 dBm Offset 1.00 dB RBW 100 kHz Att 30 dB SWT 75.9 <math>\mu</math>s VBW 300 kHz Mode Auto FFT Count 100/100 IPk Max M1[1] -7.00 dBm 2.4018260 GHz CF 2.402 GHz 691 pts Span 30.0 MHz Date: 20 MAY 2019 18:29:09</p>		
CH00 30MHz~1000MHz	 <p>Ref Level 20.00 dBm Offset 1.00 dB RBW 100 kHz Att 30 dB SWT 30.1 ms VBW 300 kHz Mode Auto Sweep Count 10/10 IPk Max M1[1] -52.90 dBm 226.2730 MHz D1 -27.000 dBm Start 30.0 MHz 30001 pts Stop 1.0 GHz Date: 20 MAY 2019 18:29:25</p>		
CH00 1GHz~26GHz	 <p>Ref Level 20.00 dBm Offset 1.00 dB RBW 100 kHz Att 30 dB SWT 250 ms VBW 300 kHz Mode Auto Sweep Count 10/10 IPk Max M1[1] -43.50 dBm 15.800000 GHz D1 -27.000 dBm Start 1.0 GHz 30001 pts Stop 26.0 GHz Date: 20 MAY 2019 18:29:41</p>		

CH39  
Reference level

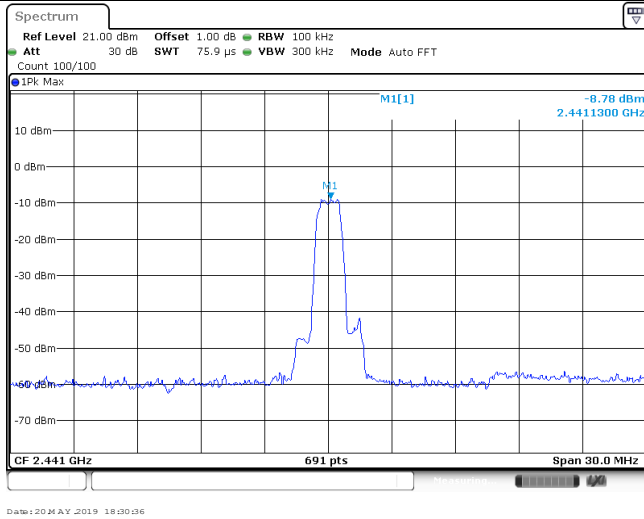

CH39  
30MHz~1000MHz

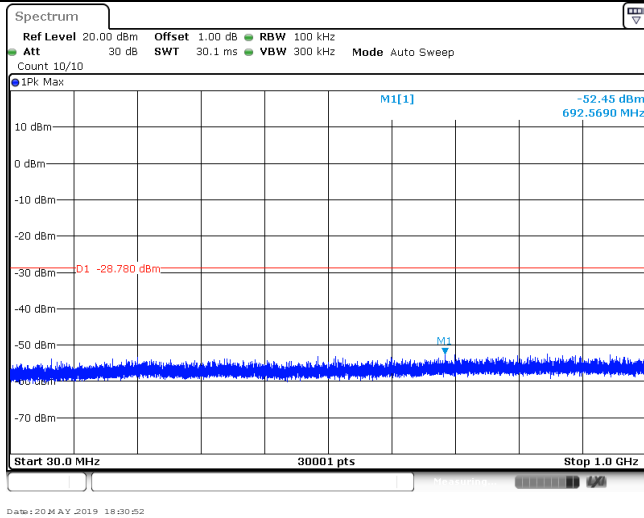

CH39  
1GHz~26GHz

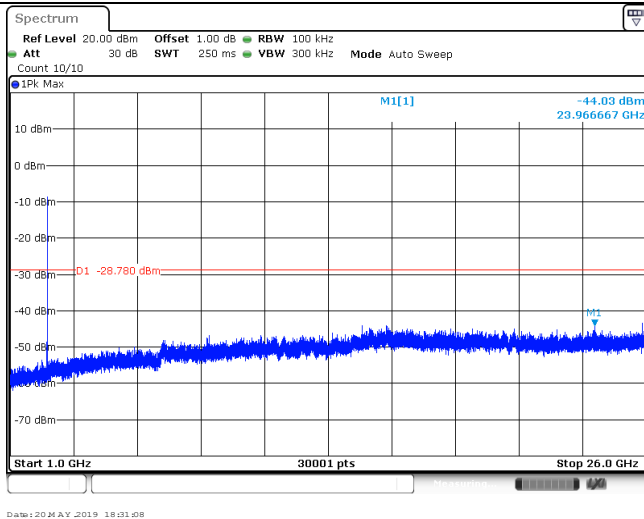

CH78  
Reference level

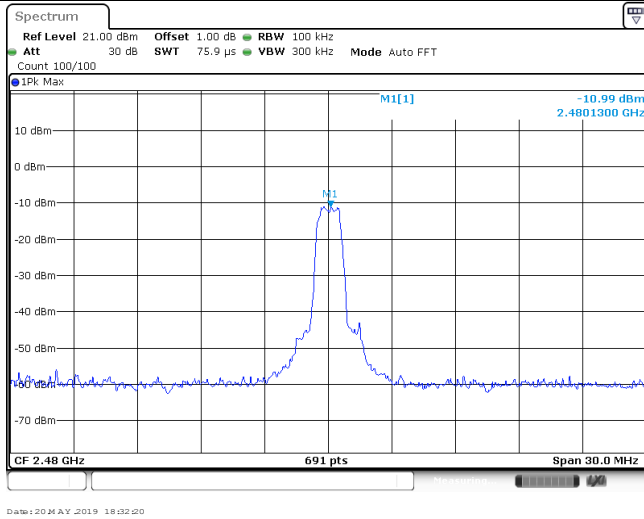

CH78  
30MHz~1000MHz

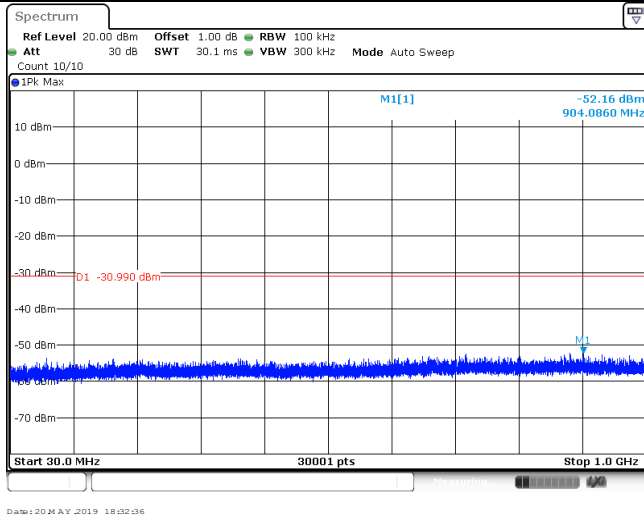

CH78  
1GHz~26GHz

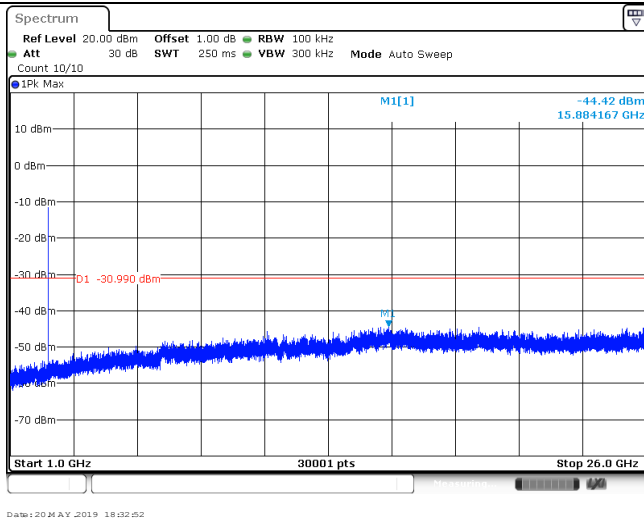

### 5.11. Spurious Emissions (radiated)

#### LIMIT

#### FCC CFR Title 47 Part 15 Subpart C Section 15.209

Frequency	Limit (dBuV/m @3m)	Value
30 MHz ~ 88 MHz	40.00	Quasi-peak
88 MHz ~ 216 MHz	43.50	Quasi-peak
216 MHz ~ 960 MHz	46.00	Quasi-peak
960 MHz ~ 1 GHz	54.00	Quasi-peak
Above 1 GHz	54.00	Average
	74.00	Peak

#### TEST CONFIGURATION

- Below 30 MHz

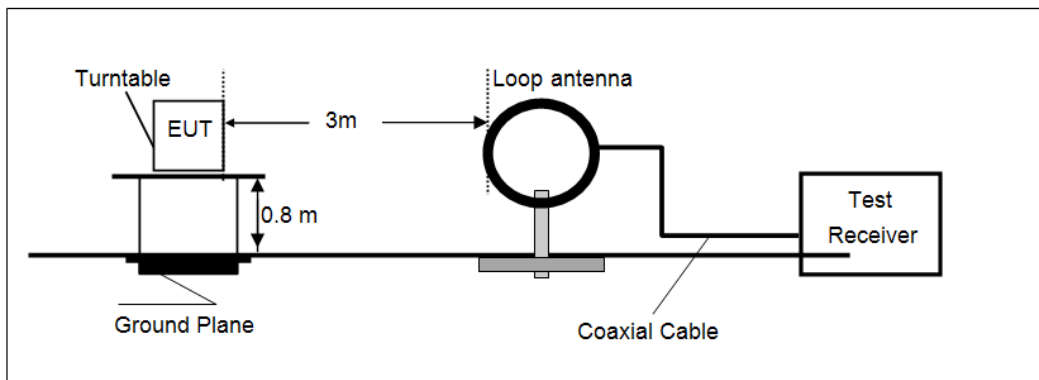

- 30 MHz ~1000 MHz

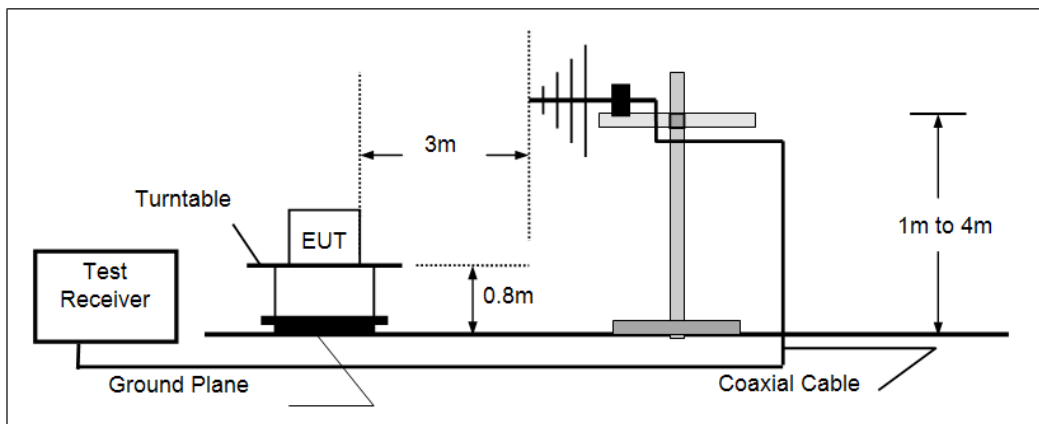

- Above 1 GHz

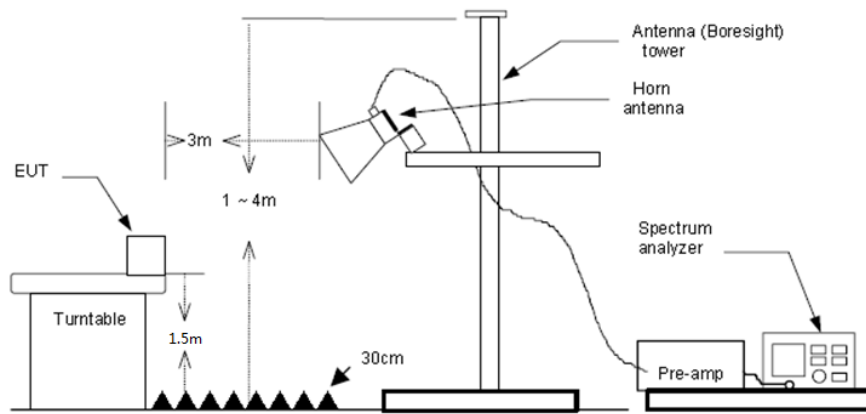

## TEST PROCEDURE

1. The EUT was tested according to ANSI C63.10:2013.
2. The EUT is placed on a turn table with 0.8 meter above ground for below 1GHz, 1.5 meter above ground for above 1GHz.
3. The EUT was set 3 meters from the receiving antenna, which was mounted on the top of a variable height antenna tower.
4. For each suspected emission, the EUT was arranged to its worst case and then tune the Antenna tower (from 1 m to 4 m) and turntable (from 0 degree to 360 degrees) to find the maximum reading. A pre-amp and a high pass filter are used for the test in order to get better signal level to comply with the guidelines.
5. Set to the maximum power setting and enable the EUT transmit continuously.
6. Use the following spectrum analyzer settings
  - (1) Span shall wide enough to fully capture the emission being measured;
  - (2) Below 1 GHz:
    - RBW=120 kHz, VBW=300 kHz, Sweep=auto, Detector function=peak, Trace=max hold;
    - If the emission level of the EUT measured by the peak detector is 3 dB lower than the applicable limit, the peak emission level will be reported. Otherwise, the emission measurement will be repeated using the quasi-peak detector and reported.
  - (3) From 1 GHz to 10<sup>th</sup> harmonic:
    - RBW=1 MHz, VBW=3 MHz Peak detector for Peak value
    - RBW=1 MHz, VBW=10 Hz Peak detector for Average value.

## TEST MODE:

Please refer to the clause 3.3

## TEST RESULTS

Passed       Not Applicable

Note:

- 1) Final Level = Receiver Read level + Antenna Factor + Cable Loss – Preamplifier Factor
- 2) The emission levels of other frequencies are very lower than the limit and not show in test report.
- 3) Below 1 GHz, Have pre-scan all modulation mode, found the GFSK modulation High channel which it was worst case, so only the worst case's data on the test report.
- 4) Above 1 GHz, Have pre-scan all modulation mode, found the GFSK modulation which it was worst case, so only the worst case's data on the test report
- 5) The peak level is lower than average limit(54 dBuV/m), this data is the too weak instrument of signal is unable to test.

### ➤ 9 kHz ~ 30 MHz

The low frequency, which started from 9 kHz to 30 MHz, was pre-scanned and the result which was 20 dB lower than the limit line per 15.31(o) was not reported.

➤ 30 MHz ~ 1 GHz

Polarization: Vertical

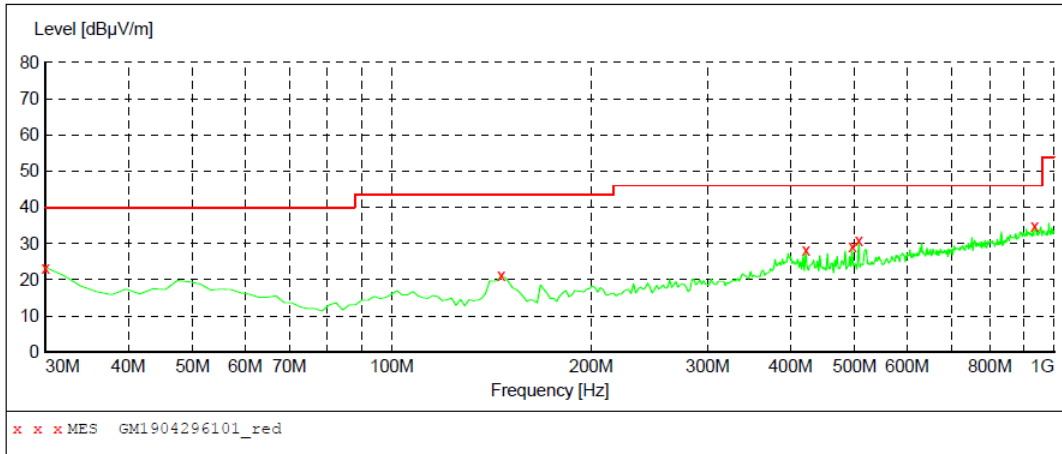

**MEASUREMENT RESULT: "GM1904296101\_red"**

4/29/2019 8:49PM

Frequency MHz	Level dBuV/m	Transd dB	Limit dBuV/m	Margin dB	Det.	Height cm	Azimuth deg	Polarization
30.000000	23.40	-13.4	40.0	16.6	QP	100.0	79.00	VERTICAL
146.400000	21.10	-14.1	43.5	22.4	QP	100.0	340.00	VERTICAL
421.880000	28.20	-4.0	46.0	17.8	QP	100.0	111.00	VERTICAL
495.600000	29.10	-2.2	46.0	16.9	QP	100.0	270.00	VERTICAL
507.240000	30.70	-1.8	46.0	15.3	QP	100.0	283.00	VERTICAL
934.040000	34.80	6.8	46.0	11.2	QP	100.0	37.00	VERTICAL

Polarization: Horizontal

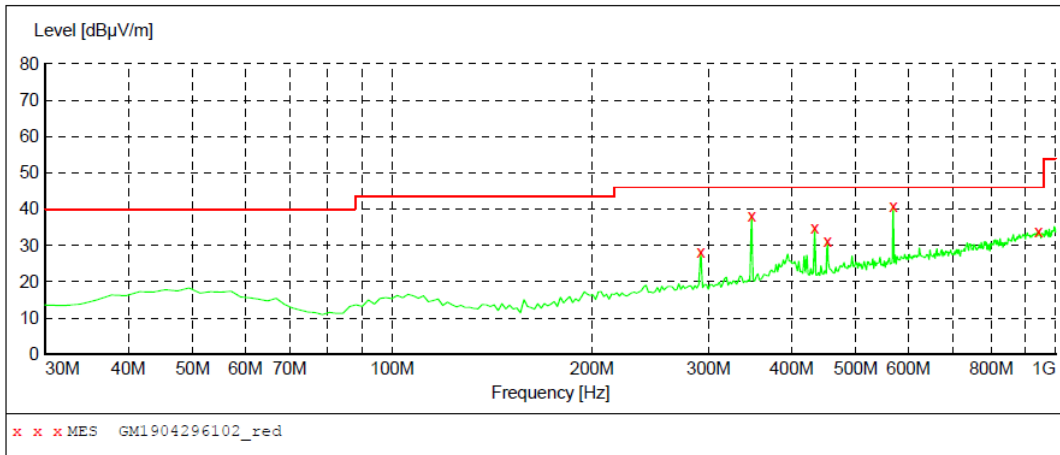

**MEASUREMENT RESULT: "GM1904296102\_red"**

4/29/2019 8:52PM

Frequency MHz	Level dBuV/m	Transd dB	Limit dBuV/m	Margin dB	Det.	Height cm	Azimuth deg	Polarization
291.900000	28.20	-7.6	46.0	17.8	QP	100.0	167.00	HORIZONTAL
348.160000	38.20	-5.6	46.0	7.8	QP	100.0	167.00	HORIZONTAL
433.520000	34.90	-3.8	46.0	11.1	QP	100.0	167.00	HORIZONTAL
452.920000	31.10	-3.5	46.0	14.9	QP	100.0	167.00	HORIZONTAL
569.320000	40.90	-0.6	46.0	5.1	QP	100.0	317.00	HORIZONTAL
941.800000	33.90	6.8	46.0	12.1	QP	100.0	305.00	HORIZONTAL

## ➤ 1 GHz ~ 25 GHz

CH00									
Frequency (MHz)	Read Level (dBuV)	Antenna Factor (dB/m)	Cable Loss (dB)	Preamp Factor (dB)	Level (dBuV/m)	Limit Line (dBuV/m)	Over Limit (dB)	Polarization	Test value
1668.04	37.40	25.11	6.51	37.27	31.75	74.00	-42.25	Vertical	Peak
1904.12	37.95	25.34	6.94	37.51	32.72	74.00	-41.28	Vertical	Peak
5086.52	33.11	31.85	12.03	35.21	41.78	74.00	-32.22	Vertical	Peak
7154.17	31.79	35.93	14.52	33.61	48.63	74.00	-25.37	Vertical	Peak
1353.80	36.78	26.04	5.92	37.14	31.60	74.00	-42.40	Horizontal	Peak
1676.56	37.56	25.13	6.52	37.28	31.93	74.00	-42.07	Horizontal	Peak
3049.39	37.93	28.70	9.05	37.53	38.15	74.00	-35.85	Horizontal	Peak
4712.55	33.32	31.25	11.68	35.89	40.36	74.00	-33.64	Horizontal	Peak

CH39									
Frequency (MHz)	Read Level (dBuV)	Antenna Factor (dB/m)	Cable Loss (dB)	Preamp Factor (dB)	Level (dBuV/m)	Limit Line (dBuV/m)	Over Limit (dB)	Polarization	Test value
1732.97	37.76	25.27	6.61	37.34	32.30	74.00	-41.70	Vertical	Peak
3507.65	36.39	29.02	9.90	37.13	38.18	74.00	-35.82	Vertical	Peak
6063.19	32.05	32.50	13.39	34.08	43.86	74.00	-30.14	Vertical	Peak
7643.68	32.17	36.16	15.12	33.03	50.42	74.00	-23.58	Vertical	Peak
1207.28	38.15	26.29	5.54	37.22	32.76	74.00	-41.24	Horizontal	Peak
3516.59	35.92	29.05	9.92	37.13	37.76	74.00	-36.24	Horizontal	Peak
5560.50	33.12	31.84	12.64	34.39	43.21	74.00	-30.79	Horizontal	Peak
6764.54	33.02	34.07	14.08	33.76	47.41	74.00	-26.59	Horizontal	Peak

CH78									
Frequency (MHz)	Read Level (dBuV)	Antenna Factor (dB/m)	Cable Loss (dB)	Preamp Factor (dB)	Level (dBuV/m)	Limit Line (dBuV/m)	Over Limit (dB)	Polarization	Test value
1313.08	36.45	26.16	5.82	37.16	31.27	74.00	-42.73	Vertical	Peak
3543.55	35.30	29.13	9.98	37.11	37.30	74.00	-36.70	Vertical	Peak
4332.85	34.60	30.30	10.95	36.44	39.41	74.00	-34.59	Vertical	Peak
6140.85	32.68	32.66	13.44	34.00	44.78	74.00	-29.22	Vertical	Peak
1464.96	36.85	25.83	6.16	37.09	31.75	74.00	-42.25	Horizontal	Peak
1706.70	37.31	25.21	6.57	37.31	31.78	74.00	-42.22	Horizontal	Peak
3672.11	36.32	29.30	9.99	37.00	38.61	74.00	-35.39	Horizontal	Peak
4958.68	34.21	31.46	11.81	35.45	42.03	74.00	-31.97	Horizontal	Peak

## Remark:

1. Final Level = Receiver Read level + Antenna Factor + Cable Loss – Preamplifier Factor
2. The peak level is lower than average limit(54 dBuV/m), this data is the too weak instrument of signal is unable to test.
3. The emission levels of other frequencies are very lower than the limit and not show in test report.



## 6. TEST SETUP PHOTOS

Conducted Emissions (AC Mains)



Radiated Emissions

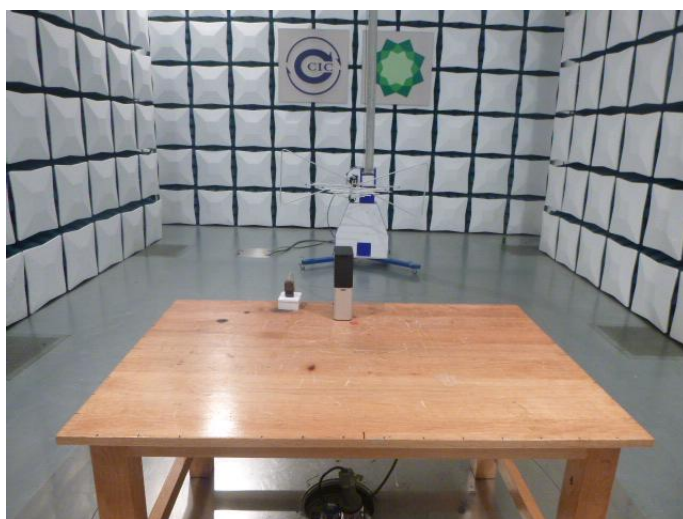

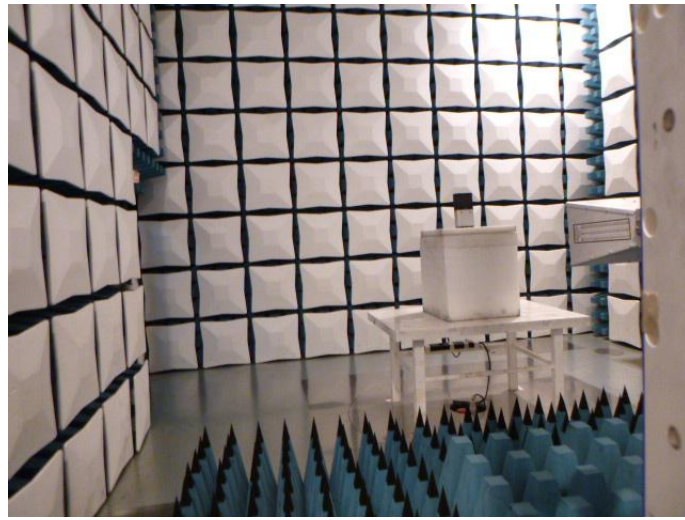

## 7. EXTERANAL AND INTERNAL PHOTOS

### External Photos

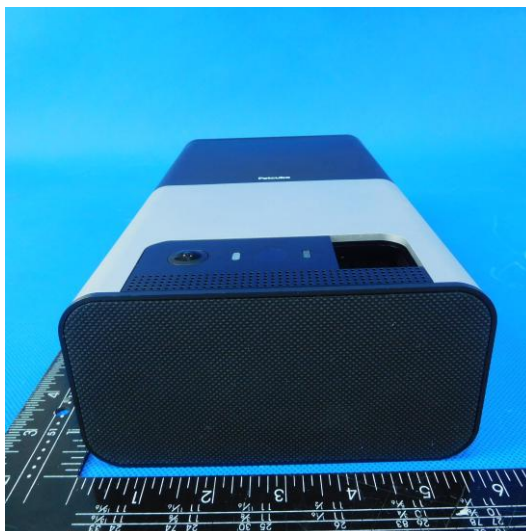

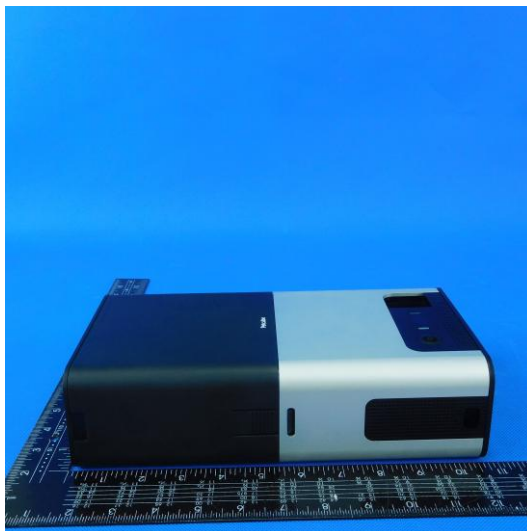
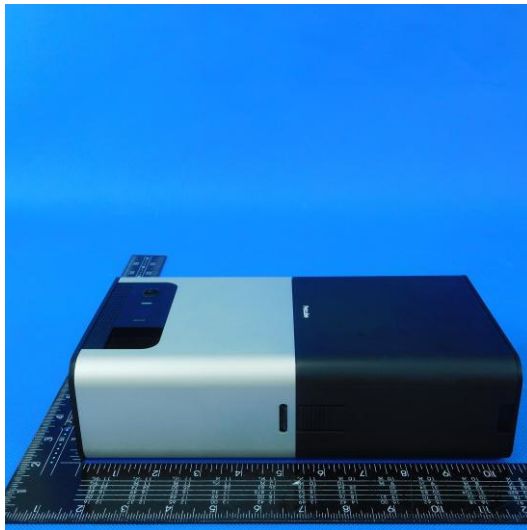
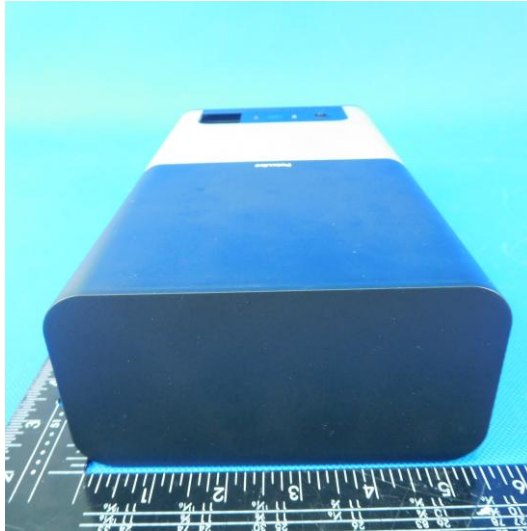



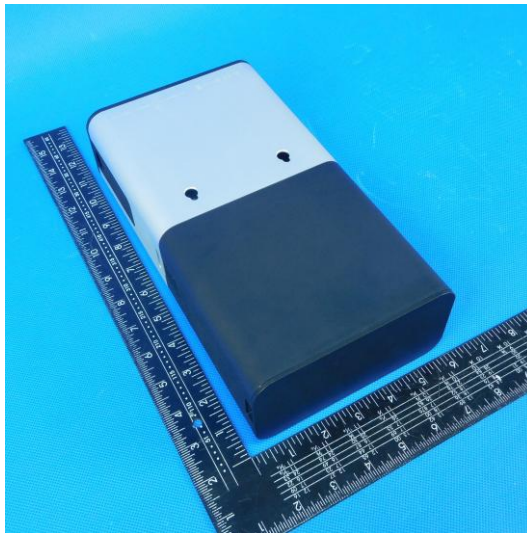

### Internal Photos

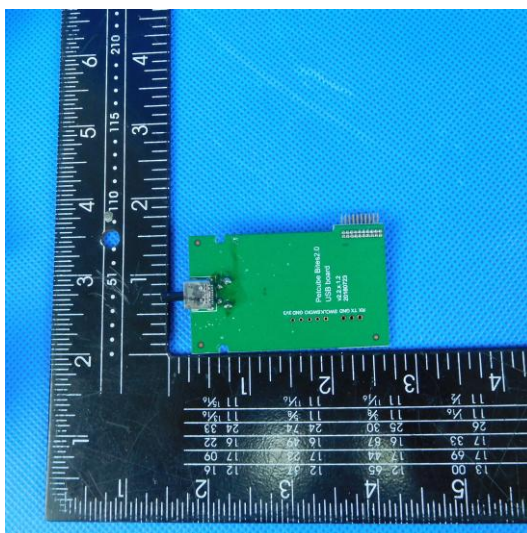
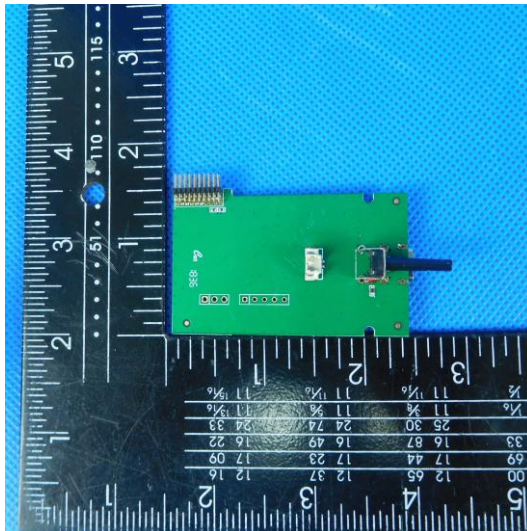

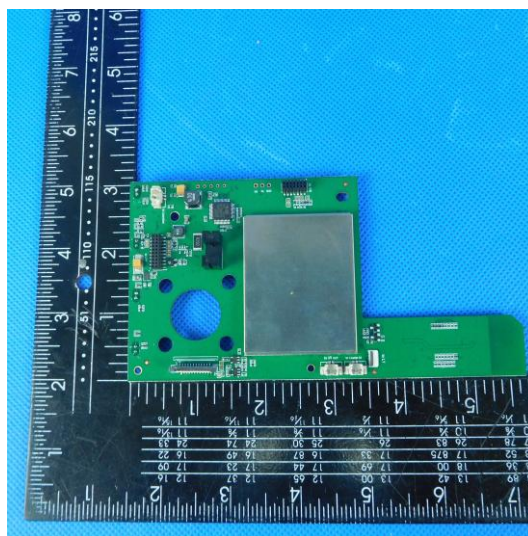
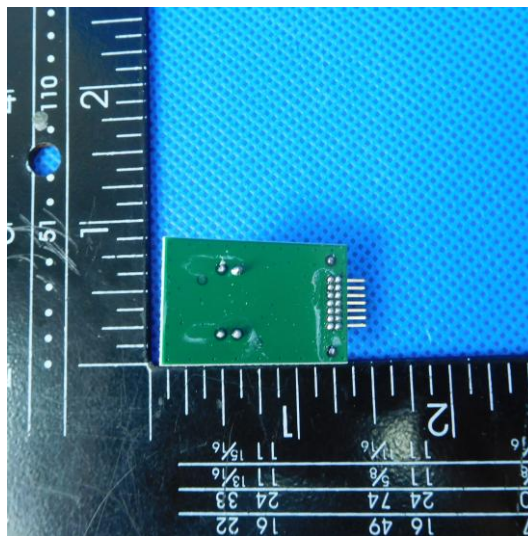
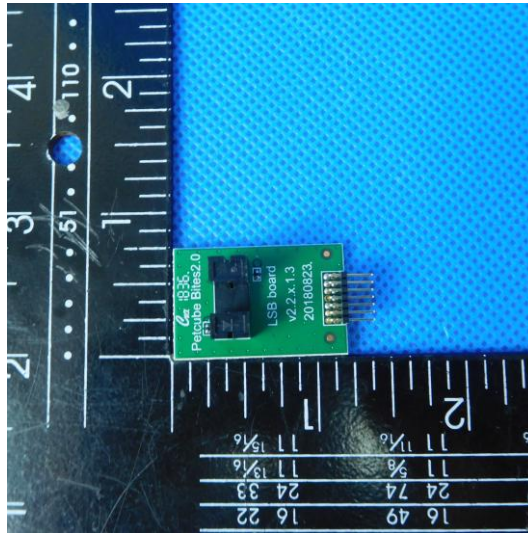



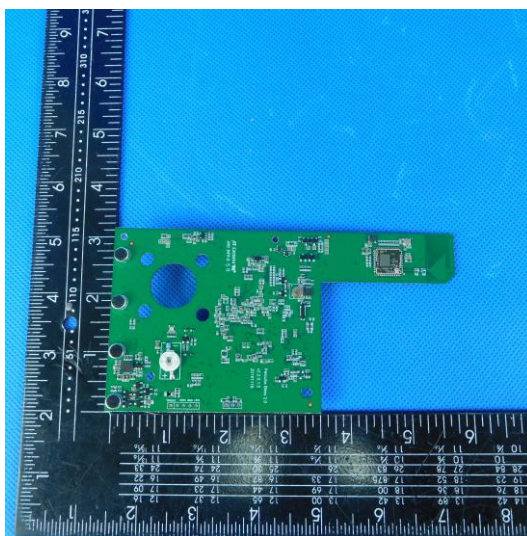
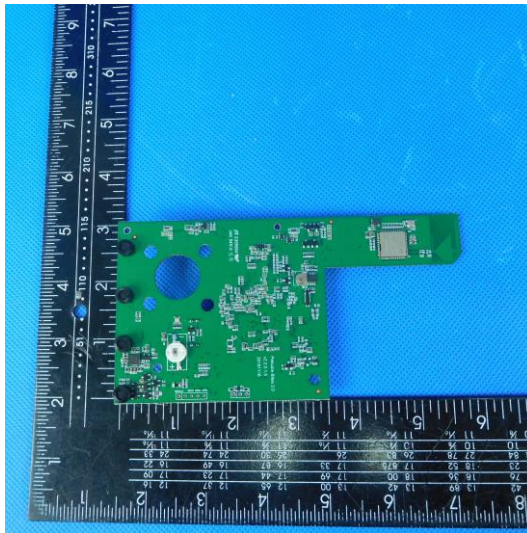
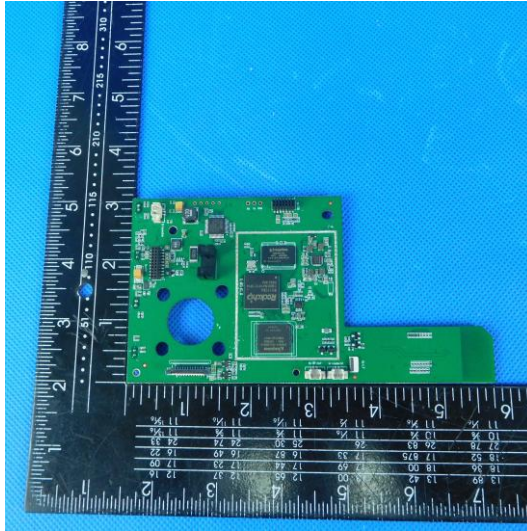



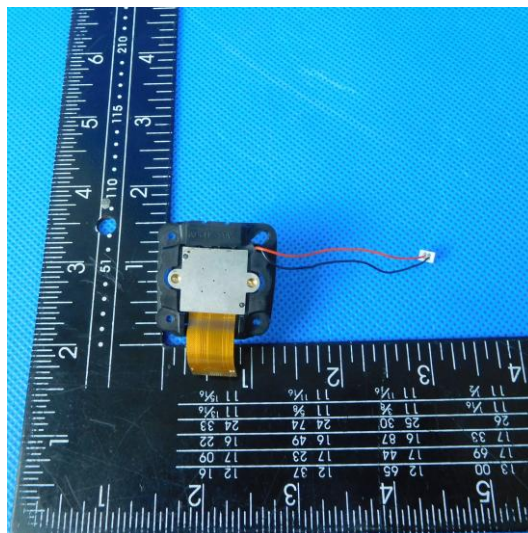
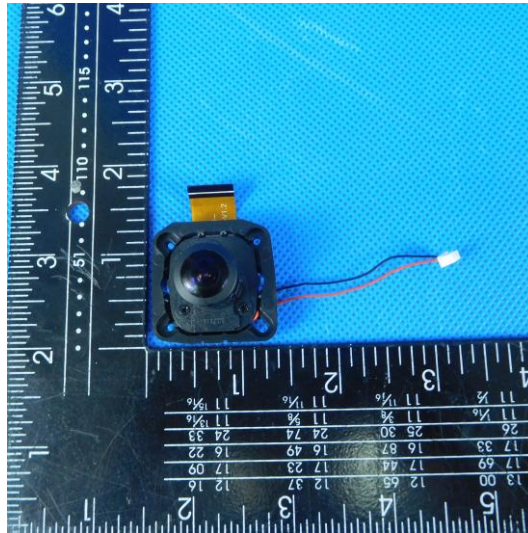

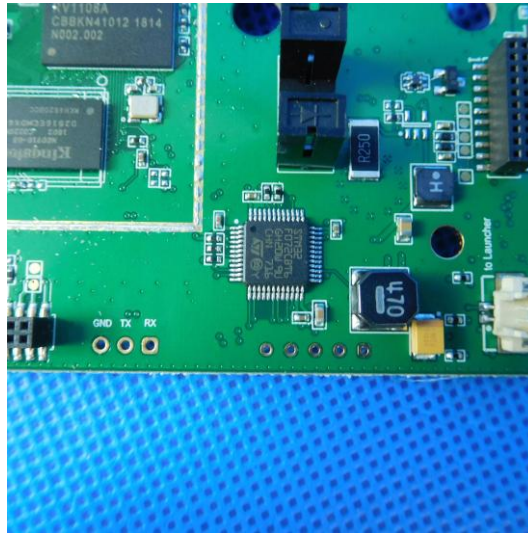

-----End of Report-----