



ELECTRO-OPTICS

KILO[®]

KILO2400ABS™ 7x25mm DIGITAL BALLISTIC LASER RANGEFINDER

OWNERS MANUAL

SIG SAUER[®]

TABLE OF CONTENTS

Introduction	3
Contents	5
Key Features	6
Product Identification	8
Warning - Safety and Operation Procedures	9
Setup	10
General Operation	13
Advanced Operation – LOS and AMR without Ballistics	18
Advanced Ballistic Operation – Ballistic Profiles and Holdover	30
SIG Ballistic App Operation	45
Frequently Asked Questions (FAQ)	58
Specifications	64
SIG SAUER Electro-Optics Infinite Guarantee™	68
SIG SAUER Electronic & Tritium Component Limited 5-Year Warranty	69

This manual is available in the following languages: French, Spanish, German, Italian, Portuguese, Russian, Afrikaans, Swedish, and Norwegian. Please visit sigsauer.com for Owners Manual downloads.

INTRODUCTION

Congratulations on the purchase of your SIG SAUER® KILO2400ABS™ Laser Rangefinder. The KILO2400ABS is the world's most advanced rangefinder featuring an embedded Applied Ballistics calculator, onboard environmental sensors and Bluetooth for synchronizing custom profiles with a free, downloadable ballistic app for your iOS or Android smartphone. Your purchase includes a tripod adapter, smartphone jack wind meter, Molle bag, nylon carry bag, lanyard and 3 spare batteries to get you up and running for long range precision target shooting and hunting. The KILO2400ABS also features an improved laser with tighter beam divergence and a molded, glass asphere for the transmitter channel which provides consistent ranging performance across all temperatures. The advanced OLED display provides for a tighter center aiming circle along with milling features and advanced information including holdover, angle, wind direction, wind speed, target mode and shot angle. As with all SIG SAUER laser rangefinders, the KILO2400 leverages SIG SAUER's proprietary LightWave DSP engine featuring HyperScan with RangeLock for reaching targets out to 2 miles at a 4 times per second scan rate.

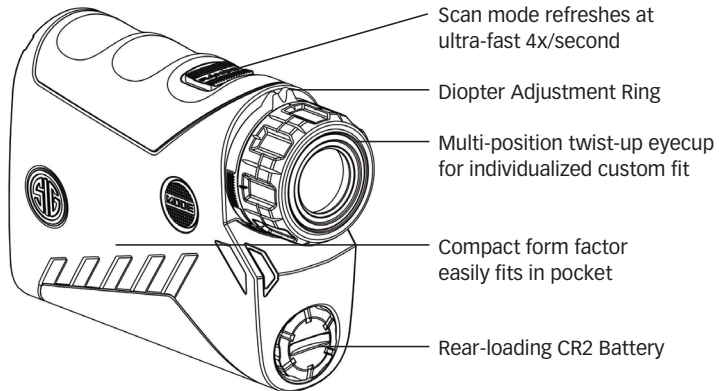

CONTENTS:

- KILO2400ABS™ 7x25mm Digital Ballistic Laser Rangefinder with Bluetooth
- Padded Ballistic Nylon Case
- Flat Dark Earth, Water Resistant Molle Gear Bag
- WeatherFlow WindMETER
- One Piece CNC Billet Aluminum Tripod Adapter
- SIG SAUER® Tactical Pen/Stylus
- (3) CR2 Primary Lithium Batteries
- Lanyard
- Instruction Manual

KEY FEATURES:

- 7x25mm monocular with SpectraCoat™ anti-reflection coatings for superior light transmission and optical clarity.
- Revolutionary LightWave DSP™ Technology for the fastest and longest distance rangefinder engine.
- HyperScan™ Technology provides 4 range updates per second in scan mode while RangeLock™ reports the last range result when ranging distant targets.
- Embedded Applied Ballistics Elite with bullet database and support for G1/G7 and AB Custom Drag curves.
- Free downloadable Sig Ballistic App for your smartphone. iOS and Android are supported.
- Temperature, pressure and humidity sensors for real-time environmental inputs to the embedded ballistic calculator.
- Digital Compass / Magnetometer / Inclinometer provides magnetic heading and incline for long distance shooting and Coriolis adjustment.
- Bluetooth 4.0 for synchronizing up to 4 custom ballistic profiles between the free SIG Ballistic App and rangefinder. Both Classic and Low Energy are supported for iOS and Android smartphones.

- Advanced OLED display provides a smaller, more accurate center aiming circle along with milling features and ballistic information including holdover, angle, wind direction, wind speed, target mode, density altitude and shot angle.
- Line of Sight or Angle Modified range in addition to full ballistic holdover results in MIL or MOA.
- Lumatic™ Display automatically calibrates display brightness to changing ambient light conditions.
- Compact, magnesium housing with binocular style eyecup and diopter adjustment.
- Sleek design for one handed operation and lanyard attachment point.
- Includes a smartphone wind meter and tripod adapter.

PRODUCT IDENTIFICATION:

- A- Power/Range Button
- B- Diopter Focus Adjustment
- C- Eyecup
- D- Mode Button
- E- Battery Compartment

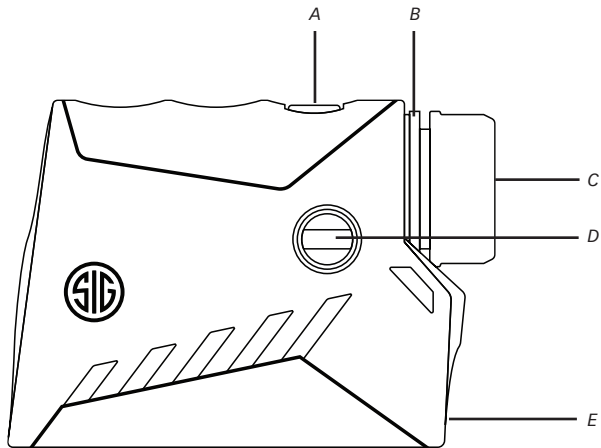

⚠ WARNING

Safety and Operation Procedures

The KILO2400ABS is classified as a Class 3R product. There are a few precautions that are important to remember:

- Do not depress the RANGE button while aiming at the human eye or while looking into the transmitting optics on the objective side
- Do not leave the KILO2400ABS within reach of small children
- Do not take the product apart or modify the product in any way to expose internal electronics that might cause damage or electric shock
- Do not use any other power source other than a CR2 battery or equivalent.

SET UP

Installing the Battery

Remove the battery cap by turning the cap in a counter-clockwise direction. Insert (1) CR2 Primary Lithium battery (+) terminal side first. The (-) terminal should be facing out. Place the cap onto the (-) battery terminal and reinstall the battery cap by turning the cap in the clockwise direction.

CAUTION - Be careful to not cross-thread the cap.

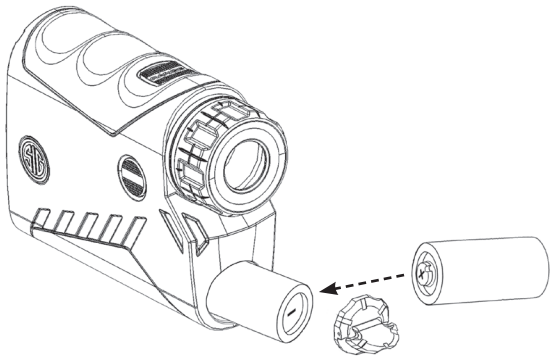

After installation of the battery and depressing the RANGE button, the status of the KIL02400ABS is displayed:

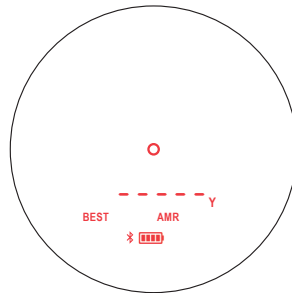

Installing the Lanyard

Install the lanyard loop through the lanyard attachment point. Pass the lanyard back through the loop for secure attachment.

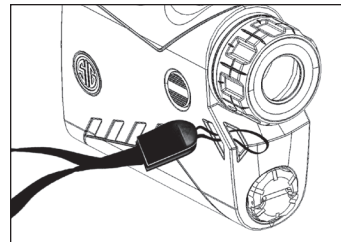

Diopter Adjustment

The diopter or focus adjustment is located just inside of the eyecup. The focus adjustment is used to bring the OLED display into sharp focus along with the target image. The diopter adjustment can turn clockwise or counter-clockwise depending upon the user's prescription.

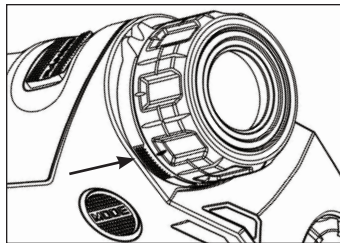

Eyecup Adjustment

The eyecup adjustment allows the user to adjust the eye relief for use with or without glasses. The eyecup rotates approximately 90 degrees counterclockwise allowing the user to adjust the eye relief by approximately 6 mm.

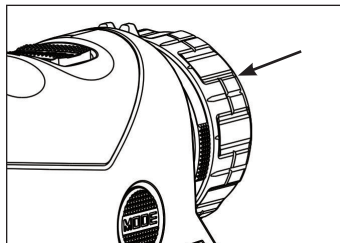

GENERAL OPERATION

a. The KILO2400ABS is setup to work out of the box in its most simple configuration. There are only two buttons located on the rangefinder: RANGE and MODE. The RANGE button is used to turn on the rangefinder and for ranging targets. The MODE button is for configuring the rangefinder.

b. For users that do not require advanced ballistics and holdover corrections, the unit is configured with only the minimal amount of information to display: Center aiming circle, BEST target mode, Angle Modified Range (AMR) mode, Y for yards as the unit of measure, remaining battery status and Bluetooth status (ON or OFF).

c. To use the rangefinder, aim the unit at a target of interest using the center circle to bracket your target. Press and release the RANGE button to display the distance to the target. The display will remain active for 30 seconds. If you press and hold the RANGE button down the rangefinder will enter HyperScan providing range results every 250 milliseconds. Upon release of the RANGE button the last range will be displayed for 30 seconds. You may notice that after initially turning on the rangefinder only the center aiming circle and range information will be displayed; this is done in order to reduce clutter in the field of view.

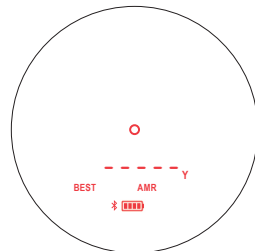

Display at initial wakeup

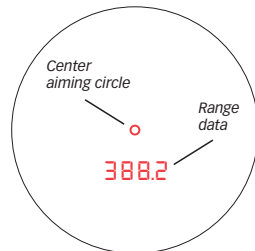

Display when ranging

HyperScan MODE

While the KILO2400ABS supports single button push ranging operation, it is highly recommended that you push and hold the RANGE button down to activate HyperScan mode. This mode allows you to scan targets at 4x/second which significantly improves ranging performance at extreme distances. As the ranging distances are updated very quickly in HyperScan mode, once you release the RANGE button the last acquired distance will be displayed. When in HyperScan mode ranging distant targets, the display may update between no result and a distant range - by using RangeLock technology the rangefinder will report the last range result when the RANGE button is released.

Note - HyperScan is limited to 20 seconds of continuous ranging before turning off. You can restart SCAN mode by releasing and pressing the range button again. This is done to ensure that the unit remains eye safe in all conditions.

LUMATIC™ OLED DISPLAY

The KILO2400ABS has the most advanced display on the market. Our OLED display has the largest dynamic range providing for high brightness in bright sunlight or snow conditions, yet will dim down to near night vision levels at dusk and dawn. No other display offers this adaptive ability to prevent your pupil from constricting in low light causing you to no longer be able to see your target. A small, ambient light sensor (ALS) is located in the objective of the rangefinder and samples the ambient light condition of the target image. The ALS samples and updates the brightness instantaneously to always provide the right amount of contrast against your target image.



Display in Bright Light



Display in Low Light

- A - Elevation Hold Direction
- B - Wind Hold Direction
- C - Milling Grid (Dots = 5 MRAD / Ticks = 10 MRAD)
- D - Center Aiming Circle (3 MRAD OD / 2.4 MRAD ID)
- E - 5 Character Alphanumeric Display
- F - Wind Speed Unit of Measure
- G - Range Unit of Measure
- H - Holdover Unit of Measure
- I - Angle of Incline or Decline
- J - Wind Speed Indicator
- K - Wind Direction Indicator
- L - Target Mode (BEST or LAST)
- M - Density Altitude Indicator
- N - Bluetooth Indicator
- O - Battery Status Indicator
- P - Ranging Mode (LOS or AMR)

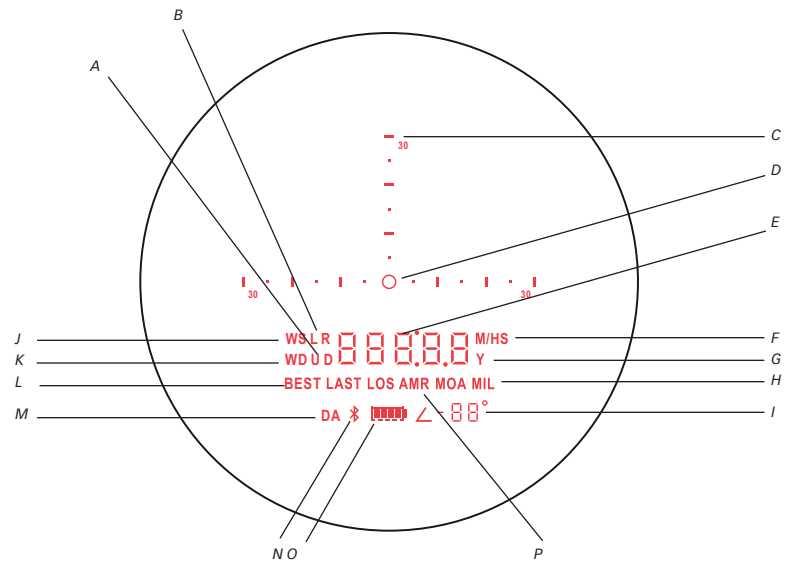

ADVANCED OPERATION

The KILO2400ABS features an advanced programming menu for configuration. There are three primary paths:

- i. Angle Modified Range mode without ballistic holdovers
- ii. Line of Sight Range mode without ballistic holdovers
- iii. Line of Sight Range mode with ballistic holdovers

A summary of the user interface programming menu is here.

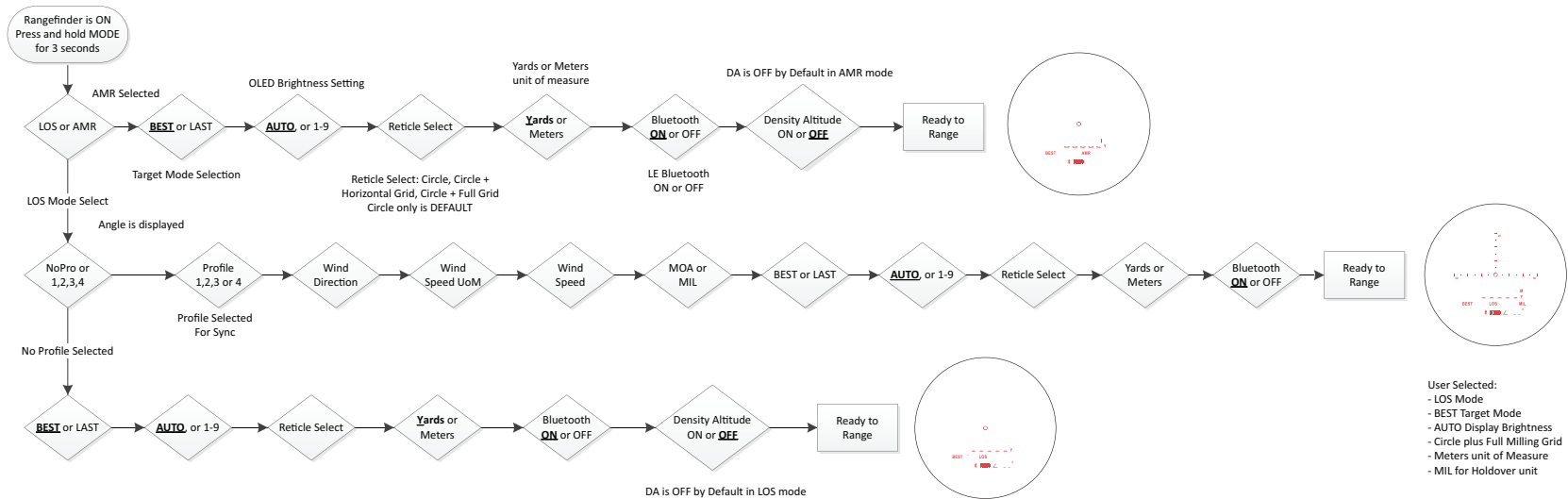

ADVANCED OPERATION (continued)

In each path you can configure the following common features:

1. Target Mode – BEST target will be used in most cases, however, if you are ranging through tall grass or foliage LAST target mode will suppress close range results and provide the farthest range result.
2. Display Brightness (Lumatic OLED Display) – AUTO will be used in most cases which leverages the ambient light sensor located in the objective of the rangefinder. This sensor samples the ambient light conditions and automatically adjusts the display to the local environment. You can change this to 9 individual settings: LOW 1 – 3, MED 1-3 and HI 1-3. Note – if you accidentally leave the unit on Setting LOW 1 you may not be able to see the display. If this occurs, go into a dark environment and change the illumination setting.
3. Reticle Select – The center only aiming circle is the simplest aiming reticle which allows for an uncluttered field of view. You can change the reticle by adding horizontal milling features or both horizontal and vertical milling features in addition to the center aiming circle. The dots in the grid represent 5 milliradian increments and the major hash marks represent 10 milliradian increments.
4. Unit of Measure – Y for yards and M for meters.
5. Bluetooth – Your Bluetooth transceiver can be turned ON or OFF. If you have no intention of syncing custom profiles with the Sig Ballistic App you should turn Bluetooth OFF to reduce power consumption. Bluetooth is on by default. Note – if you have paired the rangefinder with a smartphone and would like to pair with a different smartphone you must cycle the Bluetooth transceiver OFF and then ON again to

reset the pairing setting. This feature was implemented to prevent different smartphones from pairing multiple times to different KILO2400ABS in case there are multiple units in close proximity. Note – at this time the KILO2400ABS will NOT pair with a Kestrel with Bluetooth.

6. Density Altitude – Density Altitude is air density given as a height above mean sea level. Some users prefer to use DA instead of ballistic holdovers using the embedded AB Elite calculator. DA is OFF by default. Note - DA is not enabled while using the AB Elite calculator for holdover.

To configure your rangefinder without ballistic holdovers, please follow these steps:

1. Press and release the RANGE button to turn on your rangefinder. You should see the wakeup status display.

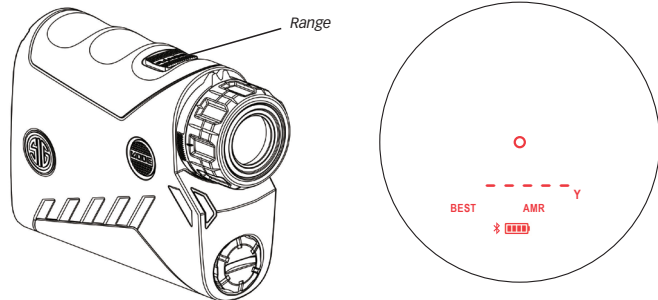

2. Press and hold the MODE button down for at least 2 seconds to enter programming mode. LOS or AMR will begin flashing (AMR is default). Release the MODE button. You can toggle between LOS and AMR by pressing and releasing the RANGE button. Your selection will be flashing LOS or AMR. Confirm and save your selection by pressing and releasing the MODE button to index to the next programming mode. If you do not press and release the MODE button the rangefinder will save your displayed setting (LOS or AMR) and turn off. LOS mode allows you to leverage the onboard ballistic calculator or simply return the line of sight range and angle of incline. AMR mode provides angle modified range or equivalent horizontal range and is best used with Sig Ballistic Turrets or for archery.

1. Press and hold down MODE
2 seconds

3. Press and release MODE to
index to next setting

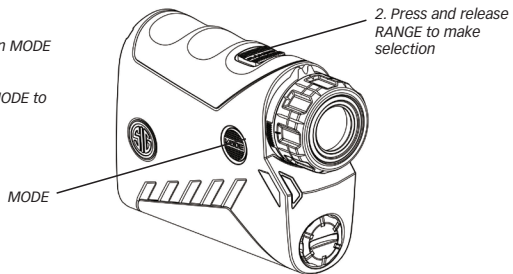

2. Press and release
RANGE to make
selection

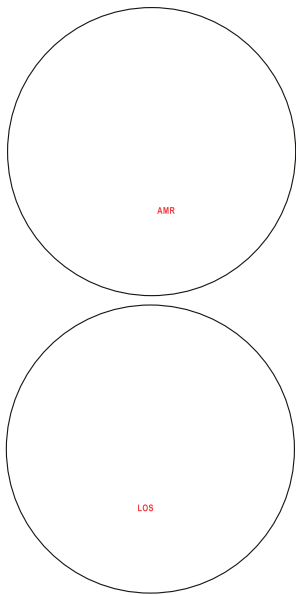

3. If you selected AMR and pressed and released the MODE button, then the rangefinder will index to Target Mode. BEST or LAST will be flashing. You can toggle between BEST or LAST by pressing and releasing the RANGE button. Confirm and save your selection by pressing and releasing the MODE button to index to the next programming mode. If you do not press and release the MODE button the rangefinder will save your displayed setting (BEST or LAST) and turn off. BEST Target Mode should be used in most situations, however, when hunting through foliage or in high grass the LAST Target Mode is recommended.

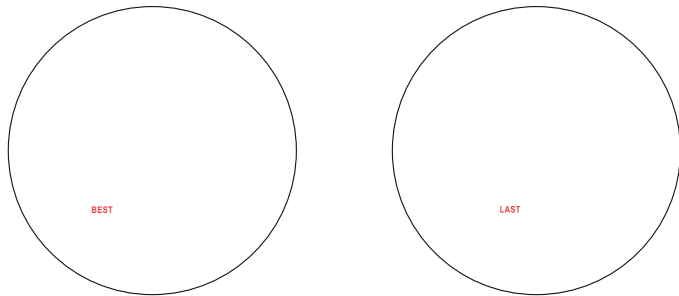

4. At this point you have selected AMR and Target Mode. You will now set the display brightness. AUTO is default and will be flashing. You can switch between 9 fixed settings (LOW 1 – 3, MED 1 – 3, HI 1 – 3 or AUTO) by pressing and releasing the RANGE button to index through the brightness selection. Confirm and save your selection by pressing and releasing the MODE button to index to the next programming mode. If you do not press and release the MODE button the rangefinder will save your displayed setting and turn off. AUTO Display Brightness is recommended.

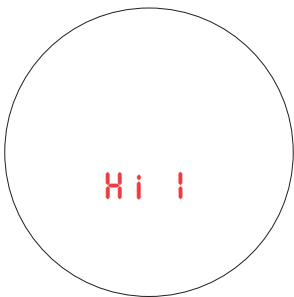
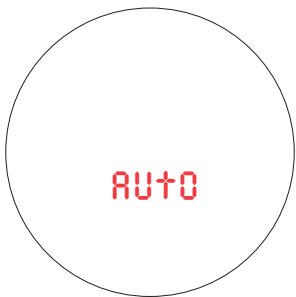

5. At this point you have selected AMR and set Target Mode and Display Brightness. You will now select an aiming reticle. Circle only is default and will be flashing. You can choose between three reticles by pressing and releasing the RANGE button to index through the reticles. Confirm and save your selection by pressing and releasing the MODE button to index to the next programming mode. If you do not press and release the MODE button the rangefinder will save your displayed setting and turn off.

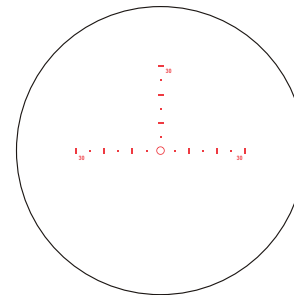
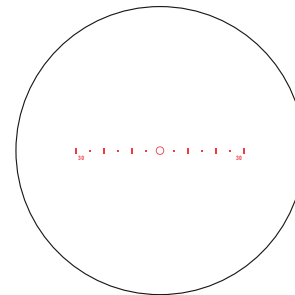
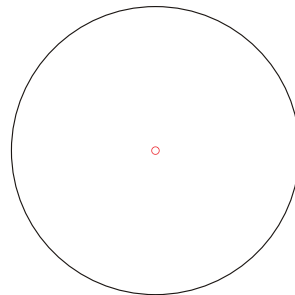

6. At this point you have selected AMR, set Target Mode, Display Brightness and selected an aiming reticle. You will now choose a unit of measure – Yards or Meters. Y for yards is default and will be flashing. Select a unit of measure by pressing and releasing the RANGE button to toggle back and forth. Confirm and save your selection by pressing and releasing the MODE button to index to the next programming mode. If you do not press and release the MODE button the rangefinder will save your displayed setting and turn off.

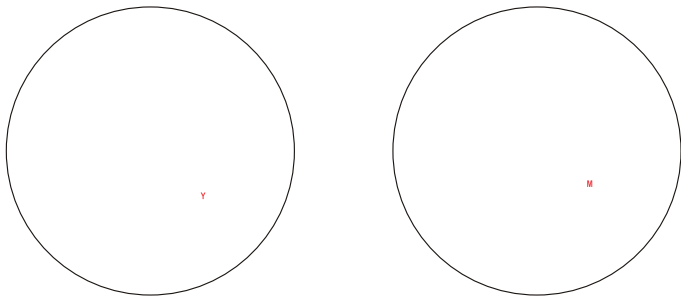

7. At this point you have selected AMR, set Target Mode, Display Brightness, selected an aiming reticle and set the unit of measure. You can now turn Bluetooth ON or OFF. Bluetooth is on by default and will be flashing. Turn ON or OFF by pressing and releasing the RANGE button to toggle back and forth. Confirm and save your selection by pressing and releasing the MODE button to index to the next programming mode. If you do not press and release the MODE button the rangefinder will save your displayed setting and turn off. If you are not using the Sig Ballistic App you should turn Bluetooth off to reduce power consumption and extend the runtime of your rangefinder.

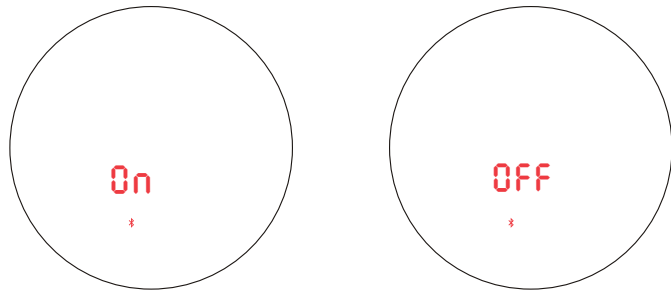

8. At this point you have selected AMR, set Target Mode, Display Brightness, selected an aiming reticle, set the unit of measure and turned Bluetooth on or off. You can now turn Density Altitude ON or OFF. DA is OFF by default and will be flashing. Turn ON or OFF by pressing and releasing the RANGE button to toggle back and forth. Confirm and save your selection by pressing and releasing the MODE button to index to the next programming mode. If you do not press and release the MODE button the rangefinder will save your displayed setting and turn off.

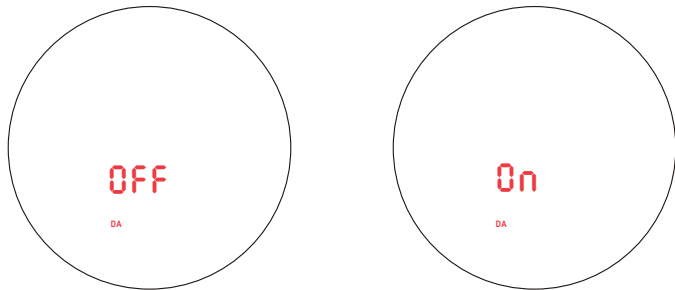

9. Looking back to Step 2, if you selected LOS and pressed and released the MODE button, then the rangefinder will index to Profile Selection. NoPro, Pro 1, Pro 2, Pro 3 or Pro 4 will be flashing. You can toggle between profiles by pressing and releasing the RANGE button. Confirm and save your selection by pressing and releasing the MODE button to index to the next programming mode. If you do not press and release the MODE button the rangefinder will save your displayed setting and turn off. NoPro should be selected if you DO NOT intend to use the onboard ballistic calculator. If you want to use the onboard ballistic calculator in conjunction with the Sig Ballistic App you should follow the instructions shown later in the manual. For this example, NoPro is selected and saved and the programming path is identical to the AMR path shown above.

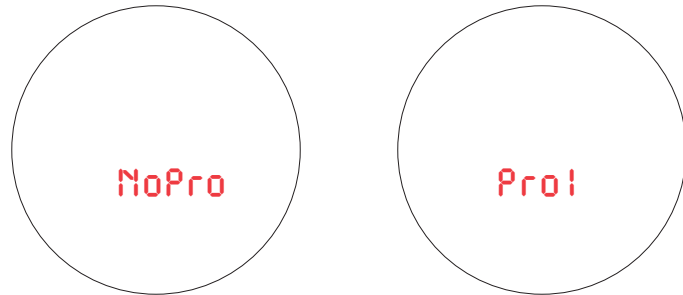

ADVANCED BALLISTIC OPERATION – Installing the app and downloading profiles

The KILO2400ABS was designed for long range shooters and hunters with onboard environmental sensors and an embedded ballistics calculator for greater precision at long distances. To get the most out of your rangefinder, download the Sig Ballistic App (KILO2400ABS) and synchronize your smartphone with your rangefinder. Once a ballistic profile is synchronized with your rangefinder you no longer need to carry your smartphone to take advantage of the advanced ballistics embedded on your rangefinder unless you intend to override environmental settings or anticipate needing real-time wind updates. By using the smartphone app simultaneously with the rangefinder you can see more information in real time by using the HUD in the app. Even better, you can actually range targets by using the RANGE button integrated on the HUD for remote operation.

In this section you will download the Sig Ballistic App (KILO2400ABS), set up a Ballistic Profile, configure your rangefinder by selecting one profile and then downloading one or more profiles to your rangefinder.

1. Go to the iTunes store to download the Sig Ballistic App (KILO2400ABS) to an iOS based Apple product. For Android products go to the Google Play store. Search for SIG SAUER® or Sig Ballistic App (KILO2400ABS). Download and install the app on your smartphone.



2. Once installed, launch the app – you will see the Home screen. You now need to sync your KILO with your smartphone. For iOS, all you need to do is ensure that Bluetooth is ON by going to Settings and sliding the toggle button until Bluetooth is ON. iOS devices automatically pair with your rangefinder from within the Sig Ballistic App. For Android you will need to formally pair the devices by going to Settings, then Bluetooth and sliding the toggle button ON. Make sure the rangefinder is nearby and also turned on by pressing and releasing the RANGE button. Your KILO2400ABS should appear as a nearby device – select your rangefinder and you are now paired. Once you have formally paired your Android smartphone with your KILO2400ABS, you will need to select the rangefinder from within the Home screen of the Sig Ballistic App. See images below.

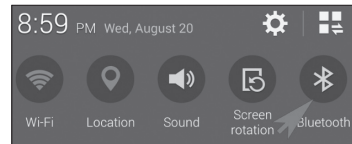
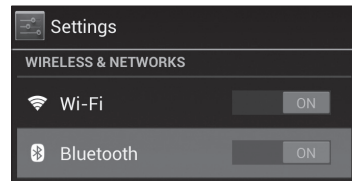

From the Home Screen touch the screen to the right of the Bluetooth icon. Your rangefinder should be listed if previously paired.

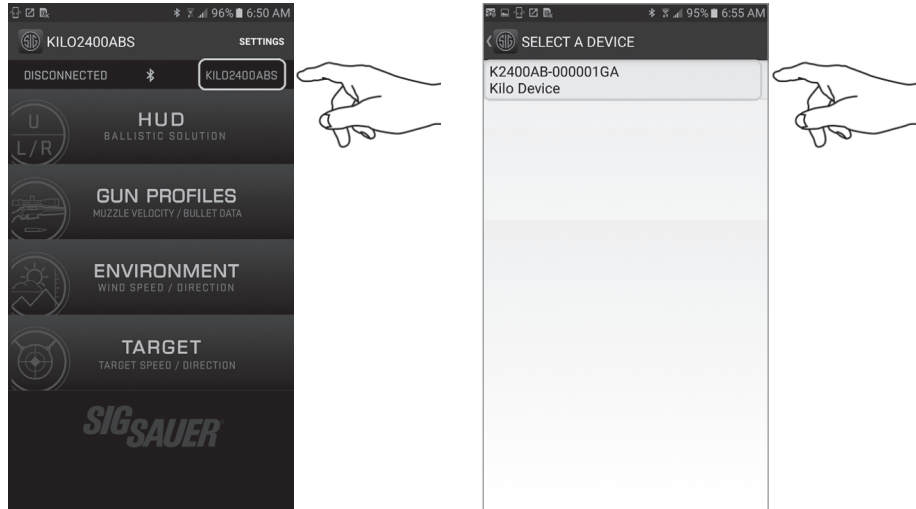

3. Within the GUN PROFILE menu, touch or select the + button to select a bullet to begin configuring your profile. Next, select a unique caliber then select a unique bullet. Once an exact bullet is selected you will be prompted to choose which drag curve to use: G1, G7 or Custom. If a Custom Drag curve is available it is recommended that you select the Custom Drag curve since this bullet will have exact BC

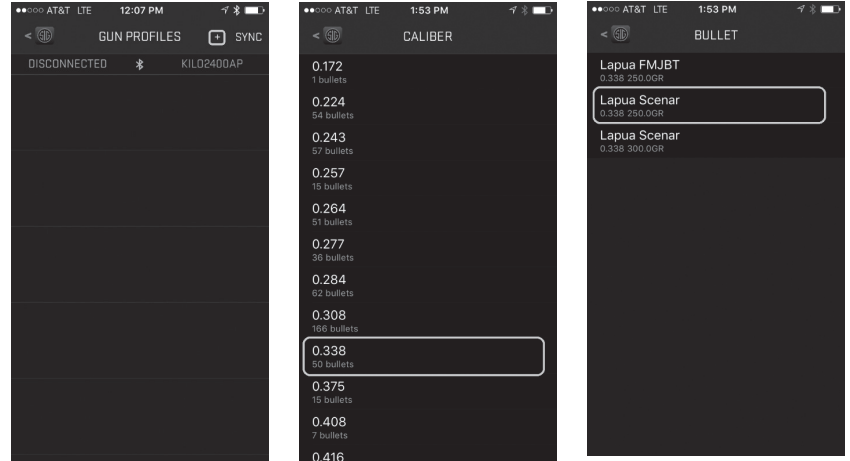

data for super, sub and transonic flight. Note – you can customize virtually any bullet characteristic that is in white (not greyed out). This is useful for those customers that hand load their ammunition or have characterized the rifle for such parameters such as muzzle velocity, sight height, bullet weight and zero range.

4. At this point you should have at least one profile listed in the GUN PROFILES menu. The smartphone display should look similar to either image below. Note that the smartphone is not connected to your rangefinder if the rangefinder has timed out and turned off.

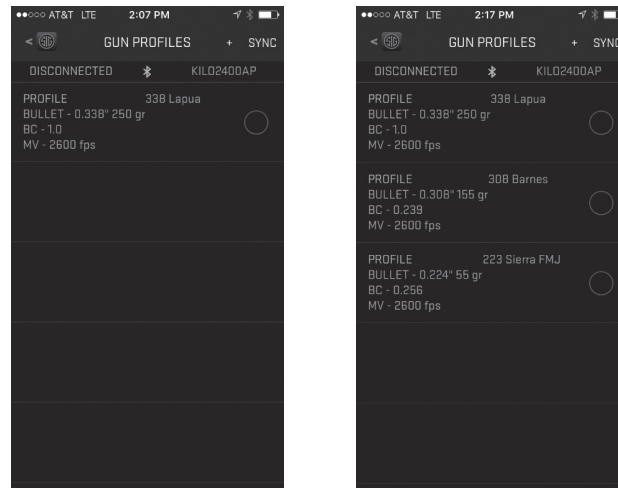
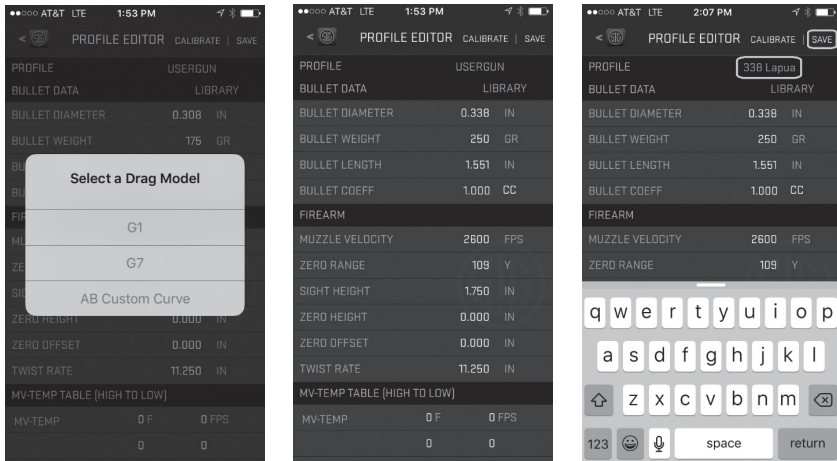

5. Now that you have one or more profiles created, you need to select which profiles are to be downloaded to your rangefinder. Press the grey circle next to the profile to select up to 4 profiles for synchronizing with your rangefinder. In this example 2 out of 3 profiles are set for synchronization:

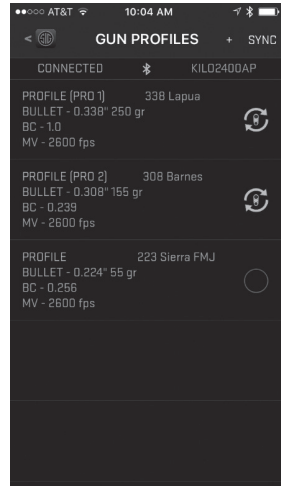
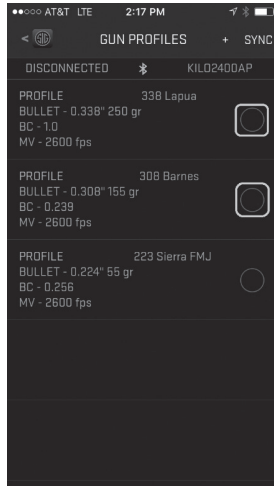

Make sure your rangefinder is active or on by pressing and releasing the RANGE button. You should see the word “CONNECTED” on the app. Touch or select the “SYNC” button in the upper right hand side of the screen and watch for the dialog box to show that the app and rangefinder are syncing. Once the dialog box disappears you have now downloaded your profile(s) to the rangefinder. You are now ready to use your rangefinder to determine elevation holds based on how you configured the rangefinder. This section will help you set your Wind Direction, Wind Speed Unit of Measure, Wind Velocity if not using the supplied WindMETER and the unit of measure for Holdover (MIL or MOA).

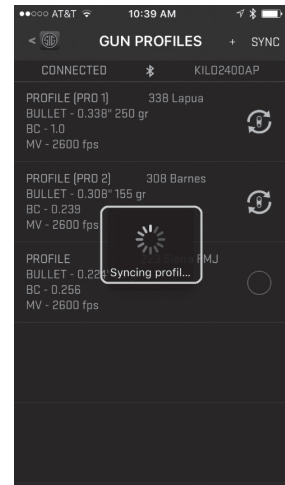
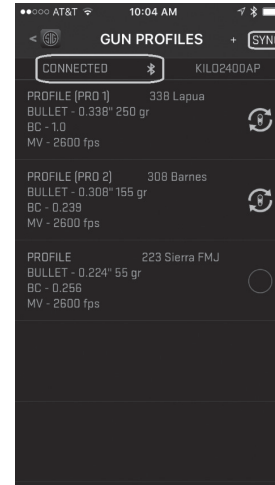

6. The next step is to enable a synchronized profile on your rangefinder by turning the rangefinder on by pressing and releasing the RANGE button. At the status display screen press and hold the MODE button for at least 2 seconds. Once in programming mode release the MODE button and follow the flowchart from page 13 by selecting LOS, advancing to Profile Selection (press and release the MODE button) and selecting Pro 1 (or Pro 2, 3 or 4) by pressing and releasing the RANGE button. Once a Profile is selected you can advance through the menu system to configure the other relevant settings such as Wind Direction, Wind Speed Unit of Measure, Wind Velocity, Holdover value and the other common settings.

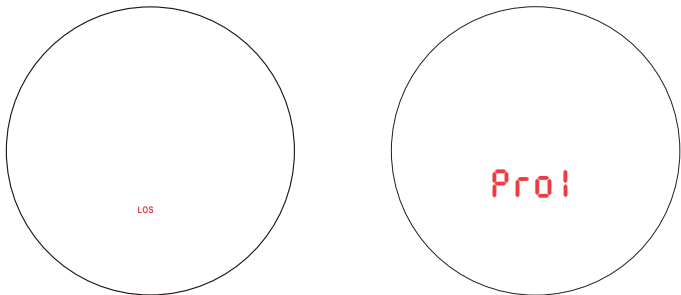

ADVANCED BALLISTIC OPERATION – Configuring wind and elevation holdover

1. For this section you will want to have your rangefinder in Programming Mode. Press and release the RANGE button to wake up the rangefinder. While looking at the status display on the rangefinder, press and hold the MODE button for more than 2 seconds to enter programming mode – then release the MODE button. Index through the menu system by pressing and releasing the MODE button – you will select LOS, then one of the Profiles (i.e. Pro 1).

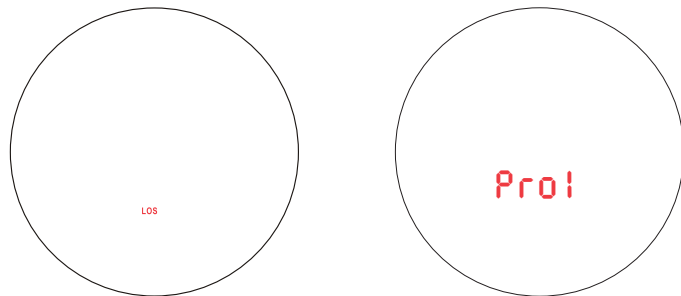

You will now see “WD” with “12:00” flashing. You can set your Wind Direction by pressing and releasing the RANGE button. The direction will change by 1:00 increments and represents the direction that the wind is coming from. Once set press the MODE button to save your wind direction and index to Wind Speed Unit of Measure. Note – you can override this setting by using the Sig Ballistic App and adjusting the heading on the app - press the SYNC button to override your settings on the rangefinder. Directions for the app will be shown later in the manual.



2. You have set your Wind Direction and now need to choose a Wind Speed Unit of Measure. The default setting is M/H (miles per hour or mph). Your display should show “WS” and “M/H” will be flashing. You can switch between M/H and M/S (meters per second) by pressing and releasing the RANGE button. Once your selection is flashing, press and release the MODE button to save your setting and index to Wind Speed Velocity.



3. You have set your Wind Direction, Wind Speed Unit of Measure (UoM) and now need to set the Wind Velocity. The default setting is 0. Your display should show "WS", "M/H" or "M/S" and "0" will be flashing. You can increment the wind velocity by 1 unit by pressing and releasing the RANGE button. If you press and hold the RANGE button down you can increase the digits faster up to a maximum of 40. Once your selection is set and flashing, press and release the MODE button to save your setting and index to Holdover Unit of Measure.



4. You have set Wind Direction Heading, Wind Speed UoM and Wind Speed Velocity. You will now choose your Holdover Unit of Measure. The default setting is "MOA" and will be flashing. You can toggle between MOA and MIL pressing and releasing the RANGE button. Once your selection is set and flashing, press and release the MODE button to save your setting and index to set the common settings such as Target Mode, Display Brightness, Reticle Selection and other common features as described earlier in the manual.

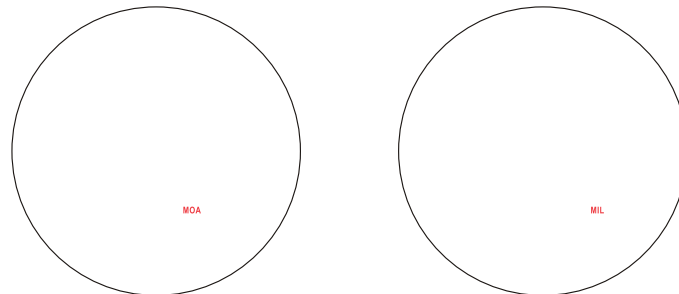

You have now installed your smartphone app, paired your phone with your rangefinder, created and configured one or more ballistic profiles, selected a profile on the rangefinder, synchronized your profiles with your rangefinder and configured all advanced settings. You can now use your rangefinder to calculate wind and elevation holds in real time.

Aiming your rangefinder at a distant target, press the range button to determine the line of sight range to your target. The LOS range will be displayed for 2 seconds, then your elevation holdover and finally your wind hold. These will repeat every 2 seconds for 30 seconds. A typical sequence is shown below where the range is "1347 m", the elevation hold is "UP 15.50 MIL" and the wind hold is "LEFT 8.25 MIL".

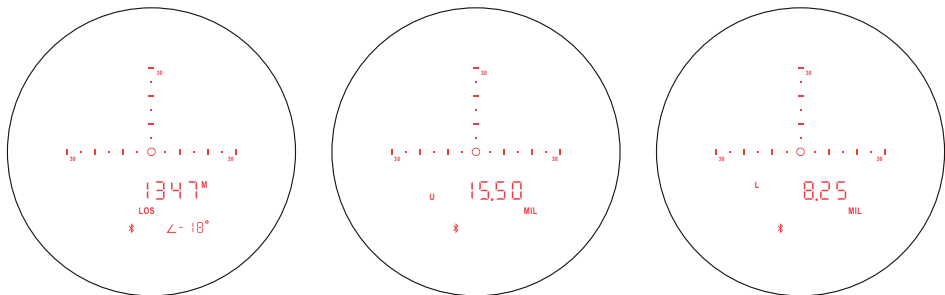

At this point you would adjust your turrets on your rifle scope to 15.50 MIL Up and 8.25 MIL Left.

SIG BALLISTIC APP

The SIG Ballistic App (SBA) was developed in partnership with Applied Ballistics and nVisti. The SBA should work on most modern smartphones running Android or iOS and includes the AB Elite version of the calculator and a complete bullet database with support for G1, G7 and Custom Drag Curves. When used with the KILO2400ABS you will be able to compute real time ballistic solutions in virtually any environment. The SBA will work remotely providing an ability to mount the rangefinder on a tripod and range targets all from within the HUD on the app.

In this section you will learn how to configure the app, navigate the app and modify / override environmental settings on the rangefinder. It will also include instructions on use of the WeatherFlow WindMETER.

1. Touch or select the SIG app on your smartphone. You will come to the Home screen on the app which has 4 sub menus. Relevant information is shown below:

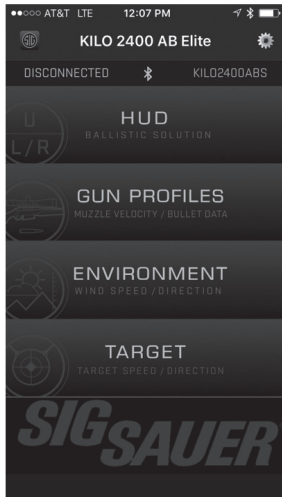

Settings

Connection Status

Heads Up Display

Displays real time range, hold and environmental information including the ability to remotely fire the rangefinder.

Gun Profiles

Select bullets from the database, configure custom ballistic profiles and synchronize them with your rangefinder.

Environment

Sample the wind using the WindMETER or override your settings on the rangefinder including wind and temperature.

Target

Input target parameters such as heading, incline, latitude, target speed and target direction.

2. Touch or select the Settings (User Preferences) icon in the upper right hand corner of the Home screen. You can toggle each of the settings by touching or selecting the white Unit Preferences. These are global settings that will work throughout the other submenus. Note – if you are struggling to keep the KILO2400ABS awake during programming or ranging you can adjust the sleep time to a maximum of 180 seconds. When you are finished configuring your settings just press the SIG button in the upper left hand corner to return to the Home screen.

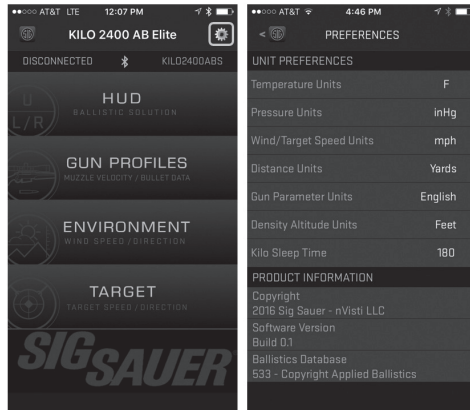

Temperature in F or C

Temperature in inHG or mbar

Wind Speed in mph or m/s

Distance in Yards or Meters

Gun Parameter Units in English and Metric

Density Altitude in Feet or Meters

Timeout for KILO – It is recommended to set this at 180

3. Heads Up Display – The HUD is configured to display real-time information from the paired rangefinder when ranging. Range, holdover and environmental information from the rangefinder is relayed over Bluetooth and displayed on the HUD. One of the most useful features is the remote RANGE button. During an active ranging session you can fire your rangefinder remotely by using this onscreen button. Note – ballistic holdover information will only be displayed if the rangefinder is set to LOS mode. If AMR is selected then only the angle modified range will be displayed.

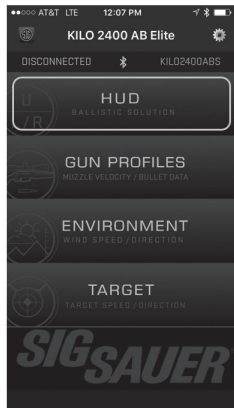

Connection Status

Remote Range Button

Wind Speed and Direction



Range information in Y or M

Elevation and Wind Holdover

Muzzle Velocity
Temperature
Pressure
Density Altitude
Energy at Target
Velocity at Target

When actively ranging targets while connected to your KIL0, you can update the wind speed directly from the HUD display screen. Press the round SYNC button in the upper right hand corner of the display to re-sync your wind setting without having to return to the Environment submenu.

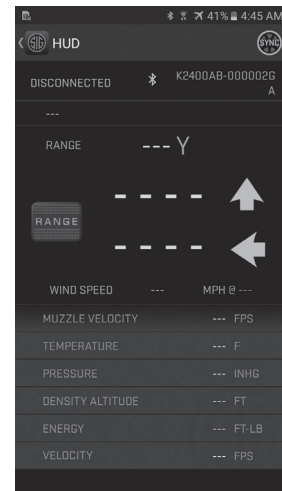

4. Gun Profiles – Creating, configuring, saving and syncing custom profiles were detailed earlier in the manual. In most cases you can modify virtually any parameter within the app where the text is shown in white color. In the example below the muzzle velocity for the 338 Lapua profile was updated to 3200 fps. Once edited press the SAVE button to return to the GUN PROFILE sub menu.

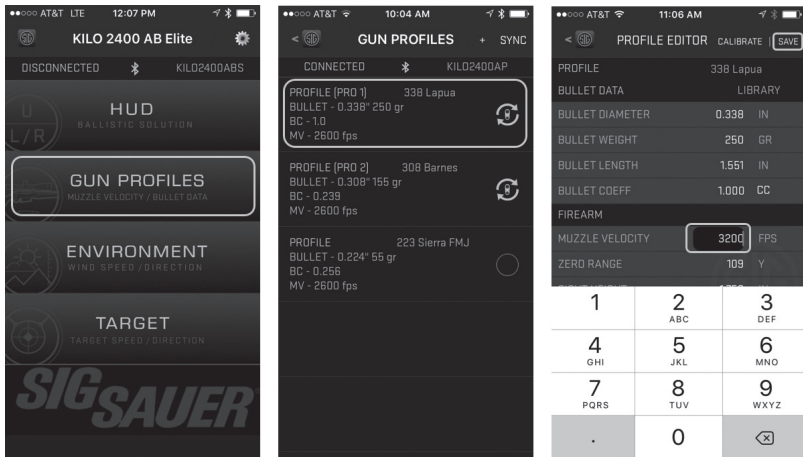

Within the GUN PROFILES sub menu you can better calibrate your muzzle velocity as a function of ambient temperature by inputting measured data into the MV-TEMP table within the PROFILE EDITOR. The rule of thumb is about 1 fps of muzzle velocity for each additional degree of temperature. You can also determine this with a temperature sensor and chronograph by recording muzzle velocity at different temperatures. An example is below. Be sure to SAVE your settings when complete:

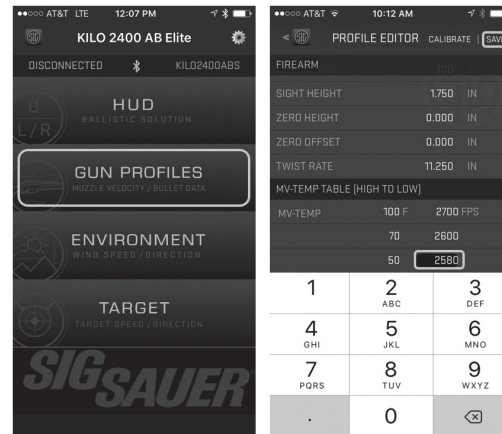

Scroll down on the PROFILE EDITOR to input muzzle velocity settings as a function of temperature. Press SAVE to save your settings and exit.



One additional feature provided within the Sig Ballistic App is the ability to calculate and set your muzzle velocity and drop scale factor empirically by using actual bullet drop at known ranges. The suggested ranges are based on your bullet selection. In this case select GUN PROFILES, then select a CUSTOM PROFILE (223 Sierra FMJ shown) and then press the CALIBRATE button at the top right hand side of the screen:

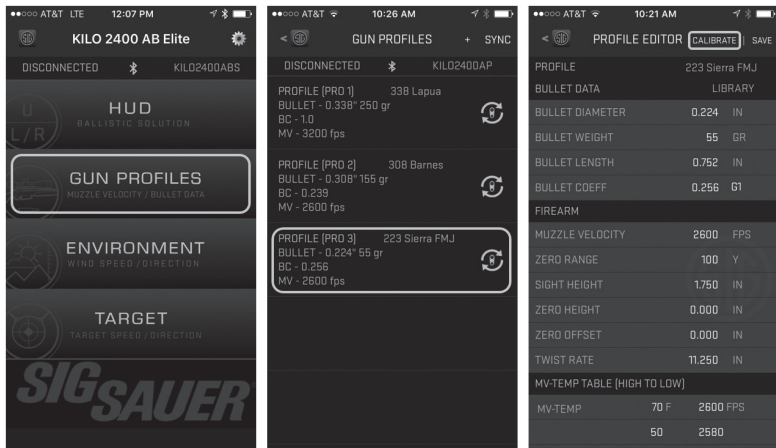

Within the CALIBRATION sub menu you will now enter your known target ranges and drop at each range. Once this information is input press the CALCULATE button and your results will appear similar to what you see below. You will note that the default MV for this bullet was 2600 fps but the measured MV was calculated to be 2624. You can now apply the calculated MV and DSF by pressing each button shown below. Note – you can apply the calculated MV or DSF or both. The typical calibration process is to set MV if you are shooting supersonic. If you are shooting subsonic it is suggested to apply both MV and DSF:

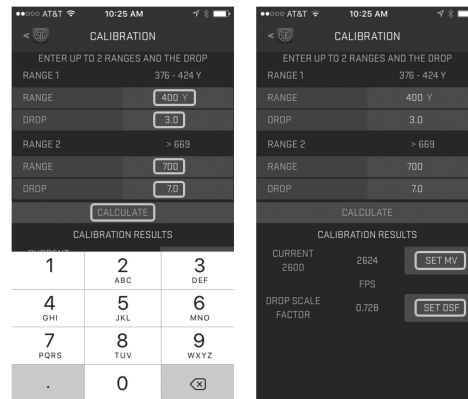

After inputting the actual drop data as a function of known ranges, press CALCULATE and then press SET MV and SET DSF to apply your new MV and DROP SCALE FACTOR for better accuracy.



5. Environment – From this screen you can adjust your Wind Direction. Wind Direction is the direction that the wind is coming from. You can override the rangefinder onboard sensors by touching on the Temperature, Pressure or Humidity data coming from the rangefinder and update any setting. Be sure that your connection is active and press the SYNC button to synchronize your settings with your rangefinder. In this example the included WindMETER is reading 11 mph, the Wind Direction is 8:00 and the sensor data is shown below the wind dial. The temperature setting is now controlled by your smartphone as the KILO icon has been switched to show that your smartphone is now setting the temperature.

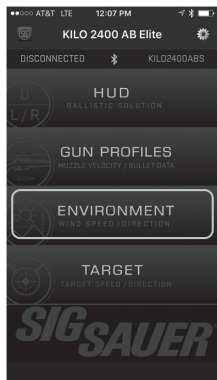

After adjusting for wind direction and any environmental parameters, and verifying that the rangefinder is connected, press the SYNC button to update the rangefinder. You are now ready to range.



Using your finger you can touch the numbers on the clock to adjust the Wind Direction. In this case the Wind Direction is 8:00 and the Wind Heading is 2:00. The wind is blowing from the 8:00 position towards the 2:00 position.

You can also override the environmental parameters from this screen. If the outside temperature is low and the rangefinder has been in your pocket, you may need to override the temperature setting by selecting the KILO icon to the left and manually updating the temperature to the right.



Note - The WeatherFlow WindMETER is included with the KILO2400ABS. For some smartphones, the WindMETER will not function properly due to incompatibilities from smartphone to smartphone. This is caused by insufficient drive current through the audio jack. Some newer smartphones no longer have an audio jack.

It is recommended that if you have wind measurement issues with the included WindMETER try downloading the WeatherFlow app to measure your wind speed and then manually input the wind speed and wind direction within the Sig Ballistic App. Alternatively, using an external Kestrel and then manually entering your wind speed and direction is also recommended.

If you are having trouble getting wind measurement with the included WindMETER, please remove the WindMETER, shutdown and relaunch the Sig Ballistic App and manually enter your wind speed and direction in the app or directly into the rangefinder.

6. Target – Use the Target sub menu if you are shooting moving targets. Heading, Inclination and Latitude all are pulled from the rangefinder. Target Speed and Target Direction are manual inputs. In the example below the Heading is 215', the target is at a decline of 16', the Latitude is 40.0' and the Target Speed has been input as 10 mph moving Right to Left. Verify that your rangefinder is connected and then press the SYNC button to synchronize your settings with your rangefinder.

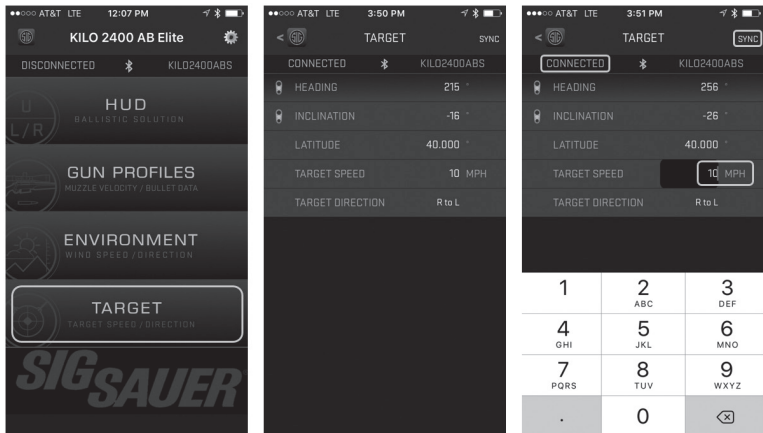

7. Compass Calibration – While using the KILO2400ABS you may notice that your compass heading may be off while viewing the Target submenu. Using a known compass while synced with your KILO, check the Target menu to determine if your compass heading is accurate (i.e. by aiming the KILO due north). If you determine there is a slight calibration offset, you can recalibrate your KILO by selecting Preferences from the Home Screen. Scroll down to Compass Calibration and press the START button to begin recalibrating your KILO to your local environment. Your KILO must be turned on and actively synced with your smartphone. Follow the onscreen instructions. Once recalibrated your KILO will return to the ready to range screen.

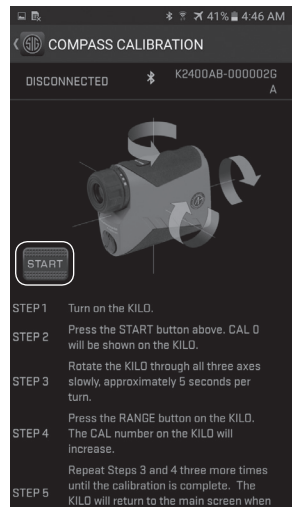
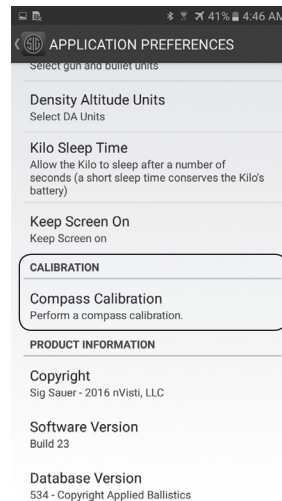

For custom calibration, select the Preferences from the Home Screen, then select Compass Calibration and follow the onscreen instructions

FREQUENTLY ASKED QUESTIONS (FAQ):

Q: I am pressing the RANGE button and nothing happens?

A: Check to make sure you have a fresh CR2 battery installed. If the battery is new, try loosening and tightening the battery cap until the cap is snug. If this doesn't fix the problem you may have switched the rangefinder into one of the low brightness settings for the OLED display. Go into a dark room and press the RANGE button. In this case, if the display becomes barely visible you need to go into programming mode and adjust the brightness to a medium or high setting, or put the display in AUTO adjust mode.

Q: Information on the display is disappearing – is this normal?

A: Yes. The rangefinder OLED display was optimized to only present the most important information while in use. Upon initial wake up, all your settings are visible such as the battery indicator, Line of Sight (LOS) or Angle Modified Range (AMR), LAST or BEST target mode and unit of measure. After the first range is acquired or in SCAN mode, after about 2 seconds, only the aiming circle and range information is displayed.

Q: I can't get the display to focus?

A: You need to adjust the diopter ring to your vision. The diopter ring is located in front of the eyecup and rotates approximately 40 degrees in either direction to accommodate your unique prescription.

Q: I can't seem to range past 1200 yards on trees?

A: The rangefinder will have very different performance based on changes in ambient conditions such as bright sunlight or snow, rain or fog, temperature and the reflectivity of the target being ranged. For example, at dusk or dawn your rangefinder may be able to range trees at over 2000 yards but in bright sunlight may only achieve 1100 yards. This is normal, however, the KILO is the highest performance compact rangefinder available.

Q: My battery seems to drain too fast?

A: Most commercial rangefinders will provide over 4000 individual range calculations using a fresh CR2 primary lithium battery. The KILO2400ABS has additional sensors and Bluetooth which consume more battery power. The rangefinder exceeds 4000 ranges on a fresh battery, however, when heavily using SCAN mode this will cause the battery to drain much faster as the range processor remains active at all times and you will quickly exceed 4000 range calculations due to the HyperScan mode. This is normal operation but you should always keep a spare CR2 battery when heading out to remote locations. You can also turn off Bluetooth to extend your runtime.

Q: My Bluetooth link between my smartphone and my rangefinder keeps disconnecting?

A: You can update your Settings / Preferences from the home screen on your app. Click on the Settings / Preferences button in the upper right hand corner of the screen and then change the KILO Timeout setting to 30, 60 or 180 seconds. This will keep the rangefinder awake longer allowing you to synchronize and update settings. However, by increasing the KILO Timeout settings this will also force you to wait longer to put the rangefinder back into Programming Mode. You will have to wait for the rangefinder to timeout, wake the unit back up by pressing the RANGE button and then pressing and holding down the MODE button for 2 seconds to re-enter programming mode. Or, alternatively, you can close the Sig Ballistic App and then enter programming mode if you don't want to wait for the rangefinder to time out.

If you are still experiencing connection issues make sure you are using the latest version of the Sig Ballistic App. You can update your app from the App Store or the Google Play store. You may also need to turn your Bluetooth radio OFF and back ON again to restore the link.

Q: I'm getting a different temperature reading from my rangefinder when I know the ambient temperature is different?

A: If you are carrying the rangefinder in a pocket or it is sitting in the sun it may sense a different temperature than the ambient environment. You can either let your rangefinder sit in the shade for a few minutes or you can override the temperature by entering the Environment sub menu on the app, touching the KILO icon next to the word "TEMPERATURE" and manually entering the temperature – be sure to press SYNC to update the temperature on the rangefinder.

Q: My rangefinder is not calculating elevation and wind holds – no holds are showing up on the OLED display or in the HUD on the app?

A: Your rangefinder is probably set to AMR (Angle Modified Range). In AMR mode only the angle modified range is displayed on the HUD and on the OLED display. Go into Programming Mode and switch the range mode from AMR to LOS. Next, select a Profile (i.e. Pro 1). Be sure to have at least one Profile configured on your app and synchronized with your rangefinder.

Q: My rangefinder is not working. I've tried everything but the display will not turn on.

A: It is possible that you have set the display brightness to setting LOW 1. Go into a dark room and press the RANGE button. You should see the display. Press and hold the MODE button down to enter the programming mode. Press and release the MODE button until you see the display setting (i.e. Low 1). Press the RANGE button to select a different setting such as Hi 1 or AUTO. AUTO is recommended as the display will now automatically adjust to the correct brightness based on your local conditions. Once selected continue pressing the MODE button until you exit the programming mode.

Q: I've plugged the WindMETER into my smartphone jack and I still do not get a wind reading.

A: On some versions of Android, your smartphone may not be able to provide enough current to the WindMETER to obtain an accurate wind reading. In this case you may be better off downloading the WeatherFlow wind meter app and using this app to obtain a wind reading. You will then need to manually update the wind reading in the ENVIRONMENT page of your Sig Ballistic App. We apologize for any inconvenience but due to the large variety of smartphones and different software loads we could not guarantee functionality in every configuration.

If you continue to have trouble getting the WindMETER to accurately measure the wind speed it is recommended that you remove the WindMETER and use an external wind meter (i.e. Kestrel) and manually enter the wind speed and direction into the app or directly into the rangefinder.

Q: When in SCAN mode my rangefinder turns off after 20 seconds, is this normal?

A: Yes - the SCAN mode is limited to 20 seconds to remain eye safe in all conditions. You can reenter SCAN mode by releasing and pressing the RANGE button again.

KILO2400ABS SPECIFICATIONS

Magnification	7x		
Objective Clear Aperture	25mm		
Exit Pupil	3.6mm		
Eye Relief	15mm		
Angular (FOV)	6.78°		
FOV @ 100yds	35.67 ft		
Laser Divergence	1.3 mrad		
Range Response Time	.25 sec		
Scanning	Yes		
Range Accuracy Under 100 yds	.1 yds		
Max Range	Reflective up to 2 miles	Trees up to 1,800 yds	Deer up to 1,400 yds
Weight with Battery	7.5 oz / 215 g		

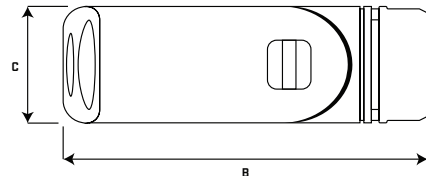
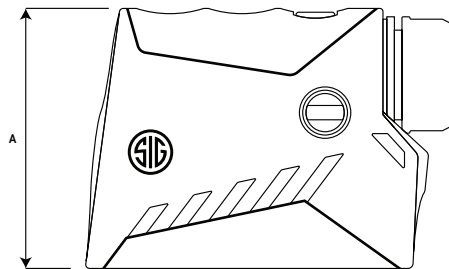

A – 3 in / 76mm
 B – 4.2 in / 107mm
 C – 1.3 in / 33mm

⚠ DANGER

CLASS 3R LASER PRODUCT INVISIBLE LASER RADIATION - AVOID DIRECT EYE EXPOSURE

This product complies with IEC 60825-1: 2014-05 Ed 3.0 and complies with FDA performance standards for laser products except for deviations pursuant to Laser Notice No. 50, dated June 24, 2007.

$P_o < 20W, \lambda = 905 \text{ nm}, t = 22 \text{ ns}$



This product has been tested and found to comply with the limits for a Class B digital device, pursuant to Part 15 of the FCC Rules. The equipment generates, uses and can radiate radio frequency energy and, if not installed and used in accordance with these instructions, may cause harmful interference to radio communications. However, there is no guarantee that interference will not occur in a particular installation. If this product does cause interference to radio or television reception the user is encouraged to try to correct the interference by one or more of the following:

- Reorient or relocate the receiving antenna
- Increase the separation between this product and the receiver
- Connect the equipment to an alternative outlet or receiver
- Consult a technician.

Shielded interference cable must be used with the equipment in order to comply with the limits for a digital device pursuant to Subpart B of Part 15 of FCC Rules.

Specifications and designs are subject to change without any notice or obligation on the part of the manufacturer.

⚠ WARNING

This device complies with part 15 of of the FCC Rules. Operation is subject to the the following two conditions: (1) This device may not cause harmful interference, and (2) this device must accept any interference received, including interference that may cause undesired operation.

⚠ CAUTION

- Use of controls or adjustments or performance of procedures other than those specified herein may result in hazardous radiation exposure. • Changes or modifications not expressly approved by the party responsible for compliance could void the user's authority to operate the equipment.

CLASS 3R LASER PRODUCT INVISIBLE LASER RADIATION AVOID DIRECT EYE EXPOSURE

This product complies with IEC 60825-1:2014 Ed.3 and Complies with FDA performance standards for laser products except for deviations pursuant to Laser Notice No.50,dated June 24,2007.

$P_o < 20 W, \lambda = 905 \text{ nm}, t = 22 \text{ ns}$

SIG SAUER Inc.
19861 SW 95th Ave.
Portland, OR 97062



LASER APERTURE



SIG SAUER Electro-Optics Infinite Guarantee™

SIG SAUER has manufactured the most rugged, dependable high-performance firearms for over two centuries. Our heritage of design, engineering and precision-manufactured quality predates the existence of any other optics company worldwide. We understand the importance of quality in the line of fire, at the shooting range or on your next hunt. SIG SAUER Electro-Optics had to earn the right to wear that badge and the Infinite Guarantee has your back, forever. Period.

We will repair or replace your SIG SAUER product in the event it becomes damaged or defective, at no charge to you. If we cannot repair your product, we will replace it with a product in perfect working order of equal or better physical condition. It doesn't matter how it happened, whose fault it was, or where you purchased it.

SIG SAUER Infinite Guarantee™

- Unlimited Lifetime Guarantee
- Fully Transferable
- No Warranty Card Required
- No Receipt Required
- No Time Limit Applies
- No Charge

If you ever have a problem, no matter the cause, we promise to take care of you when it counts. Please note that our Infinite Guarantee does not provide coverage for intentional damage, misuse, cosmetic damage that does not affect the performance of the optic, loss, theft or unauthorized repair or modification. Excludes electronic components.



SIG SAUER Electronic & Tritium Component Limited 5-Year Warranty

For components not included under the SIG SAUER® Infinite Guarantee™, this warranty covers any defects in materials and workmanship in the electronic and Tritium components of illuminated riflescopes/sights, pistol sights, electronic sights, flashlights, lasers, binoculars, spotting scopes, and rangefinders. This warranty lasts for five years from the date of manufacture. If, during that five-year period, these products are found to have electronic or Tritium component defects in materials or workmanship, SIG SAUER will repair your product, at no charge to you. If we cannot repair your product, we will replace it with a product in perfect working order of equal or better physical condition.

NOTES:

NOTES:



FOR PRODUCT SERVICE ON THIS MODEL, PLEASE CALL 603-610-3000

19861 SW 95th Avenue, Portland, OR 97062 USA