

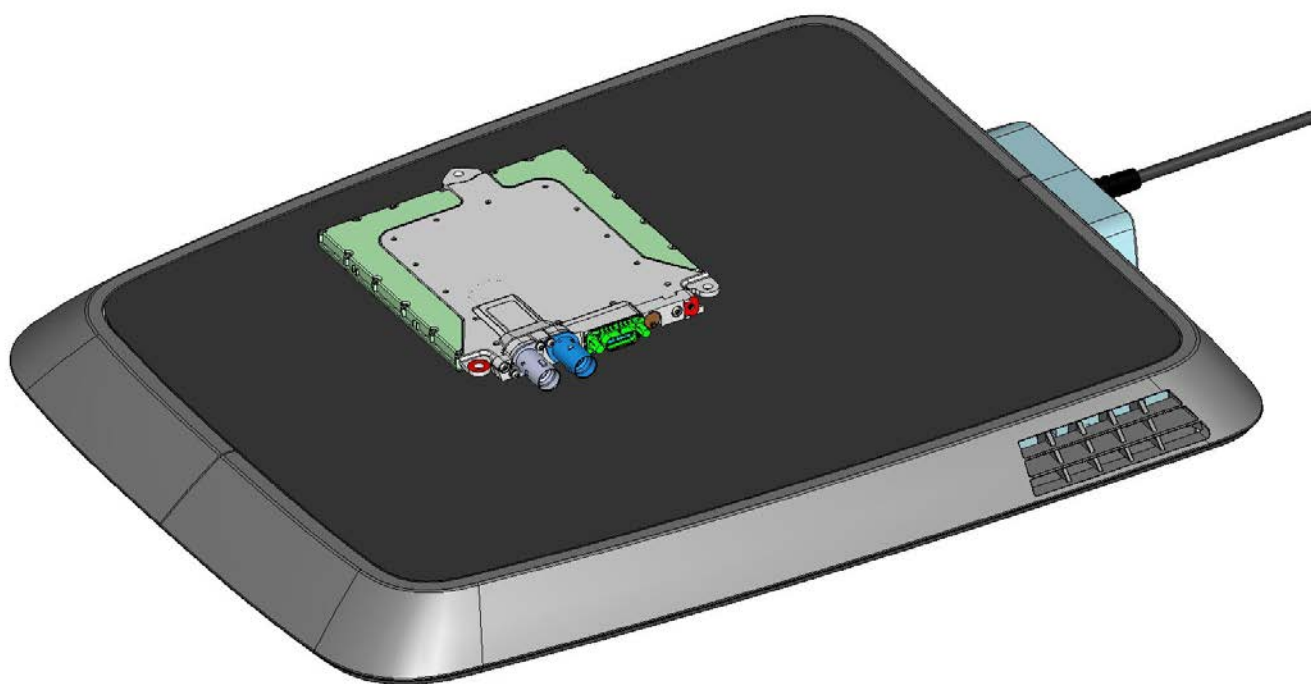

OPERATION MANUAL

INDUCTIVE CHARGING SYSTEM ICS115

- INDUCTIVE CHARGING SYSTEM ICS115 -
FOR INSTALLATION – OPERATION – MAINTENANCE



Translation of original operation manual (English)
Read carefully before use! Keep safe for later reference!

IMPRINT

Title	OPERATION MANUAL INDUCTIVE CHARGING SYSTEM ICS115
Publisher	BRUSA Elektronik AG Neudorf 14 CH-9466 Sennwald T +41 8175 819-00 F +41 8175 819-99 www.brusa.biz info@brusa.biz Managing Director: Josef Brusa
Valid for	ICS115 (2017)
Edition	1 st Edition
Number	07/2018
Date of Issue	15.02.2018
Online version	Can be found at www.brusa.biz
Copyright	© 2017 – 2018 BRUSA Elektronik AG The copyright of this document lies with BRUSA Elektronik AG. The content of this document must not be passed on to third parties – even in extracts – without the written authorization of BRUSA Elektronik AG. All technical specifications, drawings and photos used are protected by copyright. The violation of the copyrights represents a criminal offence!
Updates	Due to the technical further development of our products, we reserve the right to make constructional changes. Any changes will be notified in the individual manuals through exchange of the relevant pages or revision of the electronic data carrier.
Writing style	For reasons of better readability, the simultaneous use of feminine and masculine linguistic forms is dispensed with. All personal designations are always applicable for both genders.
Creator / Author	Pirmin Bader, Sina Kaufmann, Josef Olliges

REVISION INDEX

REVISION	DATE	NAME	CHANGE
1.0	07.02.2017	Pirmin Bader	Technical documentation based on the B3 prototype stage
2.0	24.02.2017	Sina Kaufmann	Redesign of the documentation
3.0	11.04.2017	Josef Olliges	Integration of review comments
4	03.05.2017	Josef Olliges	Integration of review comments BMW, notes from risk analysis
5	18.07.2017	Josef Olliges	Review comments Daimler, BMW integrated
6	30.10.2017	Josef Olliges	Review comments Zollner integrated, Update GPM-B4

7	15.02.2018	Josef Olliges	Review comments Approval
---	------------	---------------	--------------------------

TABLE OF CONTENTS

1	List of Abbreviations	7
2	Foreword	8
2.1	Content and Scope of this Manual	8
2.2	Requirements for handling the User Manual	8
3	Identification of the Product ICS	9
3.1	Product Identification	9
3.2	Explanation of the code for the product identification	9
3.3	Service- and Contact Data	10
3.4	Scope of Supply	11
4	Product Description of the ICS	12
4.1	Scope of Application	12
4.1.1	User Description	12
4.1.2	Health Hazards	12
4.1.3	Proper Intended Use	13
4.1.4	Proper Intended Application	13
4.1.5	Improper Use	13
4.1.6	Delimitation	14
4.2	Functionality	14
4.2.1	Energy Efficiency	15
4.3	Requirements of the ICS	15
4.4	Emissions	15
4.5	Electromagnetic Compatibility	15
5	Safety and Warning Signs	16
5.1	Symbols and their Meaning	16
5.2	Safety Instructions and Danger Levels	17
5.3	Generally Applicable Safety Instructions	19
5.3.1	Safety Instructions for Thermal Hazards	19

5.3.2	Safety Instructions for Electrical Hazards	19
5.3.3	Safety Instructions for Handling and Operation	20
5.4	Safety Equipment / Power Limitations	22
5.4.1	Overvoltage Protection	22
5.4.2	Mains Protection Input Current	22
5.4.3	Overcurrent Protection	22
5.4.4	Thermal Overload Protection (Derating)	23
5.4.5	HV Interlock	23
5.4.6	Living Object Detection (LOD)	23
5.4.7	Foreign Object Detection (FOD)	24
5.4.8	Control of the Efficiency	24
5.4.9	Enabling the Positioning	25
5.4.10	Automatic Shutdown of the Charging Operation	25
5.5	Warnings	26
5.5.1	Warnings	26
6	Commissioning and Use of the ICS	27
6.1	Installation of the GPM and Commissioning	27
7	Control and Operation	30
7.1	Use of the CPM and the GPM	30
7.2	Use of the Charging Function of the ICS	30
7.3	Displays and Signals	31
7.3.1	LED Display	31
7.4	GPM Cooling System Fan	34
7.5	Emergency Situations	34
7.6	Troubleshooting by the User	35
8	Maintenance	36
8.1	Cleanliness	37
8.1.1	Cleanliness of the CPM	37
8.1.2	Cleanliness of the GPM	37
8.2	Behavior after a vehicle accident	38
9	Deinstallation	38
10	Disposal	38
10.1	Notes for Customer Service	38

11	Legal Notices	39
11.1	Warranty	39
11.2	Company Names	39
12	Annex A1	40
12.1	Technical Specifications of the ICS	40
12.1.1	Emissions	40
12.1.2	Dimensions and Center of Gravity	40
12.1.3	Dimensions CPM [mm]	1
12.1.4	Center of Gravity CPM [mm]	42
12.2	Technical Data	43
12.2.1	Conditions for Storage and Transport of the ICS	44
12.2.2	Conditions for Operation of the ICS	44
12.2.3	Mechanical Data of the CPM	45
12.2.4	Mechanical Data of the GPM	45
12.3	Requirements on Specialist Personnel	45
12.3.1	Specialist Requirements	45
12.3.2	Health-related Requirements	45
12.4	Information about Protective Equipment	45
12.4.1	Protective Equipment during Transport and Storage	45
12.4.2	Protective Equipment during Installation	46
12.4.3	Protective Equipment during Operation	46
12.4.4	Protective Equipment during Disposal / Deinstallation	46
12.5	Preparation of the ICS for Use	46
12.5.1	Installation Information	46
12.5.2	Placement of the GPM	46
12.5.3	Alignment of GPM to CPM	46
12.5.4	Optional Installation of the GPM with Mounting Rails	48
12.5.5	Line Connections CPM	50
12.5.6	Line Connections GPM	50
12.5.7	Planning the Assembly and Installation of the ICS	52
	Planning the assembly and installation of the CPM, see Annex 12.7.4	52
12.5.8	Transport and Storage	52
12.6	Deinstallation of the GPM	54

12.6.1	Procedure for the Deinstallation of the GPM (Information for Customer Service):.....	54
12.7	Vehicle Integration of the CPM	55
12.7.1	Installation Information.....	55
12.7.2	Mounting the CPM.....	55
12.7.3	Line Connections CPM	56
12.7.4	Planning the Assembly and Installation of the CPM	60
12.7.5	Transport and Storage of the CPM	60
12.7.6	Installation of the CPM.....	61
12.7.7	Deinstallation of the CPM	62
13	Annex A2	64
13.1	Standards and Legal Requirements.....	64
13.2	DECLARATIONS OF CONFORMITY	65
13.2.1	SIMPLIFIED EU-DECLARATION OF CONFORMITY ICS115	65
13.2.2	SIMPLIFIED EU-DECLARATION OF CONFORMITY ICS1-WLAN-ATWILC-MU-D	65
14	Index	66
15	Glossary	68

1 List of Abbreviations

In the course of this manual several trade-specific abbreviations are used. An overview as well as their meanings can be found in the following table:

ABB.	DESCRIPTION	ABB.	DESCRIPTION
AC	<u>A</u> lternating <u>C</u> urrent	ICSP	ICS <u>P</u> rimary (GPM)
B [T]	Magnetic flux density B in Tesla T	ICSS	ICS <u>S</u> econdary (CPM)
C [F]	Electrical capacity C in Farad F	LOD	<u>L</u> iving <u>O</u> bject <u>D</u> etection
CAN	<u>C</u> ontroller <u>A</u> rea <u>N</u> etwork	LV	<u>L</u> ow <u>V</u> oltage
CPM	<u>C</u> ar <u>P</u> ad <u>M</u> odule	OEM	<u>O</u> riginal <u>E</u> quipment <u>M</u> anufacturer
DC	<u>D</u> irect <u>C</u> urrent	P [W]	Power P in Watt W
EMC	<u>E</u> lectro <u>M</u> agnetic <u>C</u> ompatibilty	R [Ω]	Electrical <u>R</u> esistance in the unit Ohm Ω
f [Hz]	Frequency f in Hertz Hz	RCD	<u>R</u> esidual <u>C</u> urrent <u>D</u> evice
FOD	<u>F</u> oreign <u>O</u> bject <u>D</u> etection	s [m]	Distance s in Meter m
FW	<u>F</u> irm <u>w</u> are	SSID	<u>S</u> ervice <u>S</u> et <u>I</u> Dentifier
GPM	<u>G</u> round <u>P</u> ad <u>M</u> odule	SW	<u>S</u> oft <u>w</u> are
HV	<u>H</u> igh <u>V</u> oltage	t [s]	Time t in second s
I [A]	Electrical Current <u>I</u> ntensity I in Ampere A	T [°C]	Temperature T in degrees Celsius °C
ICS	<u>I</u> nductive <u>C</u> harging <u>S</u> ystem (CPM+GPM)	U [V]	Electrical voltage U in Volt V

2 Foreword

Valued Customer!

With the BRUSA Inductive Charging System Model ICS115 you have purchased an inductive charging system with the latest technology. Model ICS115 is an inductive charging system of the 1st Generation for vehicles with high-voltage battery, which is subsequently abbreviated to ICS. Since it concerns high-performance electronics devices, we expect particular caution when dealing with it as well as when handling it!

Read through this manual carefully – in particular the chapter entitled *Safety and Warning Signs* – before you install the device or perform other work on it!

2.1 Content and Scope of this Manual

INFORMATION



In order to successfully commission the system, you require this user manual. The completeness and topicality is ensured with provision of the customer package. Updates of individual documents are performed automatically and are visible in a history.

This documentation conveys to the reader an overview of all the work steps required for the installation as well as operation of the system and the safety measures necessary for this.

The specified operation- and safety instructions must be observed precisely, in order to continuously ensure the function of the system.

The customer package contains the following registers:

- Inductive charging system (ICS), consisting of Ground Pad Module (GPM) and Car Pad Module (CPM)
- User manual

2.2 Requirements for handling the User Manual

The user manual must be read and understood by all persons who work with or use the ICS.

All safety instructions at the beginning of a chapter are valid in equal measure for all subsequent and associated subchapters following the chapter.

As user and also as customer service of the ICS, familiarize yourself with the user manual, so that you have fast access to required information. Keep the user manual safe for later reference. Select an appropriate storage location, so that the user manual is ready to hand and easy to find.

3 Identification of the Product ICS

3.1 Product Identification

This manual is valid exclusively for the devices listed in the following table:

ICS1 WITH THE FOLLOWING DEVICE DESIGNATIONS

ICSP11W-U0-01X-Xxx (GPM)

ICSS115-U0-01X-Xxx (CPM, 2-HV-Connectors)

3.2 Explanation of the code for the product identification

The breakdown of the device designation for the complete system, the GPM and the CPM, is as follows:

GPM:

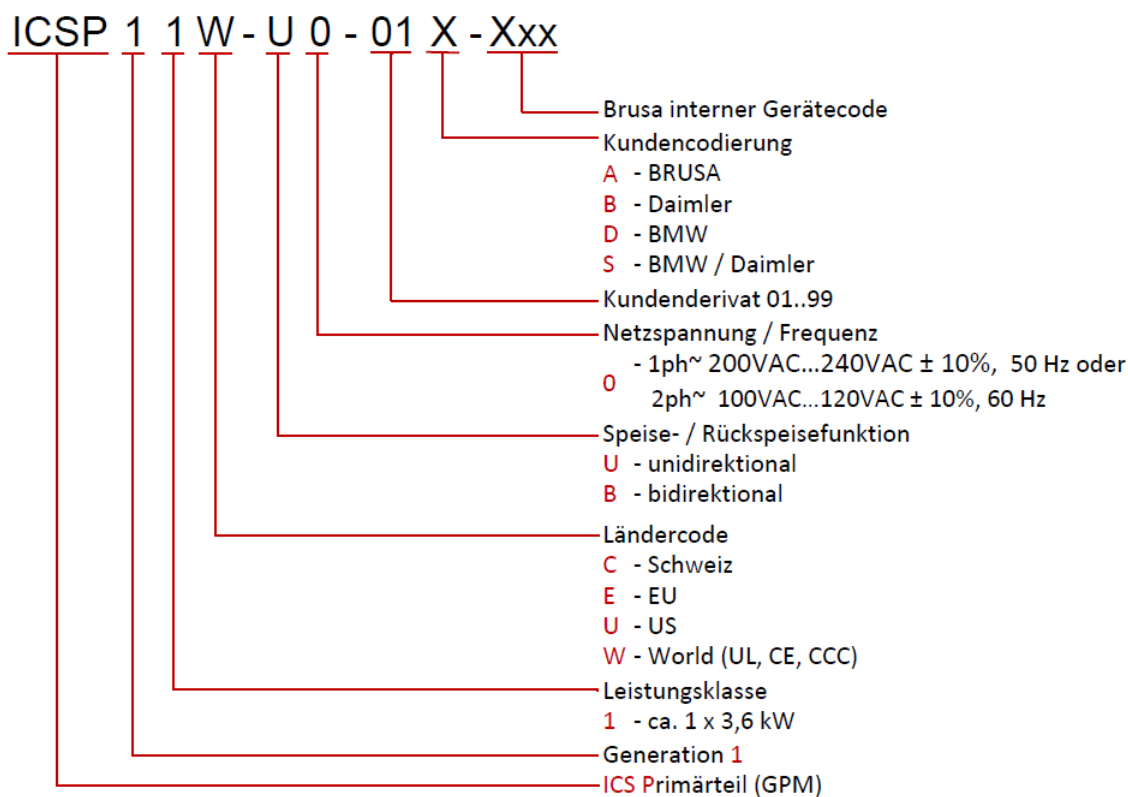

CPM:

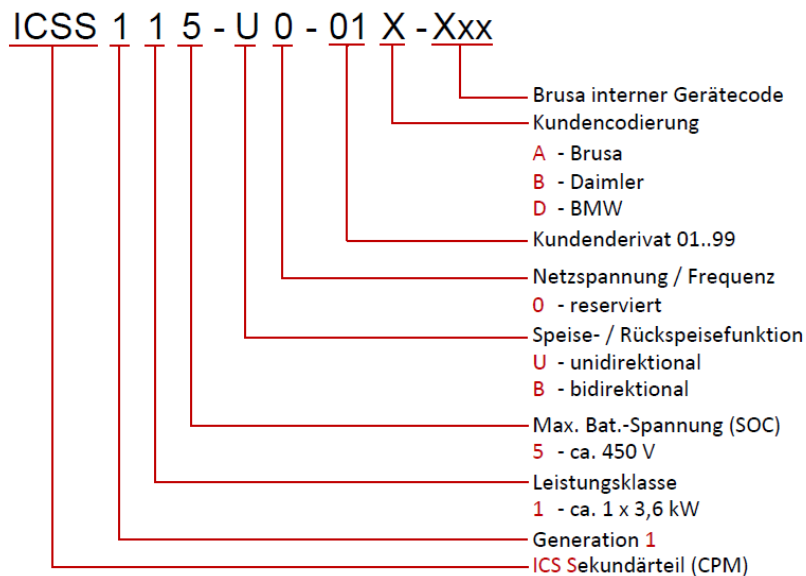

3.3 Service- and Contact Data

TYPE OF INQUIRY	COUNTRIES	CONTACT DATA
Delivery Help and Support Deinstallation and Disposal	D, A, CH	BMW Customer Support D-80788 Munich Germany Tel: +49 89 1250-16000 kundenbetreuung@bmw.de

3.4 Scope of Supply

The following items are included in the scope of supply of the ICS system

DESCRIPTION	QUANTITY	ILLUSTRATION
1 Ground Pad Module (GPM)	1	
2 Car Pad Module (CPM)	1	
3 Original Operation Manual	1	

4 Product Description of the ICS

4.1 Scope of Application

The ICS consists of two separate devices. The Ground Pad Module (GPM) thereby forms that part connected to the power supply network, which transmits the energy to the Car Pad Module (CPM) integrated in the vehicle. The communication between GPM and CPM is automated and takes place via WLAN.

NOTE



Note:

The Car Pad Modules of the possible variants from chapter 3.1 function with all Ground Pad Modules (GPM) of the ICS.

4.1.1 User Description

The user group of the system ICS includes all persons who are able to operate a vehicle. The user of the system is responsible for the observance of and compliance with the safety instructions contained in this user manual. The user is also responsible, that persons in his environment, in particular all persons who come into contact with the ICS, are knowledgeable of and familiar with the safety instructions in this user manual. The user must indicate possible hazards due to the ICS to other persons. He must thereby ensure, that individual, particularly endangered persons, e.g. children and disabled persons, have understood the safety instructions – or on the other hand ensure, that access to the ICS is not possible for these persons.

All activities that concern the installation, commissioning and deinstallation / disposal of the ICS may only be performed by specialist personnel. The specialist personnel or qualified electricians must satisfy the specialist requirements specified in chapter 12.3.

4.1.2 Health Hazards

WARNING



Risk of injury from electromagnetic field!

With inductive charging an electromagnetic field is generated under the vehicle.
Cardiac pacemakers and medical implants can be affected.



Do not reach underneath the vehicle or perform maintenance work during the charging process.

The electromagnetic radiation of the ICS remains within the legally permitted limits. During the charging process, the following groups of people are exposed to increased health risks in the vicinity of the ICS:

- People with active medical implants (e.g. cardiac pacemakers, defibrillators)
- People with passive medical implants (e.g. stents)
- People with electrically conductive foreign objects in their bodies (e.g. metallic splinters from accidents / war injuries)

4.1.3 Proper Intended Use

It is not permitted to use the products in any way other than the intended way described in section 4.1.4.

4.1.4 Proper Intended Application

The ICS is a system for the cordless transmission of energy and is designed to be integrated in an electric or hybrid vehicle with high-voltage battery. The product ICS is designed exclusively for use under consideration of the limits specified in chapter 12.2.1 and 12.2.2.

With a planned use in areas other than those previously defined, the purchaser shall be obliged to coordinate this accordingly in advance with the manufacturer and obtain a written release for this.

4.1.5 Improper Use

All applications that are not included in the intended use described by the manufacturer in 4.1.4 are to be regarded as improper use.

The device must **not** be used, in particular

- for charging vehicles that do not use the ICS as charging function
- for charging accumulators / batteries of devices, that are also based on an inductive charging function, e.g. electric toothbrushes, Smartphones
- to replace the function of an induction hob, e.g. heating meals by using pots / bowls / grilling appliances
- for drying objects (e.g. skiing equipment) or living things (e.g. pets)
- for the use for functions other than the function of charging, e.g. as seating surface or for sports activities, such as skateboarding.

The following areas must not be used as charging station, i.e. for the installation of the GPM:

- public parking places and parking lots

Under consideration of the proper intended uses specified in chapter 4.1.4, limits have been defined for the storage, transport and operation of the ICS product, see chapter 12.2.1 and 12.2.2. The product must not be used outside these limits within the respective life phases. Modification of products.

It is not permitted to undertake modifications to the product and then continue to use the product.

4.1.6 Delimitation

This operation manual describes the safe handling with the Inductive Charging System in all phases of life. BRUSA Elektronik AG accepts no liability for the incomplete passing on of information from this document, in particular to those persons from the target group defined in chapter 4.1.1 and any damage resulting therefrom.

4.2 Functionality

The ICS consists of two separate devices. The Ground Pad Module (GPM) thereby forms that part connected to the power supply network, which transmits the energy to the Car Pad Module (CPM) integrated in the vehicle by means of magnetic induction. The communication between GPM and CPM is automated and takes place via WLAN.

Basically the charging process takes place in these steps:

- The vehicle parks over the GPM with the help of the positioning function with optimal coverage between GPM and CPM.
- The charging process is started automatically from the vehicle and also ended automatically.
- After the charging process the battery is charged according to the charging time and the charging efficiency. The vehicle is ready to use.

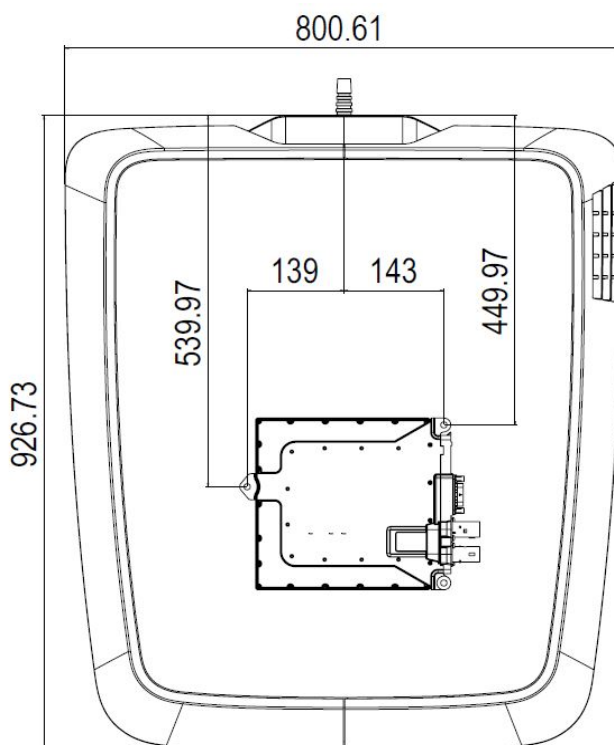

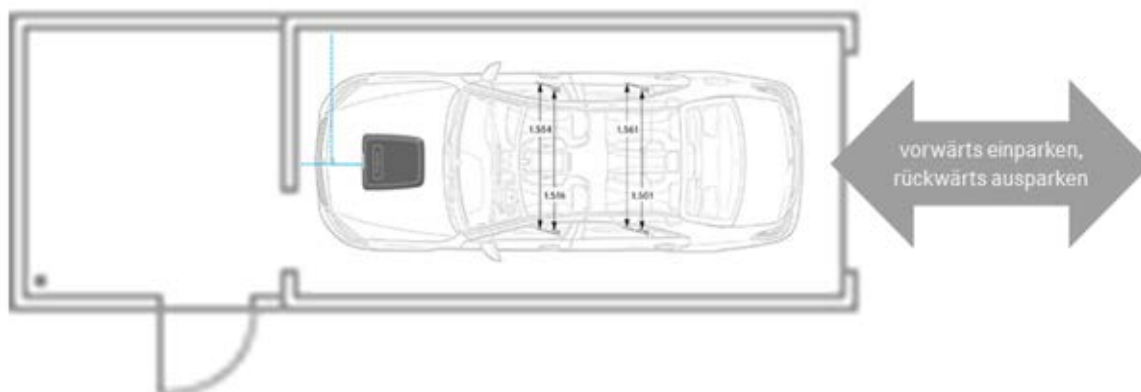

4.2.1 Energy Efficiency

The energy efficiency is generally dependent on the parking position of the vehicle over the GPM during the charging process. Maximum efficiency is achieved when you park in the optimal position range. The efficiency of the charging process depends, among other things, on the parameters of the drive battery (e.g. performance and charging cycle) of the vehicle in which the ICS is installed.

4.3 Requirements of the ICS

The CPM is maintenance-free and does not require any supply materials, such as coolant, lubricants, etc. For the cooling of the GPM, air circulation is a prerequisite, in particular during the charging process. Regular cleaning of the fan intake duct and keeping the GPM clean extends the service life of the charging system, see chapter 8.1.2.

4.4 Emissions

The ICS has a fan which causes a noise level during operation. No hazardous chemical substances are emitted. The transmission of energy of the ICS as well as the positioning functionality are based on the principle of magnetic induction. In addition WLAN is used for the communication between the two components CPM and GPM. Associated with this are emissions due to electromagnetic radiation. The characteristic values of these emissions are to be taken from Table 1: Emissions.

4.5 Electromagnetic Compatibility

The ICS system meets the requirements on the electromagnetic environmental compatibility without constraints, see No. 11 – 15, 22 in Table 3: Standards. Normally no disturbances that unacceptably impair the functionality of other electrical operating equipment are caused through the use of the ICS. Nevertheless, a disturbance of Comfort Access Systems of adjacent vehicles cannot be excluded, since both systems are based on the use of WLAN.





5 Safety and Warning Signs

In this chapter you will find safety instructions that must be taken into consideration in all life phases of the system. Read and observe these instructions without fail, in order to safeguard the safety and the life of people as well as avoid damage to the device!











5.1 Symbols and their Meaning

Various symbols are used throughout this manual. An overview as well as their meanings can be found in the following tables:

PROHIBITORY SIGNS

SYMBOL	DESCRIPTION	SYMBOL	DESCRIPTION
	General prohibition		Attention high voltage Touching prohibited
	Switching prohibited		No access for people with cardiac pacemakers or implanted defibrillators.



WARNING SIGNS

SYMBOL	DESCRIPTION	SYMBOL	DESCRIPTION
	General warning of a hazard point		Warning of electric shock
	Warning of potentially explosive environment		Warning of dangers from batteries
	Warning of hot surface		Warning of high electric voltage
	Warning of non-ionizing radiation		Warning of the risk of fire
	Warning of magnetic field		Warning of hot surfaces

MANDATORY SIGNS

SYMBOL	DESCRIPTION	SYMBOL	DESCRIPTION
	Disconnect device		Disconnect device from the mains
	Wear safety glasses		Wear protective gloves

INFORMATION SIGNS

SYMBOL	DESCRIPTION	SYMBOL	DESCRIPTION
	Important information for the avoidance of possible material damage		Important Information

5.2 Safety Instructions and Danger Levels

DANGER



This sign warns of serious, irreversible risks of injury with possible fatal consequences!
Avoid this danger by observing this notice!

WARNING



This sign warns of a serious, but reversible risk of injury!
Avoid this danger by observing this notice!

CAUTION



This sign warns of a minor risk of injury!
Avoid this danger by observing this notice!

NOTICE



This notice warns of possible material damage, if the following instructions and work sequences are not observed.

INFORMATION



This type of notice is used to communicate important information for the reader.

5.3 Generally Applicable Safety Instructions

5.3.1 Safety Instructions for Thermal Hazards

DANGER



Explosive Environment!
Danger to life!

Do not store any highly flammable substances or combustible liquids in the immediate vicinity of the devices! The generation of sparks at the device connections can ignite these materials and lead to an explosion!

CAUTION



Hot Surfaces!
Risk of burning!

The devices generate high temperatures during operation! Therefore always touch them carefully and with caution!

5.3.2 Safety Instructions for Electrical Hazards

DANGER



High Voltage!
Danger to life!

Do not touch HV-lines or HV-connections under any circumstances without ensuring zero voltage beforehand!



The device may only be connected by a qualified electrician!

Do not bridge or bypass safety equipment under any circumstances! Resulting malfunctions can have life-threatening consequences!

CAUTION



Overheating the cable!
Risk of fire!

Mains connection cables must not be operated coiled up. In the coiled up state the cable can ignite due to a build-up of heat! Therefore basically uncoil the mains connection cable completely!

INFORMATION

Basically observe the following 5 safety rules when working on the HV network:

Completely de-energize the system.

- Switch off the ignition
- Pull out service- / maintenance plug or switch off main battery switch
- Remove fuse



Secure system against restarting.

- Keep ignition key secured against unauthorized access.
- Keep service- / maintenance plug secured against unauthorized access or secure main battery switch against restarting with lockable cover cap.

Establish zero voltage with suitable voltage tester (observe voltage range!)

Ground and short-circuit system.

Cover or cordon off adjacent live parts.

5.3.3 Safety Instructions for Handling and Operation

DANGER



Danger of electric shock!

In the operating state the ICS is subjected to high voltages and currents. If the device is damaged it is possible, that live components are exposed. People can come into contact with these components.



It is therefore absolutely imperative to operate the GPM via a separate residual current device (RCD), which monitors exclusively the function of the GPM.

WARNING



Heating of foreign objects during the inductive transmission of energy!

Risk of fire!

Electrically conducting objects inside the charging magnetic field can heat up considerably, and under certain circumstances can lead to damage / ignition of other materials. Therefore during the charging process there must be no objects between CPM and GPM.

WARNING



GPM Magnetic Field!

Danger for living beings and objects!



No person must connect a GPM to the power supply without knowing the safety- and warning signs. A GPM may only be connected to the power supply, when all persons who are working near the GPM are aware of the potential dangers.



DANGER**Strong magnetic field (non-ionizing radiation)!****Effect on living beings!**

During the charging process there is a strong magnetic field between CPM and GPM, which exceeds the limits for long-term exposure of living beings.



In order to exclude acute effects, such as muscle- and nerve stimulation, as well as consequential damage, no body parts may get into and around the space between the GPM and CPM during the charging process.



In addition, jewelry (rings, wristwatches, etc.) can heat up considerably and become damaged or lead to burns.

People with a cardiac pacemaker, implanted defibrillator or other implants should keep away from the vicinity of the system during the charging process.

Keep animals away from the system during operation.

NOTICE**Damage to the HV-Battery:**

- Make sure, that the voltage ranges of the device and the HV-battery are identical!
- Use only technically suitable and high-quality cabling! In case of uncertainties, please contact BRUSA Elektronik AG beforehand at the manufacturer address specified in chapter 3.3.

NOTICE**Damage to the devices:**

- Regularly check the GPM for defects and report defects or damage to your customer service.
- A visibly damaged GPM must be replaced, in order to exclude the risk of injury. Do not touch an obviously damaged GPM under any circumstances
- Check generally when connecting the GPM, that the mains voltage is in the permissible range (see chapter 4.2.1)!
- Do not establish a low-resistance connection between the HV contacts, the housing- as well as the LV-contacts under any circumstances! This leads to malfunctions and ultimately to the destruction of the device!
- The components of the ICS must not be opened under any circumstances!
- Do not install and operate the GPM in the immediate vicinity of heat sources!
- A high ambient temperature reduces the service life! Therefore continuously ensure for sufficient cooling of the device!
- Prevent any penetration of liquids in the device (e.g. during installation work)! The penetration of liquids leads to a short circuit and subsequently to damage of the device!
- If any liquid has entered, do not start the device again under any circumstances and contact your customer service!

5.4 Safety Equipment / Power Limitations

The charging system has several safety functions in order to avoid personal injury and material damage during commissioning, operation and maintenance of the system. Essentially these are

- Monitoring of the electrical limits
- Monitoring the operating temperatures
- Foreign object detection
- Living object detection
- Monitoring the efficiency
- Positioning only with connected HV-battery

DANGER



Danger for persons due to strong magnetic field (non-ionizing radiation)!

During the charging process it is not permitted under any circumstances to move/shift the GPM.

5.4.1 Overvoltage Protection

An overvoltage protection is integrated in the GPM, which continuously protects the device from overload damage. Overvoltages in the mains are detected by the fast sensor system and lead to the shutdown of the device.

An overvoltage protection is also integrated at the output side. By means of the fast sensor system, overvoltages at the HV-battery side (e.g. load shedding or -fluctuations) are detected and lead to the shutdown of the charging device.

5.4.2 Mains Protection Input Current

In the GPM the phase and the neutral conductor are each protected by a 25 A device fuse, in order to protect the device and the electrical installations from damage due to overcurrent. If these fuses are defective, then the relevant device must be sent back to the manufacturer (see manufacturer address in chapter 3.3)! Contact customer service.

5.4.3 Overcurrent Protection

NOTICE



It is prescribed to insert suitable overcurrent protection between CPM and HV-battery of the vehicle!

An overcurrent protection is integrated in the CPM, which continuously protects the charging device from overload damage. Overcurrents are detected by the fast sensor system and, depending on the strength, are either reduced or lead to the shutdown of the charging process.

5.4.4 Thermal Overload Protection (Derating)

This safety equipment is self-protection of the system. If an internal component of the GPM or the CPM reaches a defined temperature threshold, this causes a reduction of the charging capacity (Derating), in order to protect the component and consequently the device from damage due to overheating. As a result the capacity is reduced proportional to the temperature increase, in order to keep the temperature in the target range. The GPM regulates the fan according to the temperature and ensures for additional cooling of the GPM.

The CPM and the GPM notify their respective Derating-Status in the CAN, as well as the capacity reduction as percentage. When the CPM goes into derating, the GPM reduces the transmission power. If the measures taken above do not achieve the desired success, this leads to a shutdown of the charging system.

If the temperature is increased due to external effects independent of the charging system and the energy transmission process, then the function of the secondary systems can also only be used to a limited degree or cease their function temporarily. This concerns the systems Positioning, WLAN, CAN and Diagnostic Function.

5.4.5 HV Interlock

The Interlock is a safety loop in the vehicle, which monitors the drive components. On the CPM the HV-side plug connections can be monitored with this. The wiring of the Interlock-Pins is not functionally relevant for the CPM, however to guarantee the safety we definitely recommend using an interlock system!

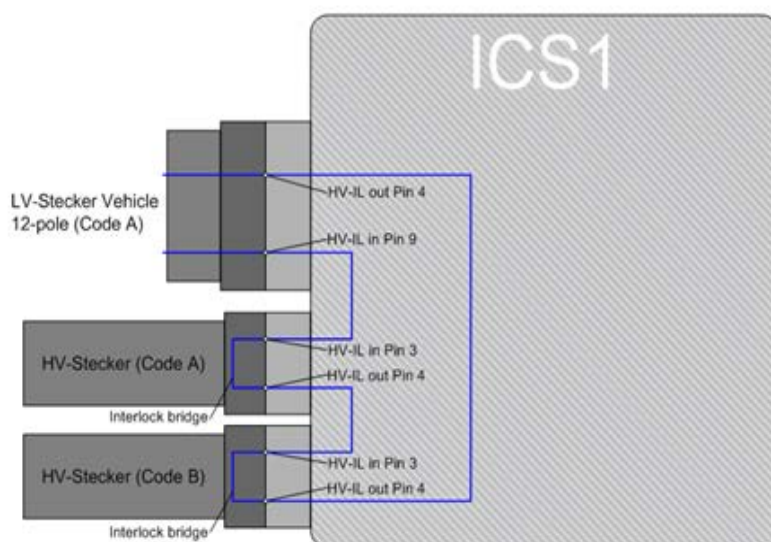

5.4.6 Living Object Detection (LOD)

DANGER



Danger for persons due to magnetic field (non-ionizing radiation)!

This function does not replace the attention of the user, to keep away from the charging station during the charging process!

It can happen, that body parts or living beings are not detected by the LOD function and as a result the protection from electromagnetic hazards is restricted!

The LOD function ensures, that body parts of people or animals are detected in the space between GPM and CPM. This safety function protects people or animals from the dangers of the strong electromagnetic field, with the charging process stopping when a living object is detected. It depends on the vehicle integration, whether the charging process is resumed automatically as soon as the living object is no longer detected by the GPM.

5.4.7 Foreign Object Detection (FOD)

DANGER



Danger for persons due to magnetic field (non-ionizing radiation)!

This function does not replace the duty of the user, to keep the charging station free of foreign objects!

It is possible, that certain foreign objects are not detected by the FOD function and as a result the protection from thermal dangers is restricted!

The FOD function ensures, that there are no electrically conducting foreign objects on the GPM during the charging process. Electrically conducting objects are relevant, as they can experience heating through electromagnetic induction in the electromagnetic field. This function stops the charging process when a foreign object is detected. This safety function prevents a heating up of electrically conductive foreign objects during the charging process and consequently reduces thermal dangers, such as e.g. fire or hot surfaces.

This function must be initialized during commissioning and after mains failures, see 7.3.1.2. In rare cases this initializing can also be necessary during normal operation, see 7.3.1.2.

5.4.8 Control of the Efficiency

DANGER



Danger for persons due to magnetic field (non-ionizing radiation)!

This function does not replace the duty of the user, to keep the GPM free of foreign objects!

It is possible, that certain foreign objects are not detected due to the function of the Efficiency Control and as a result the protection from thermal dangers is restricted!

If the efficiency falls below a certain limit value, e.g. due to the vehicle rolling away during charging, then the charging process is shut down. As a result it is ensured, that no energy is transmitted to the system environment. This safety function also prevents the heating of electrically conductive foreign objects during the charging process and thus reduces thermal dangers, such as e.g. fire or hot surfaces.

5.4.9 Enabling the Positioning

With this safety function it is ensured, that no electrical voltage is present on the HV-outputs of the CPM (see chapter 12.7.3), if the connections are not connected. Vice versa, voltage can only be present on the HV-connections of the CPM, if they are connected with a voltage source of 170 V (e.g. through connection to the vehicle drive battery). This prevents people getting an electric shock by touching the connections.

5.4.10 Automatic Shutdown of the Charging Operation

With the occurrence of one of the following conditions, the ICS terminates the charging operation:

- Detection of a foreign object (FOD) during charging
- Detection of a living object (LOD) during charging
- Overvoltage on the CPM HVDC-connector (> 450 V or greater than the specified maximum value)
- Undervoltage on the CPM HVDC-connector (< 170 V)
- Separation of the Interlock circuit
- Missing CAN commanding to the CPM
- Failure of the 12 V supply of the CPM
- Short circuit on HVDC
- Failure of the mains voltage
- Voltage jumps on HVDC
- Voltage drop AC-mains supply
- Fault of the WLAN-connection
- Overtemperature of the CPM (> 120°C)
- Overtemperature of the GPM (> 85°C)
- Load Dump (load shedding)
- Charging capacity < 500 W
- Mains failure (no independent restart of the energy transmission when the mains supply returns)
- Communication failure between GPM and CPM
- Communication failure between CPM and vehicle-CAN (Vehicle-CAN, VCAN)
- With a change of position of the CPM until the device is no longer physically able to transmit energy
- Malfunction in the device

5.5 Warnings

5.5.1 Warnings

Warning signs are attached to the devices, which warn the operator of possible dangers. On the GPM there are warning notices and a rating plate on the underside. In addition, enclosed in the GPM service flap there is a rating plate as well as information about which types of cables are suitable for the connection of the power supply and which temperature resistance is required for these cables. If one of these warning signs is missing or no longer legible due to wear, it must be renewed immediately! To obtain an original label, please contact your customer service!

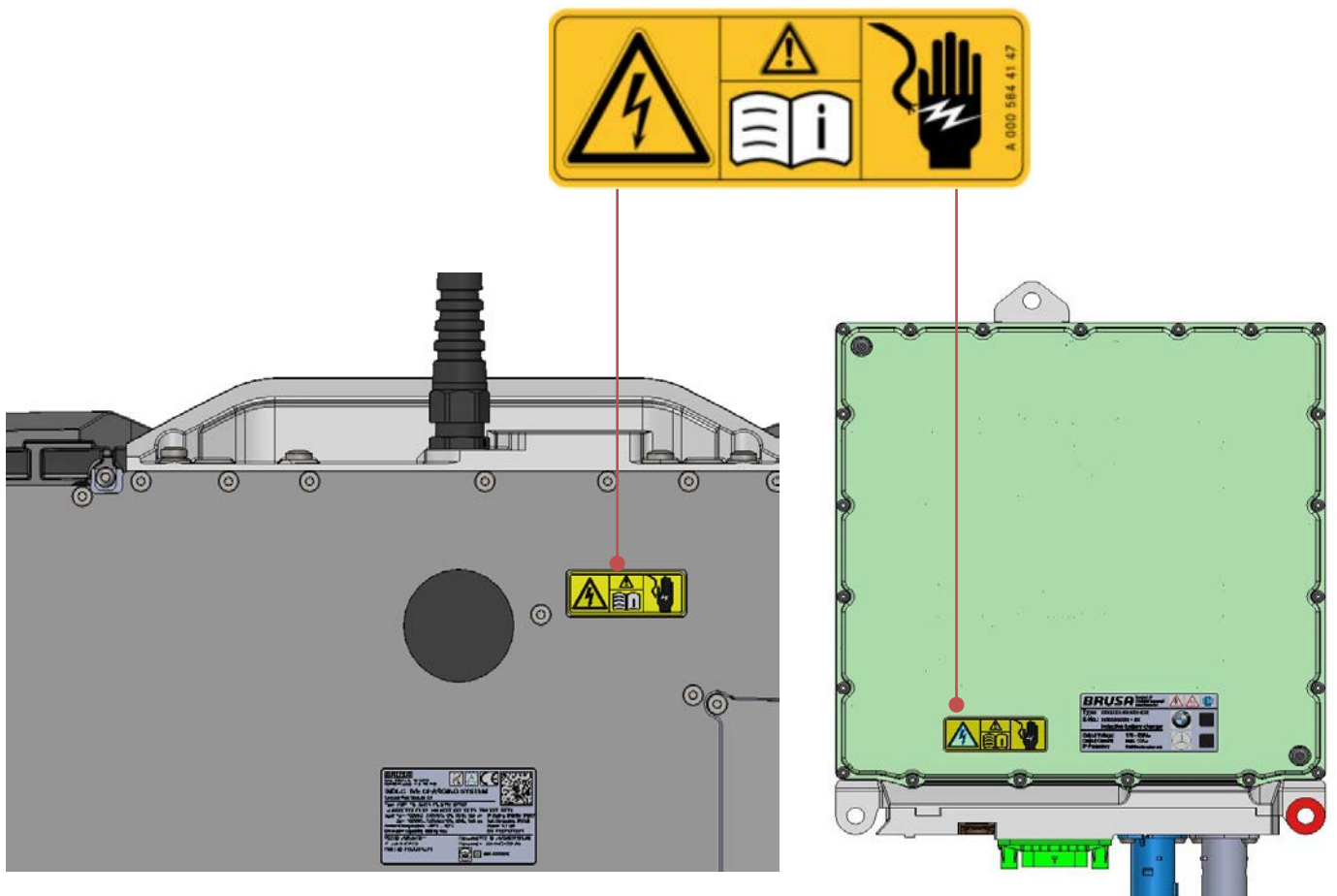

Figure 1: Warning notice (colored) on GPM underside (left) and CPM (right)

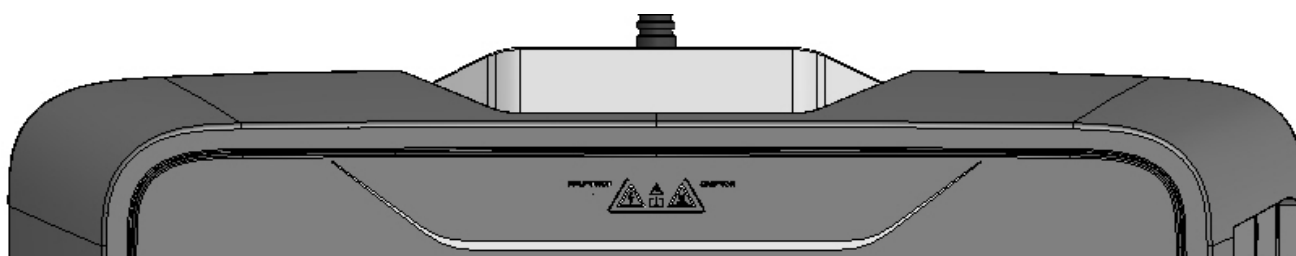

Figure 2: Warning notice (black/white) on GPM top side

6 Commissioning and Use of the ICS

The commissioning of the ICS assumes, that there is a suitable electrical connection available. The CPM is mounted on the vehicle. The GPM is installed by the service of the vehicle manufacturer at the installation location. The steps necessary for this are described in the annex. After the installation of the GPM it is commissioned by the service and thereby its functionality is explained.

6.1 Installation of the GPM and Commissioning

The installation of the CPM is the responsibility of the vehicle manufacturer or his service, see chapter 12.7.6. The installation of the GPM may only be carried out by a qualified electrician. The commissioning should be undertaken together with the user, in order to familiarize him with the function of the ICS, in particular with the LED flashing patterns.

NOTICE



The installation of the GPM may only be carried out by a qualified electrician. In particular, country-specific regulations for electrical lines and installations are to be observed. For America the National Electrical Code NFPA 70 is to be complied with, and in Canada the Canadian Electrical Code CSA C22.1.

NOTICE



The GPM must be installed flat and level on the floor. A sinking of the GPM into the floor is not permitted. Protect the mains connection cable with suitable floor mounted ducting resistant to over-rolling. Due to its overall height, the GPM represents a tripping hazard. Therefore do not install the GPM on footpaths or routes that you use frequently.

Ensure for sufficient lighting during installation, operation and deinstallation.

INFORMATION



Visually inspect the packaging material and in particular the GPM itself for damage before installation. Every GPM undergoes a strict quality- and function control before delivery. However we

have no influence on the long transport routes in some cases and the loading activities of our products.

DANGER



Mains Voltage!

During installation of the GPM there exists a danger to life from electric shock, if the connection sequence is not observed!





Make sure before commencing work, that the power connection is voltage-free!

Make sure, that there is an overcurrent protection device and a residual current device (Type A) in the connected current circuit of the GPM! The residual current device may only monitor the function of the GPM.

Check the residual current device by pressing the test button! Do not perform the installation, if these electrical safeguards are missing or are not functional!

Follow the prescribed work sequence without fail!

Do not act recklessly or impetuously under any circumstances!

WORK STEP	ILLUSTRATION / OTHER INFO
<p>For the installation you require:</p> <ul style="list-style-type: none"> - Access to the circuit breakers with 16 A fuse and residual current device (RCD) Type A - Customary local mains cable of sufficient length with at least 1.5 mm² line cross-section - Floor-mounted ducting resistant against being run over for the protection of the mains cable. - GPM 	 <p>During planning please note, that the GPM is monitored by a separate residual current device. No other device may be operated in parallel on the supply line protected by the residual current device.</p>
<p>Bring the GPM to the required destination. Separate the GPM from the rest of the packaging material.</p>	 <p>Observe the information for the transport of the GPM in chapter <i>12.5.8.2</i>.</p>
<p>Determine the position of the GPM by applying the conditions for the installation.</p>	 <p>Observe the information for the installation of the GPM in chapter <i>12.5.7.1</i> (Position to the CPM, Requirements of the vehicle manufacturer, Request of the user).</p>
<p>Connect the cable with the GPM.</p>	
<p>Ensure safe and secure laying of the cable from the power connection to the GPM. Avoid posing a tripping hazard due to protruding cable.</p>	 <p>Use resources such as floor-mounted ducting or similar to avoid tripping hazards.</p>

WORK STEP	ILLUSTRATION / OTHER INFO
<p>Connect the cable with the power connection. On the GPM the LED should not light up, in other words OFF, see 7.3.1.1.</p>	
<p>Make sure, that there are no foreign objects in the charging area.</p>	
<p>Switch the power supply for the GPM on and check the residual current device. If the GPM is supplied with mains voltage, then as next step the LED signals the initialization of the foreign-/living object detection, see 7.3.1.2.</p>	 Note the availability of the user for instruction in the use of the device and the dangers that can emanate from the ICS.
<p>Initialize the foreign-/living object detection: Place an approx. 5cm large metallic object on the GPM and remove it again after 10sec. If there is no vehicle in the vicinity which is suitable for the ICS charging system, then the GPM flashes with the appropriate pattern 7.3.1.3 The GPM now sends WLAN signals to vehicles in the reception range, but is not yet connected with any vehicle.</p>	
<p>If the vehicle with functional CPM is in the transmit range of the installed GPM, then the vehicle must be made known to the GPM. In practice this takes place as follows:</p> <ol style="list-style-type: none"> 1. In the vehicle display a list of all GPMs in the reception range of the CPM is displayed. 2. The required GPM is selected 3. The password for the selected GPM is entered. <p>Once this step is successfully concluded, then the LED of the GPM flashes with the pattern CONNECTED, see 7.3.1.4</p>	
<p>Position the vehicle over the GPM, so that the CPM and GPM are optimally overlaid. If the vehicle sends a request for charging and if the request is successful, then you see that on the GPM by the LED flashing pattern, see 7.3.1.5.</p>	<p>The preconditions for the start of the charging process are OEM-specific.</p>
<p>Wait a few minutes while the vehicle charges. Then place a suitable foreign object (metallic, approx. 5cm diameter) in the space between GPM and CPM. The charging process should then be interrupted and the LED on the GPM should flash, see 7.3.1.7. After removing the inserted object the charging process should be resumed, see 7.3.1.5.</p>	
<p>Remove the vehicle from the area in which charging is possible. The status of the GPM should change to the status CONNECTED, see 7.3.1.4, insofar as the vehicle is still sensed in the transmit range of the GPM, or the GPM switches to the status NOT CONNECTED, if the vehicle should not have any WLAN reception from the GPM, see 7.3.1.3</p>	

7 Control and Operation

NOTICE



The ICS has only one LED display, which signals important states of the GPM. Observe all safety instructions and warnings in the user manual without fail!

7.1 Use of the CPM and the GPM

The charging process between GPM and CPM functions automatically and does not need to be controlled. Used on its own, the CPM executes no function; without the presence of the CPM the GPM merely only detects foreign objects and otherwise does not execute any function when used on its own.

7.2 Use of the Charging Function of the ICS

Observe the warnings in 5.3.3 Safety Instructions for Handling and Operation

NOTICE



Scrutinize the instructions of the positioning display in your vehicle!

It is possible, that strict compliance with the positioning leads to material damage to the vehicle! A faulty positioning display or incorrect position of the GPM, e.g. due to the GPM shifting on the ground, can lead to damage to your vehicle during the parking process!

Therefore always observe the signals of the parking assistance of your vehicle! Give these signals precedence over the positioning signals of the ICS!

NOTICE



Physical Limits. Within the octagon described above, energy is transmitted with a high level of efficiency. Outside the octagon limitations in the charging performance are to be reckoned with:



- Reduced efficiency
- Reduced transmission power
- Reduced charging voltage range
- Increased charging time

NOTICE



Take into consideration the properties and parameters of the CPM and GPM, if you have modifications carried out on the vehicle or perform them yourself!

Please note, that material damage to the vehicle or ICS is possible, if modifications to the vehicle (tuning, lowering the vehicle) are undertaken.

WORK STEP	ILLUSTRATION / OTHER INFO
1 Make sure, that the GPM is free of objects.	 Observe the instructions for keeping the GPM clean in chapter 8.1.2.
2 Position the CPM above the GPM or position your vehicle with the help of the positioning function. On the GPM the LED should flash with the pattern according to 7.3.1.4.	 Observe the instructions. Avoid damage to your vehicle due to positioning malfunctions.
3 Start the charging process by following the instructions on the user interface of your vehicle. On the GPM the LED should flash with the pattern according to 7.3.1.5.	 If the charging process does not start, follow the troubleshooting instructions in chapter 7.6 or contact customer service.

7.3 Displays and Signals

7.3.1 LED Display

On the service flap of the GPM there is an LED, which indicates the operating status and error states.

7.3.1.1 Status: Off

The GPM is without power or defective. After unpacking the GPM, the LEDs are off. Likewise after installation before the circuit breaker has been switched on. If the LEDs remain off after the GPM is working, then there is a defect. In this case, check that neither the circuit breaker nor the residual current device interrupt the power supply to the GPM.

on

off

Figure 3: Flashing pattern in status Off

7.3.1.2 Status: Initialization Foreign-/Living Object Detection

For safety reasons during running operation, the GPM monitors that there are no living or foreign objects between GPM and CPM. For this safety function a re-initialization may be necessary. In the status Initialization Foreign-/Living Object Detection, charging the vehicle is not possible, because the GPM can no longer safely evaluate, whether an object is present or not.

If the GPM requires an initialization of the foreign-/living object detection, you recognize this by this flashing pattern:

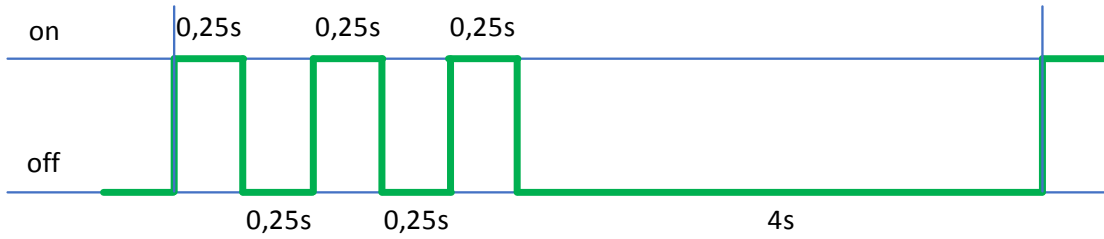

Figure 4: Flashing pattern in status Initialization Foreign-/Living Object Detection

In practice this initialization is carried out by making sure that there is no object lying on the GPM surface. Then place an approx. 5cm large piece of metal (e.g. 5cm large steel disk, beverage can, etc.) on the GPM and remove it again after 6-9sec. The initialization of the foreign-/living object detection is possibly required

- after the GPM is switched on or after a mains failure,
- during the operation

7.3.1.3 Status: Not Connected

The GPM is in this status, when the power supply for the GPM has been switched on, the initialization of the foreign-/living object detection has already been performed, but there is not yet any vehicle nearby, which is suitable for charging with the GPM.

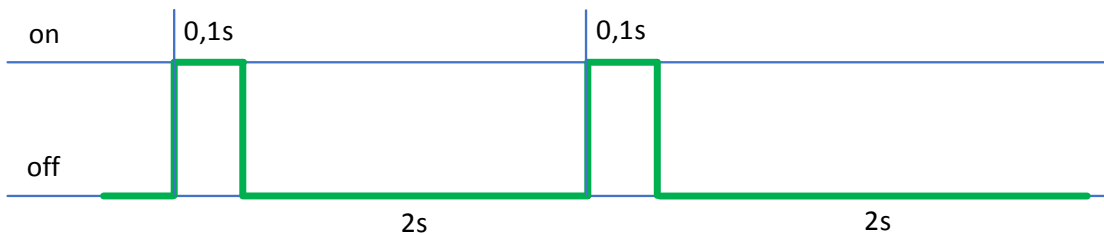

Figure 5: Flashing pattern in status Not Connected

7.3.1.4 Status: Connected

If a suitable vehicle (with CPM) is configured for charging with the GPM and if this vehicle is near the GPM, then a WLAN connection is established between CPM and GPM. The charging process is controlled automatically from the vehicle via this WLAN connection.



Figure 6: Flashing pattern in status Connected

7.3.1.5 Status: Charging / Energy Transmission

If the vehicle (with CPM) is in the optimal parking position, then the charging process is started automatically. The energy transmission from GPM to the vehicle is signaled by means of LED with this flashing pattern.

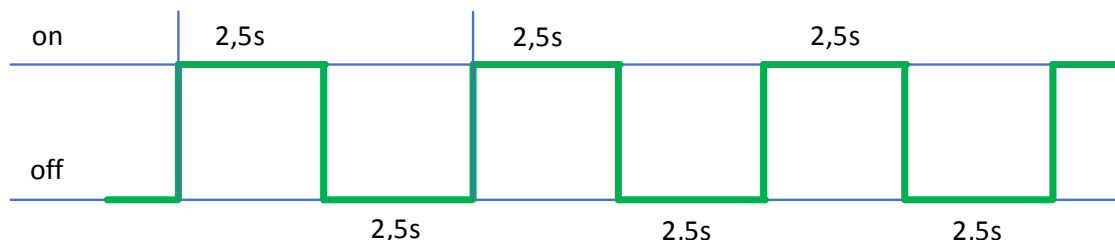

Figure 7: Flashing pattern in status Charging / Energy Transmission

7.3.1.6 Status: General Error

With an error the LED flashes with this pattern. Attempt to rectify the error as described in *7.6 Troubleshooting by the User*.

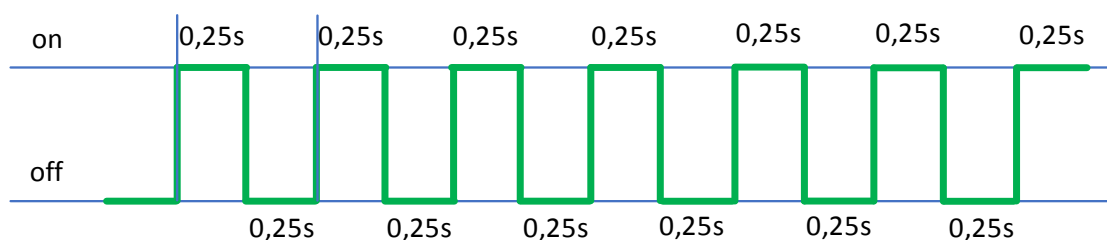

Figure 8: Flashing pattern in status General Error

7.3.1.7 Status: Foreign Object Detected

If a foreign object is detected during charging, then the charging process is interrupted for safety reasons. The LED signals this with this pattern. In this case check the GPM and make sure, that the GPM is free of foreign objects of any kind.

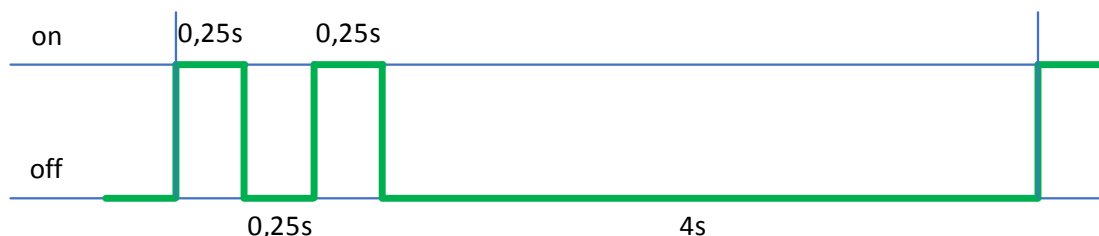

Figure 9: Flashing pattern in status Foreign Object Detected

If a foreign object is detected incorrectly, although the GPM surface is free, then a reset of the GPM is necessary, i.e. the GPM must be disconnected from the power supply until the LED goes out. After switching the GPM on again, a renewed initialization of the FOD is possibly necessary, see 7.3.1.2 Status: Initialization Foreign-/Living Object Detection.

7.3.1.8 Status: Cooling Fan Blocked

The GPM is reliant on a sufficient circulation of air, in particular during the charging process. If the fan duct is clogged, and the fan is blocked, then you recognize this on the LED with this pattern. In this case please check the cooling duct and clean it as required.

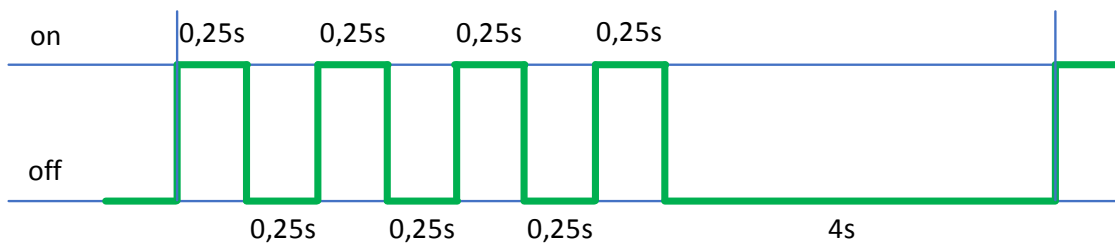

Figure 10: Flashing pattern in status Fan Blocked

7.4 GPM Cooling System Fan

Noise can be caused by the cooling function of the fan. The device is protected from overheating by an internal function. Please treat the fan with care and observe the instructions for cleaning, see section 8.1 Cleanliness. In particular clean the fan intake duct regularly. Do not use any high-pressure cleaner, such as e.g. Kärcher!

7.5 Emergency Situations

With the occurrence of emergency situations, follow the corresponding situation descriptions in the table below and comply with the associated instructions!

SITUATION	INSTRUCTIONS
Development of smoke or fire in the charging environment	<ol style="list-style-type: none"> 1. Keep calm! 2. Remove yourself and if necessary other persons immediately from the source of the fire and from the surroundings! Do not use the vehicle in the charging station for this! 3. Fetch help. Call the fire department! 4. Keep other people away from the source of the fire! 5. Visit a doctor in order to exclude smoke poisoning!
Feeling of numbness in the extremities	<ol style="list-style-type: none"> 1. Keep calm! 2. Remove yourself immediately from the charging environment! 3. Visit a doctor.
Feeling unwell	<ol style="list-style-type: none"> 1. Keep calm! 2. Remove yourself immediately from the environment of the charging station! 3. Visit a doctor.

7.6 Troubleshooting by the User

For the following errors, limited troubleshooting can be undertaken by the user. The troubleshooting is to be undertaken as described in this chapter. The user is forbidden to undertake further troubleshooting that goes beyond the troubleshooting specified in this chapter. In the following, situations are described as can occur during the operation. The troubleshooting is to be undertaken and performed in the given order for exactly that situation description that applies to the current situation.

SITUATION	TROUBLESHOOTING
It is not possible to position the vehicle for a charging operation.	<ol style="list-style-type: none"> 1. Check, whether your vehicle is switched on. The positioning function only works when readiness to drive is established. In addition the confirmation of your consent for the charging operation is required via the interface of the vehicle. 2. Check, whether the GPM has shifted. If so, bring it back to that position, that was determined in chapter <i>12.5.1</i>. 3. Check, whether the GPM can be supplied with power. For this, establish whether the power supply for the GPM has been interrupted by electrical safety devices. If so, re-establish the power supply for the GPM, by switching on the electrical safety device. 4. Check, whether the WLAN connection between CPM and GPM is faulty. If necessary repeat the positioning process. 5. If the error still occurs, contact customer service.
The charging operation is aborted again immediately after the start.	<ol style="list-style-type: none"> 1. Check, whether the GPM is free of foreign objects. If necessary clear it, taking into consideration the information specified in chapter <i>8.1.2</i>. 2. Check, whether the charging function has been and can be interrupted by people or animals. If necessary, prevent the access to the charging station. 3. Check, whether the GPM can be supplied with power. For this, establish whether the power supply for the GPM has been interrupted by electrical safety devices. If so, re-establish the power supply for the GPM, by switching on the electrical safety device. 4. Check, whether the difference in height between GPM and CPM has changed in an inadmissible way, e.g. due to a great deal of snow on the car tires or on the ground, on which the GPM is installed. 5. If the error still occurs, contact customer service.

SITUATION	TROUBLESHOOTING
The vehicle (the drive battery) is not completely charged.	<ol style="list-style-type: none"> 1. Check, whether the charging time for the complete charge of the battery was sufficient. (Is the charging process resumed when you resume the charging function?) 2. Check, whether the GPM and its immediate environment is free of foreign objects. If necessary clear it, taking into consideration the information specified in chapter 8.1.2. Perhaps the charging operation could not be completed in the charging time provided due to the presence of foreign objects. 3. Check, whether the charging function has been and can be interrupted by people or animals. If necessary, prevent the access to the charging station. Perhaps the charging process was stopped by a person or animal and therefore could not be completed in the charging time provided. 4. If the error still occurs, contact customer service.
The vehicle (the drive battery) is not completely charged, although the charging operation was indicated as completed.	<ol style="list-style-type: none"> 1. Check, whether consumers in the vehicle (e.g. radio, light, navigation?) were switched on, so that after charging up, the drive battery was discharged again. 2. If the error still occurs, contact customer service.
The ICS System can no longer be used / it is switched off.	<ol style="list-style-type: none"> 1. Check, whether the GPM can be supplied with power. For this, establish whether the power supply for the GPM has been interrupted by electrical safety devices. If so, re-establish the power supply for the GPM, by switching on the electrical safety device. 2. Contact customer service



8 Maintenance

DANGER

Never perform maintenance measures during operation of the ICS!

Strong magnetic field (non-ionizing radiation)!

Influence on electrically conductive objects!

During the charging process there is a strong magnetic field between CPM and GPM, which exceeds the limits for long-term exposure of living beings.

In order to exclude acute effects, such as muscle- and nerve stimulation, as well as consequential damage, no body parts may get into and around the space between the GPM and CPM during the charging process.

In addition, jewelry (rings, wristwatches, etc.) can heat up considerably and become damaged or lead to burns.

People with a cardiac pacemaker or implanted defibrillator should keep away from the vicinity of the system during the charging process.

Keep animals away from the system during operation.

NOTICE



Apart from the cleaning in chapter 8.1.2 all maintenance measures may only be performed by specialists!

Contact customer service to have measures carried out for the maintenance of the ICS! This way you avoid material damage to the ICS or the loss of the warranty.

The ICS system consists of the components CPM and GPM. In the framework of the guarantee it is possible to have these two components inspected by specialists, if failure symptoms are evident. Contact customer service for this. The contact details can be found in chapter 3.3.

Consumables or individual replacement parts are not required or provided for the CPM or the GPM of the ICS system.

If a warranty case occurs, the respective components are to be replaced exclusively by specialists. In particular, renewed work for the installation of the components is also to be carried out by specialists. If individual components have to be replaced, the descriptions for the preparation of the ICS for use or for deinstallation in chapter 6 resp. 9 are to be observed for the removal of the old components and the installation of the new components.

8.1 Cleanliness

8.1.1 Cleanliness of the CPM

NOTICE



For the CPM regular cleaning by the user is not intended and also not permitted. Non-observance of this notice can result in damage to the CPM.

8.1.2 Cleanliness of the GPM

CAUTION



Do not perform cleaning during and immediately after the charging process!

Keep the GPM clean and remove objects in its close proximity, which would lie under the vehicle during the charging process. In particular no cables may be routed over the GPM. During the charging process, objects in the charging area may have heated up. Touching these objects can lead to injuries due to burning.

NOTICE



Deviation from recommended measures for cleaning can result in damage to the GPM.

During use the GPM must be kept clean. It is recommended to keep the GPM clean by means of the following measures:

- Manual clearing of the GPM surroundings
- Sweeping off the GPM
- Moist wiping of the GPM with a mild cleaning agent
- Cleaning the fan intake duct

In particular the following measures should not be applied to keep the GPM clean:

- High-pressure cleaner, e.g. Kärcher
- (strong) chemical cleaning agent
- Road sweeper
- Snow plough

8.2 Behavior after a vehicle accident

After an accident with the vehicle in which the CPM is installed, the CPM must be inspected for functionality by a specialist.

9 Deinstallation

NOTICE



Measures for the deinstallation and disposal may only be performed by specialists!
Contact customer service to have measures performed for the maintenance of the ICS! This way you avoid material damage or dangers for nature and the environment!

The deinstallation of the GPM is described in chapter 12.7.7.

10 Disposal

The disposal of the ICS is carried out by customer service after the deinstallation of the system from the vehicle (CPM) or from the charging station (GPM).

10.1 Notes for Customer Service

A basic prerequisite for the reuse and the recycling of used electronic devices is the correct disposal.

According to the EU-Directive 2012/19/EU, since 24th March 2006 electrical devices may no longer be disposed of together with the household waste, but must be collected and gathered separately by a specialist company. The disposal by a specialist company contributes significantly towards avoiding dangers for people and nature. In the case of disposal we therefore recommend that you contact a recognized specialist waste management company.

11 Legal Notices

11.1 Warranty

For damage that occurs during proper intended use and despite observance of the safety instructions in this document, BRUSA provides a warranty for the ICS. The warranty is in accordance with the provisions in our currently valid General Terms and Conditions, which can be viewed at www.brusa.biz/support/agb.html.

No warranty is provided for damage that can be traced back to improper use or non-observance of the safety instructions.

11.2 Company Names

The company names mentioned in this operation manual are used exclusively for identification and are therefore mentioned without consideration of a possibly existing patent- or trademark protection:

- BMW
- Daimler

12 Annex A1

12.1 Technical Specifications of the ICS

12.1.1 Emissions

Table 1: Emissions

PARAMETER	CHARACTERISTIC VALUE	UNIT
Max. magnetic flux density between GPM and CPM	$7 \cdot 10^{-3}$	T
Magnetic flux density of the GPM at vehicle limitation	$4.6 \cdot 10^{-6}$	T
WLAN-Signal		
- Frequency	2.4	GHz
- Max. transmit power	19	dBm
	79	mW
Positioning signal		
- Frequency s	125	kHz
- Max. radiated magnetic field strength at 125 kHz	17.5	dB μ A/m

12.1.2 Dimensions and Center of Gravity

12.1.2.1 Dimensions GPM [mm]

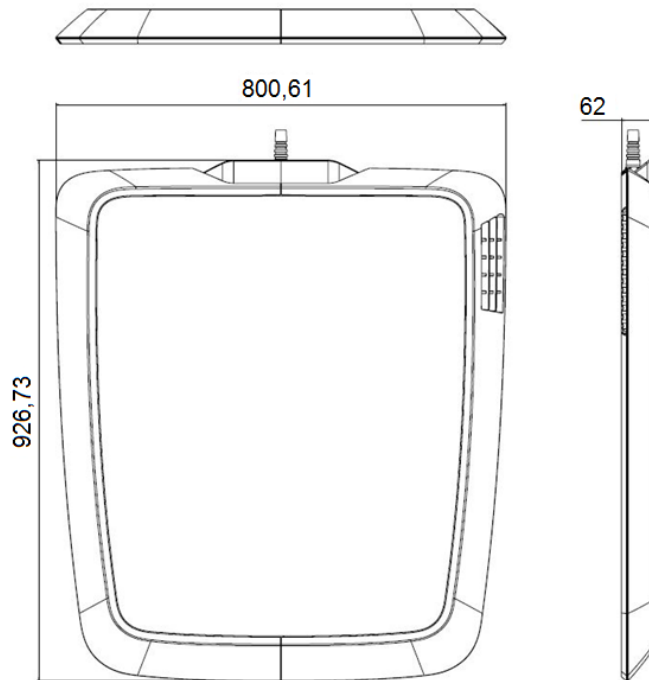

12.1.2.2 Center of Gravity GPM [mm]

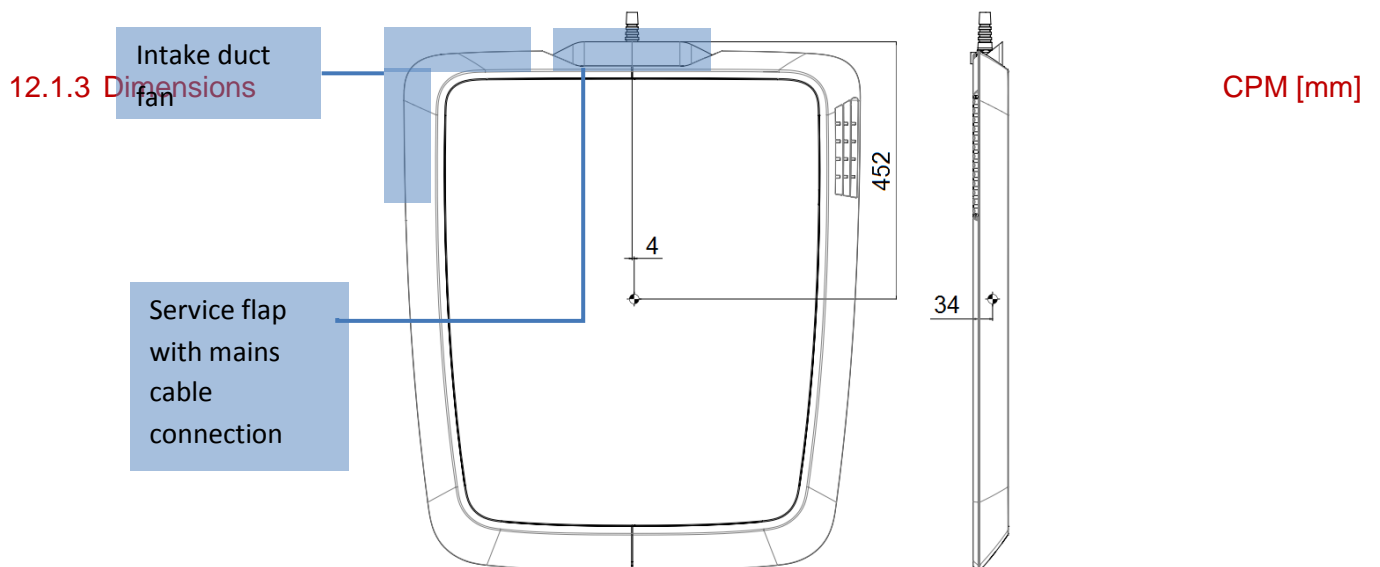
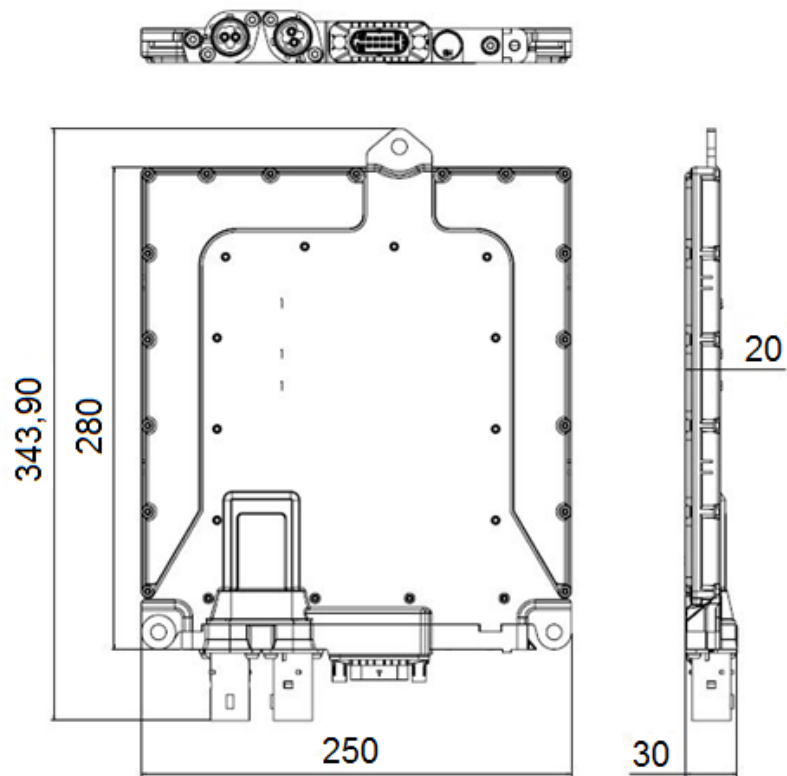
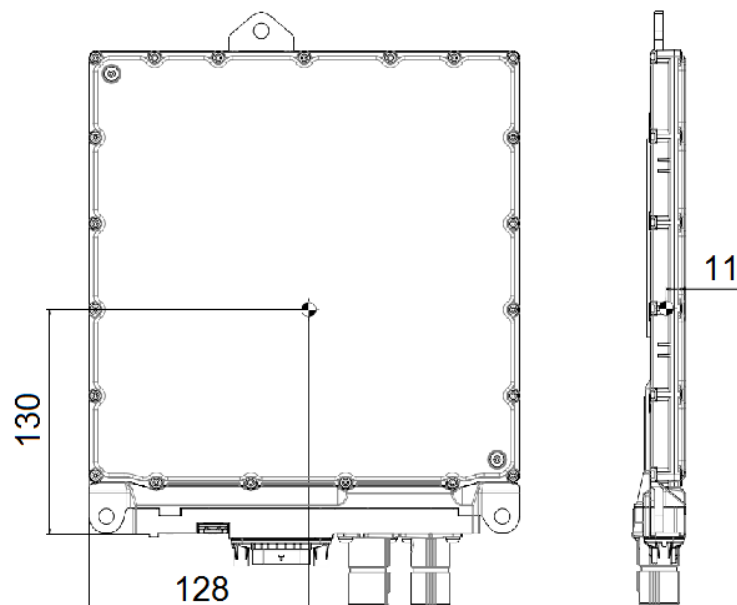

Figure 11: Center of gravity of GPM with fan intake duct



12.1.4 Center of Gravity CPM [mm]



12.2 Technical Data

BASIC DATA ICS	VALUE	UNIT
Total weight	approx. 52	kg
Rated input voltage (single-phase L1/N)	200 – 240	V _{AC}
Rated input voltage (two-phase L1/L2)	100 – 120	V _{AC}
Rated input frequency	50 – 60	Hz
Maximum input current	16	A _{rms}
Max. input power	3600	W
Charging voltage	200 – 440	V _{DC}
Max. charging current	12	A _{DC}
Charging capacity	500 – 3200	W
Energy transmission frequency	81.38 – 90	kHz
Duration of a charging process	Dependent on type of vehicle	
Transmission frequency WLAN (ISM Band)	2.412 – 2.462	GHz
Max. transmit power WLAN	100	mW
Transmission frequency positioning	125	kHz
LV-wiring system CPM	9 – 16	V _{DC}
LV-wiring system max. voltage CPM (device destruction)	27	V _{DC}
IP protection class	IP6K9K, IP65	-
Insulation class acc. EN 61140	Protection class I	-

BASIC MECHANICAL DATA	MIN	MAX	UNIT
Height above ground GPM	0	0	mm
Height above ground CPM	100	160	mm

Maximum offset GPM to CPM in travel direction (x-direction)	-75	75	mm
Maximum offset GPM to CPM transverse to travel direction (y-direction)	-150	150	mm
Above specified applies, if	0	$ x + y < 175 \text{ mm}$	mm
This inductive charging system also functions outside these specified system limits, but with restricted efficiency and restricted transmission power.			

VEHICLE-CAN CPM	ICS	UNIT
CAN 2.0B	---	---
CAN Baud rate	500 (default)	kBd
CAN input capacity	47	pF
CAN High – Low input resistance	36	k Ω
Startup time / charging readiness (until CAN-communication)	3	s
Sample Point	81	%
BTL Cycles	16	---
SJW	3	---

12.2.1 Conditions for Storage and Transport of the ICS

	ICS	UNIT
Ambient temperature range ICS for storage and transport	- 40 – 85	$^{\circ}\text{C}$
Max. humidity ICS for storage and transport	70	%

12.2.2 Conditions for Operation of the ICS

	ICS	UNIT
LV-wiring system CPM	9 – 16	V_{DC}
Max. LV-wiring system voltage CPM (device destruction)	27	V_{DC}
LV-current consumption CPM	0.2 – 2	A_{DC}
LV-current consumption CPM (Sleep-Mode)	$< 100 \cdot 10^{-6}$	A_{DC}
Ambient temperature range operation CPM	- 40 – 105	$^{\circ}\text{C}$
Ambient temperature range operation GPM	- 40 – 50	$^{\circ}\text{C}$
Ground clearance CPM without restriction of efficiency, distance between ground and CPM-underside)	115 – 150	mm
max. operating altitude of device above sea level	4,000	m

Another condition for the operation of the ICS is the installation of an independent functional residual current device of class A or class B in the electric circuit of the connection for the GPM, which monitors exclusively the function of the GPM. In addition a functional electrical safety device must be installed in the electric circuit of the power supply for the GPM.

12.2.3 Mechanical Data of the CPM

PART OF THE SYSTEM	PHYSICAL SIZE [UNIT]	CHARACTERISTIC VALUE/(-RANGE)
CPM	Weight [kg]	approx. 3
	Dimensions [mm]	344 x 250 x 30

12.2.4 Mechanical Data of the GPM



PART OF THE SYSTEM	PHYSICAL SIZE [UNIT]	CHARACTERISTIC VALUE/(-RANGE)
GPM	Weight [kg]	approx. 49
	Dimensions [mm]	930 x 800 x 62

12.3 Requirements on Specialist Personnel

12.3.1 Specialist Requirements

The work steps described in this manual for assembly, installation, disassembly and disposal may only be performed by qualified specialist personnel (mechanical installation) or by a qualified electrician (electrical installation), who, based on their professional education, knowledge and experience as well as knowledge of the relevant standards, can assess and perform the work steps described in the installation instructions and recognize any dangers.

12.3.2 Health-related Requirements

WARNING	
	<p>Risk of injury due to electromagnetic field!</p> <p>During inductive charging an electromagnetic field is generated under the vehicle. Cardiac pacemakers and medical implants can be impaired.</p>
	<p>Do not reach under the vehicle or perform maintenance work on the vehicle during the charging process.</p>

The warning of dangers due to electromagnetic radiation also applies for specialists. Electromagnetic radiation can be particularly dangerous for people with medical implants, especially people with cardiac pacemakers.

12.4 Information about Protective Equipment

12.4.1 Protective Equipment during Transport and Storage

For the installation the following protective equipment must be worn, to prevent possible injuries in the respective work steps:

Transport / Removal / Storage: Protective gloves against mechanical risks and safety shoes

12.4.2 Protective Equipment during Installation

During the installation the following protective equipment must be worn, to prevent possible injuries in the respective work steps:

Installation: Safety shoes

12.4.3 Protective Equipment during Operation

No protective equipment is required during the operation.

12.4.4 Protective Equipment during Disposal / Deinstallation

During the deinstallation and disposal the following protective equipment must be worn, to prevent possible injuries in the respective work steps:

Deinstallation: Safety shoes

Disposal: Safety shoes

12.5 Preparation of the ICS for Use

12.5.1 Installation Information

The electrical, mechanical and thermal integration of the CPM is to be ensured by the vehicle manufacturer. This is described in chapter 12.7.2. The manufacturer is not liable for damage, that results from the faulty integration of the CPM in the target vehicle of the vehicle manufacturer.

12.5.2 Placement of the GPM

The GPM is placed flat and level on the ground. Rubber feet underneath the GPM prevent the GPM from shifting on the support surface. Optionally the GPM can be fixed on mounting rails, see 12.5.4 Optional Installation of the GPM with Mounting Rails.

12.5.3 Alignment of GPM to CPM

For the alignment of the GPM to the CPM, refer to *Figure 12*. The vehicle manufacturer is responsible for the provision of the correct dimensions for the installation of the GPM in the charging station. For the position of the GPM in the charging station the dimensions of the vehicle must be taken into consideration. For damage that is due to faulty installation of the GPM in the charging station, no liability is accepted on the part of the manufacturer.

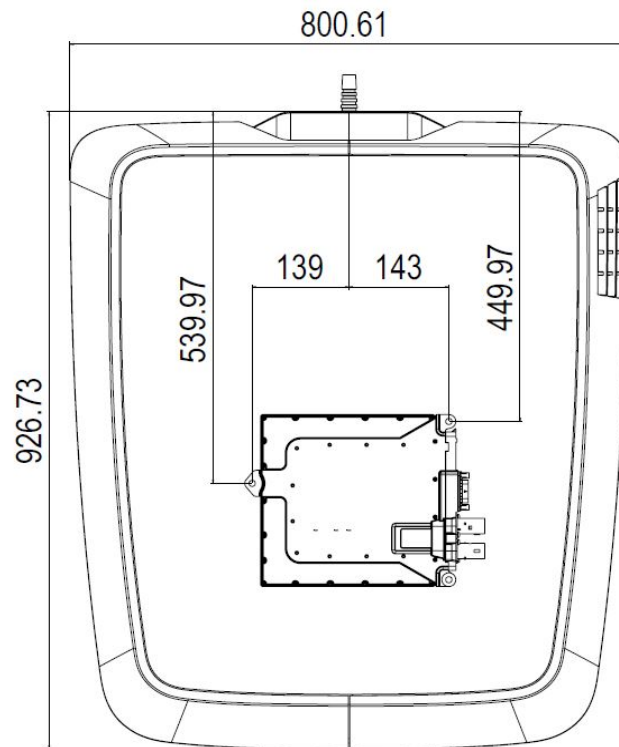

Figure 12: Alignment of GPM to the CPM, as should be taken into consideration during the installation

1. For the alignment of the GPM to the CPM, at best proceed as follows: During the installation of the GPM (Ground Pad Module) the vehicle must be present.
2. Establish exactly the required parking position, at which the vehicle should later be charged.
 - a. Park the vehicle in the intended position, so that the charging later in this position is ensured.
3. Mark the planned position on the floor according to the positioning sketch. This step decides about the functionality of the charging system, therefore proceed exactly!
 - a. Set the steering straight.
 - b. Mark on the floor the position and middle of the front license plate holder.
 - c. Mark on the floor the position of the outer edges of the front wheels.

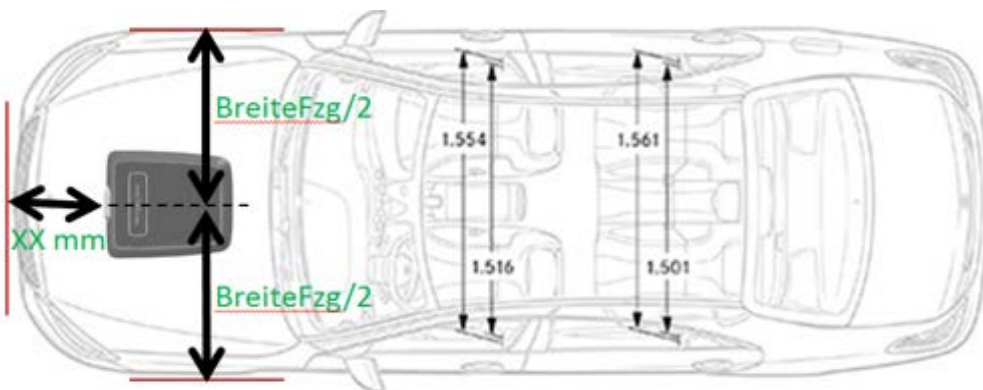

Figure 13 Example for positioning the GPM with desired forward parking

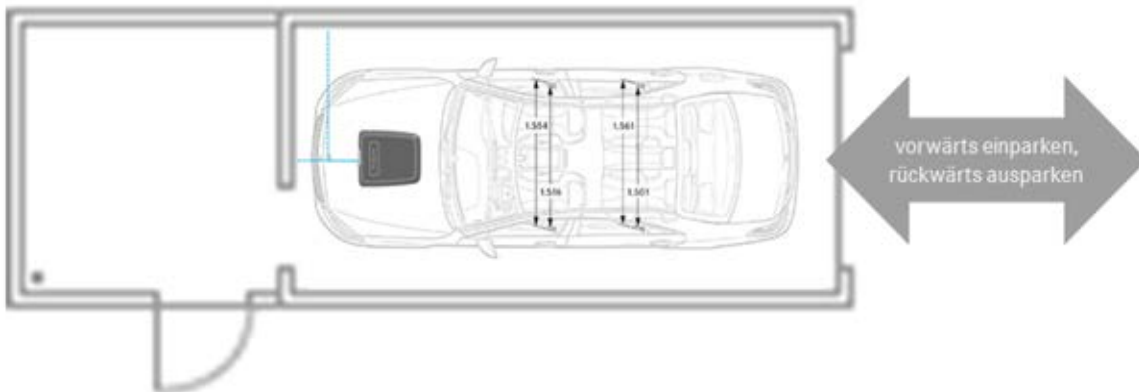

Figure 14: Recommendation for cable laying (blue) with desired forward parking

12.5.4 Optional Installation of the GPM with Mounting Rails

Optionally the GPM can be fixed against shifting with the help of mounting rails. This prevents the GPM from shifting.

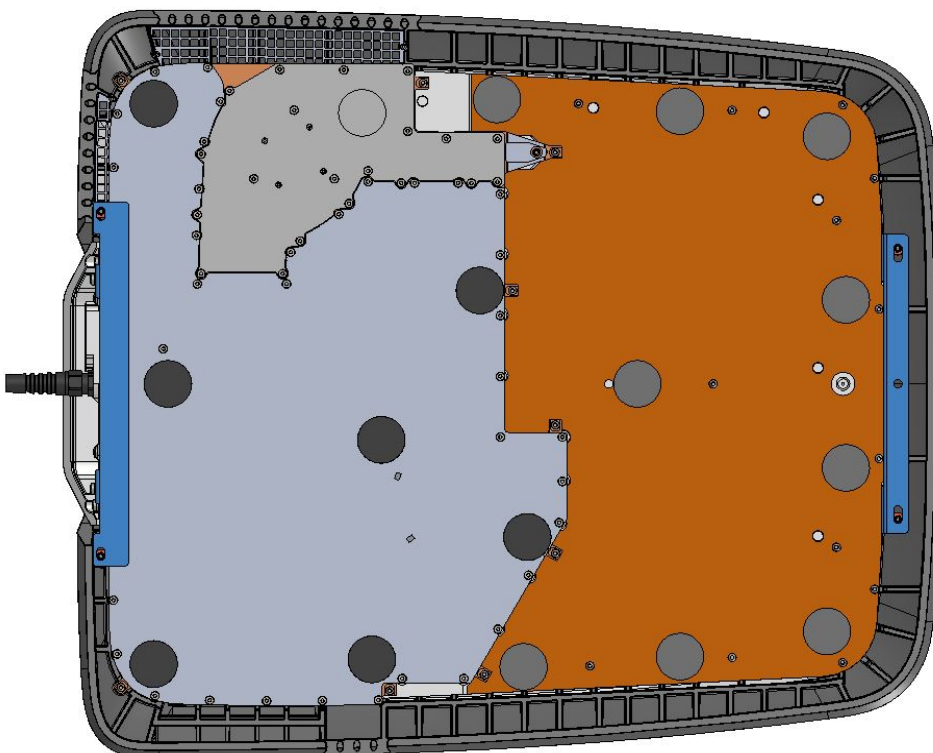

Figure 15: Bottom of the GPM with mounting rails (blue). The right-hand rail snaps into recesses of the GPM-housing. The left-hand rail (on the cable bushing) is screwed tight at the side of the service cover.

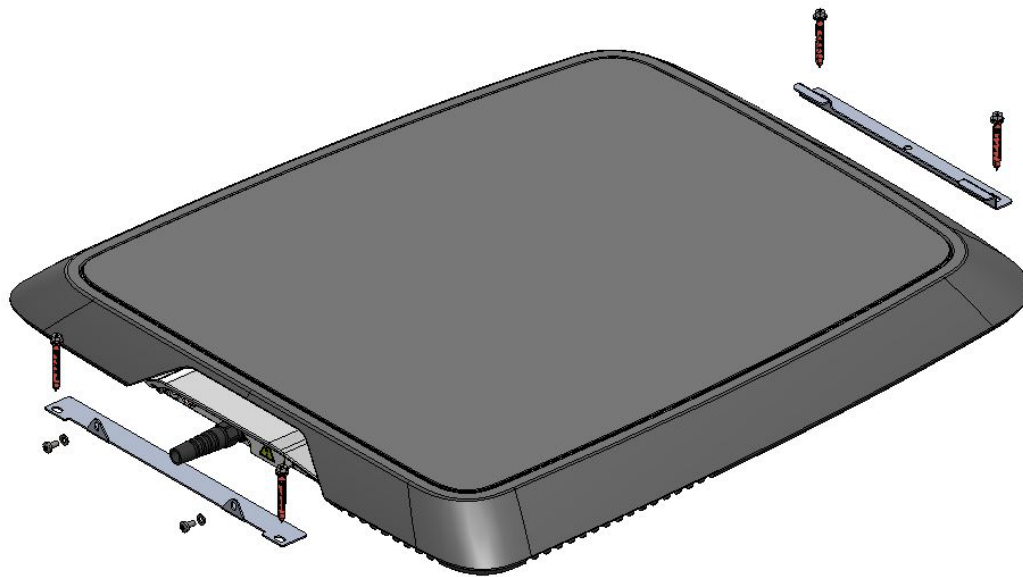

Figure 16: View of GPM with mounting rails.

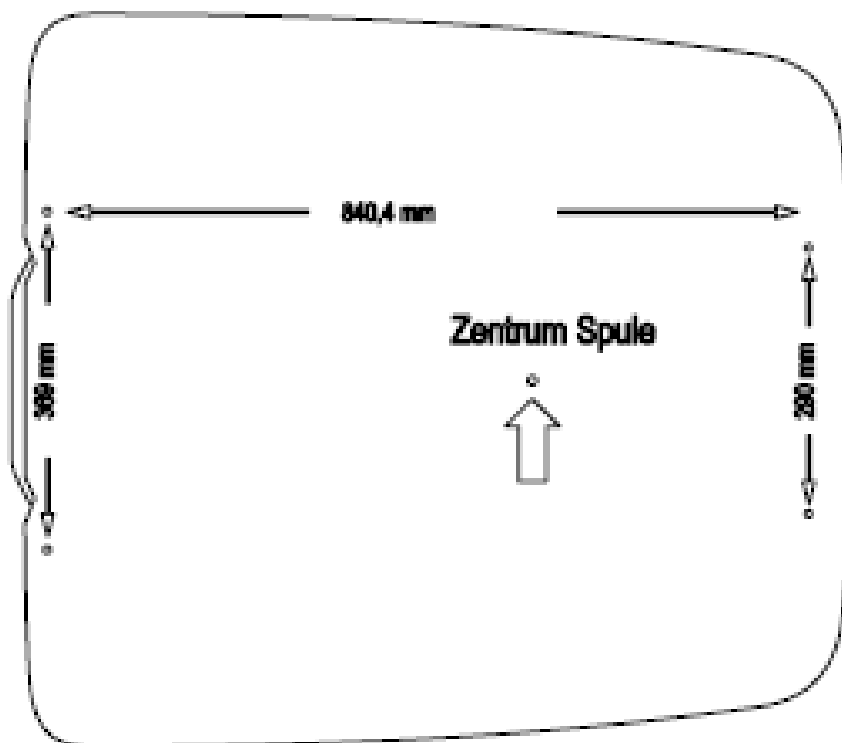

Figure 17: Drilling template for GPM mounting rail

Proceed as follows:

1. For the mounting rails 8 mm diameter holes are drilled according to the drilling template (see Figure 17: Drilling template for GPM mounting rail).
2. The rails are then fastened to the floor with the help of the plastic frame plugs 0912 808 602. The screws must be screwed in flush. (see data sheet in the annex)
3. The GPM is then pushed into the rear rail. To do this hold the GPM a little inclined. The rear rail disappears under the ground frame. Check whether the rail engages in the GPM. (possibly by lifting)
4. Push until the GPM also goes down at the front rail (service area). Then screw the rail together with the GPM with 2x oval-head screws M6x12 and washers.

12.5.5 Line Connections CPM

See Annex 12.7.3

12.5.6 Line Connections GPM

12.5.6.1 Cable Assignment

The GPM is supplied without mains cable. For the installation the electrician on site must connect a country-typical mains cable. If the fixed connection variant is not chosen, a suitable country-specific connector with a minimum current carrying capacity of 16A must be selected and connected. *Table 2: Assignment Mains Connection Cable GPM* describes the cable assignment. For America the National Electrical Code NFPA 70 is to be complied with, and in Canada the Canadian Electrical Code CSA C22.1. For the connection of the mains cable, the service flap, see *Figure 18, Figure 19* must be opened. The cable must then be connected to the connection terminals in the service cover. The terminals are suitable for the connection of copper conductors with or without wire-end ferrules with a nominal cross section of 1.5 – 2.5mm² (AWG 16 – AWG 12). For the connection of the voltage supply, use cables that are approved for a temperature of at least 75°C (167°F). The color assignment must be observed without fail, see *Table 2: Assignment Mains Connection Cable GPM*.

Color	Use
brown	Phase L1
blue	Neutral conductor
yellow/green	Protective conductor

Table 2: Assignment Mains Connection Cable GPM



Figure 18: Service flap with LED - View







Figure 19: Connection of a cable to the cage clamp in the service flap

12.5.7 Planning the Assembly and Installation of the ICS

Planning the assembly and installation of the CPM, see Annex 12.7.4.



12.5.7.1 Planning the Installation of the GPM

WORK STEP	ILLUSTRATION / OTHER INFO
<p>1 Determine the installation position of the GPM.</p>	 Please note, that certain information must be obtained: Dimensions of the GPM (ICS User Manual), position of the CPM installed in the vehicle, request of the user about preferred parking position of the target vehicle, check of the installation possibility (solid ground).
<p>2 Ensure the availability of the GPM for the installation work step.</p>	 Take into consideration the ordering- and delivery times for the GPM.
<p>3 Ensure the availability of the auxiliary material and the information from the user manual, to be able to undertake the installation of the GPM and if necessary be able to check the correct installation. Make sure, that the space requirement for the installation is covered.</p>	 Note the use of the respective auxiliary material, that is required for the GPM during the installation (see installation instructions of the vehicle manufacturer), e.g. cable required (note length!) for the connection of the GPM to the power supply and auxiliary material for the professional laying of the cable (floor-mounted duct or similar).
<p>4 Make sure, that all information required for the installation of the GPM is prepared for the installation and is available during the installation.</p>	 Note information- and communication channels.

12.5.8 Transport and Storage

12.5.8.1 Transport and Storage of the ICS



CAUTION	
	<p>Caution during transport and storage of the ICS!</p> <p>Note the technical specifications of the ICS, e.g. weight and center of gravity! Please note, that with careless handling of the CPM, injuries are possible: injuries on ICS or packaging, as well as injuries through allowing the ICS to fall (in packaging)!</p>



WORK STEP	ILLUSTRATION / OTHER INFO
1 Ensure cautious and careful handling of the ICS (possibly in packaging) during the preparation for transport or storage.	 Note the total weight of approx. 52 kg for the ICS. Avoid impacts on the ICS.
2 For transport or storage, place the ICS on a level surface.	 Ensure compliance with the conditions in chapter 12.2.1 for storage or transport of the ICS.
3 Ensure cautious and careful handling of the ICS after transport or storage.	 Note the weight of the ICS. Avoid impacts on the ICS.

Transport and storage of the CPM, see chapter 12.7.5.

12.5.8.2 Transport and Storage of the GPM

CAUTION	
	<p>Caution during transport and storage of the GPM! Do not lift the GPM alone, rather always with a second person.</p> <p>Note the technical specifications of the GPM, e.g. weight and center of gravity! Please note, that with careless handling of the GPM, injuries are possible: injuries on GPM or packaging, as well as injuries through allowing the GPM to fall!</p> <p>Use safety shoes and protective gloves as protective equipment for handling the GPM! Use a handcart and lashing straps as auxiliary equipment for the transport of the GPM!</p>





WORK STEP	ILLUSTRATION / OTHER INFO
1 Preparation: Determine, whether a cautious and careful handling of the GPM (possibly in packaging) is possible. You thereby avoid transport damage to the GPM. Wear the protective equipment, as prescribed in chapter 12.4.	 Make sure, that routes for the manual transport are free (no tripping hazards due to tools or cables lying around) and provide sufficient space! Note the weight of approx. 49 kg for the GPM (plus the weight of the packaging). Note the center of gravity of the GPM in chapter 12.1.4.
2 Lifting: Lift the GPM taking into consideration the weight, the dimensions and the center of gravity.	
3 Handling: Ensure, that you can safely hold the GPM during the manipulation.	 Please note that the handling of the GPM (possibly in packaging) can change during the manipulation, e.g. through a change of the relative position of the center of gravity of the GPM, due to contact with smooth surfaces or due to the GPM shifting in the packaging.

WORK STEP	ILLUSTRATION / OTHER INFO
<p>4 Transport: Transport the GPM, so that you can move comfortably. As a result you avoid posture injuries. Use auxiliary equipment to protect the transport, such as handcart and lashing straps.</p>	<p> Note the weight and center of gravity of the GPM.</p>
<p>5 Setting down: Place the GPM (possibly in packaging) on a level surface.</p>	<p> Ensure compliance with the conditions in chapter 12.5.8 for storage or transport of the GPM.</p>
<p>6 Storage: Store the GPM (possibly in packaging) horizontal on level surfaces. Place the base area of the GPM (possibly in packaging) completely on the storage surface. Avoid damage to the GPM due to incorrect storage.</p>	<p> Observe the conditions in chapter 12.5.8.2 for the storage of the GPM.</p>

12.6 Deinstallation of the GPM

The deinstallation of the GPM component may only be performed by specialist personnel. Contact customer service.

12.6.1 Procedure for the Deinstallation of the GPM (Information for Customer Service):

WORK STEP	ILLUSTRATION / OTHER INFO
<p>1 Ensure for a safe working environment during the deinstallation. Inform the people in your surrounding area about your work. Ensure for adequate lighting.</p> <p>If the GPM is hot, wait until it has cooled down.</p>	<p> Make sure, that no sources of danger can occur during the deinstallation (e.g. for pets, crushing by machines). Do not wear any jewelry during the deinstallation.</p> <p> Danger of injury with hot GPM.</p>
<p>2 Switch off the power supply for the GPM.</p>	
<p>3 Make sure by means of measurement, that the power supply for the GPM is switched off.</p>	<p> Use suitable tools to check the voltage.</p>
<p>4 Disconnect the GPM from the connection to the power supply.</p>	
<p>5 Stow the GPM safely for removal.</p>	<p> Take into consideration the instructions for transport and storage in chapter 12.5.8 .</p>

WORK STEP	ILLUSTRATION / OTHER INFO
6 Clear the charging system of tools and auxiliary equipment that was used during the assembly and installation.	 Do not forget any utensils, that you have required for the assembly and installation of the CPM. Do not leave any waste behind (packaging material) with the user of the ICS.
7 Dispose of the GPM taking into consideration the instructions for the disposal of electrical devices in chapter 10.1.	

12.7 Vehicle Integration of the CPM

12.7.1 Installation Information

The electrical, mechanical and thermal integration of the CPM is to be ensured by the vehicle manufacturer.

12.7.2 Mounting the CPM

Observe the following points for the mounting of the CPM:

- The CPM must be installed at a dry location.
- The mechanical fastening must be positioned, so that the device is installed firmly and with as little vibration as possible.
- Cable feeds must not bunch up on sharp-edged components.
- The CPM is to be installed at the three fastening points illustrated:

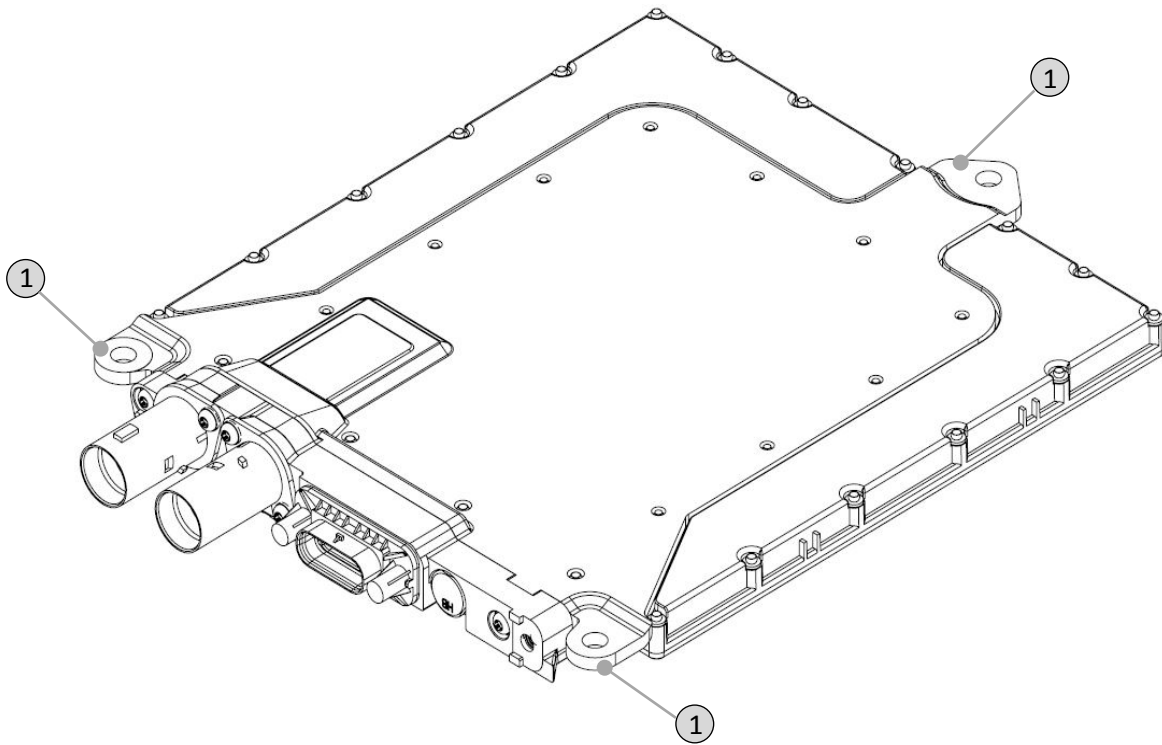

12.7.3 Line Connections CPM

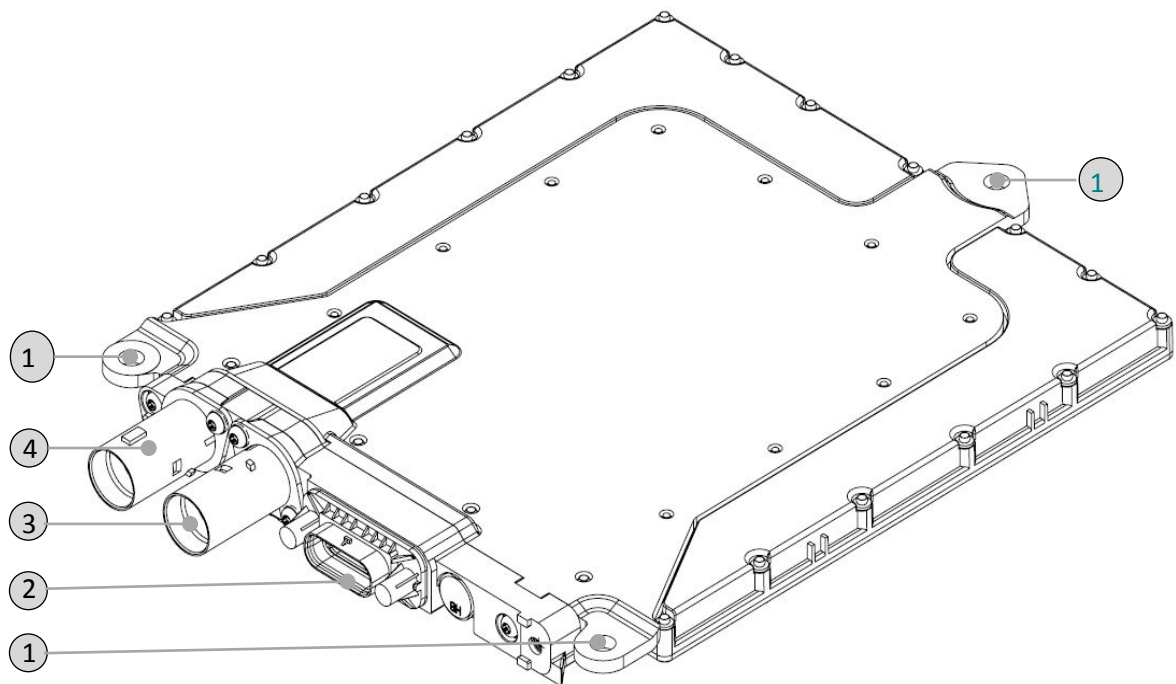

1

1. Ground screws GND for screws M6	2. LV-connector vehicle 12-pin (Code B)
3. HV-connector (Code A)	4. HV-connector (Code B)

12.7.3.1 Ground GND

INFORMATION



The ground screw must be connected with the ground of the vehicle or the test stand.

We generally recommend to route the ground lines of all drive components together at one ground point. This minimizes the risk of potential differences, which can lead to malfunctions of individual drive components!

The cable cross-section of the ground line must correspond with the dimension of the HV-lines.

12.7.3.2 Pin-Assignment LV-Connector Vehicle 12-pin (Code B, device-side)

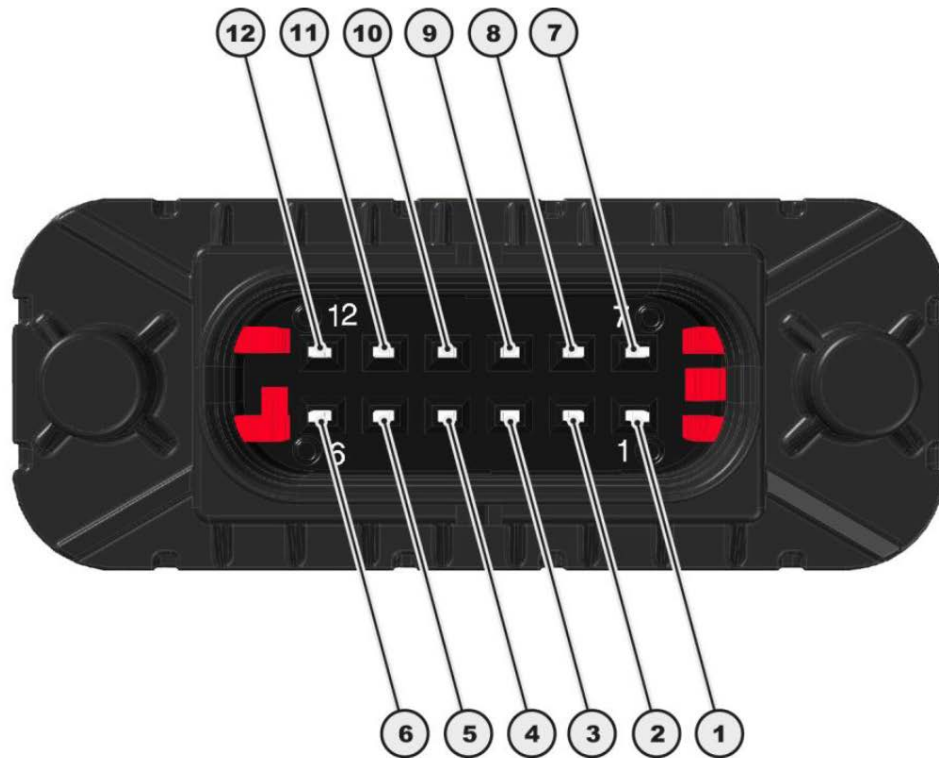

1. KI30	+12 V (supply system Plus)	2. EV_CAN_H	EV CAN high
3. KI30C	KI30 Crash	4. HVIL_out	HV-Interlock loop output
5. ---	Not contacted	6. ---	Not contacted
7. KI31	Ground (supply system Minus)	8. EV_CAN_L	EV CAN low
9. HVIL_in	HV-Interlock loop input	10. ---	Not contacted
11. Debug_CAN_H	Debug CAN high	12. Debug_CAN_L	Debug CAN low

12.7.3.3 Pin Assignment HV-Connector (Code A)

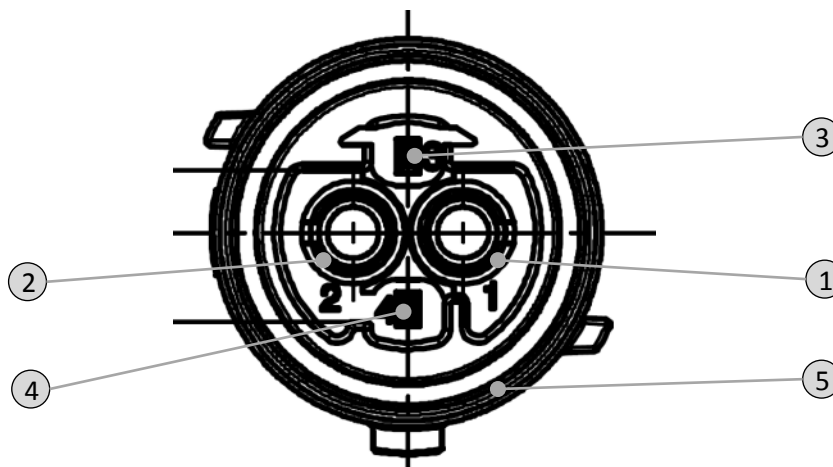

1. HV_DC_+	HV Battery Plus	2. HV_DC_-	HV Battery Minus
3. HVIL_in	HV-Interlock Loop Input	4. HVIL_out	HV-Interlock Loop Output
5. GND	Housing (equipotential bonding)		



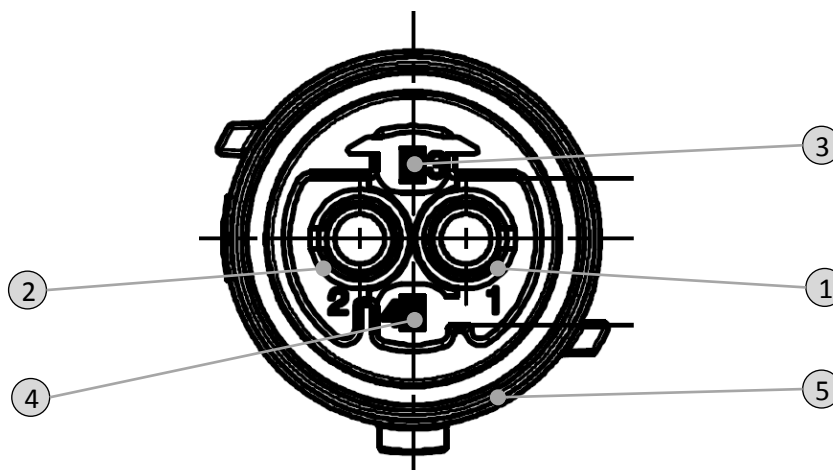



12.7.3.4 Pin Assignment HV-Connector (Code B)



1. HV_DC_+	HV Battery Plus	2. HV_DC_-	HV Battery Minus
3. HVIL_in	HV-Interlock Loop Input	4. HVIL_out	HV-Interlock Loop Output
5. GND	Housing (equipotential bonding)		





12.7.4 Planning the Assembly and Installation of the CPM

CAUTION	
	<p>Installation of the CPM requires a vehicle with insulation monitor</p> <p>The CPM may only be installed in vehicles with an insulation monitor. In the CPM the HVDC live parts are basic insulated against SELV (Safety Extra Low Voltage). As error protection the IT-network of the vehicle traction circuit is used. If the insulation monitor detects a failure of the insulation, a connection of the HV-battery should be prevented.</p>

WORK STEP	ILLUSTRATION / OTHER INFO
<p>1 Determine the installation position of the CPM.</p>	 Note the dimensions and installation instructions of the CPM (user manual ICS) and the dimensions of the vehicle.
<p>2 Determine that work step, for which the CPM should be available for the installation in the target vehicle.</p>	 Please note, that for the connection of the CPM to the drive battery, this must already be installed in the vehicle!
<p>3 Ensure the availability of the CPM for the integration of the CPM in the vehicle for that work step determined at 2.</p>	 Take into consideration the ordering- and delivery times.
<p>4 Ensure the availability of the connections in the vehicle required for the CPM.</p>	 Note the mechanical connection of the CPM in the vehicle as well as connections to the vehicle battery and to the vehicle wiring system.
<p>5 Ensure the availability of the auxiliary equipment and the information (user manual), in order to be able to undertake the installation of the CPM, and if necessary, to be able to check the correct installation.</p>	 Make sure to include corresponding tools in the planning, CPM-side and also vehicle-side.
<p>6 Ensure, that all information required for the assembly and installation of the CPM, is available for the assembly and present during the assembly.</p>	 Note the information- and communication channels.

12.7.5 Transport and Storage of the CPM

CAUTION	
	<p>Caution during transport and storage of the CPM!</p> <p>Note the technical specifications of the CPM, e.g. weight. Please note, that with careless handling of the CPM, injuries are possible: injuries on CPM or packaging, as well as injuries through allowing the CPM to fall!</p>







WORK STEP	ILLUSTRATION / OTHER INFO
1 Preparation: Determine, whether a cautious and careful handling of the CPM (possibly in packaging) is possible. You thereby avoid transport damage to the CPM.	 Make sure, that routes for the manual transport are free (no tripping hazards) and provide sufficient space!
2 Lifting: Lift the CPM taking into consideration the weight, the dimensions and the center of gravity.	
3 Handling and Transport: Make sure, that you can safely hold the CPM while working.	 Caution when placing the CPM down on smooth surfaces or if the CPM slips out of the packaging.
4 Setting down: Place the CPM (possibly in packaging) on a level surface.	 Ensure compliance with the conditions in section 12.5.8 for storage or transport of the CPM.
5 Storage: Store the CPM (possibly in packaging) horizontal on a level surface. Place the base area of the CPM (possibly in packaging) completely on the storage surface. Avoid damage to the CPM due to incorrect storage.	 Ensure compliance with the conditions in section 12.5.8.1 for storage of the CPM.

12.7.6 Installation of the CPM

DANGER	
	<p>High Voltage! Danger to life!</p> <p>Before commencing work, ensure zero voltage in the HV-circuit! Follow the prescribed work sequence without fail! Do not act recklessly and impetuously under any circumstances!</p>



INFORMATION	
	<p>Visually inspect the packaging material and in particular the CPM itself for damage before installation. At BRUSA every CPM undergoes a strict quality- and function control before delivery. However we have no influence on the long transport routes in some cases and the loading activities of our products.</p>

WORK STEP	ILLUSTRATION / OTHER INFO
-----------	---------------------------

WORK STEP	ILLUSTRATION / OTHER INFO
<p>1 Separate the CPM from the rest of the packaging material. Remove the film from the heat conducting pad.</p>	 Remove the CPM carefully from the packaging. Make sure not to damage the CPM. Do not wear any jewelry during the installation.
<p>2 Follow the installation instructions of the CPM for the target vehicle of the respective vehicle manufacturer.</p>	
<p>3 Install the CPM mechanically at the intended location. For the installation use the fastening points provided for this purpose, see chapter 12.7.2.</p>	 Observe the installation instructions (e.g. torques for screws) of the vehicle manufacturer for the installation of the CPM in the intended vehicle.
<p>4 Establish the ground connection between CPM and vehicle.</p>	 Note the position of the connection in chapter 12.7.3. The cable length should be chosen as short as possible.
<p>5 Connect the HV-connector of the CPM with the drive battery resp. the charging circuit of the intended vehicle or with the air conditioning compressor of the intended vehicle.</p>	 The connections for the respective HV-connector are to be connected color matched (black and white). The HV-connector is unambiguously connectable. If different possibilities exist for plugging in, abort the installation at this point.
<p>6 Connect the LV-connector of the CPM with the wiring system of the target vehicle.</p> <ul style="list-style-type: none"> - Power supply - Communication 	 The LV-connector is unambiguously connectable. If different possibilities exist for plugging in, abort the installation at this point.
<p>7 Switch the CPM power supply on.</p>	 If no connection can be established to the CPM, do not continue with the following steps, rather first rectify the error in the communication.
<p>8 Check the correct installation of the CPM.</p>	
<p>9 Conclude the installation: Stow the tools used and dispose of any other packaging.</p>	 After the 8 th work step the CPM is installed ready.

12.7.7 Deinstallation of the CPM

The deinstallation of the CPM component may only be performed by specialist personnel. Contact customer service.

WORK STEP	ILLUSTRATION / OTHER INFO
<p>1 Ensure for a safe working environment during the deinstallation.</p> <p>If the CPM is hot, wait until it has cooled down.</p>	<p> Make sure, that no sources of danger can occur during the deinstallation (e.g. crushing due to the vehicle rolling away). Do not wear any jewelry during the deinstallation.</p> <p> Danger of injury with hot CPM.</p>
<p>2 Interrupt the CPM Interlock.</p>	
<p>3 Follow the instructions for the removal of the CPM for the intended vehicle of the respective vehicle manufacturer.</p>	
<p>4 Dispose of the CPM, taking into consideration the regulations for the disposal of electrical devices in chapter 10.1.</p>	

13 Annex A2

13.1 Standards and Legal Requirements

The standards and legal requirements that the ICS product fulfills, are compiled in the following table:

Table 3: Standards

NO	REQUIREMENT	CONTENT
1	2014/53/EU	Provision of radio equipment on the market
2	2011/65/EU	Restriction of Hazardous Substances - RoHS
3	EN 55011:2009+A1:2010	Industrial, scientific and medical equipment - Radio-frequency disturbance characteristics - Limits and methods of measurement
4	EN 61000-3-2:2014	Electromagnetic compatibility (EMC) – Part 3-2: Limits - Limits for harmonic current emissions
5	EN 61000-3-3:2013	Electromagnetic compatibility (EMC) – Part 3-3: Limits - Limitation of voltage changes, voltage fluctuations and flicker
6	EN 61000-6-2:2005+AC:2005	Electromagnetic compatibility (EMC) – Part 6-2: Generic standards - Immunity for industrial environments
7	EN 300 328 V2.1.1	Wideband transmission systems - Data transmission equipment operating in the 2.4 GHz ISM band and using wide band modulation techniques
8	EN 300 330 V2.1.1	Electromagnetic Compatibility and Radio Spectrum Matters (ERM) - Short Range Devices (SRD)
9	EN 301 489-1 V2.1.1	Electromagnetic compatibility and Radio spectrum Matters (ERM); Electromagnetic Compatibility (EMC) standard for radio equipment
10	EN 301 489-3 V2.1.1	Electromagnetic compatibility and Radio spectrum Matters (ERM); Electromagnetic Compatibility (EMC) standard for radio equipment and services
11	EN 301 489-17 V3.2.0	Electromagnetic Compatibility (EMC) standard for radio equipment and services - Part 17: Specific conditions for Broadband Data Transmission Systems
12	EN 50364:2010	Limitation of human exposure to electromagnetic fields from devices
13	EN 62479:2010	Assessment of the compliance of low power electronic and electrical equipment with the basic restrictions related to human exposure to electromagnetic fields (10 MHz to 300 GHz)

NO	REQUIREMENT	CONTENT
14	IEC 61980-1:2015	Electric vehicle wireless power transfer (WPT) systems - Part 1: General requirements
15	ICNIRP 1998	Directives for the limitation of the exposure due to time-varying electric, magnetic and electromagnetic fields (up to 300 GHz)
16	EN 50581:2012	Assessment of electrical and electronic products with respect to the restriction of hazardous substances

13.2 DECLARATIONS OF CONFORMITY

13.2.1 SIMPLIFIED EU-DECLARATION OF CONFORMITY ICS115

BRUSA Elektronik AG herewith declares, that the radio equipment type ICS115 conforms to the directive 2014/53/EU. The complete text of the EU-Declaration of Conformity is available at the following Internet address:

www.brusa.biz/<todo>

13.2.2 SIMPLIFIED EU-DECLARATION OF CONFORMITY ICS1-WLAN-ATWILC-MU-D

BRUSA Elektronik AG herewith declares, that the radio equipment type ICS1-WLAN-ATWILC-MU-D conforms to the directive 2014/53/EU. The complete text of the EU-Declaration of Conformity is available at the following Internet address:

www.brusa.biz/<todo>

14 Index

- Abbreviations, 7
- Alignment GPM, 43
- Center of Gravity
 - CPM, 39
 - GPM, 38
- Cleaning, 35
- Cleanliness
 - CPM, 35
 - GPM, 35
- Connections
 - CPM, 51
- Contact
 - Customer Service, 10
 - Manufacturer, 10
 - Service, 10
- Deinstallation, 36
 - CPM, 57
 - GPM, 49
- Dimensions
 - CPM, 38
 - GPM, 37
- Disposal, 36
- Efficiency, 14
- Emergency situations, 32
- Energy Efficiency, 14
- Foreword, 8
- Functionality, 13
- Functionality
 - LOD, 22
- Functionality
 - FOD, 22
- Functionality
 - Efficiency Control, 23
- Imprint, 2
- Installation
 - CPM, 56
- Installation and Commissioning
 - GPM, 26
- Installation information, 42, 50
- Maintenance, 34
- Mounting Rails GPM, 44
- Position GPM, 43
- Product identification
 - CPM**, 10
 - GPM, 9
 - ICS, 9
- Removal of the ICS, 36
- Scope of Application
 - ICS, 12
- Scope of supply, 11

Storage	ICS, 40
CPM, 55	Transport
GPM, 49	CPM, 55
Support, 10	GPM, 49
Technical Data	Troubleshooting
CPM, 41	by User, 33
Energy Supply, 14	Warranty, 36
GPM, 41	

15 Glossary

Derating

Reduction of the charging capacity. Protective function of the system when limits are exceeded, e.g. temperature limits.

Electromagnetic Field

Physical effect, during which electrically conductive objects situated within the field heat up and therefore can cause dangers for people (e.g. burning, fire).

Electromagnetic Induction

Physical effect, on which the cordless transmission of energy from the charging station (GPM) to the vehicle (CPM) is based