

TEST REPORT

Report No.: SHE23040034-02AE

Date: 2023-05-06

Page 1 of 47

Applicant : Keeson Technology Corporation Limited
Address of Applicant : No. 195, Yuanfeng East Road, Wangjiangjing, Xiuzhou District, Jiaxing City, 314000, China

Product Name : REMOTE CONTROL

Brand Name : N/A

Model Name : RF432A

Sample Acquisition Method : Sent by Client

Sample No. : E23040034-01#02

E23040004-01#03

FCC ID : 2AK23-RF432A

ISED Number : 22406-RF432A

Standards : FCC CFR47 Part 15, Subpart C Section 15.249
RSS-Gen (Issue 5, Amd.2-Feb 2021)
RSS-210 (Issue 10, Amendment-Apr 2020)

Date of Receipt : 2023-04-10

Date of Test : 2023-04-27 ~ 2023-05-04

Date of Issue : 2023-05-06

Remark:

This report details the results of the testing carried out on one sample, the results contained in this report do not relate to other samples of the same product. The manufacturer should ensure that all products in series production are in conformity with the product sample detailed in this report.

Prepared by:



(Erik Yang)

Reviewed by:



(Jennifer Zhou)

Approved by:



(Authorized signatory: Guoyou Chi)

TEST REPORT

Report No.: SHE23040034-02AE

Date: 2023-05-06

Page 2 of 47

Contents

1	GENERAL INFORMATION	3
1.1	TESTING LABORATORY	3
1.2	DETAILS OF APPLICATION	3
1.3	DETAILS OF EUT	3
1.4	TEST METHODOLOGY	5
1.5	TEST SUMMARY	5
2	TEST CONDITION	6
2.1	ENVIRONMENTAL CONDITIONS	6
2.2	EQUIPMENT LIST	6
2.3	MEASUREMENT UNCERTAINTY	6
3	TEST SET-UP AND OPERATION MODES	7
3.1	DETAILS OF TEST MODE	7
3.2	SPECIAL ACCESSORIES AND AUXILIARY EQUIPMENT	7
3.3	SUPPORT SOFTWARE	7
3.4	TEST SETUP DIAGRAM	8
4	TEST RESULTS	9
4.1	TRANSMITTER REQUIREMENT & TEST SUITES	9
4.1.1	<i>Antenna Requirement</i>	9
4.1.2	<i>Radiated Emission</i>	10
4.1.3	<i>Band Edge</i>	35
4.1.4	<i>20dB Bandwidth and 99% Bandwidth</i>	39
5	APPENDIXES	42
5.1	PHOTOGRAPHS OF THE SAMPLE	42
5.2	SET-UP FOR SPURIOUS EMISSIONS BELOW 1GHZ	47
5.3	SET-UP FOR SPURIOUS EMISSIONS ABOVE 1GHZ	47

TEST REPORT

Report No.: SHE23040034-02AE

Date: 2023-05-06

Page 3 of 47

1 General Information

1.1 Testing Laboratory

ISED CAB identifier #	CN0081
Company Name	ICAS Testing Technology Service (Shanghai) Co., Ltd.
Address	No.1298 Pingan Rd, Minhang District, Shanghai, China
Telephone	0086 21-51682999
Fax	0086 21-54711112
Homepage	www.icasiso.com

1.2 Details of Application

Applicant Company Name	Keeson Technology Corporation Limited
Address	No. 195, Yuanfeng East Road, Wangjiangjing, Xiuzhou District, Jiaxing City, 314000, China
Contact Person	Sam xu
Telephone	18279170755
Email	xuwb@keeson.com
Manufacturer Company Name	DewertOkin Technology Group Co., Ltd.
Address	No.465, Xinnanyang Road, Wangjiangjing Development Zone, Xiuzhou District, Jiaxing City, Zhejiang Province, China.
Factory Company Name	DewertOkin Technology Group Co., Ltd.
Address	No.465, Xinnanyang Road, Wangjiangjing Development Zone, Xiuzhou District, Jiaxing City, Zhejiang Province, China.

1.3 Details of EUT

Product Name	REMOTE CONTROL
Brand Name	N/A
Test Model Name	RF432A
FCC ID	2AK23-RF432A
ISED Number	22406-RF432A
Operation Frequency	2403MHz ~ 2480MHz
Maximum Field Strength	85.86dBuV/m(Peak)@3m
Number of Channels	78
Modulation Type	GFSK
Antenna Type	PCB Antenna
Antenna Gain	1.225dBi
Extreme Temperature Range	-10°C ~ +40°C
Test Voltage	DC 4.5V supply by battery
Hardware Version	R5.109.00.1063A

TEST REPORT

Report No.: SHE23040034-02AE

Date: 2023-05-06

Page 4 of 47

Software Version	V1.0
RF power setting in TEST SW	Enter the fixed frequency mode by pressing the key_Default power

Note:

1. The above information was declared by the manufacture.
2. For more details, please refer to the User's manual of the EUT.

Channel List

Channel	Frequency	Channel	Frequency	Channel	Frequency
1	2.403GHz	28	2.430GHz	55	2.457GHz
2	2.404GHz	29	2.431GHz	56	2.458GHz
3	2.405GHz	30	2.432GHz	57	2.459GHz
4	2.406GHz	31	2.433GHz	58	2.460GHz
5	2.407GHz	32	2.434GHz	59	2.461GHz
6	2.408GHz	33	2.435GHz	60	2.462GHz
7	2.409GHz	34	2.436GHz	61	2.463GHz
8	2.410GHz	35	2.437GHz	62	2.464GHz
9	2.411GHz	36	2.438GHz	63	2.465GHz
10	2.412GHz	37	2.439GHz	64	2.466GHz
11	2.413GHz	38	2.440GHz	65	2.467GHz
12	2.414GHz	39	2.441GHz	66	2.468GHz
13	2.415GHz	40	2.442GHz	67	2.469GHz
14	2.416GHz	41	2.443GHz	68	2.470GHz
15	2.417GHz	42	2.444GHz	69	2.471GHz
16	2.418GHz	43	2.445GHz	70	2.472GHz
17	2.419GHz	44	2.446GHz	71	2.473GHz
18	2.420GHz	45	2.447GHz	72	2.474GHz
19	2.421GHz	46	2.448GHz	73	2.475GHz
20	2.422GHz	47	2.449GHz	74	2.476GHz
21	2.423GHz	48	2.450GHz	75	2.477GHz
22	2.424GHz	49	2.451GHz	76	2.478GHz
23	2.425GHz	50	2.452GHz	77	2.479GHz
24	2.426GHz	51	2.453GHz	78	2.480GHz
25	2.427GHz	52	2.454GHz		
26	2.428GHz	53	2.455GHz		
27	2.429GHz	54	2.456GHz		

TEST REPORT

Report No.: SHE23040034-02AE

Date: 2023-05-06

Page 5 of 47

1.4 Test Methodology

47 CFR Part 15, Subpart C	Telecommunication-Radio Frequency Devices-Intentional Radiators
RSS-Gen (Issue 5, Amd.2-Feb 2021)	General Requirements for Compliance of Radio Apparatus
RSS-210 (Issue 10, Amendment-Apr 2020)	Licence-Exempt Radio Apparatus: Category I Equipment
ANSI C63.10-2013	American National Standard for Testing Unlicensed Wireless Devices

Note(s):

All test items were verified and recorded according to the standards and without any addition/deviation/exclusion during the test.

1.5 Test Summary

Test Item	FCC Rules	ISED Rules	Result
Antenna Requirement	Part 15.203	RSS-GEN 6.8	PASS
Radiated Emission	FCC Part 15.249(a),15.209	RSS-210 B.10(a) RSS-GEN 8.9	PASS
Band Edge	FCC Part 15.249(d),15.209	RSS-210 B.10(b) RSS-GEN 8.10	PASS
20dB Bandwidth and 99% Bandwidth	FCC Part 15.215(c)	RSS-GEN 6.7	PASS
Conducted Emission on AC Mains	FCC Part 15.207(a)	RSS-Gen 8.8	N/A ^{note}

Note(s): The EUT is powered by battery (DC 4.5V supply by battery)

TEST REPORT

Report No.: SHE23040034-02AE

Date: 2023-05-06

Page 6 of 47

2 Test Condition

2.1 Environmental conditions

Temperature (°C)	18-25
Humidity (%RH)	40-65
Barometric Pressure (mbar)	960-1060

2.2 Equipment List

Name of Equipment	Manufacturer	Model	Serial No.	Cal. Date	Cal. Due
Spectrum Analyzer	Keysight	N9020B	MY59260184	2022-08-02	2023-08-01
Spectrum Analyzer	Rohde & Schwarz	FSV40N	101450	2022-06-10	2023-06-09
Signal Generator	Rohde & Schwarz	SMR27	100184	2022-08-02	2023-08-01
EMI Test Receiver	Rohde & Schwarz	ESR 7	101911	2022-06-10	2023-06-09
DC Power Supply	ITECH	IT6512A	N/A	2022-06-07	2024-06-06
Broadband Antenna	SCHWARZBECK	VULB9163	9163-1037	2021-06-08	2023-06-07
Horn Antenna	SCHWARZBECK	BBHA9120D	9120D-1775	2021-06-08	2023-06-07
Loop Antenna	SCHWARZBECK	FMZB 1513	/	2022-06-10	2023-06-09
Broadband Preamplifier	SCHWARZBECK	BBV 9718	346	2022-06-10	2023-06-09
EMC chamber 9*6*6 (L*W*H)	CHANGNING	966	N/A	2022-06-10	2023-06-09
Test Software	BL	BL410_E	Version:1.0.0.117	N/A	N/A
Test Software	BL	BL410_R	Version:2.1.1.409	N/A	N/A

2.3 Measurement Uncertainty

The uncertainty is calculated using the methods suggested in the "Guide to the Expression of Uncertainty in measurement" (GUM) published by CISPR and ANSI. The reported uncertainty of measurement $y \pm U$, where expanded uncertainty U is based on a standard uncertainty multiplied by a coverage factor of $k=2$, providing a level of confidence of approximately 95.45%.

Parameter	Uncertainty	
Antenna Port Conducted Emission	< 1GHz	± 1.5 dB
	> 1GHz	± 1.5 dB
Radiated Emission	9KHz – 30MHz	± 3.42 dB
	30 MHz – 1GHz	± 5.00 dB
	> 1GHz	± 4.88 dB
Occupied Channel Bandwidth	± 5 %	

TEST REPORT

Report No.: SHE23040034-02AE

Date: 2023-05-06

Page 7 of 47

3 Test Set-up and Operation Modes

3.1 Details of Test Mode

Enter the fixed frequency mode by pressing the key was control EUT work in continuous transmitter and receiver mode. Select test channel as below:

Channel	Frequency
The lowest channel(CH1)	2403MHz
The middle channel(CH40)	2442MHz
The highest channel(CH78)	2480MHz

The basic operation modes are:

- A. Transmitting
 - i. Low Channel
 - ii. Middle Channel
 - iii. High Channel

3.2 Special Accessories and Auxiliary Equipment

Description	Manufacturer	Model No.	Serial No.
N/A	N/A	N/A	N/A

3.3 Support Software

Description	Manufacturer	Software Name
N/A	N/A	N/A

TEST REPORT

Report No.: SHE23040034-02AE

Date: 2023-05-06

Page 8 of 47

3.4 Test Setup Diagram

Diagram of Measurement Configuration for Radiation Test

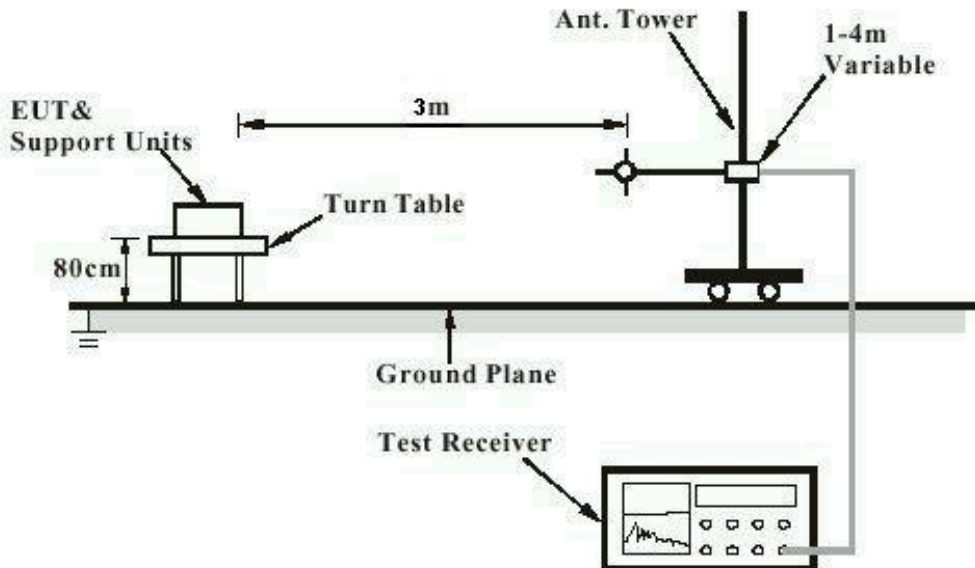

Note: Measurements above 1GHz are done with a table height of 1.5m. In addition, there is RF absorbing material on the floor of the test site for above 1GHz measurement.

Diagram of Measurement Configuration for Transmitter Test

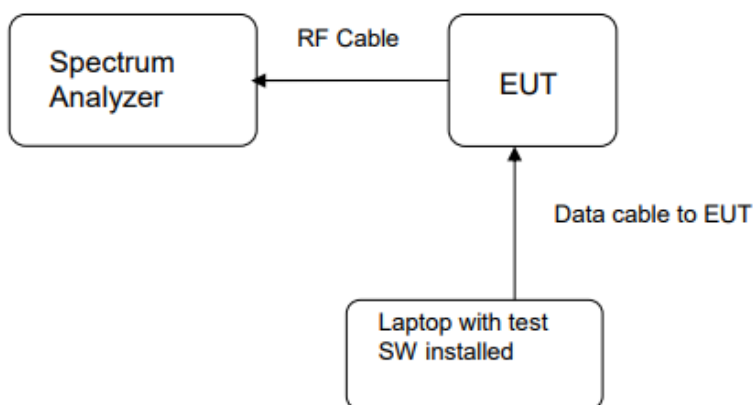

TEST REPORT

Report No.: SHE23040034-02AE

Date: 2023-05-06

Page 9 of 47

4 Test Results

4.1 Transmitter Requirement & Test Suites

4.1.1 Antenna Requirement

RESULT:

PASS

Test standard	: Part 15.203, RSS-GEN 6.8
Requirement	: An intentional radiator shall be designed to ensure that no antenna other than that furnished by the responsible party shall be used with the device. The use of a permanently attached antenna or of an antenna that uses a unique coupling to the intentional radiator shall be considered sufficient to comply with the provisions of this section. The manufacturer may design the unit so that a broken antenna can be replaced by the user, but the use of a standard antenna jack or electrical connector is prohibited.

According to the manufacturer declaration, the EUT has an antenna with a directional gain of 1.225dBi. The antenna is pcb antenna with no possibility of replacement with a non-approved antenna by the end-user.

Therefore, the EUT is considered to comply with this provision.

TEST REPORT

Report No.: SHE23040034-02AE

Date: 2023-05-06

Page 10 of 47

4.1.2 Radiated Emission

RESULT:

PASS

Test standard : FCC Part 15.249(a), 15.209
RSS-210 B.10(a), RSS-GEN 8.9

Requirement : ANSI C63.10-2013

Kind of test site : 3m Semi-Anechoic Chamber

Test setup

Test Channel : Low/Middle/High

Operation Mode : A.i/ii/iii

Ambient temperature : 23.4°C

Relative humidity : 50%

Notes

1. For 9 kHz ~ 30 MHz, the amplitude of spurious emissions that are attenuated by more than 20dB below the permissible. The value has no need to be reported.
2. The spurious above 18GHz is noise only and 20dB below the limit. The value has no need to be reported.
3. The EUT was pretested with 3 orientations placed on the table for the radiated emission measurement –X, Y, and Z-plane. The X-plane results were found as the worst case and were shown in this report.

TEST REPORT

Report No.: SHE23040034-02AE

Date: 2023-05-06

Page 11 of 47

Figure 1: Test plots of Field strength of fundamental, 2403MHz, Horizontal polarization

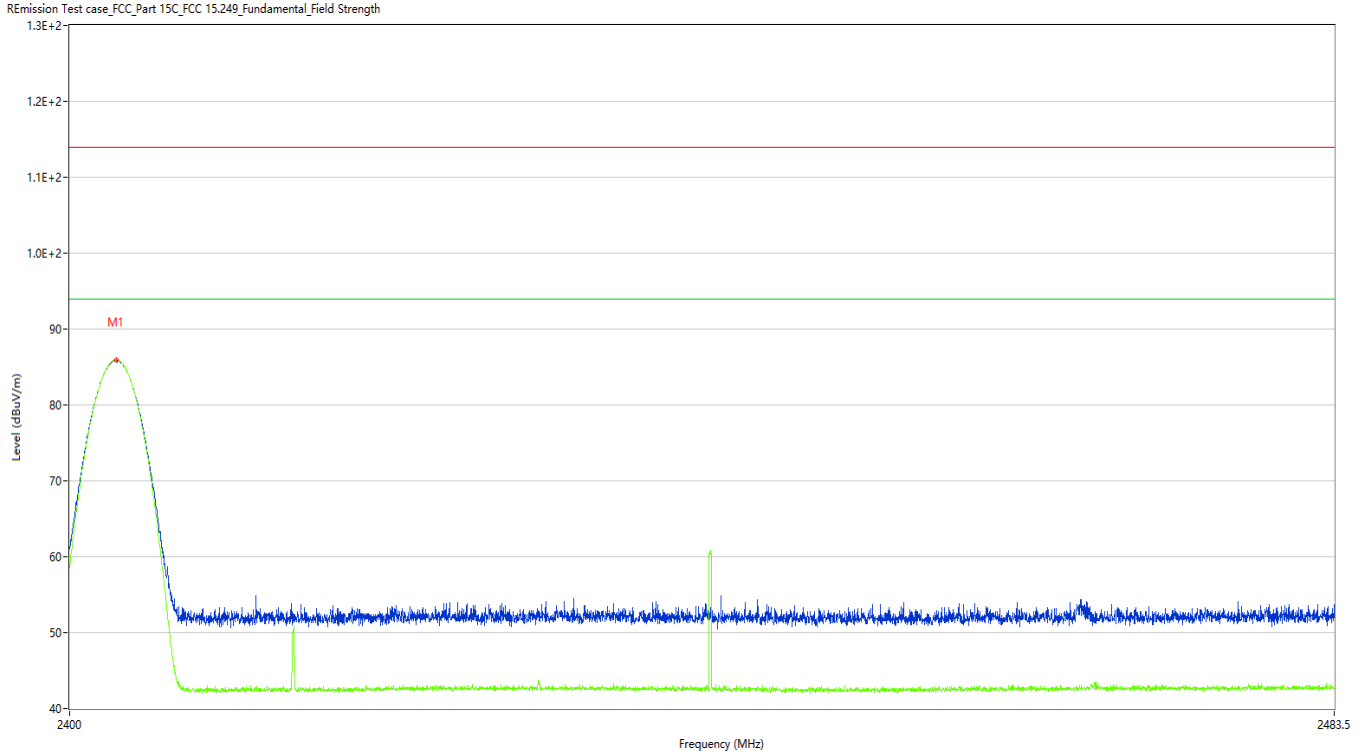

No.	Frequency (MHz)	Results (dBuV/m)	Factor (dB)	Limit (dBuV/m)	Margin (dB)	Detector	Table (Degree)	Height (cm)	Antenna	Verdict
1	2403.048	85.86	-9.82	114.0	28.14	Peak	356.10	100	Horizontal	Pass
1**	2403.048	85.82	-9.82	94.0	8.18	AV	356.10	100	Horizontal	Pass

TEST REPORT

Report No.: SHE23040034-02AE

Date: 2023-05-06

Page 12 of 47

Figure 2: Test plots of Field strength of fundamental, 2403MHz, Vertical polarization

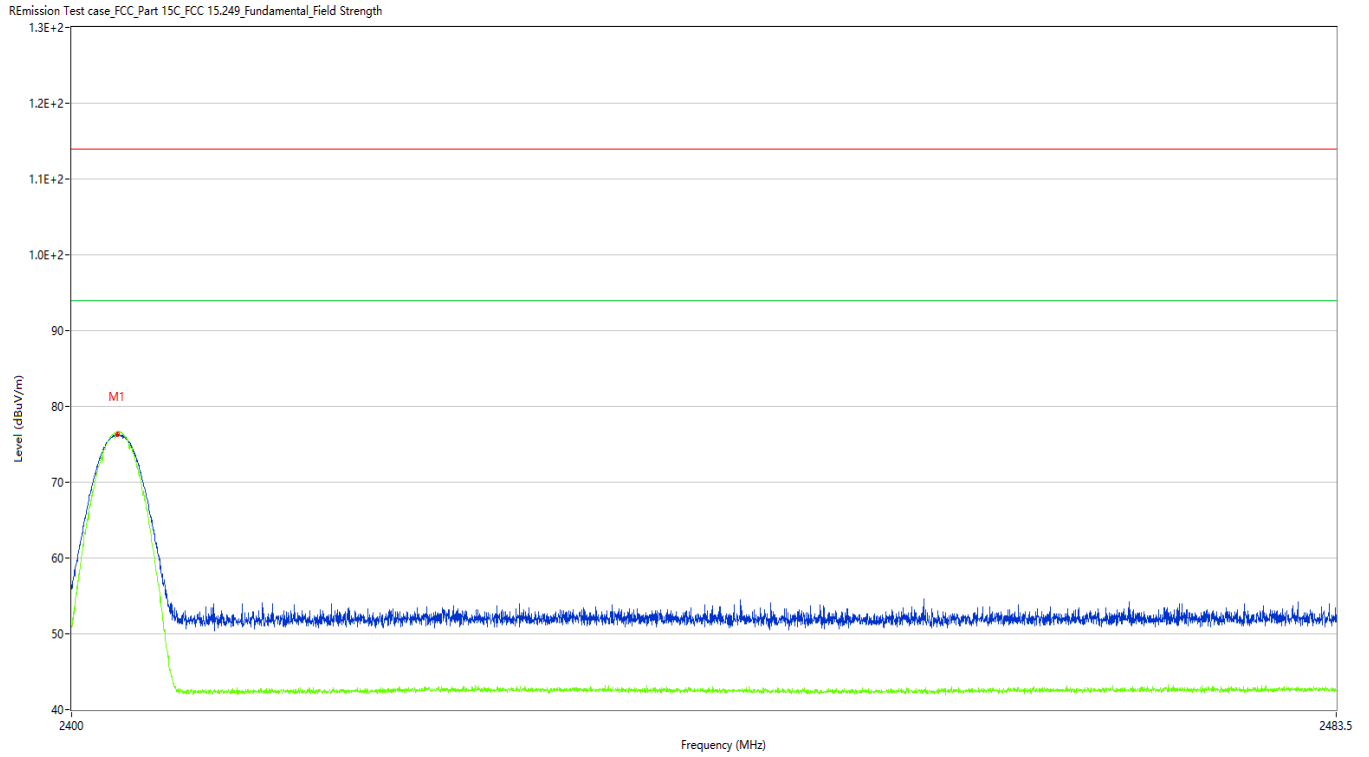

No.	Frequency (MHz)	Results (dBuV/m)	Factor (dB)	Limit (dBuV/m)	Margin (dB)	Detector	Table (Degree)	Height (cm)	Antenna	Verdict
1	2403.006	76.25	-9.82	114.0	37.75	Peak	163.70	100	Vertical	Pass
1**	2403.006	76.21	-9.82	94.0	17.79	AV	163.70	100	Vertical	Pass

TEST REPORT

Report No.: SHE23040034-02AE

Date: 2023-05-06

Page 13 of 47

Figure 3: Test plots of Field strength of fundamental, 2442MHz, Horizontal polarization

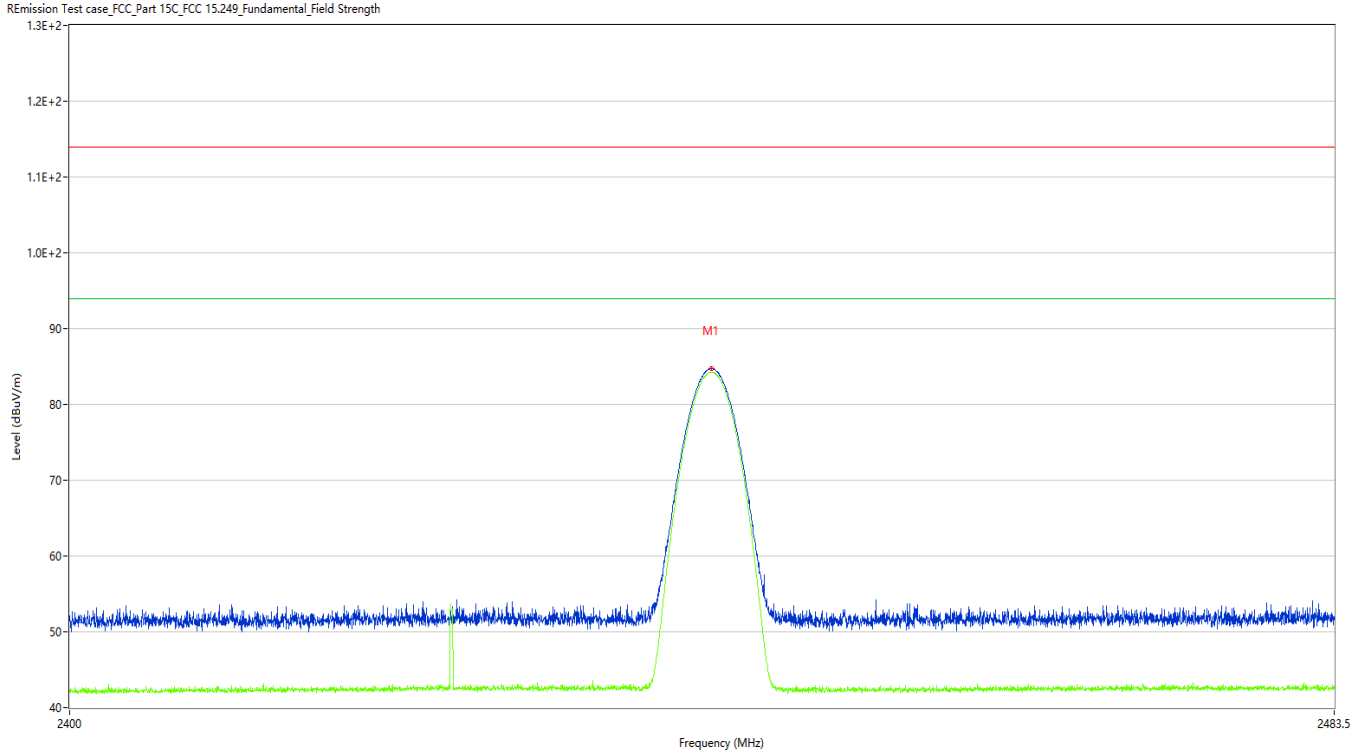

No.	Frequency (MHz)	Results (dBuV/m)	Factor (dB)	Limit (dBuV/m)	Margin (dB)	Detector	Table (Degree)	Height (cm)	Antenna	Verdict
1	2442.000	84.75	-9.61	114.0	29.25	Peak	340.40	100	Horizontal	Pass
1**	2442.000	84.25	-9.61	94.0	9.75	AV	340.40	100	Horizontal	Pass

TEST REPORT

Report No.: SHE23040034-02AE

Date: 2023-05-06

Page 14 of 47

Figure 4: Test plots of Field strength of fundamental, 2442MHz, Vertical polarization

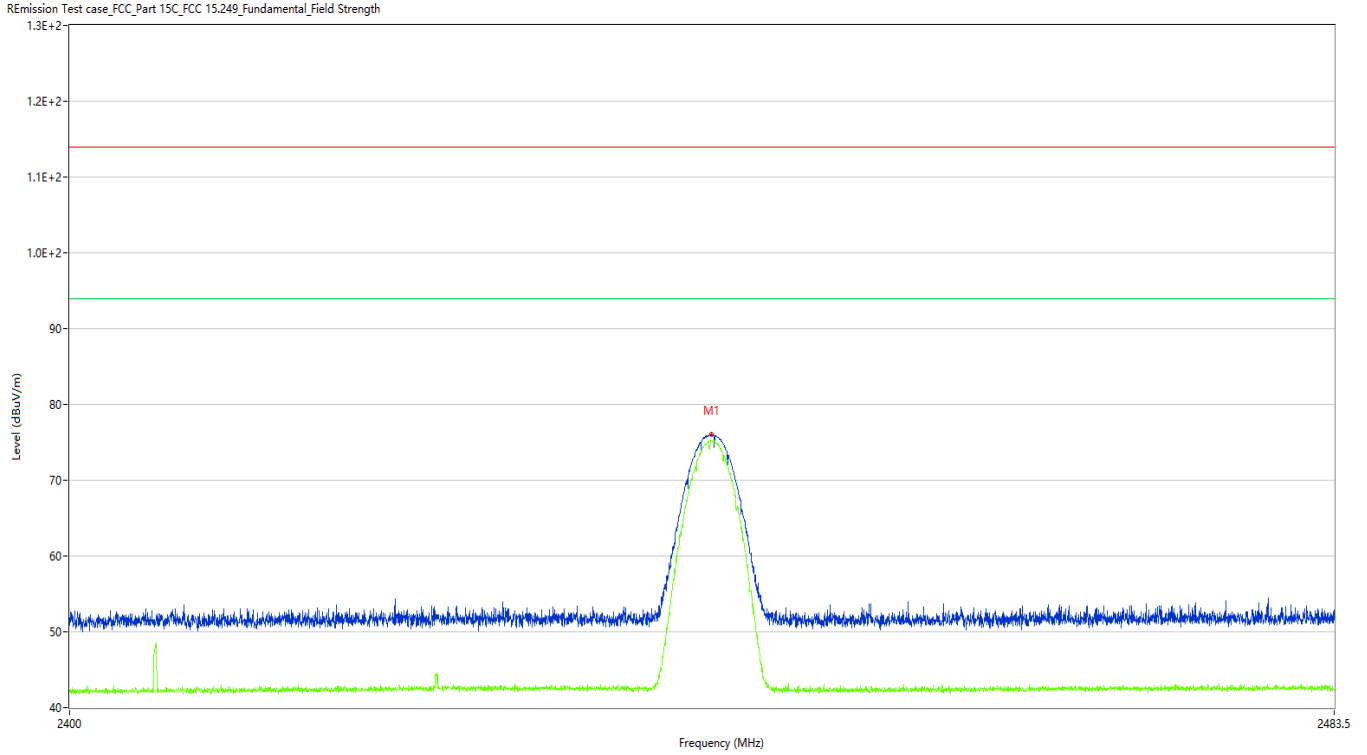

No.	Frequency (MHz)	Results (dBuV/m)	Factor (dB)	Limit (dBuV/m)	Margin (dB)	Detector	Table (Degree)	Height (cm)	Antenna	Verdict
1	2442.000	76.00	-9.61	114.0	38.00	Peak	144.70	100	Vertical	Pass
1**	2442.000	75.20	-9.61	94.0	18.80	AV	144.70	100	Vertical	Pass

TEST REPORT

Report No.: SHE23040034-02AE

Date: 2023-05-06

Page 15 of 47

Figure 5: Test plots of Field strength of fundamental, 2480MHz, Horizontal polarization

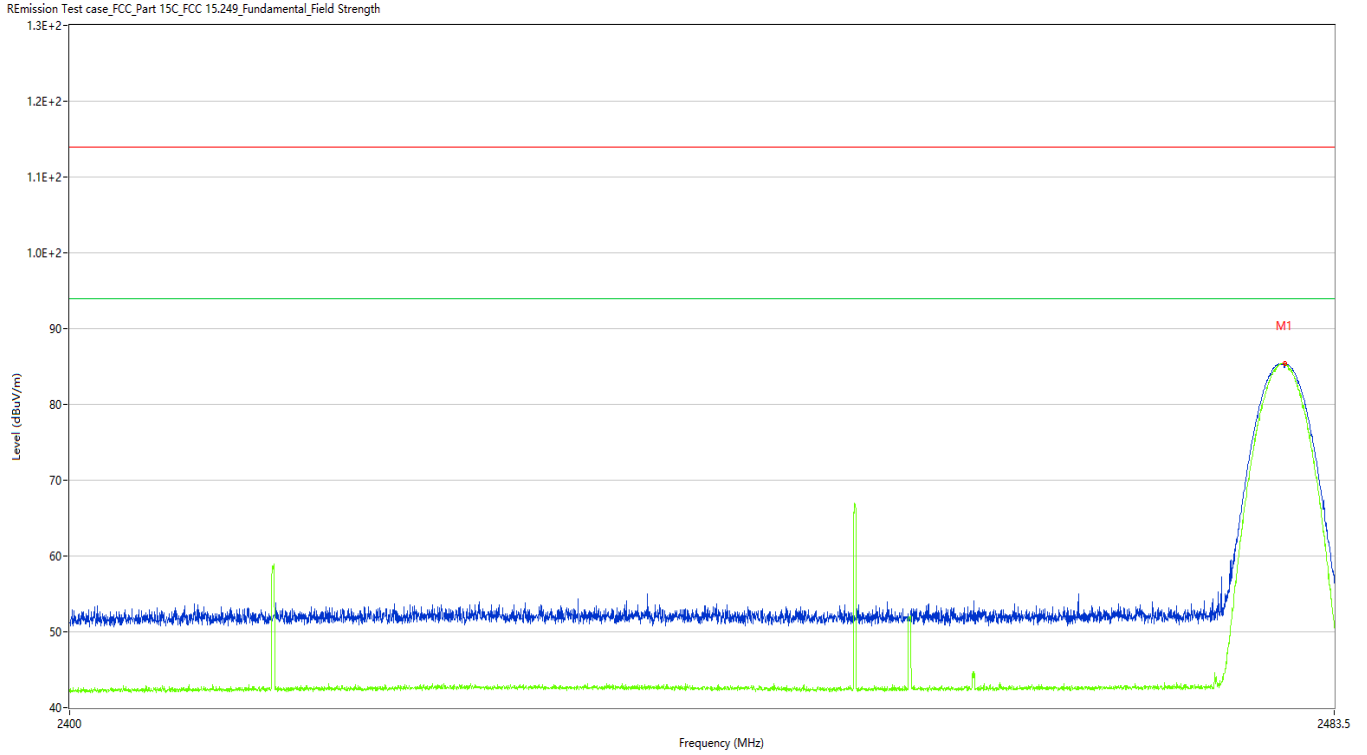

No.	Frequency (MHz)	Results (dBuV/m)	Factor (dB)	Limit (dBuV/m)	Margin (dB)	Detector	Table (Degree)	Height (cm)	Antenna	Verdict
1	2480.202	85.39	-9.48	114.0	28.61	Peak	329.30	200	Horizontal	Pass
1**	2480.202	85.29	-9.48	94.0	8.71	AV	329.30	200	Horizontal	Pass

TEST REPORT

Report No.: SHE23040034-02AE

Date: 2023-05-06

Page 16 of 47

Figure 6: Test plots of Field strength of fundamental, 2480MHz, Vertical polarization

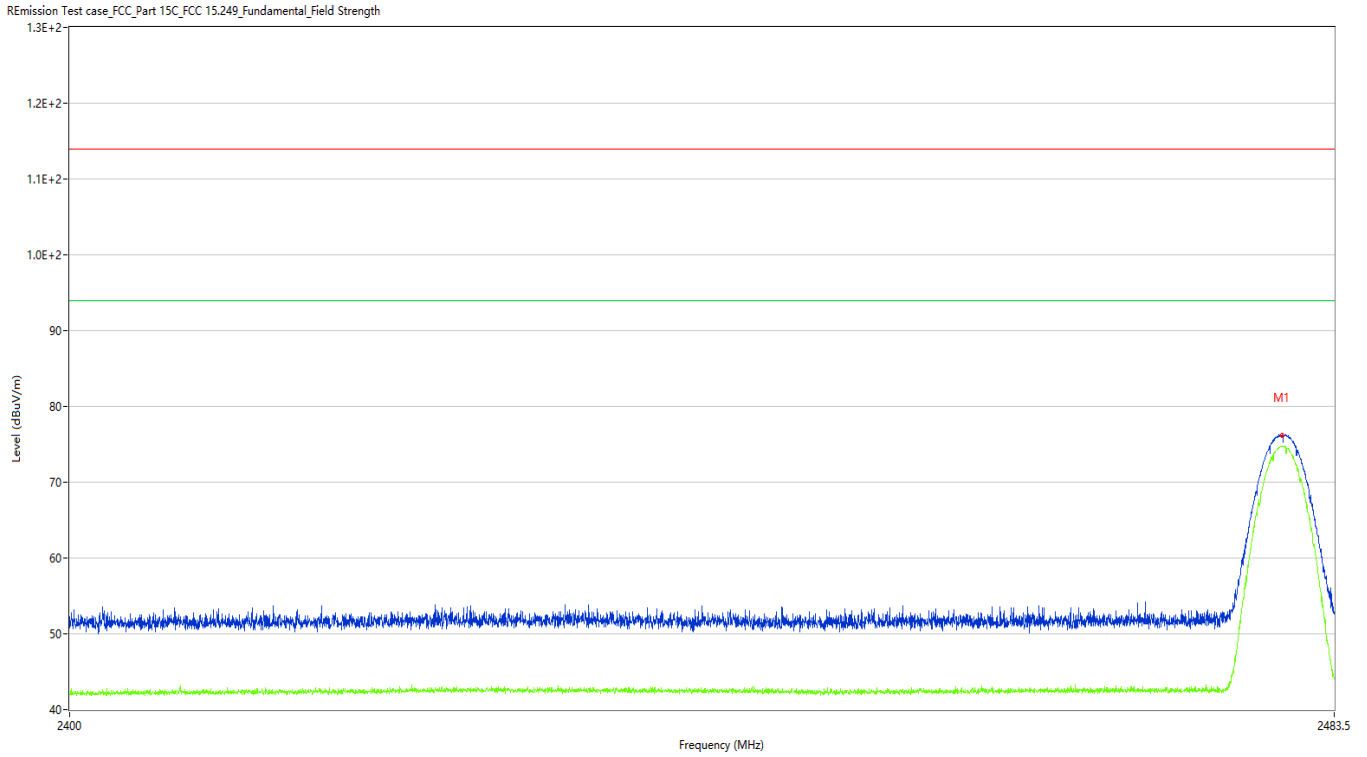

No.	Frequency (MHz)	Results (dBuV/m)	Factor (dB)	Limit (dBuV/m)	Margin (dB)	Detector	Table (Degree)	Height (cm)	Antenna	Verdict
1	2479.993	76.23	-9.48	114.0	37.77	Peak	262.00	100	Vertical	Pass
1**	2479.993	74.74	-9.48	94.0	19.26	AV	262.00	100	Vertical	Pass

TEST REPORT

Report No.: SHE23040034-02AE

Date: 2023-05-06

Page 17 of 47

Figure 7: Test plots of Field strength of harmonics, 2403MHz, 30MHz-1GHz, Horizontal polarization

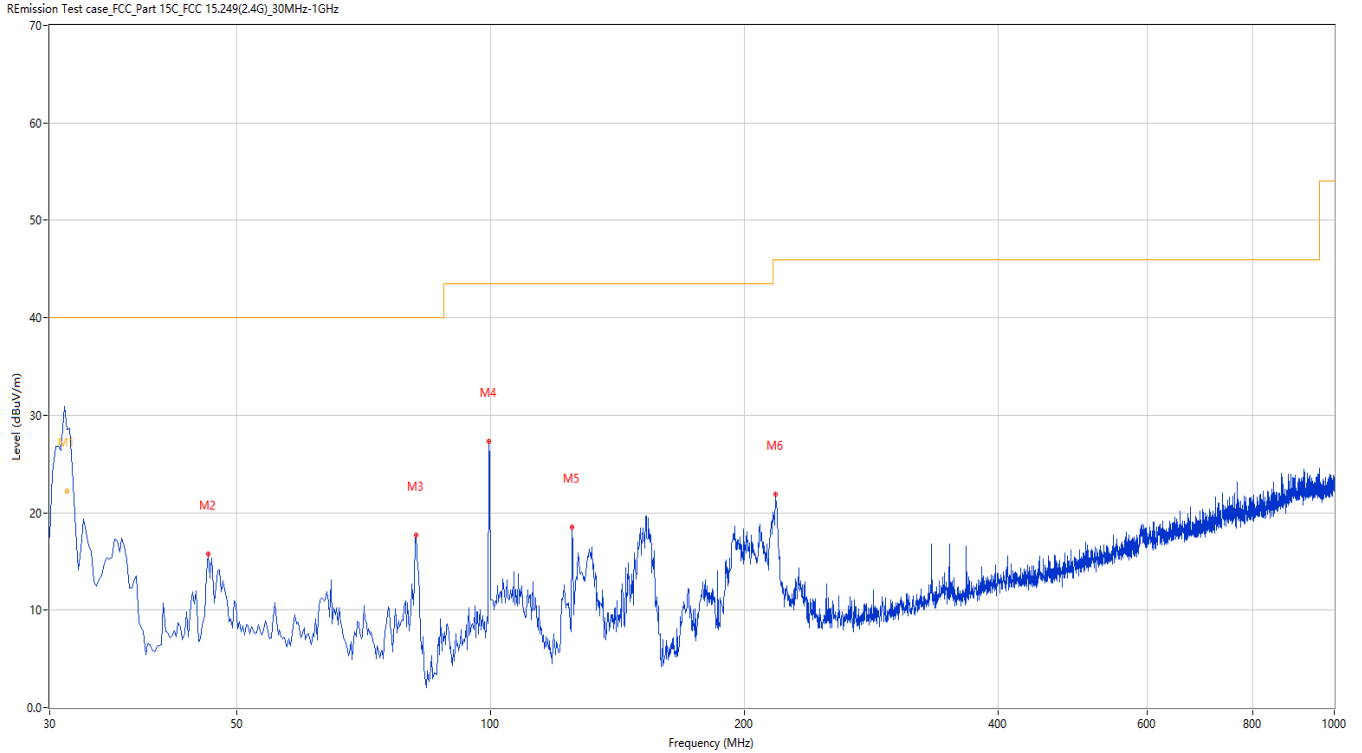

No.	Frequency (MHz)	Results (dBuV/m)	Factor (dB)	Limit (dBuV/m)	Margin (dB)	Detector	Table (Degree)	Height (cm)	Antenna	Verdict
1	31.430	32.08	-29.43	40.0	7.92	Peak	359.20	152	Horizontal	Pass
1*	31.430	22.18	-29.43	40.0	17.82	QP	359.20	152	Horizontal	Pass
2	46.243	15.75	-25.20	40.0	24.25	Peak	37.50	200	Horizontal	Pass
3	81.640	17.74	-31.35	40.0	22.26	Peak	242.20	200	Horizontal	Pass
4	99.580	27.30	-26.68	43.5	16.20	Peak	96.30	200	Horizontal	Pass
5	124.794	18.54	-28.97	43.5	24.96	Peak	77.00	200	Horizontal	Pass
6	217.406	21.93	-26.46	46.0	24.07	Peak	131.20	100	Horizontal	Pass

TEST REPORT

Report No.: SHE23040034-02AE

Date: 2023-05-06

Page 18 of 47

Figure 8: Test plots of Field strength of harmonics, 2403MHz, 30MHz-1GHz, Vertical polarization

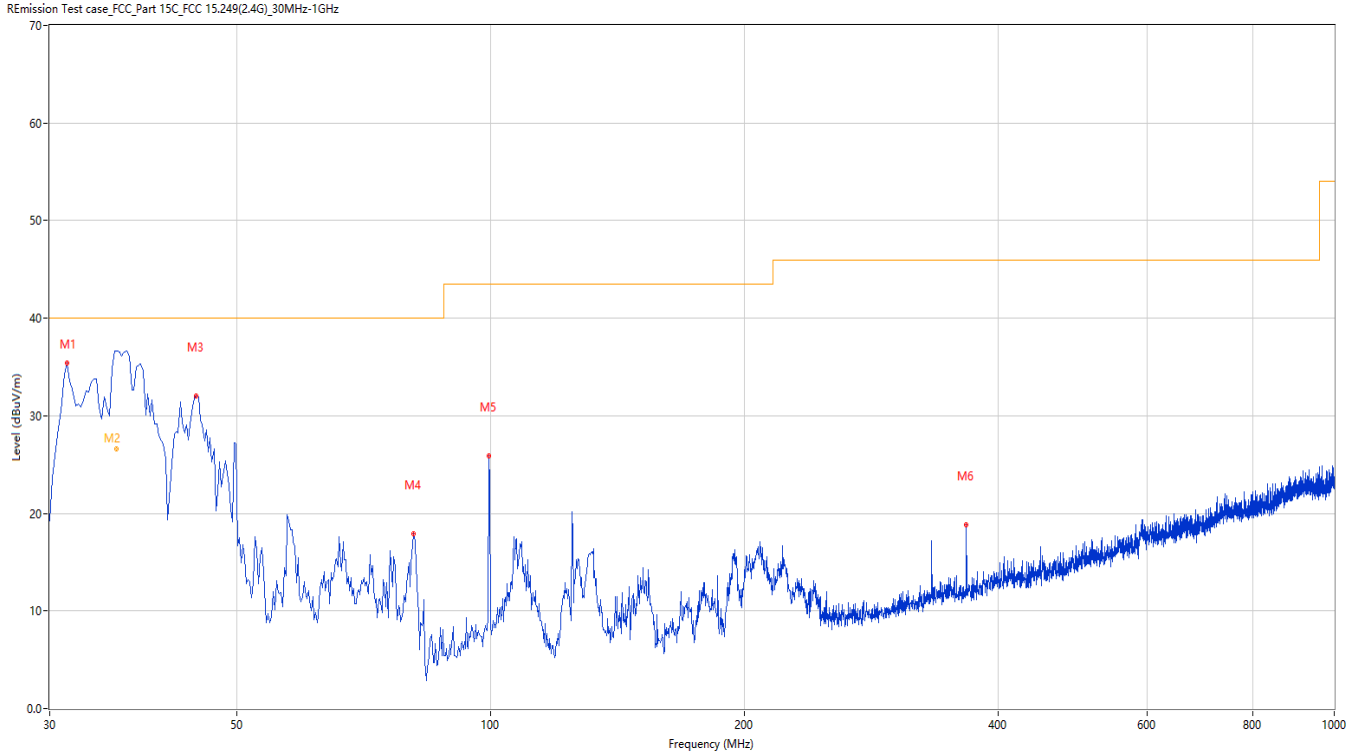

No.	Frequency (MHz)	Results (dBuV/m)	Factor (dB)	Limit (dBuV/m)	Margin (dB)	Detector	Table (Degree)	Height (cm)	Antenna	Verdict
1	31.455	35.43	-29.34	40.0	4.57	Peak	0.00	200	Vertical	Pass
2	35.949	36.16	-27.78	40.0	3.84	Peak	0.00	100	Vertical	Pass
2*	35.949	26.64	-27.78	40.0	13.36	QP	0.00	100	Vertical	Pass
3	44.789	32.01	-25.29	40.0	7.99	Peak	0.00	200	Vertical	Pass
4	80.912	17.94	-31.46	40.0	22.06	Peak	167.80	200	Vertical	Pass
5	99.580	25.86	-26.68	43.5	17.64	Peak	220.80	100	Vertical	Pass
6	366.506	18.81	-21.94	46.0	27.19	Peak	102.30	200	Vertical	Pass

TEST REPORT

Report No.: SHE23040034-02AE

Date: 2023-05-06

Page 19 of 47

Figure 9: Test plots of Field strength of harmonics, 2403MHz, 1GHz-7GHz, Horizontal polarization

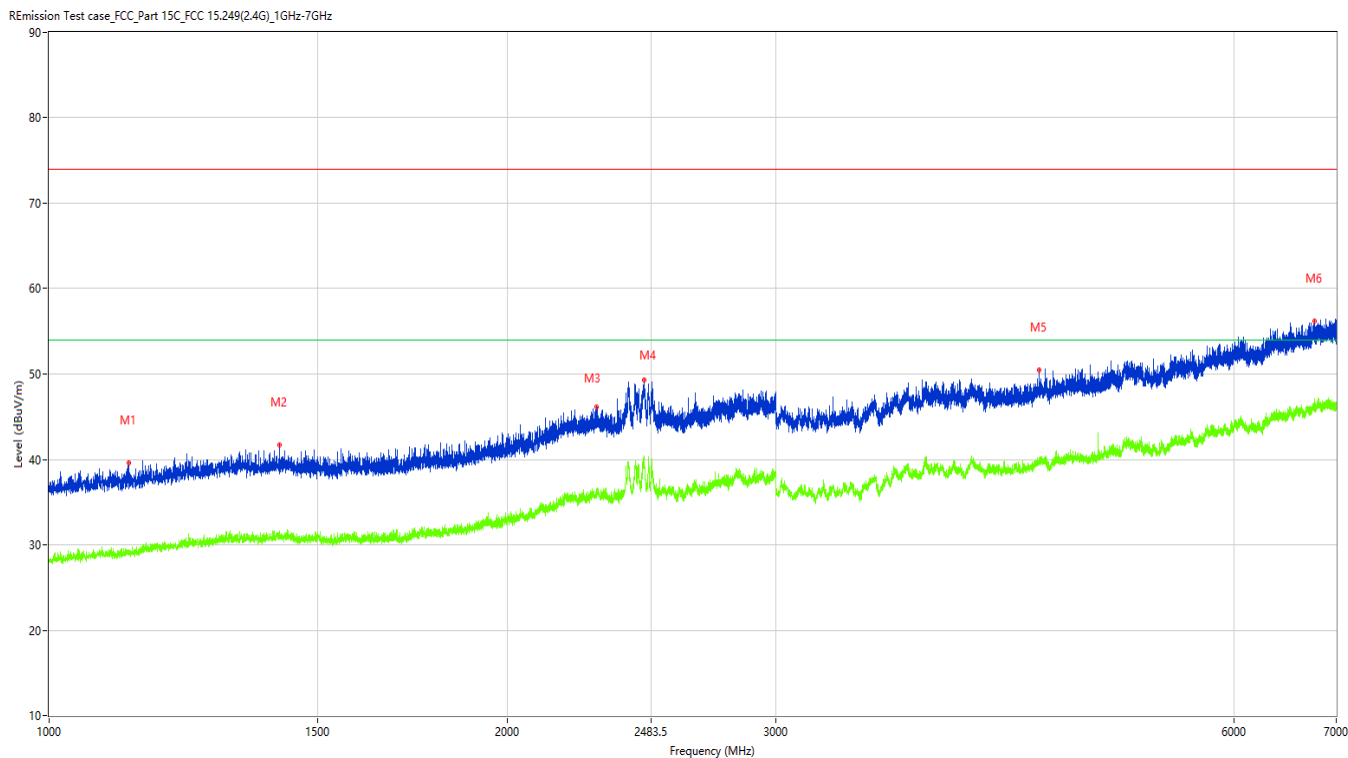

No.	Frequency (MHz)	Results (dBuV/m)	Factor (dB)	Limit (dBuV/m)	Margin (dB)	Detector	Table (Degree)	Height (cm)	Antenna	Verdict
1	1128.734	39.55	-14.05	74.0	34.45	Peak	269.50	100	Horizontal	Pass
1**	1128.734	28.93	-14.05	54.0	25.07	AV	269.50	100	Horizontal	Pass
2	1417.198	41.74	-12.43	74.0	32.26	Peak	163.10	100	Horizontal	Pass
2**	1417.198	31.40	-12.43	54.0	22.60	AV	163.10	100	Horizontal	Pass
3	2287.089	46.18	-7.42	74.0	27.82	Peak	3.80	100	Horizontal	Pass
3**	2287.089	35.74	-7.42	54.0	18.26	AV	3.80	100	Horizontal	Pass
4	2458.068	49.27	-3.90	74.0	24.73	Peak	0.00	100	Horizontal	Pass
4**	2458.068	39.67	-3.90	54.0	14.33	AV	0.00	100	Horizontal	Pass
5	4469.316	50.45	-0.71	74.0	23.55	Peak	55.00	100	Horizontal	Pass
5**	4469.316	39.89	-0.71	54.0	14.11	AV	55.00	100	Horizontal	Pass
6	6775.528	56.18	5.29	74.0	17.82	Peak	0.50	100	Horizontal	Pass
6**	6775.528	46.15	5.29	54.0	7.85	AV	0.50	100	Horizontal	Pass

TEST REPORT

Report No.: SHE23040034-02AE

Date: 2023-05-06

Page 20 of 47

Figure 10: Test plots of Field strength of harmonics, 2403MHz, 1GHz-7GHz, Vertical polarization

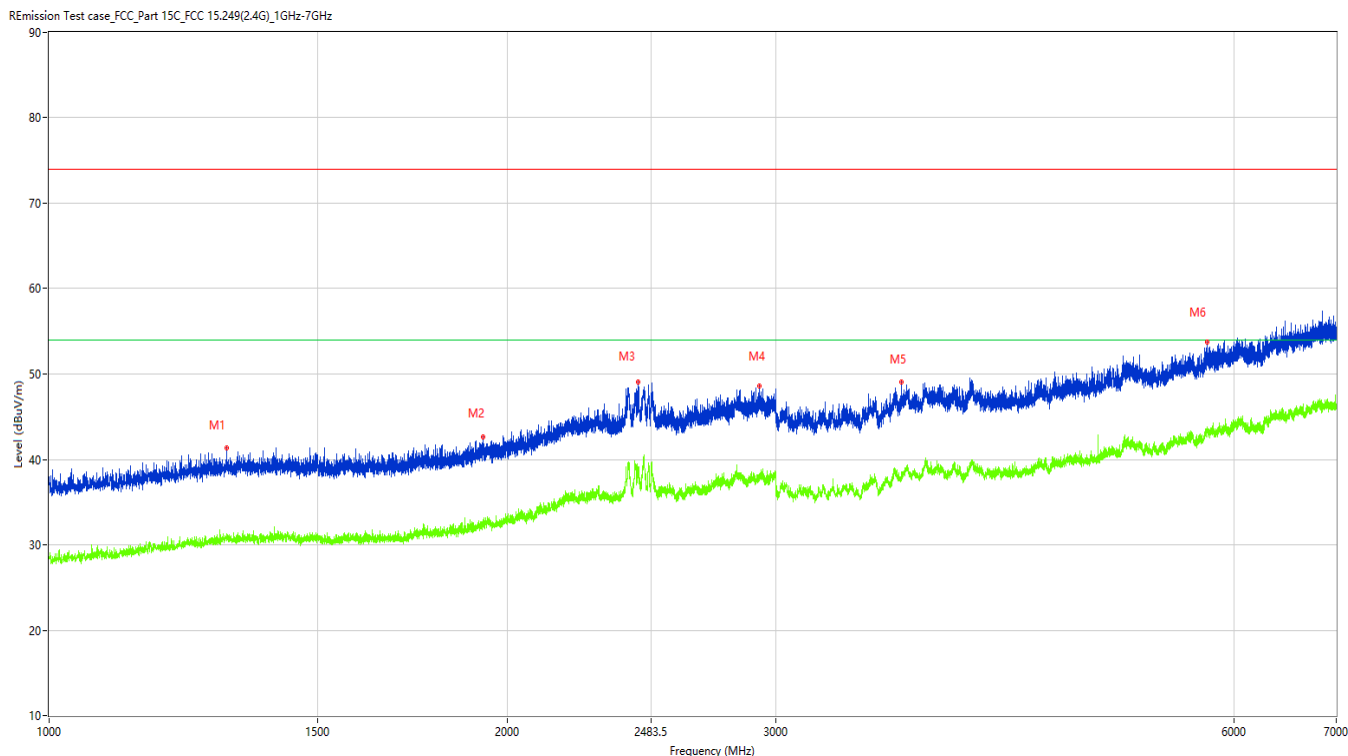

No.	Frequency (MHz)	Results (dBuV/m)	Factor (dB)	Limit (dBuV/m)	Margin (dB)	Detector	Table (Degree)	Height (cm)	Antenna	Verdict
1	1308.461	41.36	-12.39	74.0	32.64	Peak	25.00	100	Vertical	Pass
1**	1308.461	31.24	-12.39	54.0	22.76	AV	25.00	100	Vertical	Pass
2	1926.134	42.61	-11.30	74.0	31.39	Peak	281.40	100	Vertical	Pass
2**	1926.134	32.75	-11.30	54.0	21.25	AV	281.40	100	Vertical	Pass
3	2437.820	49.02	-3.94	74.0	24.98	Peak	0.00	100	Vertical	Pass
3**	2437.820	39.12	-3.94	54.0	14.88	AV	0.00	100	Vertical	Pass
4	2926.759	48.65	-3.99	74.0	25.35	Peak	31.30	100	Vertical	Pass
4**	2926.759	38.09	-3.99	54.0	15.91	AV	31.30	100	Vertical	Pass
5	3626.422	49.11	-1.69	74.0	24.89	Peak	313.30	100	Vertical	Pass
5**	3626.422	37.76	-1.69	54.0	16.24	AV	313.30	100	Vertical	Pass
6	5756.155	53.69	2.32	74.0	20.31	Peak	26.00	100	Vertical	Pass
6**	5756.155	43.73	2.32	54.0	10.27	AV	26.00	100	Vertical	Pass

TEST REPORT

Report No.: SHE23040034-02AE

Date: 2023-05-06

Page 21 of 47

Figure 11: Test plots of Field strength of harmonics, 2403MHz, 7GHz-18GHz, Horizontal polarization

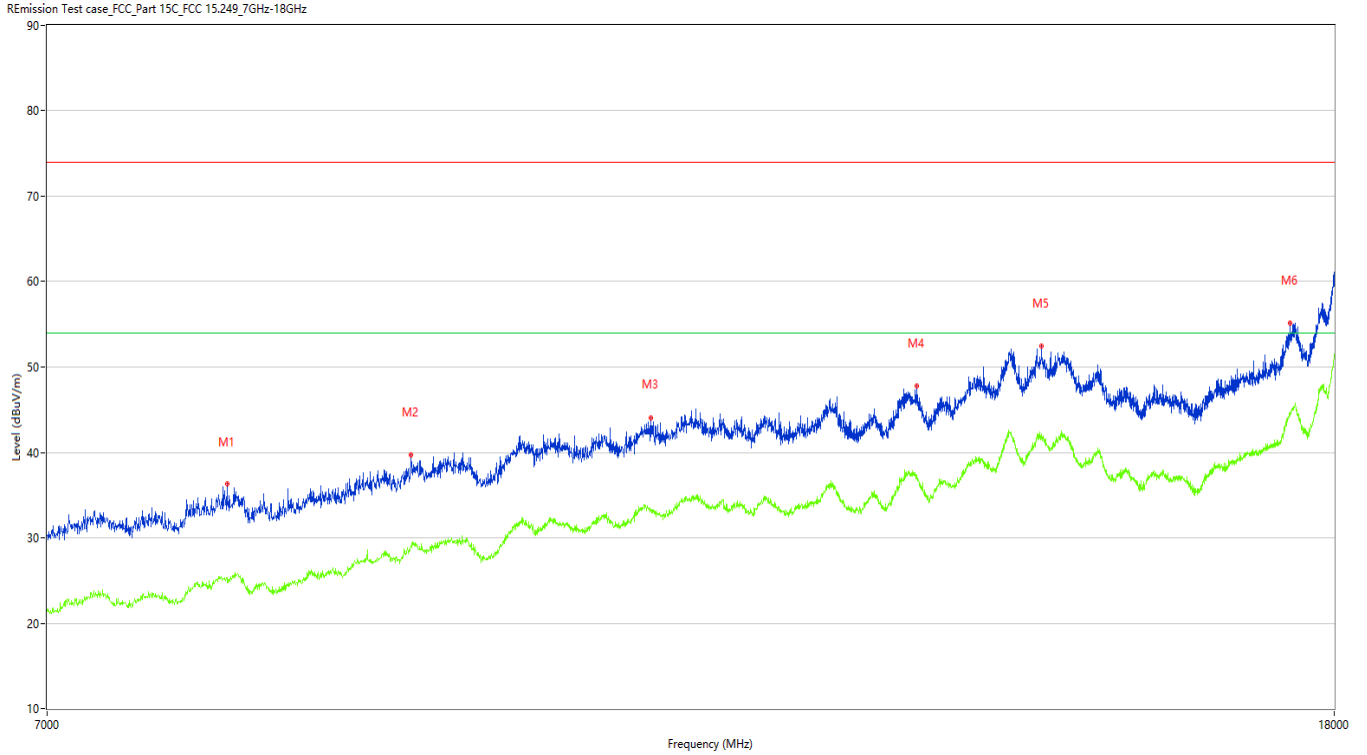

No.	Frequency (MHz)	Results (dBuV/m)	Factor (dB)	Limit (dBuV/m)	Margin (dB)	Detector	Table (Degree)	Height (cm)	Antenna	Verdict
1	7987.250	36.32	3.73	74.0	37.68	Peak	24.50	100	Horizontal	Pass
1**	7987.250	25.15	3.73	54.0	28.85	AV	24.50	100	Horizontal	Pass
2	9142.250	39.66	7.20	74.0	34.34	Peak	222.50	200	Horizontal	Pass
2**	9142.250	29.07	7.20	54.0	24.93	AV	222.50	200	Horizontal	Pass
3	10905.000	44.02	11.12	74.0	29.98	Peak	360.00	100	Horizontal	Pass
3**	10905.000	33.10	11.12	54.0	20.90	AV	360.00	100	Horizontal	Pass
4	13250.750	47.75	13.98	74.0	26.25	Peak	360.00	100	Horizontal	Pass
4**	13250.750	36.90	13.98	54.0	17.10	AV	360.00	100	Horizontal	Pass
5	14521.250	52.49	17.55	74.0	21.51	Peak	312.70	100	Horizontal	Pass
5**	14521.250	41.68	17.55	54.0	12.32	AV	312.70	100	Horizontal	Pass
6	17425.250	55.11	20.40	74.0	18.89	Peak	104.50	100	Horizontal	Pass
6**	17425.250	44.67	20.40	54.0	9.33	AV	104.50	100	Horizontal	Pass

TEST REPORT

Report No.: SHE23040034-02AE

Date: 2023-05-06

Page 22 of 47

Figure 12: Test plots of Field strength of harmonics, 2403MHz, 7GHz-18GHz, Vertical polarization

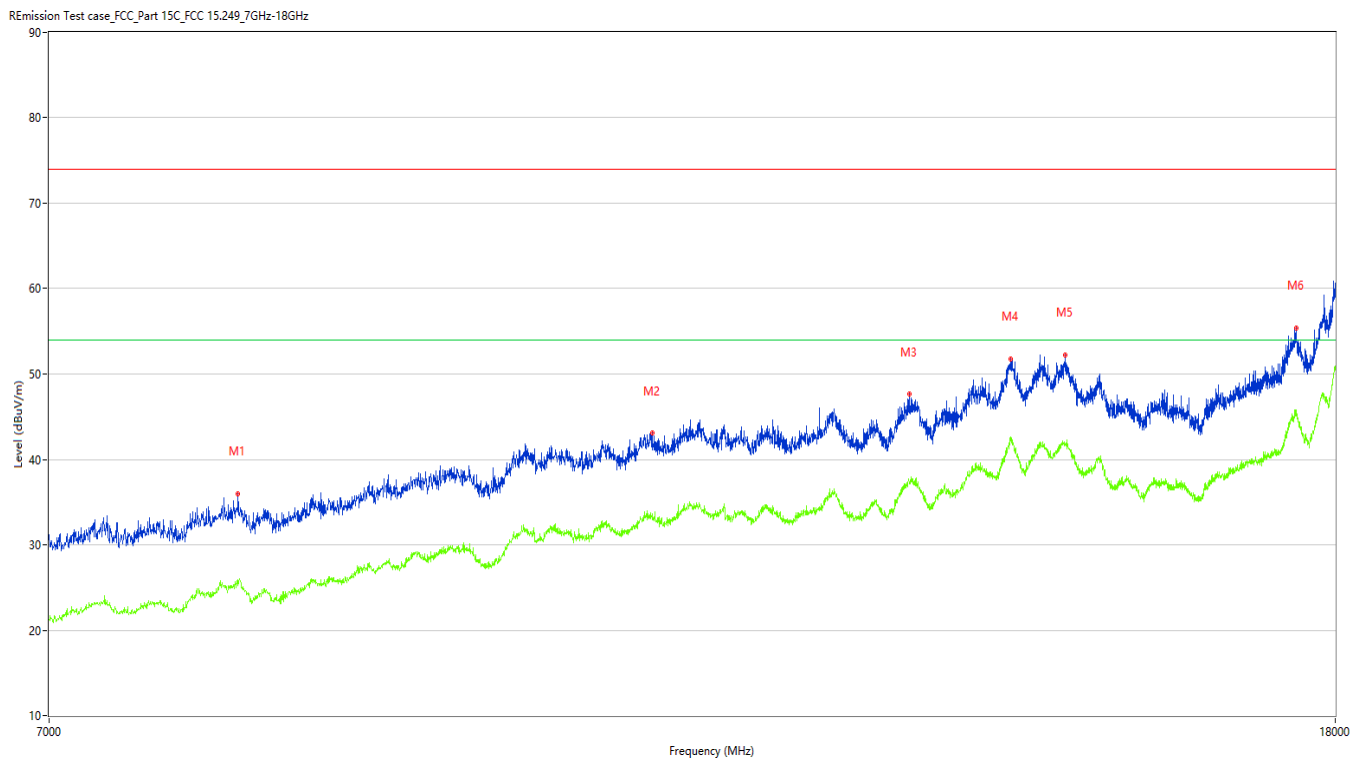

No.	Frequency (MHz)	Results (dBuV/m)	Factor (dB)	Limit (dBuV/m)	Margin (dB)	Detector	Table (Degree)	Height (cm)	Antenna	Verdict
1	8042.250	35.95	4.53	74.0	38.05	Peak	247.60	100	Vertical	Pass
1**	8042.250	25.25	4.53	54.0	28.75	AV	247.60	100	Vertical	Pass
2	10899.500	43.06	11.11	74.0	30.94	Peak	327.60	100	Vertical	Pass
2**	10899.500	33.63	11.11	54.0	20.37	AV	327.60	100	Vertical	Pass
3	13162.750	47.61	14.00	74.0	26.39	Peak	9.00	100	Vertical	Pass
3**	13162.750	37.25	14.00	54.0	16.75	AV	9.00	100	Vertical	Pass
4	14185.750	51.77	19.69	74.0	22.23	Peak	0.00	100	Vertical	Pass
4**	14185.750	42.59	19.69	54.0	11.41	AV	0.00	100	Vertical	Pass
5	14766.000	52.24	18.84	74.0	21.76	Peak	182.80	100	Vertical	Pass
5**	14766.000	41.81	18.84	54.0	12.19	AV	182.80	100	Vertical	Pass
6	17488.501	55.38	21.46	74.0	18.62	Peak	40.30	100	Vertical	Pass
6**	17488.501	45.81	21.46	54.0	8.19	AV	40.30	100	Vertical	Pass

TEST REPORT

Report No.: SHE23040034-02AE

Date: 2023-05-06

Page 23 of 47

Figure 13: Test plots of Field strength of harmonics, 2442MHz, 30MHz-1GHz, Horizontal polarization

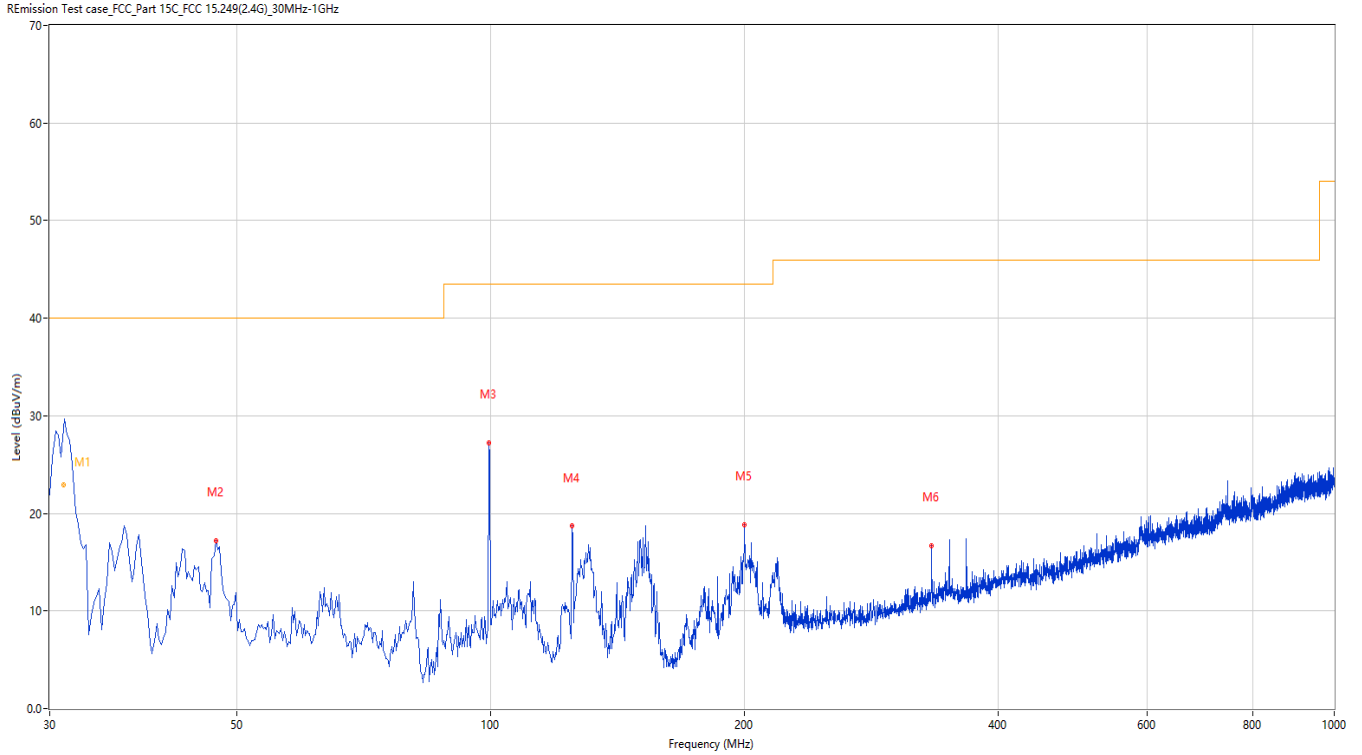

No.	Frequency (MHz)	Results (dBuV/m)	Factor (dB)	Limit (dBuV/m)	Margin (dB)	Detector	Table (Degree)	Height (cm)	Antenna	Verdict
1	31.154	32.90	-29.43	40.0	7.10	Peak	27.50	162	Horizontal	Pass
1*	31.154	22.97	-29.43	40.0	17.03	QP	27.50	162	Horizontal	Pass
2	47.213	17.16	-25.14	40.0	22.84	Peak	360.00	100	Horizontal	Pass
3	99.580	27.25	-26.68	43.5	16.25	Peak	81.60	200	Horizontal	Pass
4	124.794	18.69	-28.97	43.5	24.81	Peak	81.60	200	Horizontal	Pass
5	199.950	18.83	-26.18	43.5	24.67	Peak	214.60	200	Horizontal	Pass
6	333.049	16.73	-22.53	46.0	29.27	Peak	0.00	200	Horizontal	Pass

TEST REPORT

Report No.: SHE23040034-02AE

Date: 2023-05-06

Page 24 of 47

Figure 14: Test plots of Field strength of harmonics, 2442MHz, 30MHz-1GHz, Vertical polarization

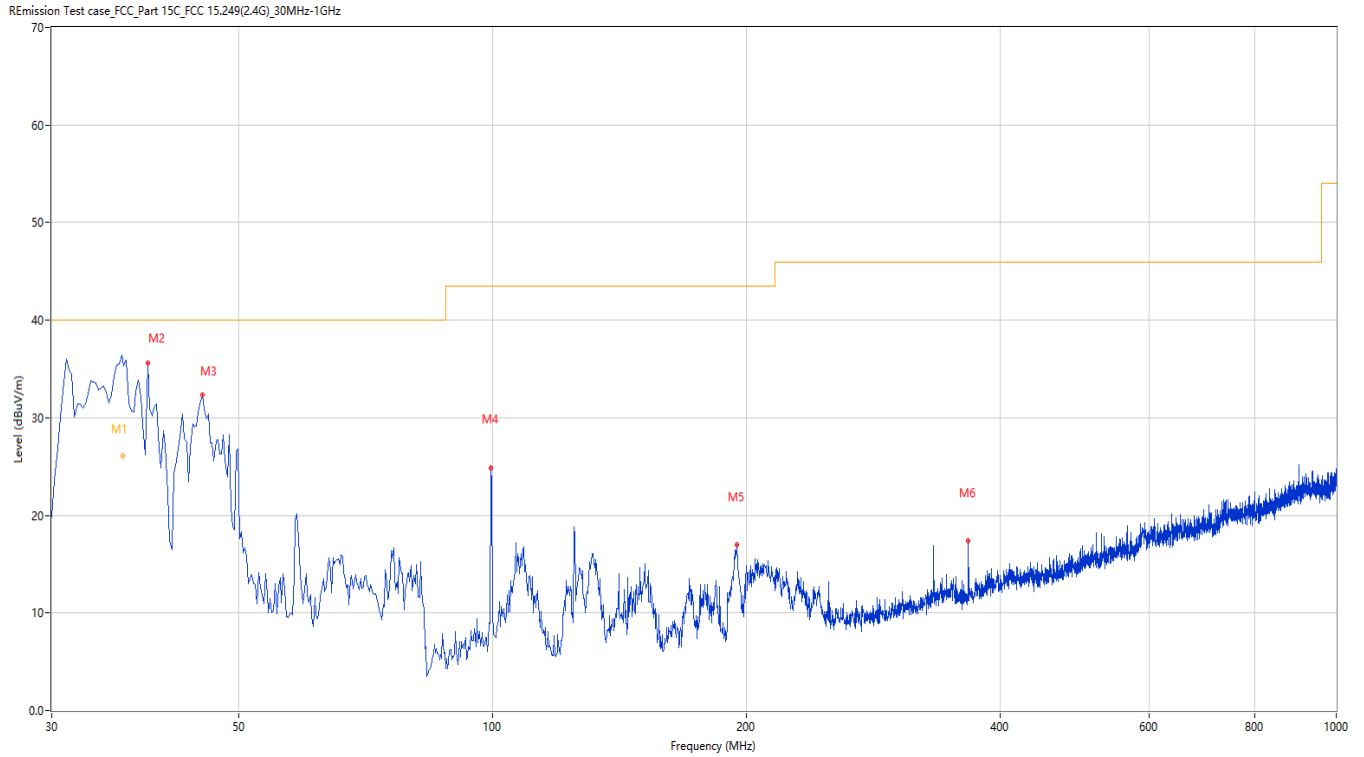

No.	Frequency (MHz)	Results (dBuV/m)	Factor (dB)	Limit (dBuV/m)	Margin (dB)	Detector	Table (Degree)	Height (cm)	Antenna	Verdict
1	36.381	35.25	-27.61	40.0	4.75	Peak	183.50	100	Vertical	Pass
1*	36.381	26.13	-27.61	40.0	13.87	QP	183.50	100	Vertical	Pass
2	38.970	35.57	-26.70	40.0	4.43	Peak	360.00	200	Vertical	Pass
3	45.274	32.36	-25.26	40.0	7.64	Peak	360.00	200	Vertical	Pass
4	99.580	24.92	-26.68	43.5	18.58	Peak	178.60	100	Vertical	Pass
5	194.616	16.95	-26.26	43.5	26.55	Peak	360.00	200	Vertical	Pass
6	366.506	17.36	-21.94	46.0	28.64	Peak	234.20	200	Vertical	Pass

TEST REPORT

Report No.: SHE23040034-02AE

Date: 2023-05-06

Page 25 of 47

Figure 15: Test plots of Field strength of harmonics, 2442MHz, 1GHz-7GHz, Horizontal polarization

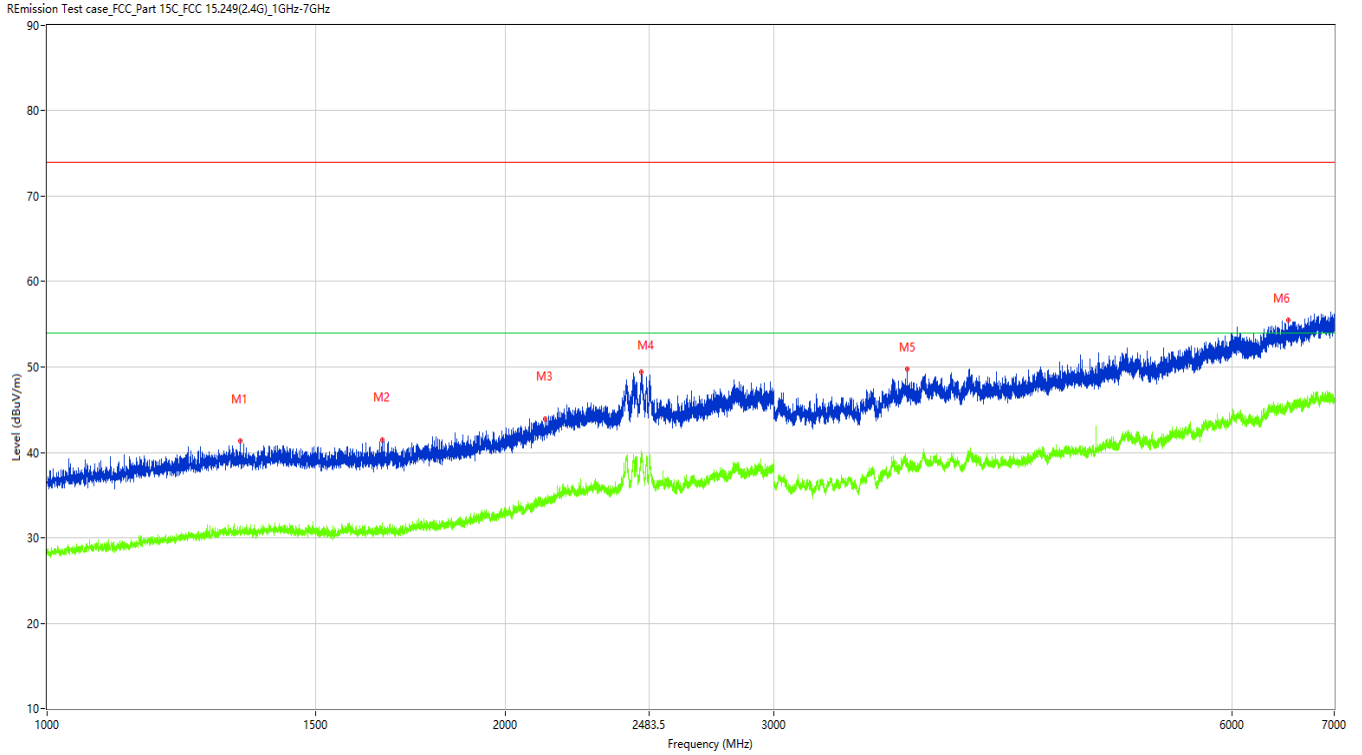

No.	Frequency (MHz)	Results (dBuV/m)	Factor (dB)	Limit (dBuV/m)	Margin (dB)	Detector	Table (Degree)	Height (cm)	Antenna	Verdict
1	1339.708	41.31	-12.49	74.0	32.69	Peak	350.30	100	Horizontal	Pass
1**	1339.708	31.05	-12.49	54.0	22.95	AV	350.30	100	Horizontal	Pass
2	1658.918	41.50	-12.73	74.0	32.50	Peak	301.90	100	Horizontal	Pass
2**	1658.918	31.72	-12.73	54.0	22.28	AV	301.90	100	Horizontal	Pass
3	2124.609	43.92	-8.84	74.0	30.08	Peak	63.00	100	Horizontal	Pass
3**	2124.609	34.22	-8.84	54.0	19.78	AV	63.00	100	Horizontal	Pass
4	2455.568	49.45	-3.92	74.0	24.55	Peak	197.30	100	Horizontal	Pass
4**	2455.568	39.49	-3.92	54.0	14.51	AV	197.30	100	Horizontal	Pass
5	3670.416	49.80	-1.43	74.0	24.20	Peak	20.80	100	Horizontal	Pass
5**	3670.416	39.32	-1.43	54.0	14.68	AV	20.80	100	Horizontal	Pass
6	6534.058	55.55	4.20	74.0	18.45	Peak	18.20	100	Horizontal	Pass
6**	6534.058	45.39	4.20	54.0	8.61	AV	18.20	100	Horizontal	Pass

TEST REPORT

Report No.: SHE23040034-02AE

Date: 2023-05-06

Page 26 of 47

Figure 16: Test plots of Field strength of harmonics, 2442MHz, 1GHz-7GHz, Vertical polarization

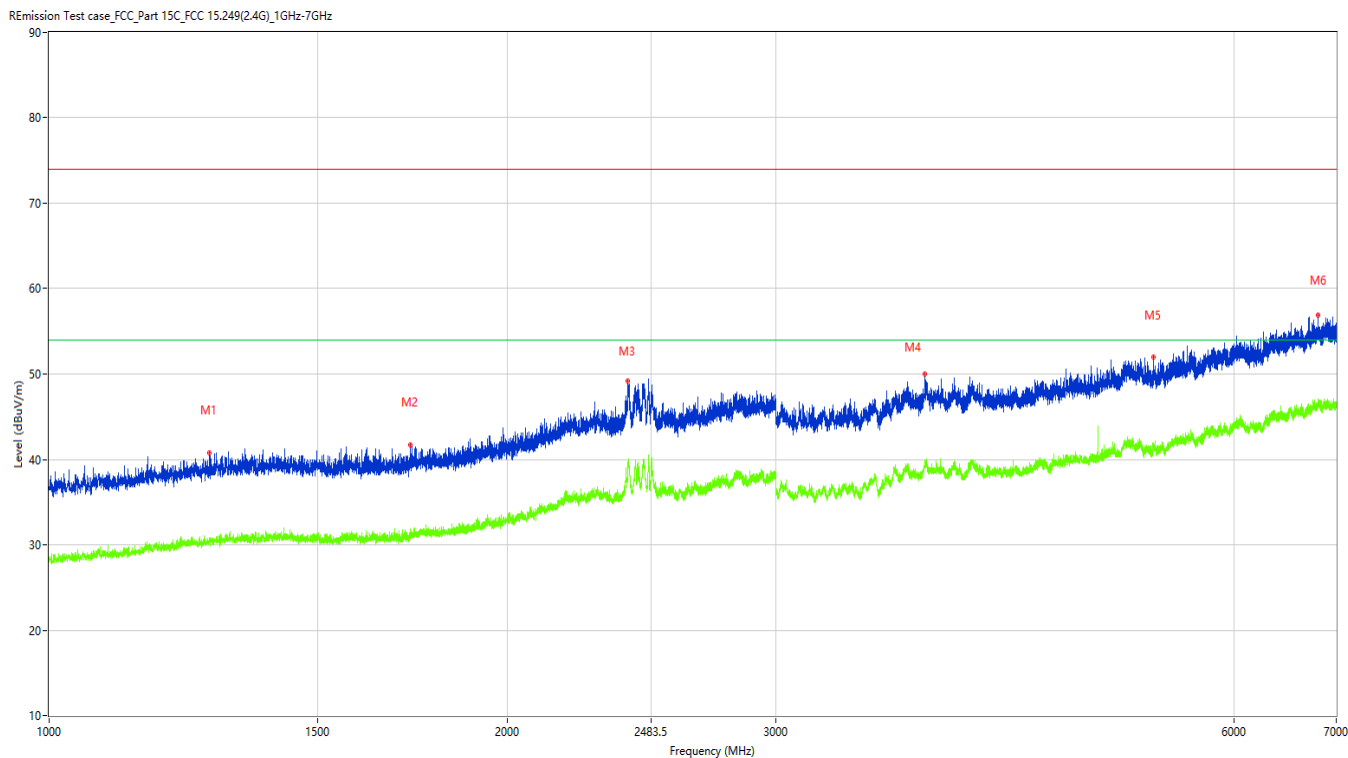

No.	Frequency (MHz)	Results (dBuV/m)	Factor (dB)	Limit (dBuV/m)	Margin (dB)	Detector	Table (Degree)	Height (cm)	Antenna	Verdict
1	1273.716	40.81	-12.67	74.0	33.19	Peak	359.30	100	Vertical	Pass
1**	1273.716	30.22	-12.67	54.0	23.78	AV	359.30	100	Vertical	Pass
2	1726.909	41.71	-12.31	74.0	32.29	Peak	102.60	100	Vertical	Pass
2**	1726.909	30.70	-12.31	54.0	23.30	AV	102.60	100	Vertical	Pass
3	2399.075	49.13	-3.99	74.0	24.87	Peak	220.90	100	Vertical	Pass
3**	2399.075	39.16	-3.99	54.0	14.84	AV	220.90	100	Vertical	Pass
4	3759.405	49.97	-1.16	74.0	24.03	Peak	130.90	100	Vertical	Pass
4**	3759.405	39.27	-1.16	54.0	14.73	AV	130.90	100	Vertical	Pass
5	5311.211	51.93	0.81	74.0	22.07	Peak	65.40	100	Vertical	Pass
5**	5311.211	41.61	0.81	54.0	12.39	AV	65.40	100	Vertical	Pass
6	6813.023	56.86	5.46	74.0	17.14	Peak	30.80	100	Vertical	Pass
6**	6813.023	47.06	5.46	54.0	6.94	AV	30.80	100	Vertical	Pass

TEST REPORT

Report No.: SHE23040034-02AE

Date: 2023-05-06

Page 27 of 47

Figure 17: Test plots of Field strength of harmonics, 2442MHz, 7GHz-18GHz, Horizontal polarization

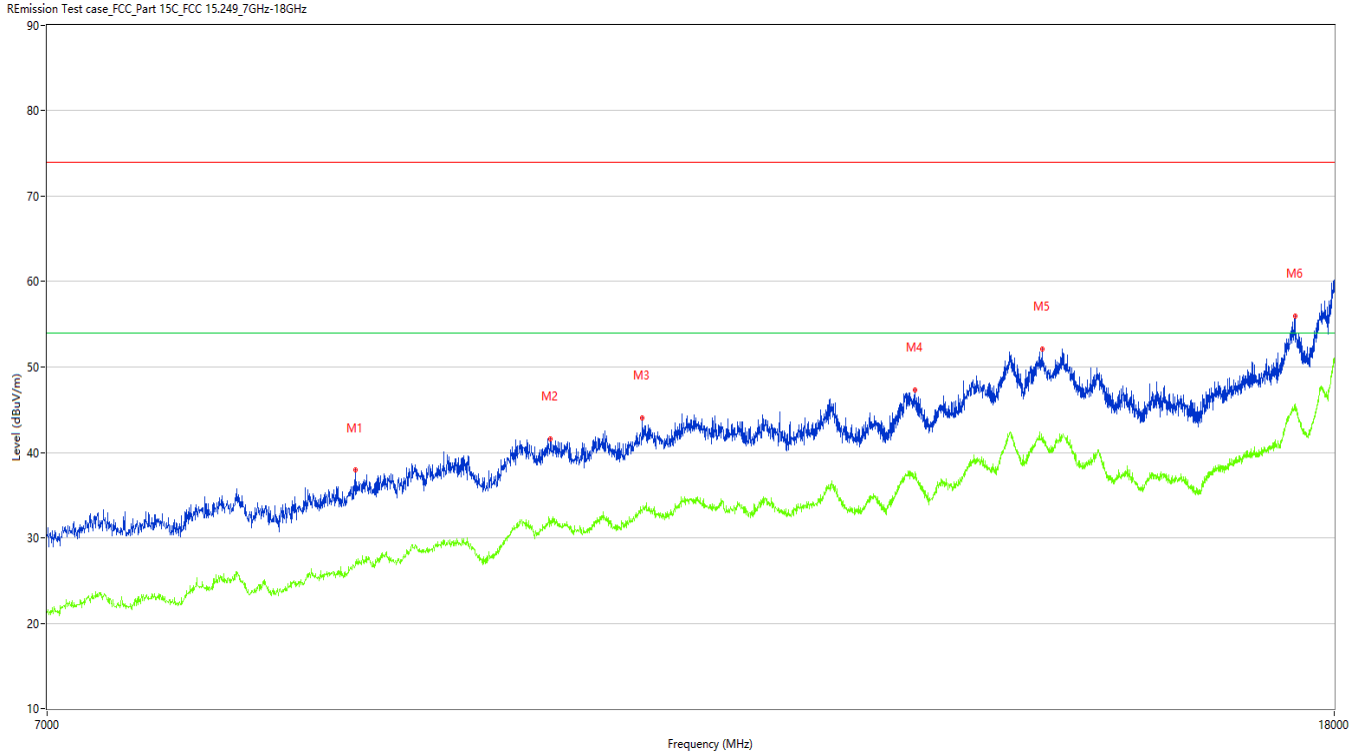

No.	Frequency (MHz)	Results (dBuV/m)	Factor (dB)	Limit (dBuV/m)	Margin (dB)	Detector	Table (Degree)	Height (cm)	Antenna	Verdict
1	8779.250	37.92	4.89	74.0	36.08	Peak	356.90	100	Horizontal	Pass
1**	8779.250	27.15	4.89	54.0	26.85	AV	356.90	100	Horizontal	Pass
2	10129.500	41.61	9.41	74.0	32.39	Peak	195.00	100	Horizontal	Pass
2**	10129.500	31.85	9.41	54.0	22.15	AV	195.00	100	Horizontal	Pass
3	10833.500	44.04	10.95	74.0	29.96	Peak	178.90	100	Horizontal	Pass
3**	10833.500	33.09	10.95	54.0	20.91	AV	178.90	100	Horizontal	Pass
4	13231.500	47.35	14.19	74.0	26.65	Peak	31.20	100	Horizontal	Pass
4**	13231.500	37.05	14.19	54.0	16.95	AV	31.20	100	Horizontal	Pass
5	14526.750	52.10	17.51	74.0	21.90	Peak	64.70	100	Horizontal	Pass
5**	14526.750	41.71	17.51	54.0	12.29	AV	64.70	100	Horizontal	Pass
6	17494.000	55.99	21.33	74.0	18.01	Peak	243.70	100	Horizontal	Pass
6**	17494.000	45.28	21.33	54.0	8.72	AV	243.70	100	Horizontal	Pass

TEST REPORT

Report No.: SHE23040034-02AE

Date: 2023-05-06

Page 28 of 47

Figure 18: Test plots of Field strength of harmonics, 2442MHz, 7GHz-18GHz, Vertical polarization

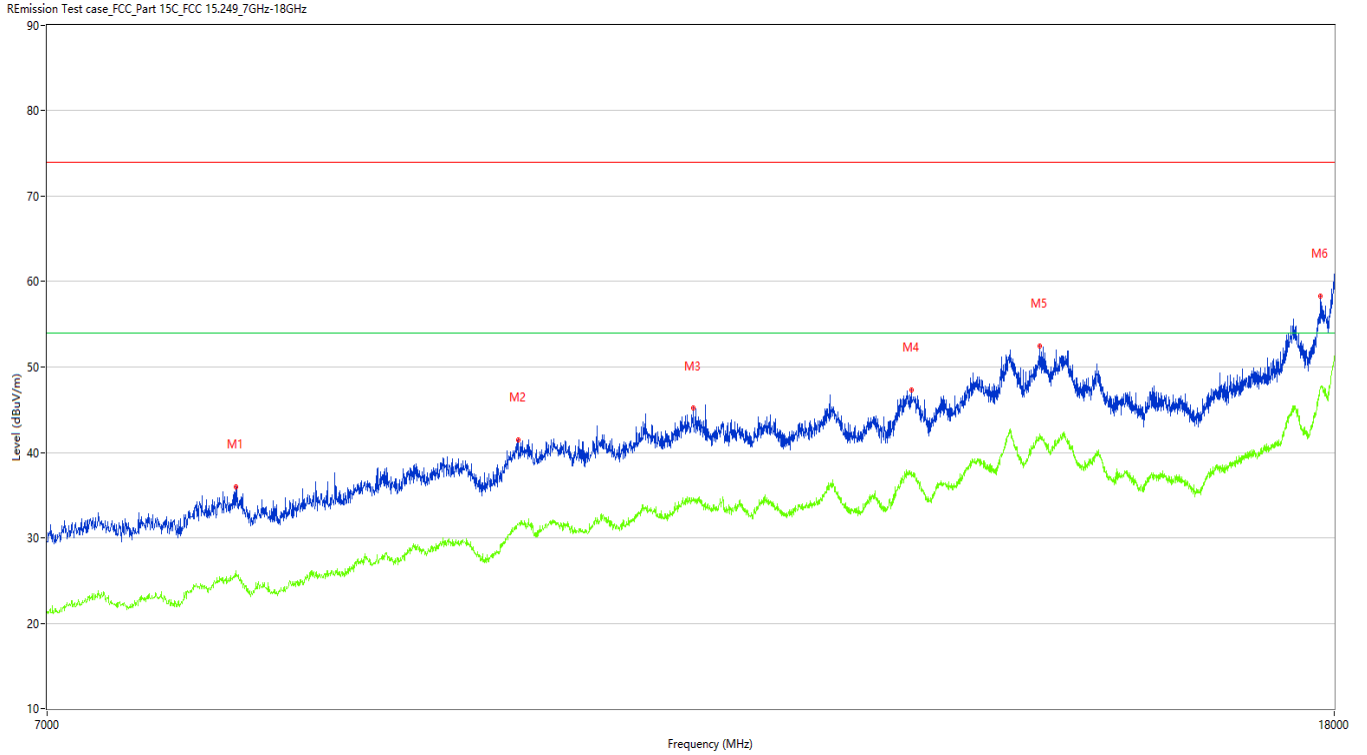

No.	Frequency (MHz)	Results (dBuV/m)	Factor (dB)	Limit (dBuV/m)	Margin (dB)	Detector	Table (Degree)	Height (cm)	Antenna	Verdict
1	8039.500	35.98	4.48	74.0	38.02	Peak	269.60	100	Vertical	Pass
1**	8039.500	26.12	4.48	54.0	27.88	AV	269.60	100	Vertical	Pass
2	9890.250	41.52	9.54	74.0	32.48	Peak	255.40	100	Vertical	Pass
2**	9890.250	31.55	9.54	54.0	22.45	AV	255.40	100	Vertical	Pass
3	11246.000	45.15	11.84	74.0	28.85	Peak	15.00	100	Vertical	Pass
3**	11246.000	34.38	11.84	54.0	19.62	AV	15.00	100	Vertical	Pass
4	13198.500	47.30	14.08	74.0	26.70	Peak	63.80	100	Vertical	Pass
4**	13198.500	37.33	14.08	54.0	16.67	AV	63.80	100	Vertical	Pass
5	14504.750	52.51	17.67	74.0	21.49	Peak	2.50	100	Vertical	Pass
5**	14504.750	42.16	17.67	54.0	11.84	AV	2.50	100	Vertical	Pass
6	17821.250	58.31	22.19	74.0	15.69	Peak	221.90	100	Vertical	Pass
6**	17821.250	47.64	22.19	54.0	6.36	AV	221.90	100	Vertical	Pass

TEST REPORT

Report No.: SHE23040034-02AE

Date: 2023-05-06

Page 29 of 47

Figure 19: Test plots of Field strength of harmonics, 2480MHz, 30MHz-1GHz, Horizontal polarization

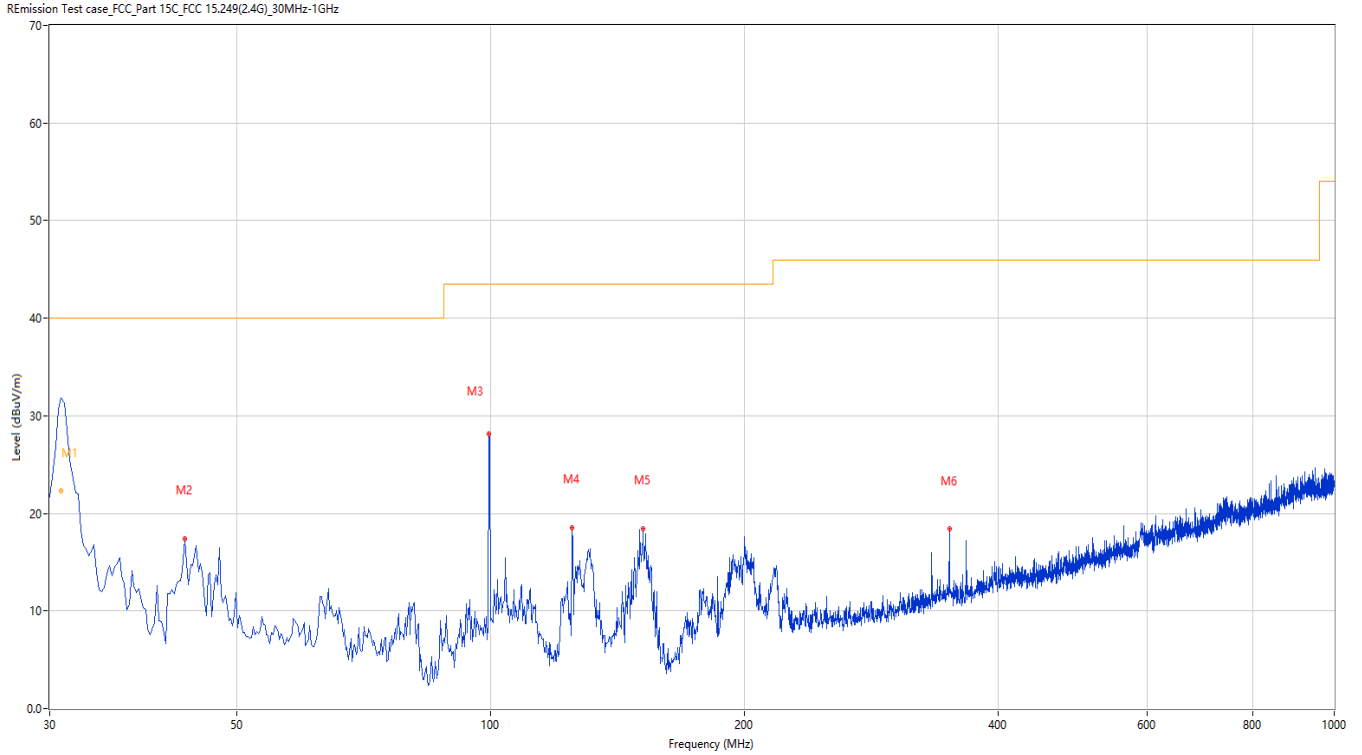

No.	Frequency (MHz)	Results (dBuV/m)	Factor (dB)	Limit (dBuV/m)	Margin (dB)	Detector	Table (Degree)	Height (cm)	Antenna	Verdict
1	30.962	32.32	-29.51	40.0	7.68	Peak	360.00	146	Horizontal	Pass
1*	30.962	22.35	-29.51	40.0	17.65	QP	360.00	146	Horizontal	Pass
2	43.334	17.37	-25.44	40.0	22.63	Peak	147.70	100	Horizontal	Pass
3	99.580	28.09	-26.68	43.5	15.41	Peak	81.70	200	Horizontal	Pass
4	124.794	18.55	-28.97	43.5	24.95	Peak	61.60	200	Horizontal	Pass
5	151.705	18.40	-29.88	43.5	25.10	Peak	238.00	200	Horizontal	Pass
6	349.778	18.38	-21.67	46.0	27.62	Peak	360.00	200	Horizontal	Pass

TEST REPORT

Report No.: SHE23040034-02AE

Date: 2023-05-06

Page 30 of 47

Figure 20: Test plots of Field strength of harmonics, 2480MHz, 30MHz-1GHz, Vertical polarization

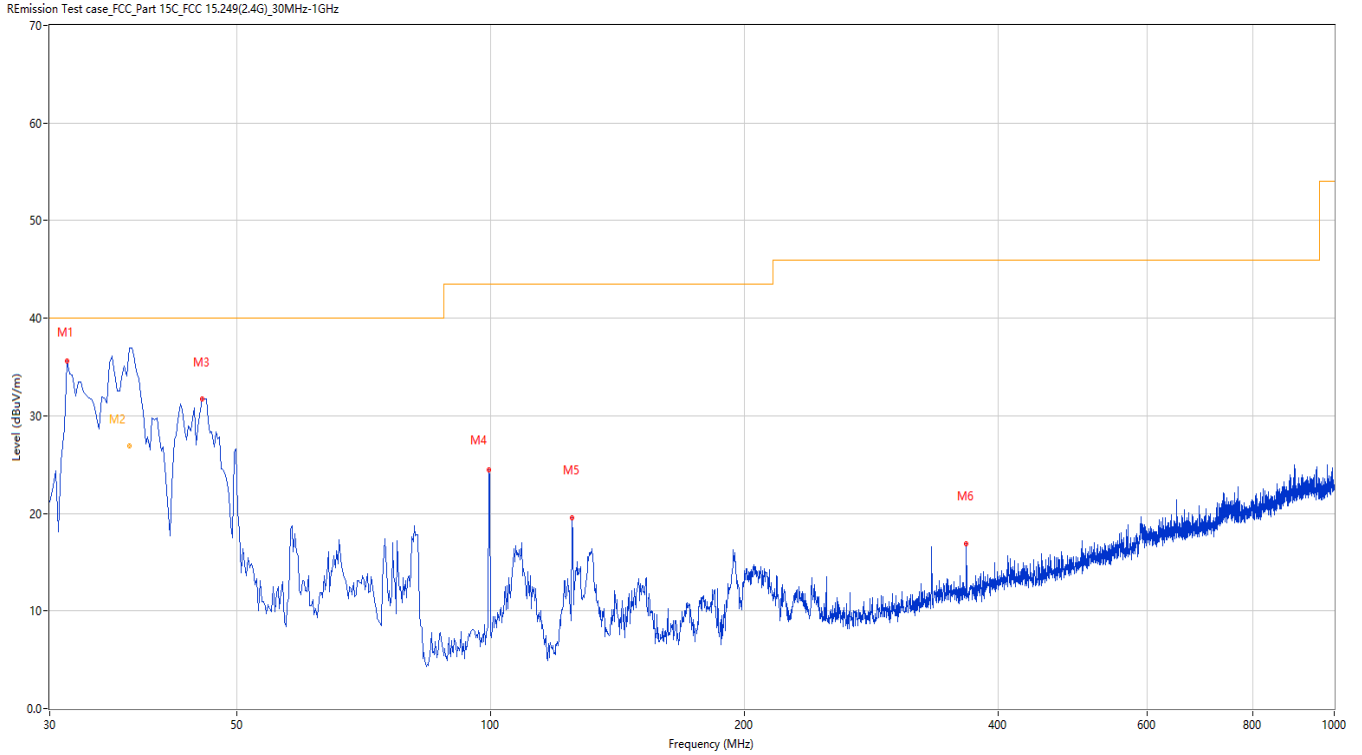

No.	Frequency (MHz)	Results (dBuV/m)	Factor (dB)	Limit (dBuV/m)	Margin (dB)	Detector	Table (Degree)	Height (cm)	Antenna	Verdict
1	31.455	35.57	-29.34	40.0	4.43	Peak	0.00	200	Vertical	Pass
2	37.310	36.42	-27.18	40.0	3.58	Peak	0.00	101	Vertical	Pass
2*	37.310	26.88	-27.18	40.0	13.12	QP	0.00	101	Vertical	Pass
3	45.516	31.77	-25.24	40.0	8.23	Peak	46.20	100	Vertical	Pass
4	99.580	24.48	-26.68	43.5	19.02	Peak	187.70	100	Vertical	Pass
5	124.794	19.51	-28.97	43.5	23.99	Peak	276.30	100	Vertical	Pass
6	366.506	16.85	-21.94	46.0	29.15	Peak	64.20	200	Vertical	Pass

TEST REPORT

Report No.: SHE23040034-02AE

Date: 2023-05-06

Page 31 of 47

Figure 21: Test plots of Field strength of harmonics, 2480MHz, 1GHz-7GHz, Horizontal polarization

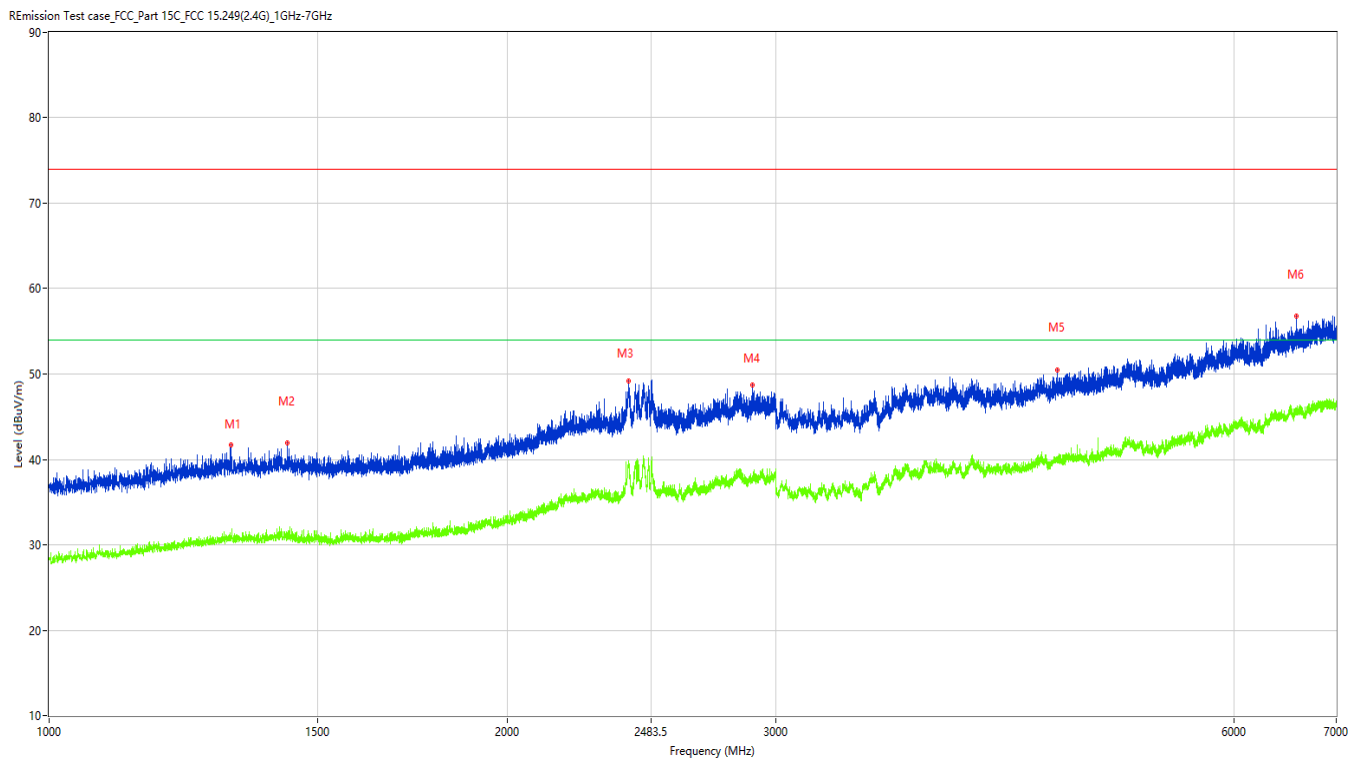

No.	Frequency (MHz)	Results (dBuV/m)	Factor (dB)	Limit (dBuV/m)	Margin (dB)	Detector	Table (Degree)	Height (cm)	Antenna	Verdict
1	1315.711	41.68	-12.56	74.0	32.32	Peak	291.10	100	Horizontal	Pass
1**	1315.711	30.83	-12.56	54.0	23.17	AV	291.10	100	Horizontal	Pass
2	1433.946	41.88	-12.38	74.0	32.12	Peak	133.30	100	Horizontal	Pass
2**	1433.946	31.18	-12.38	54.0	22.82	AV	133.30	100	Horizontal	Pass
3	2401.825	49.14	-4.01	74.0	24.86	Peak	220.40	100	Horizontal	Pass
3**	2401.825	39.81	-4.01	54.0	14.19	AV	220.40	100	Horizontal	Pass
4	2897.013	48.70	-3.74	74.0	25.30	Peak	23.50	100	Horizontal	Pass
4**	2897.013	37.61	-3.74	54.0	16.39	AV	23.50	100	Horizontal	Pass
5	4593.301	50.50	-0.43	74.0	23.50	Peak	219.10	100	Horizontal	Pass
5**	4593.301	39.90	-0.43	54.0	14.10	AV	219.10	100	Horizontal	Pass
6	6589.551	56.73	4.46	74.0	17.27	Peak	0.40	100	Horizontal	Pass
6**	6589.551	45.69	4.46	54.0	8.31	AV	0.40	100	Horizontal	Pass

TEST REPORT

Report No.: SHE23040034-02AE

Date: 2023-05-06

Page 32 of 47

Figure 22: Test plots of Field strength of harmonics, 2480MHz, 1GHz-7GHz, Vertical polarization

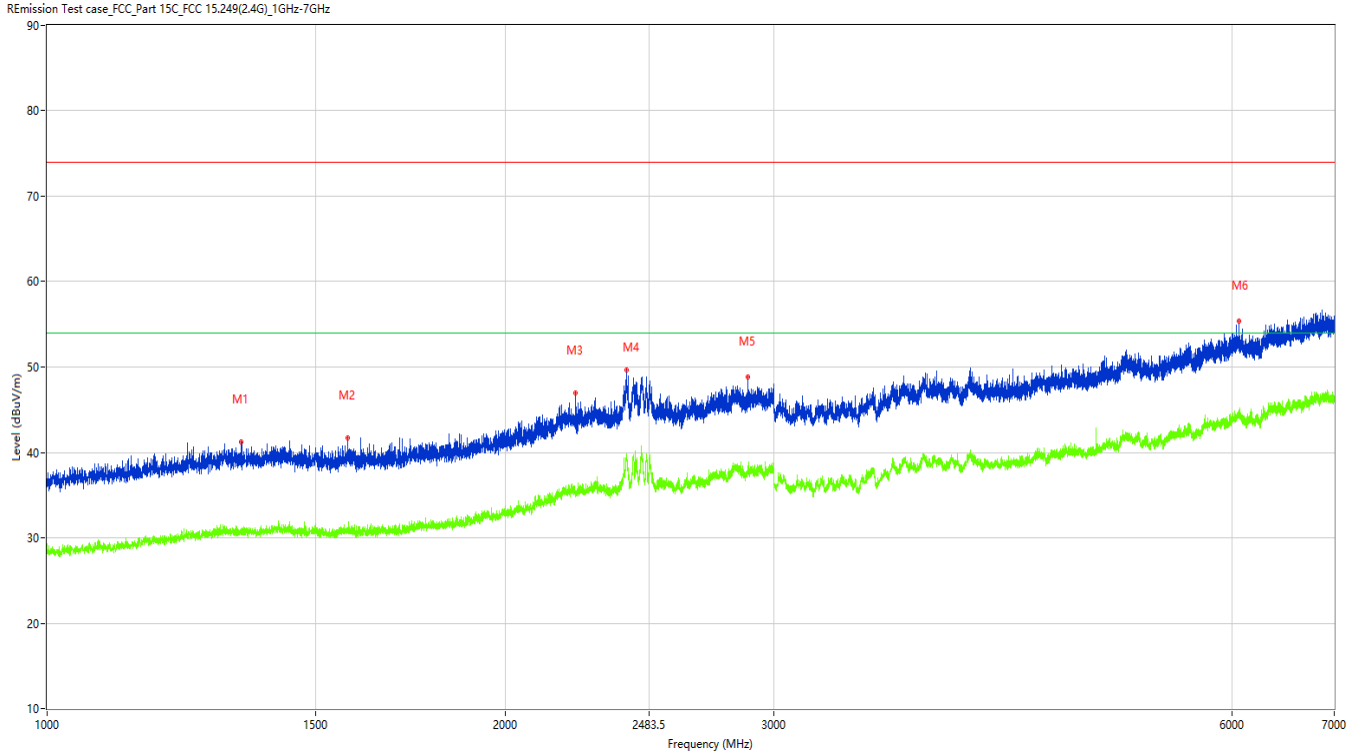

No.	Frequency (MHz)	Results (dBuV/m)	Factor (dB)	Limit (dBuV/m)	Margin (dB)	Detector	Table (Degree)	Height (cm)	Antenna	Verdict
1	1341.457	41.20	-12.49	74.0	32.80	Peak	353.80	100	Vertical	Pass
1**	1341.457	30.61	-12.49	54.0	23.39	AV	353.80	100	Vertical	Pass
2	1575.178	41.71	-12.71	74.0	32.29	Peak	353.80	100	Vertical	Pass
2**	1575.178	31.11	-12.71	54.0	22.89	AV	353.80	100	Vertical	Pass
3	2224.097	46.95	-7.72	74.0	27.05	Peak	132.90	100	Vertical	Pass
3**	2224.097	35.52	-7.72	54.0	18.48	AV	132.90	100	Vertical	Pass
4	2400.575	49.70	-4.01	74.0	24.30	Peak	356.90	100	Vertical	Pass
4**	2400.575	39.34	-4.01	54.0	14.66	AV	356.90	100	Vertical	Pass
5	2886.264	48.87	-3.73	74.0	25.13	Peak	204.00	100	Vertical	Pass
5**	2886.264	38.38	-3.73	54.0	15.62	AV	204.00	100	Vertical	Pass
6	6062.117	55.39	3.02	74.0	18.61	Peak	306.90	100	Vertical	Pass
6**	6062.117	44.64	3.02	54.0	9.36	AV	306.90	100	Vertical	Pass

TEST REPORT

Report No.: SHE23040034-02AE

Date: 2023-05-06

Page 33 of 47

Figure 23: Test plots of Field strength of harmonics, 2480MHz, 7GHz-18GHz, Horizontal polarization

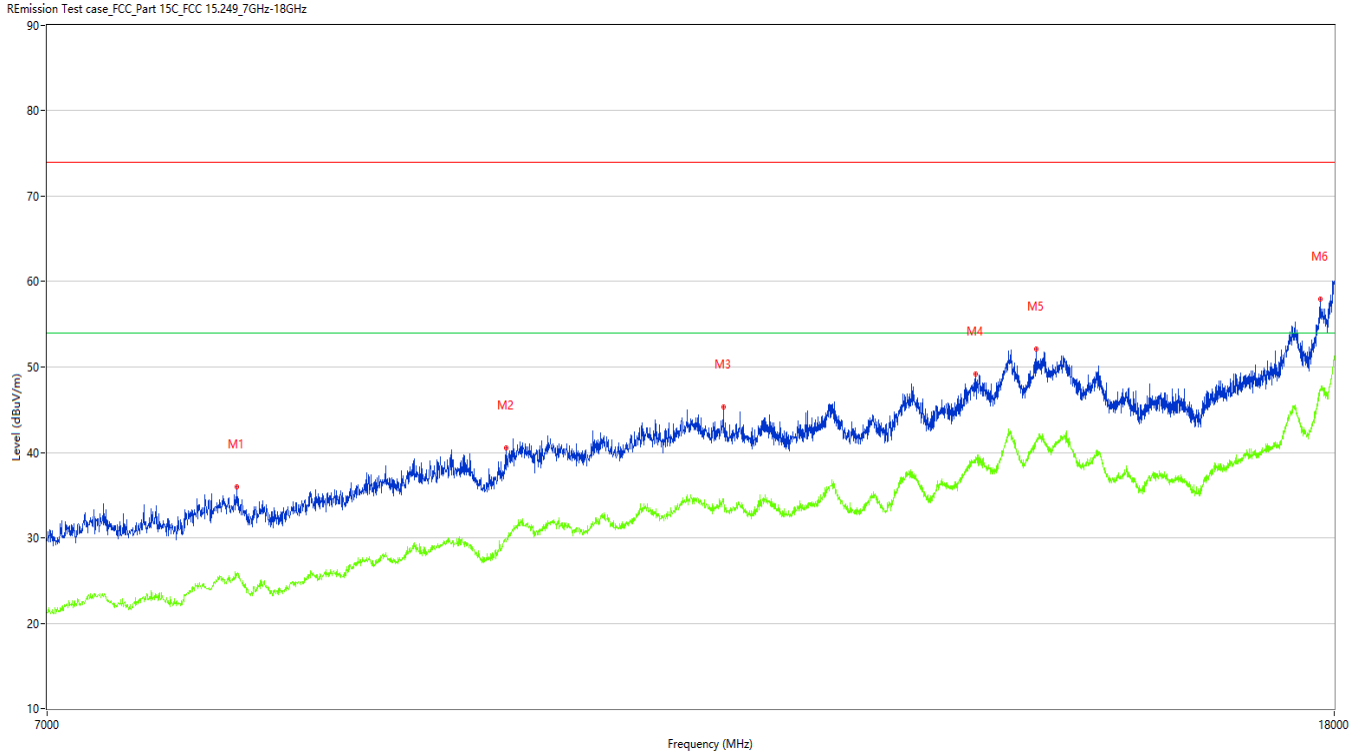

No.	Frequency (MHz)	Results (dBuV/m)	Factor (dB)	Limit (dBuV/m)	Margin (dB)	Detector	Table (Degree)	Height (cm)	Antenna	Verdict
1	8047.750	35.93	4.55	74.0	38.07	Peak	193.40	100	Horizontal	Pass
1**	8047.750	25.61	4.55	54.0	28.39	AV	193.40	100	Horizontal	Pass
2	9802.250	40.58	8.27	74.0	33.42	Peak	48.10	100	Horizontal	Pass
2**	9802.250	29.68	8.27	54.0	24.32	AV	48.10	100	Horizontal	Pass
3	11499.000	45.30	11.93	74.0	28.70	Peak	48.10	100	Horizontal	Pass
3**	11499.000	34.33	11.93	54.0	19.67	AV	48.10	100	Horizontal	Pass
4	13833.750	49.17	15.13	74.0	24.83	Peak	16.50	100	Horizontal	Pass
4**	13833.750	39.23	15.13	54.0	14.77	AV	16.50	100	Horizontal	Pass
5	14460.750	52.12	17.72	74.0	21.88	Peak	360.00	100	Horizontal	Pass
5**	14460.750	41.34	17.72	54.0	12.66	AV	360.00	100	Horizontal	Pass
6	17821.250	57.90	22.19	74.0	16.10	Peak	209.40	100	Horizontal	Pass
6**	17821.250	47.46	22.19	54.0	6.54	AV	209.40	100	Horizontal	Pass

TEST REPORT

Report No.: SHE23040034-02AE

Date: 2023-05-06

Page 34 of 47

Figure 24: Test plots of Field strength of harmonics, 2480MHz, 7GHz-18GHz, Vertical polarization

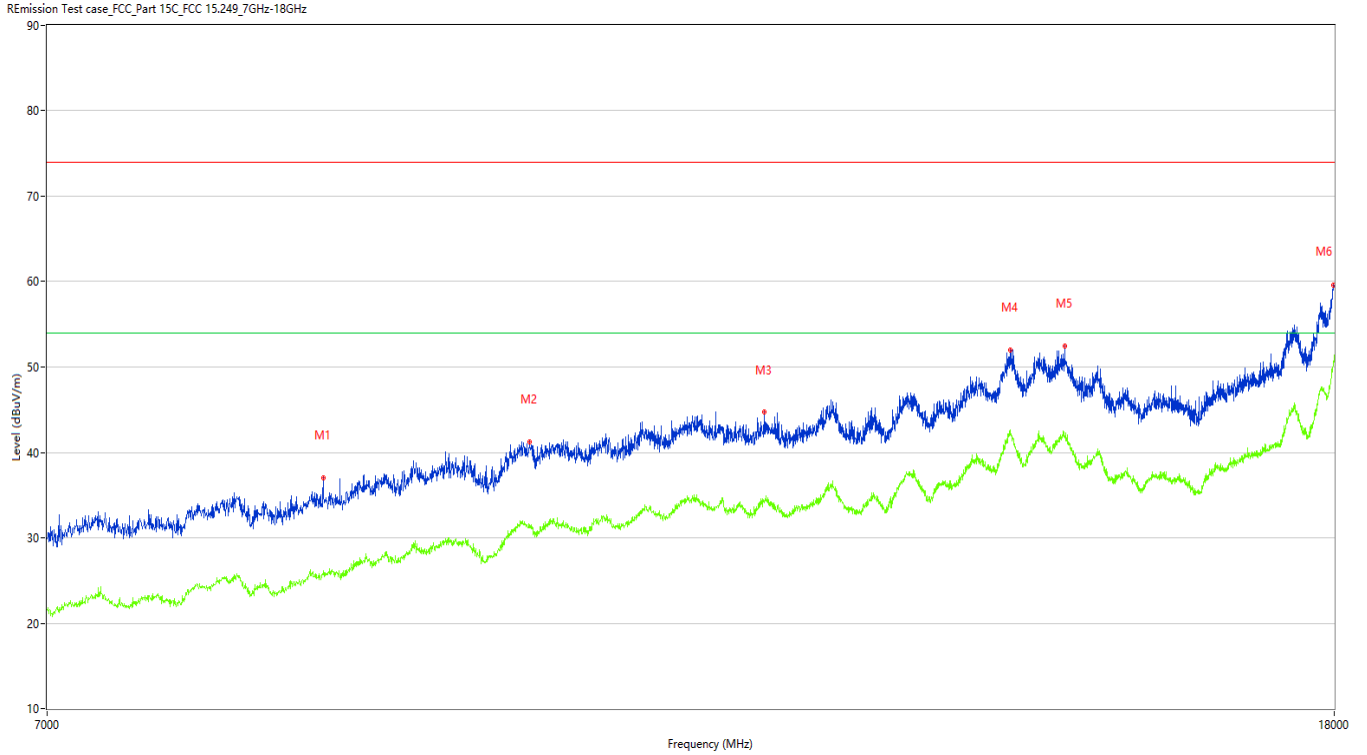

No.	Frequency (MHz)	Results (dBuV/m)	Factor (dB)	Limit (dBuV/m)	Margin (dB)	Detector	Table (Degree)	Height (cm)	Antenna	Verdict
1	8573.000	36.99	4.14	74.0	37.01	Peak	147.50	100	Vertical	Pass
1**	8573.000	25.67	4.14	54.0	28.33	AV	147.50	100	Vertical	Pass
2	9972.750	41.28	9.48	74.0	32.72	Peak	147.50	100	Vertical	Pass
2**	9972.750	31.22	9.48	54.0	22.78	AV	147.50	100	Vertical	Pass
3	11851.000	44.70	11.86	74.0	29.30	Peak	312.30	100	Vertical	Pass
3**	11851.000	34.27	11.86	54.0	19.73	AV	312.30	100	Vertical	Pass
4	14191.250	52.01	19.69	74.0	21.99	Peak	131.90	100	Vertical	Pass
4**	14191.250	42.38	19.69	54.0	11.62	AV	131.90	100	Vertical	Pass
5	14771.500	52.45	18.75	74.0	21.55	Peak	277.40	100	Vertical	Pass
5**	14771.500	41.73	18.75	54.0	12.27	AV	277.40	100	Vertical	Pass
6	17991.750	59.61	27.41	74.0	14.39	Peak	4.30	100	Vertical	Pass
6**	17991.750	50.54	27.41	54.0	3.46	AV	4.30	100	Vertical	Pass

TEST REPORT

Report No.: SHE23040034-02AE

Date: 2023-05-06

Page 35 of 47

4.1.3 Band Edge

RESULT:

PASS

Test standard : FCC Part 15.249(d), 15.209
RSS-210 B.10(b), RSS-GEN 8.10

Requirement : ANSI C63.10-2013

Kind of test site : 3m Semi-Anechoic Chamber

Test setup

Test Channel : Low/High

Operation Mode : A.i/iii

Ambient temperature : 23.4°C

Relative humidity : 50%

Figure 25: Test plots of Band Edge, 2403MHz, Horizontal polarization

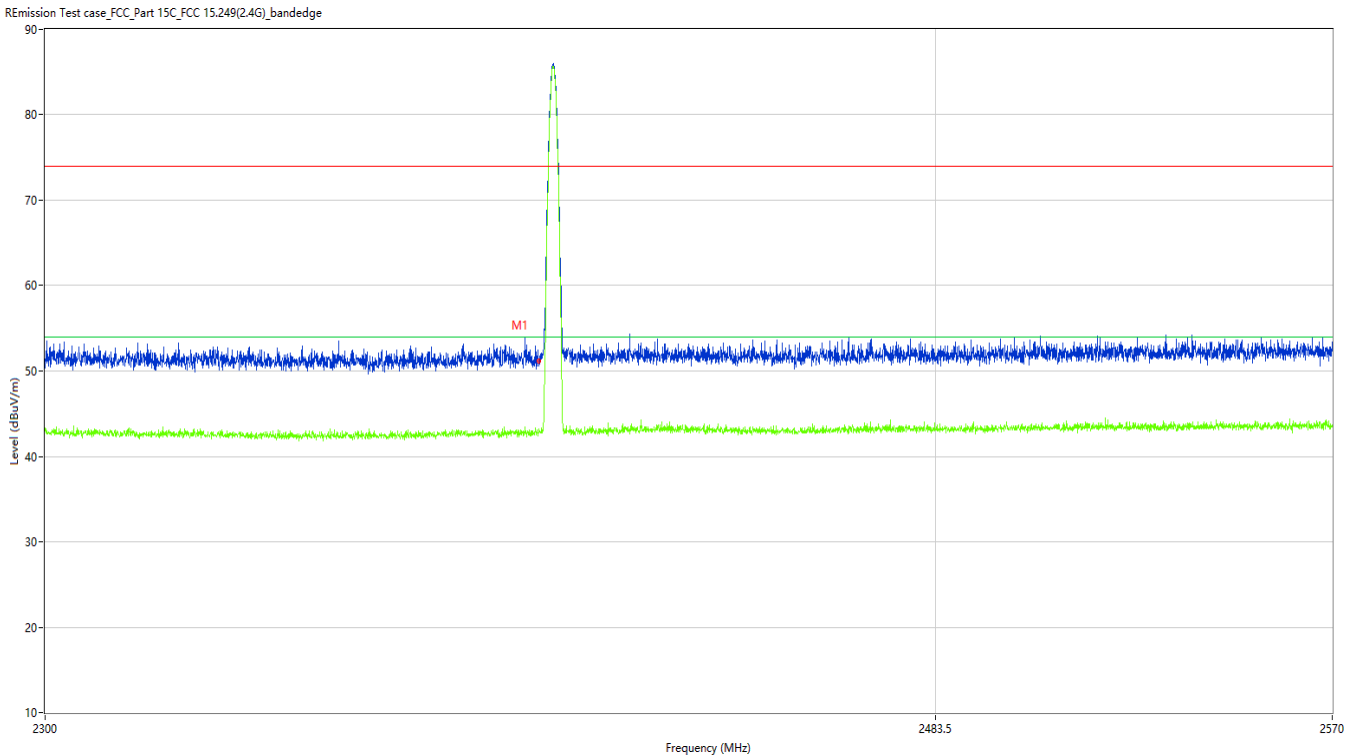

No.	Frequency (MHz)	Results (dBuV/m)	Factor (dB)	Limit (dBuV/m)	Margin (dB)	Detector	Table (Degree)	Height (cm)	Antenna	Verdict
1	2400.000	51.13	-9.87	74.0	22.87	Peak	135.41	100	Horizontal	Pass
1**	2400.000	42.78	-9.87	54.0	11.22	AV	135.41	100	Horizontal	Pass

TEST REPORT

Report No.: SHE23040034-02AE

Date: 2023-05-06

Page 36 of 47

Figure 26: Test plots of Band Edge, 2403MHz, Vertical polarization

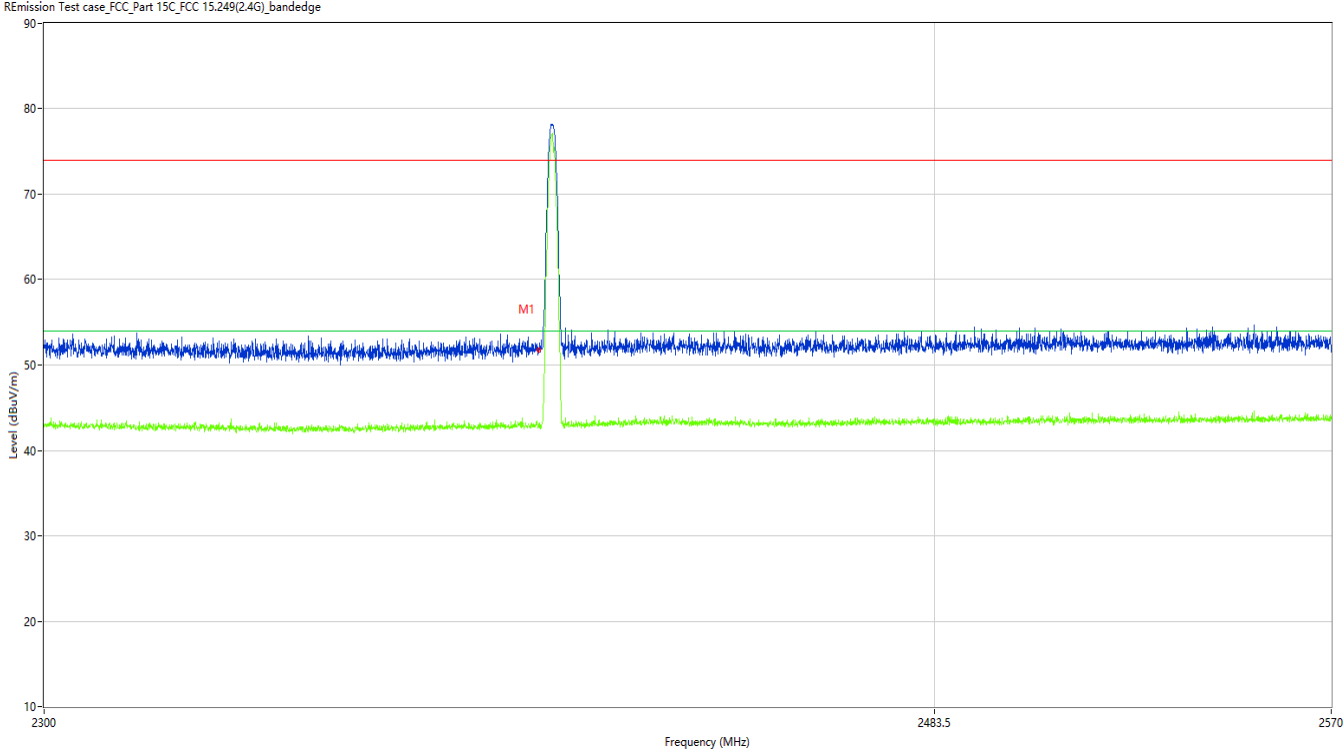

No.	Frequency (MHz)	Results (dBuV/m)	Factor (dB)	Limit (dBuV/m)	Margin (dB)	Detector	Table (Degree)	Height (cm)	Antenna	Verdict
1	2400.000	51.72	-9.87	74.0	22.28	Peak	359.43	100	Vertical	Pass
1**	2400.000	42.66	-9.87	54.0	11.34	AV	359.43	100	Vertical	Pass

TEST REPORT

Report No.: SHE23040034-02AE

Date: 2023-05-06

Page 37 of 47

Figure 27: Test plots of Band Edge, 2480MHz, Horizontal polarization

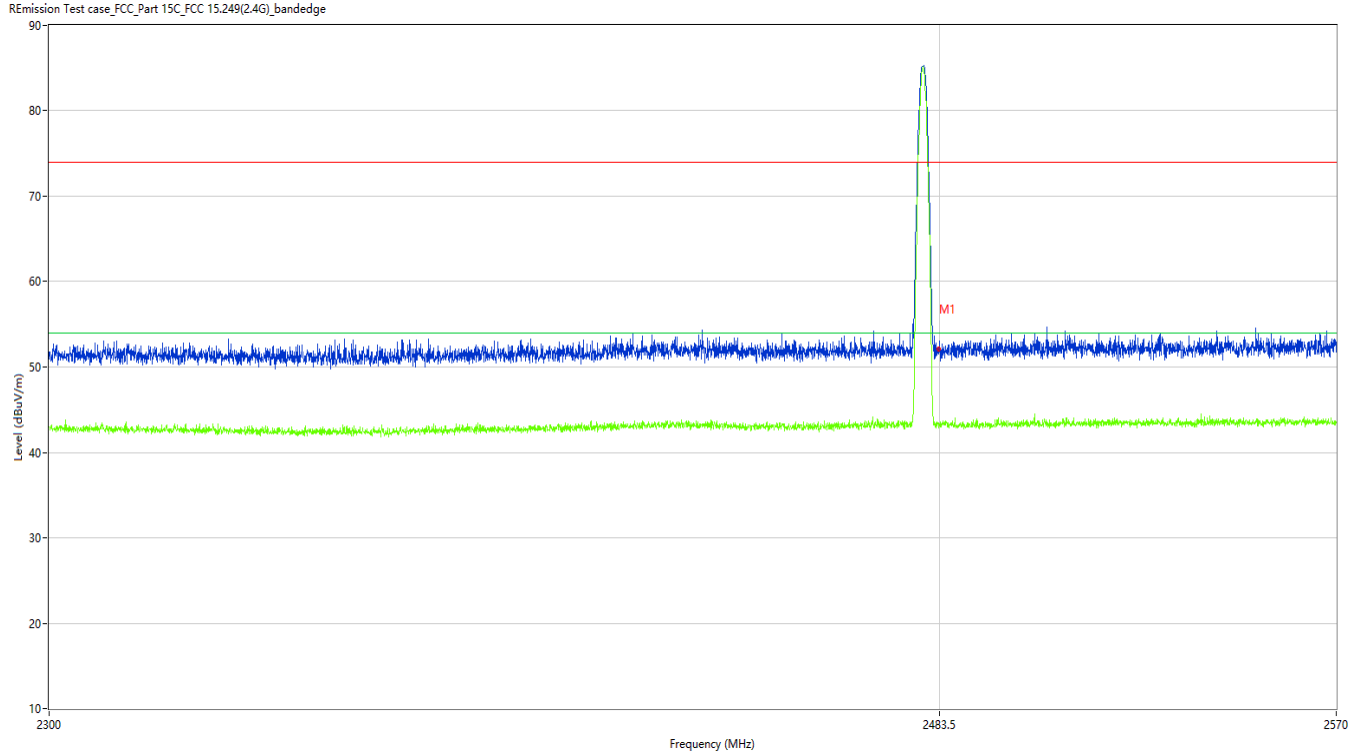

No.	Frequency (MHz)	Results (dBuV/m)	Factor (dB)	Limit (dBuV/m)	Margin (dB)	Detector	Table (Degree)	Height (cm)	Antenna	Verdict
1	2483.500	51.94	-9.51	74.0	22.06	Peak	305.85	100	Horizontal	Pass
1**	2483.500	42.99	-9.51	54.0	11.01	AV	305.85	100	Horizontal	Pass

TEST REPORT

Report No.: SHE23040034-02AE

Date: 2023-05-06

Page 38 of 47

Figure 28: Test plots of Band Edge, 2480MHz, Vertical polarization

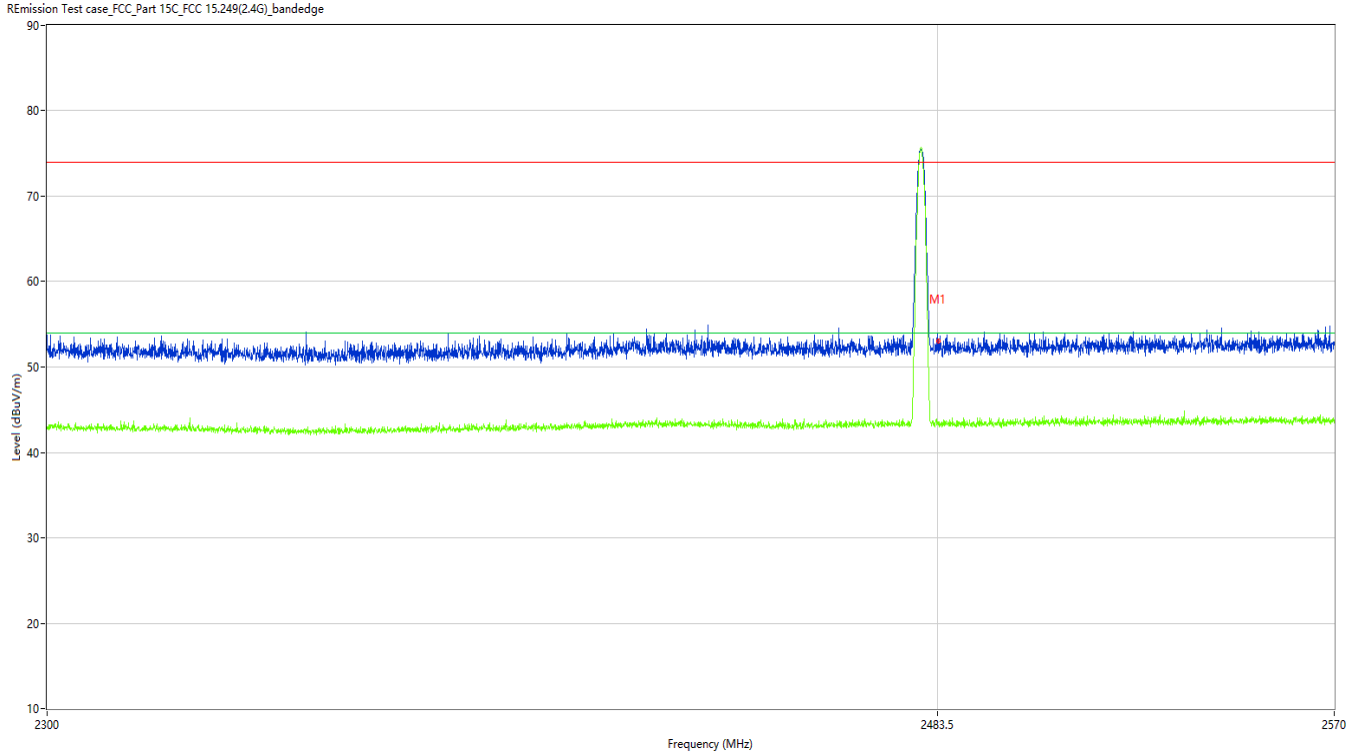

No.	Frequency (MHz)	Results (dBuV/m)	Factor (dB)	Limit (dBuV/m)	Margin (dB)	Detector	Table (Degree)	Height (cm)	Antenna	Verdict
1	2483.500	53.11	-9.51	74.0	20.89	Peak	56.76	100	Vertical	Pass
1**	2483.500	43.69	-9.51	54.0	10.31	AV	56.76	100	Vertical	Pass

TEST REPORT

Report No.: SHE23040034-02AE

Date: 2023-05-06

Page 39 of 47

4.1.4 20dB Bandwidth and 99% Bandwidth

RESULT:

PASS

Test standard : FCC Part 15.215(c), RSS-GEN 6.7

Requirement : ANSI C63.10-2013

Kind of test site : Shielded room

Test setup

Test Channel : Low/Middle/High

Operation Mode : A.i/ii/iii

Ambient temperature : 22.8°C

Relative humidity : 50%

Table 1: 20dB Bandwidth and 99% Bandwidth

Test Mode	Test Channel (MHz)	20dB Bandwidth (MHz)	99% Bandwidth (MHz)
GFSK	2403	1.031	0.937
	2442	0.986	0.905
	2480	1.078	0.966

TEST REPORT

Report No.:

SHE23040034-02AE

Date:

2023-05-06

Page 40 of 47

Figure 29: The plots of 20dB Bandwidth and 99% Bandwidth, 2403MHz



Figure 30: The plots of 20dB Bandwidth and 99% Bandwidth, 2442MHz

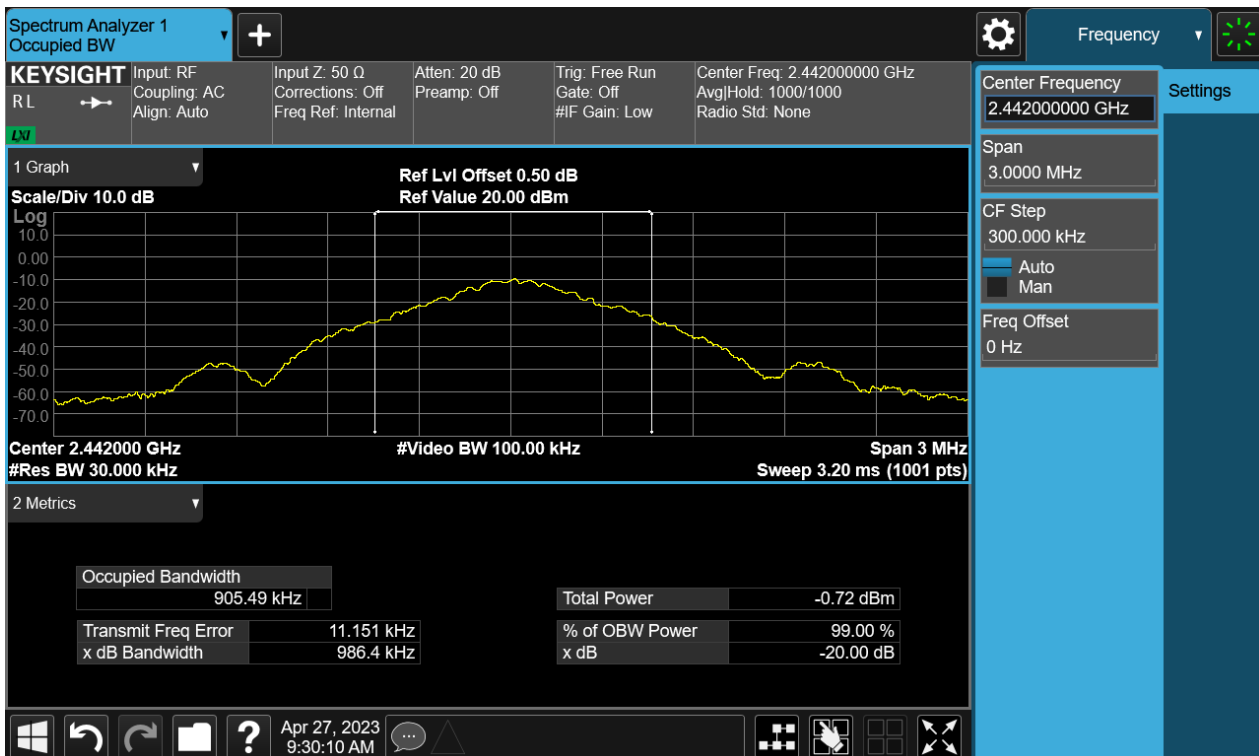

TEST REPORT

Report No.: SHE23040034-02AE

Date: 2023-05-06

Page 41 of 47

Figure 31: The plots of 20dB Bandwidth and 99% Bandwidth, 2480MHz

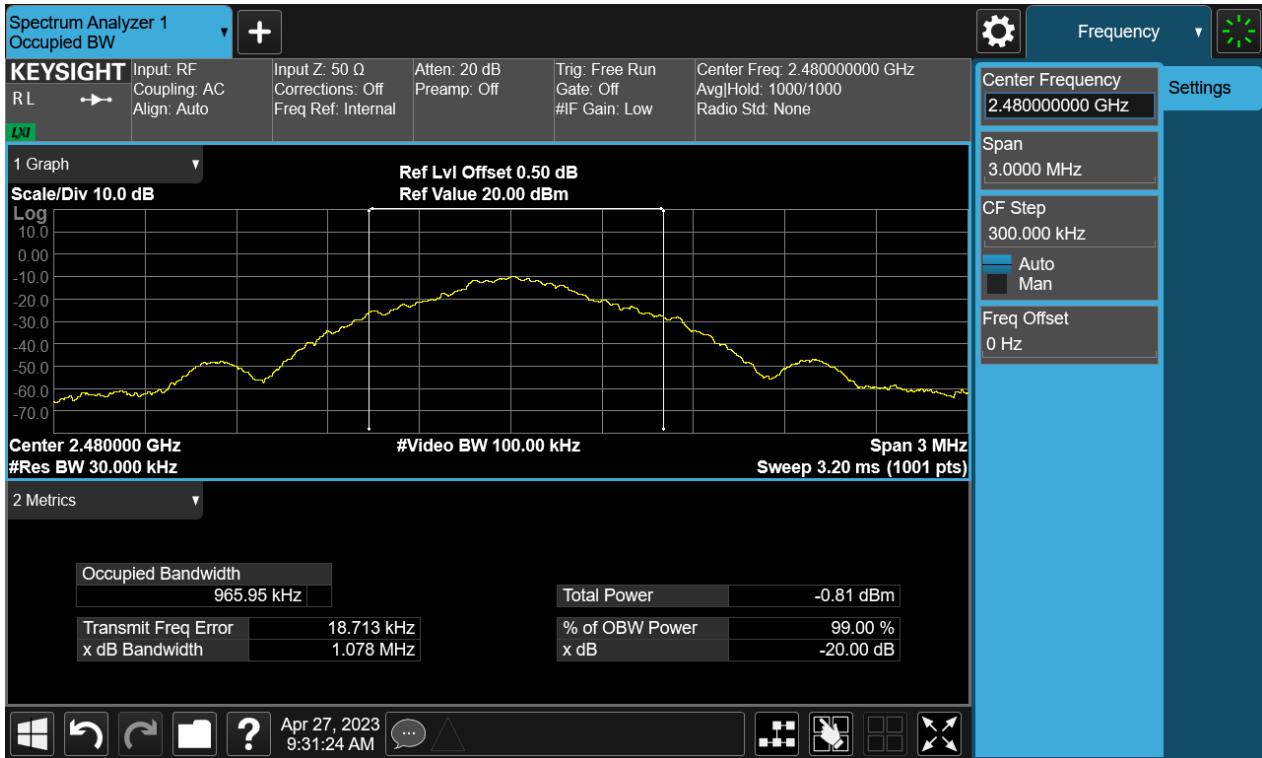

TEST REPORT

Report No.: SHE23040034-02AE

Date: 2023-05-06

Page 42 of 47

5 Appendixes

5.1 Photographs of the Sample



Front of the sample

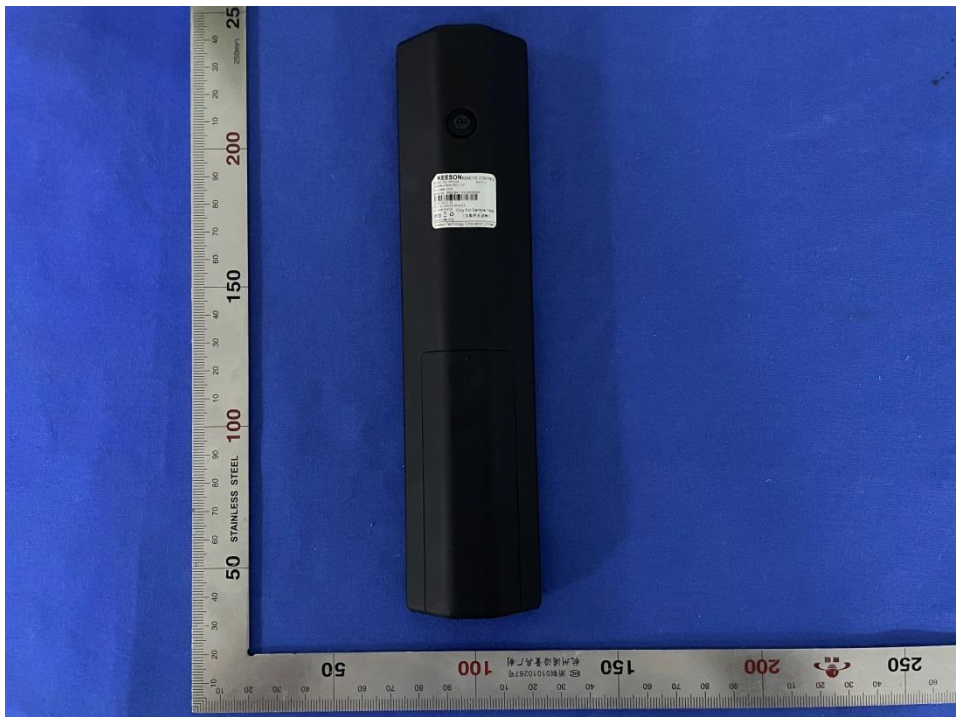

Back of the sample

TEST REPORT

Report No.:

SHE23040034-02AE

Date:

2023-05-06

Page 43 of 47



Left of the sample



Right of the sample

TEST REPORT

Report No.:

SHE23040034-02AE

Date:

2023-05-06

Page 44 of 47



Top of the sample



Bottom of the sample

TEST REPORT

Report No.:

SHE23040034-02AE

Date:

2023-05-06

Page 45 of 47

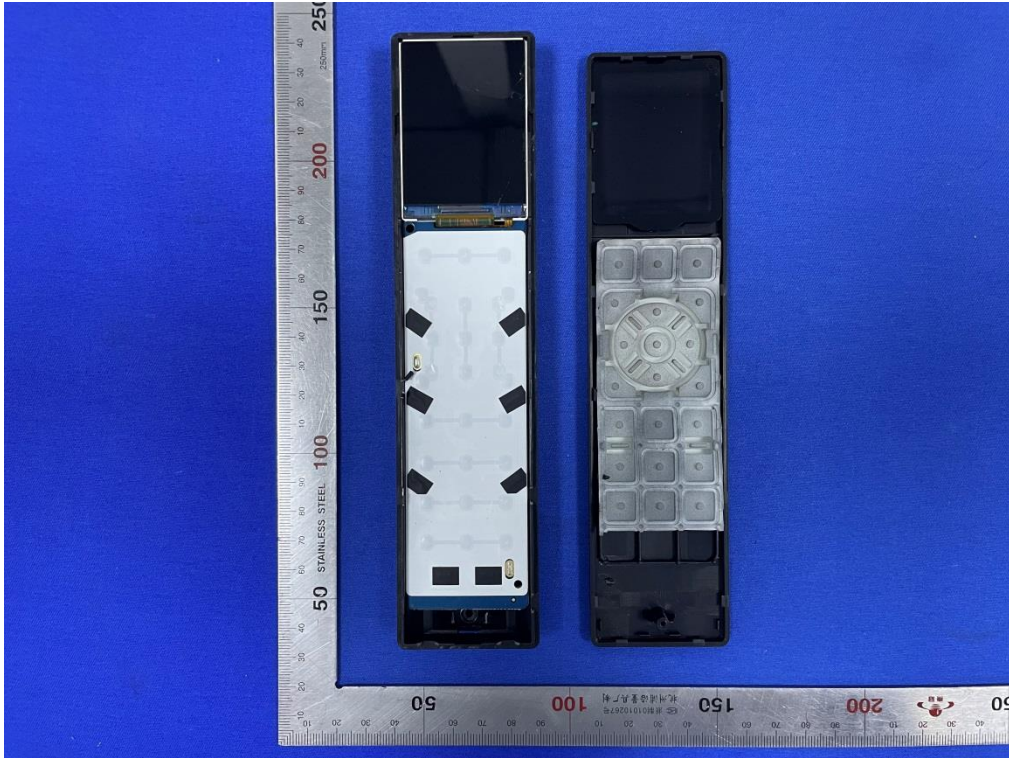

Open of the sample

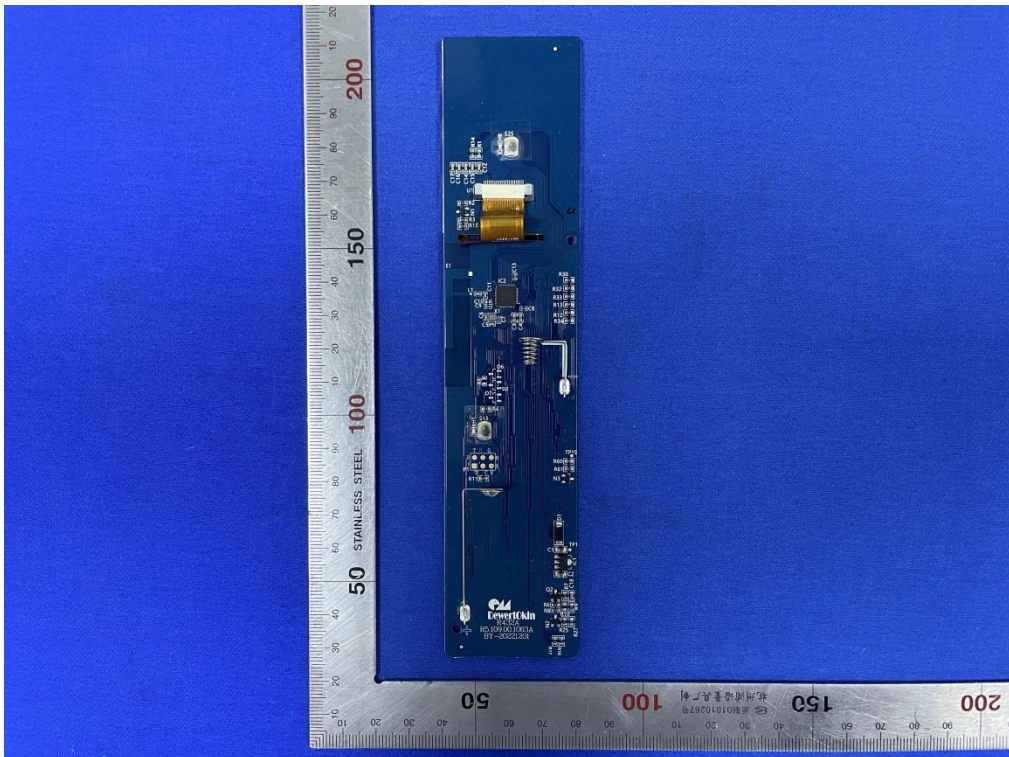

Internal-1 of the sample

TEST REPORT

Report No.:

SHE23040034-02AE

Date:

2023-05-06

Page 46 of 47

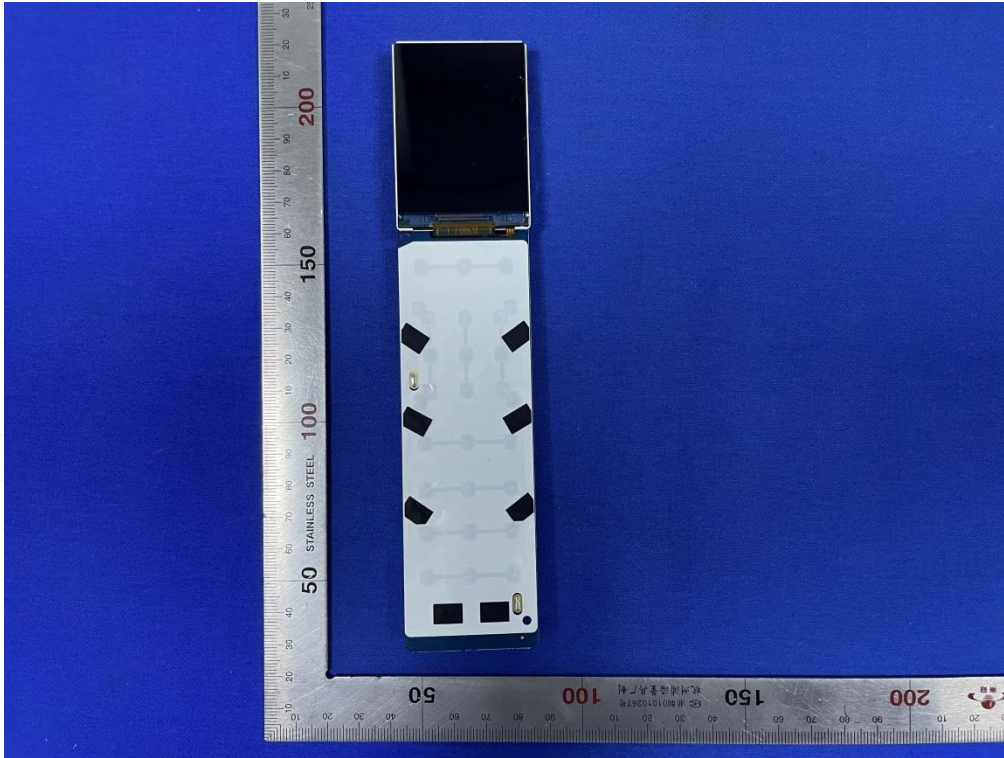

Internal-2 of the sample

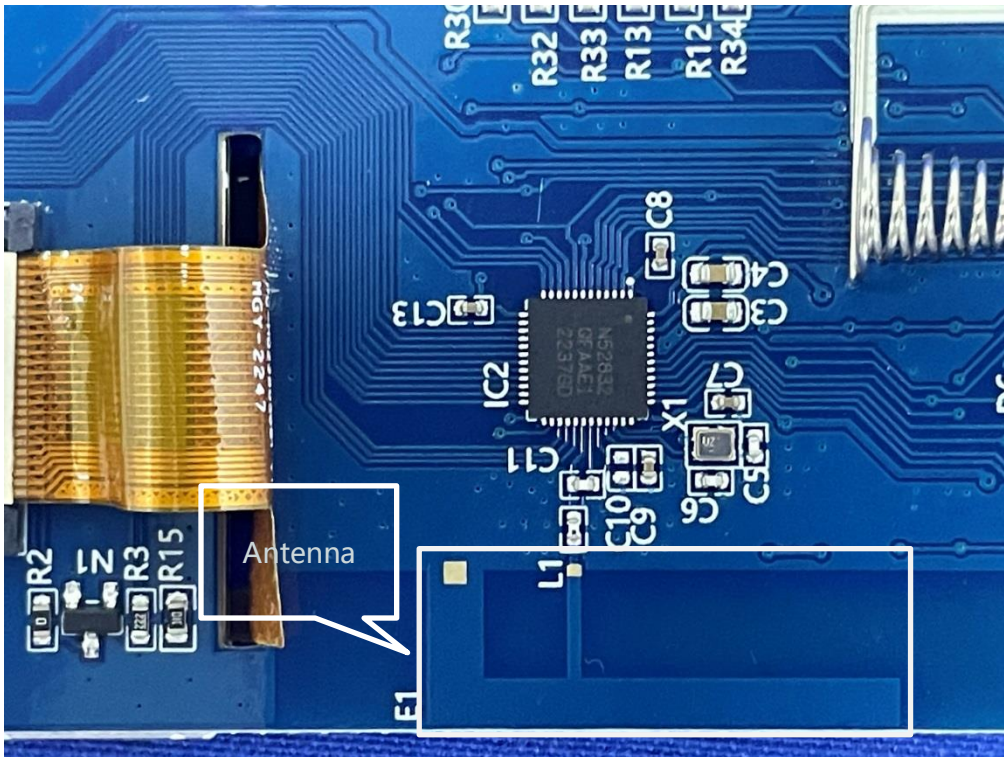

Antenna position of the sample

TEST REPORT

Report No.: SHE23040034-02AE

Date: 2023-05-06

Page 47 of 47

5.2 Set-up for Spurious Emissions below 1GHz

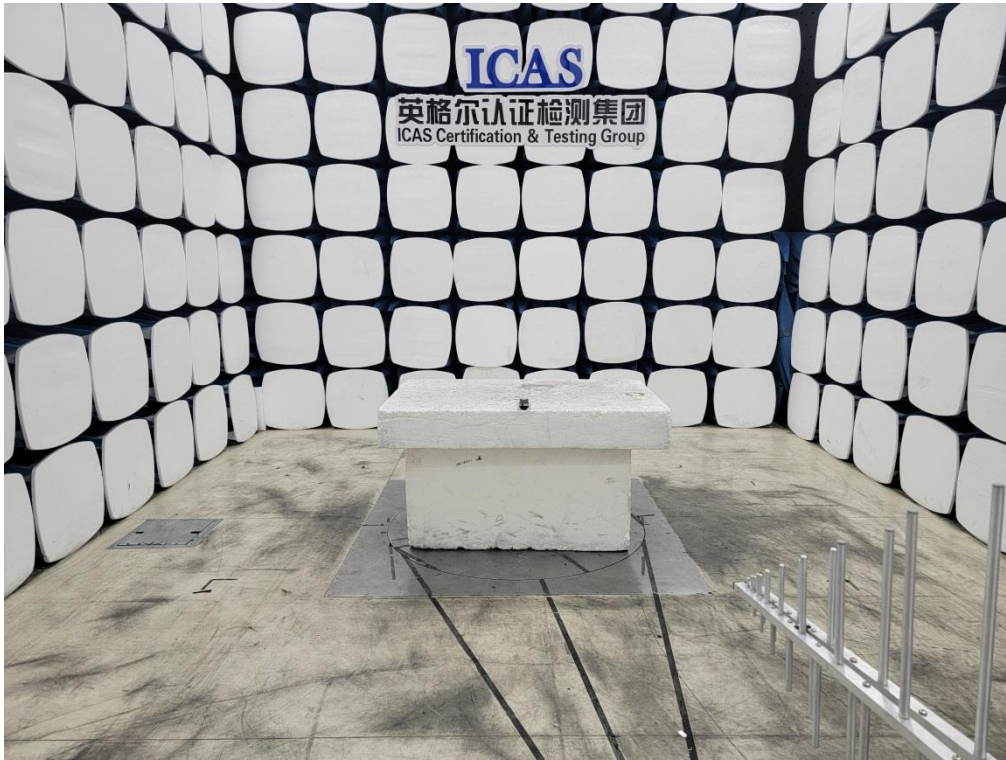

5.3 Set-up for Spurious Emissions above 1GHz

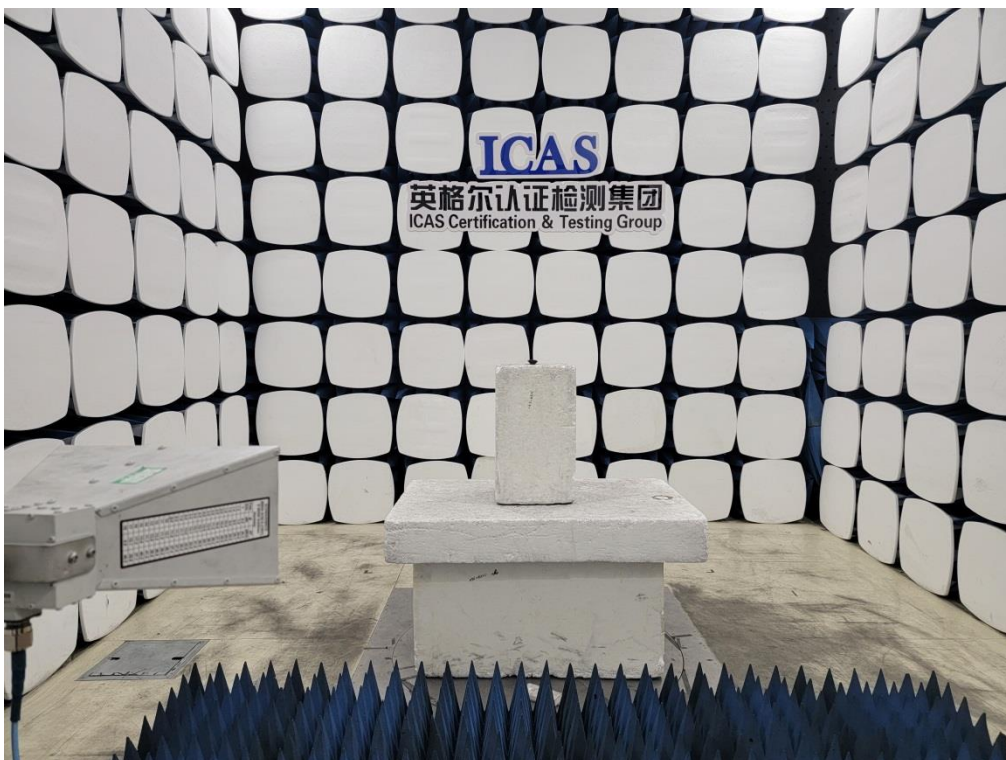

End of the report