

**FCC Part 15.249**  
**RSS-GEN ISSUE 5 February 2021 AMENDMENT 2**  
**RSS-210, ISSUE 10, April 2020 AMENDMENT**  
**TEST REPORT**

For

**Keeson Technology Corporation Limited**

No. 195, Yuanfeng East Road, Wangjiangjing, Xiuzhou District, Jiaxing City, China 314000

**FCC ID: 2AK23-RF406C**  
**IC: 22406-RF406C**

**Report Type:**  
Original Report

**Product Type:**  
Remote Control

**Report Producer :** Nana Hsu

**Report Number :** RLK220706003RF01

**Report Date :** 2022-08-15

**Reviewed By:** David Hsu *David.Hsu*

**Prepared By:** Bay Area Compliance Laboratories Corp.

(Linkou Laboratory)

No. 6, Wende 2Rd., Guishan Dist., Taoyuan City

33382, Taiwan (R.O.C.)

Tel: +886 (3)3961072; Fax: +886 (3) 3961027

[www.bacl.com.tw](http://www.bacl.com.tw)

## Revision History

Revision	No.	Report Number	Issue Date	Description	Author/ Revised by
0.0	RLK220706003	RLK220706003RF01	2022-08-15	Original Report	Nana Hsu

## TABLE OF CONTENTS

<b>1</b>	<b>General Information .....</b>	<b>4</b>
1.1	Product Description for Equipment under Test (EUT) .....	4
1.2	Objective .....	5
1.3	Test Methodology.....	5
1.4	Statement.....	5
1.5	Measurement Uncertainty .....	6
1.6	Environmental Conditions.....	6
1.7	Test Facility.....	6
<b>2</b>	<b>System Test Configuration .....</b>	<b>7</b>
2.1	Description of Test Configuration.....	7
2.2	Equipment Modifications .....	7
2.3	EUT Exercise Software .....	7
2.4	Support Equipment List and Details.....	7
2.5	External Cable List and Details.....	7
2.6	Block Diagram of Test Setup .....	8
<b>3</b>	<b>Summary of Test Results .....</b>	<b>10</b>
<b>4</b>	<b>Test Equipment List and Details.....</b>	<b>11</b>
<b>5</b>	<b>RSS-102 § 2.5.1 – EXEMPTION LIMITS FROM ROUTINE EVALUATION – SAR EVALUATION.....</b>	<b>12</b>
5.1	Applicable Standard .....	12
5.2	Calculated Data: .....	13
<b>6</b>	<b>FCC §15.203 &amp; RSS-GEN CLAUSE 6.8 – Antenna Requirements .....</b>	<b>14</b>
6.1	Applicable Standard .....	14
6.2	Antenna Information .....	14
<b>7</b>	<b>FCC §15.209, §15.205 , §15.249 &amp; RSS-210 ANNEX B.10, RSS-GEN CLAUSE 8.10 - Radiated Emissions .....</b>	<b>15</b>
7.1	Applicable Standard .....	15
7.2	EUT Setup .....	16
7.3	EMI Test Receiver & Spectrum Analyzer Setup.....	16
7.4	Test Procedure .....	17
7.5	Corrected Factor & Margin Calculation.....	17
7.6	Test Results Summary.....	17
7.7	Test Results .....	18
<b>8</b>	<b>FCC §15.215(c) &amp; RSS-GEN CLAUSE 6.7 – 20 dB Bandwidth Testing and 99% OCCUPIED BANDWIDTH .....</b>	<b>22</b>
8.1	Applicable Standard .....	22
8.2	Test Procedure.....	23
8.3	Test Results .....	23

# 1 General Information

## 1.1 Product Description for Equipment under Test (EUT)

Applicant	Keeson Technology Corporation Limited
	No. 195, Yuanfeng East Road, Wangjiangjing, Xiuzhou District, Jiaying City, China 314000
Manufacturer	Keeson Technology Corporation Limited
	No. 195, Yuanfeng East Road, Wangjiangjing, Xiuzhou District, Jiaying City, China 314000
Brand(Trade) Name	N/A
Product (Equipment)	Remote Control
Main Model Name (HVIN)	RF406C
Frequency Range	2403-2480 MHz
Antenna Specification	PCB Antenna / 1 dBi
Power Operation (Voltage Range)	<input type="checkbox"/> AC 120V/60Hz <input type="checkbox"/> Adapter I/P: <input type="checkbox"/> By AC Power Cord <input type="checkbox"/> PoE
	<input checked="" type="checkbox"/> DC Type <input checked="" type="checkbox"/> 3Vdc from Battery*2 <input type="checkbox"/> DC Power Supply <input type="checkbox"/> External from USB Cable <input type="checkbox"/> External DC Adapter
	<input type="checkbox"/> Host System
Received Date	Jul. 05, 2022
Date of Test	Jul. 07, 2022 ~ Jul. 08, 2022

*\*All measurement and test data in this report was gathered from production sample serial number:*

*RLK220706003-01 (Assigned by BACL, New Taipei Laboratory).*

## 1.2 Objective

This report is prepared on behalf of Keeson Technology Corporation Limited in accordance with Part 2-Subpart J, and Part 15-Subparts A and C of the Federal Communication Commission's rules, and RSS-210, Issue 10, April 2020 Amendment of the Innovation, Science and Economic Development Canada, and RSS-Gen Issue 5, February 2021 Amendment 2, General Requirements for Compliance of Radio Apparatus.

## 1.3 Test Methodology

All measurements contained in this report were conducted with ANSI C63.10-2013, American National Standard of Procedures for Compliance Testing of Unlicensed Wireless Devices, and RSS-210, Issue 10, April 2020 Amendment of the Innovation, Science and Economic Development Canada, and RSS-Gen Issue 5, February 2021 Amendment 2, General Requirements for Compliance of Radio Apparatus.

## 1.4 Statement

Decision Rule: No, (The test results do not include MU judgment)

It may not be duplicated or used in part without prior written consent from Bay Area Compliance Laboratories Corp. (Linkou Laboratory).

Any unauthorized alteration, forgery or falsification of the content or appearance of this document is unlawful and offenders may be prosecuted to the fullest extent of the law.

Unless otherwise stated the results shown in this test report refer only to the sample(s) tested.

The determination of the test results does not require consideration of the uncertainty of the measurement, unless the assessment is required by customer agreement, regulation or standard document specification.

Bay Area Compliance Laboratories Corp. (Linkou Laboratory) is not responsible for the authenticity of the information provided by the applicant that affects the test results.

**1.5 Measurement Uncertainty**

Parameter		Uncertainty
Emissions Bandwidth		+/- 0.35 MHz
Unwanted Emissions, conducted		+/- 1.69 dBm
Emissions, radiated	30 MHz~1GHz	+/- 5.22 dB
	1 GHz~18 GHz	+/- 6.12 dB
	18 GHz~40 GHz	+/- 4.99 dB
Temperature		+/- 1.27 °C
Humidity		+/- 3 %

**1.6 Environmental Conditions**

Test Site	Test Date	Temperature (°C)	Relative Humidity (%)	ATM Pressure (hPa)	Test Engineer
Radiation Spurious Emissions	2022/7/7-2022/7/8	27.2~27.6	63~65	1010	Alex Huang
Emission Bandwidth	2022/7/7	23.2	52	1010	Rory Cheng

**1.7 Test Facility**

The Test site used by Bay Area Compliance Laboratories Corp. (Linkou Laboratory) to collect test data is located on

No.6, Wende 2Rd., Guishan Dist., Taoyuan City 33382, Taiwan (R.O.C.).

Bay Area Compliance Laboratories Corp. (Linkou Laboratory) is accredited to ISO 17025 by Taiwan Accreditation Foundation (TAF code: 3546) and the FCC designation No.TW3546 under the Mutual Recognition Agreement (MRA) in FCC Test.

The lab has been recognized by Innovation, Science and Economic Development Canada to test to Canadian radio equipment requirements, the CAB identifier: TW3546.

## 2 System Test Configuration

### 2.1 Description of Test Configuration

The system was configured for testing in an engineering mode, which was provided by manufacturer.

The engineering mode was configured the system transmitting with maximum power.

The device employs 78 Channels as below table:

Channel	Frequency (MHz)	Channel	Frequency (MHz)
1	2403	40	2442
2	2404	...	...
...	...	...	...
38	2440	77	2479
39	2441	78	2480

Tested with channel 1, 40 and 78.

### 2.2 Equipment Modifications

No modification was made to the EUT.

### 2.3 EUT Exercise Software

Use the buttons on the remote control to switch the test channel.

Test Frequency	2403 MHz	2442 MHz	2480 MHz
Power Level Setting	Default	Default	Default

### 2.4 Support Equipment List and Details

N/A

### 2.5 External Cable List and Details

N/A

### 2.6 Block Diagram of Test Setup

See test photographs attached in setup photos for the actual connections between EUT and support equipment.

#### Radiation:

Below 1GHz:

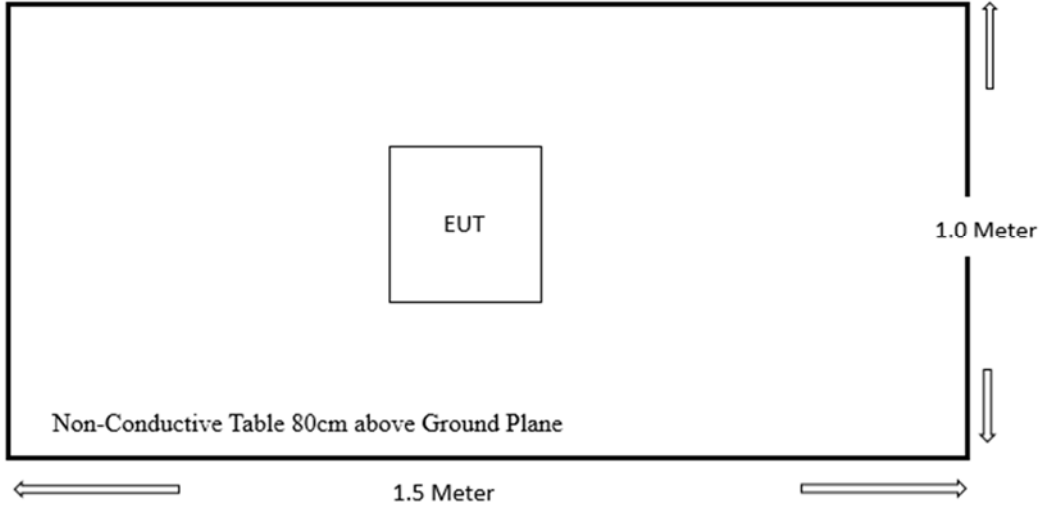

Above 1GHz:

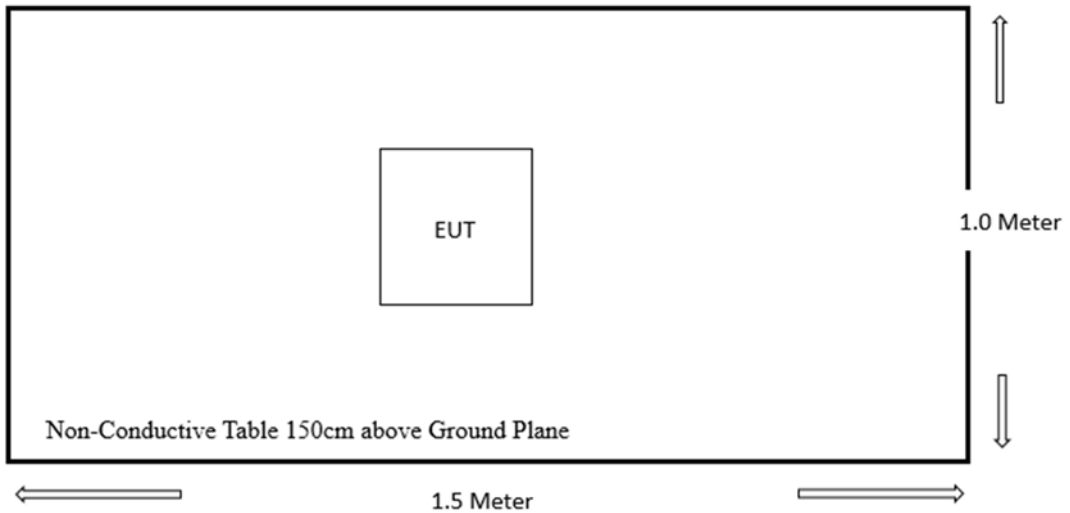



**Conducted**

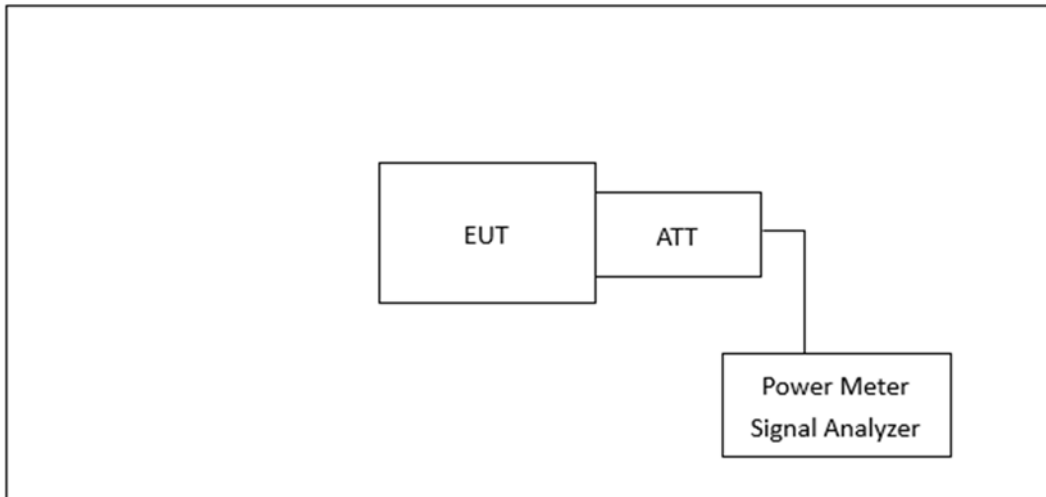

### 3 Summary of Test Results

FCC Rules	Description of Test	Results
RSS-102 Clause 2.5.1	Exemption Limits From Routine Evaluation-SAR Evaluation	Compliance
§15.203 RSS-GEN Clause 6.8	Antenna Requirement	Compliance
§15.207 (a) RSS-Gen Clause 8.8	AC Line Conducted Emissions	Not applicable
§15.205, §15.209, §15.249 RSS-210 Annex B.10 RSS-Gen Clause 8.10	Radiated Emissions	Compliance
§15.215 (c) RSS-Gen Clause 6.7	20 dB Emission Bandwidth 99% Occupied Bandwidth	Compliance
§1.1307(b)(3)(i)	RF Exposure	Compliance

Not applicable: The EUT is powered by batteries.

### 4 Test Equipment List and Details

Description	Manufacturer	Model	Serial Number	Calibration Date	Calibration Due Date
<b>Conducted</b>					
Signal and Spectrum Analyzer (with B21)	Rohde & Schwarz	FSV40	1321.3008K40-101938-Gt	2021/12/7	2022/12/6
10dB Attenuator	MCL	BW-S10W5+	605	2022/3/9	2023/3/8
Reference Cable	MTJ	MT40S	620620-MT40S-100	2021/12/22	2022/12/21
Description	Manufacturer	Model	Serial Number	Calibration Date	Calibration Due Date
<b>Radiated</b>					
Bilog Antenna & 6 dB Attenuator	SUNOL SCIENCES & EMCI	JB3 & N-6-06	A111513 & AT-N0668	2022/4/11	2023/4/10
Horn Antenna	ETS-Lindgren	3115	109141	2021/7/12	2022/7/11
Horn Antenna	ETS-Lindgren	3160-09	123852	2021/7/13	2022/7/12
Spectrum Analyzer	Rohde & Schwarz	FSV40	101940	2021/12/15	2022/12/14
ESR EMI Test Receiver	Rohde & Schwarz	ESR3	102448	2021/9/28	2022/9/27
Preamplifier with 1W input limiter	A.H. Systems	PAM-0118P	470	2022/3/23	2023/3/22
Microflex Cable (1m)	MTJ	00000-MT26A-100	H0919	2021/8/7	2022/8/6
Microflex Cable (2m)	EMCI	EMC106-SM-SM-2000	180515	2021/8/7	2022/8/6
Microflex Cable (8m)	UTIFLEX	UFA210A-1-3149-300300	MFR 64639 232490-001	2021/8/7	2022/8/6
Band Reject Filter	Xi'an Xingbo	XBLBQ-DZA81	190329-1-08	2022/4/14	2023/4/13
Software	Audix	e3	18621a bacl	N.C.R	N.C.R

*\*Statement of Traceability: BACL Corp. attests that all of the calibrations on the equipment items listed above were traceable to the SI System of Units via the R.O.C. Center for Measurement Standards of the Electronics Testing Center, Taiwan (ETC) or to another internationally recognized National Metrology Institute (NMI), and were compliant with the current Taiwan Accreditation Foundation (TAF) requirements*

## 5 RSS-102 § 2.5.1 – EXEMPTION LIMITS FROM ROUTINE EVALUATION – SAR EVALUATION

### 5.1 Applicable Standard

SAR evaluation is required if the separation distance between the user and/or bystander and the antenna and/or radiating element of the device is less than or equal to 20 cm, except when the device operates at or below the applicable output power level (adjusted for tune-up tolerance) for the specified separation distance defined in Table 1.

Table 1: SAR evaluation — Exemption limits for routine evaluation based on frequency and separation distance					
Frequency (MHz)	Exemption Limits (mW)				
	At separation	At separation	At separation	At separation	At separation
	distance of	distance of	distance of	distance of	distance of
	≤5 mm	10 mm	15 mm	20 mm	25 mm
≤300	71 mW	101 mW	132 mW	162 mW	193 mW
450	52 mW	70 mW	88 mW	106 mW	123 mW
835	17 mW	30 mW	42 mW	55 mW	67 mW
1900	7 mW	10 mW	18 mW	34 mW	60 mW
2450	4 mW	7 mW	15 mW	30 mW	52 mW
3500	2 mW	6 mW	16 mW	32 mW	55 mW
5800	1 mW	6 mW	15 mW	27 mW	41 mW
Frequency (MHz)	Exemption Limits (mW)				
	At separation	At separation	At separation	At separation	At separation
	distance of	distance of	distance of	distance of	distance of
	30 mm	35 mm	40 mm	45 mm	≥50 mm
≤300	223 mW	254 mW	284 mW	315 mW	345 mW
450	141 mW	159 mW	177 mW	195 mW	213 mW
835	80 mW	92 mW	105 mW	117 mW	130 mW
1900	99 mW	153 mW	225 mW	316 mW	431 mW
2450	83 mW	123 mW	173 mW	235 mW	309 mW
3500	86 mW	124 mW	170 mW	225 mW	290 mW
5800	56 mW	71 mW	85 mW	97 mW	106 mW

Output power level shall be the higher of the maximum conducted or equivalent isotropically radiated power (e.i.r.p.) source-based, time-averaged output power. For controlled use devices where the 8 W/kg for 1 gram of tissue applies, the exemption limits for routine evaluation in Table 1 are multiplied by a factor of 5. For limb-worn devices where the 10 gram value applies, the exemption limits for routine evaluation in Table 1 are multiplied by a factor of 2.5.

If the operating frequency of the device is between two frequencies located in Table 1, linear interpolation shall be applied for the applicable separation distance. For test separation distance less than 5 mm, the exemption limits for a separation distance of 5 mm can be applied to determine if a routine evaluation is required. For medical implants devices, the exemption limit for routine evaluation is set at 1 mW. The output power of a medical implants device is defined as the higher of the conducted or e.i.r.p to determine whether the device is exempt from the SAR evaluation.

**5.2 Calculated Data:**

According to Table 1, for the separation distance is less than or equal to 5 mm, the exemption limit for 2450MHz is 4mW and the exemption limit for 3500MHz is 2mW, so the exemption limit for 2480MHz =  $2\text{mW} + (3500\text{MHz}-2480\text{MHz}) \cdot (4\text{mW}-2\text{mW}) / (3500\text{MHz}-2450\text{MHz}) = 3.94 \text{ mW}$

For limb-worn devices exemption limits:  $3.94 \times 2.5 = 9.85 \text{ mW}$

Exemption from Routine Evaluation Limit is:

EIRP=  $88.36 \text{ dB}\mu\text{V/m} - 95.2 = -6.84 \text{ dBm}$

Tune-up power =  $-6.5 \text{ dBm} = 0.2 \text{ mW} < 9.85 \text{ mW}$

**Result:** The device meets the exemption requirement.

## 6 FCC §15.203 & RSS-GEN CLAUSE 6.8 – Antenna Requirements

### 6.1 Applicable Standard

For intentional device, according to §15.203, an intentional radiator shall be designed to ensure that no antenna other than that furnished by the responsible party shall be used.

According to RSS-Gen §6.8, The applicant for equipment certification shall provide a list of all antenna types that may be used with the transmitter, where applicable (i.e. fo transmitters with detachable antenna), indicating the maximum permissible antenna gain (in dBi) and the required impedance for each antenna. The test report shall demonstrate the compliance of the transmitter with the limit for maximum equivalent isotropically radiated power (e.i.r.p.) specified in the applicable RSS, when the transmitter is equipped with any antenna type, selected from this list.

For expediting the testing, measurements may be performed using only the antenna with highest gain of each combination of transmitter and antenna type, with the transmitter output power set at the maximum level. However, the transmitter shall comply with the applicable requirements under all operational conditions and when in combination with any type of antenna from the list provided in the test report (and in the notice to be included in the user manual, provided below).

When measurements at the antenna port are used to determine the RF output power, the effective gain of the device's antenna shall be stated, based on a measurement or on data from the antenna's manufacturer. The test report shall state the RF power, output power setting and spurious emission measurements with each antenna type that is used with the transmitter being tested.

For licence-exempt equipment with detachable antennas, the user manual shall also contain the following notice in a conspicuous location:

*This radio transmitter [enter the device's ISED certification number] has been approved by Innovation, Science and Economic Development Canada to operate with the antenna types listed below, with the maximum permissible gain indicated. Antenna types not included in this list that have a gain greater than the maximum gain indicated for any type listed are strictly prohibited for use with this device.*

Immediately following the above notice, the manufacturer shall provide a list of all antenna types which can be used with the transmitter, indicating the maximum permissible antenna gain (in dBi) and the required impedance for each antenna type.

### 6.2 Antenna Information

Type	Antenna Gain	Input impedance
PCB Antenna	1 dBi	50Ω

**Result:** Compliance.

## 7 FCC §15.209, §15.205 , §15.249 & RSS-210 ANNEX B.10, RSS-GEN CLAUSE 8.10 - Radiated Emissions

### 7.1 Applicable Standard

As per FCC§15.249 (a), except as provided in paragraph (b) of this section, the field strength of emissions from intentional radiators operated within these frequency bands shall comply with the following:

Fundamental frequency	Field strength of fundamental (millivolts/meter)	Field strength of harmonics (microvolts/meter)
920-928 MHz	50	500
2400-2483.5 MHz	50	500
5725-5875 MHz	50	500
24.0-24.25 GHz	250	2500

As per FCC§15.249 (c), Field strength limits are specified at a distance of 3 meters.

(d) Emissions radiated outside of the specified frequency bands, except for harmonics, shall be attenuated by at least 50 dB below the level of the fundamental or to the general radiated emission limits in §15.209, whichever is the lesser attenuation.

According to RSS-210 Issue 10 Clause Annex B B.10 (a): The field strength of fundamental and harmonic emissions, measured at 3 m, shall not exceed 50 mV/m and 0.5 mV/m respectively.

According to RSS-210 Issue 10 Clause Annex B B.10 (b): Emissions radiated outside of the specified frequency bands, except for harmonic emissions, shall be attenuated by at least 50 dB below the level of the fundamental emissions or to the general field strength limits listed in RSS-GEN Issue 5, whichever is less stringent.

Field strength limits at various frequencies		
Fundamental frequency	Field strength (mV/m)	
	Fundamental emissions	Harmonic emissions
920-928 MHz	50	0.5
2400-2483.5 MHz	50	0.5
5725-5875 MHz	50	0.5
24.0-24.25 GHz	250	2.5

As per RSS-210 Issue 10 Clause Annex B B.10, Field strength limits are specified at a distance of 3 meters.

### 7.2 EUT Setup

Below 1 GHz:

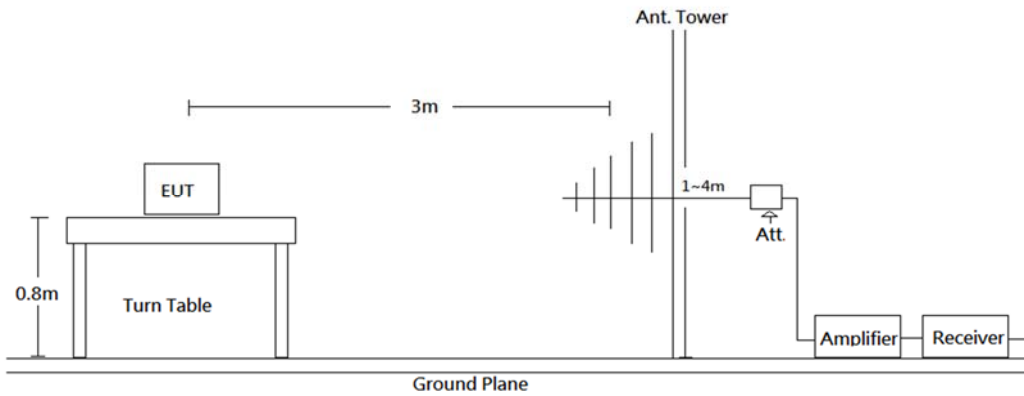

Above 1 GHz:

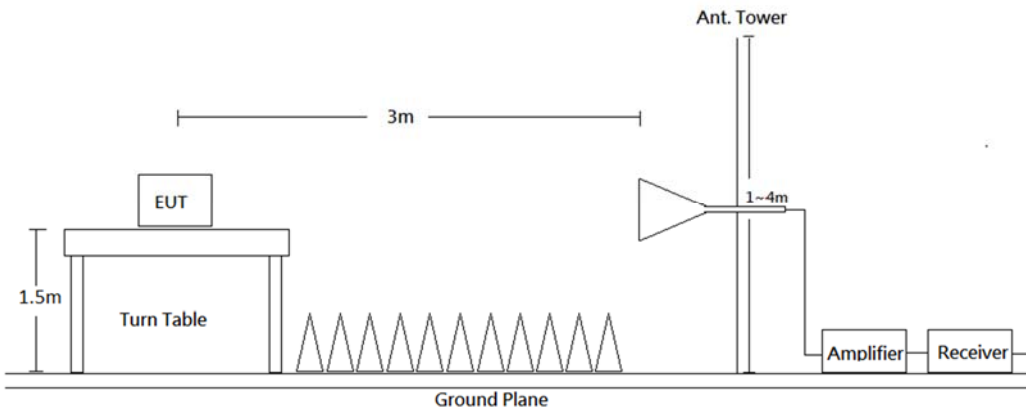

Radiated emission tests were performed in the 3 meters chamber test site, using the setup accordance with the ANSI C63.10-2013. The specification used was the FCC 15.205, FCC 15.209, FCC 15.249 and RSS-GEN, RSS-210 limits.

### 7.3 EMI Test Receiver & Spectrum Analyzer Setup

The system was investigated from 30 MHz to 26.5 GHz. During the radiated emission test, the EMI test receiver was set with the following configurations:

Frequency Range	RBW	VBW	Measurement method
30-1000 MHz	120 kHz	300 kHz	QP
Above 1 GHz	1 MHz	3 MHz	PK
	1 MHz	3 MHz	Ave



#### 7.4 Test Procedure

Maximizing procedure was performed on the highest emissions to ensure that the EUT complied with all installation combinations.

All data was recorded in the Quasi-peak detector mode from 30 MHz to 1 GHz and PK and average detector modes for frequencies above 1 GHz.

#### 7.5 Corrected Factor & Margin Calculation

The Correct Factor is calculated by adding the Antenna Factor and Cable Loss, and subtracting the Amplifier Gain from the Meter Reading. The basic equation is as follows:

$$\text{Correct Factor} = \text{Antenna Factor} + \text{Cable Loss} - \text{Amplifier Gain}$$

The “Margin” column of the following data tables indicates the degree of compliance with the applicable limit. For example, a margin of -7 dB means the emission is 7 dB below the limit. The equation for margin calculation is as follows:

$$\text{Margin} = \text{Result} - \text{Limit}$$

#### 7.6 Test Results Summary

According to the data in the following table, the EUT complied with the FCC 15.205, FCC 15.209, FCC 15.249 and RSS-210, RSS-Gen.

### 7.7 Test Results

#### Test Mode: Transmitting

(Pre-scan with three orthogonal axis, and worse case as Z axis.)

(worst case is low channel)

30MHz-1GHz:

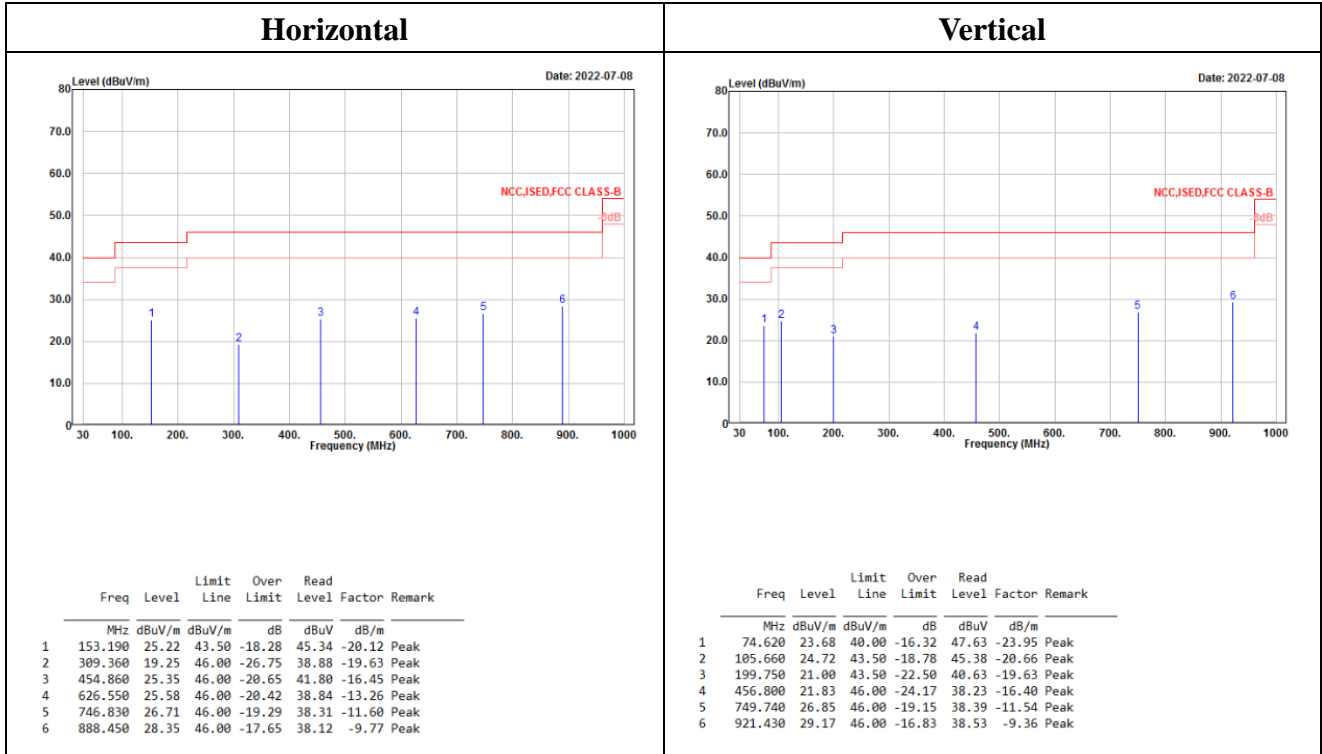

Level (Result) = Reading Level + Factor.

Over Limit = Level – Limit.

Factor = Antenna Factor + Cable Loss – Amplifier Gain.

Spurious emissions more than 20 dB below the limit were not reported.

Fundamental

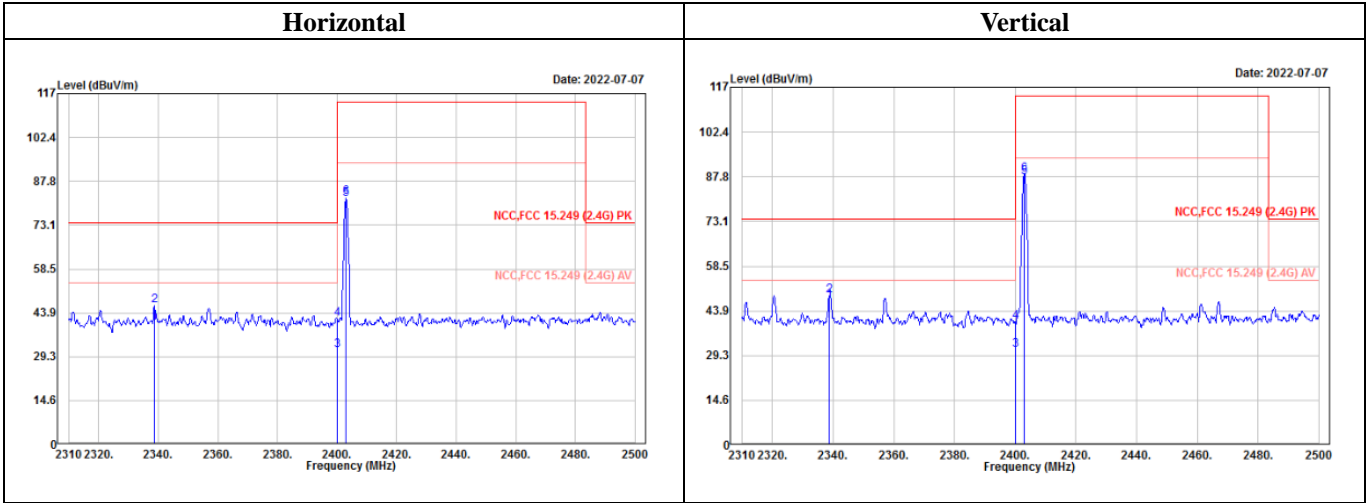

1GHz-18GHz:

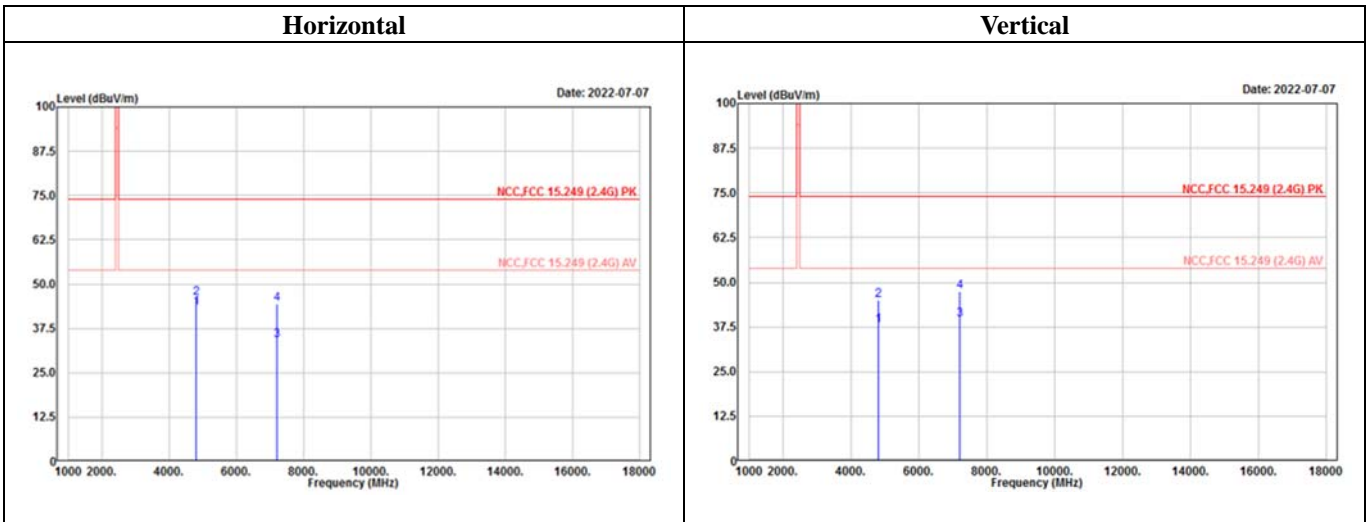

18GHz-26.5GHz:

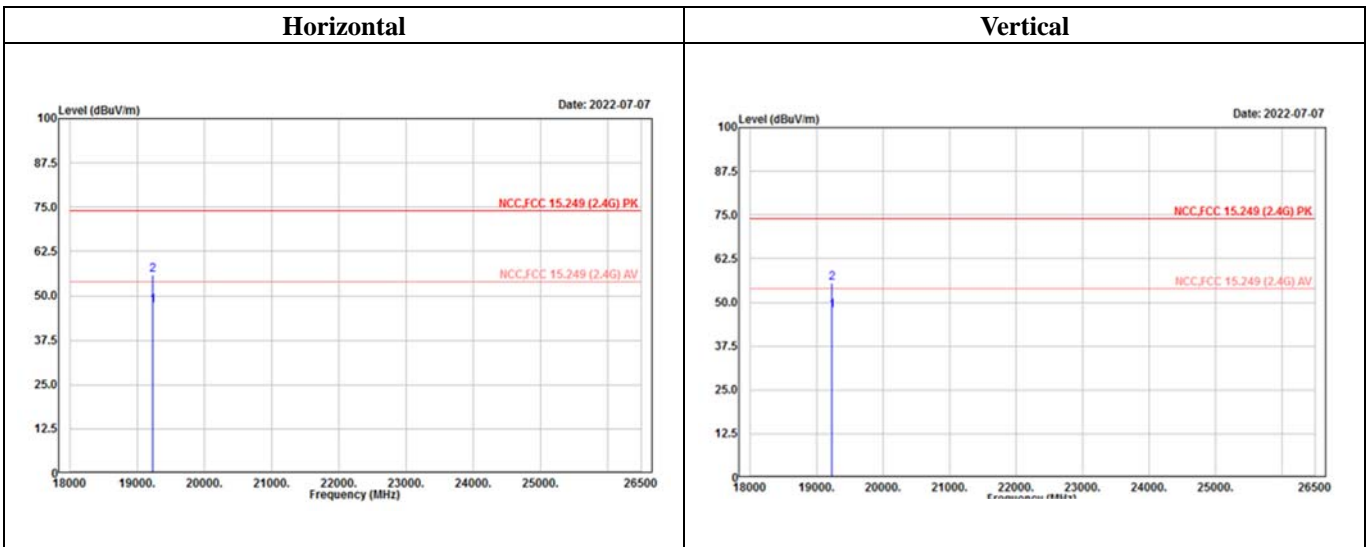

**Above 1GHz**

**Horizontal**

Low channel							
	Freq	Level	Limit Line	Over Limit	Read Level	Factor	Remark
	MHz	dBuV/m	dBuV/m	dB	dBuV	dB/m	
1 !	2338.690	40.50	54.00	-13.50	50.36	-9.86	Average
2	2338.690	46.17	74.00	-27.83	56.03	-9.86	Peak
3	2400.000	31.30	54.00	-22.70	40.97	-9.67	Average
4	2400.000	41.99	74.00	-32.01	51.66	-9.67	Peak
5 !	2403.000	81.77	94.00	-12.23	91.42	-9.65	Average
6	2403.000	82.55	114.00	-31.45	92.20	-9.65	Peak

	Freq	Level	Limit Line	Over Limit	Read Level	Factor	Remark
	MHz	dBuV/m	dBuV/m	dB	dBuV	dB/m	
1 !	4806.000	43.36	54.00	-10.64	46.06	-2.70	Average
2	4806.000	46.16	74.00	-27.84	48.86	-2.70	Peak
3 !	7209.000	34.28	54.00	-19.72	30.46	3.82	Average
4	7209.000	44.46	74.00	-29.54	40.64	3.82	Peak

Middle channel							
	Freq	Level	Limit Line	Over Limit	Read Level	Factor	Remark
	MHz	dBuV/m	dBuV/m	dB	dBuV	dB/m	
1 !	2442.000	80.73	94.00	-13.27	90.26	-9.53	Average
2	2442.000	81.01	114.00	-32.99	90.54	-9.53	Peak

	Freq	Level	Limit Line	Over Limit	Read Level	Factor	Remark
	MHz	dBuV/m	dBuV/m	dB	dBuV	dB/m	
1 !	4884.000	36.37	54.00	-17.63	38.86	-2.49	Average
2	4884.000	45.39	74.00	-28.61	47.88	-2.49	Peak
3 !	7326.000	34.77	54.00	-19.23	30.59	4.18	Average
4	7326.000	47.83	74.00	-26.17	43.65	4.18	Peak

High channel							
	Freq	Level	Limit Line	Over Limit	Read Level	Factor	Remark
	MHz	dBuV/m	dBuV/m	dB	dBuV	dB/m	
1 !	2480.000	80.29	94.00	-13.71	89.71	-9.42	Average
2	2480.000	80.56	114.00	-33.44	89.98	-9.42	Peak
3	2487.270	30.92	54.00	-23.08	40.31	-9.39	Average
4	2487.270	44.31	74.00	-29.69	53.70	-9.39	Peak

	Freq	Level	Limit Line	Over Limit	Read Level	Factor	Remark
	MHz	dBuV/m	dBuV/m	dB	dBuV	dB/m	
1 !	4960.000	42.08	54.00	-11.92	44.35	-2.27	Average
2	4960.000	46.89	74.00	-27.11	49.16	-2.27	Peak
3 !	7440.000	39.59	54.00	-14.41	35.12	4.47	Average
4	7440.000	47.52	74.00	-26.48	43.05	4.47	Peak

Level (Result) = Reading Level + Factor.

Over Limit = Level – Limit.

Factor = Antenna Factor + Cable Loss – Amplifier Gain.

Spurious emissions more than 20 dB below the limit were not reported.

**Vertical**

<b>Low channel</b>							
	Freq	Level	Limit Line	Over Limit	Read Level	Factor	Remark
	MHz	dBuV/m	dBuV/m	dB	dBuV	dB/m	
1 !	2338.880	46.98	54.00	-7.02	56.84	-9.86	Average
2	2338.880	48.90	74.00	-25.10	58.76	-9.86	Peak
3	2400.000	31.22	54.00	-22.78	40.89	-9.67	Average
4	2400.000	40.22	74.00	-33.78	49.89	-9.67	Peak
5 !	2403.000	87.67	94.00	-6.33	97.32	-9.65	Average
6	2403.000	88.36	114.00	-25.64	98.01	-9.65	Peak

	Freq	Level	Limit Line	Over Limit	Read Level	Factor	Remark
	MHz	dBuV/m	dBuV/m	dB	dBuV	dB/m	
1 !	4806.000	38.05	54.00	-15.95	40.75	-2.70	Average
2	4806.000	45.08	74.00	-28.92	47.78	-2.70	Peak
3 !	7209.000	39.46	54.00	-14.54	35.64	3.82	Average
4	7209.000	47.48	74.00	-26.52	43.66	3.82	Peak

<b>Middle channel</b>							
	Freq	Level	Limit Line	Over Limit	Read Level	Factor	Remark
	MHz	dBuV/m	dBuV/m	dB	dBuV	dB/m	
1 !	2442.000	86.58	94.00	-7.42	96.11	-9.53	Average
2	2442.000	86.83	114.00	-27.17	96.36	-9.53	Peak

	Freq	Level	Limit Line	Over Limit	Read Level	Factor	Remark
	MHz	dBuV/m	dBuV/m	dB	dBuV	dB/m	
1 !	4884.000	38.77	54.00	-15.23	41.26	-2.49	Average
2	4884.000	45.77	74.00	-28.23	48.26	-2.49	Peak
3 !	7326.000	37.43	54.00	-16.57	33.25	4.18	Average
4	7326.000	48.58	74.00	-25.42	44.40	4.18	Peak

<b>High channel</b>							
	Freq	Level	Limit Line	Over Limit	Read Level	Factor	Remark
	MHz	dBuV/m	dBuV/m	dB	dBuV	dB/m	
1 !	2480.000	85.21	94.00	-8.79	94.63	-9.42	Average
2	2480.000	85.42	114.00	-28.58	94.84	-9.42	Peak
3	2486.320	33.02	54.00	-20.98	42.41	-9.39	Average
4	2486.320	43.65	74.00	-30.35	53.04	-9.39	Peak

	Freq	Level	Limit Line	Over Limit	Read Level	Factor	Remark
	MHz	dBuV/m	dBuV/m	dB	dBuV	dB/m	
1 !	4960.000	42.15	54.00	-11.85	44.42	-2.27	Average
2	4960.000	46.71	74.00	-27.29	48.98	-2.27	Peak
3 !	7440.000	41.27	54.00	-12.73	36.80	4.47	Average
4	7440.000	49.98	74.00	-24.02	45.51	4.47	Peak

Level (Result) = Reading Level + Factor.

Over Limit = Level - Limit.

Factor = Antenna Factor + Cable Loss - Amplifier Gain.

Spurious emissions more than 20 dB below the limit were not reported.

## **8 FCC §15.215(c) & RSS-GEN CLAUSE 6.7 – 20 dB Bandwidth Testing and 99% OCCUPIED BANDWIDTH**

### **8.1 Applicable Standard**

Intentional radiators operating under the alternative provisions to the general emission limits, as contained in § 15.217 through 15.257 and in Subpart E of this part, must be designed to ensure that the 20 dB bandwidth of the emission, or whatever bandwidth may otherwise be specified in the specific rule section under which the equipment operates, is contained within the frequency band designated in the rule section under which the equipment is operated.

According to RSS-Gen Clause 6.7:

The occupied bandwidth or the “99% emission bandwidth” is defined as the frequency range between two points, one above and the other below the carrier frequency, within which 99% of the total transmitted power of the fundamental transmitted emission is contained. The occupied bandwidth shall be reported for all equipment in addition to the specified bandwidth required in the applicable RSSs.

In some cases, the “x dB bandwidth” is required, which is defined as the frequency range between two points, one at the lowest frequency below and one at the highest frequency above the carrier frequency, at which the maximum power level of the transmitted emission is attenuated x dB below the maximum inband power level of the modulated signal, where the two points are on the outskirts of the in-band emission.

The following conditions shall be observed for measuring the occupied bandwidth and x dB bandwidth: The transmitter shall be operated at its maximum carrier power measured under normal test conditions.

The span of the spectrum analyzer shall be set large enough to capture all products of the modulation process, including the emission skirts, around the carrier frequency, but small enough to avoid having other emissions (e.g. on adjacent channels) within the span. The detector of the spectrum analyzer shall be set to “Sample” .

However, a peak, or peak hold,

may be used in place of the sampling detector since this usually produces a wider bandwidth than the actual bandwidth (worst-case measurement). Use of a peak hold (or “Max Hold”) may be necessary to determine the occupied / x dB bandwidth if the device is not transmitting continuously.

The resolution bandwidth (RBW) shall be in the range of 1% to 5% of the actual occupied / x dB bandwidth and the video bandwidth (VBW) shall not be smaller than three times the RBW value. Video averaging is not permitted.

Note: It may be necessary to repeat the measurement a few times until the RBW and VBW are in compliance with the above requirement.

## 8.2 Test Procedure

20dB bandwidth test:

1. Check the calibration of the measuring instrument using either an internal calibrator or a known signal from an external generator.
2. Position the EUT without connection to measurement instrument. Turn on the EUT and connect it to measurement instrument. Then set it to any one convenient frequency within its operating range. Set a reference level on the measuring instrument equal to the highest peak value.
3. Measure the frequency difference of two frequencies that were attenuated 20 dB from the reference level. Record the frequency difference as the emission bandwidth.
4. Repeat above procedures until all frequencies measured were complete.

For the 99% emission bandwidth, the trace data points are recovered and directly summed in linear power level terms. The recovered amplitude data points, beginning at the lowest frequency, are placed in a running sum until 0.5% of the total is reached, and that frequency recorded. The process is repeated for the highest frequency data points (starting at the highest frequency, at the right side of the span, and going down in frequency). This frequency is then recorded. The difference between the two recorded frequencies is the occupied bandwidth (or the 99% emission bandwidth).

## 8.3 Test Results

Channel	Frequency (MHz)	20 dB Emission Bandwidth (kHz)	99% Occupied Bandwidth (kHz)
Low	2403	1004	933
Middle	2442	1022	925
High	2480	1026	920



Please refer to the following plots

**20 dB Emission Bandwidth**

**Low Channel**

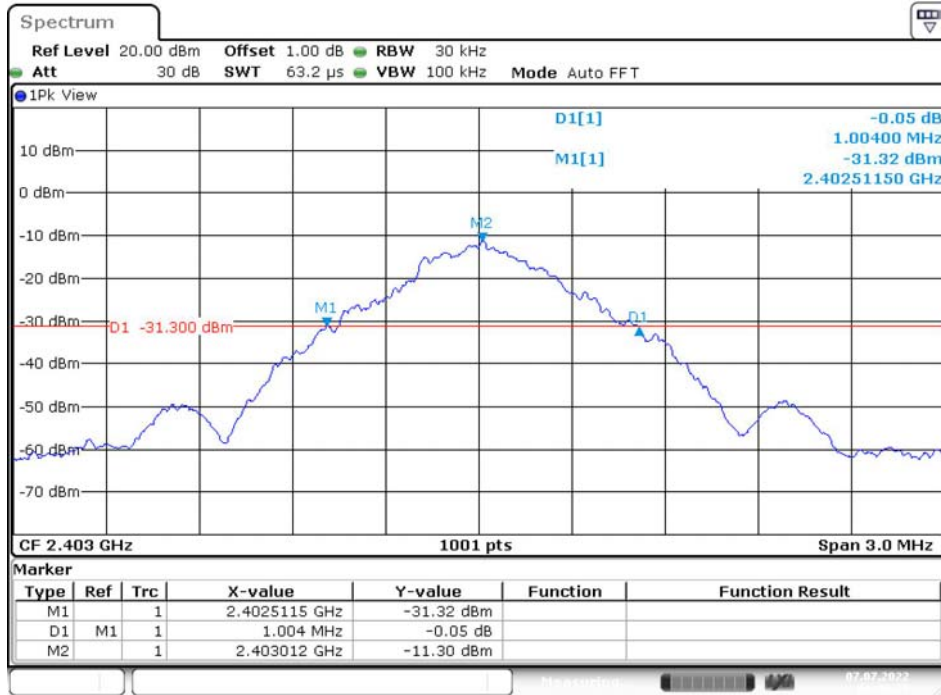

Date: 7.JUL.2022 09:48:19

**Middle Channel**

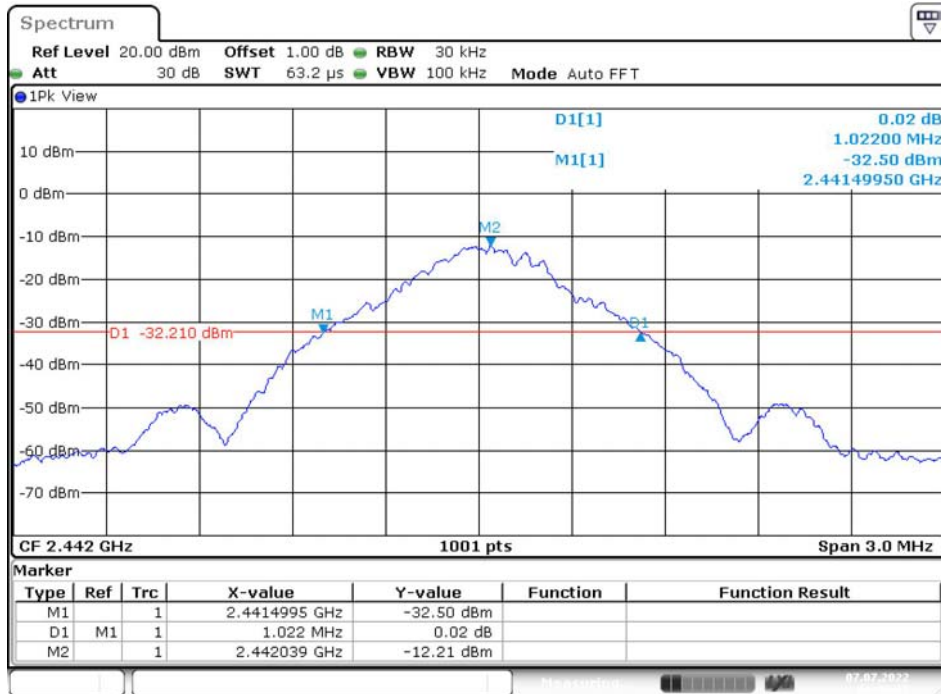

Date: 7.JUL.2022 09:49:02



### High Channel

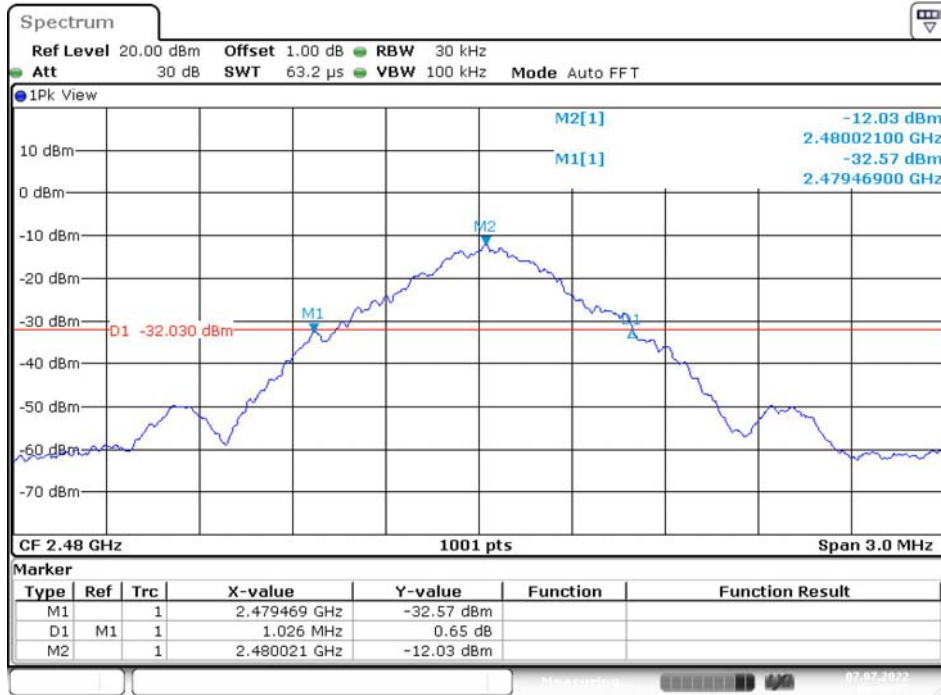

### 99% Occupied Bandwidth

### Low Channel

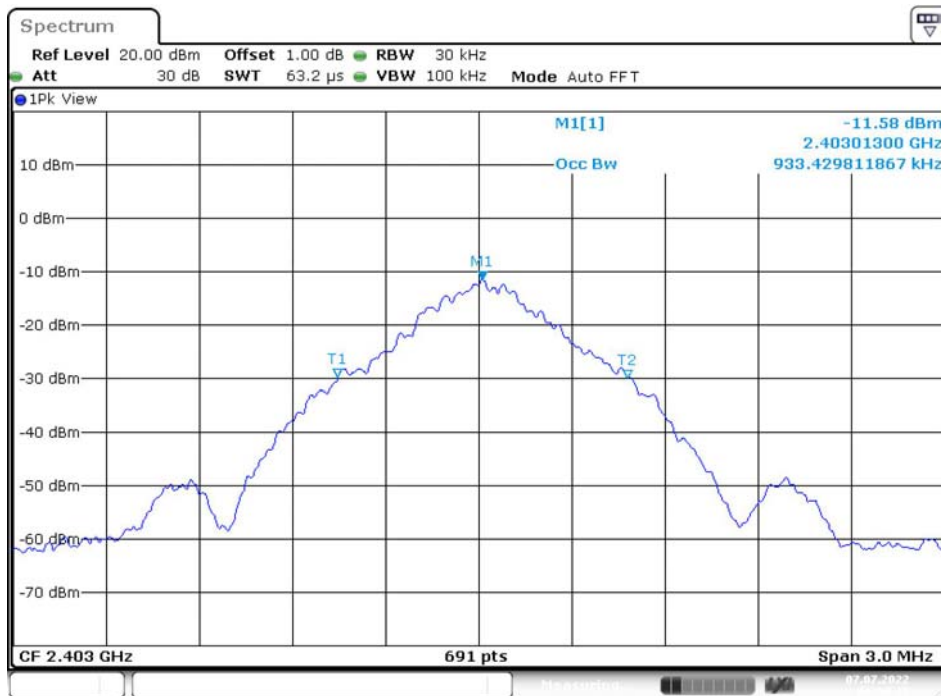

### Middle Channel

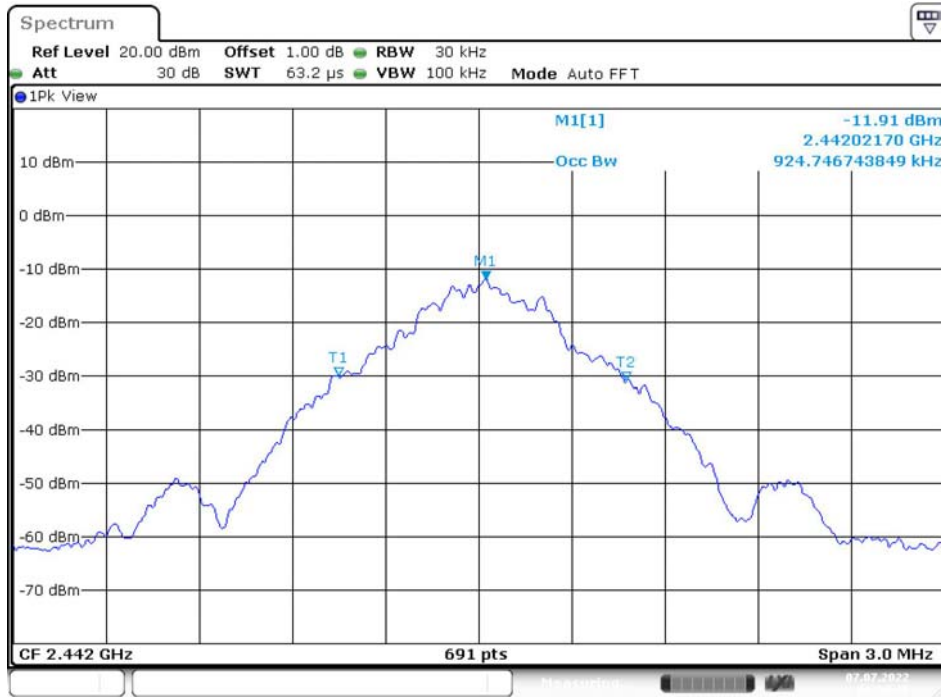

Date: 7.JUL.2022 09:34:47

### High Channel

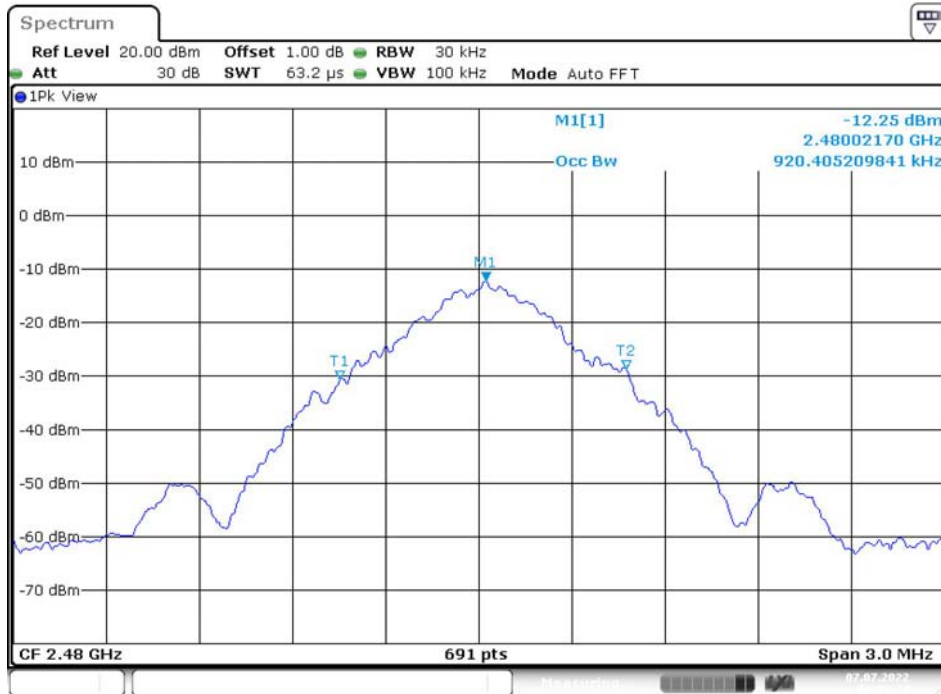

Date: 7.JUL.2022 09:35:24

## 9 FCC §1.1307(b)(3)(i)-RF Exposure

### 9.1 Applicable Standard

According to subpart 15.247(i) and subpart §1.1307(b)(3)(i), systems operating under the provisions of this section shall be operated in a manner that ensures that the public is not exposed to radio frequency energy level in excess of the Commission's guidelines.

For single RF sources (*i.e.*, any single fixed RF source, mobile device, or portable device, as defined in paragraph (b)(2) of this section): A single RF source is exempt if:

(A) The available maximum time-averaged power is no more than 1 mW, regardless of separation distance. This exemption may not be used in conjunction with other exemption criteria other than those in paragraph (b)(3)(ii)(A) of this section. Medical implant devices may only use this exemption and that in paragraph (b)(3)(ii)(A);

(B) Or the available maximum time-averaged power or effective radiated power (ERP), whichever is greater, is less than or equal to the threshold  $P_{th}$  (mW) described in the following formula. This method shall only be used at separation distances (cm) from 0.5 centimeters to 40 centimeters and at frequencies from 0.3 GHz to 6 GHz (inclusive).  $P_{th}$  is given by:

$$P_{th} \text{ (mW)} = \begin{cases} ERP_{20 \text{ cm}} (d/20 \text{ cm})^x & d \leq 20 \text{ cm} \\ ERP_{20 \text{ cm}} & 20 \text{ cm} < d \leq 40 \text{ cm} \end{cases}$$

Where

$$x = -\log_{10} \left( \frac{60}{ERP_{20 \text{ cm}} \sqrt{f}} \right) \text{ and } f \text{ is in GHz;}$$

and

$$ERP_{20 \text{ cm}} \text{ (mW)} = \begin{cases} 2040f & 0.3 \text{ GHz} \leq f < 1.5 \text{ GHz} \\ 3060 & 1.5 \text{ GHz} \leq f \leq 6 \text{ GHz} \end{cases}$$

(C) Or using Table 1 and the minimum separation distance (R in meters) from the body of a nearby person for the frequency (f in MHz) at which the source operates, the ERP (watts) is no

more than the calculated value prescribed for that frequency. For the exemption in Table 1 to apply, R must be at least  $\lambda/2\pi$ , where  $\lambda$  is the free-space operating wavelength in meters. If the ERP of a single RF source is not easily obtained, then the available maximum time-averaged power may be used in lieu of ERP if the physical dimensions of the radiating structure(s) do not exceed the electrical length of  $\lambda/4$  or if the antenna gain is less than that of a half-wave dipole (1.64 linear value).

Table 1 to § 1.1307(b)(3)(i)(C) - Single RF Sources Subject to Routine Environmental Evaluation

	RF Source frequency (MHz)	Threshold ERP (watts)
	0.3-1.34	1,920 R <sup>2</sup> .
	1.34-30	3,450 R <sup>2</sup> /f <sup>2</sup> .
Expand	30-300	3.83 R <sup>2</sup> .
Table	300-1,500	0.0128 R <sup>2</sup> f.
	1,500-100,000	19.2R <sup>2</sup> .

**10.2 Calculated Data:**

Calculate the EIRP from the radiated field strength in the far field using Equation

$$EIRP = E_{Meas} + 20\log(d_{Meas}) - 104.7$$

$$EIRP = 88.36 \text{ dB}\mu\text{V/m} - 95.2 = -6.84 \text{ dBm}$$

$$\text{Tune-up power} = -6.5 \text{ dBm}$$

Project info

Band	Freq (MHz)	Tune-up power (dBm)	Distances (mm)	Tune-up power (mW)	ERP (dBm)	ERP (mW)
SRD	2403	-6.5	5	0.22	-8.65	0.14

**Option A**

The available maximum time-averaged power is no more than 1 mW

Band	Freq (MHz)	Result Option A
SRD	2403	exempt

**\*\*\*\*\* END OF REPORT \*\*\*\*\***