



FCC RF Test Report

APPLICANT : Verdegrass LLC
EQUIPMENT : Digital Media Streaming Device
MODEL NAME : EX69VW
FCC ID : 2AJZB-0308
STANDARD : FCC Part 15 Subpart C §15.247
CLASSIFICATION : (DTS) Digital Transmission System

The product was completed on Jul. 19, 2017. We, SPORTON INTERNATIONAL INC., would like to declare that the tested sample has been evaluated in accordance with the test procedures and has been in compliance with the applicable technical standards.

The test results in this report apply exclusively to the tested model / sample. Without written approval of SPORTON INTERNATIONAL INC., the test report shall not be reproduced except in full.

Reviewed by: Joseph Lin / Supervisor

Approved by: Jones Tsai / Manager



SPORTON INTERNATIONAL INC.

No. 52, Hwa Ya 1st Rd., Hwa Ya Technology Park, Kwei-Shan District, Tao Yuan City, Taiwan, R.O.C.

SPORTON INTERNATIONAL INC.

TEL : 886-3-327-3456

FAX : 886-3-328-4978

FCC ID : 2AJZB-0308

Page Number : 1 of 35

Report Issued Date : Aug. 17, 2017

Report Version : Rev. 01

Report Template No.: BU5-FR15CBT4.0 Version 2.0



TABLE OF CONTENTS

SUMMARY OF TEST RESULT 4

1 GENERAL DESCRIPTION..... 5

 1.1 Applicant 5

 1.2 Manufacturer..... 5

 1.3 Product Feature of Equipment Under Test..... 5

 1.4 Modification of EUT 5

 1.5 Testing Location 6

 1.6 Applicable Standards..... 6

2 TEST CONFIGURATION OF EQUIPMENT UNDER TEST..... 7

 2.1 Carrier Frequency Channel 7

 2.2 Descriptions of Test Mode..... 8

 2.3 Test Mode..... 8

 2.4 Connection Diagram of Test System..... 9

 2.5 Support Unit used in test configuration and system 10

 2.6 EUT Operation Test Setup 10

 2.7 Measurement Results Explanation Example..... 10

3 TEST RESULT 11

 3.1 6dB and 99% Bandwidth Measurement 11

 3.2 Peak Output Power Measurement 16

 3.3 Power Spectral Density Measurement 17

 3.4 Conducted Band Edges and Spurious Emission Measurement 22

 3.5 Radiated Band Edges and Spurious Emission Measurement 27

 3.6 AC Conducted Emission Measurement..... 31

 3.7 Antenna Requirements 33

4 LIST OF MEASURING EQUIPMENT..... 34

5 UNCERTAINTY OF EVALUATION..... 35

APPENDIX A. CONDUCTED TEST RESULTS

APPENDIX B. AC CONDUCTED EMISSION TEST RESULT

APPENDIX C. RADIATED SPURIOUS EMISSION

APPENDIX D. RADIATED SPURIOUS EMISSION PLOTS

APPENDIX E. DUTY CYCLE PLOTS



REVISION HISTORY

REPORT NO.	VERSION	DESCRIPTION	ISSUED DATE
FR742534-01B	Rev. 01	Initial issue of report	Aug. 17, 2017



SUMMARY OF TEST RESULT

Report Section	FCC Rule	Description	Limit	Result
3.1	15.247(a)(2)	6dB Bandwidth	$\geq 0.5\text{MHz}$	Pass
3.1	-	99% Bandwidth	-	Pass
3.2	15.247(b)(3)	Peak Output Power	$\leq 30\text{dBm}$	Pass
3.3	15.247(e)	Power Spectral Density	$\leq 8\text{dBm}/3\text{kHz}$	Pass
3.4	15.247(d)	Conducted Band Edges and Spurious Emission	$\leq 20\text{dBc}$	Pass
3.5	15.247(d)	Radiated Band Edges and Spurious Emission	15.209(a) & 15.247(d)	Pass
3.6	15.207	AC Conducted Emission	15.207(a)	Pass
3.7	15.203 & 15.247(b)	Antenna Requirement	N/A	Pass



1 General Description

1.1 Applicant

Verdegrass LLC
233 South 13th Street, Suite 1100, Lincoln, Nebraska 68508

1.2 Manufacturer

Product Feature	
Equipment	Digital Media Streaming Device
Model Name	EX69VW
FCC ID	2AJZB-0308
EUT supports Radios application	WLAN 11a/b/g/n HT20/HT40 WLAN 11ac VHT20/VHT40/VHT80 Bluetooth BR/EDR/LE

1.3 Product Feature of Equipment Under Test

Standards-related Product Specification	
Tx/Rx Frequency Range	2402 MHz ~ 2480 MHz
Number of Channels	40
Carrier Frequency of Each Channel	40 Channel(37 hopping + 3 advertising channel)
Maximum Output Power to Antenna	8.67 dBm (0.0074 W)
99% Occupied Bandwidth	1.054MHz
Antenna Type / Gain	Fixed Internal Antenna type with gain 1.77 dBi
Type of Modulation	Bluetooth LE : GFSK

1.4 Modification of EUT

No modifications are made to the EUT during all test items.



1.5 Testing Location

Sporton Lab is accredited to ISO 17025 by Taiwan Accreditation Foundation (TAF code : 1190) and the FCC designation No. TW0007 under the FCC 2.948(e) by Mutual Recognition Agreement (MRA) in FCC Test.

Test Site	SPORTON INTERNATIONAL INC.	
Test Site Location	No. 52, Hwa Ya 1 st Rd., Hwa Ya Technology Park, Kwei-Shan District, Tao Yuan City, Taiwan, R.O.C. TEL: +886-3-327-3456 FAX: +886-3-328-4978	
Test Site No.	Sporton Site No.	
	TH05-HY	CO05-HY

Test Site	SPORTON INTERNATIONAL INC.	
Test Site Location	No.58, Aly. 75, Ln. 564, Wenhua 3rd Rd. Guishan Dist, Taoyuan City, Taiwan (R.O.C.) TEL: +886-3-327-0868 FAX: +886-3-327-0855	
Test Site No.	Sporton Site No.	
	03CH12-HY	

Note: The test site complies with ANSI C63.4 2014 requirement.

1.6 Applicable Standards

According to the specifications of the manufacturer, the EUT must comply with the requirements of the following standards:

- ♦ FCC Part 15 Subpart C §15.247
- ♦ FCC KDB Publication No. 558074 D01 DTS Meas. Guidance v04
- ♦ ANSI C63.10-2013

Remark: All test items were verified and recorded according to the standards and without any deviation during the test.



2 Test Configuration of Equipment Under Test

2.1 Carrier Frequency Channel

Frequency Band	Channel	Freq. (MHz)	Channel	Freq. (MHz)
2400-2483.5 MHz	0	2402	21	2444
	1	2404	22	2446
	2	2406	23	2448
	3	2408	24	2450
	4	2410	25	2452
	5	2412	26	2454
	6	2414	27	2456
	7	2416	28	2458
	8	2418	29	2460
	9	2420	30	2462
	10	2422	31	2464
	11	2424	32	2466
	12	2426	33	2468
	13	2428	34	2470
	14	2430	35	2472
	15	2432	36	2474
	16	2434	37	2476
	17	2436	38	2478
	18	2438	39	2480
	19	2440	-	-
20	2442	-	-	



2.2 Descriptions of Test Mode

The RF output power was recorded in the following table:

Channel	Frequency	Bluetooth – LE RF Output Power
		Data Rate / Modulation
		GFSK
		1Mbps
Ch00	2402MHz	8.20 dBm
Ch19	2440MHz	8.67 dBm
Ch39	2480MHz	7.83 dBm

a. The EUT has been associated with peripherals and configuration operated in a manner tended to maximize its emission characteristics in a typical application. Frequency range investigated: conduction emission (150 kHz to 30 MHz), radiation emission (9 kHz to the 10th harmonic of the highest fundamental frequency or to 40 GHz, whichever is lower). For radiated measurement, all the possible configuration was pre-scanned with power adaptor and peripherals (HDMI, USB and IR connector). It was determined that the worst configuration was EUT with adaptor but no peripherals. The final radiated testing was performed with EUT with adaptor but no peripherals.

b. AC power line Conducted Emission was tested under maximum output power.

2.3 Test Mode

The following summary table is showing all test modes to demonstrate in compliance with the standard.

Summary table of Test Cases	
Test Item	Data Rate / Modulation
	Bluetooth – LE / GFSK
Conducted TCs	Mode 1: Bluetooth Tx CH00_2402 MHz_1Mbps Mode 2: Bluetooth Tx CH19_2440 MHz_1Mbps Mode 3: Bluetooth Tx CH39_2480 MHz_1Mbps
Radiated TCs	Mode 1: Bluetooth Tx CH00_2402 MHz_1Mbps Mode 2: Bluetooth Tx CH19_2440 MHz_1Mbps Mode 3: Bluetooth Tx CH39_2480 MHz_1Mbps
AC Conducted Emission	Mode 1: WLAN (2.4GHz) Link + Bluetooth Link + LED On + MPEG4 (Maximum Resolution) + IR On + Adapter

2.4 Connection Diagram of Test System

<Bluetooth - LE Tx Mode >

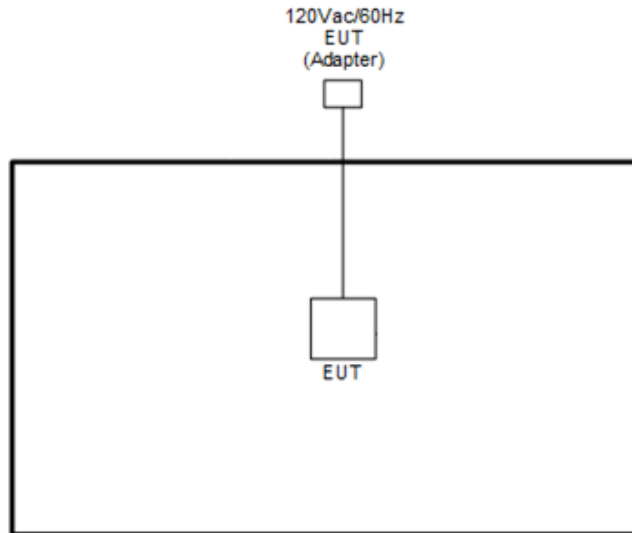

<AC Conducted Emission Mode>

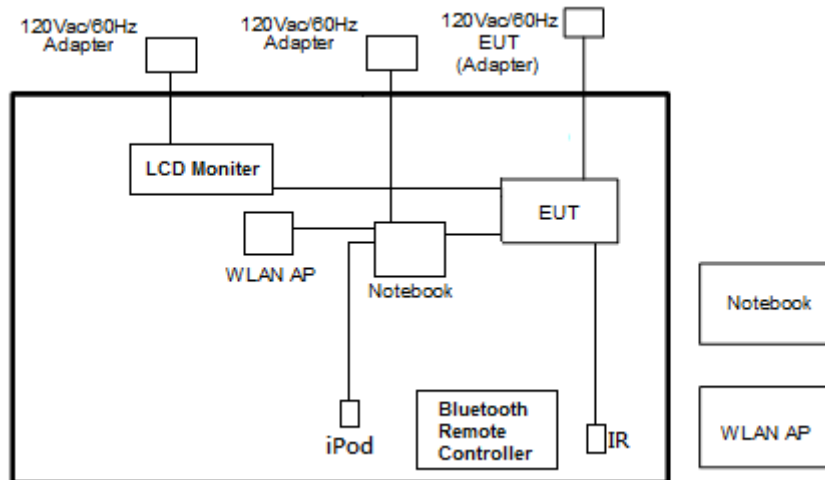



2.5 Support Unit used in test configuration and system

Item	Equipment	Trade Name	Model Name	FCC ID	Data Cable	Power Cord
1.	WLAN AP	ASUS	RT-AC66U	MSQ-RTAC66U	N/A	Unshielded,1.8m
2.	iPod	Apple	A1285	DoC	Shielded, 1.0m	N/A
3.	NOTE BOOK	DELL	E5570	FCC DoC	N/A	AC I/P: Unshielded, 1.2 m DC O/P: Shielded, 1.8 m
4.	NOTE BOOK	DELL	Latitude E6320	FCC DoC	N/A	AC I/P: Unshielded, 1.2 m DC O/P: Shielded, 1.8 m
5.	LCD MONITOR	SONY	KD-55X850D	FCC DoC	Shielded, 1.6m	Unshielded,1.8m
6.	Base Station	R&S	CBT32	N/A		

2.6 EUT Operation Test Setup

The RF test items, programmed RF utility, "CMD" installed in the notebook make the EUT provide functions like channel selection and power level for continuous transmitting and receiving signals.

2.7 Measurement Results Explanation Example

For all conducted test items:

The offset level is set in the spectrum analyzer to compensate the RF cable loss and attenuator factor between EUT conducted output port and spectrum analyzer. With the offset compensation, the spectrum analyzer reading level is exactly the EUT RF output level.

Example :

The spectrum analyzer offset is derived from RF cable loss and attenuator factor.

Offset = RF cable loss + attenuator factor.

Following shows an offset computation example with cable loss 4.2 dB and 10dB attenuator.

$$\begin{aligned}
 \text{Offset(dB)} &= \text{RF cable loss(dB)} + \text{attenuator factor(dB)}. \\
 &= 4.2 + 10 = 14.2 \text{ (dB)}
 \end{aligned}$$

3 Test Result

3.1 6dB and 99% Bandwidth Measurement

3.1.1 Limit of 6dB and 99% Bandwidth

The minimum 6 dB bandwidth shall be at least 500 kHz.

3.1.2 Measuring Instruments

The section 4.0 of List of Measuring Equipment of this test report is used for test.

3.1.3 Test Procedures

1. The testing follows FCC KDB Publication No. 558074 D01 DTS Meas. Guidance v04.
2. The RF output of EUT was connected to the spectrum analyzer by RF cable and attenuator. The path loss was compensated to the results for each measurement.
3. Set to the maximum power setting and enable the EUT transmit continuously.
4. Make the measurement with the spectrum analyzer's resolution bandwidth (RBW) = 100 kHz. Set the Video bandwidth (VBW) = 300 kHz. In order to make an accurate measurement. The 6 dB bandwidth must be greater than 500 kHz.
5. For 99% Bandwidth Measurement, the spectrum analyzer's resolution bandwidth (RBW) is set 30kHz and set the Video bandwidth (VBW) = 100kHz.
6. Measure and record the results in the test report.

3.1.4 Test Setup





3.1.5 Test Result of 6dB Bandwidth

Please refer to Appendix A.

6 dB Bandwidth Plot on Channel 00

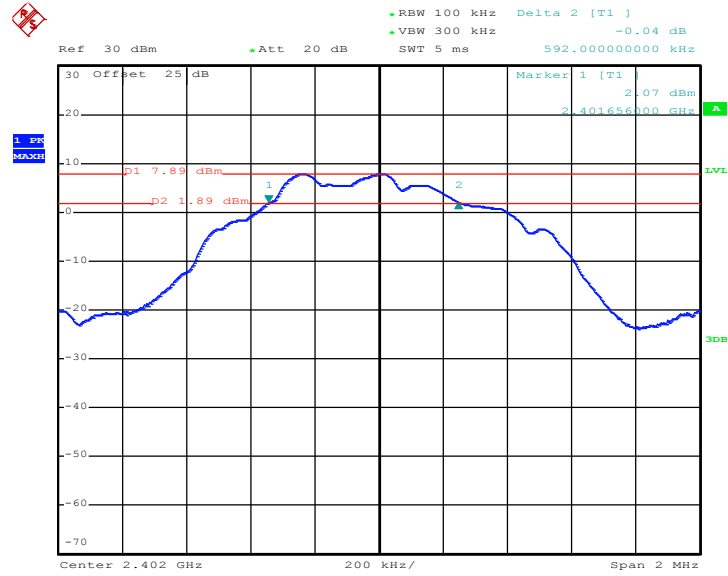

Date: 8.JUL.2017 15:52:36



6 dB Bandwidth Plot on Channel 19

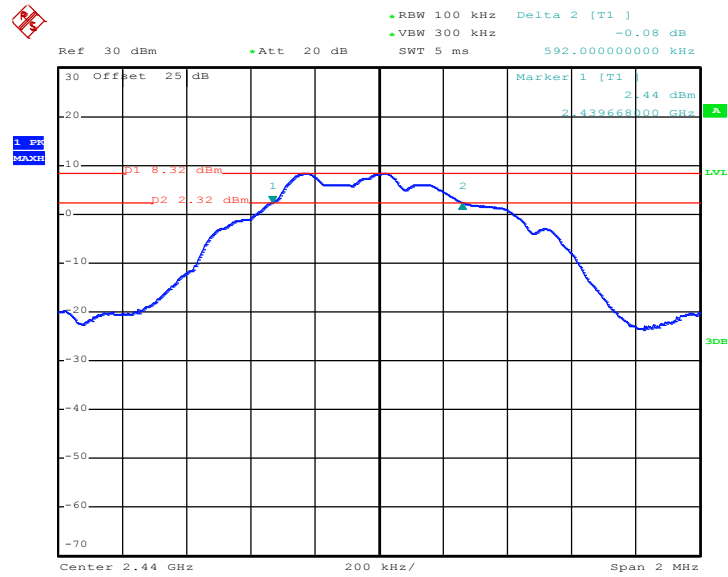

Date: 8.JUL.2017 15:56:28

6 dB Bandwidth Plot on Channel 39

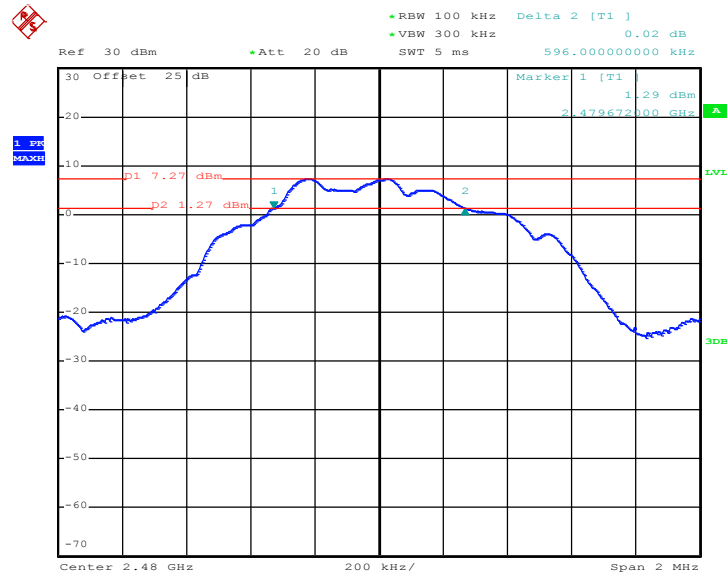

Date: 8.JUL.2017 15:59:57



3.1.6 Test Result of 99% Occupied Bandwidth

Please refer to Appendix A.

99% Bandwidth Plot on Channel 00

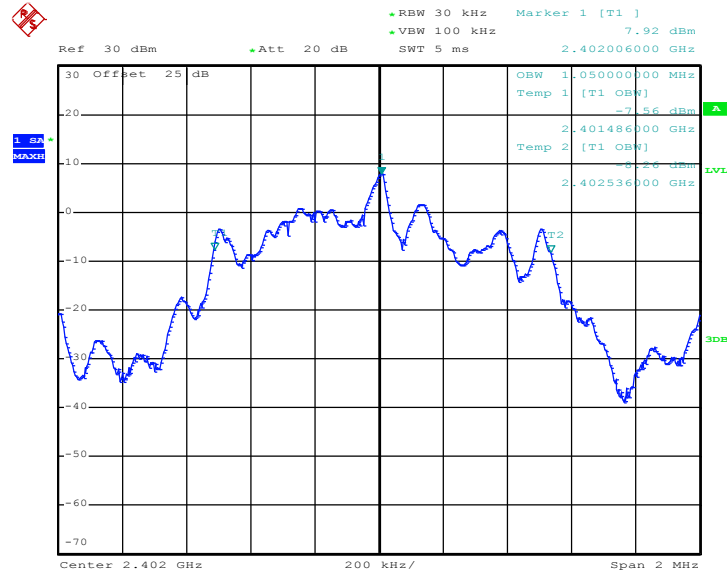

Date: 8.JUL.2017 15:54:09



99% Occupied Bandwidth Plot on Channel 19

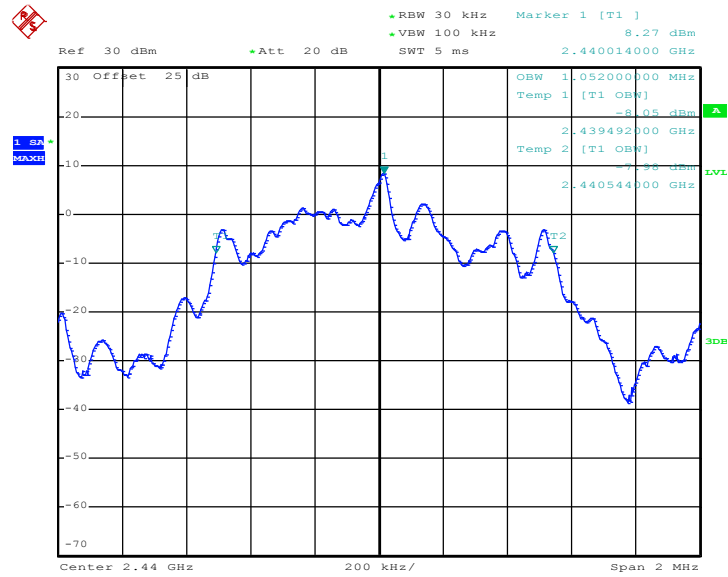

Date: 8.JUL.2017 15:58:32

99% Occupied Bandwidth Plot on Channel 39

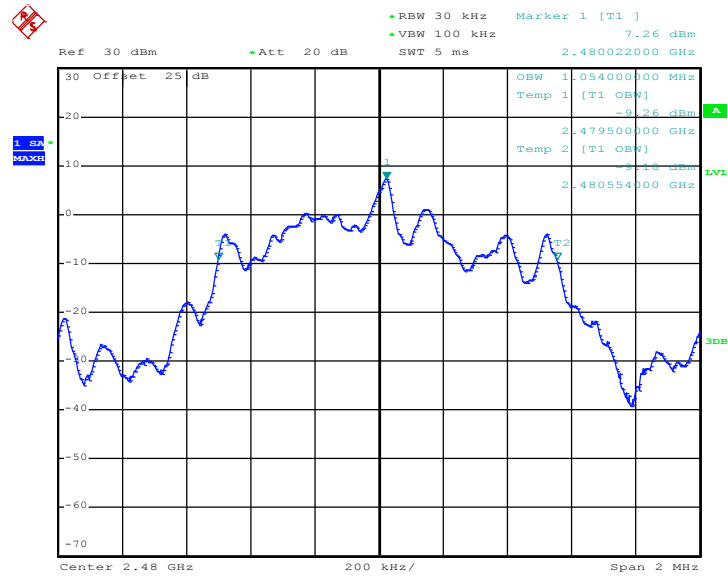

Date: 8.JUL.2017 16:02:00

Note : The occupied channel bandwidth is maintained within the band of operation for all of the modulations.

3.2 Peak Output Power Measurement

3.2.1 Limit of Peak Output Power

For systems using digital modulation in the 2400-2483.5MHz, the limit for peak output power is 30dBm. If transmitting antenna of directional gain greater than 6dBi is used, the peak output power from the intentional radiator shall be reduced below the above stated value by the amount in dB that the directional gain of the antenna exceeds 6 dBi. In case of point-to-point operation, the limit has to be reduced by 1dB for every 3dB that the directional gain of the antenna exceeds 6dBi.

3.2.2 Measuring Instruments

The section 4.0 of List of Measuring Equipment of this test report is used for test.

3.2.3 Test Procedures

1. The testing follows the Measurement Procedure of FCC KDB No. 558074 DTS D01 Meas. Guidance v04 section 9.1.3 PKPM1 Peak power meter method.
2. The RF output of EUT was connected to the power meter by RF cable and attenuator. The path loss was compensated to the results for each measurement.
3. Set to the maximum power setting and enable the EUT transmit continuously.
4. Measure the conducted output power and record the results in the test report.

3.2.4 Test Setup

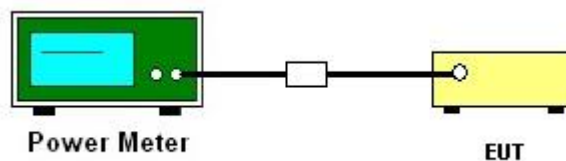

3.2.5 Test Result of Peak Output Power

Please refer to Appendix A.

3.3 Power Spectral Density Measurement

3.3.1 Limit of Power Spectral Density

The peak power spectral density shall not be greater than 8dBm in any 3kHz band at any time interval of continuous transmission.

3.3.2 Measuring Instruments

The section 4.0 of List of Measuring Equipment of this test report is used for test.

3.3.3 Test Procedures

1. The testing follows Measurement Procedure 10.2 Method PKPSD of FCC KDB Publication No. 558074 D01 DTS Meas. Guidance v04
2. The RF output of EUT was connected to the spectrum analyzer by RF cable and attenuator. The path loss was compensated to the results for each measurement.
3. Set to the maximum power setting and enable the EUT transmit continuously.
4. Make the measurement with the spectrum analyzer's resolution bandwidth (RBW) = 3 kHz. Video bandwidth VBW = 10 kHz In order to make an accurate measurement, set the span to 1.5 times DTS Channel Bandwidth. (6dB BW)
5. Detector = peak, Sweep time = auto couple, Trace mode = max hold, Allow trace to fully stabilize. Use the peak marker function to determine the maximum power level.
6. Measure and record the results in the test report.
7. The Measured power density (dBm)/ 100kHz is a reference level and used as 20dBc down limit line for Conducted Band Edges and Conducted Spurious Emission.

3.3.4 Test Setup

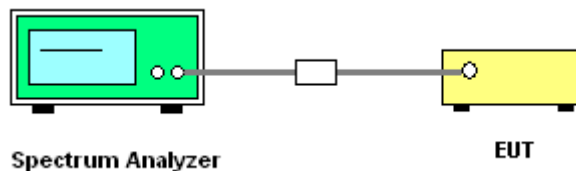



3.3.5 Test Result of Power Spectral Density

Please refer to Appendix A.

3.3.6 Test Result of Power Spectral Density Plots (100kHz)

PSD 100kHz Plot on Channel 00

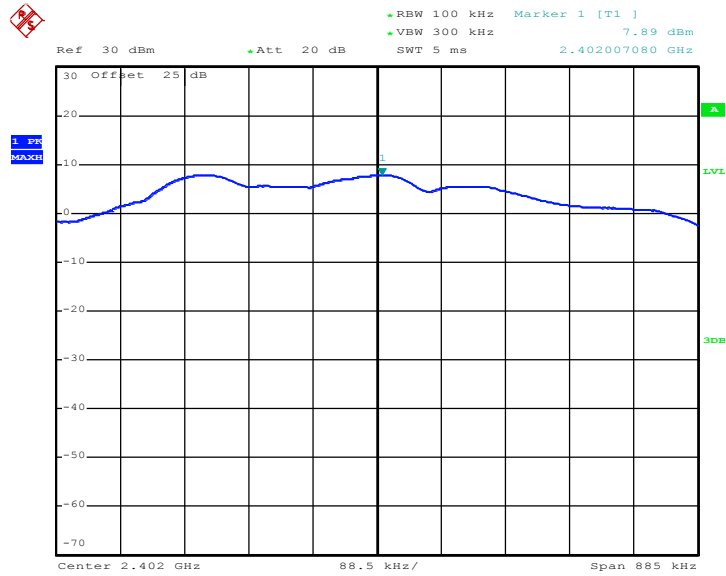

Date: 8.JUL.2017 15:53:17



PSD 100kHz Plot on Channel 19

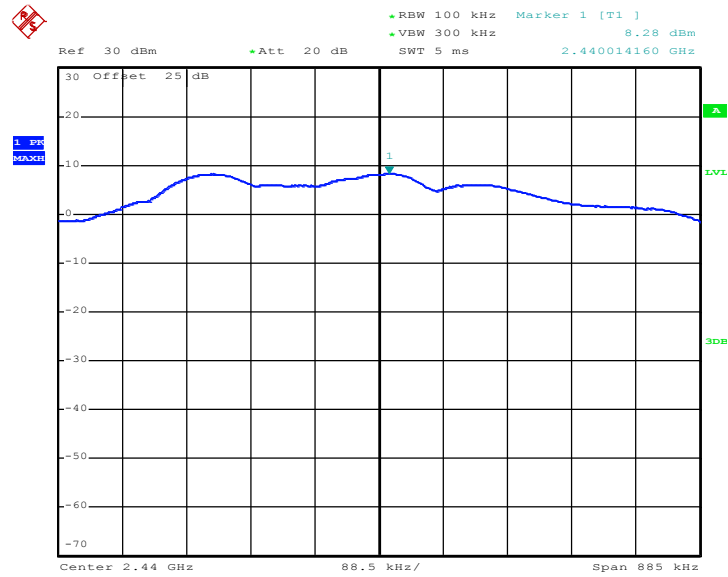

Date: 8.JUL.2017 15:57:34

PSD 100kHz Plot on Channel 39

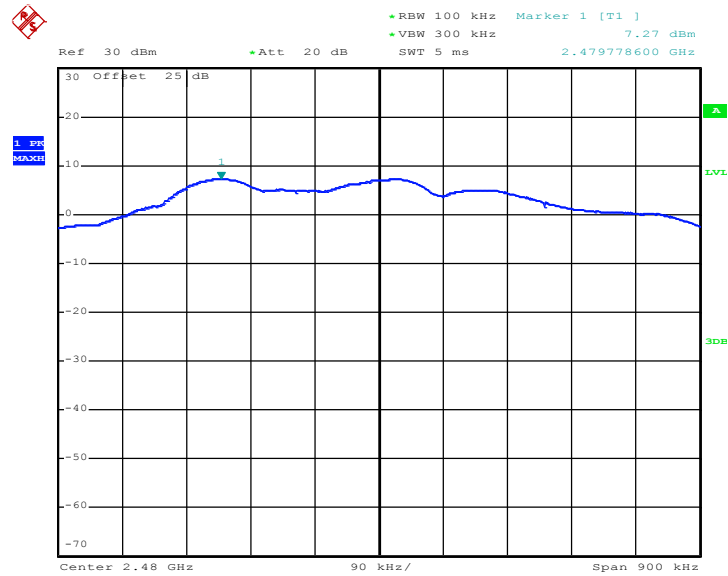

Date: 8.JUL.2017 16:00:31



3.3.7 Test Result of Power Spectral Density Plots (3kHz)

PSD 3kHz Plot on Channel 00

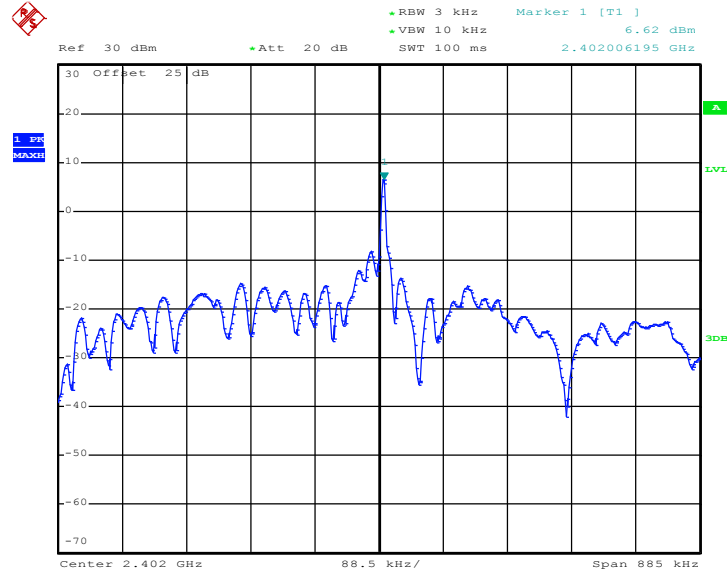

Date: 8.JUL.2017 16:09:39



PSD 3kHz Plot on Channel 19

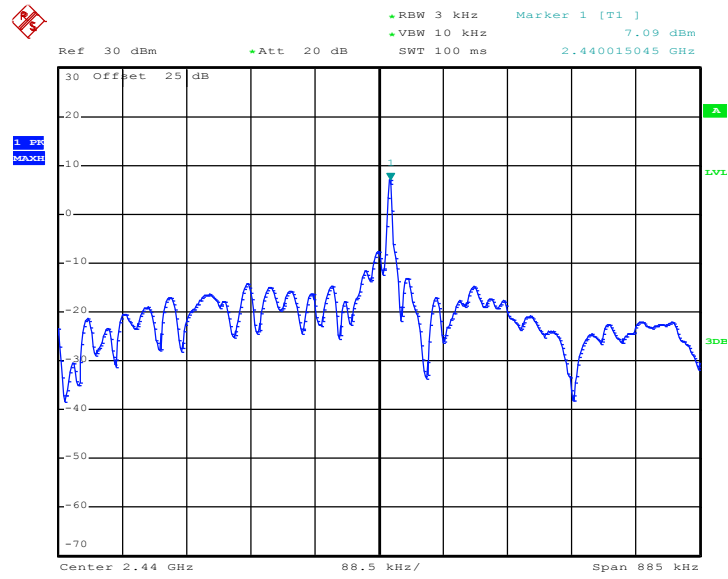

Date: 8.JUL.2017 15:57:06

PSD 3kHz Plot on Channel 39

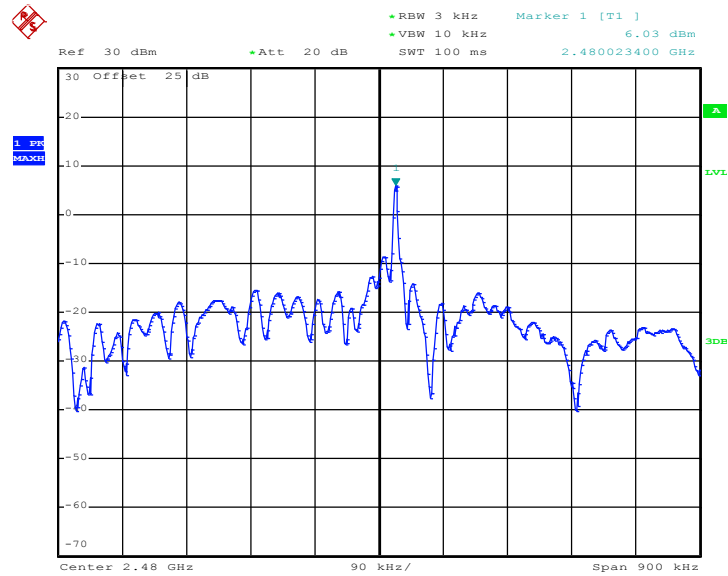

Date: 8.JUL.2017 16:00:13

3.4 Conducted Band Edges and Spurious Emission Measurement

3.4.1 Limit of Conducted Band Edges and Spurious Emission

All harmonics/spurious must be at least 20 dB down from the highest emission level within the authorized band.

3.4.2 Measuring Instruments

The section 4.0 of List of Measuring Equipment of this test report is used for test.

3.4.3 Test Procedure

1. The testing follows FCC KDB Publication No. 558074 D01 DTS Meas. Guidance v04.
2. The RF output of EUT was connected to the spectrum analyzer by RF cable and attenuator. The path loss was compensated to the results for each measurement.
3. Set to the maximum power setting and enable the EUT transmit continuously.
4. Set RBW = 100 kHz, VBW=300 kHz, Peak Detector. Unwanted Emissions measured in any 100 kHz bandwidth outside of the authorized frequency band shall be attenuated by at least 20 dB relative to the maximum in-band peak PSD level in 100 kHz when maximum peak conducted output power procedure is used. If the transmitter complies with the conducted power limits based on the use of RMS averaging over a time interval, the attenuation required under this paragraph shall be 30 dB instead of 20 dB.
5. Measure and record the results in the test report.
6. The RF fundamental frequency should be excluded against the limit line in the operating frequency band.

3.4.4 Test Setup

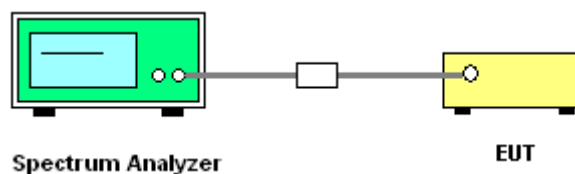



3.4.5 Test Result of Conducted Band Edges Plots

Low Band Edge Plot on Channel 00

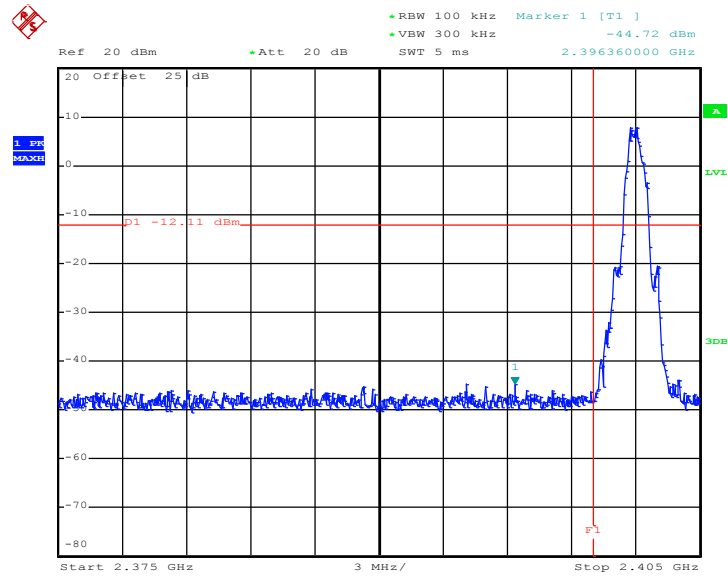

Date: 8.JUL.2017 15:53:27

High Band Edge Plot on Channel 39

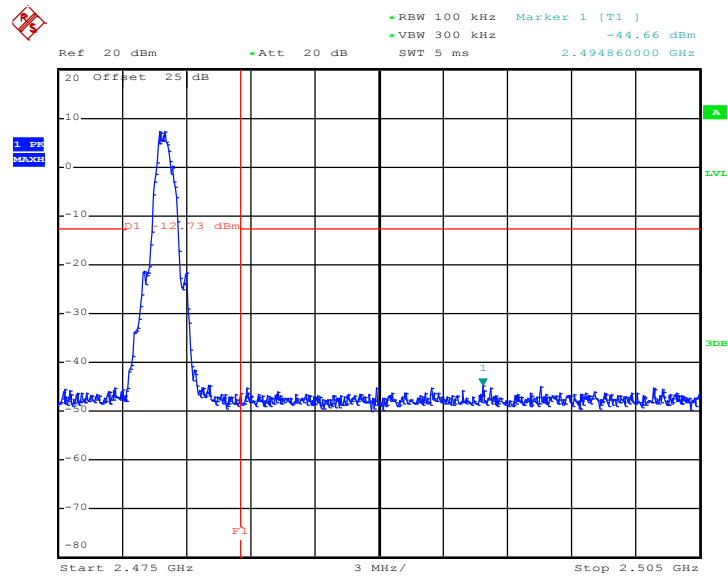

Date: 8.JUL.2017 16:00:53



3.4.6 Test Result of Conducted Spurious Emission Plots

Conducted Spurious Emission Plot on Bluetooth LE 1Mbps GFSK Channel 00

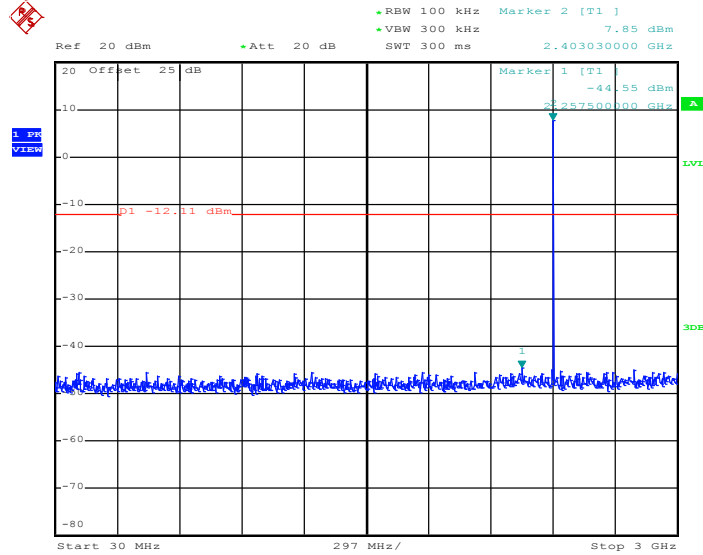

Date: 8.JUL.2017 15:54:20

Conducted Spurious Emission Plot on Bluetooth LE 1Mbps GFSK Channel 00

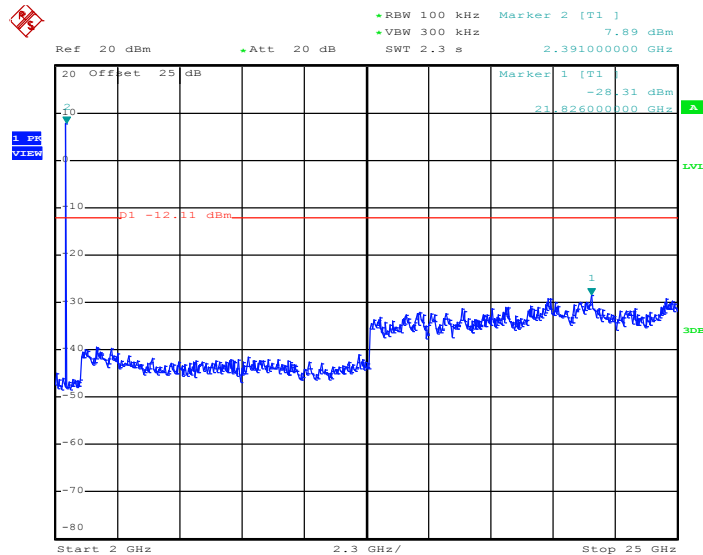

Date: 8.JUL.2017 15:54:28



Conducted Spurious Emission Plot on Bluetooth LE 1Mbps GFSK Channel 19

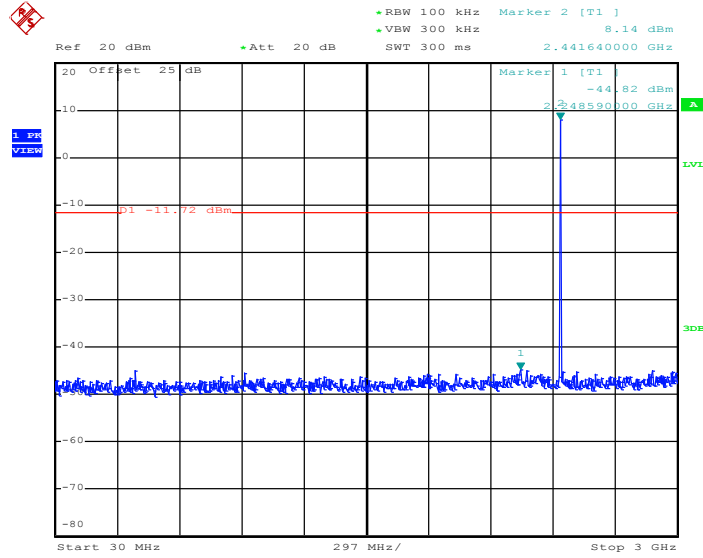

Date: 8.JUL.2017 16:03:37

Conducted Spurious Emission Plot on Bluetooth LE 1Mbps GFSK Channel 19

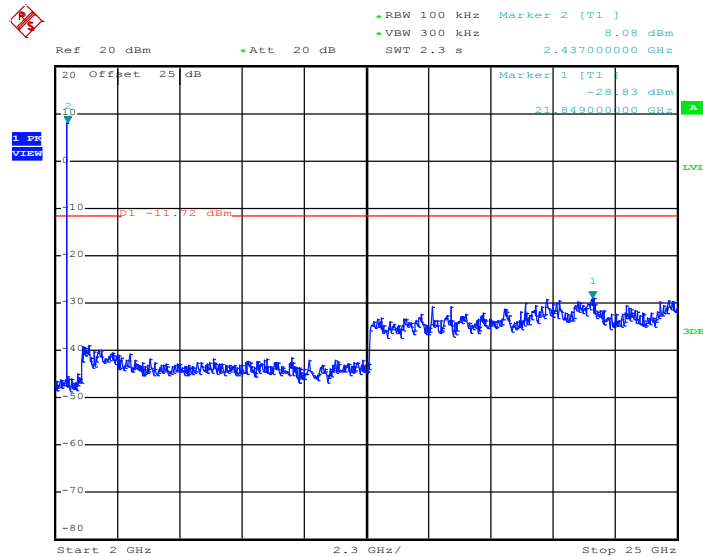

Date: 8.JUL.2017 16:03:46



Conducted Spurious Emission Plot on Bluetooth LE 1Mbps GFSK Channel 39

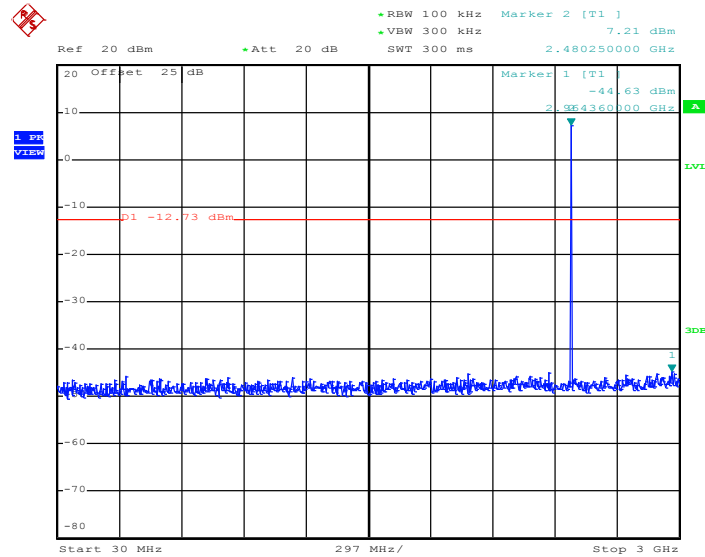

Date: 8.JUL.2017 16:02:12

Conducted Spurious Emission Plot on Bluetooth LE 1Mbps GFSK Channel 39

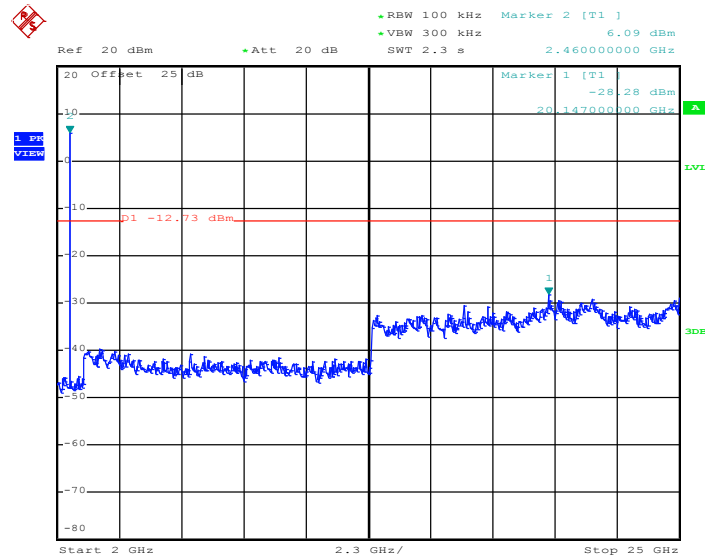

Date: 8.JUL.2017 16:02:20



3.5 Radiated Band Edges and Spurious Emission Measurement

3.5.1 Limit of Radiated Band Edges and Spurious Emission

In any 100 kHz bandwidth outside the intentional radiator frequency band, all harmonics/spurious must be at least 20 dB below the highest emission level within the authorized band. If the output power of this device was measured by spectrum analyzer, the attenuation under this paragraph shall be 30 dB instead of 20 dB. In addition, radiated emissions which fall in the restricted bands must also comply with the limits as below.

Frequency (MHz)	Field Strength (microvolts/meter)	Measurement Distance (meters)
0.009 – 0.490	2400/F(kHz)	300
0.490 – 1.705	24000/F(kHz)	30
1.705 – 30.0	30	30
30 – 88	100	3
88 – 216	150	3
216 - 960	200	3
Above 960	500	3

3.5.2 Measuring Instruments

The section 4.0 of List of Measuring Equipment of this test report is used for test.



3.5.3 Test Procedures

1. The testing follows FCC KDB Publication No. 558074 D01 DTS Meas. Guidance v04.
2. The EUT was arranged to its worst case and then tune the antenna tower (from 1 m to 4 m) and turntable (from 0 degree to 360 degrees) to find the maximum reading. A pre-amp and a high pass filter are used for the test in order to get better signal level.
3. The EUT was placed on a turntable with 0.8 meter for frequency below 1GHz and 1.5 meter for frequency above 1GHz respectively above ground.
4. The EUT was set 3 meters from the interference receiving antenna, which was mounted on the top of a variable height antenna tower.
5. Corrected Reading: Antenna Factor + Cable Loss + Read Level - Preamp Factor = Level
6. For measurement below 1GHz, If the emission level of the EUT measured by the peak detector is 3 dB lower than the applicable limit, the peak emission level will be reported. Otherwise, the emission measurement will be repeated using the quasi-peak detector and reported.
7. Use the following spectrum analyzer settings:
 - (1) Span shall wide enough to fully capture the emission being measured;
 - (2) Set RBW=100 kHz for $f < 1$ GHz; VBW \geq RBW; Sweep = auto; Detector function = peak; Trace = max hold;
 - (3) Set RBW = 1 MHz, VBW= 3MHz for $f \geq 1$ GHz for peak measurement.
For average measurement:
 - VBW = 10 Hz, when duty cycle is no less than 98 percent.
 - VBW $\geq 1/T$, when duty cycle is less than 98 percent where T is the minimum transmission duration over which the transmitter is on and is transmitting at its maximum power control level for the tested mode of operation.

3.5.4 Test Setup

For radiated emissions below 30MHz



For radiated emissions from 30MHz to 1GHz

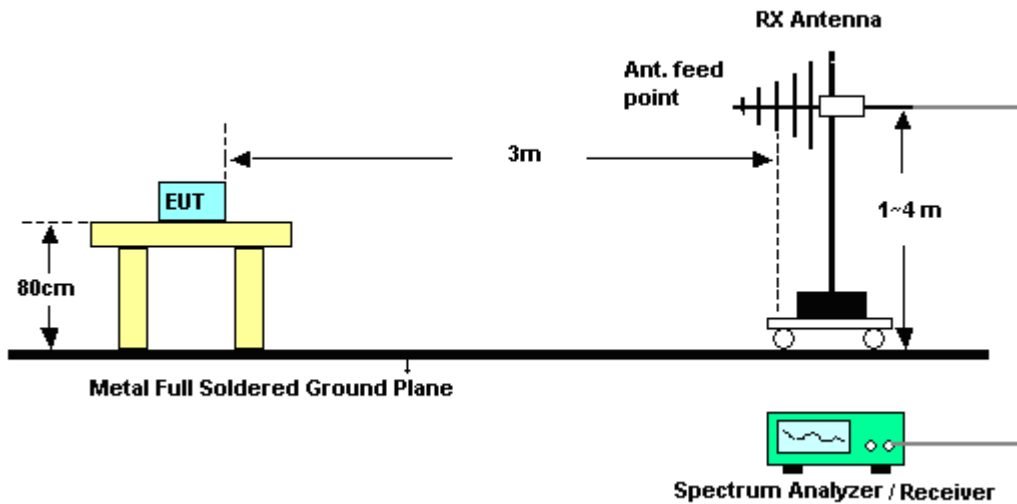

For radiated emissions above 1GHz

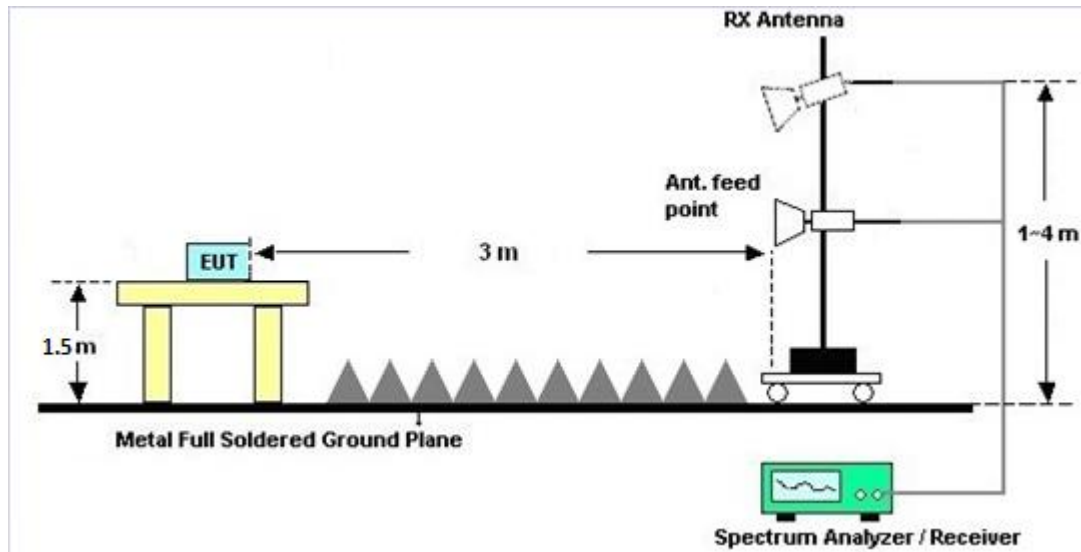

3.5.5 Test Results of Radiated Spurious Emissions (9 kHz ~ 30 MHz)

The low frequency, which started from 9 kHz to 30MHz, was pre-scanned and the result which was 20dB lower than the limit line was not reported.

There is a comparison data of both open-field test site and semi-Anechoic chamber, and the result came out very similar.

3.5.6 Test Result of Radiated Spurious at Band Edges

Please refer to Appendix C and D.

3.5.7 Duty Cycle

Please refer to Appendix E.

3.5.8 Test Result of Radiated Spurious Emission (30MHz ~ 10th Harmonic)

Please refer to Appendix C and D.



3.6 AC Conducted Emission Measurement

3.6.1 Limit of AC Conducted Emission

For equipment that is designed to be connected to the public utility (AC) power line, the radio frequency voltage that is conducted back onto the AC power line on any frequency or frequencies within the band 150 kHz to 30 MHz shall not exceed the limits in the following table.

Frequency of emission (MHz)	Conducted limit (dBµV)	
	Quasi-peak	Average
0.15-0.5	66 to 56*	56 to 46*
0.5-5	56	46
5-30	60	50

*Decreases with the logarithm of the frequency.

3.6.2 Measuring Instruments

The section 4.0 of List of Measuring Equipment of this test report is used for test.

3.6.3 Test Procedures

1. The EUT was placed 0.4 meter from the conducting wall of the shielding room was kept at least 80 centimeters from any other grounded conducting surface.
2. Connect EUT to the power mains through a line impedance stabilization network (LISN).
3. All the support units are connecting to the other LISN.
4. The LISN provides 50 ohm coupling impedance for the measuring instrument.
5. The FCC states that a 50 ohm, 50 microhenry LISN should be used.
6. Both sides of AC line were checked for maximum conducted interference.
7. The frequency range from 150 kHz to 30 MHz was searched.
8. Set the test-receiver system to Peak Detect Function and specified bandwidth (IF Bandwidth = 9kHz) with Maximum Hold Mode. Then measurement is also conducted by Average Detector and Quasi-Peak Detector Function respectively.

3.6.4 Test Setup

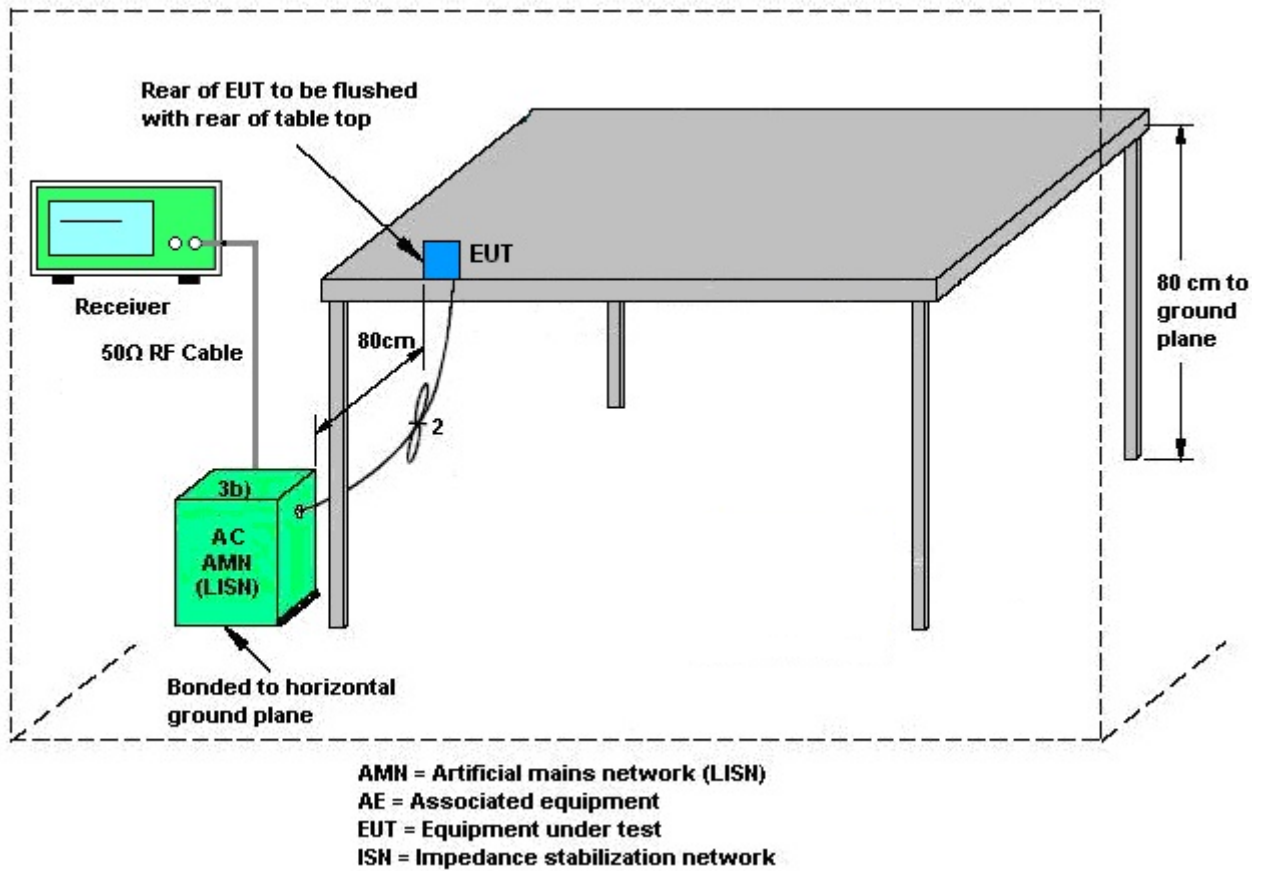

3.6.5 Test Result of AC Conducted Emission

Please refer to Appendix B.



3.7 Antenna Requirements

3.7.1 Standard Applicable

If directional gain of transmitting antennas is greater than 6dBi, the power shall be reduced by the same level in dB comparing to gain minus 6dBi. The use of a permanently attached antenna or of an antenna that uses a unique coupling to the intentional radiator shall be considered sufficient to comply with the rule.

3.7.2 Antenna Anti-Replacement Construction

An embedded-in antenna design is used.

3.7.3 Antenna Gain

The antenna peak gain of EUT is less than 6 dBi. Therefore, it is not necessary to reduce maximum peak output power limit.



4 List of Measuring Equipment

Instrument	Manufacturer	Model No.	Serial No.	Characteristics	Calibration Date	Test Date	Due Date	Remark
Power Meter	Agilent	E4416A	GB412923 44	NA	Dec. 26, 2016	Jul. 06, 2017~ Jul. 08, 2017	Dec. 25, 2017	Conducted (TH05-HY)
Power Sensor	Agilent	E9327A	US404415 48	50MHz~18GHz	Dec. 26, 2016	Jul. 06, 2017~ Jul. 08, 2017	Dec. 25, 2017	Conducted (TH05-HY)
Spectrum Analyzer	Rohde & Schwarz	FSP40	100055	9kHz-40GHz	Jul. 17, 2016	Jul. 06, 2017~ Jul. 08, 2017	Jul. 16, 2017	Conducted (TH05-HY)
AC Power Source	ChainTek	APC-1000W	N/A	N/A	N/A	Jul. 07, 2017	N/A	Conduction (CO05-HY)
EMI Test Receiver	Rohde & Schwarz	ESCI 7	100724	9kHz~7GHz	Aug. 30, 2016	Jul. 07, 2017	Aug. 29, 2017	Conduction (CO05-HY)
LISN	Rohde & Schwarz	ENV216	100080	9kHz~30MHz	Nov. 29, 2016	Jul. 07, 2017	Nov. 28, 2017	Conduction (CO05-HY)
LISN	Rohde & Schwarz	ENV216	100081	9kHz~30MHz	Dec. 06, 2016	Jul. 07, 2017	Dec. 05, 2017	Conduction (CO05-HY)
Spectrum Analyzer	Keysight	N9010A	MY553705 26	N/A	Mar. 15, 2017	Jul. 07, 2017 ~ Jul. 19, 2017	Mar. 14, 2018	Radiation (03CH13-HY)
EMI Test Receiver	Agilent	N9038A(MXE)	MY532900 53	20Hz to 26.5GHz	Jan. 12, 2017	Jul. 07, 2017 ~ Jul. 19, 2017	Jan. 11, 2018	Radiation (03CH13-HY)
Loop Antenna	Rohde & Schwarz	HFH2-Z2	100315	9 kHz~30 MHz	May 15, 2017	Jul. 07, 2017 ~ Jul. 19, 2017	May 14, 2019	Radiation (03CH13-HY)
Bilog Antenna	TESEQ	CBL 6111D&00800 N1D01N-06	40103&04	30MHz to 1GHz	Jan. 07, 2017	Jul. 07, 2017 ~ Jul. 19, 2017	Jan. 06, 2018	Radiation (03CH13-HY)
Horn Antenna	SCHWARZBECK	BBHA 9120 D	9120D-124 1	1GHz ~ 18GHz	May 02, 2017	Jul. 07, 2017 ~ Jul. 19, 2017	May 01, 2018	Radiation (03CH13-HY)
SHF-EHF Horn Antenna	SCHWARZBECK	BBHA 9170	BBHA9170 584	18GHz- 40GHz	Nov. 08, 2016	Jul. 07, 2017 ~ Jul. 19, 2017	Nov. 07, 2017	Radiation (03CH13-HY)
Amplifier	Sonoma-Instrument	310 N	187282	9KHz~1GHz	Dec. 21, 2016	Jul. 07, 2017 ~ Jul. 19, 2017	Dec. 20, 2017	Radiation (03CH13-HY)
Preamplifier	Keysight	83017A	MY532701 47	1GHz~26.5GHz	Jan. 09, 2017	Jul. 07, 2017 ~ Jul. 19, 2017	Jan. 08, 2018	Radiation (03CH13-HY)
Preamplifier	MITEQ	AMF-7D-0010 1800-30-10P	1590074	1GHz~18GHz	May 22, 2017	Jul. 07, 2017 ~ Jul. 19, 2017	May 21, 2018	Radiation (03CH13-HY)
Preamplifier	MITEQ	TTA 1840-35-HG	1887435	18GHz ~ 40GHz	Oct. 13, 2016	Jul. 07, 2017 ~ Jul. 19, 2017	Oct. 12, 2017	Radiation (03CH13-HY)
Antenna Mast	EMEC	AM-BS-4500- B	N/A	1m~4m	N/A	Jul. 07, 2017 ~ Jul. 19, 2017	N/A	Radiation (03CH13-HY)
Turn Table	EMEC	TT2000	N/A	0~360 Degree	N/A	Jul. 07, 2017 ~ Jul. 19, 2017	N/A	Radiation (03CH13-HY)



5 Uncertainty of Evaluation

Uncertainty of Conducted Emission Measurement (150 kHz ~ 30 MHz)

Measuring Uncertainty for a Level of Confidence of 95% ($U = 2Uc(y)$)	2.70
---	------

Uncertainty of Radiated Emission Measurement (30 MHz ~ 1000 MHz)

Measuring Uncertainty for a Level of Confidence of 95% ($U = 2Uc(y)$)	4.90
---	------

Uncertainty of Radiated Emission Measurement (1000 MHz ~ 18000 MHz)

Measuring Uncertainty for a Level of Confidence of 95% ($U = 2Uc(y)$)	5.40
---	------

Uncertainty of Radiated Emission Measurement (18000 MHz ~ 40000 MHz)

Measuring Uncertainty for a Level of Confidence of 95% ($U = 2Uc(y)$)	4.30
---	------

Appendix A. Test Result of Conducted Test Items

Test Engineer:	Aking chang	Temperature:	21~25	°C
Test Date:	2017/7/6~2017/7/8	Relative Humidity:	51~54	%

TEST RESULTS DATA 6dB and 99% Occupied Bandwidth

Mod.	Data Rate	NTX	CH.	Freq. (MHz)	99% Occupied BW (MHz)	6dB BW (MHz)	6dB BW Limit (MHz)	Pass/Fail
BLE	1Mbps	1	0	2402	1.050	0.592	0.50	Pass
BLE	1Mbps	1	19	2440	1.052	0.592	0.50	Pass
BLE	1Mbps	1	39	2480	1.054	0.596	0.50	Pass

TEST RESULTS DATA Peak Power Table

Mod.	Data Rate	NTX	CH.	Freq. (MHz)	Peak Conducted Power (dBm)	Conducted Power Limit (dBm)	DG (dBi)	EIRP Power (dBm)	EIRP Power Limit (dBm)	Pass /Fail
BLE	1Mbps	1	0	2402	8.20	30.00	1.77	9.97	36.00	Pass
BLE	1Mbps	1	19	2440	8.67	30.00	1.77	10.44	36.00	Pass
BLE	1Mbps	1	39	2480	7.83	30.00	1.77	9.60	36.00	Pass

TEST RESULTS DATA Average Power Table (Reporting Only)

Mod.	Data Rate	NTX	CH.	Freq. (MHz)	Duty Factor (dB)	Average Conducted Power (dBm)
BLE	1Mbps	1	0	2402	2.54	7.97
BLE	1Mbps	1	19	2440	2.54	8.43
BLE	1Mbps	1	39	2480	2.54	7.55

TEST RESULTS DATA Peak Power Density

Mod.	Data Rate	NTX	CH.	Freq. (MHz)	Peak PSD (dBm /100kHz)	Peak PSD (dBm /3kHz)	DG (dBi)	Peak PSD Limit (dBm /3kHz)	Pass/Fail
BLE	1Mbps	1	0	2402	7.89	6.62	1.77	8.00	Pass
BLE	1Mbps	1	19	2440	8.28	7.09	1.77	8.00	Pass
BLE	1Mbps	1	39	2480	7.27	6.03	1.77	8.00	Pass

Note: PSD (dBm/ 100kHz) is a reference level used for Conducted Band Edges and Conducted Spurious Emission 20dBc limit.



Appendix B. AC Conducted Emission Test Results

Test Engineer :	Eric Jeng	Temperature :	22~24°C
		Relative Humidity :	51~53%

EUT Information

Report NO : 742534-01
 Test Mode : Mode 1
 Test Voltage : 120Vac/60Hz
 Phase : Neutral

ENV216 Auto Test FCC Power Bar - N

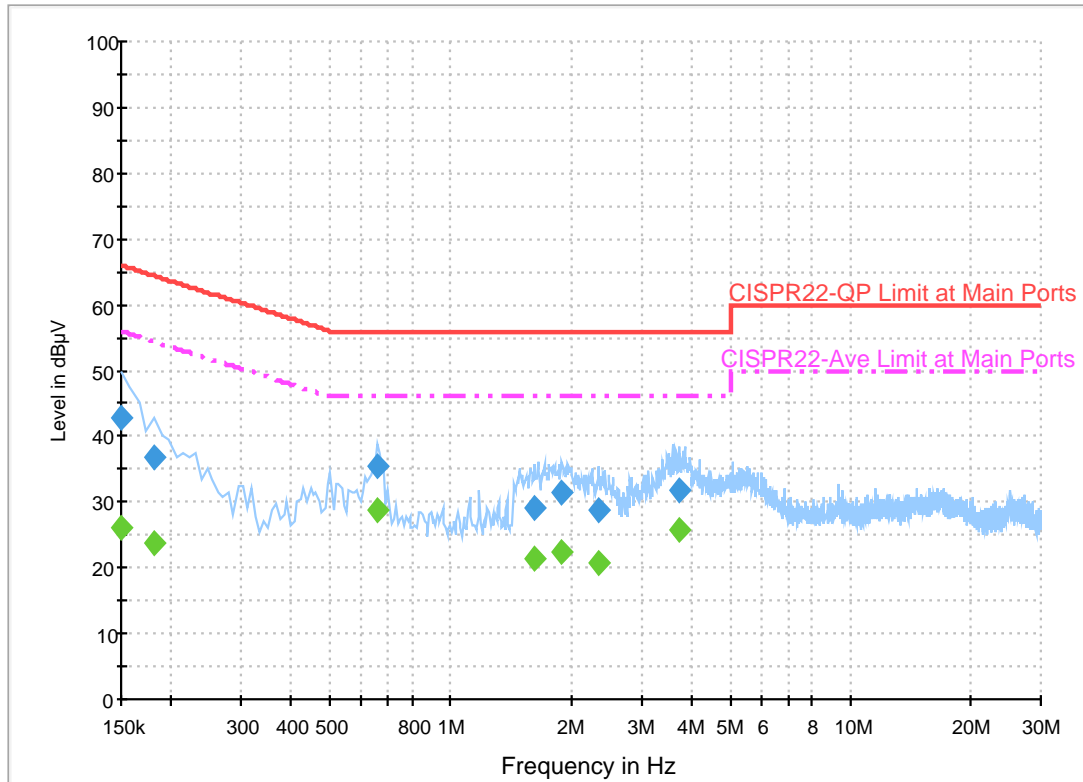

Final Result 1

Frequency (MHz)	QuasiPeak (dBµV)	Filter	Line	Corr. (dB)	Margin (dB)	Limit (dBµV)
0.150000	42.9	Off	N	19.5	23.1	66.0
0.182000	36.7	Off	N	19.5	27.7	64.4
0.654000	35.6	Off	N	19.6	20.4	56.0
1.622000	29.1	Off	N	19.6	26.9	56.0
1.902000	31.4	Off	N	19.6	24.6	56.0
2.350000	28.8	Off	N	19.0	27.2	56.0
3.742000	31.8	Off	N	19.7	24.2	56.0

Final Result 2

Frequency (MHz)	Average (dBµV)	Filter	Line	Corr. (dB)	Margin (dB)	Limit (dBµV)
0.150000	26.2	Off	N	19.5	29.8	56.0
0.182000	23.9	Off	N	19.5	30.5	54.4
0.654000	28.9	Off	N	19.6	17.1	46.0
1.622000	21.5	Off	N	19.6	24.5	46.0
1.902000	22.5	Off	N	19.6	23.5	46.0
2.350000	20.8	Off	N	19.0	25.2	46.0
3.742000	25.6	Off	N	19.7	20.4	46.0

EUT Information

Report NO : 742534-01
 Test Mode : Mode 1
 Test Voltage : 120Vac/60Hz
 Phase : Line

ENV216 Auto Test FCC Power Bar - L

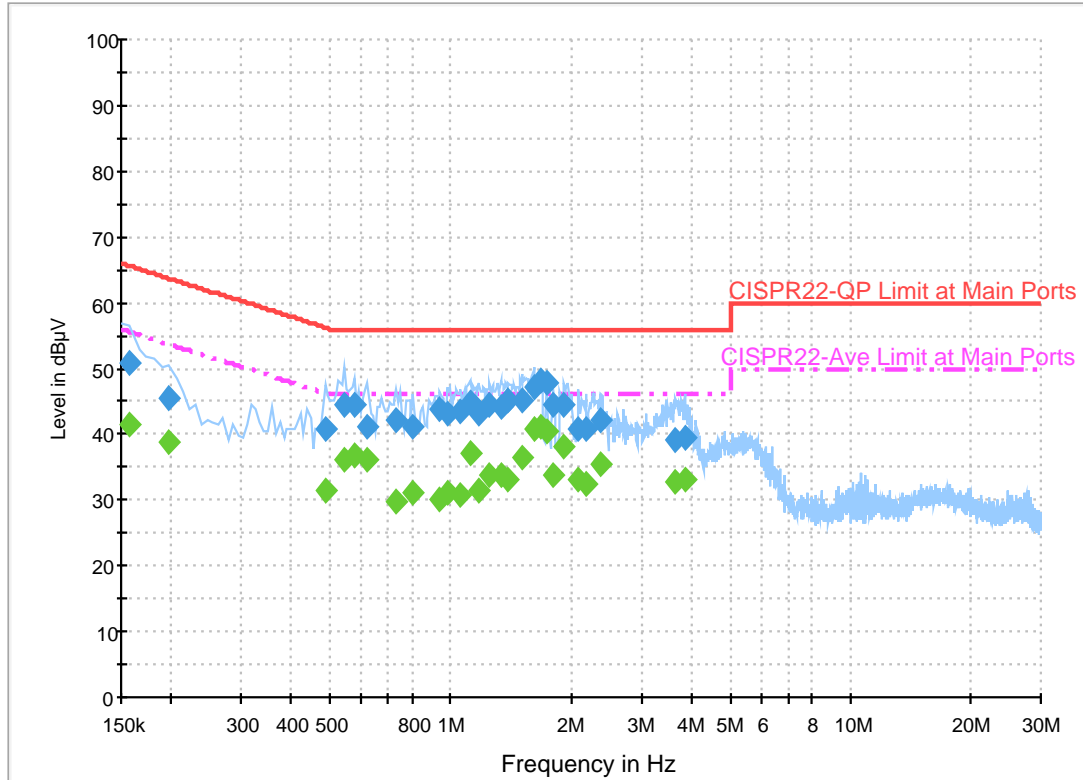

Final Result 1

Frequency (MHz)	QuasiPeak (dBµV)	Filter	Line	Corr. (dB)	Margin (dB)	Limit (dBµV)
0.158000	51.0	Off	L1	19.6	14.6	65.6
0.198000	45.5	Off	L1	19.6	18.2	63.7
0.486000	40.9	Off	L1	19.6	15.3	56.2
0.542000	44.4	Off	L1	19.6	11.6	56.0
0.574000	44.6	Off	L1	19.6	11.4	56.0
0.622000	41.2	Off	L1	19.6	14.8	56.0
0.734000	42.0	Off	L1	19.6	14.0	56.0
0.806000	41.2	Off	L1	19.6	14.8	56.0
0.942000	43.8	Off	L1	19.6	12.2	56.0
0.982000	43.3	Off	L1	19.6	12.7	56.0
1.062000	43.4	Off	L1	19.6	12.6	56.0
1.118000	45.0	Off	L1	19.6	11.0	56.0
1.174000	43.2	Off	L1	19.6	12.8	56.0
1.254000	44.6	Off	L1	19.6	11.4	56.0
1.334000	44.3	Off	L1	19.6	11.7	56.0
1.398000	45.1	Off	L1	19.6	10.9	56.0
1.510000	45.1	Off	L1	19.6	10.9	56.0
1.614000	47.1	Off	L1	19.6	8.9	56.0
1.686000	48.0	Off	L1	19.6	8.0	56.0
1.734000	47.7	Off	L1	19.6	8.3	56.0
1.814000	44.5	Off	L1	19.6	11.5	56.0
1.926000	44.3	Off	L1	19.6	11.7	56.0
2.094000	40.7	Off	L1	18.0	15.3	56.0

Frequency (MHz)	QuasiPeak (dBμV)	Filter	Line	Corr. (dB)	Margin (dB)	Limit (dBμV)
2.190000	40.8	Off	L1	18.5	15.2	56.0
2.366000	42.1	Off	L1	19.0	13.9	56.0
3.662000	39.2	Off	L1	19.7	16.8	56.0
3.854000	39.6	Off	L1	19.7	16.4	56.0

Final Result 2

Frequency (MHz)	Average (dBμV)	Filter	Line	Corr. (dB)	Margin (dB)	Limit (dBμV)
0.158000	41.4	Off	L1	19.6	14.2	55.6
0.198000	38.9	Off	L1	19.6	14.8	53.7
0.486000	31.5	Off	L1	19.6	14.7	46.2
0.542000	36.1	Off	L1	19.6	9.9	46.0
0.574000	37.0	Off	L1	19.6	9.0	46.0
0.622000	36.1	Off	L1	19.6	9.9	46.0
0.734000	29.9	Off	L1	19.6	16.1	46.0
0.806000	31.1	Off	L1	19.6	14.9	46.0
0.942000	30.2	Off	L1	19.6	15.8	46.0
0.982000	31.0	Off	L1	19.6	15.0	46.0
1.062000	30.9	Off	L1	19.6	15.1	46.0
1.118000	37.2	Off	L1	19.6	8.8	46.0
1.174000	31.6	Off	L1	19.6	14.4	46.0
1.254000	33.8	Off	L1	19.6	12.2	46.0
1.334000	33.8	Off	L1	19.6	12.2	46.0
1.398000	33.1	Off	L1	19.6	12.9	46.0
1.510000	36.6	Off	L1	19.6	9.4	46.0
1.614000	40.7	Off	L1	19.6	5.3	46.0
1.686000	41.2	Off	L1	19.6	4.8	46.0
1.734000	40.5	Off	L1	19.6	5.5	46.0
1.814000	33.9	Off	L1	19.6	12.1	46.0
1.926000	38.3	Off	L1	19.6	7.7	46.0
2.094000	33.2	Off	L1	18.0	12.8	46.0
2.190000	32.3	Off	L1	18.5	13.7	46.0
2.366000	35.5	Off	L1	19.0	10.5	46.0
3.662000	32.9	Off	L1	19.7	13.1	46.0
3.854000	33.0	Off	L1	19.7	13.0	46.0



Appendix C. Radiated Spurious Emission

Test Engineer :	Alex Jheng, Bill Chang and Wilson Wu	Temperature :	24.0~24.3°C
		Relative Humidity :	50~52%

2.4GHz 2400~2483.5MHz

BLE (Band Edge @ 3m)

BLE	Note	Frequency (MHz)	Level (dBμV/m)	Over Limit (dB)	Limit Line (dBμV/m)	Read Level (dBμV)	Antenna Factor (dB/m)	Cable Loss (dB)	Preamp Factor (dB)	Ant Pos (cm)	Table Pos (deg)	Peak Avg. (P/A)	Pol. (H/V)
BLE CH 00 2402MHz		2332.575	52.02	-21.98	74	41.19	27.15	4.76	31.01	101	107	P	H
		2382.24	43.02	-10.98	54	31.94	27.31	4.83	30.99	101	107	A	H
	*	2402	104.18	-	-	93.02	27.37	4.85	30.99	101	107	P	H
	*	2402	103.69	-	-	92.53	27.37	4.85	30.99	101	107	A	H
		2383.815	51.66	-22.34	74	40.58	27.31	4.83	30.99	113	23	P	V
		2376.465	42.94	-11.06	54	31.86	27.31	4.83	30.99	113	23	A	V
	*	2402	99.85	-	-	88.69	27.37	4.85	30.99	113	23	P	V
	*	2402	99.36	-	-	88.2	27.37	4.85	30.99	113	23	A	V
BLE CH 19 2440MHz		2389.66	51.89	-22.11	74	40.75	27.37	4.83	30.99	100	106	P	H
		2386.44	43.15	-10.85	54	32.01	27.37	4.83	30.99	100	106	A	H
	*	2440	104.31	-	-	92.94	27.53	4.88	30.97	100	106	P	H
	*	2440	103.76	-	-	92.39	27.53	4.88	30.97	100	106	A	H
		2498.88	53.15	-20.85	74	41.55	27.7	4.93	30.96	100	106	P	H
		2493.91	43.48	-10.52	54	31.88	27.7	4.93	30.96	100	106	A	H
		2385.88	52.22	-21.78	74	41.08	27.37	4.83	30.99	100	23	P	V
		2359.84	43.01	-10.99	54	32.02	27.26	4.8	31	100	23	A	V
	*	2440	100.24	-	-	88.87	27.53	4.88	30.97	100	23	P	V
	*	2440	99.73	-	-	88.36	27.53	4.88	30.97	100	23	A	V
		2485.79	52.64	-21.36	74	41.11	27.64	4.93	30.97	100	23	P	V
		2486.42	43.34	-10.66	54	31.81	27.64	4.93	30.97	100	23	A	V



BLE CH 39 2480MHz	*	2480	101.17	-	-	89.65	27.64	4.92	30.97	105	109	P	H
	*	2480	100.68	-	-	89.16	27.64	4.92	30.97	105	109	A	H
		2492.32	51.92	-22.08	74	40.32	27.7	4.93	30.96	105	109	P	H
		2488.36	42.83	-11.17	54	31.23	27.7	4.93	30.96	105	109	A	H
	*	2480	97.63	-	-	86.11	27.64	4.92	30.97	100	22	P	V
	*	2480	97.07	-	-	85.55	27.64	4.92	30.97	100	22	A	V
		2499.8	52.52	-21.48	74	40.92	27.7	4.93	30.96	100	22	P	V
		2488.8	42.65	-11.35	54	31.05	27.7	4.93	30.96	100	22	A	V
Remark	1. No other spurious found. 2. All results are PASS against Peak and Average limit line.												



2.4GHz 2400~2483.5MHz

BLE (Harmonic @ 3m)

BLE	Note	Frequency (MHz)	Level (dBμV/m)	Over Limit (dB)	Limit Line (dBμV/m)	Read Level (dBμV)	Antenna Factor (dB/m)	Cable Loss (dB)	Preamp Factor (dB)	Ant Pos (cm)	Table Pos (deg)	Peak Avg. (P/A)	Pol. (H/V)
BLE CH 00 2402MHz		4804	41.88	-32.12	74	59.57	31.76	7.3	57.27	100	0	P	H
		4804	39.21	-34.79	74	56.9	31.76	7.3	57.27	100	0	P	V
BLE CH 19 2440MHz		4880	38.82	-35.18	74	56.17	31.88	7.44	57.17	100	0	P	H
		7320	45.04	-28.96	74	55.51	37.22	9.14	57.29	100	0	P	H
		3696	46.57	-27.43	74	67.9	29.32	6.39	57.87	100	0	P	V
		4880	37.98	-36.02	74	55.33	31.88	7.44	57.17	100	0	P	V
BLE CH 39 2480MHz		4960	39.37	-34.63	74	56.3	32.04	7.59	57.05	100	0	P	H
		7440	45.23	-28.77	74	55.44	37.56	9.21	57.44	100	0	P	H
		4960	38.88	-35.12	74	55.81	32.04	7.59	57.05	100	0	P	V
		7440	44.61	-29.39	74	54.82	37.56	9.21	57.44	100	0	P	V
Remark	1. No other spurious found. 2. All results are PASS against Peak and Average limit line.												



Emission below 1GHz

2.4GHz BLE (LF)

BLE	Note	Frequency	Level	Over	Limit	Read	Antenna	Cable	Preamp	Ant	Table	Peak	Pol.
		(MHz)	(dBμV/m)	(dB)	(dBμV/m)	(dBμV)	(dB/m)	(dB)	(dB)	(cm)	(deg)	(P/A)	(H/V)
2.4GHz BLE LF		93.45	32.15	-11.35	43.5	52.8	10.52	1	32.29	-	-	P	H
		133.95	27.24	-16.26	43.5	44.51	13.77	1.19	32.28	-	-	P	H
		283.26	27.96	-18.04	46	42.9	15.46	1.68	32.15	-	-	P	H
		663.3	36.92	-9.08	46	43.13	23.35	2.51	32.18	-	-	P	H
		704.6	37.12	-8.88	46	42.8	23.74	2.64	32.16	100	0	P	H
		757.1	34.35	-11.65	46	38.47	25.17	2.68	32.07	-	-	P	H
		76.98	29.68	-10.32	40	50.75	10.19	0.95	32.3	-	-	P	V
		108.03	27.64	-15.86	43.5	44.49	14.33	1	32.29	-	-	P	V
		281.64	23.61	-22.39	46	38.58	15.44	1.68	32.16	-	-	P	V
		497.4	32.91	-13.09	46	42.01	20.82	2.2	32.2	-	-	P	V
		648.6	33.95	-12.05	46	40.11	23.43	2.48	32.19	-	-	P	V
	711.6	35.61	-10.39	46	40.97	24.05	2.64	32.15	100	0	P	V	
Remark	1. No other spurious found. 2. All results are PASS against limit line.												



Note symbol

*	Fundamental Frequency which can be ignored. However, the level of any unwanted emissions shall not exceed the level of the fundamental frequency.
!	Test result is over limit line.
P/A	Peak or Average
H/V	Horizontal or Vertical



A calculation example for radiated spurious emission is shown as below:

WIFI	Note	Frequency	Level	Over	Limit	Read	Antenna	Cable	Preamp	Ant	Table	Peak	Pol.
Ant.				Limit	Line	Level	Factor	Loss	Factor	Pos	Pos	Avg.	
1+2		(MHz)	(dBμV/m)	(dB)	(dBμV/m)	(dBμV)	(dB/m)	(dB)	(dB)	(cm)	(deg)	(P/A)	(H/V)
802.11b		2390	55.45	-18.55	74	54.51	32.22	4.58	35.86	103	308	P	H
CH 01													
2412MHz		2390	43.54	-10.46	54	42.6	32.22	4.58	35.86	103	308	A	H

- Level(dBμV/m) =
Antenna Factor(dB/m) + Cable Loss(dB) + Read Level(dBμV) - Preamp Factor(dB)
- Over Limit(dB) = Level(dBμV/m) – Limit Line(dBμV/m)

For Peak Limit @ 2390MHz:

- Level(dBμV/m)
= Antenna Factor(dB/m) + Cable Loss(dB) + Read Level(dBμV) - Preamp Factor(dB)
= 32.22(dB/m) + 4.58(dB) + 54.51(dBμV) – 35.86 (dB)
= 55.45 (dBμV/m)
- Over Limit(dB)
= Level(dBμV/m) – Limit Line(dBμV/m)
= 55.45(dBμV/m) – 74(dBμV/m)
= -18.55(dB)

For Average Limit @ 2390MHz:

- Level(dBμV/m)
= Antenna Factor(dB/m) + Cable Loss(dB) + Read Level(dBμV) - Preamp Factor(dB)
= 32.22(dB/m) + 4.58(dB) + 42.6(dBμV) – 35.86 (dB)
= 43.54 (dBμV/m)
- Over Limit(dB)
= Level(dBμV/m) – Limit Line(dBμV/m)
= 43.54(dBμV/m) – 54(dBμV/m)
= -10.46(dB)

Both peak and average measured complies with the limit line, so test result is “PASS”.



Appendix D. Radiated Spurious Emission

Test Engineer :	Alex Jheng, Bill Chang and Wilson Wu	Temperature :	24.0~24.3°C
		Relative Humidity :	50~52%

Note symbol

-L	Low channel location
-R	High channel location



2.4GHz 2400~2483.5MHz

BLE (Band Edge @ 3m)

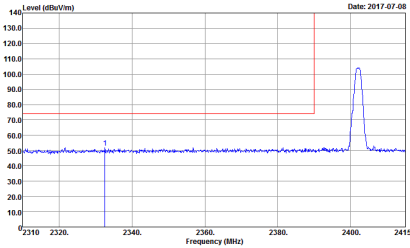
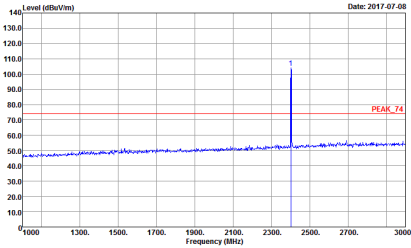
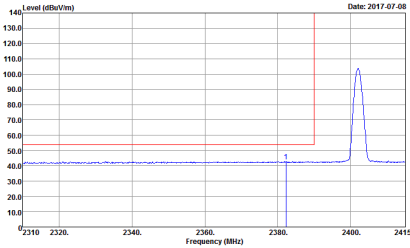
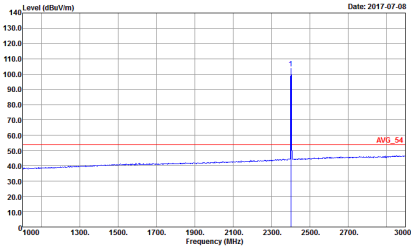
BLE	2.4GHz 2400~2483.5MHz Band Edge @ 3m	
BLE CH00 2402MHz		
Horizontal		Fundamental
Peak	 <p>Level (dBuV/m) vs Frequency (MHz) plot showing a peak at 2402 MHz. Date: 2017-07-08. Site: 03CH13-HY. Condition: PEAK BE 74 3m HORN 9120D 1522 HORIZONTAL.</p>	 <p>Level (dBuV/m) vs Frequency (MHz) plot showing a peak at 2402 MHz. Date: 2017-07-08. Site: 03CH13-HY. Condition: PEAK 74 3m HORN 9120D 1522 HORIZONTAL.</p>
Avg.	 <p>Level (dBuV/m) vs Frequency (MHz) plot showing average level. Date: 2017-07-08. Site: 03CH13-HY. Condition: AVG BE 54 3m HORN 9120D 1522 HORIZONTAL.</p>	 <p>Level (dBuV/m) vs Frequency (MHz) plot showing average level. Date: 2017-07-08. Site: 03CH13-HY. Condition: AVG 54 3m HORN 9120D 1522 HORIZONTAL.</p>

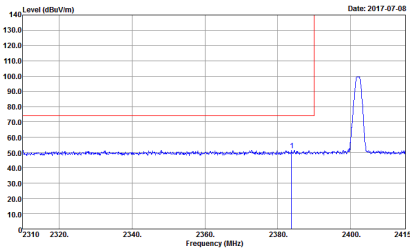
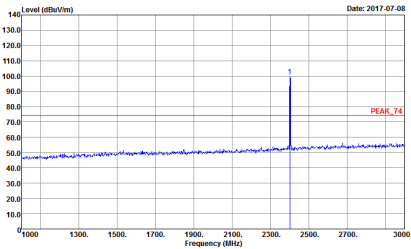
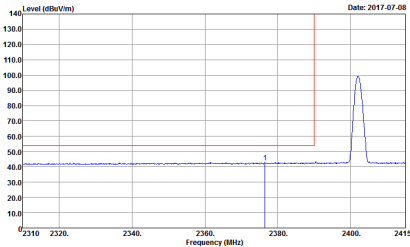
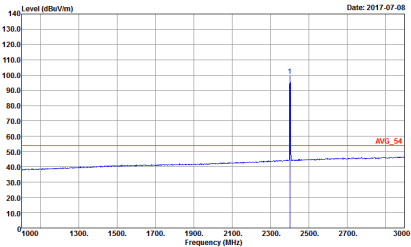

BLE	2.4GHz 2400~2483.5MHz Band Edge @ 3m	
BLE CH00 2402MHz		
	Vertical	Fundamental
Peak	 <p>Level (dBuV/m) vs Frequency (MHz) plot for Vertical Peak. The y-axis ranges from 10.0 to 140.0 dBuV/m, and the x-axis ranges from 2310 to 2415 MHz. A sharp peak is visible at approximately 2402 MHz, reaching a level of about 100 dBuV/m. A red horizontal line is drawn at approximately 75 dBuV/m. The plot is dated 2017-07-08.</p> <p>Site : 03CH13-HY Condition : PEAK BE 74 3m HORN 9120D 1522 VERTICAL</p>	 <p>Level (dBuV/m) vs Frequency (MHz) plot for Fundamental Peak. The y-axis ranges from 10.0 to 140.0 dBuV/m, and the x-axis ranges from 1000 to 3000 MHz. A sharp peak is visible at approximately 2402 MHz, reaching a level of about 100 dBuV/m. A red horizontal line is drawn at approximately 75 dBuV/m, labeled 'PEAK 74'. The plot is dated 2017-07-08.</p> <p>Site : 03CH13-HY Condition : PEAK 74 3m HORN 9120D 1522 VERTICAL</p>
Avg	 <p>Level (dBuV/m) vs Frequency (MHz) plot for Vertical Avg. The y-axis ranges from 10.0 to 140.0 dBuV/m, and the x-axis ranges from 2310 to 2415 MHz. A sharp peak is visible at approximately 2402 MHz, reaching a level of about 100 dBuV/m. A red horizontal line is drawn at approximately 54 dBuV/m. The plot is dated 2017-07-08.</p> <p>Site : 03CH13-HY Condition : AVG BE 54 3m HORN 9120D 1522 VERTICAL</p>	 <p>Level (dBuV/m) vs Frequency (MHz) plot for Fundamental Avg. The y-axis ranges from 10.0 to 140.0 dBuV/m, and the x-axis ranges from 1000 to 3000 MHz. A sharp peak is visible at approximately 2402 MHz, reaching a level of about 100 dBuV/m. A red horizontal line is drawn at approximately 54 dBuV/m, labeled 'AVG 54'. The plot is dated 2017-07-08.</p> <p>Site : 03CH13-HY Condition : AVG 54 3m HORN 9120D 1522 VERTICAL</p>

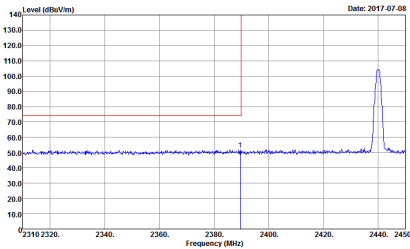
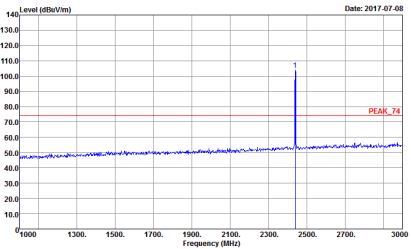
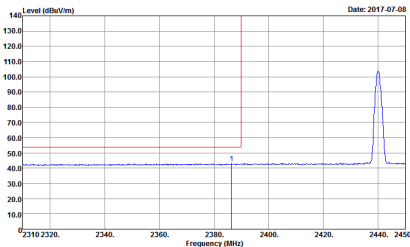
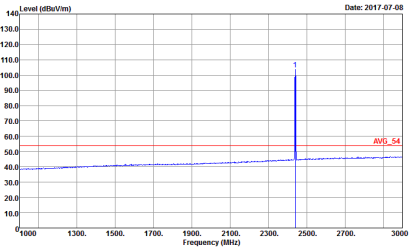

BLE	2.4GHz 2400~2483.5MHz Band Edge @ 3m	
BLE CH19 2440MHz - L		
	Horizontal	Fundamental
Peak	 <p>Level (dBuV/m) vs Frequency (MHz) plot showing a peak at 2440 MHz. Date: 2017-07-08. Site: 03CH13-HY, Condition: PEAK BE 74 3m HORN 9120D 1522 HORIZONTAL.</p>	 <p>Level (dBuV/m) vs Frequency (MHz) plot showing a peak at 2440 MHz. Date: 2017-07-08. Site: 03CH13-HY, Condition: PEAK 74 3m HORN 9120D 1522 HORIZONTAL.</p>
Avg.	 <p>Level (dBuV/m) vs Frequency (MHz) plot showing average level. Date: 2017-07-08. Site: 03CH13-HY, Condition: AVG BE 54 3m HORN 9120D 1522 HORIZONTAL.</p>	 <p>Level (dBuV/m) vs Frequency (MHz) plot showing average level. Date: 2017-07-08. Site: 03CH13-HY, Condition: AVG 54 3m HORN 9120D 1522 HORIZONTAL.</p>

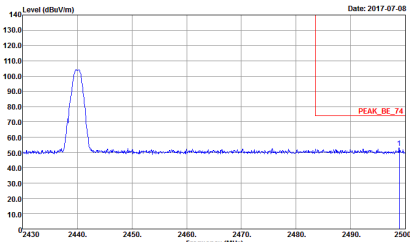
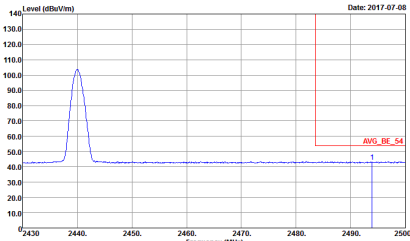

BLE	2.4GHz 2400~2483.5MHz Band Edge @ 3m	
BLE CH19 2440MHz - R		
	Horizontal	Fundamental
Peak	 <p>Site : 03CH13-HY Condition : PEAK BE 74 3m HORN 9120D 1522 HORIZONTAL</p>	Left blank
Avg.	 <p>Site : 03CH13-HY Condition : AVG BE 54 3m HORN 9120D 1522 HORIZONTAL</p>	Left blank

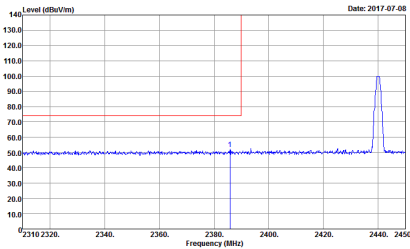
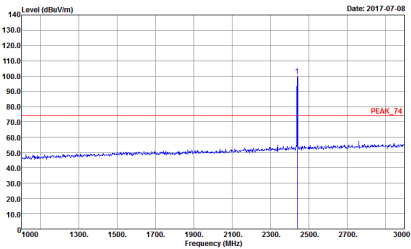
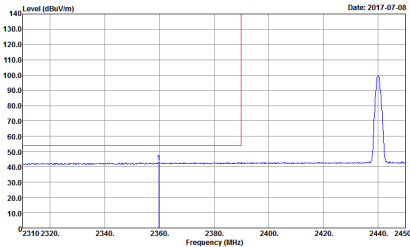
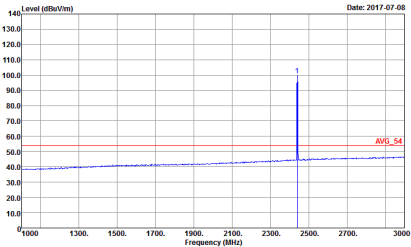

BLE	2.4GHz 2400~2483.5MHz Band Edge @ 3m	
BLE CH19 2440MHz - L		
Vertical		Fundamental
Peak	 <p>Level (dBuV/m) vs Frequency (MHz) plot showing a peak at 2440 MHz. The y-axis ranges from 10.0 to 140.0 dBuV/m, and the x-axis ranges from 2310 to 2450 MHz. A red horizontal line is at approximately 75 dBuV/m. A blue peak is labeled '1' at 2440 MHz.</p> <p>Site : 03CH13-HY Condition : PEAK BE 74 3m HORN 9120D 1522 VERTICAL</p>	 <p>Level (dBuV/m) vs Frequency (MHz) plot showing a peak at 2440 MHz. The y-axis ranges from 10.0 to 140.0 dBuV/m, and the x-axis ranges from 1000 to 3000 MHz. A red horizontal line is at approximately 75 dBuV/m. A blue peak is labeled '1' at 2440 MHz. A red label 'PEAK 74' is present.</p> <p>Site : 03CH13-HY Condition : PEAK 74 3m HORN 9120D 1522 VERTICAL</p>
Avg.	 <p>Level (dBuV/m) vs Frequency (MHz) plot showing an average level. The y-axis ranges from 10.0 to 140.0 dBuV/m, and the x-axis ranges from 2310 to 2450 MHz. A red horizontal line is at approximately 54 dBuV/m. A blue peak is labeled '1' at 2440 MHz.</p> <p>Site : 03CH13-HY Condition : AVG BE 54 3m HORN 9120D 1522 VERTICAL</p>	 <p>Level (dBuV/m) vs Frequency (MHz) plot showing an average level. The y-axis ranges from 10.0 to 140.0 dBuV/m, and the x-axis ranges from 1000 to 3000 MHz. A red horizontal line is at approximately 54 dBuV/m. A blue peak is labeled '1' at 2440 MHz. A red label 'AVG 54' is present.</p> <p>Site : 03CH13-HY Condition : AVG 54 3m HORN 9120D 1522 VERTICAL</p>

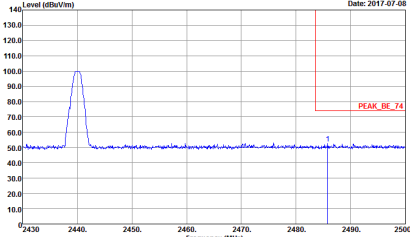
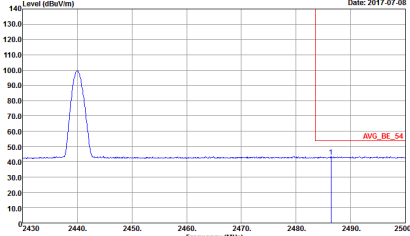

BLE	2.4GHz 2400~2483.5MHz Band Edge @ 3m	
BLE CH19 2440MHz - R		
	Vertical	Fundamental
Peak	 <p>Site : 03CH13-HY Condition : PEAK BE 74 3m HORN 9120D 1522 VERTICAL</p>	Left blank
Avg.	 <p>Site : 03CH13-HY Condition : AVG BE 54 3m HORN 9120D 1522 VERTICAL</p>	Left blank

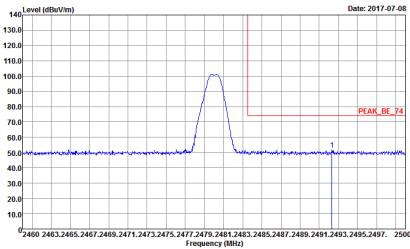
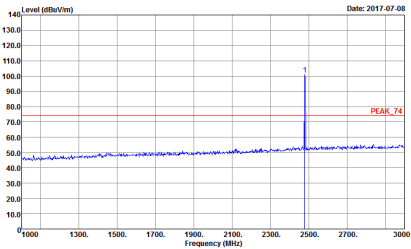
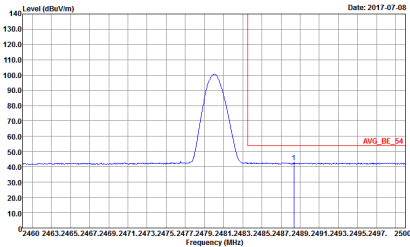
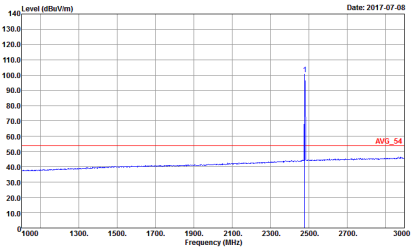

BLE	2.4GHz 2400~2483.5MHz Band Edge @ 3m	
BLE CH39 2480MHz		
	Horizontal	Fundamental
Peak	 <p>Level (dBuV/m) vs Frequency (MHz) plot showing a peak at approximately 2480 MHz. The peak level is around 100 dBuV/m. A red line indicates the peak level at 74 dBuV/m. The x-axis ranges from 2460 to 2500 MHz, and the y-axis ranges from 10.0 to 140.0 dBuV/m.</p> <p>Date: 2017-07-08</p> <p>Site : 03CH13-HY Condition : PEAK BE 74 3m HORN 9120d 1522 HORIZONTAL</p>	 <p>Level (dBuV/m) vs Frequency (MHz) plot showing a peak at approximately 2480 MHz. The peak level is around 100 dBuV/m. A red line indicates the peak level at 74 dBuV/m. The x-axis ranges from 1000 to 3000 MHz, and the y-axis ranges from 10.0 to 140.0 dBuV/m.</p> <p>Date: 2017-07-08</p> <p>Site : 03CH13-HY Condition : PEAK 74 3m HORN 9120d 1522 HORIZONTAL</p>
Avg.	 <p>Level (dBuV/m) vs Frequency (MHz) plot showing the average level across the band. The average level is around 40 dBuV/m. A red line indicates the average level at 54 dBuV/m. The x-axis ranges from 2460 to 2500 MHz, and the y-axis ranges from 10.0 to 140.0 dBuV/m.</p> <p>Date: 2017-07-08</p> <p>Site : 03CH13-HY Condition : AVG BE 54 3m HORN 9120d 1522 HORIZONTAL</p>	 <p>Level (dBuV/m) vs Frequency (MHz) plot showing the average level across the band. The average level is around 40 dBuV/m. A red line indicates the average level at 54 dBuV/m. The x-axis ranges from 1000 to 3000 MHz, and the y-axis ranges from 10.0 to 140.0 dBuV/m.</p> <p>Date: 2017-07-08</p> <p>Site : 03CH13-HY Condition : AVG 54 3m HORN 9120d 1522 HORIZONTAL</p>

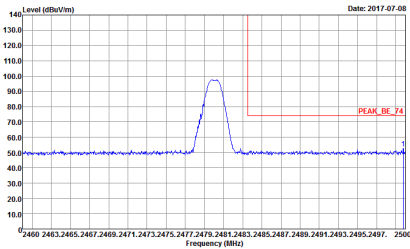
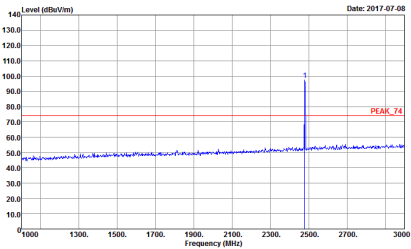
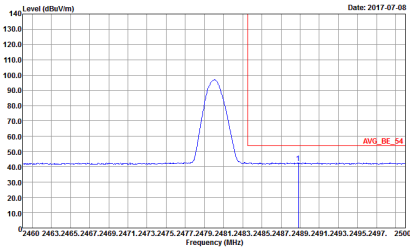
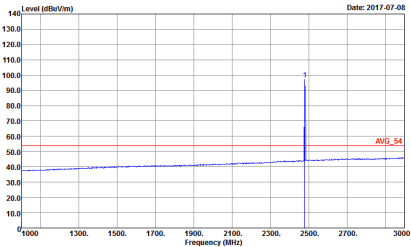

BLE	2.4GHz 2400~2483.5MHz Band Edge @ 3m	
BLE CH39 2480MHz		
Vertical		Fundamental
Peak	 <p>Level (dBuV/m) vs Frequency (MHz) plot showing a peak at 2480 MHz. The y-axis ranges from 10.0 to 140.0 dBuV/m, and the x-axis ranges from 2460 to 2500 MHz. A red line indicates the peak level at approximately 74 dBuV/m.</p> <p>Date: 2017-07-08</p> <p>Site : 03CH13-HY Condition : PEAK BE 74 3m HORN 9120D 1522 VERTICAL</p>	 <p>Level (dBuV/m) vs Frequency (MHz) plot showing a peak at 2480 MHz. The y-axis ranges from 10.0 to 140.0 dBuV/m, and the x-axis ranges from 1000 to 3000 MHz. A red line indicates the peak level at approximately 74 dBuV/m.</p> <p>Date: 2017-07-08</p> <p>Site : 03CH13-HY Condition : PEAK 74 3m HORN 9120D 1522 VERTICAL</p>
Avg.	 <p>Level (dBuV/m) vs Frequency (MHz) plot showing the average level. The y-axis ranges from 10.0 to 140.0 dBuV/m, and the x-axis ranges from 2460 to 2500 MHz. A red line indicates the average level at approximately 54 dBuV/m.</p> <p>Date: 2017-07-08</p> <p>Site : 03CH13-HY Condition : AVG BE 54 3m HORN 9120D 1522 VERTICAL</p>	 <p>Level (dBuV/m) vs Frequency (MHz) plot showing the average level. The y-axis ranges from 10.0 to 140.0 dBuV/m, and the x-axis ranges from 1000 to 3000 MHz. A red line indicates the average level at approximately 54 dBuV/m.</p> <p>Date: 2017-07-08</p> <p>Site : 03CH13-HY Condition : AVG 54 3m HORN 9120D 1522 VERTICAL</p>



2.4GHz 2400~2483.5MHz

BLE (Harmonic @ 3m)

BLE	2.4GHz 2400~2483.5MHz Harmonic @ 3m	
BLE CH00 2402MHz		
Horizontal		Vertical
<p>Peak</p> <p>Avg.</p>	<p>Site : 03CH13-HY Condition : PEAK 74 3m SHF HORN 584 HORIZONTAL</p>	<p>Site : 03CH13-HY Condition : PEAK 74 3m SHF HORN 584 VERTICAL</p>

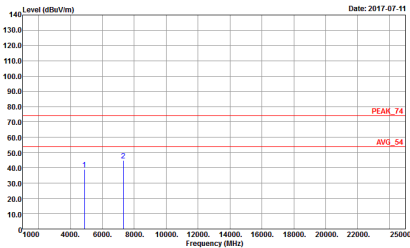
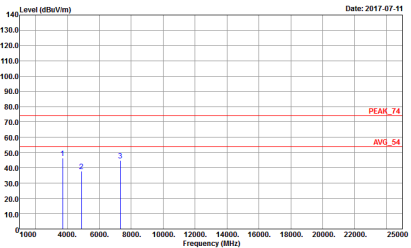

BLE	2.4GHz 2400~2483.5MHz Harmonic @ 3m	
BLE CH19 2440MHz		
	Horizontal	Vertical
Peak Avg.	 <p>Date: 2017-07-11</p> <p>Site : 03CH13-HY Condition : PEAK 74 3m SHF HORN 584 HORIZONTAL</p>	 <p>Date: 2017-07-11</p> <p>Site : 03CH13-HY Condition : PEAK 74 3m SHF HORN 584 VERTICAL</p>

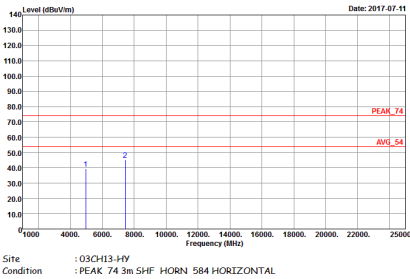
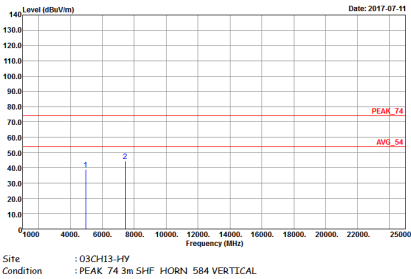

BLE	2.4GHz 2400~2483.5MHz Harmonic @ 3m	
BLE CH39 2480MHz		
	Horizontal	Vertical
Peak	 <p>Date: 2017-07-11</p> <p>Site : 03CH13-HY Condition : PEAK 74 3m SHF HORN 584 HORIZONTAL</p>	 <p>Date: 2017-07-11</p> <p>Site : 03CH13-HY Condition : PEAK 74 3m SHF HORN 584 VERTICAL</p>



Emission below 1GHz

2.4GHz BLE (LF)

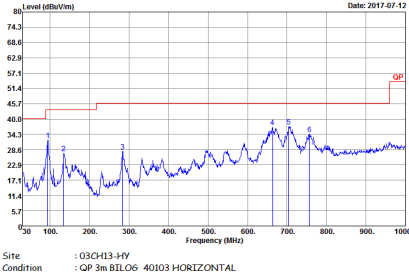
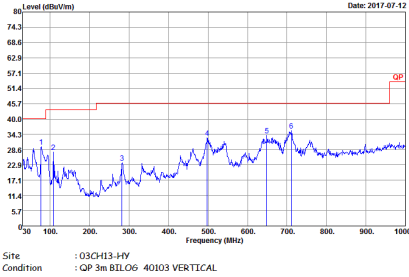
BLE	2.4GHz 2400~2483.5MHz	
BLE LF		
Horizontal		Vertical
QP / Peak	 <p>Site : 03CH13-HY Condition : QP 3m BILOG 40103 HORIZONTAL</p>	 <p>Site : 03CH13-HY Condition : QP 3m BILOG 40103 VERTICAL</p>



Appendix E. Duty Cycle Plots

Band	Duty Cycle(%)	T(us)	1/T(kHz)	VBW Setting
Bluetooth -LE	55.77	348	2.87	3Hz

Bluetooth - LE

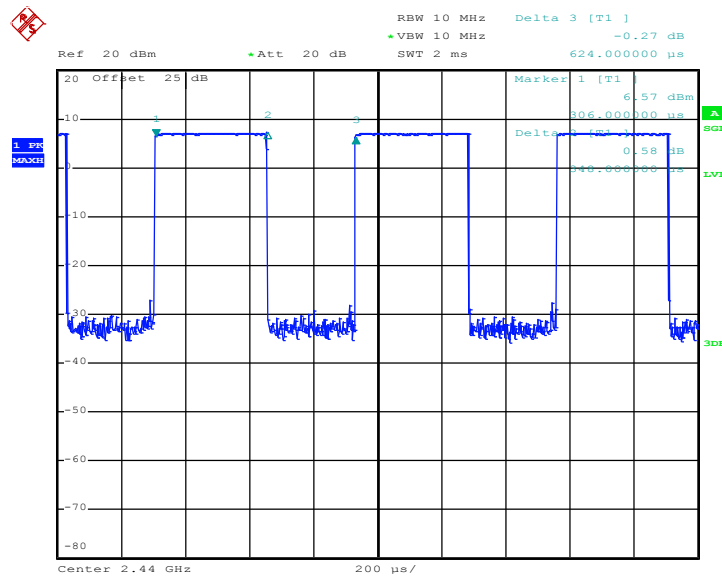

Date: 6.JUL.2017 01:25:46