



FCC RF Test Report

APPLICANT : Verdegrass LLC
EQUIPMENT : Digital Media Streaming Device
MODEL NAME : EX69VW
FCC ID : 2AJZB-0308
STANDARD : FCC Part 15 Subpart C §15.247
CLASSIFICATION : (DSS) Spread Spectrum Transmitter

The product was completed on Jul. 19, 2017. We, SPORTON INTERNATIONAL INC., would like to declare that the tested sample has been evaluated in accordance with the test procedures and has been in compliance with the applicable technical standards.

The test results in this report apply exclusively to the tested model / sample. Without written approval of SPORTON INTERNATIONAL INC., the test report shall not be reproduced except in full.

Reviewed by: Joseph Lin / Supervisor

Approved by: Jones Tsai / Manager



SPORTON INTERNATIONAL INC.

No. 52, Hwa Ya 1st Rd., Hwa Ya Technology Park, Kwei-Shan District, Tao Yuan City, Taiwan, R.O.C.

SPORTON INTERNATIONAL INC.

TEL : 886-3-327-3456

FAX : 886-3-328-4978

FCC ID : 2AJZB-0308

Page Number : 1 of 59

Report Issued Date : Aug. 17, 2017

Report Version : Rev. 01

Report Template No.: BU5-FR15CBT Version 2.0



TABLE OF CONTENTS

REVISION HISTORY.....3

SUMMARY OF TEST RESULT4

1 GENERAL DESCRIPTION.....5

 1.1 Applicant5

 1.2 Manufacturer.....5

 1.3 Product Feature of Equipment Under Test.....5

 1.4 Modification of EUT5

 1.5 Testing Location6

 1.6 Applicable Standards.....6

2 TEST CONFIGURATION OF EQUIPMENT UNDER TEST.....7

 2.1 Carrier Frequency Channel7

 2.2 Descriptions of Test Mode8

 2.3 Test Mode.....9

 2.4 Connection Diagram of Test System.....10

 2.5 Support Unit used in test configuration and system11

 2.6 EUT Operation Test Setup11

 2.7 Measurement Results Explanation Example.....11

3 TEST RESULT12

 3.1 Number of Channel Measurement12

 3.2 Hopping Channel Separation Measurement14

 3.3 Dwell Time Measurement.....20

 3.4 20dB and 99% Bandwidth Measurement22

 3.5 Peak Output Power Measurement33

 3.6 Conducted Band Edges Measurement.....34

 3.7 Conducted Spurious Emission Measurement41

 3.8 Radiated Band Edges and Spurious Emission Measurement51

 3.9 AC Conducted Emission Measurement.....55

 3.10 Antenna Requirements.....57

4 LIST OF MEASURING EQUIPMENT.....58

5 UNCERTAINTY OF EVALUATION.....59

APPENDIX A. CONDUCTED TEST RESULTS

APPENDIX B. AC CONDUCTED EMISSION TEST RESULT

APPENDIX C. RADIATED SPURIOUS EMISSION

APPENDIX D. RADIATED SPURIOUS EMISSION PLOTS

APPENDIX E. DUTY CYCLE PLOTS



SUMMARY OF TEST RESULT

Report Section	FCC Rule	Description	Limit	Result
3.1	15.247(a)(1)	Number of Channels	≥ 15Chs	Pass
3.2	15.247(a)(1)	Hopping Channel Separation	≥ 2/3 of 20dB BW	Pass
3.3	15.247(a)(1)	Dwell Time of Each Channel	≤ 0.4sec in 31.6sec period	Pass
3.4	15.247(a)(1)	20dB Bandwidth	NA	Pass
3.4	-	99% Bandwidth	-	Pass
3.5	15.247(b)(1)	Peak Output Power	≤ 125 mW	Pass
3.6	15.247(d)	Conducted Band Edges	≤ 20dBc	Pass
3.7	15.247(d)	Conducted Spurious Emission	≤ 20dBc	Pass
3.8	15.247(d)	Radiated Band Edges and Radiated Spurious Emission	15.209(a) & 15.247(d)	Pass
3.9	15.207	AC Conducted Emission	15.207(a)	Pass
3.10	15.203 & 15.247(b)	Antenna Requirement	N/A	Pass



1 General Description

1.1 Applicant

Verdegrass LLC
233 South 13th Street, Suite 1100, Lincoln, Nebraska 68508

1.2 Manufacturer

Product Feature	
Equipment	Digital Media Streaming Device
Model Name	EX69VW
FCC ID	2AJZB-0308
EUT supports Radios application	WLAN 11a/b/g/n HT20/HT40 WLAN 11ac VHT20/VHT40/VHT80 Bluetooth BR/EDR/LE

1.3 Product Feature of Equipment Under Test

Standards-related Product Specification	
Tx/Rx Frequency Range	2402 MHz ~ 2480 MHz
Number of Channels	79
Carrier Frequency of Each Channel	2402+n*1 MHz; n=0~78
Maximum Output Power to Antenna	Bluetooth BR(1Mbps) : 10.41 dBm (0.0110 W) Bluetooth EDR (2Mbps) : 9.02 dBm (0.0080 W) Bluetooth EDR (3Mbps) : 9.30 dBm (0.0085 W)
99% Occupied Bandwidth	Bluetooth BR(1Mbps) : 0.888MHz Bluetooth EDR (2Mbps) : 1.208MHz Bluetooth EDR (3Mbps) : 1.184MHz
Antenna Type / Gain	Fixed Internal Antenna type with gain 1.77 dBi
Type of Modulation	Bluetooth BR (1Mbps) : GFSK Bluetooth EDR (2Mbps) : $\pi/4$ -DQPSK Bluetooth EDR (3Mbps) : 8-DPSK

1.4 Modification of EUT

No modifications are made to the EUT during all test items.



1.5 Testing Location

Sporton Lab is accredited to ISO 17025 by Taiwan Accreditation Foundation (TAF code : 1190) and the FCC designation No. TW0007 under the FCC 2.948(e) by Mutual Recognition Agreement (MRA) in FCC Test.

Test Site	SPORTON INTERNATIONAL INC.	
Test Site Location	No. 52, Hwa Ya 1 st Rd., Hwa Ya Technology Park, Kwei-Shan District, Tao Yuan City, Taiwan, R.O.C. TEL: +886-3-327-3456 FAX: +886-3-328-4978	
Test Site No.	Sporton Site No.	
	TH05-HY	CO05-HY

Test Site	SPORTON INTERNATIONAL INC.	
Test Site Location	No.58, Aly. 75, Ln. 564, Wenhua 3rd Rd. Guishan Dist, Taoyuan City, Taiwan (R.O.C.) TEL: +886-3-327-0868 FAX: +886-3-327-0855	
Test Site No.	Sporton Site No.	
	03CH12-HY	

Note: The test site complies with ANSI C63.4 2014 requirement.

1.6 Applicable Standards

According to the specifications of the manufacturer, the EUT must comply with the requirements of the following standards:

- ♦ FCC Part 15 Subpart C §15.247
- ♦ ANSI C63.10-2013

Remark: All test items were verified and recorded according to the standards and without any deviation during the test.



2 Test Configuration of Equipment Under Test

2.1 Carrier Frequency Channel

Frequency Band	Channel	Freq. (MHz)	Channel	Freq. (MHz)	Channel	Freq. (MHz)
2400-2483.5 MHz	0	2402	27	2429	54	2456
	1	2403	28	2430	55	2457
	2	2404	29	2431	56	2458
	3	2405	30	2432	57	2459
	4	2406	31	2433	58	2460
	5	2407	32	2434	59	2461
	6	2408	33	2435	60	2462
	7	2409	34	2436	61	2463
	8	2410	35	2437	62	2464
	9	2411	36	2438	63	2465
	10	2412	37	2439	64	2466
	11	2413	38	2440	65	2467
	12	2414	39	2441	66	2468
	13	2415	40	2442	67	2469
	14	2416	41	2443	68	2470
	15	2417	42	2444	69	2471
	16	2418	43	2445	70	2472
	17	2419	44	2446	71	2473
	18	2420	45	2447	72	2474
	19	2421	46	2448	73	2475
	20	2422	47	2449	74	2476
	21	2423	48	2450	75	2477
	22	2424	49	2451	76	2478
	23	2425	50	2452	77	2479
	24	2426	51	2453	78	2480
	25	2427	52	2454	-	-
	26	2428	53	2455	-	-



2.2 Descriptions of Test Mode

Preliminary tests were performed in different data rates and recorded the RF output power in the following table:

Channel	Frequency	Bluetooth RF Output Power		
		Data Rate / Modulation		
		GFSK	$\pi/4$ -DQPSK	8-DPSK
		1Mbps	2Mbps	3Mbps
Ch00	2402MHz	9.74 dBm	8.08 dBm	8.36 dBm
Ch39	2441MHz	10.41 dBm	9.02 dBm	9.30 dBm
Ch78	2480MHz	9.62 dBm	8.71 dBm	8.90 dBm

Remark:

1. All the test data for each data rate were verified, but only the worst case was reported.
 2. The data rate was set in 1Mbps for all the test items due to the highest RF output power.
- a. The EUT has been associated with peripherals and configuration operated in a manner tended to maximize its emission characteristics in a typical application. Frequency range investigated: conduction emission (150 kHz to 30 MHz), radiation emission (9 kHz to the 10th harmonic of the highest fundamental frequency or to 40 GHz, whichever is lower). For radiated measurement, all the possible configuration was pre-scanned with power adaptor and peripherals (HDMI, USB and IR connector). It was determined that the worst configuration was EUT with adaptor but no peripherals. The final radiated testing was performed with EUT with adaptor but no peripherals. The worst mode of radiated spurious emissions is Bluetooth 1Mbps mode, and recorded in this report.
- b. AC power line Conducted Emission was tested under maximum output power.



2.3 Test Mode

The following summary table is showing all test modes to demonstrate in compliance with the standard.

Summary table of Test Cases			
Test Item	Data Rate / Modulation		
	Bluetooth BR 1Mbps GFSK	Bluetooth EDR 2Mbps $\pi/4$ -DQPSK	Bluetooth EDR 3Mbps 8-DPSK
Conducted Test Cases	Mode 1: CH00_2402 MHz Mode 2: CH39_2441 MHz Mode 3: CH78_2480 MHz	Mode 4: CH00_2402 MHz Mode 5: CH39_2441 MHz Mode 6: CH78_2480 MHz	Mode 7: CH00_2402 MHz Mode 8: CH39_2441 MHz Mode 9: CH78_2480 MHz
Radiated Test Cases	Bluetooth BR 1Mbps GFSK		
	Mode 1: CH00_2402 MHz Mode 2: CH39_2441 MHz Mode 3: CH78_2480 MHz		
AC Conducted Emission	Mode 1 :WLAN (2.4GHz) Link + Bluetooth Link + LED On + MPEG4 (Maximum Resolution) + IR On + Adapter		
Remark: <p>For radiated test cases, the worst mode data rate 1Mbps was reported only, because this data rate has the highest RF output power at preliminary tests, and the conducted spurious emissions and conducted band edge measurement for each data rate are no worse than 1Mbps, and no other significantly frequencies found in conducted spurious emission.</p>			

2.4 Connection Diagram of Test System

<Bluetooth Tx Mode>

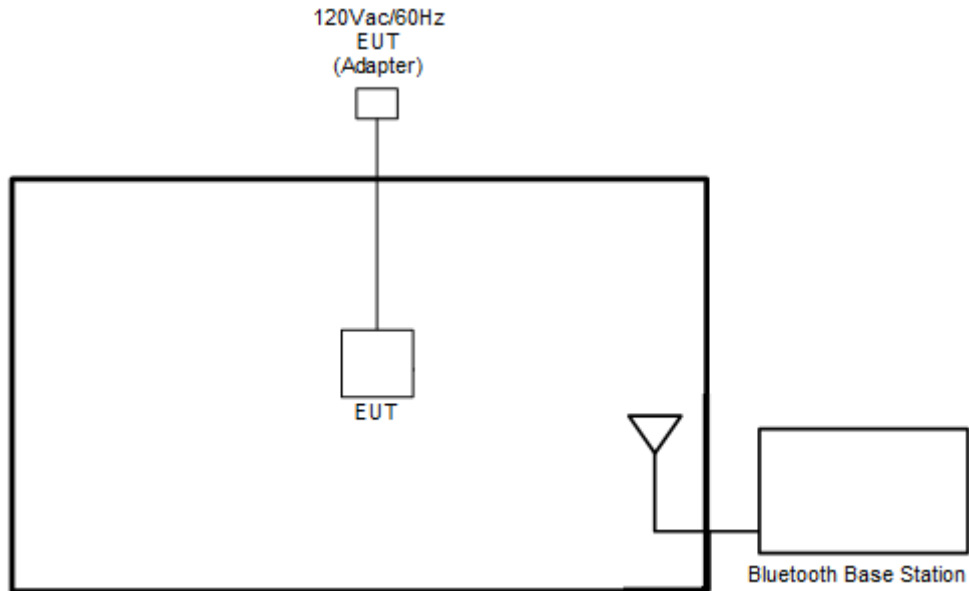

<AC Conducted Emission Mode>

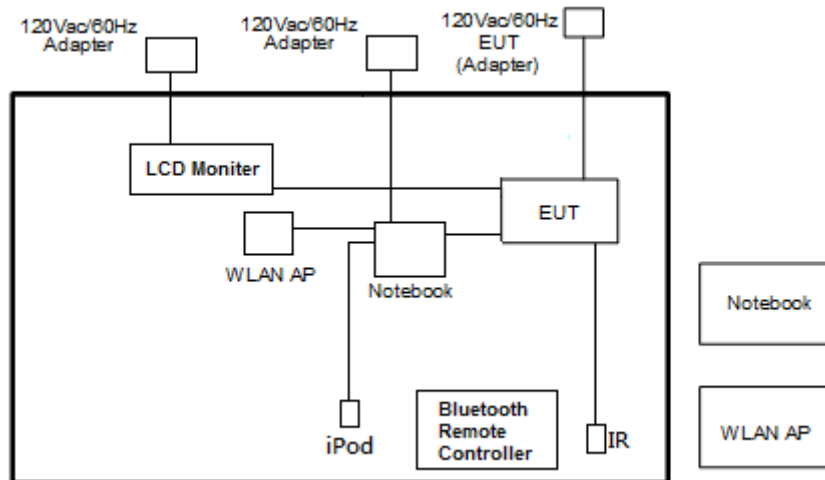



2.5 Support Unit used in test configuration and system

Item	Equipment	Trade Name	Model Name	FCC ID	Data Cable	Power Cord
1.	WLAN AP	ASUS	RT-AC66U	MSQ-RTAC66U	N/A	Unshielded,1.8m
2.	iPod	Apple	A1285	DoC	Shielded, 1.0m	N/A
3.	NOTE BOOK	DELL	E5570	FCC DoC	N/A	AC I/P: Unshielded, 1.2 m DC O/P: Shielded, 1.8 m
4.	NOTE BOOK	DELL	Latitude E6320	FCC DoC	N/A	AC I/P: Unshielded, 1.2 m DC O/P: Shielded, 1.8 m
5.	LCD MONITOR	SONY	KD-55X850D	FCC DoC	Shielded, 1.6m	Unshielded,1.8m
6.	Base Station	R&S	CBT32	N/A	N/A	Unshielded,1.8m

2.6 EUT Operation Test Setup

The RF test items utility, "CMD" was installed in EUT which was programmed in order to make the EUT get into the engineering modes to contact with base station for continuous transmitting and receiving signals.

2.7 Measurement Results Explanation Example

For all conducted test items:

The offset level is set in the spectrum analyzer to compensate the RF cable loss and attenuator factor between EUT conducted output port and spectrum analyzer. With the offset compensation, the spectrum analyzer reading level is exactly the EUT RF output level.

Example:

The spectrum analyzer offset is derived from RF cable loss and attenuator factor.

Offset = RF cable loss + attenuator factor.

Following shows an offset computation example with cable loss 4.2 dB and 10dB attenuator.

$$\begin{aligned} \text{Offset(dB)} &= \text{RF cable loss(dB)} + \text{attenuator factor(dB)}. \\ &= 4.2 + 10 = 14.2 \text{ (dB)} \end{aligned}$$

3 Test Result

3.1 Number of Channel Measurement

3.1.1 Limits of Number of Hopping Frequency

Frequency hopping systems in the 2400-2483.5 MHz band shall use at least 15 channels.

3.1.2 Measuring Instruments

The measuring equipment is listed in the section 4 of this test report.

3.1.3 Test Procedure

1. The testing follows ANSI C63.10-2013 clause 7.8.3.
2. The RF output of EUT was connected to the spectrum analyzer by RF cable and attenuator. The path loss was compensated to the results for each measurement.
3. Set to the maximum power setting and enable the EUT transmit continuously.
4. Enable the EUT hopping function.
5. Use the following spectrum analyzer settings: Span = the frequency band of operation; RBW = 300kHz; VBW \geq RBW; Sweep = auto; Detector function = peak; Trace = max hold.
6. The number of hopping frequency used is defined as the number of total channel.
7. Record the measurement data derived from spectrum analyzer.

3.1.4 Test Setup

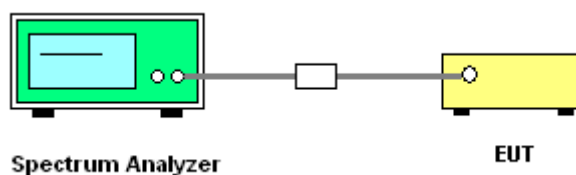



3.1.5 Test Result of Number of Hopping Frequency

Please refer to Appendix A.

Number of Hopping Channel Plot on Channel 00 - 78

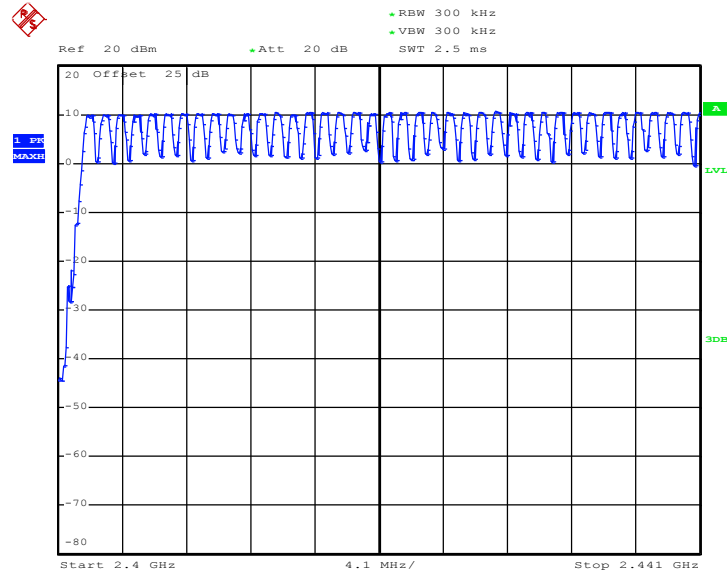

Date: 8.JUL.2017 14:33:34

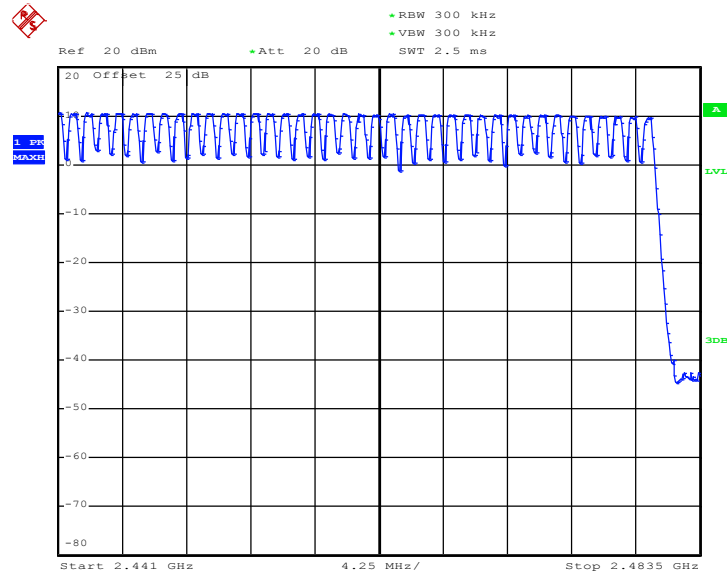

Date: 8.JUL.2017 14:34:39

3.2 Hopping Channel Separation Measurement

3.2.1 Limit of Hopping Channel Separation

Frequency hopping systems operating in the 2400-2483.5 MHz band may have hopping channel carrier frequencies that are separated by 25 kHz or two-thirds of the 20 dB bandwidth of the hopping channel, whichever is greater.

3.2.2 Measuring Instruments

The measuring equipment is listed in the section 4 of this test report.

3.2.3 Test Procedures

1. The testing follows ANSI C63.10-2013 clause 7.8.2.
2. The RF output of EUT was connected to the spectrum analyzer by RF cable and attenuator. The path loss was compensated to the results for each measurement.
3. Set to the maximum power setting and enable the EUT transmit continuously.
4. Enable the EUT hopping function.
5. Use the following spectrum analyzer settings:
Span = wide enough to capture the peaks of two adjacent channels;
RBW = 300kHz; VBW \geq RBW; Sweep = auto; Detector function = peak; Trace = max hold.
6. Measure and record the results in the test report.

3.2.4 Test Setup

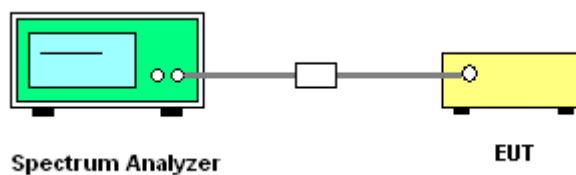

3.2.5 Test Result of Hopping Channel Separation

Please refer to Appendix A.



<1Mbps>

Channel Separation Plot on Channel 00 - 01

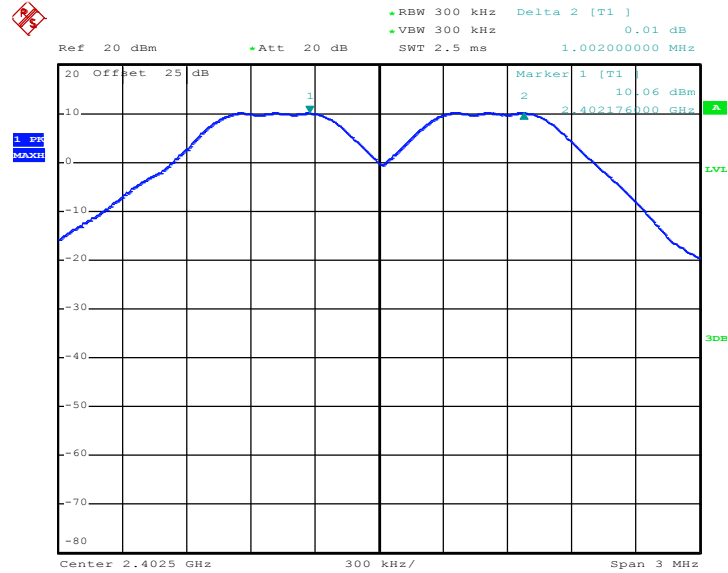

Date: 8.JUL.2017 14:47:32

Channel Separation Plot on Channel 39 - 40

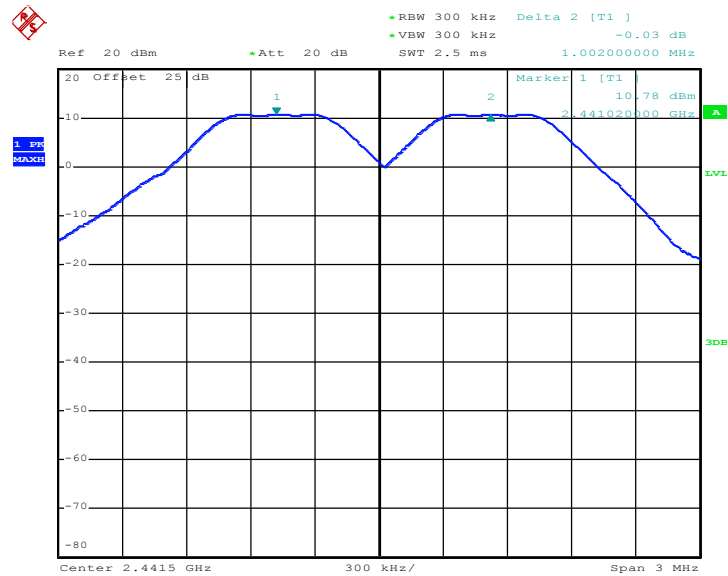

Date: 8.JUL.2017 14:49:57



Channel Separation Plot on Channel 77 - 78

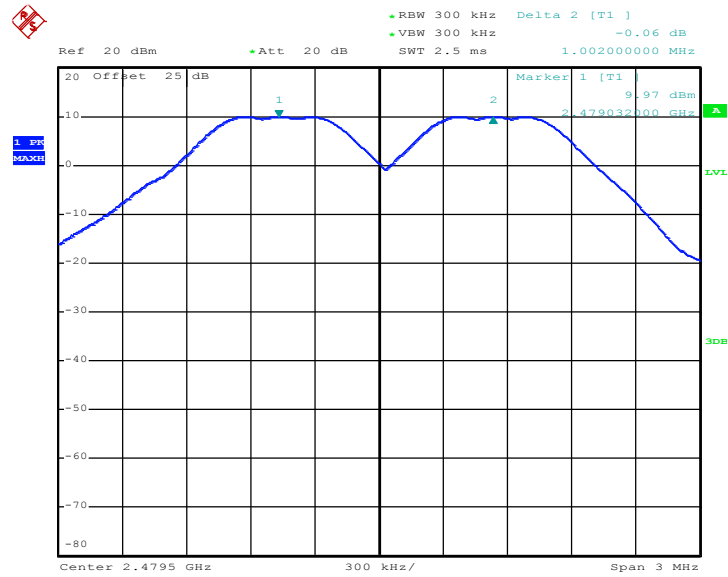

Date: 8.JUL.2017 14:52:49

<2Mbps>

Channel Separation Plot on Channel 00 - 01

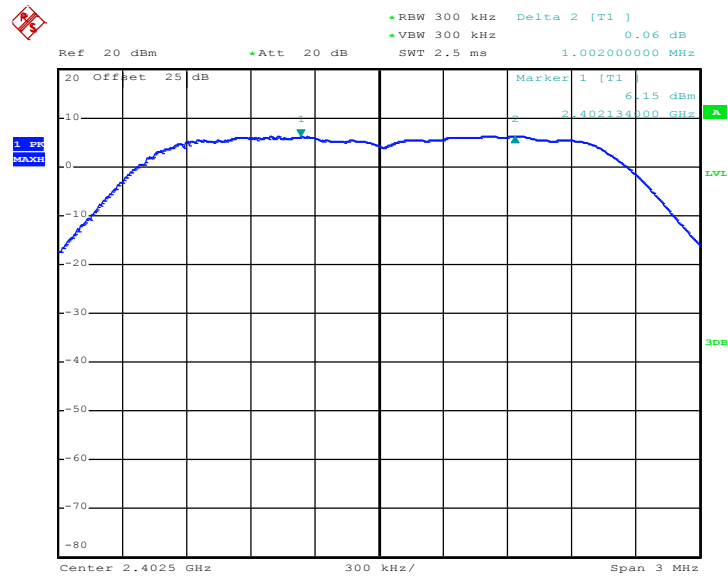

Date: 8.JUL.2017 14:57:08



Channel Separation Plot on Channel 39 - 40

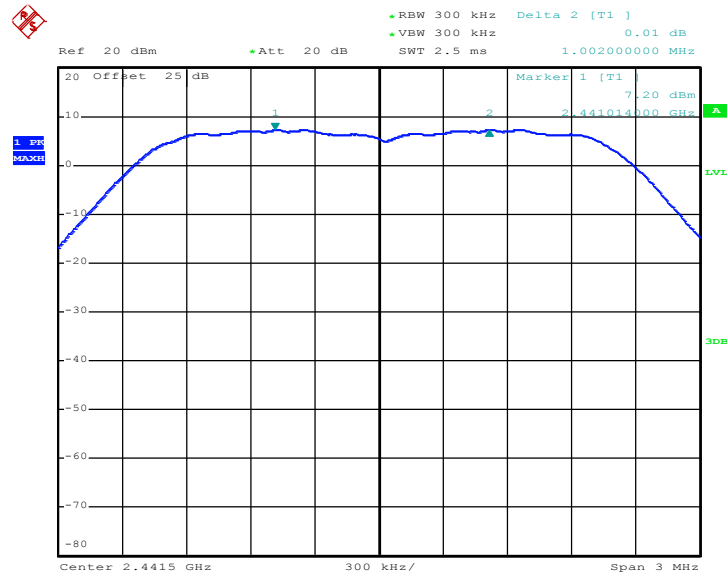

Date: 8.JUL.2017 15:04:43

Channel Separation Plot on Channel 77 - 78

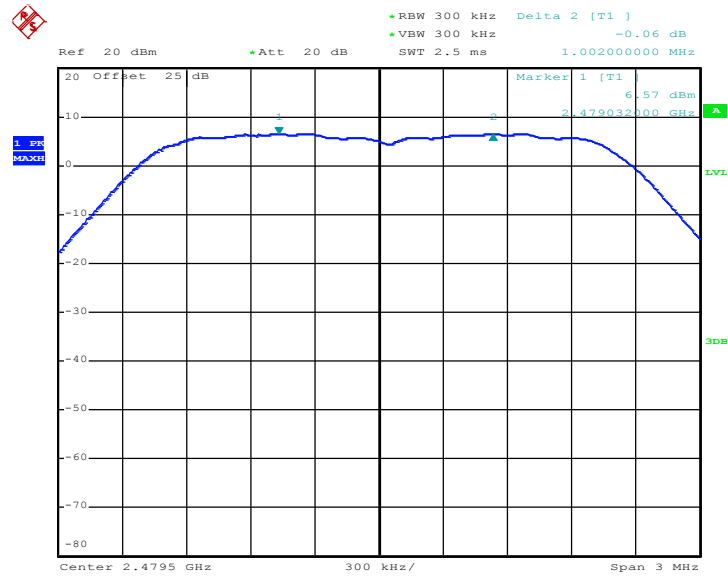

Date: 8.JUL.2017 15:09:33



<3Mbps>

Channel Separation Plot on Channel 00 - 01

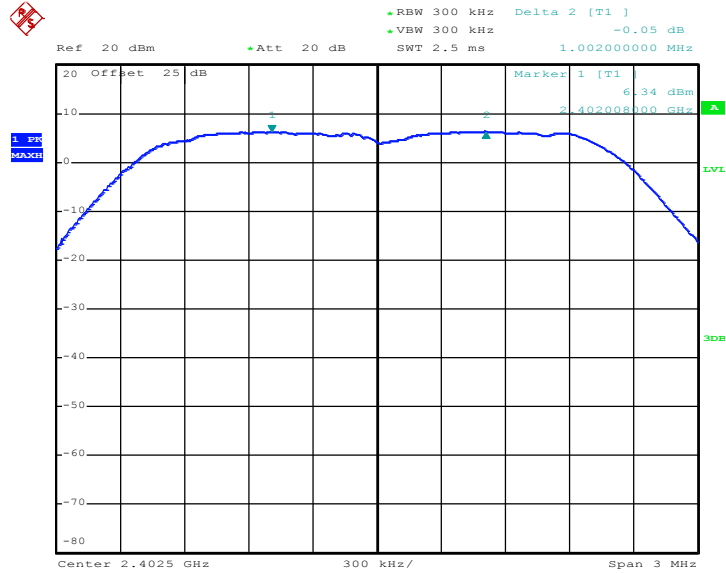

Date: 8.JUL.2017 15:14:10

Channel Separation Plot on Channel 39 - 40

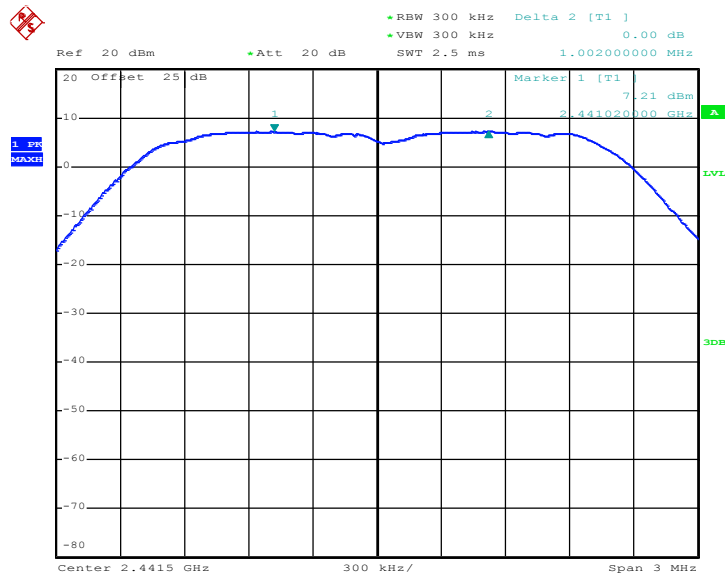

Date: 8.JUL.2017 15:18:50



Channel Separation Plot on Channel 77 - 78

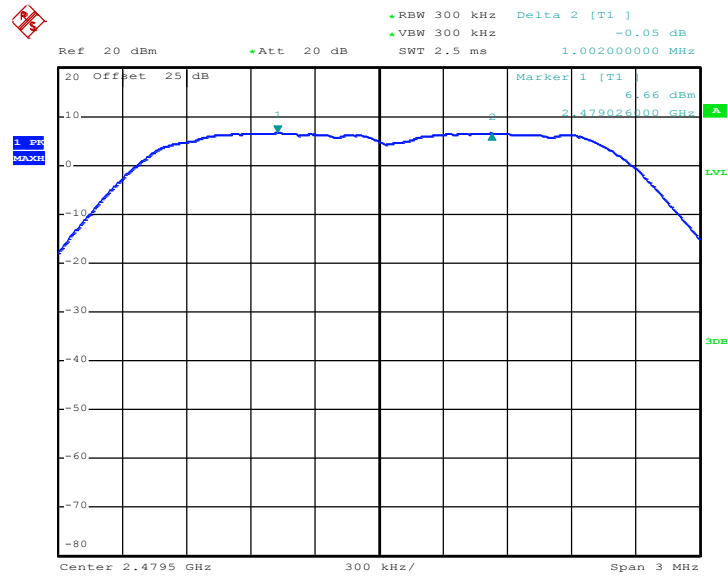

Date: 8.JUL.2017 15:23:08

3.3 Dwell Time Measurement

3.3.1 Limit of Dwell Time

The average time of occupancy on any channel shall not be greater than 0.4 seconds within a period of 0.4 seconds multiplied by the number of hopping channels employed.

3.3.2 Measuring Instruments

The measuring equipment is listed in the section 4 of this test report.

3.3.3 Test Procedures

1. The testing follows ANSI C63.10-2013 clause 7.8.4.
2. The RF output of EUT was connected to the spectrum analyzer by RF cable and attenuator. The path loss was compensated to the results for each measurement.
3. Set to the maximum power setting and enable the EUT transmit continuously.
4. Enable the EUT hopping function.
5. Use the following spectrum analyzer settings: Span = zero span, centered on a hopping channel; RBW = 1 MHz; VBW \geq RBW; Sweep = as necessary to capture the entire dwell time per hopping channel; Detector function = peak; Trace = max hold.
6. Measure and record the results in the test report.

3.3.4 Test Setup

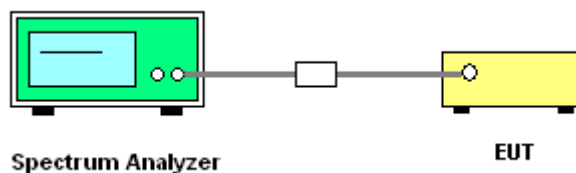

3.3.5 Test Result of Dwell Time

Please refer to Appendix A.



Package Transfer Time Plot

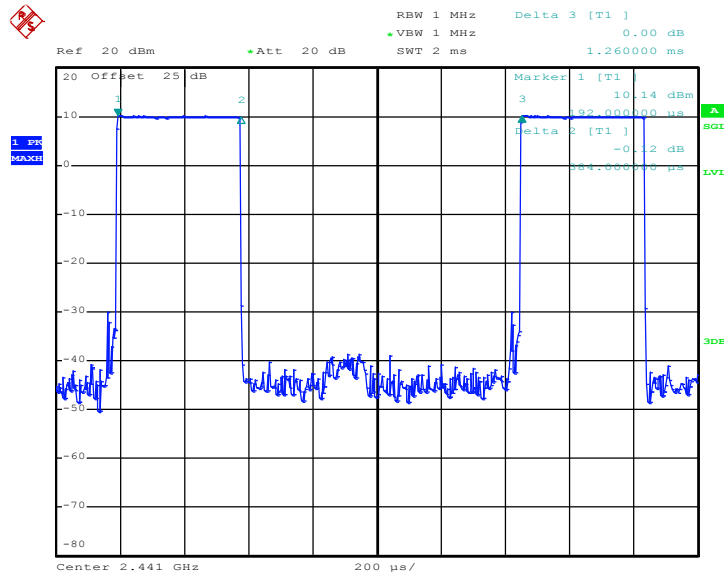

Date: 6.JUL.2017 21:15:23

Remark:

1. In normal mode, hopping rate is 1600 hops/s with 6 slots in 79 hopping channels. With channel hopping rate (1600 / 6 / 79) in Occupancy Time Limit (0.4 x 79) (s), Hops Over Occupancy Time comes to (1600 / 6 / 79) x (0.4 x 79) = 106.67 hops.
2. In AFH mode, hopping rate is 800 hops/s with 6 slots in 20 hopping channels. With channel hopping rate (800 / 6 / 20) in Occupancy Time Limit (0.4 x 20) (s), Hops Over Occupancy Time comes to (800 / 6 / 20) x (0.4 x 20) = 53.33 hops.
3. Dwell Time(s) = Hops Over Occupancy Time (hops) x Package Transfer Time

3.4 20dB and 99% Bandwidth Measurement

3.4.1 Limit of 20dB and 99% Bandwidth

Reporting only

3.4.2 Measuring Instruments

The measuring equipment is listed in the section 4 of this test report.

3.4.3 Test Procedures

1. The testing follows ANSI C63.10-2013 clause 6.9.2 and 6.9.3.
2. The RF output of EUT was connected to the spectrum analyzer by RF cable and attenuator. The path loss was compensated to the results for each measurement.
3. Set to the maximum power setting and enable the EUT transmit continuously.
4. Use the following spectrum analyzer settings for 20dB Bandwidth measurement.
Span = approximately 2 to 5 times the 20 dB bandwidth, centered on a hopping channel;
RBW \geq 1% of the 20 dB bandwidth; VBW \geq RBW; Sweep = auto; Detector function = peak;
Trace = max hold.
5. Use the following spectrum analyzer settings for 99 % Bandwidth measurement.
Span = approximately 1.5 to 5 times the 99% bandwidth, centered on a hopping channel;
RBW \geq 1% of the 99% bandwidth; VBW \geq RBW; Sweep = auto; Detector function = peak;
Trace = max hold.
6. Measure and record the results in the test report.

3.4.4 Test Setup

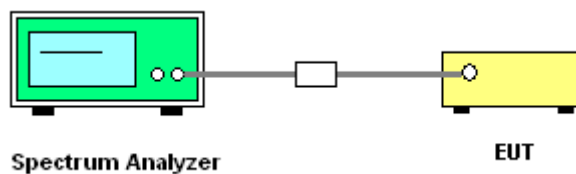

3.4.5 Test Result of 20dB Bandwidth

Please refer to Appendix A.



<1Mbps>

20 dB Bandwidth Plot on Channel 00

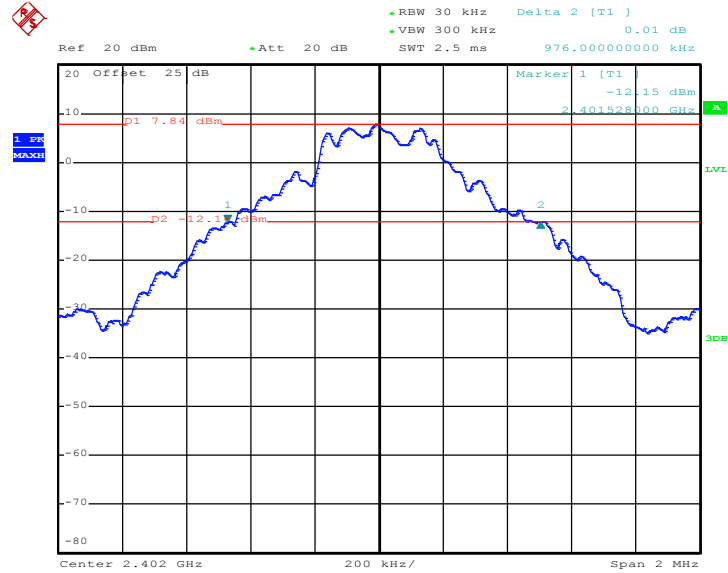

Date: 8.JUL.2017 15:25:40

20 dB Bandwidth Plot on Channel 39

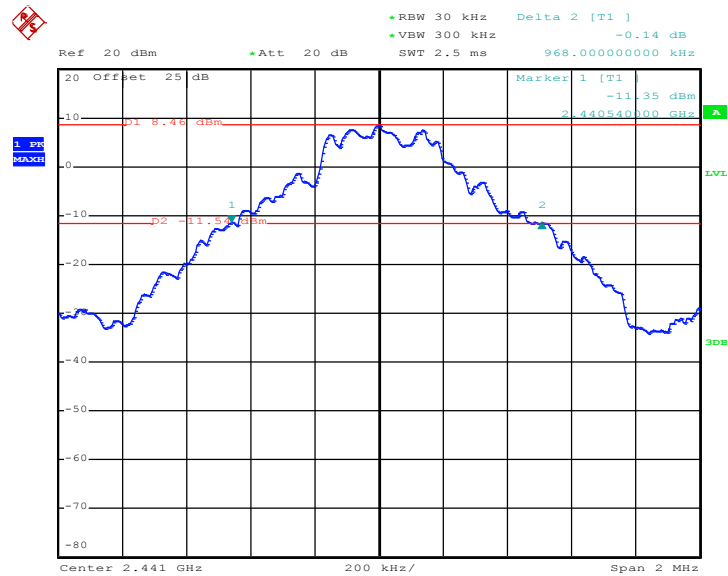

Date: 8.JUL.2017 15:27:22



20 dB Bandwidth Plot on Channel 78

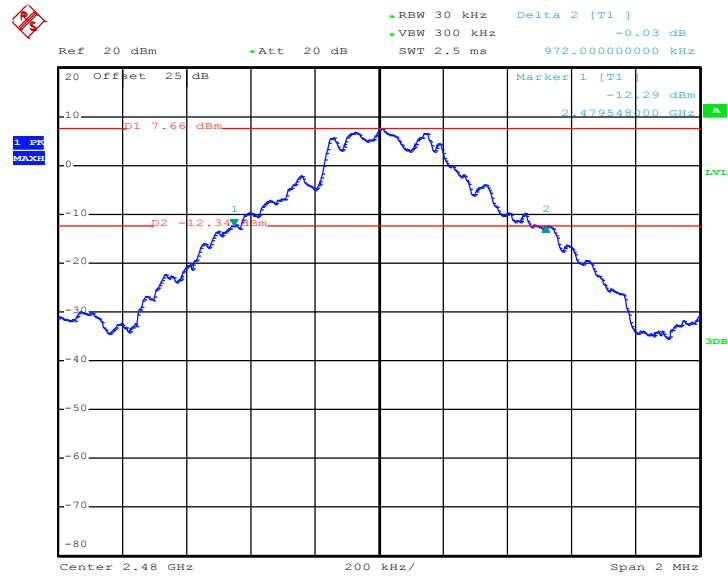

Date: 8.JUL.2017 15:28:18

<2Mbps>

20 dB Bandwidth Plot on Channel 00

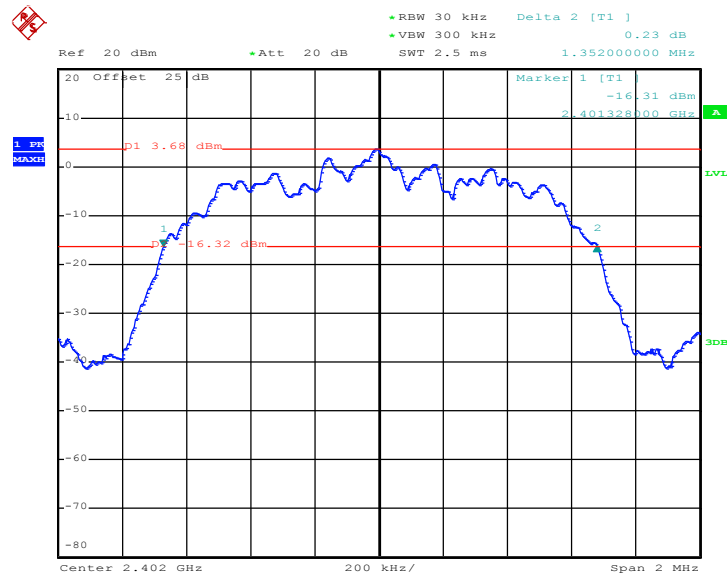

Date: 8.JUL.2017 15:31:18



20 dB Bandwidth Plot on Channel 39

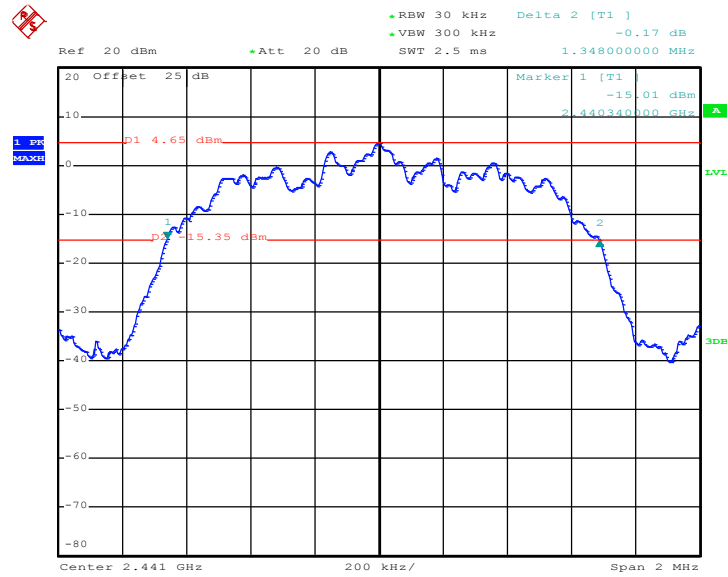

Date: 8.JUL.2017 15:32:37

20 dB Bandwidth Plot on Channel 78

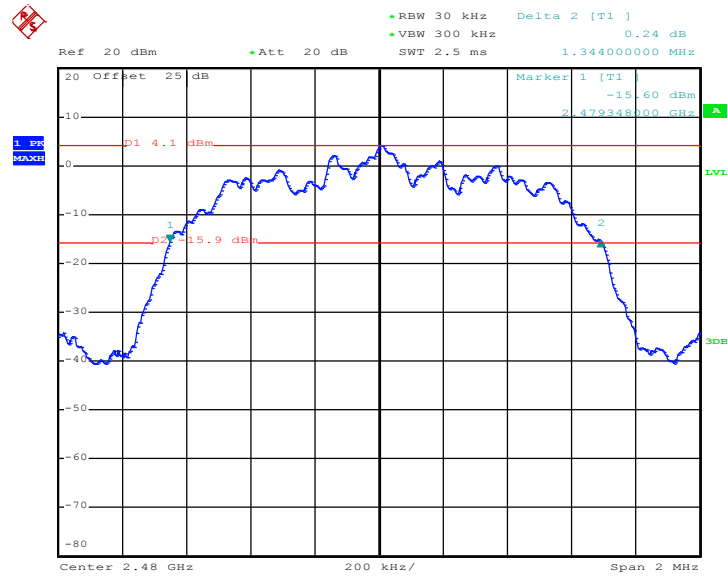

Date: 8.JUL.2017 15:34:03



<3Mbps>

20 dB Bandwidth Plot on Channel 00

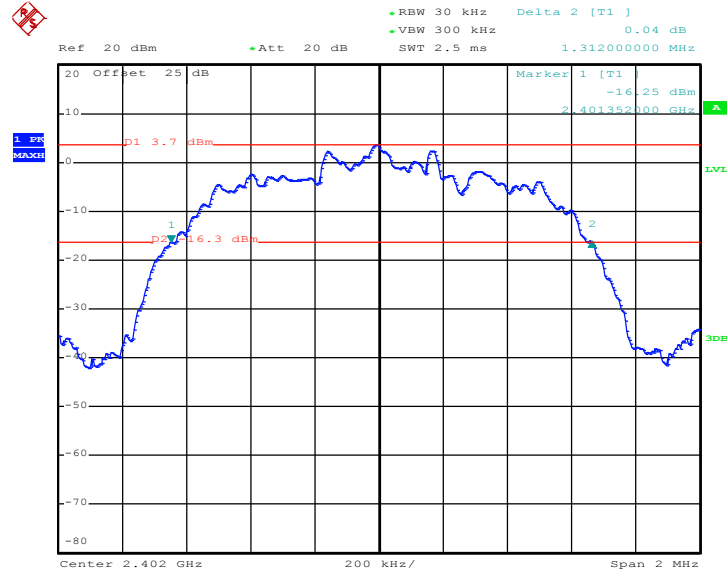

Date: 8.JUL.2017 15:35:21

20 dB Bandwidth Plot on Channel 39

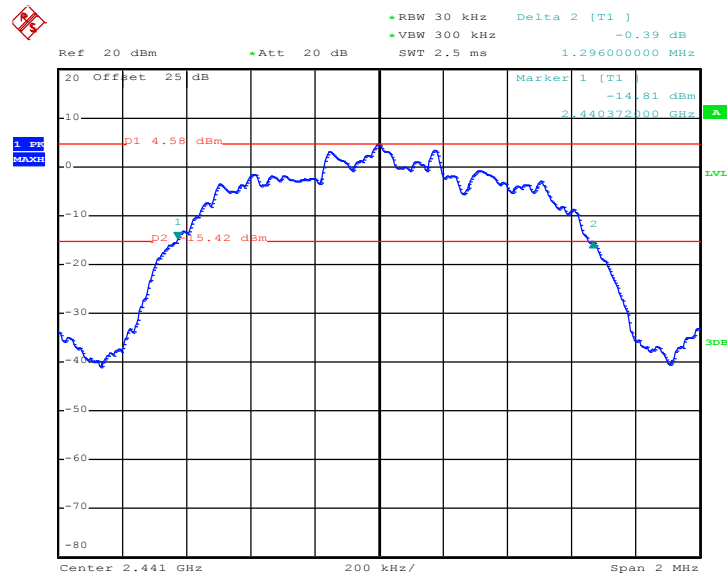

Date: 8.JUL.2017 15:36:37



20 dB Bandwidth Plot on Channel 78

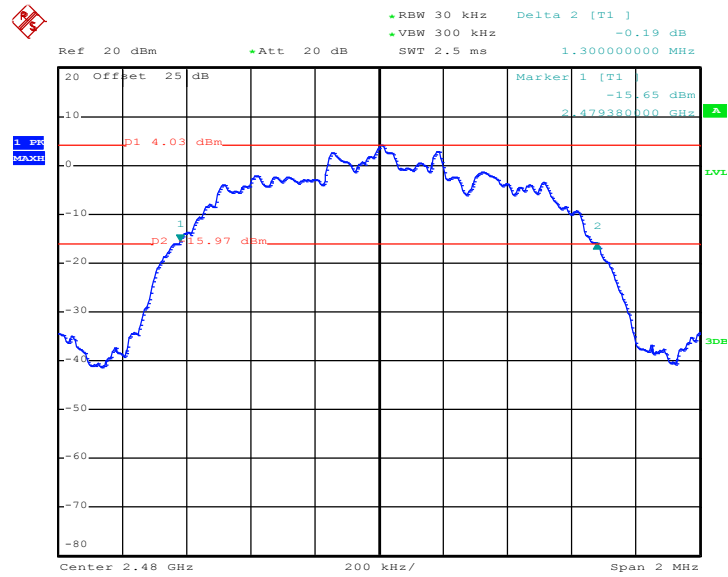

Date: 8.JUL.2017 15:37:45



3.4.6 Test Result of 99% Occupied Bandwidth

Please refer to Appendix A.

<1Mbps>

99% Occupied Bandwidth Plot on Channel 00

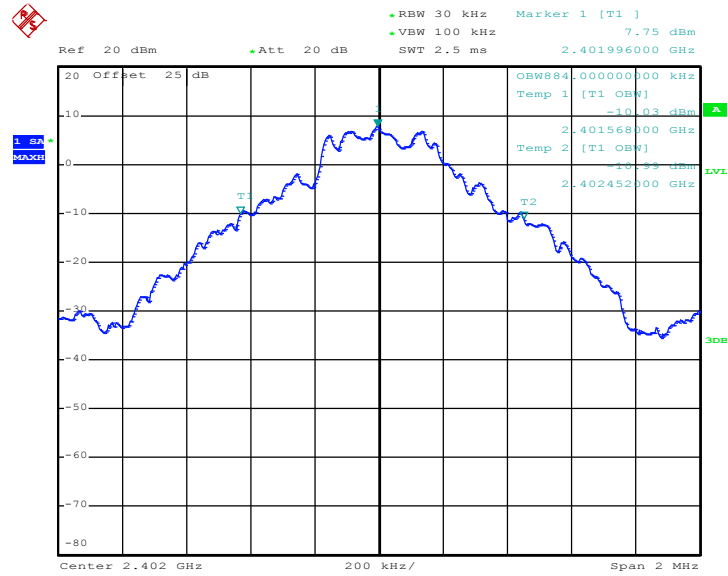

Date: 8.JUL.2017 14:45:24



99% Occupied Bandwidth Plot on Channel 39

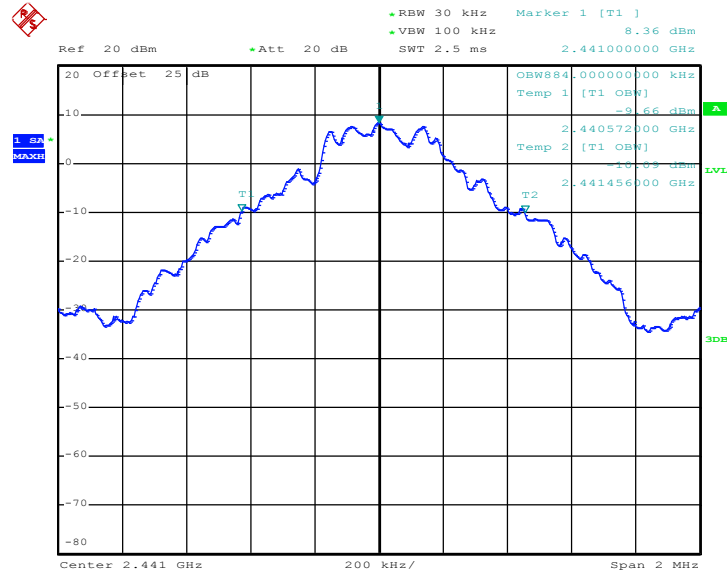

Date: 8.JUL.2017 14:49:03

99% Occupied Bandwidth Plot on Channel 78

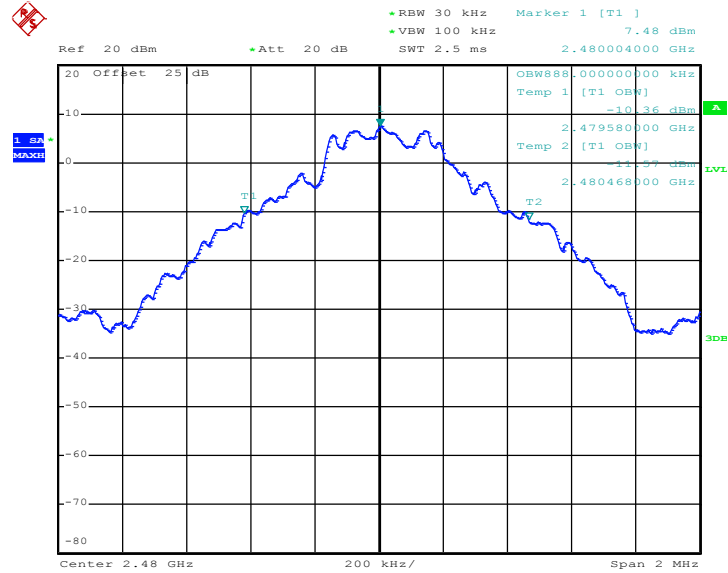

Date: 8.JUL.2017 14:51:25



<2Mbps>

99% Occupied Bandwidth Plot on Channel 00

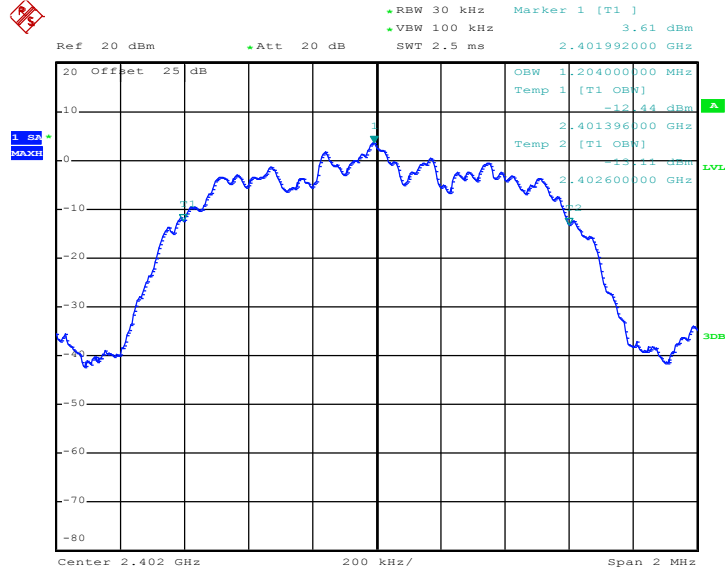

Date: 8.JUL.2017 14:55:23

99% Occupied Bandwidth Plot on Channel 39

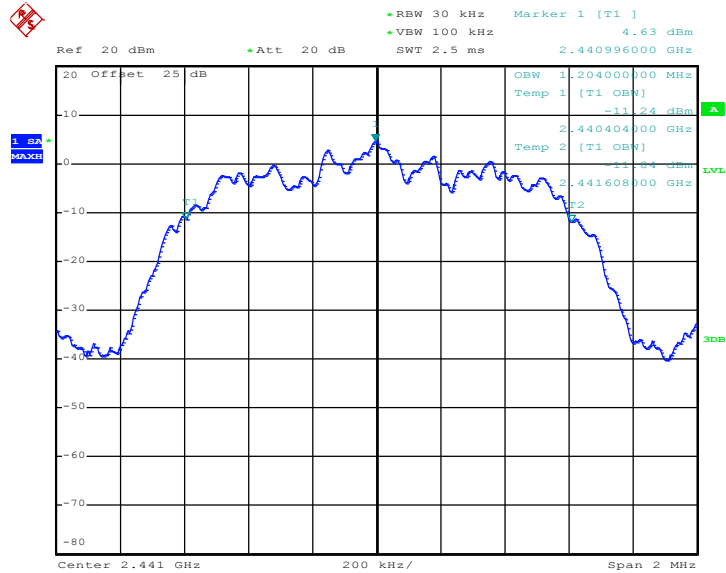

Date: 8.JUL.2017 14:58:46



99% Occupied Bandwidth Plot on Channel 78

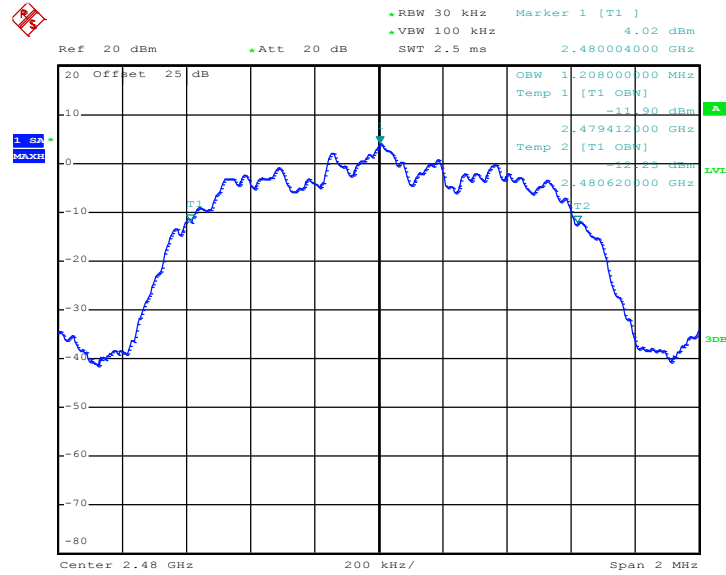

Date: 8.JUL.2017 15:06:12

<3Mbps>

99% Occupied Bandwidth Plot on Channel 00

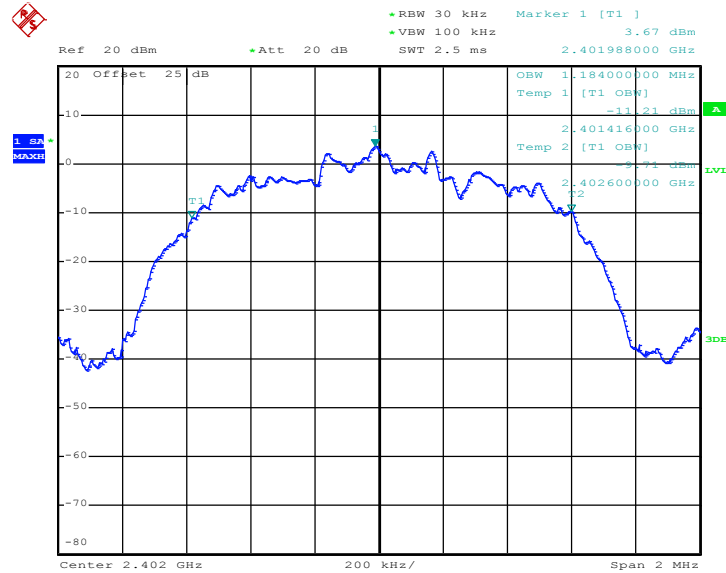

Date: 8.JUL.2017 15:11:07



99% Occupied Bandwidth Plot on Channel 39

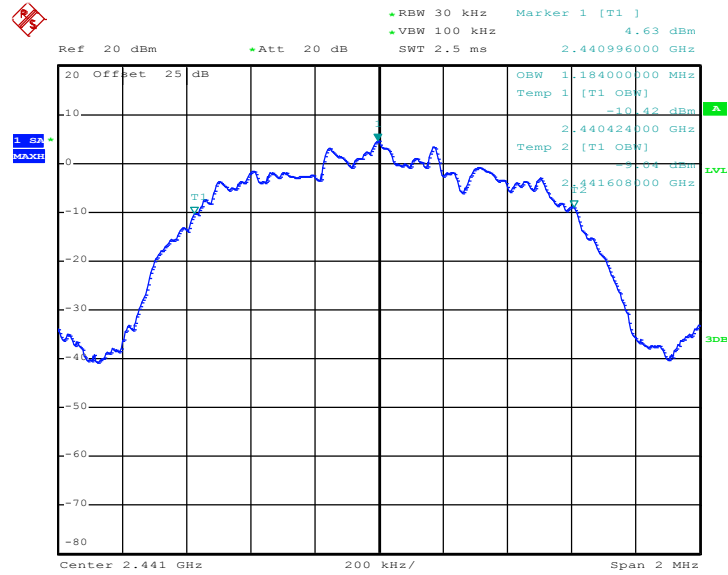

Date: 8.JUL.2017 15:17:51

99% Occupied Bandwidth Plot on Channel 78

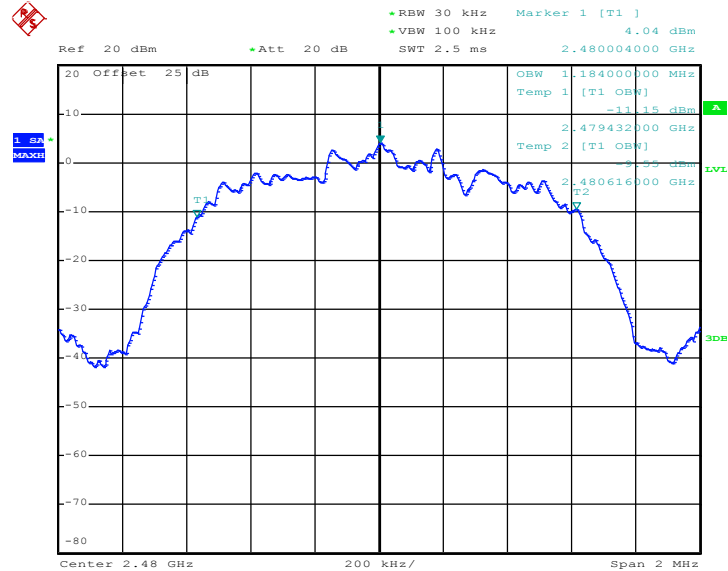

Date: 8.JUL.2017 15:20:39

Note : The occupied channel bandwidth is maintained within the band of operation for all of the modulations.

3.5 Peak Output Power Measurement

3.5.1 Limit of Peak Output Power

The maximum peak conducted output power of the intentional radiator shall not exceed the following:
(1) For frequency hopping systems operating in the 2400-2483.5 MHz band employing at least 75 non-overlapping hopping channels, and all frequency hopping systems in the 5725-5850 MHz band: 1 watt. For all other frequency hopping systems in the 2400-2483.5 MHz band 0.125 watts. The power limit for 1Mbps, 2Mbps, 3Mbps and AFH modes are 0.125 watts.

3.5.2 Measuring Instruments

The measuring equipment is listed in the section 4 of this test report.

3.5.3 Test Procedures

1. The testing follows ANSI C63.10-2013 clause 7.8.5.
2. The RF output of EUT was connected to the power meter by RF cable and attenuator. The path loss was compensated to the results for each measurement.
3. Set to the maximum power setting and enable the EUT transmit continuously.
4. Measure the conducted output power with cable loss and record the results in the test report.
5. Measure and record the results in the test report.

3.5.4 Test Setup

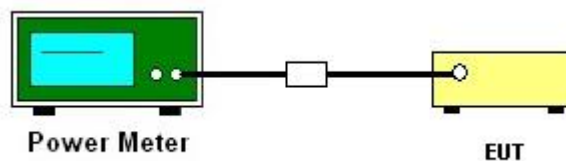

3.5.5 Test Result of Peak Output Power

Please refer to Appendix A.

3.6 Conducted Band Edges Measurement

3.6.1 Limit of Band Edges

In any 100 kHz bandwidth outside the intentional radiation frequency band, the radio frequency power shall be at least 20 dB below the highest level of the radiated power. In addition, radiated emissions which fall in the restricted bands must also comply with the radiated emission limits.

3.6.2 Measuring Instruments

The measuring equipment is listed in the section 4 of this test report.

3.6.3 Test Procedures

1. The testing follows ANSI C63.10-2013 clause 7.8.6.
2. Set to the maximum power setting and enable the EUT transmit continuously.
3. Set RBW = 100kHz, VBW = 300kHz. Band edge emissions must be at least 20 dB down from the highest emission level within the authorized band as measured with a 100kHz RBW. The attenuation shall be 30 dB instead of 20 dB when RMS conducted output power procedure is used.
4. Enable hopping function of the EUT and then repeat step 2. and 3.
5. Measure and record the results in the test report.

3.6.4 Test Setup

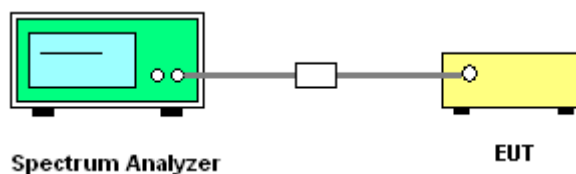

3.6.5 Test Result of Conducted Band Edges

Please refer to Appendix A.



<1Mbps>

Low Band Edge Plot on Channel 00

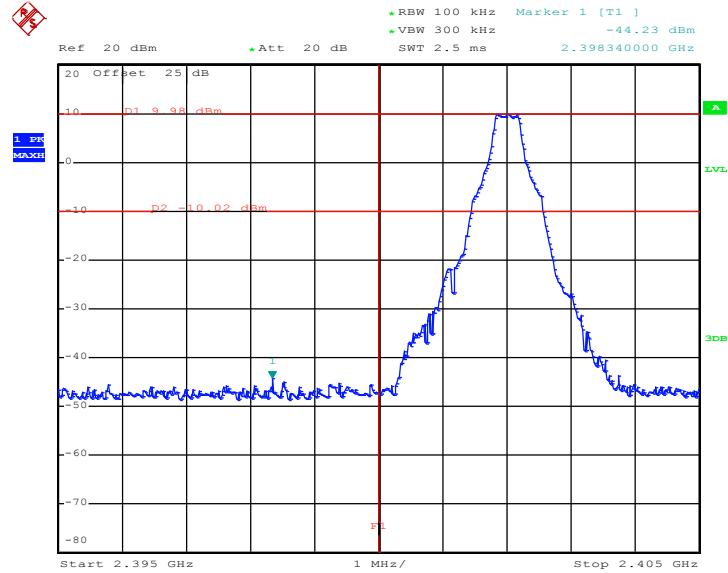

Date: 8.JUL.2017 14:46:33

High Band Edge Plot on Channel 78

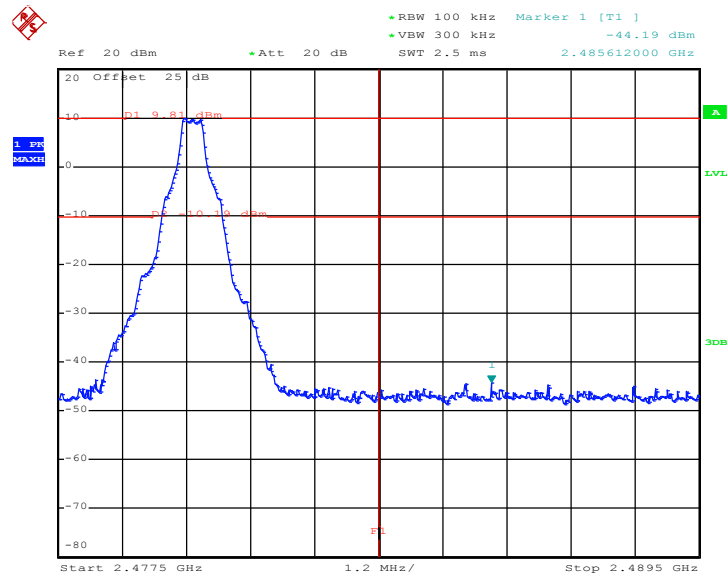

Date: 8.JUL.2017 14:51:49



<2Mbps>

Low Band Edge Plot on Channel 00

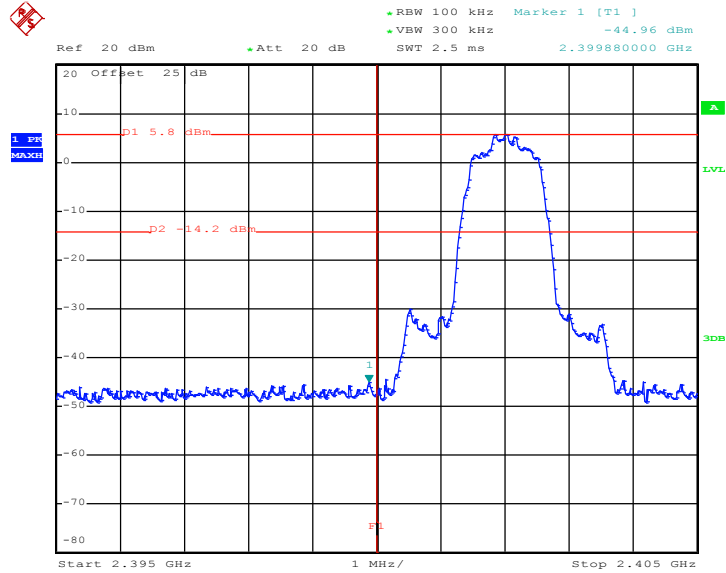

Date: 8.JUL.2017 14:55:40

High Band Edge Plot on Channel 78

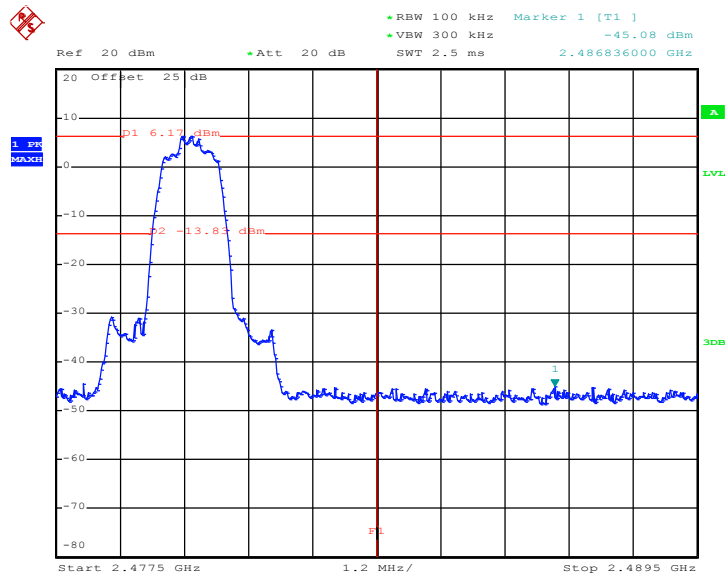

Date: 8.JUL.2017 15:08:21



<3Mbps>

Low Band Edge Plot on Channel 00

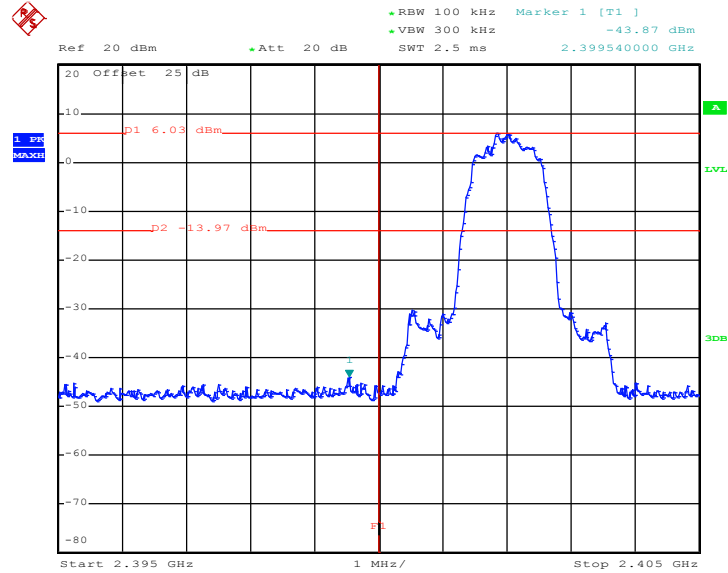

Date: 8.JUL.2017 15:11:47

High Band Edge Plot on Channel 78

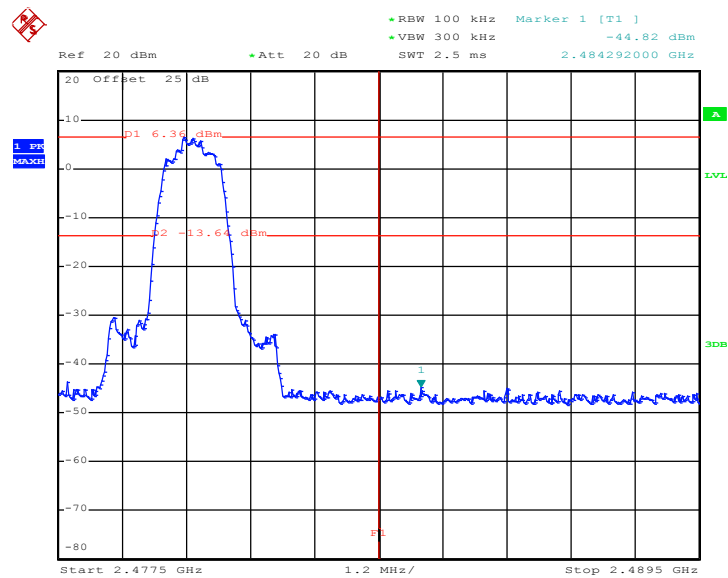

Date: 8.JUL.2017 15:21:54



3.6.6 Test Result of Conducted Hopping Mode Band Edges

Please refer to Appendix A.

<1Mbps>

Hopping Mode Low Band Edge Plot

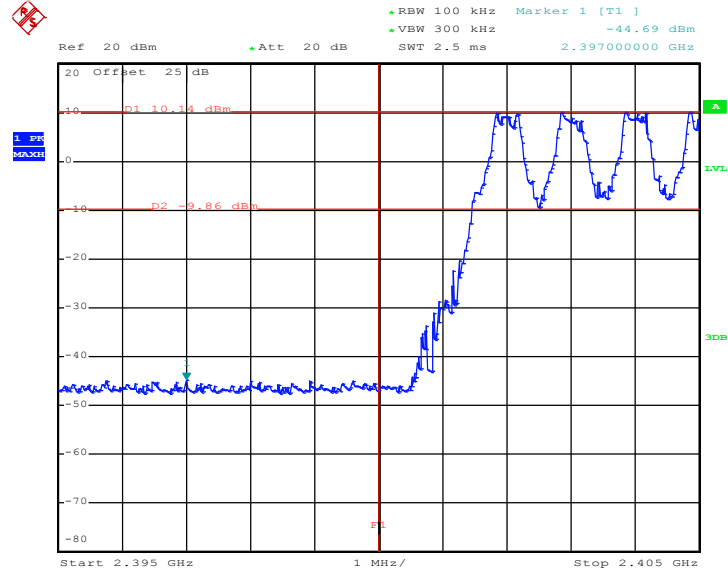

Date: 8.JUL.2017 14:36:29

Hopping Mode High Band Edge Plot

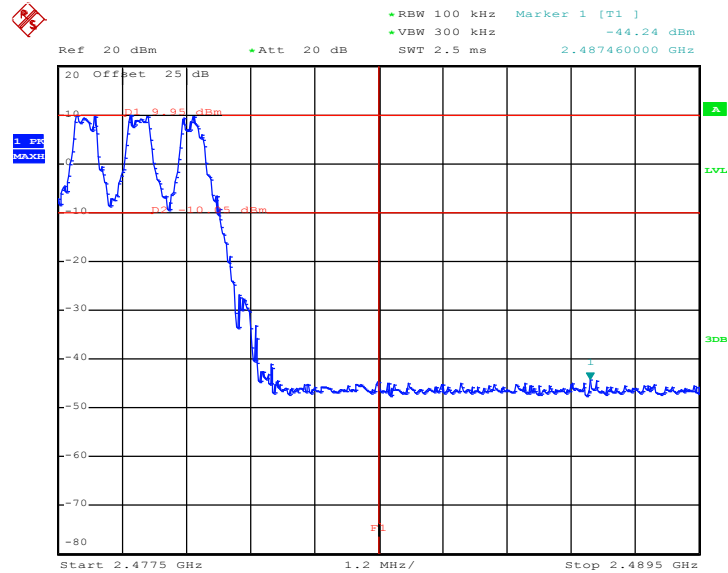

Date: 8.JUL.2017 14:37:41



<2Mbps>

Hopping Mode Low Band Edge Plot

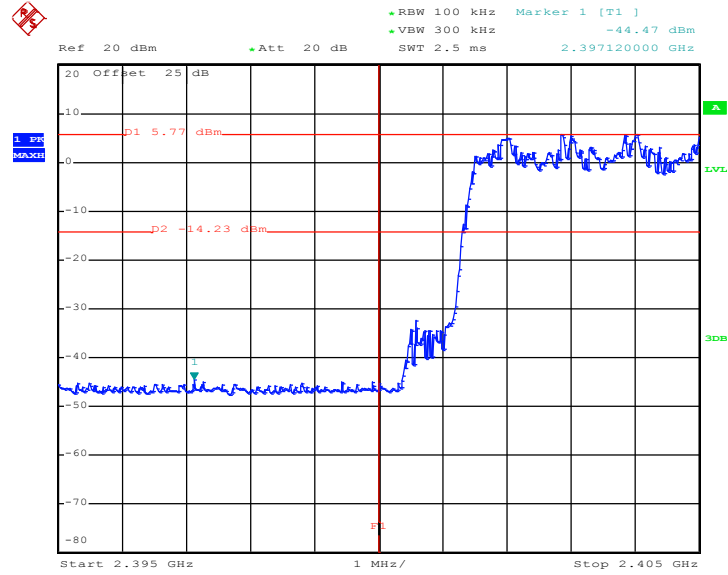

Date: 8.JUL.2017 14:39:38

Hopping Mode High Band Edge Plot

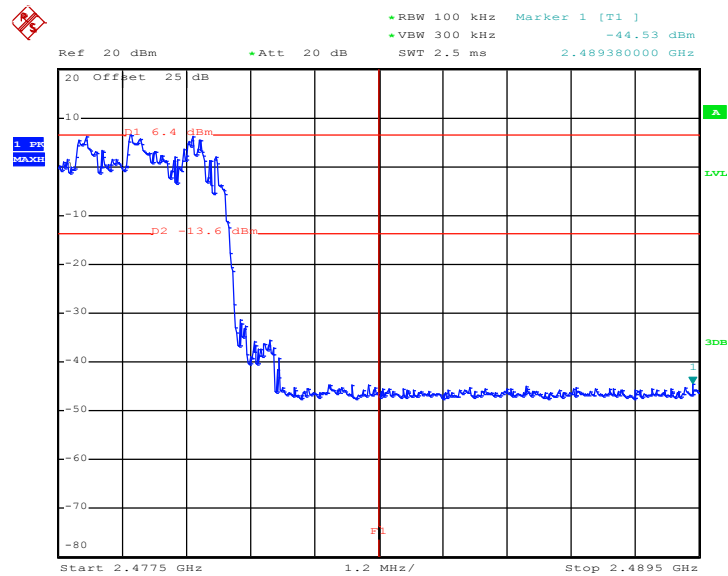

Date: 8.JUL.2017 14:40:38



<3Mbps>

Hopping Mode Low Band Edge Plot

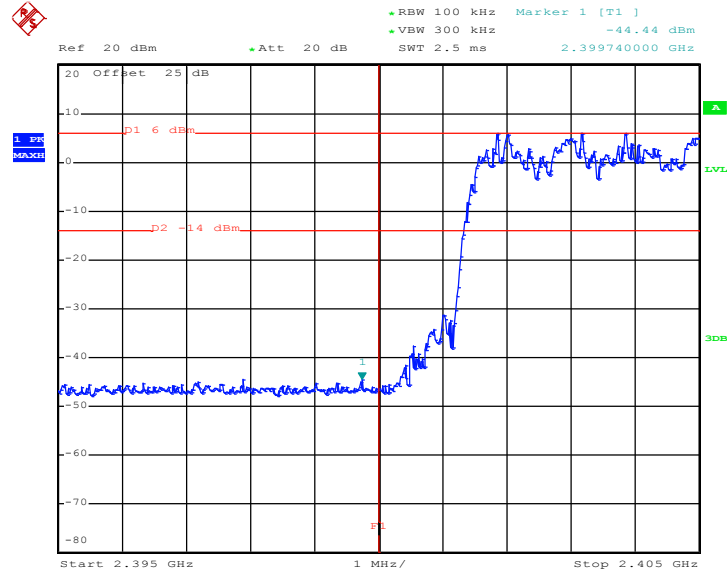

Date: 8.JUL.2017 14:43:42

Hopping Mode High Band Edge Plot

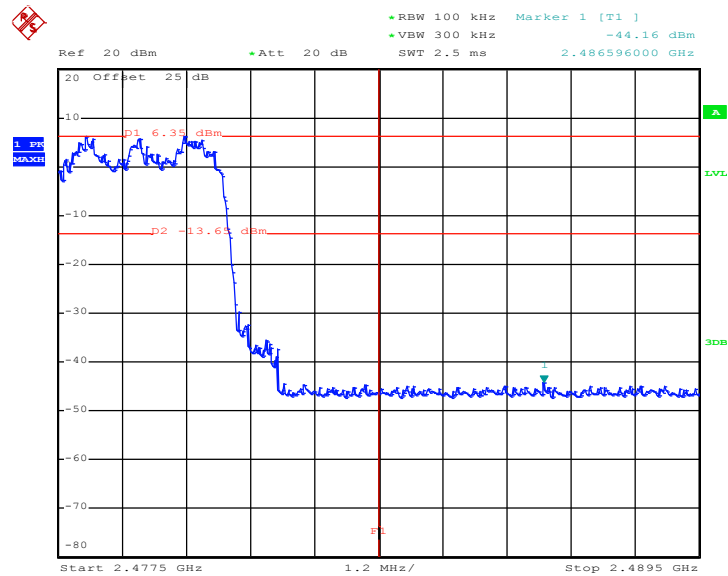

Date: 8.JUL.2017 14:42:13

3.7 Conducted Spurious Emission Measurement

3.7.1 Limit of Spurious Emission Measurement

In any 100 kHz bandwidth outside the intentional radiation frequency band, the radio frequency power shall be at least 20 dB below the highest level of the radiated power. In addition, radiated emissions which fall in the restricted bands must also comply with the radiated emission limits.

3.7.2 Measuring Instruments

The measuring equipment is listed in the section 4 of this test report.

3.7.3 Test Procedure

1. The testing follows ANSI C63.10-2013 clause 7.8.8.
2. The RF output of EUT was connected to the spectrum analyzer by RF cable and attenuator. The path loss was compensated to the results for each measurement.
3. Set to the maximum power setting and enable the EUT transmit continuously.
4. Set RBW = 100 kHz, VBW = 300kHz, scan up through 10th harmonic. All harmonics / spurs must be at least 20 dB down from the highest emission level within the authorized band as measured with a 100 kHz RBW.
5. Measure and record the results in the test report.
6. The RF fundamental frequency should be excluded against the limit line in the operating frequency band.

3.7.4 Test Setup

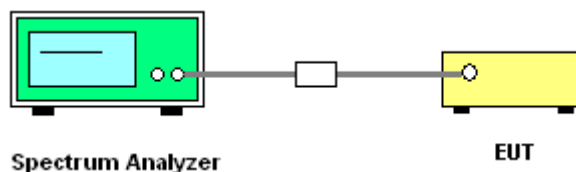



3.7.5 Test Result of Conducted Spurious Emission

Please refer to Appendix A.

<1Mbps>

CSE Plot on Ch 00 between 30MHz ~ 3 GHz

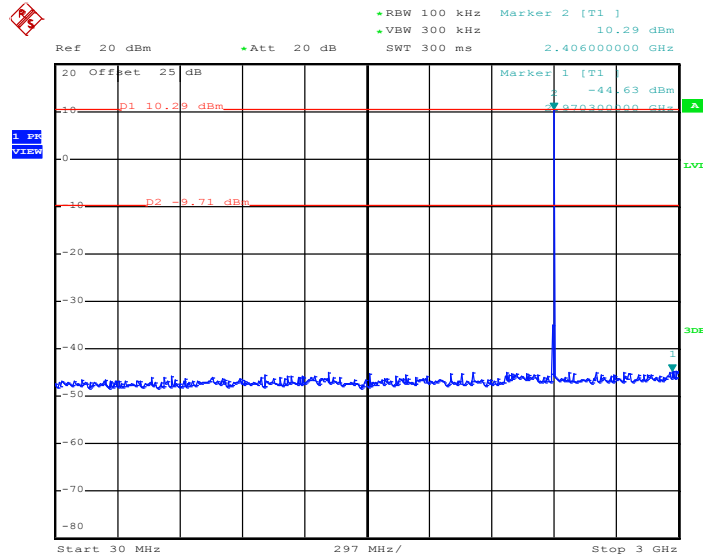

Date: 8.JUL.2017 14:45:49

1Mbps CSE Plot on Ch 00 between 2 GHz ~ 25 GHz

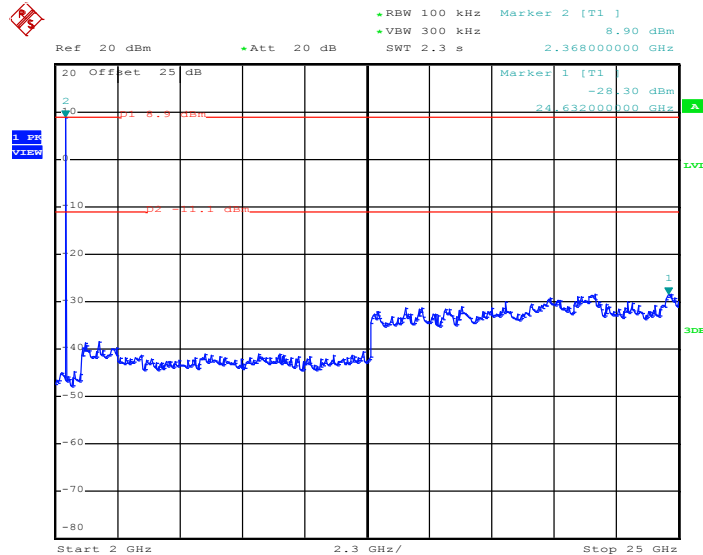

Date: 8.JUL.2017 14:46:11



CSE Plot on Ch 39 between 30MHz ~ 3 GHz

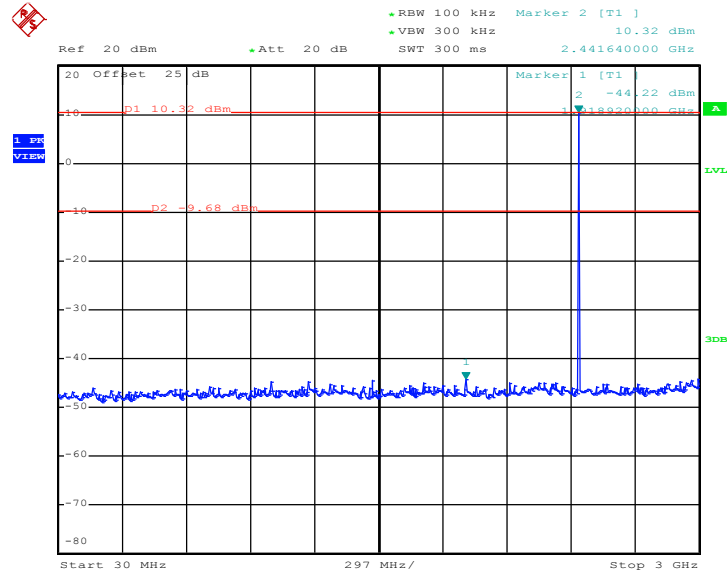

Date: 8.JUL.2017 14:48:04

CSE Plot on Ch 39 between 2 GHz ~ 25 GHz

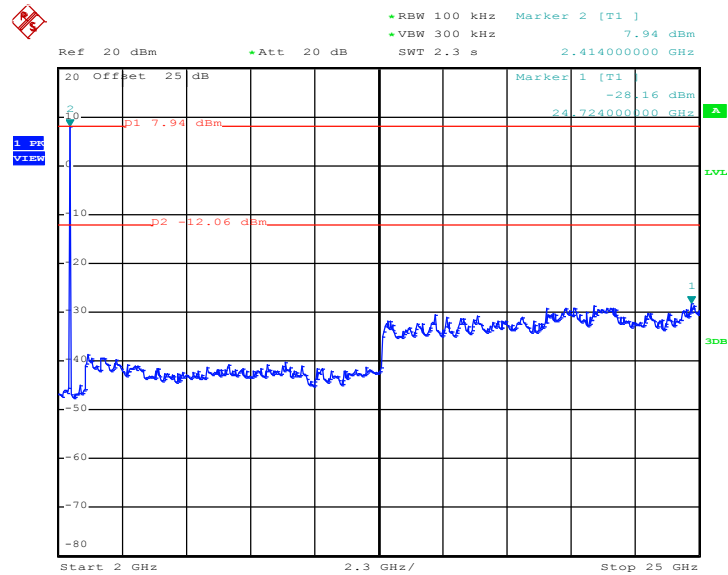

Date: 8.JUL.2017 14:48:26



CSE Plot on Ch 78 between 30MHz ~ 3 GHz

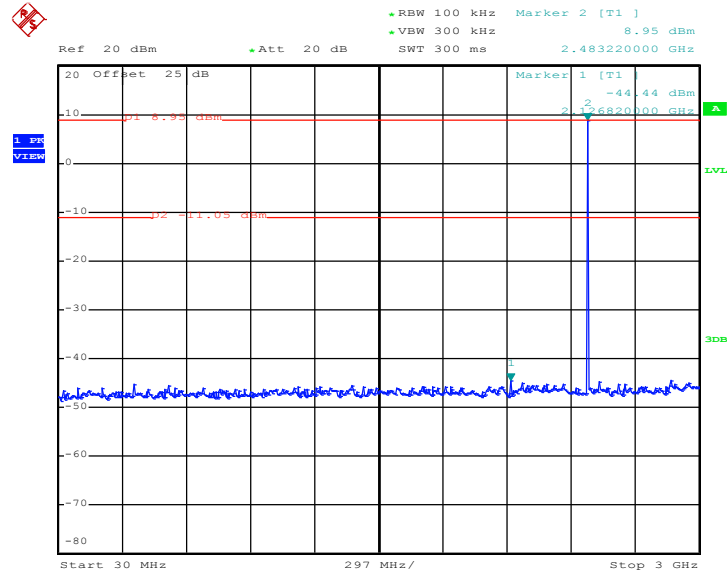

Date: 8.JUL.2017 14:50:26

CSE Plot on Ch 78 between 2 GHz ~ 25 GHz

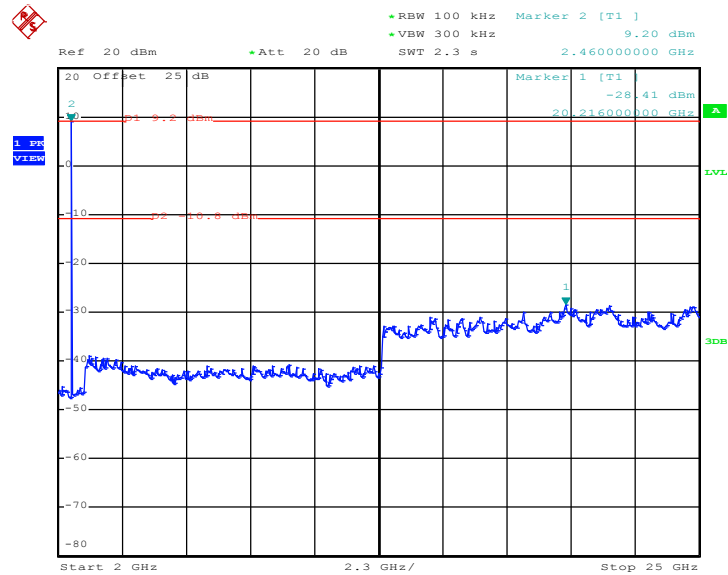

Date: 8.JUL.2017 14:50:47



<2Mbps>

CSE Plot on Ch 00 between 30MHz ~ 3 GHz

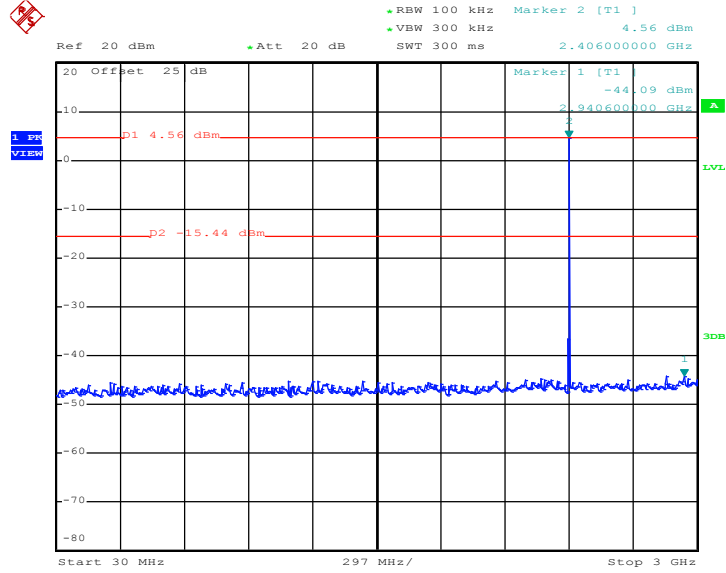

Date: 8.JUL.2017 14:53:24

CSE Plot on Ch 00 between 2 GHz ~ 25 GHz

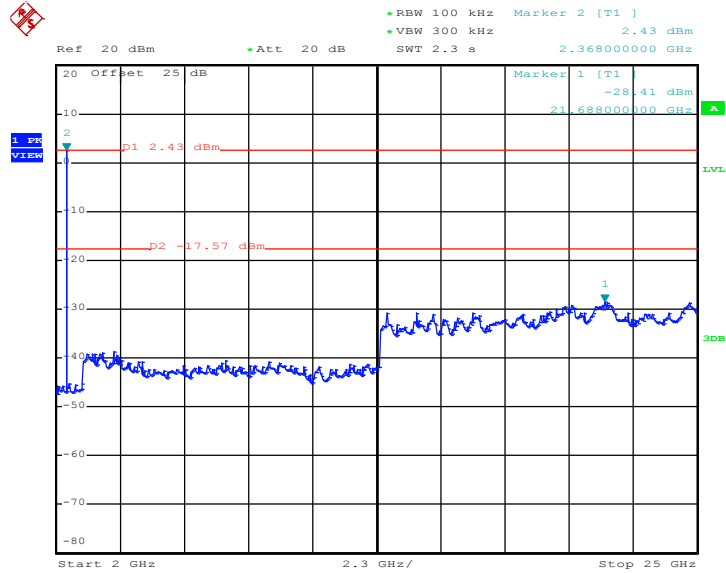

Date: 8.JUL.2017 14:53:46



CSE Plot on Ch 39 between 30MHz ~ 3 GHz

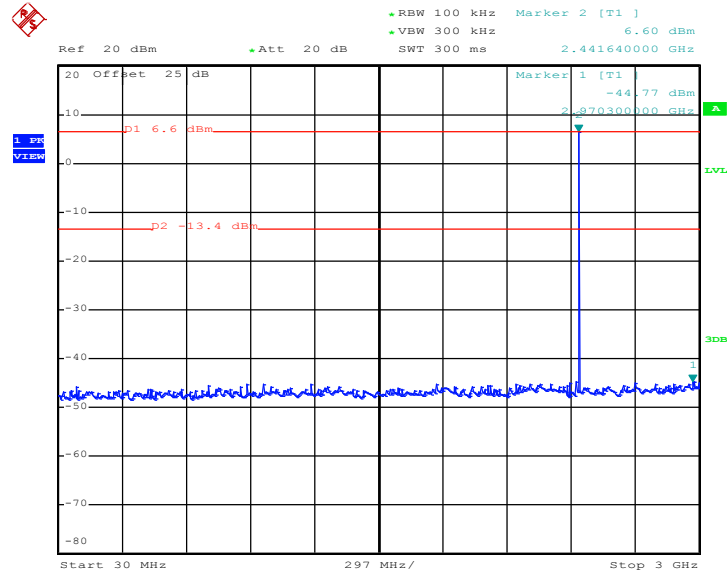

Date: 8.JUL.2017 15:02:36

CSE Plot on Ch 39 between 2 GHz ~ 25 GHz

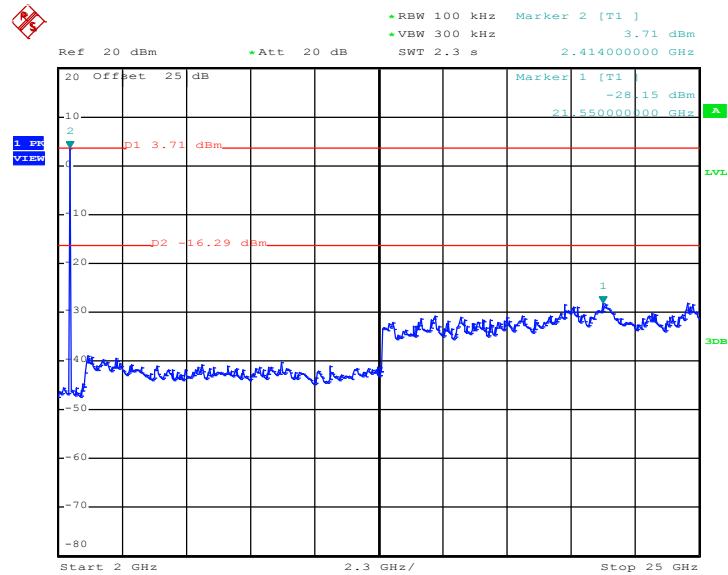

Date: 8.JUL.2017 15:02:57



CSE Plot on Ch 78 between 30MHz ~ 3 GHz

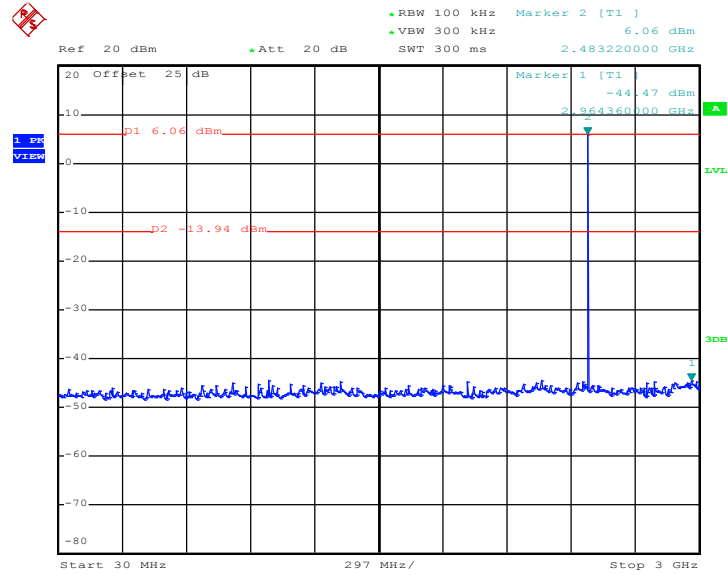

Date: 8.JUL.2017 15:07:33

CSE Plot on Ch 78 between 2 GHz ~ 25 GHz

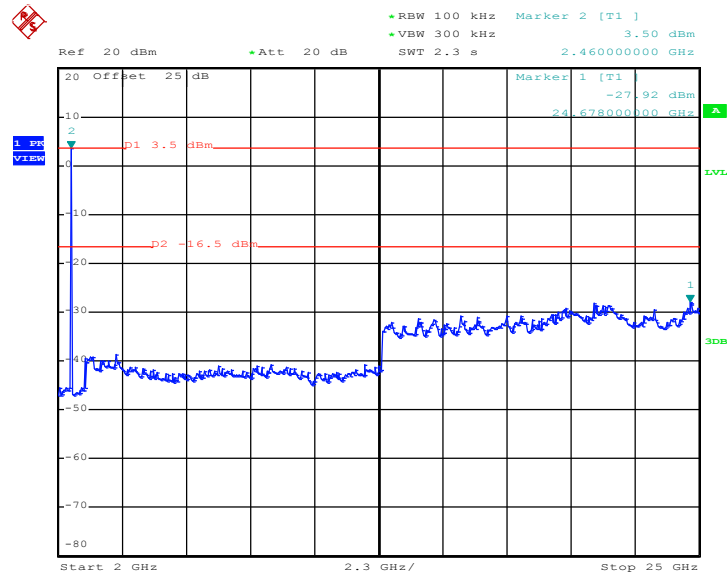

Date: 8.JUL.2017 15:07:55



<3Mbps>

CSE Plot on Ch 00 between 30MHz ~ 3 GHz

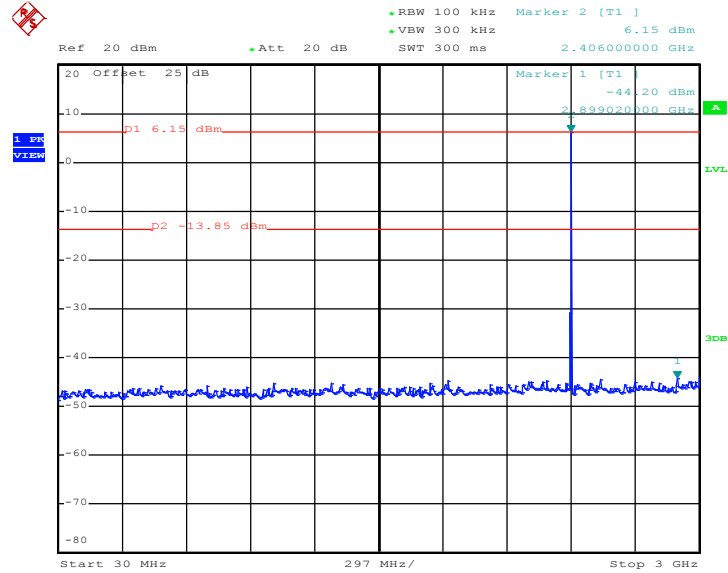

Date: 8.JUL.2017 15:15:37

CSE Plot on Ch 00 between 2 GHz ~ 25 GHz

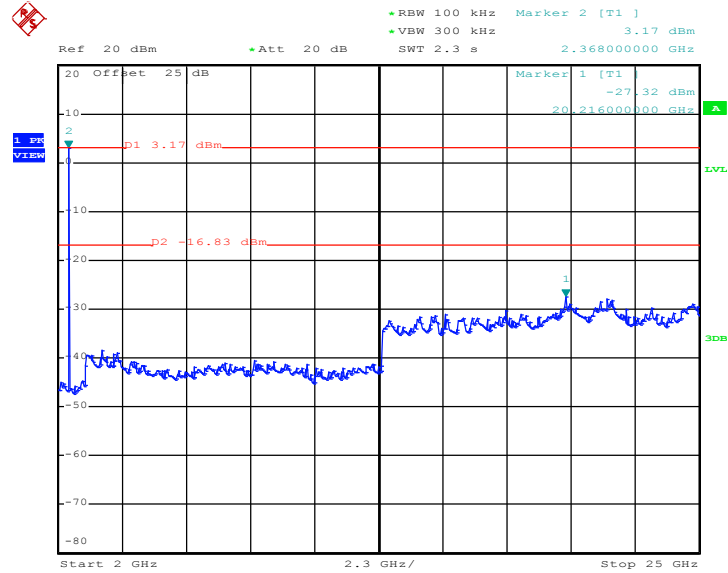

Date: 8.JUL.2017 15:15:59



CSE Plot on Ch 39 between 30MHz ~ 3 GHz

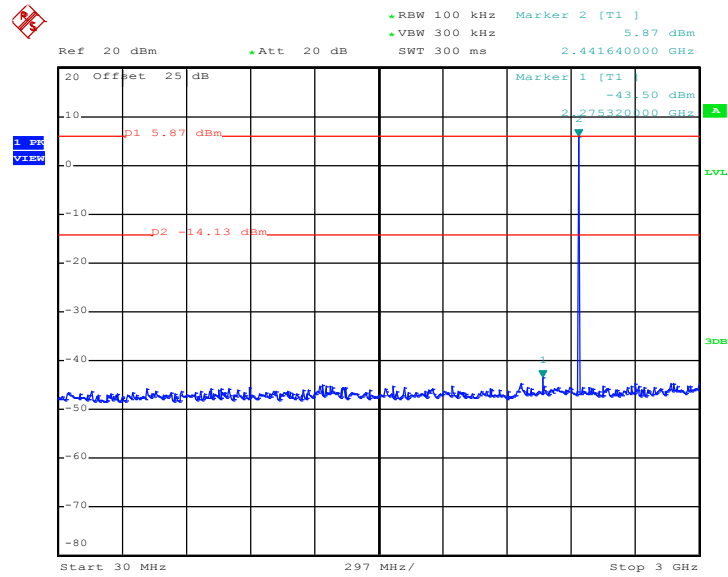

Date: 8.JUL.2017 15:16:48

CSE Plot on Ch 39 between 2 GHz ~ 25 GHz

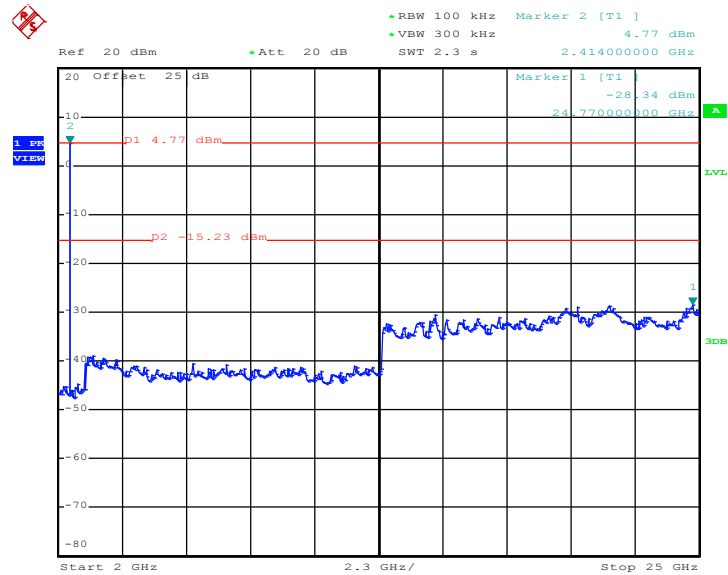

Date: 8.JUL.2017 15:17:10



CSE Plot on Ch 78 between 30MHz ~ 3 GHz

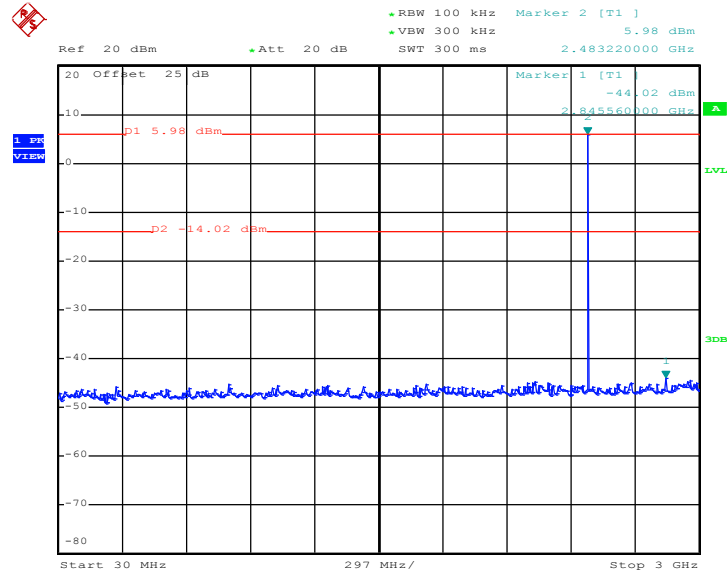

Date: 8.JUL.2017 15:21:13

CSE Plot on Ch 78 between 2 GHz ~ 25 GHz

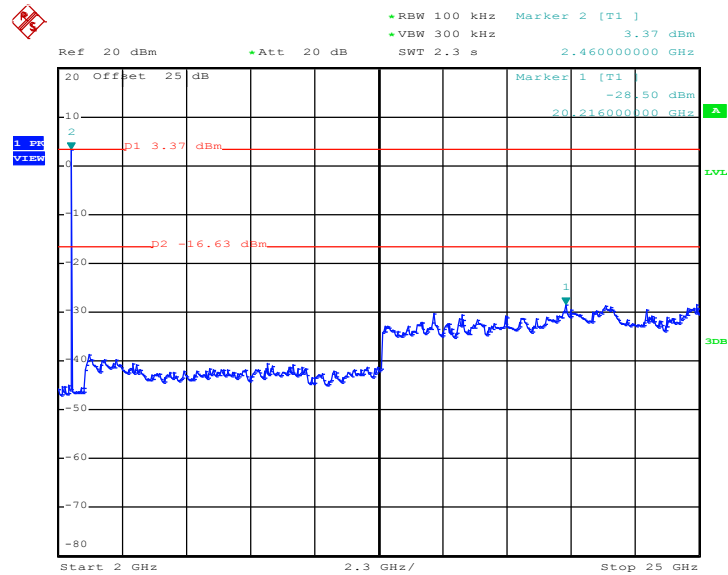

Date: 8.JUL.2017 15:21:35



3.8 Radiated Band Edges and Spurious Emission Measurement

3.8.1 Limit of Radiated Band Edges and Spurious Emission

In any 100 kHz bandwidth outside the intentional radiator frequency band, all harmonics/spurious must be at least 20 dB below the highest emission level within the authorized band. In addition, radiated emissions which fall in the restricted bands must also comply with the limits as below.

Frequency (MHz)	Field Strength (microvolts/meter)	Measurement Distance (meters)
0.009 – 0.490	2400/F(kHz)	300
0.490 – 1.705	24000/F(kHz)	30
1.705 – 30.0	30	30
30 – 88	100	3
88 – 216	150	3
216 - 960	200	3
Above 960	500	3

3.8.2 Measuring Instruments

The measuring equipment is listed in the section 4 of this test report.



3.8.3 Test Procedures

1. The EUT was placed on a turntable with 0.8 meter for frequency below 1GHz and 1.5 meter for frequency above 1GHz respectively above ground.
2. The EUT was set 3 meters from the interference receiving antenna, which was mounted on the top of a variable height antenna tower.
3. For each suspected emission, the EUT was arranged to its worst case and then tune the Antenna tower (from 1 m to 4 m) and turntable (from 0 degree to 360 degrees) to find the maximum reading. A pre-amp and a high pass filter are used for the test in order to get better signal level to comply with the guidelines.
4. Set to the maximum power setting and enable the EUT transmit continuously.
5. Use the following spectrum analyzer settings:
 - (1) Span shall wide enough to fully capture the emission being measured;
 - (2) Set RBW=100 kHz for $f < 1 \text{ GHz}$, RBW=1MHz for $f > 1\text{GHz}$; VBW \geq RBW; Sweep = auto; Detector function = peak; Trace = max hold for peak
 - (3) For average measurement: use duty cycle correction factor method per 15.35(c).
Duty cycle = On time/100 milliseconds
On time = $N_1 * L_1 + N_2 * L_2 + \dots + N_{n-1} * L_{n-1} + N_n * L_n$
Where N_1 is number of type 1 pulses, L_1 is length of type 1 pulses, etc.
Average Emission Level = Peak Emission Level + $20 * \log(\text{Duty cycle})$
6. Corrected Reading: Antenna Factor + Cable Loss + Read Level - Preamp Factor = Level

Note: The average levels were calculated from the peak level corrected with duty cycle correction factor (24.82dB) derived from $20 \log (\text{dwell time}/100\text{ms})$. This correction is only for signals that hop with the fundamental signal, such as band-edge and harmonic. Other spurious signals that are independent of the hopping signal would not use this correction.

3.8.4 Test Setup

For radiated emissions below 30MHz

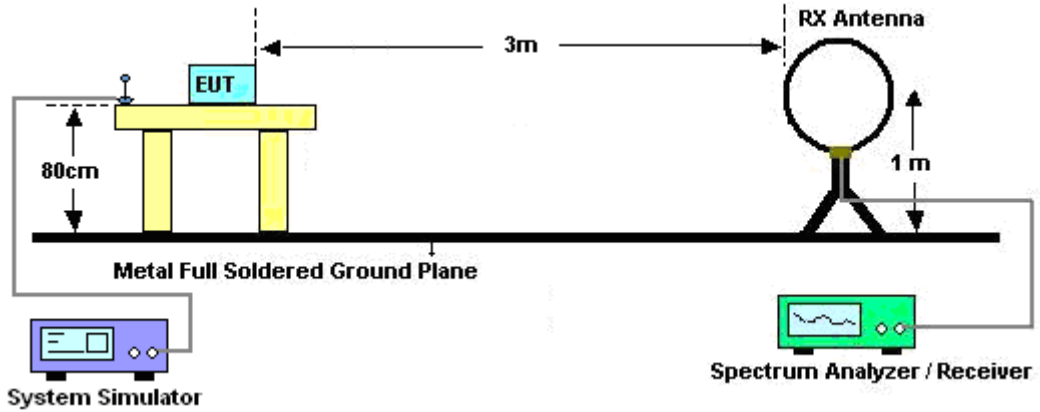

For radiated emissions from 30MHz to 1GHz

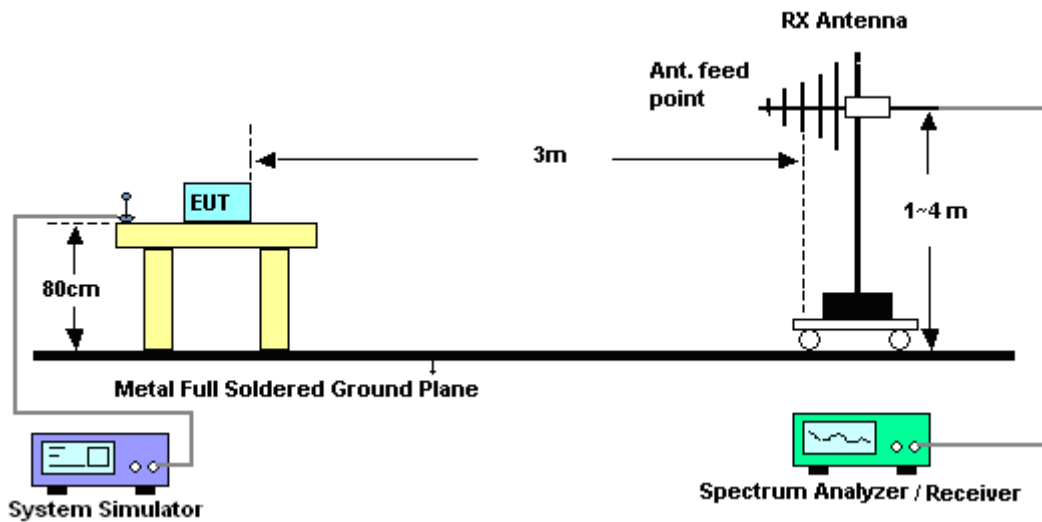

For radiated emissions above 1GHz

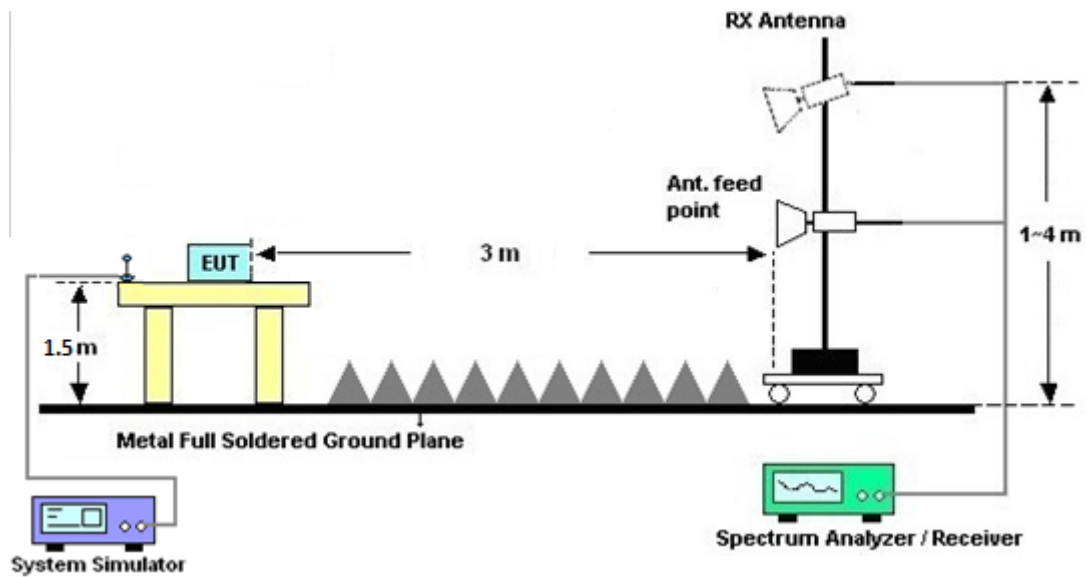

3.8.5 Test Results of Radiated Spurious Emissions (9 kHz ~ 30 MHz)

The low frequency, which started from 9 kHz to 30MHz, was pre-scanned and the result which was 20dB lower than the limit line was not reported.

There is a comparison data of both open-field test site and semi-Anechoic chamber, and the result came out very similar.

3.8.6 Test Result of Radiated Spurious at Band Edges

Please refer to Appendix C and D.

3.8.7 Duty Cycle

Please refer to Appendix E.

3.8.8 Test Result of Radiated Spurious Emission (30MHz ~ 10th Harmonic)

Please refer to Appendix C and D.



3.9 AC Conducted Emission Measurement

3.9.1 Limit of AC Conducted Emission

For equipment that is designed to be connected to the public utility (AC) power line, the radio frequency voltage that is conducted back onto the AC power line on any frequency or frequencies within the band 150 kHz to 30 MHz shall not exceed the limits in the following table.

Frequency of emission (MHz)	Conducted limit (dBµV)	
	Quasi-peak	Average
0.15-0.5	66 to 56*	56 to 46*
0.5-5	56	46
5-30	60	50

*Decreases with the logarithm of the frequency.

3.9.2 Measuring Instruments

The measuring equipment is listed in the section 4 of this test report.

3.9.3 Test Procedures

1. The EUT was placed 0.4 meter from the conducting wall of the shielding room was kept at least 80 centimeters from any other grounded conducting surface.
2. Connect EUT to the power mains through a line impedance stabilization network (LISN).
3. All the support units are connecting to the other LISN.
4. The LISN provides 50 ohm coupling impedance for the measuring instrument.
5. The FCC states that a 50 ohm, 50 microhenry LISN should be used.
6. Both sides of AC line were checked for maximum conducted interference.
7. The frequency range from 150 kHz to 30 MHz was searched.
8. Set the test-receiver system to Peak Detect Function and specified bandwidth (IF Bandwidth = 9kHz) with Maximum Hold Mode. Then measurement is also conducted by Average Detector and Quasi-Peak Detector Function respectively.

3.9.4 Test Setup

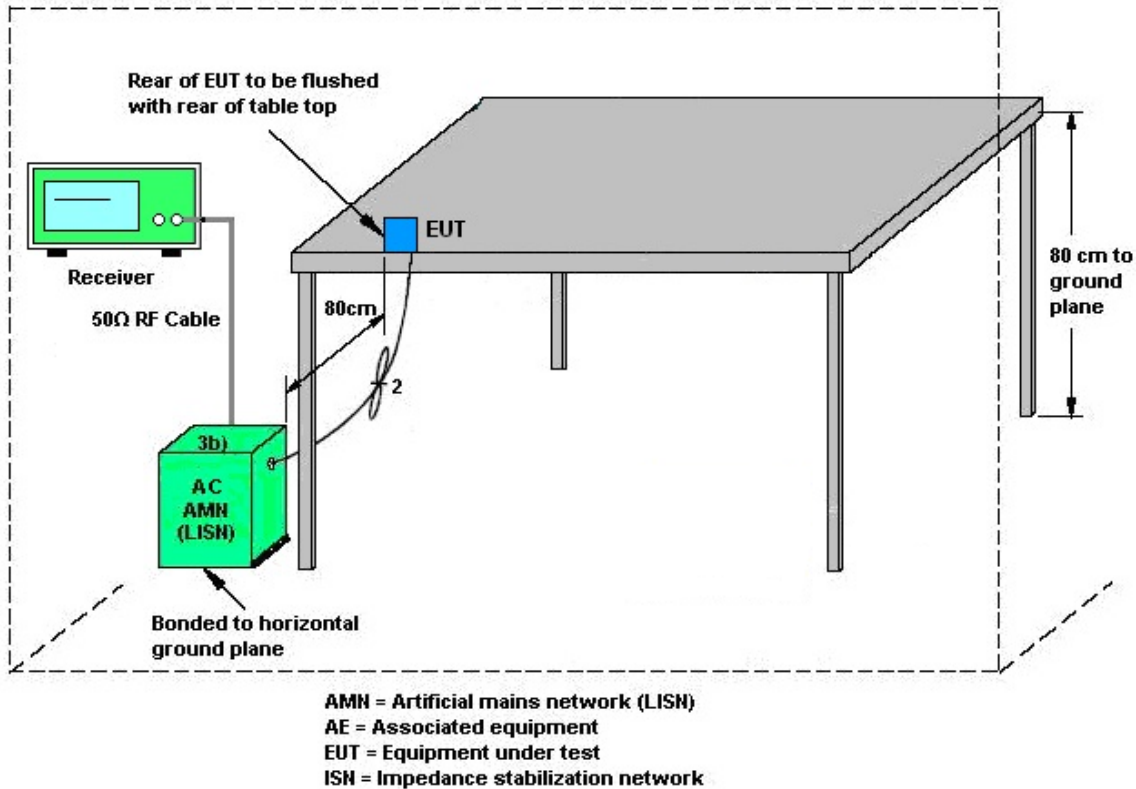

3.9.5 Test Result of AC Conducted Emission

Please refer to Appendix B.



3.10 Antenna Requirements

3.10.1 Standard Applicable

If directional gain of transmitting antennas is greater than 6dBi, the power shall be reduced by the same level in dB comparing to gain minus 6dBi. The use of a permanently attached antenna or of an antenna that uses a unique coupling to the intentional radiator shall be considered sufficient to comply with the rule.

3.10.2 Antenna Anti-Replacement Construction

An embedded-in antenna design is used.

3.10.3 Antenna Gain

The antenna peak gain of EUT is less than 6 dBi. Therefore, it is not necessary to reduce maximum peak output power limit.



4 List of Measuring Equipment

Instrument	Manufacturer	Model No.	Serial No.	Characteristics	Calibration Date	Test Date	Due Date	Remark
Power Meter	Agilent	E4416A	GB412923 44	NA	Dec. 26, 2016	Jul. 06, 2017~ Jul. 08, 2017	Dec. 25, 2017	Conducted (TH05-HY)
Power Sensor	Agilent	E9327A	US404415 48	50MHz~18GHz	Dec. 26, 2016	Jul. 06, 2017~ Jul. 08, 2017	Dec. 25, 2017	Conducted (TH05-HY)
Spectrum Analyzer	Rohde & Schwarz	FSP40	100055	9kHz-40GHz	Jul. 17, 2016	Jul. 06, 2017~ Jul. 08, 2017	Jul. 16, 2017	Conducted (TH05-HY)
BT Base Station(Measure)	Rohde & Schwarz	CBT	101136	BT 3.0	Sep. 21, 2016	Jul. 06, 2017~ Jul. 08, 2017	Sep. 20, 2017	Conducted (TH05-HY)
AC Power Source	ChainTek	APC-1000W	N/A	N/A	N/A	Jul. 07, 2017	N/A	Conduction (CO05-HY)
EMI Test Receiver	Rohde & Schwarz	ESCI 7	100724	9kHz~7GHz	Aug. 30, 2016	Jul. 07, 2017	Aug. 29, 2017	Conduction (CO05-HY)
LISN	Rohde & Schwarz	ENV216	100080	9kHz~30MHz	Nov. 29, 2016	Jul. 07, 2017	Nov. 28, 2017	Conduction (CO05-HY)
LISN	Rohde & Schwarz	ENV216	100081	9kHz~30MHz	Dec. 06, 2016	Jul. 07, 2017	Dec. 05, 2017	Conduction (CO05-HY)
Spectrum Analyzer	Keysight	N9010A	MY553705 26	N/A	Mar. 15, 2017	Jul. 07, 2017 ~ Jul. 19, 2017	Mar. 14, 2018	Radiation (03CH13-HY)
EMI Test Receiver	Agilent	N9038A(MXE)	MY532900 53	20Hz to 26.5GHz	Jan. 12, 2017	Jul. 07, 2017 ~ Jul. 19, 2017	Jan. 11, 2018	Radiation (03CH13-HY)
Loop Antenna	Rohde & Schwarz	HFH2-Z2	100315	9 kHz~30 MHz	May 15, 2017	Jul. 07, 2017 ~ Jul. 19, 2017	May 14, 2019	Radiation (03CH13-HY)
Bilog Antenna	TESEQ	CBL 6111D&00800 N1D01N-06	40103&04	30MHz to 1GHz	Jan. 07, 2017	Jul. 07, 2017 ~ Jul. 19, 2017	Jan. 06, 2018	Radiation (03CH13-HY)
Horn Antenna	SCHWARZBE CK	BBHA 9120 D	9120D-124 1	1GHz ~ 18GHz	May 02, 2017	Jul. 07, 2017 ~ Jul. 19, 2017	May 01, 2018	Radiation (03CH13-HY)
SHF-EHF Horn Antenna	SCHWARZBE CK	BBHA 9170	BBHA9170 584	18GHz- 40GHz	Nov. 08, 2016	Jul. 07, 2017 ~ Jul. 19, 2017	Nov. 07, 2017	Radiation (03CH13-HY)
Amplifier	Sonoma-Instru ment	310 N	187282	9KHz~1GHz	Dec. 21, 2016	Jul. 07, 2017 ~ Jul. 19, 2017	Dec. 20, 2017	Radiation (03CH13-HY)
Preamplifier	Keysight	83017A	MY532701 47	1GHz~26.5GHz	Jan. 09, 2017	Jul. 07, 2017 ~ Jul. 19, 2017	Jan. 08, 2018	Radiation (03CH13-HY)
Preamplifier	MITEQ	AMF-7D-0010 1800-30-10P	1590074	1GHz~18GHz	May 22, 2017	Jul. 07, 2017 ~ Jul. 19, 2017	May 21, 2018	Radiation (03CH13-HY)
Preamplifier	MITEQ	TTA 1840-35-HG	1887435	18GHz ~ 40GHz	Oct. 13, 2016	Jul. 07, 2017 ~ Jul. 19, 2017	Oct. 12, 2017	Radiation (03CH13-HY)
Antenna Mast	EMEC	AM-BS-4500- B	N/A	1m~4m	N/A	Jul. 07, 2017 ~ Jul. 19, 2017	N/A	Radiation (03CH13-HY)
Turn Table	EMEC	TT2000	N/A	0~360 Degree	N/A	Jul. 07, 2017 ~ Jul. 19, 2017	N/A	Radiation (03CH13-HY)



5 Uncertainty of Evaluation

Uncertainty of Conducted Emission Measurement (150 kHz ~ 30 MHz)

Measuring Uncertainty for a Level of Confidence of 95% ($U = 2Uc(y)$)	2.70
---	------

Uncertainty of Radiated Emission Measurement (30 MHz ~ 1000 MHz)

Measuring Uncertainty for a Level of Confidence of 95% ($U = 2Uc(y)$)	4.90
---	------

Uncertainty of Radiated Emission Measurement (1000 MHz ~ 18000 MHz)

Measuring Uncertainty for a Level of Confidence of 95% ($U = 2Uc(y)$)	5.40
---	------

Uncertainty of Radiated Emission Measurement (18000 MHz ~ 40000 MHz)

Measuring Uncertainty for a Level of Confidence of 95% ($U = 2Uc(y)$)	4.30
---	------

Appendix A. Test Result of Conducted Test Items

Test Engineer:	Aking chang	Temperature:	21~25	°C
Test Date:	2017/7/6~2017/7/8	Relative Humidity:	51~54	%

TEST RESULTS DATA
20dB and Hopping Channel Separation

Mod.	Data Rate	NTX	CH.	Freq. (MHz)	20db BW (MHz)	Hopping Channel Separation Measurement (MHz)	Hopping Channel Separation Measurement Limit (MHz)	Pass/Fail
DH	1Mbps	1	0	2402	0.98	1.00	0.6507	Pass
DH	1Mbps	1	39	2441	0.97	1.00	0.6453	Pass
DH	1Mbps	1	78	2480	0.97	1.00	0.6480	Pass
2DH	2Mbps	1	0	2402	1.35	1.00	0.9013	Pass
2DH	2Mbps	1	39	2441	1.35	1.00	0.8987	Pass
2DH	2Mbps	1	78	2480	1.34	1.00	0.8960	Pass
3DH	3Mbps	1	0	2402	1.31	1.00	0.8747	Pass
3DH	3Mbps	1	39	2441	1.30	1.00	0.8640	Pass
3DH	3Mbps	1	78	2480	1.30	1.00	0.8667	Pass

TEST RESULTS DATA
99% Bandwidth

Mod.	Data Rate	NTX	CH.	Freq. (MHz)	99% Bandwidth (MHz)
DH	1Mbps	1	0	2402	0.884
DH	1Mbps	1	39	2441	0.884
DH	1Mbps	1	78	2480	0.888
2DH	2Mbps	1	0	2402	1.204
2DH	2Mbps	1	39	2441	1.204
2DH	2Mbps	1	78	2480	1.208
3DH	3Mbps	1	0	2402	1.184
3DH	3Mbps	1	39	2441	1.184
3DH	3Mbps	1	78	2480	1.184

TEST RESULTS DATA
Dwell Time

Mod.	Hopping Channel Number Rate	Hops Over Occupancy Time(hops)	Package Transfer Time (msec)	Dwell Time (sec)	Limits (sec)	Pass/Fail
Nomal	79	106.67	2.90	0.31	0.4	Pass
AFH	20	53.33	2.90	0.15	0.4	Pass

TEST RESULTS DATA**Peak Power Table**

DH	channel		Peak Power (dBm)	Power Limit (dBm)	Test Result
DH1	0	1	9.74	20.97	Pass
	39	1	10.41	20.97	Pass
	78	1	9.62	20.97	Pass

2DH	channel		Peak Power (dBm)	Power Limit (dBm)	Test Result
2DH1	0	1	8.08	20.97	Pass
	39	1	9.02	20.97	Pass
	78	1	8.71	20.97	Pass

3DH	channel		Peak Power (dBm)	Power Limit (dBm)	Test Result
3DH1	0	1	8.36	20.97	Pass
	39	1	9.30	20.97	Pass
	78	1	8.90	20.97	Pass

TEST RESULTS DATA**Number of Hopping Frequency**

Number of Hopping (Channel)	Adaptive Frequency Hopping (Channel)	Limits (Channel)	Pass/Fail
79	20	>15	Pass



Appendix B. AC Conducted Emission Test Results

Test Engineer :	Eric Jeng	Temperature :	22~24°C
		Relative Humidity :	51~53%

EUT Information

Report NO : 742534-01
 Test Mode : Mode 1
 Test Voltage : 120Vac/60Hz
 Phase : Line

ENV216 Auto Test FCC Power Bar - L

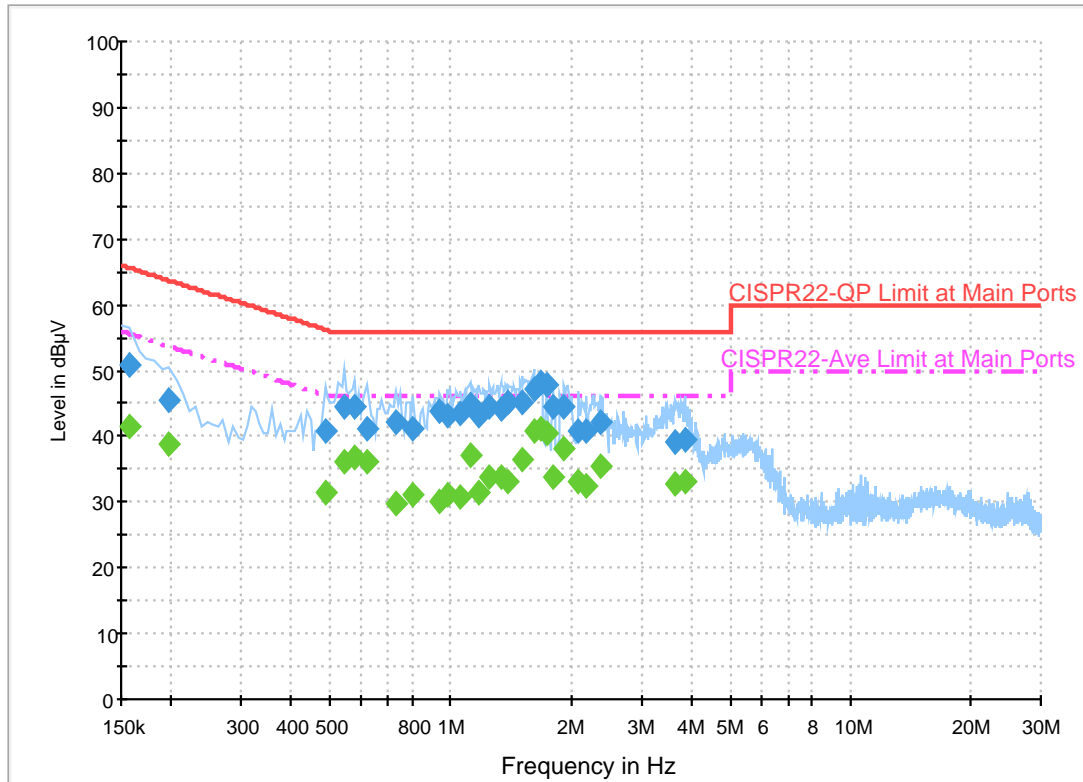

Final Result 1

Frequency (MHz)	QuasiPeak (dBµV)	Filter	Line	Corr. (dB)	Margin (dB)	Limit (dBµV)
0.158000	51.0	Off	L1	19.6	14.6	65.6
0.198000	45.5	Off	L1	19.6	18.2	63.7
0.486000	40.9	Off	L1	19.6	15.3	56.2
0.542000	44.4	Off	L1	19.6	11.6	56.0
0.574000	44.6	Off	L1	19.6	11.4	56.0
0.622000	41.2	Off	L1	19.6	14.8	56.0
0.734000	42.0	Off	L1	19.6	14.0	56.0
0.806000	41.2	Off	L1	19.6	14.8	56.0
0.942000	43.8	Off	L1	19.6	12.2	56.0
0.982000	43.3	Off	L1	19.6	12.7	56.0
1.062000	43.4	Off	L1	19.6	12.6	56.0
1.118000	45.0	Off	L1	19.6	11.0	56.0
1.174000	43.2	Off	L1	19.6	12.8	56.0
1.254000	44.6	Off	L1	19.6	11.4	56.0
1.334000	44.3	Off	L1	19.6	11.7	56.0
1.398000	45.1	Off	L1	19.6	10.9	56.0
1.510000	45.1	Off	L1	19.6	10.9	56.0
1.614000	47.1	Off	L1	19.6	8.9	56.0
1.686000	48.0	Off	L1	19.6	8.0	56.0
1.734000	47.7	Off	L1	19.6	8.3	56.0
1.814000	44.5	Off	L1	19.6	11.5	56.0
1.926000	44.3	Off	L1	19.6	11.7	56.0
2.094000	40.7	Off	L1	18.0	15.3	56.0

Frequency (MHz)	QuasiPeak (dBμV)	Filter	Line	Corr. (dB)	Margin (dB)	Limit (dBμV)
2.190000	40.8	Off	L1	18.5	15.2	56.0
2.366000	42.1	Off	L1	19.0	13.9	56.0
3.662000	39.2	Off	L1	19.7	16.8	56.0
3.854000	39.6	Off	L1	19.7	16.4	56.0

Final Result 2

Frequency (MHz)	Average (dBμV)	Filter	Line	Corr. (dB)	Margin (dB)	Limit (dBμV)
0.158000	41.4	Off	L1	19.6	14.2	55.6
0.198000	38.9	Off	L1	19.6	14.8	53.7
0.486000	31.5	Off	L1	19.6	14.7	46.2
0.542000	36.1	Off	L1	19.6	9.9	46.0
0.574000	37.0	Off	L1	19.6	9.0	46.0
0.622000	36.1	Off	L1	19.6	9.9	46.0
0.734000	29.9	Off	L1	19.6	16.1	46.0
0.806000	31.1	Off	L1	19.6	14.9	46.0
0.942000	30.2	Off	L1	19.6	15.8	46.0
0.982000	31.0	Off	L1	19.6	15.0	46.0
1.062000	30.9	Off	L1	19.6	15.1	46.0
1.118000	37.2	Off	L1	19.6	8.8	46.0
1.174000	31.6	Off	L1	19.6	14.4	46.0
1.254000	33.8	Off	L1	19.6	12.2	46.0
1.334000	33.8	Off	L1	19.6	12.2	46.0
1.398000	33.1	Off	L1	19.6	12.9	46.0
1.510000	36.6	Off	L1	19.6	9.4	46.0
1.614000	40.7	Off	L1	19.6	5.3	46.0
1.686000	41.2	Off	L1	19.6	4.8	46.0
1.734000	40.5	Off	L1	19.6	5.5	46.0
1.814000	33.9	Off	L1	19.6	12.1	46.0
1.926000	38.3	Off	L1	19.6	7.7	46.0
2.094000	33.2	Off	L1	18.0	12.8	46.0
2.190000	32.3	Off	L1	18.5	13.7	46.0
2.366000	35.5	Off	L1	19.0	10.5	46.0
3.662000	32.9	Off	L1	19.7	13.1	46.0
3.854000	33.0	Off	L1	19.7	13.0	46.0

EUT Information

Report NO : 742534-01
 Test Mode : Mode 1
 Test Voltage : 120Vac/60Hz
 Phase : Neutral

ENV216 Auto Test FCC Power Bar - N

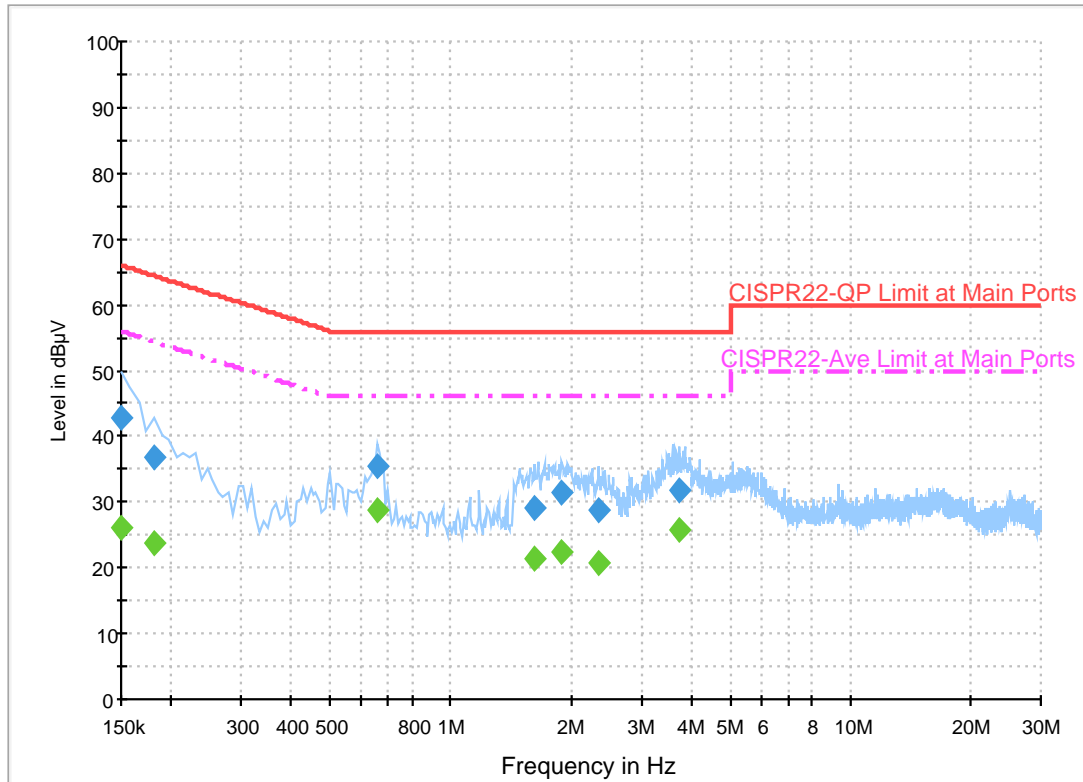

Final Result 1

Frequency (MHz)	QuasiPeak (dBµV)	Filter	Line	Corr. (dB)	Margin (dB)	Limit (dBµV)
0.150000	42.9	Off	N	19.5	23.1	66.0
0.182000	36.7	Off	N	19.5	27.7	64.4
0.654000	35.6	Off	N	19.6	20.4	56.0
1.622000	29.1	Off	N	19.6	26.9	56.0
1.902000	31.4	Off	N	19.6	24.6	56.0
2.350000	28.8	Off	N	19.0	27.2	56.0
3.742000	31.8	Off	N	19.7	24.2	56.0

Final Result 2

Frequency (MHz)	Average (dBµV)	Filter	Line	Corr. (dB)	Margin (dB)	Limit (dBµV)
0.150000	26.2	Off	N	19.5	29.8	56.0
0.182000	23.9	Off	N	19.5	30.5	54.4
0.654000	28.9	Off	N	19.6	17.1	46.0
1.622000	21.5	Off	N	19.6	24.5	46.0
1.902000	22.5	Off	N	19.6	23.5	46.0
2.350000	20.8	Off	N	19.0	25.2	46.0
3.742000	25.6	Off	N	19.7	20.4	46.0



Appendix C. Radiated Spurious Emission

Test Engineer :	Eric Jeng	Temperature :	22~24°C
		Relative Humidity :	51~53%

2.4GHz 2400~2483.5MHz

BT (Band Edge @ 3m)

BT	Note	Frequency (MHz)	Level (dBμV/m)	Over Limit (dB)	Limit Line (dBμV/m)	Read Level (dBμV)	Antenna Factor (dB/m)	Cable Loss (dB)	Preamp Factor (dB)	Ant Pos (cm)	Table Pos (deg)	Peak Avg. (P/A)	Pol. (H/V)
BT CH00 2402MHz		2361.24	42.73	-31.27	74	41.67	27.26	4.8	31	115	107	P	H
		2361.24	17.97	-36.03	54	-	-	-	-	-	-	A	H
	*	2402	105.8	-	-	104.57	27.37	4.85	30.99	115	107	P	H
	*	2402	81.04	-	-	-	-	-	-	-	-	A	H
		2355.78	42	-32	74	40.96	27.26	4.78	31	105	311	P	V
		2355.78	17.24	-36.76	54	-	-	-	-	-	-	A	V
	*	2402	101.35	-	-	100.12	27.37	4.85	30.99	105	311	P	V
	*	2402	76.59	-	-	-	-	-	-	-	-	A	V
BT CH 39 2441MHz		2388.54	41.98	-32.02	74	40.77	27.37	4.83	30.99	111	107	P	H
		2388.54	17.22	-36.78	54	-	-	-	-	-	-	A	H
	*	2442	105.21	-	-	103.77	27.53	4.88	30.97	111	107	P	H
	*	2442	80.45	-	-	-	-	-	-	-	-	A	H
		2494.47	42.51	-31.49	74	40.84	27.7	4.93	30.96	111	107	P	H
		2494.47	17.75	-36.25	54	-	-	-	-	-	-	A	H
		2361.52	41.65	-32.35	74	40.59	27.26	4.8	31	115	311	P	V
		2361.52	16.89	-37.11	54	-	-	-	-	-	-	A	V
	*	2442	101.72	-	-	100.28	27.53	4.88	30.97	115	311	P	V
	*	2442	76.96	-	-	-	-	-	-	-	-	A	V
		2483.97	42.48	-31.52	74	40.88	27.64	4.93	30.97	115	311	P	V
		2483.97	17.72	-36.28	54	-	-	-	-	-	-	A	V



BT CH 78 2480MHz	*	2480	103.81	-	-	102.22	27.64	4.92	30.97	105	112	P	H	
	*	2480	79.05	-	-	-	-	-	-	-	-	A	H	
		2483.96	45.05	-28.95	74	43.45	27.64	4.93	30.97	105	112	P	H	
		2483.96	20.29	-33.71	54	-	-	-	-	-	-	A	H	
	*	2480	100.25	-	-	98.66	27.64	4.92	30.97	113	311	P	V	
	*	2480	75.49	-	-	-	-	-	-	-	-	-	A	V
		2483.88	44.05	-29.95	74	42.45	27.64	4.93	30.97	113	311	P	V	
		2483.88	19.29	-34.71	54	-	-	-	-	-	-	-	A	V
Remark	1. No other spurious found. 2. All results are PASS against Peak and Average limit line.													



**2.4GHz 2400~2483.5MHz
BT (Harmonic @ 3m)**

BT	Note	Frequency (MHz)	Level (dBµV/m)	Over Limit (dB)	Limit Line (dBµV/m)	Read Level (dBµV)	Antenna Factor (dB/m)	Cable Loss (dB)	Preamp Factor (dB)	Ant Pos (cm)	Table Pos (deg)	Peak Avg. (P/A)	Pol. (H/V)
BT CH 00 2402MHz		4804	41.16	-32.84	74	58.85	31.76	7.3	57.27	100	0	P	H
		4804	16.4	-37.6	54	-	-	-	-	-	-	A	H
		4804	39.01	-34.99	74	56.7	31.76	7.3	57.27	100	0	P	V
		4804	14.25	-39.75	54	-	-	-	-	-	-	A	V
BT CH 39 2441MHz		4882	39.59	-34.41	74	56.94	31.88	7.44	57.17	100	0	P	H
		4882	14.83	-39.17	54	-	-	-	-	-	-	A	H
		7323	47.07	-26.93	74	57.54	37.22	9.14	57.29	100	0	P	H
		7323	22.31	-31.69	54	-	-	-	-	-	-	A	H
		4882	39.05	-34.95	74	56.4	31.88	7.44	57.17	100	0	P	V
		4882	14.29	-39.71	54	-	-	-	-	-	-	A	V
		7323	45.84	-28.16	74	56.31	37.22	9.14	57.29	100	0	P	V
		7323	21.08	-32.92	54	-	-	-	-	-	-	A	V
BT CH 78 2480MHz		4960	39.43	-34.57	74	56.36	32.04	7.59	57.05	100	0	P	H
		4960	14.67	-39.33	54	-	-	-	-	-	-	A	H
		7440	45.16	-28.84	74	55.37	37.56	9.21	57.44	100	0	P	H
		7440	20.4	-33.6	54	-	-	-	-	-	-	A	H
		4960	39.72	-34.28	74	56.65	32.04	7.59	57.05	100	0	P	V
		4960	14.96	-39.04	54	-	-	-	-	-	-	A	V
		7440	45.12	-28.88	74	55.33	37.56	9.21	57.44	100	0	P	V
		7440	20.36	-33.64	54	-	-	-	-	-	-	A	V
Remark	1. No other spurious found. 2. All results are PASS against Peak and Average limit line.												



Emission below 1GHz

2.4GHz BT (LF)

BT	Note	Frequency	Level	Over	Limit	Read	Antenna	Cable	Preamp	Ant	Table	Peak	Pol.
		(MHz)	(dBμV/m)	(dB)	(dBμV/m)	(dBμV)	(dB/m)	(dB)	(dB)	(cm)	(deg)	(P/A)	(H/V)
2.4GHz BT LF		93.18	33.39	-10.11	43.5	54.04	10.52	1	32.29	100	0	P	H
		134.49	28.22	-15.28	43.5	45.35	13.91	1.19	32.28	-	-	P	H
		282.45	26.41	-19.59	46	41.37	15.45	1.68	32.16	-	-	P	H
		661.2	34.51	-11.49	46	40.73	23.34	2.51	32.19	-	-	P	H
		704.6	34.5	-11.5	46	40.18	23.74	2.64	32.16	-	-	P	H
		760.6	31.76	-14.24	46	35.79	25.22	2.71	32.06	-	-	P	H
		77.52	29.57	-10.43	40	50.52	10.31	0.95	32.3	100	0	P	V
		108.03	31.14	-12.36	43.5	47.99	14.33	1	32.29	-	-	P	V
		282.18	23.54	-22.46	46	38.5	15.45	1.68	32.16	-	-	P	V
		498.1	32.14	-13.86	46	41.2	20.86	2.2	32.2	-	-	P	V
		666.8	32.99	-13.01	46	39.2	23.35	2.51	32.18	-	-	P	V
	708.1	33.78	-12.22	46	39.3	23.9	2.64	32.16	-	-	P	V	
Remark	1. No other spurious found. 2. All results are PASS against limit line.												



Note symbol

*	Fundamental Frequency which can be ignored. However, the level of any unwanted emissions shall not exceed the level of the fundamental frequency.
!	Test result is over limit line.
P/A	Peak or Average
H/V	Horizontal or Vertical



A calculation example for radiated spurious emission is shown as below:

WIFI	Note	Frequency	Level	Over	Limit	Read	Antenna	Cable	Preamp	Ant	Table	Peak	Pol.
Ant.				Limit	Line	Level	Factor	Loss	Factor	Pos	Pos	Avg.	
1+2		(MHz)	(dBμV/m)	(dB)	(dBμV/m)	(dBμV)	(dB/m)	(dB)	(dB)	(cm)	(deg)	(P/A)	(H/V)
802.11b		2390	55.45	-18.55	74	54.51	32.22	4.58	35.86	103	308	P	H
CH 01													
2412MHz		2390	43.54	-10.46	54	42.6	32.22	4.58	35.86	103	308	A	H

- Level(dBμV/m) =
Antenna Factor(dB/m) + Cable Loss(dB) + Read Level(dBμV) - Preamp Factor(dB)
- Over Limit(dB) = Level(dBμV/m) – Limit Line(dBμV/m)

For Peak Limit @ 2390MHz:

- Level(dBμV/m)
= Antenna Factor(dB/m) + Cable Loss(dB) + Read Level(dBμV) - Preamp Factor(dB)
= 32.22(dB/m) + 4.58(dB) + 54.51(dBμV) – 35.86 (dB)
= 55.45 (dBμV/m)
- Over Limit(dB)
= Level(dBμV/m) – Limit Line(dBμV/m)
= 55.45(dBμV/m) – 74(dBμV/m)
= -18.55(dB)

For Average Limit @ 2390MHz:

- Level(dBμV/m)
= Antenna Factor(dB/m) + Cable Loss(dB) + Read Level(dBμV) - Preamp Factor(dB)
= 32.22(dB/m) + 4.58(dB) + 42.6(dBμV) – 35.86 (dB)
= 43.54 (dBμV/m)
- Over Limit(dB)
= Level(dBμV/m) – Limit Line(dBμV/m)
= 43.54(dBμV/m) – 54(dBμV/m)
= -10.46(dB)

Both peak and average measured complies with the limit line, so test result is “PASS”.



Appendix D. Radiated Spurious Emission Plots

Test Engineer :	Alex Jheng, Bill Chang and Wilson Wu	Temperature :	24.0~24.3°C
		Relative Humidity :	50~52%

2.4GHz 2400~2483.5MHz

BT (Band Edge @ 3m)

BT	2.4GHz 2400~2483.5MHz Band Edge @ 3m	
ANT	BT CH00 2402MHz	
3	Horizontal	Fundamental
Peak	<p>Site : 03CH13-HY Condition : PEAK BE 74 3m HORN 9120D 1522 HORIZONTAL</p>	<p>Site : 03CH13-HY Condition : PEAK 74 3m HORN 9120D 1522 HORIZONTAL</p>

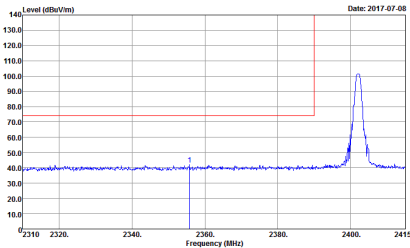
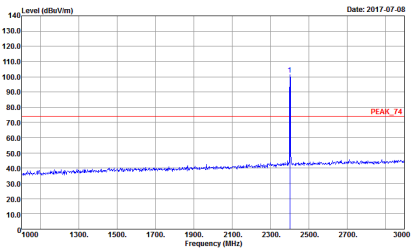

BT	2.4GHz 2400~2483.5MHz Band Edge @ 3m	
ANT	BT CH00 2402MHz	
3	Vertical	Fundamental
Peak	 <p>Site : 03CH13-HY Condition : PEAK BE 74 3m HORN 9120D 1522 VERTICAL</p>	 <p>Site : 03CH13-HY Condition : PEAK 74 3m HORN 9120D 1522 VERTICAL</p>

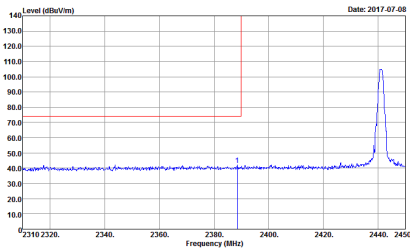
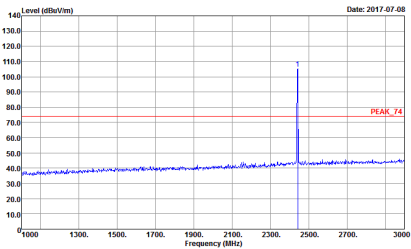
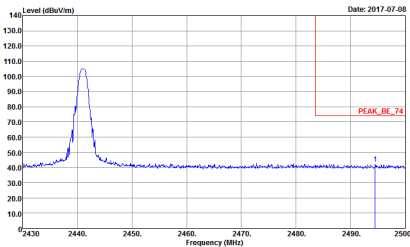

BT	2.4GHz 2400~2483.5MHz Band Edge @ 3m	
ANT	BT CH39 2441MHz	
3	Horizontal	Fundamental
Peak	 <p>Site : 03CH13-HY Condition : PEAK BE 74 3m HORN 9120D 1522 HORIZONTAL</p>	 <p>Site : 03CH13-HY Condition : PEAK 74 3m HORN 9120D 1522 HORIZONTAL</p>
Peak	 <p>Site : 03CH13-HY Condition : PEAK BE 74 3m HORN 9120D 1522 HORIZONTAL</p>	Left blank

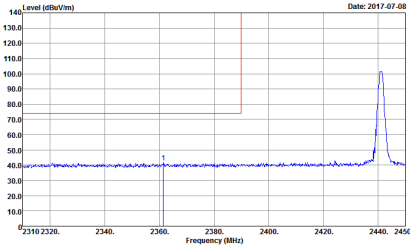
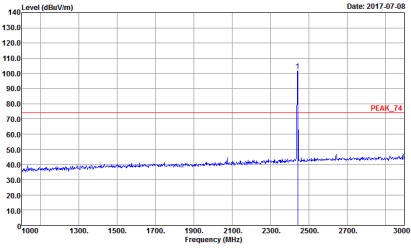
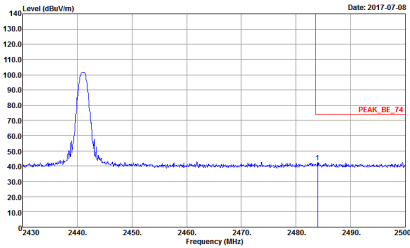

BT	2.4GHz 2400~2483.5MHz Band Edge @ 3m	
ANT	BT CH39 2441MHz	
3	Vertical	Fundamental
Peak	 <p>Date: 2017-07-08</p> <p>Site : 03CH13-HY Condition : PEAK BE 74 3m HORN 9120D 1522 VERTICAL</p>	 <p>Date: 2017-07-08</p> <p>Site : 03CH13-HY Condition : PEAK 74 3m HORN 9120D 1522 VERTICAL</p>
Peak	 <p>Date: 2017-07-08</p> <p>Site : 03CH13-HY Condition : PEAK BE 74 3m HORN 9120D 1522 VERTICAL</p>	Left blank

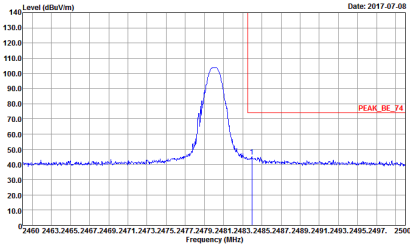
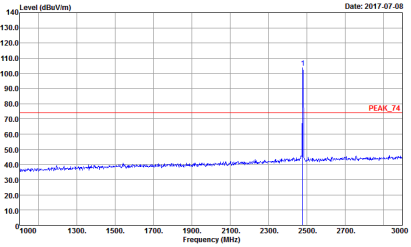

BT	2.4GHz 2400~2483.5MHz Band Edge @ 3m	
ANT	BT CH78 2480MHz	
3	Horizontal	Fundamental
Peak	 <p>Date: 2017-07-08</p> <p>Site : 03CH13-HY Condition : PEAK BE 74 3m HORN 9120d 1522 HORIZONTAL</p>	 <p>Date: 2017-07-08</p> <p>Site : 03CH13-HY Condition : PEAK 74 3m HORN 9120D 1522 HORIZONTAL</p>



BT	2.4GHz 2400~2483.5MHz Band Edge @ 3m	
ANT	BT CH78 2480MHZ	
3	Vertical	Fundamental
Peak	<p>Site : 03CH13-HY Condition : PEAK BE 74 3m HORN 9120D 1522 VERTICAL</p>	<p>Site : 03CH13-HY Condition : PEAK 74 3m HORN 9120D 1522 VERTICAL</p>



2.4GHz 2400~2483.5MHz

BT (Harmonic @ 3m)

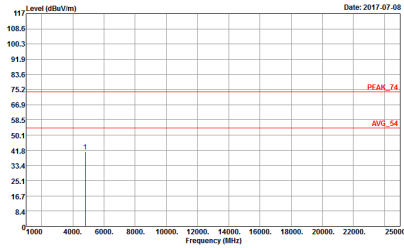
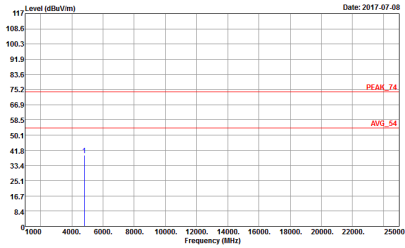
BT	2.4GHz 2400~2483.5MHz Harmonic @ 3m	
ANT	BT CH00 2402MHz	
3	Horizontal	Vertical
<p>Peak</p> <p>Avg.</p>	 <p>Site : 03CH13-HY Condition : PEAK 74 3m SHF HORN 584 HORIZONTAL</p>	 <p>Site : 03CH13-HY Condition : PEAK 74 3m SHF HORN 584 VERTICAL</p>



BT	2.4GHz 2400~2483.5MHz Harmonic @ 3m	
ANT	BT CH39 2441MHz	
3	Horizontal	Vertical
Peak Avg.	<p>Site : 03CH13-HY Condition : PEAK 74 3m SHF HORN 584 HORIZONTAL</p>	<p>Site : 03CH13-HY Condition : PEAK 74 3m SHF HORN 584 VERTICAL</p>



BT	2.4GHz 2400~2483.5MHz Harmonic @ 3m	
ANT	BT CH78 2480MHz	
3	Horizontal	Vertical
Peak Avg.	<p>Site : 03CH13-HY Condition : PEAK 74 3m SHF HORN 584 HORIZONTAL</p>	<p>Site : 03CH13-HY Condition : PEAK 74 3m SHF HORN 584 VERTICAL</p>



Emission below 1GHz

2.4GHz BT (LF)

BT	2.4GHz 2400~2483.5MHz	
ANT	BT LF	
3	Horizontal	Vertical
QP / Peak	<p>Horizontal emission spectrum plot showing Level (dBuV/m) vs Frequency (MHz) from 30 to 1000 MHz. The plot shows a blue signal line with several peaks and a red limit line. The date is 2017.07.12. Site: 03CH13-HY, Condition: QP 3m BILOG 40103 HORIZONTAL.</p>	<p>Vertical emission spectrum plot showing Level (dBuV/m) vs Frequency (MHz) from 30 to 1000 MHz. The plot shows a blue signal line with several peaks and a red limit line. The date is 2017.07.12. Site: 03CH13-HY, Condition: QP 3m BILOG 40103 VERTICAL.</p>

Appendix E. Duty Cycle Plots

DH5 on time (One Pulse) Plot on Channel 39

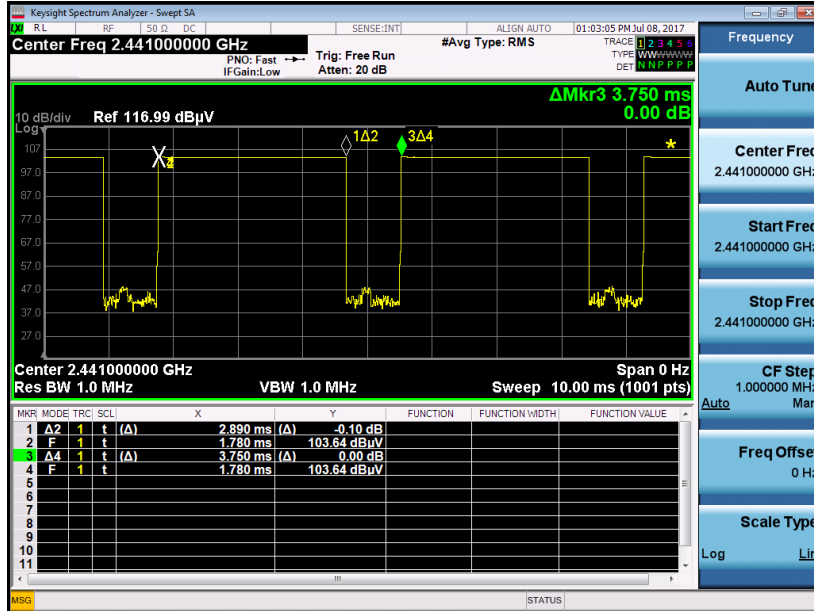

on time (Count Pulses) Plot on Channel 39

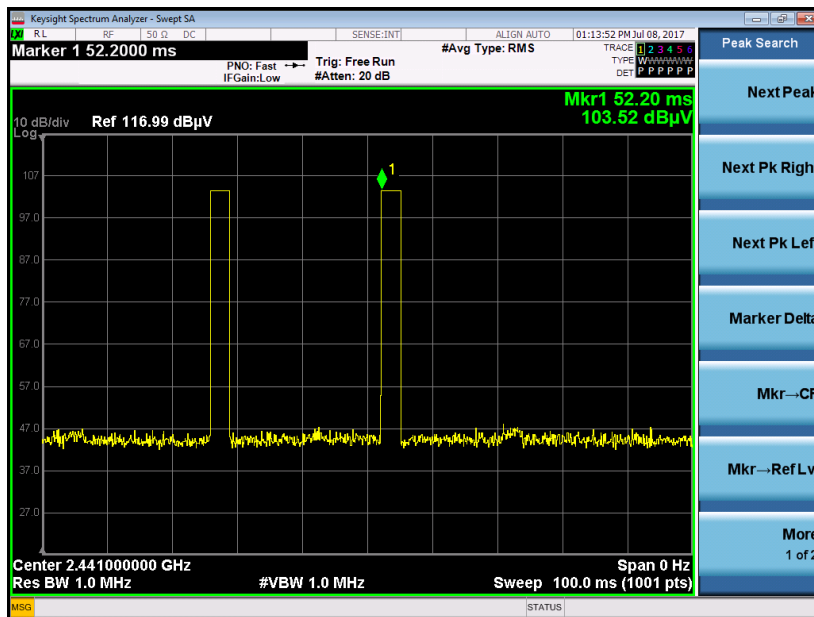

Note:

1. Worst case Duty cycle = on time/100 milliseconds = 2 * 2.88 / 100 = 5.76 %
2. Worst case Duty cycle correction factor = 20*log(Duty cycle) = -24.82 dB
3. DH5 has the highest duty cycle worst case and is reported.



Duty Cycle Correction Factor Consideration for AFH mode:

Bluetooth normal hopping rate is 1600Hz and reduced to 800Hz in AFH mode; due to the reduced number of hopping frequencies, with the same packet configuration the dwell time in each channel frequency within 100msec period is longer in AFH mode than normal mode.

In AFH mode, the minimum hopping frequencies are 20, to get the longest dwell time DH5 packet is observed; the period to have DH5 packet completing one hopping sequence is

$$2.88 \text{ ms} \times 20 \text{ channels} = 57.6 \text{ ms}$$

There cannot be 2 complete hopping sequences within 100ms period, considering the random hopping behavior, maximum 2 hops can be possibly observed within the period. $[100\text{ms} / 57.6\text{ms}] = 2$ hops

Thus, the maximum possible ON time:

$$2.88 \text{ ms} \times 2 = 5.76 \text{ ms}$$

Worst case Duty Cycle Correction factor, which is derived from the maximum possible ON time,

$$20 \times \log(5.76 \text{ ms}/100\text{ms}) = -24.82 \text{ dB}$$