



VARIANT FCC TEST REPORT (PART 90)

Applicant:	SIMCom Wireless Solutions Limited
Address:	Building 3, No.289 Linhong Road Shanghai China 200335

Manufacturer or Supplier	SIMCom Wireless Solutions Limited
Address	Building 3, No.289 Linhong Road Shanghai China 200335
Product	SIM7672NA
Brand Name	SIMCom
Model Name	SIM7672NA
FCC ID	2AJYU-8XS0003
Date of tests	Aug. 22, 2023 ~ Nov. 01, 2023

The tests have been carried out according to the requirements of the following standard:

- FCC Part 90, Subpart R, S ANSI/TIA/EIA-603- D
- FCC Part 2 ANSI/TIA/EIA-603-E ANSI C63.26-2015

CONCLUSION: The submitted sample was found to COMPLY with the test requirement

Prepared by Chao Wu Engineer / Mobile Department	Approved by Peibo Sun Manager / Mobile Department
Date: Nov. 01, 2023	Date: Nov. 01, 2023

This report is governed by, and incorporates by reference, the Conditions of Testing as posted at the date of issuance of this report at <http://www.bureauveritas.com/home/about-us/our-business/cps/about-us/terms-conditions> and is intended for your exclusive use. Any copying or replication of this report to or for any other person or entity, or use of our name or trademark, is permitted only with our prior written permission. This report sets forth our findings solely with respect to the test samples identified herein. The results set forth in this report are not indicative or representative of the quality or characteristics of the lot from which a test sample was taken or any similar or identical product unless specifically and expressly noted. Our report includes all of the tests requested by you and the results thereof based upon the information that you provided to us. Measurement uncertainty is only provided upon request for accredited tests. Statements of conformity are based on simple acceptance criteria without taking measurement uncertainty into account, unless otherwise requested in writing. You have 60 days from date of issuance of this report to notify us of any material error or omission caused by our negligence or if you require measurement uncertainty; provided, however, that such notice shall be in writing and shall specifically address the issue you wish to raise. A failure to raise such issue within the prescribed time shall constitute your unqualified acceptance of the completeness of this report, the tests conducted and the correctness of the report contents.



TABLE OF CONTENTS

RELEASE CONTROL RECORD	4
1 SUMMARY OF TEST RESULTS	5
1.1 MEASUREMENT UNCERTAINTY	6
1.2 TEST SITE AND INSTRUMENTS	7
2 GENERAL INFORMATION.....	9
2.1 GENERAL DESCRIPTION OF EUT	9
2.2 CONFIGURATION OF SYSTEM UNDER TEST	10
2.3 DESCRIPTION OF SUPPORT UNITS	11
2.4 DESCRIPTION OF TEST MODES	11
2.5 GENERAL DESCRIPTION OF APPLIED STANDARDS	13
3 TEST TYPES AND RESULTS	14
3.1 OUTPUT POWER MEASUREMENT	14
3.1.1 LIMITS OF OUTPUT POWER MEASUREMENT	14
3.1.2 TEST PROCEDURES	14
3.1.3 TEST SETUP	15
3.1.4 TEST RESULTS	15
3.2 FREQUENCY STABILITY MEASUREMENT	19
3.2.1 LIMITS OF FREQUENCY STABILITY MEASUREMENT	19
3.2.2 TEST PROCEDURE	19
3.2.3 TEST SETUP	19
3.2.4 TEST RESULTS	20
3.3 OCCUPIED BANDWIDTH MEASUREMENT	21
3.3.1 LIMITS OF OCCUPIED BANDWIDTH MEASUREMENT	21
3.3.2 TEST SETUP	21
3.3.3 TEST PROCEDURES	21
3.3.4 TEST RESULTS	22
3.4 EMISSION MASK MEASUREMENT	23
3.4.1 LIMITS OF EMISSION MASK MEASUREMENT	23
3.4.2 TEST SETUP	23
3.4.3 TEST PROCEDURES	24
3.4.4 TEST RESULTS	25
3.5 CONDUCTED SPURIOUS EMISSIONS	26
3.5.1 LIMITS OF CONDUCTED SPURIOUS EMISSIONS MEASUREMENT	26
3.5.2 TEST PROCEDURE	26
3.5.3 TEST SETUP	26
3.5.4 TEST RESULTS	27
3.6 RADIATED EMISSION MEASUREMENT	28
3.6.1 LIMITS OF RADIATED EMISSION MEASUREMENT	28
3.6.2 TEST PROCEDURES	28
3.6.3 DEVIATION FROM TEST STANDARD	28
3.6.4 TEST SETUP	29
3.6.5 TEST RESULTS	31
3.7 PEAK TO AVERAGE RATIO	37
3.7.1 LIMITS OF PEAK TO AVERAGE RATIO MEASUREMENT	37
3.7.2 TEST SETUP	37
3.7.3 TEST PROCEDURES	37
3.7.4 TEST RESULTS	38
4 INFORMATION ON THE TESTING LABORATORIES	39



5 MODIFICATIONS RECORDERS FOR ENGINEERING CHANGES TO THE EUT BY THE LAB 40

6 APPENDIX..... 41

BAND14 41

PEAK-TO-AVERAGE RATIO(CCDF)..... 41

 TEST RESULT 41

 TEST GRAPHS 42

26DB BANDWIDTH AND OCCUPIED BANDWIDTH..... 44

 TEST RESULT 44

 TEST GRAPHS 45

BAND EDGE..... 48

 TEST RESULT 48

 TEST GRAPHS 49

CONDUCTED SPURIOUS EMISSION 54

 TEST RESULT 54

 TEST GRAPHS 54

FREQUENCY STABILITY..... 62

 TEST RESULT 62



RELEASE CONTROL RECORD

ISSUE NO.	REASON FOR CHANGE	DATE ISSUED
W7L-P23070009RF05	Original release	Sep. 11, 2023
W7L-P23070009-2RF05	Based on the original report product changing the model name and FCC ID, add LTE Band 14, remove LTE Band 7/25/26/38/41, This report is a new test of LTE B14 RF data.	Nov. 01, 2023



1 SUMMARY OF TEST RESULTS

The EUT has been tested according to the following specifications:

APPLIED STANDARD: FCC Part 90 & Part 2		
STANDARD SECTION	TEST TYPE AND LIMIT	RESULT
§2.1046 §90.635(b)	Conducted Output Power (Band14)	PASS
§2.1055 § 90.213 § 90.539	Frequency Stability	PASS
§2.1049 §90.209	Occupied Bandwidth	PASS
§2.1051 § 90.543(e)(f) § 90.691(a)	Emission Masks	PASS
§2.1051 § 90.543(e)(f) § 90.691(a)	Conducted Spurious Emissions	PASS
§2.1053 § 90.691(a)	Radiated Spurious Emissions	PASS

*Test Lab Information Reference

Lab A:

Huarui 7Layers High Technology (Suzhou) Co., Ltd.

Lab Address:

Tower N, Innovation Center, 88 Zhuyi Road, High-tech District, Suzhou City, Anhui Province

Accredited Test Lab Cert 6613.01

The FCC Site Registration No. is 434559; The Designation No. is CN1325.

1.1 MEASUREMENT UNCERTAINTY

Where relevant, the following measurement uncertainty levels have been estimated for tests performed on the EUT as specified in CISPR 16-4-2:

MEASUREMENT	UNCERTAINTY
Maximum Peak Output Power	±2.06dB
Frequency Stability	±76.97Hz
Radiated emissions (9KHz~30MHz)	±2.68dB
Radiated emissions (30MHz~1GHz)	±4.98dB
Radiated emissions (1GHz ~6GHz)	±4.70dB
Radiated emissions (6GHz ~18GHz)	±4.60dB
Radiated emissions (18GHz ~40GHz)	±4.12dB
Conducted emissions	±4.01dB
Occupied Channel Bandwidth	±43.58KHz
Band Edge Measurements	±4.70dB
Peak to average ratio	±0.76dB

This uncertainty represents an expanded uncertainty expressed at approximately the 95% confidence level using a coverage factor of k=2.



**BUREAU
VERITAS**

Test Report No.: W7L-P23070009-2RF05

1.2 TEST SITE AND INSTRUMENTS

Equipment	Manufacturer	Model No.	Serial No.	Last Cal.	Next Cal.
Pre-Amplifier	R&S	SCU18F1	100815	Aug.30,22	Aug.29,24
Pre-Amplifier	R&S	SCU08F1	101028	Sep.16,22	Sep.15,24
Vector Signal Generator	R&S	SMBV100B	102176	Feb.16,22	Feb.15,24
Signal Generator	R&S	SMB100A	182185	Feb.16,22	Feb.15,24
3m Fully-anechoic Chamber	TDK	9m*6m*6m	HRSW-SZ-E MC-01Cham ber	Nov.25,22	Nov.24,25
3m Semi-anechoic Chamber	TDK	9m*6m*6m	HRSW-SZ-E MC-02Cham ber	Nov.25,22	Nov.24,25
EMI TEST Receiver	R&S	ESR26	101734	Feb.25,22	Feb.24,24
EMI TEST Receiver	R&S	ESW44	101973	Feb.25,22	Feb.24,24
Bilog Antenna	SCHWARZBECK	VULB 9163	1264	Feb.28,22	Feb.27,24
Horn Antenna	ETS-LINDGREN	3117	227836	Aug.22,22	Aug.21,24
Horn Antenna (18GHz-40GHz)	Steatite Q-par Antennas	QMS 00880	23486	Feb.23,22	Feb.22,24
Horn Antenna	Steatite Q-par Antennas	QMS 00208	23485	Aug.22,22	Aug.21,24
Loop Antenna	SCHWARZ	HFH2-Z2/Z2E	100976	Feb.23,22	Feb.22,24
WIDEBANDRADIO COMMUNICATION TESTER	R&S	CMW500	169399	Jun.27,22	Jun.26,24
Test Software	EMC32	EMC32	N/A	N/A	N/A
Test Software	ELEKTRA	ELEKTRA4.32	N/A	N/A	N/A
Open Switch and Control Unit	R&S	OSP220	101964	Oct.01,22	Sep.30,24
DC Source	HYELEC	HY3010B	551016	Aug.31,22	Aug.30,24
Hygrothermograph	DELI	20210528	SZ014	Sep.06,22	Sep.05,24
PC	LENOVO	E14	HRSW0024	N/A	N/A
TMC-AMI18843A(CABLE)	R&S	HF290-NMNM -7.00M	N/A	N/A	N/A
TMC-AMI18843A(CABLE)	R&S	HF290-NMNM -4.00M	N/A	N/A	N/A
CABLE	R&S	W13.02	N/A	Apr.28,23	Oct.27,23
CABLE	R&S	W13.02	N/A	Oct.27,23	Apr.26,24
CABLE	R&S	W12.14	N/A	Apr.28,23	Oct.27,23
CABLE	R&S	W12.14	N/A	Oct.27,23	Apr.26,24
CABLE	R&S	J12J103539-0 0-1	SEP-03-20- 069	Apr.28,23	Oct.27,23
CABLE	R&S	J12J103539-0 0-1	SEP-03-20- 069	Oct.27,23	Apr.26,24
CABLE	R&S	J12J103539-0 0-1	SEP-03-20- 070	Apr.28,23	Oct.27,23
CABLE	R&S	J12J103539-0 0-1	SEP-03-20- 070	Oct.27,23	Apr.26,24
Temperature Chamber	votsch	VT4002	5856607810 0050	May.31,22	May.30,24



Test Report No.: W7L-P23070009-2RF05

- NOTE:**
1. The calibration interval of the above test instruments is 6 months or 12 months or 36 months and the calibrations are traceable to CEPREI/CHINA, GRGT/CHINA and NIM/CHINA.
 2. The test was performed in 3m Semi-anechoic Chamber and RF Oven Room.
 3. The horn antenna is used only for the measurement of emission frequency above 1GHz if tested.
 4. The FCC Site Registration No. is 434559; The Designation No. is CN1325.

2 GENERAL INFORMATION

2.1 GENERAL DESCRIPTION OF EUT

PRODUCT	SIM7672NA	
BRAND NAME	SIMCom	
MODEL NAME	SIM7672NA	
NOMINAL VOLTAGE	EUT 3.8V	
MODULATION TECHNOLOGY	LTE	QPSK, 16QAM
FREQUENCY RANGE	LTE Band 14 Channel Bandwidth: 5MHz	790.5MHz ~ 795.5MHz
	LTE Band 14 Channel Bandwidth: 10MHz	793MHz
MAX. ERP POWER	LTE Band 14 Channel Bandwidth: 5MHz	199.53mW
	LTE Band 14 Channel Bandwidth: 10MHz	202.77mW
EMISSION DESIGNATOR	LTE Band 14 Channel Bandwidth: 5MHz	QPSK: 4M50G7D 16QAM: 4M50W7D
	LTE Band 14 Channel Bandwidth: 10MHz	QPSK: 8M93G7D 16QAM: 4M82W7D
ANTENNA TYPE	Monopole Antenna	
ANTENNA GAIN	2.23 dBi for LTE Band 14	
HW VERSION	V2.02	
SW VERSION	SIM7672M5A	
I/O PORTS	Refer to user's manual	
DATA CABLE	N/A	
EXTREME TEMPERATURE	-10-55 °C	
EXTREME VOLTAGE	3.2V - 4.2V	

NOTE:

- For a more detailed features description, please refer to the manufacturer's specifications or the user's manual.
- The EUT incorporates a SISO function. Physically, the EUT provides one completed transmitter and one receiver.

MODULATION MODE	TX FUNCTION
LTE	1TX/1RX

- For the test results, the EUT had been tested with all conditions. But only the worst case was shown in test report.

2.2 CONFIGURATION OF SYSTEM UNDER TEST

FOR RADIATION EMISSION TEST

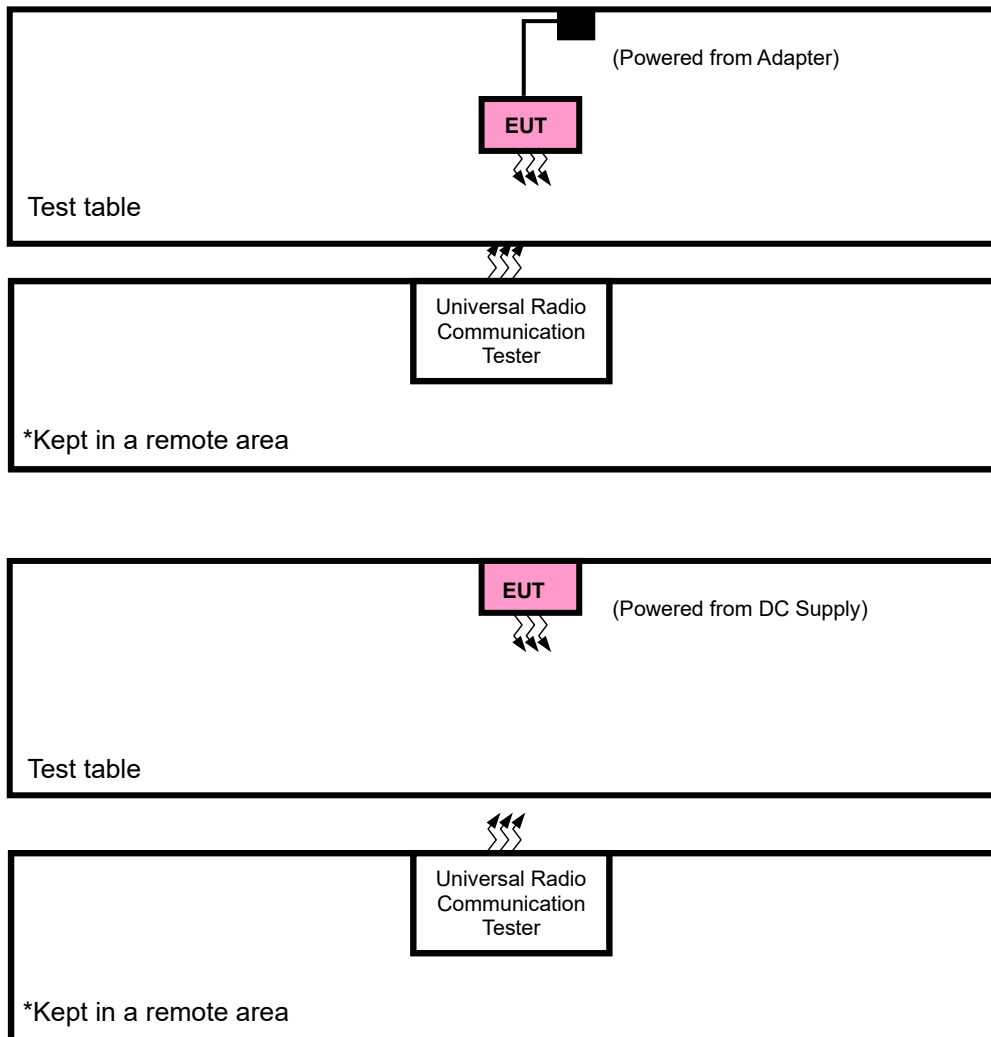



2.3 DESCRIPTION OF SUPPORT UNITS

The EUT has been tested as an independent unit together with other necessary accessories or support units. The following support units or accessories were used to form a representative test configuration during the tests.

NO.	PRODUCT	BRAND	MODEL NO.	SERIAL NO.	FCC ID
1	DC source	HYELEC	HY3010B	551016	N/A
2	Adapter	N/A	N/A	N/A	N/A

NO.	SIGNAL CABLE DESCRIPTION OF THE ABOVE SUPPORT UNITS
1	DC Line: Unshielded, Detachable 1.0m
2	USB Line: Shielded, Detachable 1.0m;

2.4 DESCRIPTION OF TEST MODES

Pre-Scan has been conducted to determine the worst-case mode from all possible combinations between available modulations, data rates, XYZ axis and antenna ports. The worst case in ERP/EIRP and radiated emission was found when positioned on X-plane for LTE. Following channel(s) was (were) selected for the final test as listed below:

EUT CONFIGURE MODE	DESCRIPTION
A	EUT + Adapter with LTE link
B	EUT + DC Supply with LTE link



LTE BAND 14 MODE

EUT CONFIGURE MODE	TEST ITEM	AVAILABLE CHANNEL	TESTED CHANNEL	CHANNEL BANDWIDTH	MODULATION	MODE
A	ERP	23305 to 23355	23305, 23330, 23355	5MHz	QPSK,16QAM,64QAM	1 RB / 0 RB Offset
		23330	23330	10MHz	QPSK,16QAM,64QAM	1 RB / 0 RB Offset
B	FREQUENCY STABILITY	23330	23330	10MHz	QPSK	50 RB / 0 RB Offset
A	OCCUPIED BANDWIDTH	23305 to 23355	23305, 23330, 23355	5MHz	QPSK,16QAM,64QAM	25 RB / 0 RB Offset
		23330	23330	10MHz	QPSK,16QAM,64QAM	50 RB / 0 RB Offset
A	PEAK TO AVERAGE RATIO	23330	23330	10MHz	QPSK,16QAM,64QAM	1 RB / 0 RB Offset 50 RB / 0 RB Offset
A	BAND EDGE	23305 to 23355	23305	5MHz	QPSK,16QAM, 64QAM	1 RB / 0 RB Offset 25 RB / 0 RB Offset
			23355	5MHz	QPSK,16QAM, 64QAM	1 RB / 24 RB Offset 25 RB / 0 RB Offset
		23300	23330	10MHz	QPSK,16QAM, 64QAM	1 RB / 0 RB Offset
						50 RB / 0 RB Offset
						1 RB / 49 RB Offset
						/
A	CONDUCTED EMISSION	23305 to 23355	23305, 23330, 23355	5MHz	QPSK,16QAM,64QAM	1 RB / 0 RB Offset
		23330	23330	10MHz	QPSK,16QAM,64QAM	1 RB / 0 RB Offset
A	RADIATED EMISSION	23305 to 23355	23330	5MHz	QPSK	1 RB / 0 RB Offset
		23330	23330	10MHz	QPSK	1 RB / 0 RB Offset

Note: This device was tested under all bandwidths, RB configurations and modulations. The worst case was found in QPSK modulation.



Test Report No.: W7L-P23070009-2RF05

TEST CONDITION:

TEST ITEM	ENVIRONMENTAL CONDITIONS	INPUT POWER	TESTED BY
EIRP(ERP)	24deg. C, 60%RH	EUT 3.8V	Chao Wu
FREQUENCY STABILITY	24deg. C, 61%RH	DC 3.2V/3.8V/4.2V By DC Supply	Chao Wu
OCCUPIED BANDWIDTH	24deg. C, 61%RH	EUT 3.8V	Chao Wu
BAND EDGE	24deg. C, 61%RH	EUT 3.8V	Chao Wu
CONDUCTED EMISSION	24deg. C, 61%RH	EUT 3.8V	Chao Wu
RADIATED EMISSION	23deg. C, 70%RH	EUT 3.8V	Chao Wu

2.5 GENERAL DESCRIPTION OF APPLIED STANDARDS

The EUT is a RF product. According to the specifications of the manufacturer, it must comply with the requirements of the following standards:

FCC 47 CFR Part 2

FCC 47 CFR Part 90

ANSI/TIA/EIA-603-D

ANSI/TIA/EIA-603-E

ANSI C63.26-2015

NOTE: All test items have been performed and recorded as per the above standards.



3 TEST TYPES AND RESULTS

3.1 OUTPUT POWER MEASUREMENT

3.1.1 LIMITS OF OUTPUT POWER MEASUREMENT

Per FCC Part 90.635 (b)

The maximum output power of the transmitter for mobile stations is 100 watts (20 dBw).

3.1.2 TEST PROCEDURES

EIRP / ERP MEASUREMENT:

Per KDB 971168 D01 Power Meas License Digital Systems v03r01 or subclause 5.2.5.5 of ANSI C63.26-2015, the relevant equation for determining the ERP or EIRP from the conducted RF output power measured using the guidance provided above is:

$$\text{ERP or EIRP} = P_{\text{Meas}} + G_{\text{T}} - L_{\text{C}}$$

Where:

ERP or EIRP = effective radiated power or equivalent isotropically radiated power, respectively

(expressed in the same units as P_{Meas} , typically dBW or dBm);

P_{Meas} = measured transmitter output power or PSD, in dBm or dBW;

G_{T} = gain of the transmitting antenna, in dBd (ERP) or dBi (EIRP);

L_{C} = signal attenuation in the connecting cable between the transmitter and antenna, in dB

CONDUCTED POWER MEASUREMENT:

- a. The EUT was set up for the maximum power with LTE link data modulation and link up with simulator.
- b. Set the EUT to transmit under low, middle and high channel and record the power level shown on simulator.

3.1.3 TEST SETUP

CONDUCTED POWER MEASUREMENT:

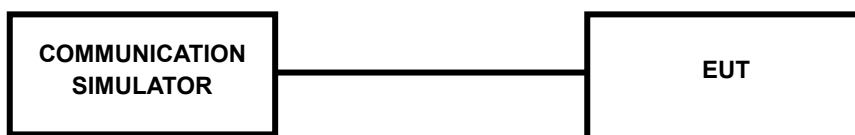

For the actual test configuration, please refer to the attached file (Test Setup Photo).

3.1.4 TEST RESULTS

CONDUCTED OUTPUT POWER (dBm)

LTE Band 14

Band/BW	Modulation	RB Size	RB Offset	Low CH 23305	Mid CH 23330	High CH 23355
				Frequency 790.5 MHz	Frequency 793 MHz	Frequency 795.5 MHz
14/ 5	QPSK	1	0	22.66	22.75	22.74
		1	12	22.88	22.89	22.92
		1	24	22.57	22.57	22.65
		12	0	22.14	22.09	22.02
		12	6	22.15	22.11	22.17
		12	13	22.09	22.18	22.06
		25	0	22.14	22.14	22.17
	16QAM	1	0	22.11	22.20	22.15
		1	12	22.35	22.34	22.30
		1	24	22.04	22.10	22.09
		12	0	22.11	22.05	22.02
		12	6	22.20	22.19	22.25
		12	13	22.05	22.07	22.10
		25	0	21.24	21.21	21.27



**BUREAU
VERITAS**

Test Report No.: W7L-P23070009-2RF05

Band/BW	Modulation	RB Size	RB Offset	/	Mid CH 23330	/
				/	Frequency 793 MHz	/
14/ 10	QPSK	1	0	/	22.77	/
		1	24	/	22.99	/
		1	49	/	22.65	/
		25	0	/	22.14	/
		25	12	/	22.23	/
		25	25	/	22.18	/
		50	0	/	22.21	/
	16QAM	1	0	/	22.20	/
		1	24	/	22.39	/
		1	49	/	22.15	/
		25	0	/	22.14	/
		25	12	/	22.27	/
		25	25	/	22.14	/
		50	0	/	21.32	/



Test Report No.: W7L-P23070009-2RF05

ERP

LTE BAND 14

CHANNEL BANDWIDTH: 5MHz QPSK

Channel	Frequency (MHz)	Conducted Power (dBm)	G _T -L _C (dB)	ERP (dBm)	ERP (mW)	Limit (W)
23305	790.5	22.88	2.23	22.96	197.7	3
23330	793	22.89	2.23	22.97	198.15	3
23355	795.5	22.92	2.23	23	199.53	3

CHANNEL BANDWIDTH: 5MHz 16QAM

Channel	Frequency (MHz)	Conducted Power (dBm)	G _T -L _C (dB)	ERP (dBm)	ERP (mW)	Limit (W)
23305	790.5	22.35	2.23	22.43	174.98	3
23330	793	22.34	2.23	22.42	174.58	3
23355	795.5	22.3	2.23	22.38	172.98	3



Test Report No.: W7L-P23070009-2RF05

CHANNEL BANDWIDTH: 10MHz QPSK

Channel	Frequency (MHz)	Conducted Power (dBm)	G _T -L _c (dB)	ERP (dBm)	ERP (mW)	Limit (W)
-	-	-	-	-	-	-
23330	793	22.99	2.23	23.07	202.77	3
-	-	-	-	-	-	-

CHANNEL BANDWIDTH: 10MHz 16QAM

Channel	Frequency (MHz)	Conducted Power (dBm)	G _T -L _c (dB)	ERP (dBm)	ERP (mW)	Limit (W)
-	-	-	-	-	-	-
23330	793	22.39	2.23	22.47	176.6	3
-	-	-	-	-	-	-

REMARKS: ERP Output Power (dBm) = ERP (dBm) -2.15(dB).

3.2 FREQUENCY STABILITY MEASUREMENT

3.2.1 LIMITS OF FREQUENCY STABILITY MEASUREMENT

The frequency stability of mobile, portable and control transmitters operating in the wideband segment must be 1.25 parts per million or better when AFC is locked to a base station, and 5 parts per million or better when AFC is not locked.

3.2.2 TEST PROCEDURE

- a. Device is placed at the oven room. The oven room could control the temperatures and humidity. Power warm up is at least 15 min and power applied should perform before recording frequency error.
- b. EUT is connected the external power supply to control the DC input power. The test voltage range is from minimum to maximum working voltage. Each step shall be record the frequency error rate.
- c. The temperature range step is 10 degrees in this test items. All temperature levels shall be hold the $\pm 0.5^{\circ}\text{C}$ during the measurement testing. The each temperature step shall be at least 0.5 hours, consider the EUT could be test under the stability condition.

NOTE: The frequency error was recorded frequency error from the communication simulator.

3.2.3 TEST SETUP

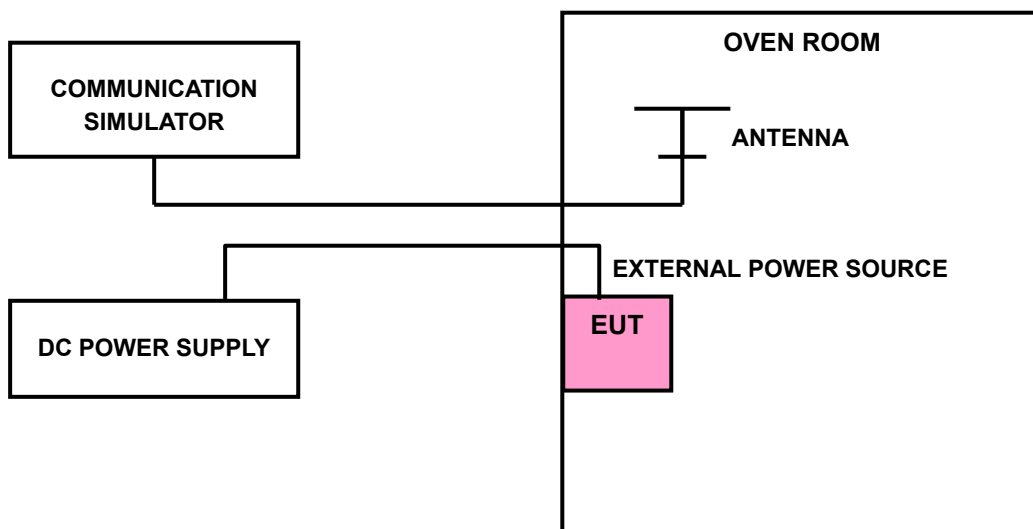



Test Report No.: W7L-P23070009-2RF05

3.2.4 TEST RESULTS

Please Refer to Appendix Of this test report.

Note: VL = Low voltage(3.2V); VN/NV = Normal voltage(3.8V); VH = High voltage(4.2V);
NT = Normal temperature (25°C)

3.3 OCCUPIED BANDWIDTH MEASUREMENT

3.3.1 LIMITS OF OCCUPIED BANDWIDTH MEASUREMENT

The width of a frequency band such that, below the lower and above the upper frequency limits, the mean powers emitted are each equal to a specified percentage 0.5 %of the total mean power of a given emission.

3.3.2 TEST SETUP

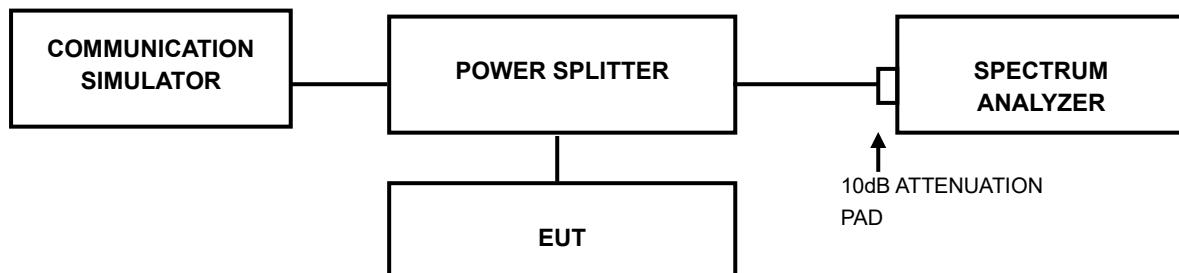

3.3.3 TEST PROCEDURES

- a. The conducted occupied bandwidth used the power splitter via EUT RF power connector between simulation base station and spectrum analyzer.
- b. Use OBW measurement function of Spectrum analyzer to measure 99 % occupied bandwidth.



Test Report No.: W7L-P23070009-2RF05

3.3.4 TEST RESULTS

Please Refer to Appendix Of this test report.

3.4 EMISSION MASK MEASUREMENT

3.4.1 LIMITS OF EMISSION MASK MEASUREMENT

LTE Band26:

According to FCC part 90.691 shall be tested the emission mask. For any frequency removed from the EA licensee's frequency block by up to and including 37.5 kHz, the power of any emission shall be attenuated below the transmitter power (P) in watts by at least $116 \log_{10}(f/6.1)$ decibels or $50 + 10 \log_{10}(P)$ decibels or 80 decibels, whichever is the lesser attenuation, where f is the frequency removed from the center of the outer channel in the block in kilohertz and where f is greater than 12.5 kHz.

For any frequency removed from the EA licensee's frequency block greater than 37.5 kHz, the power of any emission shall be attenuated below the transmitter power (P) in watts by at least $43 + 10 \log_{10}(P)$ decibels or 80 decibels, whichever is the lesser attenuation, where f is the frequency removed from the center of the outer channel in the block in kilohertz and where f is greater than 37.5 kHz.

3.4.2 TEST SETUP

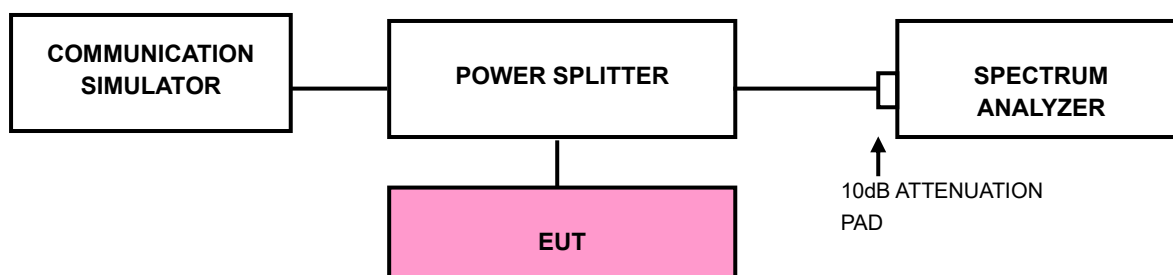



Test Report No.: W7L-P23070009-2RF05

3.4.3 TEST PROCEDURES

- a) Connect the transmitter to the spectrum analyzer via coaxial cable while ensuring proper impedance matching.
- b) Tune the analyzer to the nominal center frequency of the emission bandwidth (EBW).
- c) Set the resolution bandwidth (RBW) $\geq 1\%$ EBW in the 1MHz band immediately outside and adjacent to the band edge.
- d) Beyond the 1MHz band from the band edge, RBW=1MHz was used.
- e) Set the video bandwidth (VBW) to $\geq 3 \times$ RBW.
- f) Select the average power (RMS) display detector.
- g) Set the number of measurement points to ≥ 1001 .
- h) Use auto-coupled sweep time.
- i) Perform the measurement over an interval of time when the transmission is continuous and at its maximum power level.
- j) The RF fundamental frequency should be excluded against the limit line in the operating frequency band and use RBW is 10KHz or 100KHz.
- k) Record the max trace plot into the test report.



Test Report No.: W7L-P23070009-2RF05

3.4.4 TEST RESULTS

Please Refer to Appendix Of this test report.

3.5 CONDUCTED SPURIOUS EMISSIONS

3.5.1 LIMITS OF CONDUCTED SPURIOUS EMISSIONS MEASUREMENT

(1) The power of any emission outside a licensee's frequency block shall be attenuated below the transmitter power (P) by at least $43 + 10 \log_{10}(P)$ dB. The limit of emission equal to -13dBm

(2) For operations in the 763–775 MHz and 793–805 MHz bands, all emissions including harmonics in the band 1559– 1610 MHz shall be limited to -70 dBW/MHz equivalent isotropically radiated power (EIRP) for wideband signals, and -80 dBW EIRP for discrete emissions of less than 700 Hz bandwidth. For the purpose of equipment authorization, a transmitter shall be tested with an antenna that is representative of the type that will be used with the equipment in normal operation.

3.5.2 TEST PROCEDURE

- a. The EUT makes a phone call to the communication simulator. All measurements were done at middle operational frequency range.
- b. Measuring frequency range is from 9kHz up to a frequency including its 10th harmonic. 10dB attenuation pad is connected with spectrum. RBW=1MHz and VBW=3MHz is used for conducted emission measurement.

3.5.3 TEST SETUP

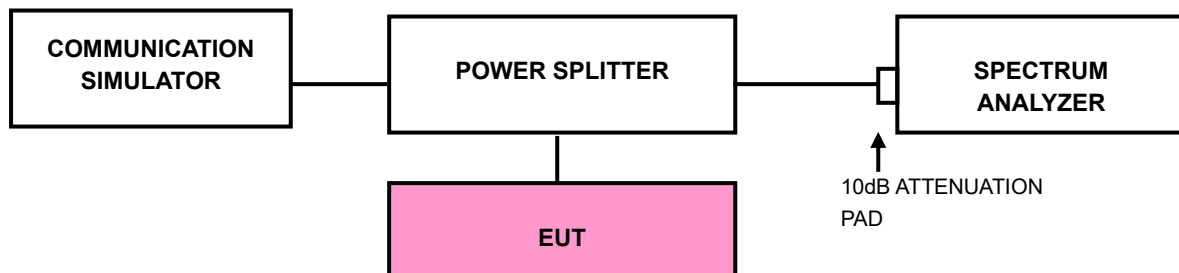



Test Report No.: W7L-P23070009-2RF05

3.5.4 TEST RESULTS

NOTE : The 9K~30MHz amplitude of spurious emissions attenuated more than 20 dB below the permissible value is not required in the report.

Please Refer to Appendix Of this test report.



3.6 RADIATED EMISSION MEASUREMENT

3.6.1 LIMITS OF RADIATED EMISSION MEASUREMENT

(1) The power of any emission outside a licensee's frequency block shall be attenuated below the transmitter power (P) by at least $43 + 10 \log_{10}(P)$ dB. The limit of emission equal to -13dBm

(2) For operations in the 763–775 MHz and 793–805 MHz bands, all emissions including harmonics in the band 1559– 1610 MHz shall be limited to -70 dBW/MHz equivalent isotropically radiated power (EIRP) for wideband signals, and -80 dBW EIRP for discrete emissions of less than 700 Hz bandwidth. For the purpose of equipment authorization, a transmitter shall be tested with an antenna that is representative of the type that will be used with the equipment in normal operation.

3.6.2 TEST PROCEDURES

- a. Substitution method is used for E.I.R.P measurement. In the semi-anechoic chamber, EUT placed on the 0.8m height of Turn Table, rotated the table around 360 degrees to search the maximum radiation power and receiver antenna shall be rotated vertical and horizontal polarization and moved height from 1m to 4m to find the maximum polar radiated power. The “Read Value” is the spectrum reading the maximum power value.
- b. The substitution horn antenna is substituted for EUT at the same position and signals generator export the CW signal to the substitution antenna via a TX cable. Rotated the Turn Table and moved receiving antenna to find the maximum radiation power. Adjust output power level of S.G to get a Value of spectrum reading equal to “Read Value” of step a. Record the power level of S.G
- c. $\text{EIRP} = \text{Output power level of S.G} - \text{TX cable loss} + \text{Antenna gain of substitution horn.}$
- d. E.R.P power can be calculated form E.I.R.P power by subtracting the gain of dipole, $\text{E.R.P power} = \text{E.I.P.R power} - 2.15\text{dBi.}$

NOTE: The resolution bandwidth of spectrum analyzer is 1 MHz and the video bandwidth is 3 MHz.

3.6.3 DEVIATION FROM TEST STANDARD

No deviation

3.6.4 TEST SETUP

<Below 30MHz>

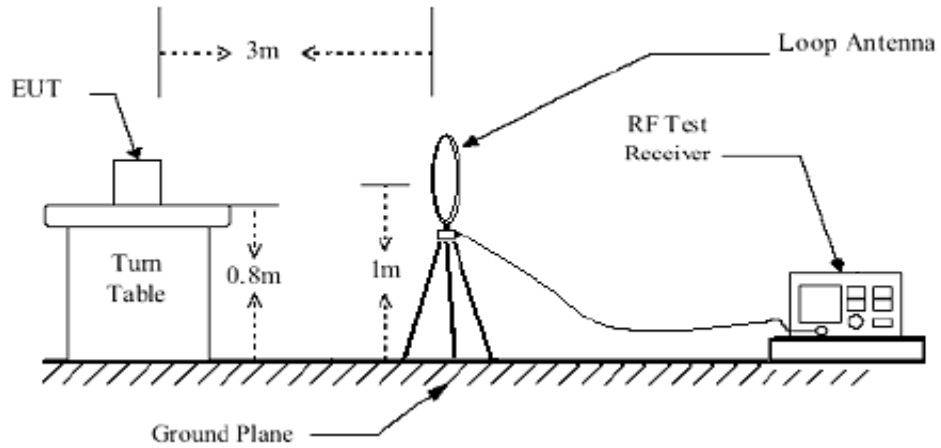

< Frequency Range 30MHz~1GHz >

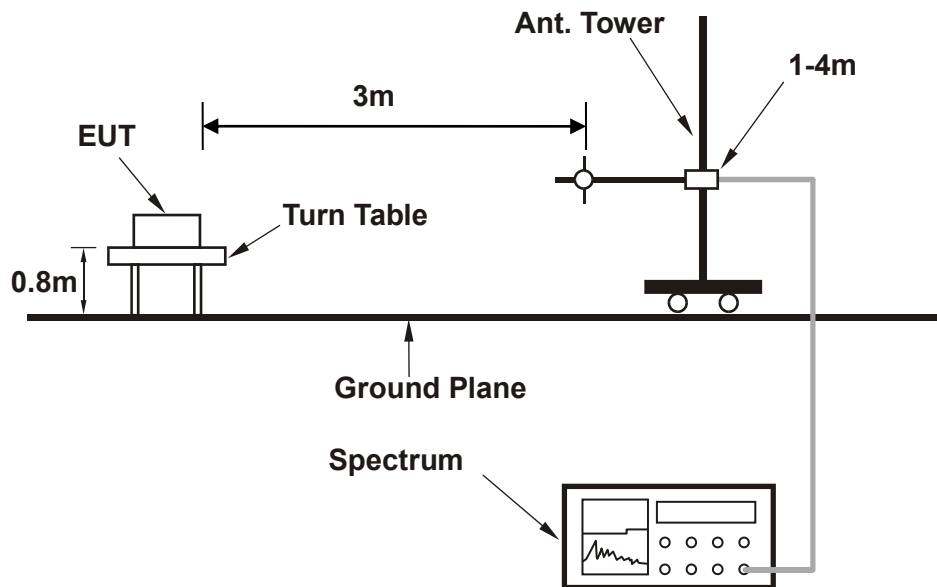

< Frequency Range above 1GHz >

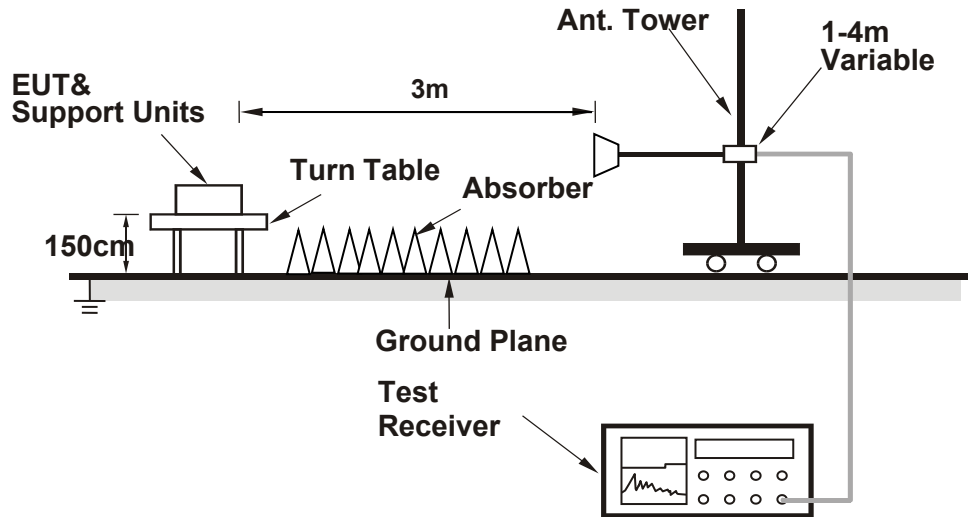

For the actual test configuration, please refer to the attached file (Test Setup Photo).



Test Report No.: W7L-P23070009-2RF05

3.6.5 TEST RESULTS

NOTE : The 9K~30MHz amplitude of spurious emissions attenuated more than 20 dB below the permissible value is not required in the report.

BELOW 1GHz WORST-CASE DATA

30 MHz – 1GHz data:

LTE Band 14:

CHANNEL BANDWIDTH: 10MHz / QPSK

MODE	TX channel 23330	FREQUENCY RANGE	Below 1000MHz
ENVIRONMENTAL CONDITIONS	23deg. C, 70%RH	INPUT POWER	AC 120V/60HZ
TESTED BY	Chao Wu		
ANTENNA POLARITY & TEST DISTANCE: HORIZONTAL AT 3 M			

Rg	Frequency [MHz]	PK+ Level [dBm]	PK+ Limit [dBm]	PK+ Margin [dB]	Correction [dB]	Polarization	Azimuth [deg]	Antenna Height [m]
1	32.600	-60.65	-13.00	47.65	5.13	H	169.4	2
1	47.300	-65.21	-13.00	52.21	2.57	H	263.8	2
1	71.150	-73.11	-13.00	60.11	-3.51	H	155.8	1
1	117.350	-78.16	-13.00	65.16	-5.45	H	187	1
1	232.000	-69.35	-13.00	56.35	8.01	H	0.8	2
1	429.650	-71.05	-13.00	58.05	7.09	H	263.8	2

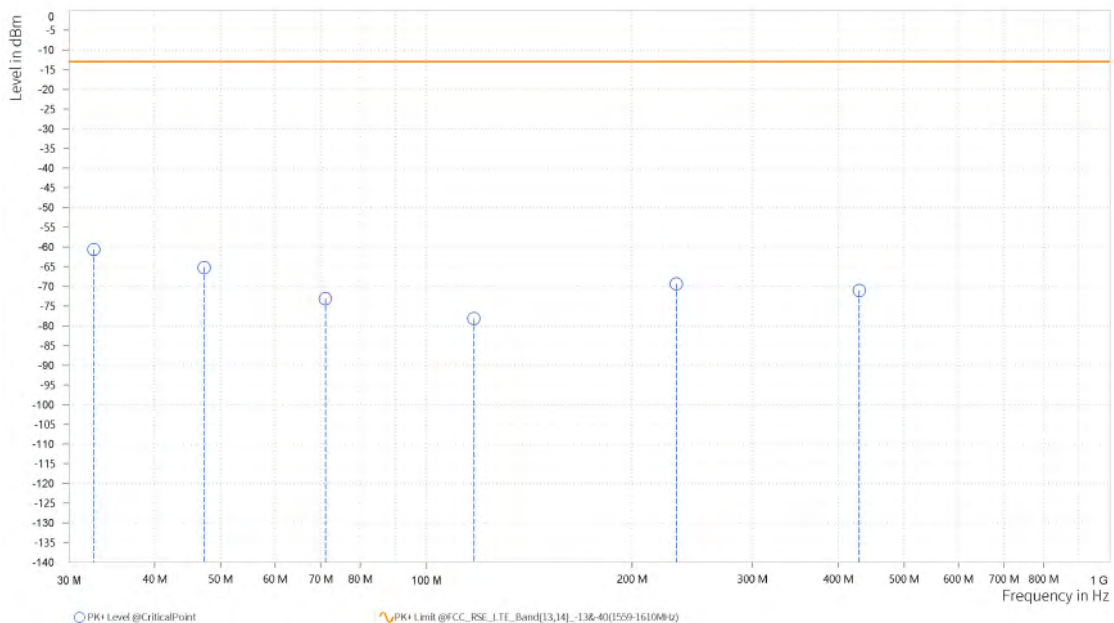



Test Report No.: W7L-P23070009-2RF05

MODE	TX channel 23330	FREQUENCY RANGE	Below 1000MHz
ENVIRONMENTAL CONDITIONS	23deg. C, 70%RH	INPUT POWER	AC 120V/60HZ
TESTED BY	Chao Wu		
ANTENNA POLARITY & TEST DISTANCE: VERTICAL AT 3 M			

Rg	Frequency [MHz]	PK+ Level [dBm]	PK+ Limit [dBm]	PK+ Margin [dB]	Correction [dB]	Polarization	Azimuth [deg]	Antenna Height [m]
1	32.900	-68.25	-13.00	55.25	-0.03	V	359	2
1	58.700	-65.56	-13.00	52.56	2.91	V	357.5	1
1	99.350	-60.67	-13.00	47.67	11.69	V	2.2	2
1	141.150	-77.52	-13.00	64.52	-4.72	V	101.2	2
1	181.100	-76.98	-13.00	63.98	-2.57	V	0.9	2
1	284.350	-73.40	-13.00	60.40	5.14	V	2.2	2

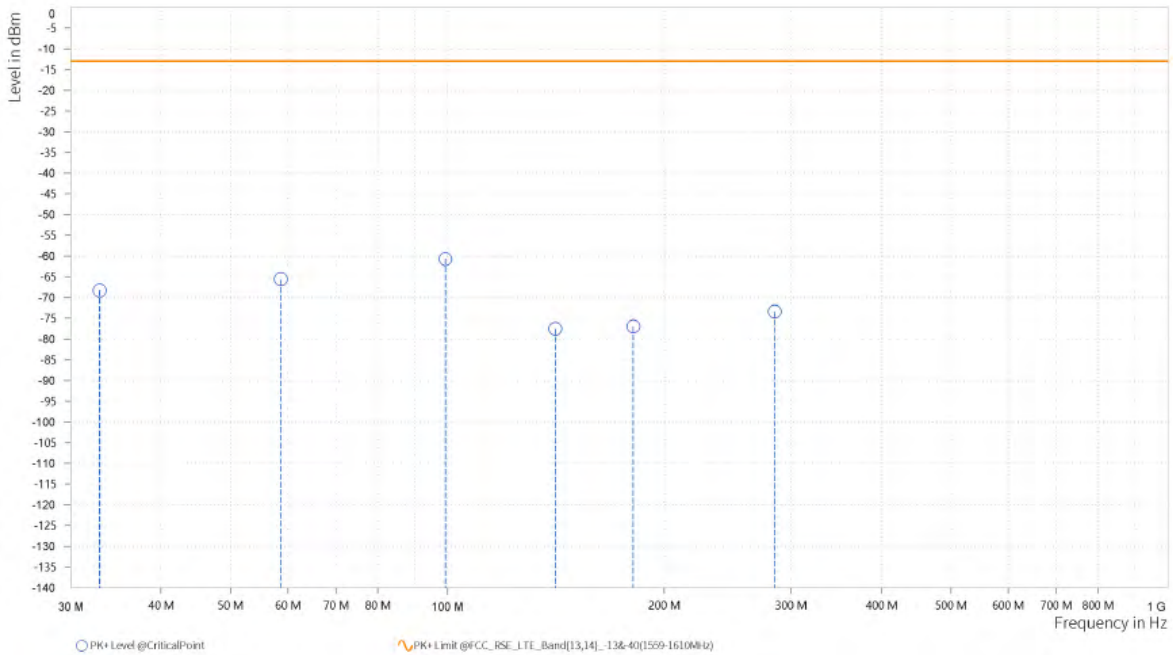



BUREAU
VERITAS

Test Report No.: W7L-P23070009-2RF05

ABOVE 1GHz

Note: For higher frequency, the emission is too low to be detected.

LTE B14

CHANNEL BANDWIDTH: 5MHz / QPSK

CH23330

MODE	TX channel 23330	FREQUENCY RANGE	Above 1000MHz
ENVIRONMENTAL CONDITIONS	23deg. C, 70%RH	INPUT POWER	AC 120V/60HZ
TESTED BY	Chao Wu		
ANTENNA POLARITY & TEST DISTANCE: HORIZONTAL AT 3 M			

Rg	Frequency [MHz]	PK+ Level [dBm]	PK+ Limit [dBm]	PK+ Margin [dB]	Correction [dB]	Polarization	Azimuth [deg]	Antenna Height [m]
2	1,581.500	-59.20	-40.00	19.20	13.74	H	1	1
3	2,372.250	-52.88	-13.00	39.88	21.37	H	354.6	1

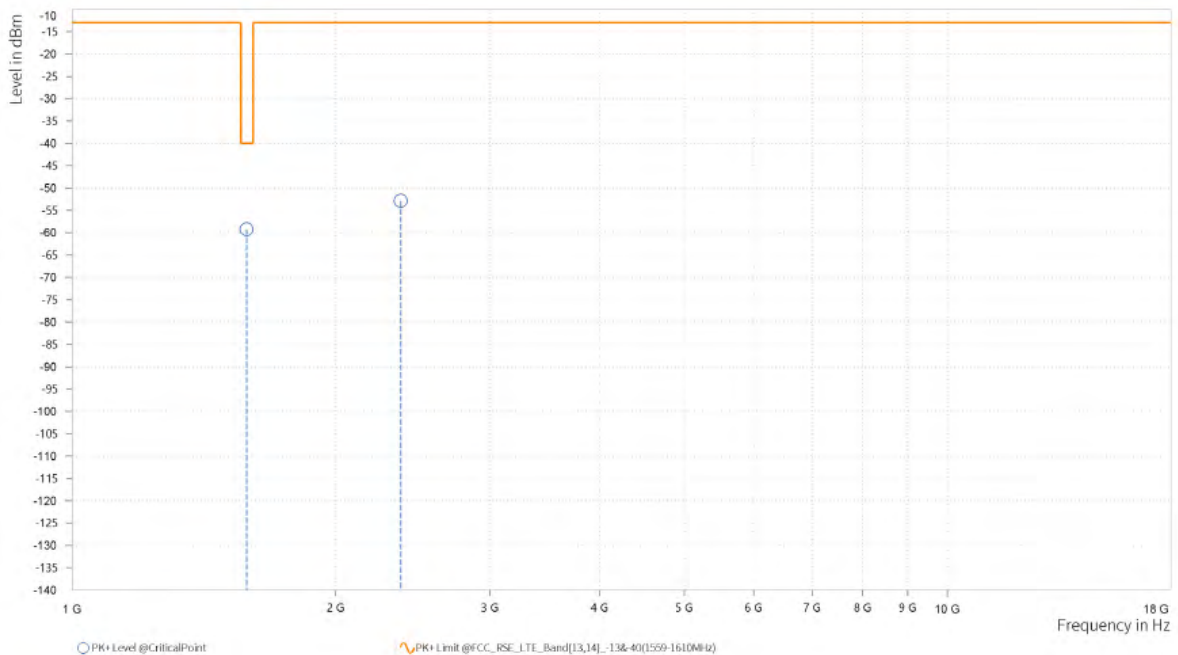



Test Report No.: W7L-P23070009-2RF05

MODE	TX channel 23330	FREQUENCY RANGE	Above 1000MHz
ENVIRONMENTAL CONDITIONS	23deg. C, 70%RH	INPUT POWER	AC 120V/60HZ
TESTED BY	Chao Wu		
ANTENNA POLARITY & TEST DISTANCE: VERTICAL AT 3 M			

Rg	Frequency [MHz]	PK+ Level [dBm]	PK+ Limit [dBm]	PK+ Margin [dB]	Correction [dB]	Polarization	Azimuth [deg]	Antenna Height [m]
2	1,581.500	-58.12	-40.00	18.12	14.87	V	62.6	1
3	2,372.250	-53.17	-13.00	40.17	20.81	V	0.9	2

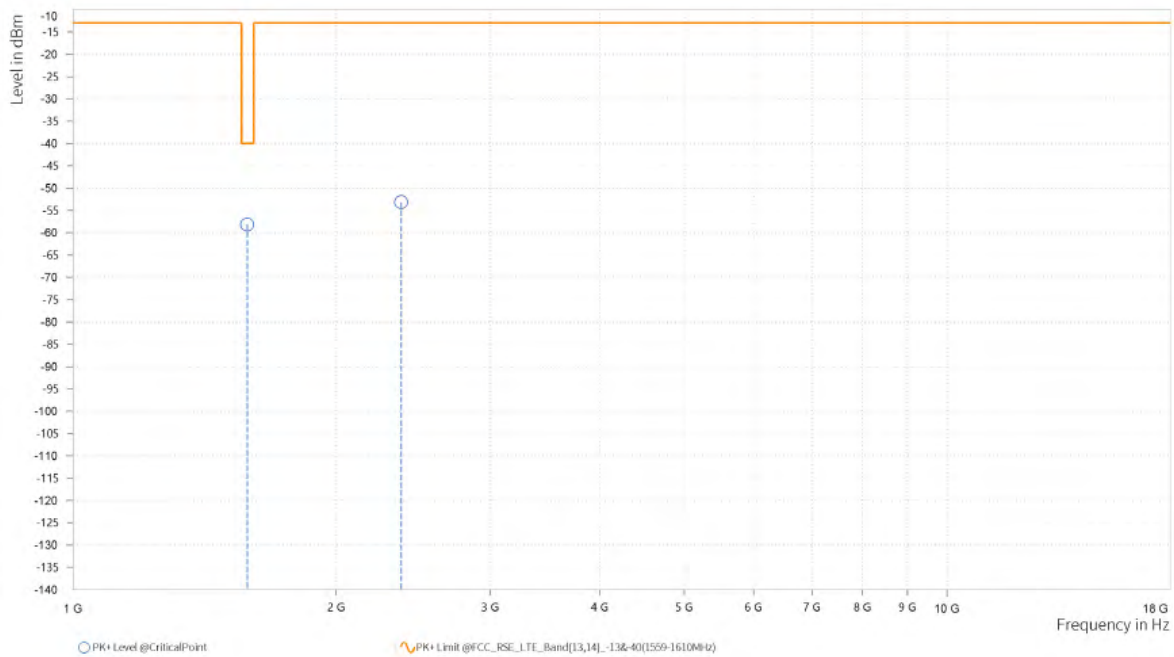



Test Report No.: W7L-P23070009-2RF05

CHANNEL BANDWIDTH: 10MHz / QPSK

CH23330

MODE	TX channel 23330	FREQUENCY RANGE	Above 1000MHz
ENVIRONMENTAL CONDITIONS	23deg. C, 70%RH	INPUT POWER	AC 120V/60HZ
TESTED BY	Chao Wu		
ANTENNA POLARITY & TEST DISTANCE: HORIZONTAL AT 3 M			

Rg	Frequency [MHz]	PK+ Level [dBm]	PK+ Limit [dBm]	PK+ Margin [dB]	Correction [dB]	Polarization	Azimuth [deg]	Antenna Height [m]
2	1,577.000	-60.80	-40.00	20.80	13.65	H	1	2
3	2,365.500	-53.59	-13.00	40.59	21.28	H	1	1

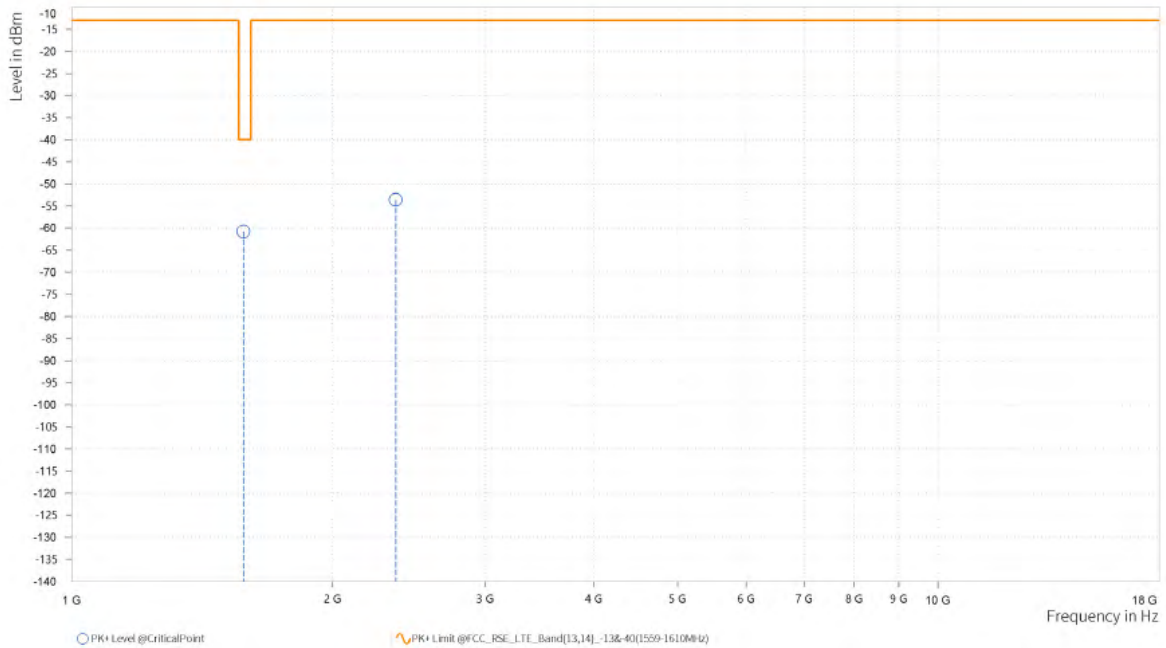



Test Report No.: W7L-P23070009-2RF05

MODE	TX channel 23330	FREQUENCY RANGE	Above 1000MHz
ENVIRONMENTAL CONDITIONS	23deg. C, 70%RH	INPUT POWER	AC 120V/60HZ
TESTED BY	Chao Wu		
ANTENNA POLARITY & TEST DISTANCE: VERTICAL AT 3 M			

Rg	Frequency [MHz]	PK+ Level [dBm]	PK+ Limit [dBm]	PK+ Margin [dB]	Correction [dB]	Polarization	Azimuth [deg]	Antenna Height [m]
2	1,577.000	-57.77	-40.00	17.77	14.85	V	308	2
3	2,365.500	-53.72	-13.00	40.72	20.91	V	259	2

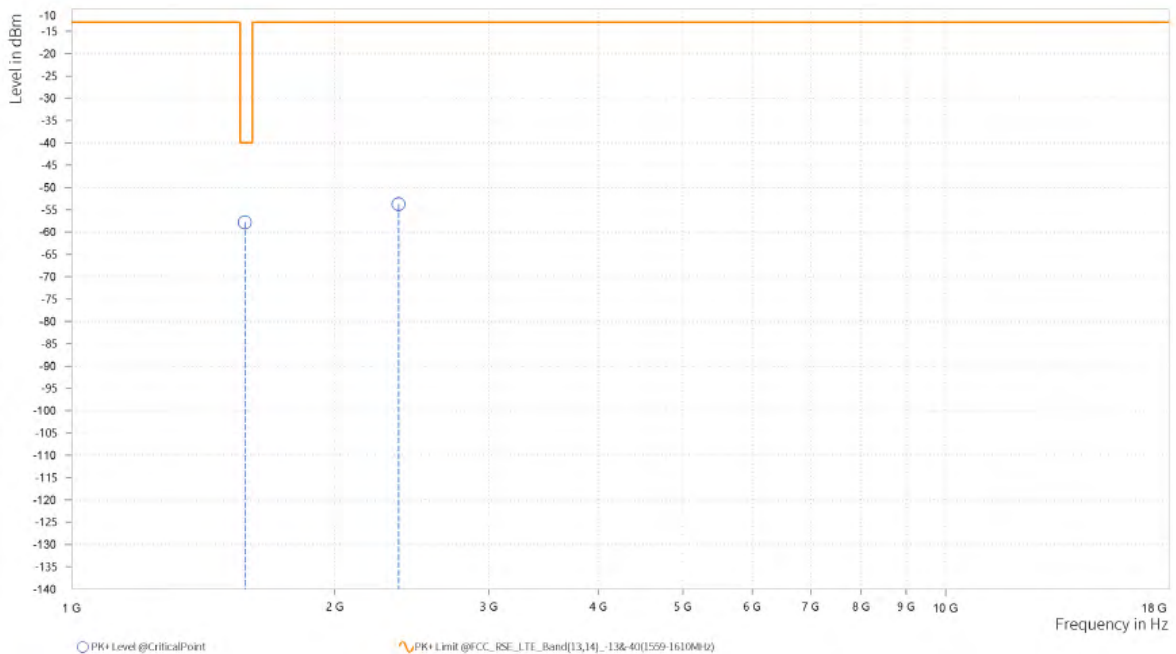



3.7 PEAK TO AVERAGE RATIO

3.7.1 LIMITS OF PEAK TO AVERAGE RATIO MEASUREMENT

In measuring transmissions in this band using an average power technique, the peak to-average ratio (PAR) of the transmission may not exceed 13 dB

3.7.2 TEST SETUP

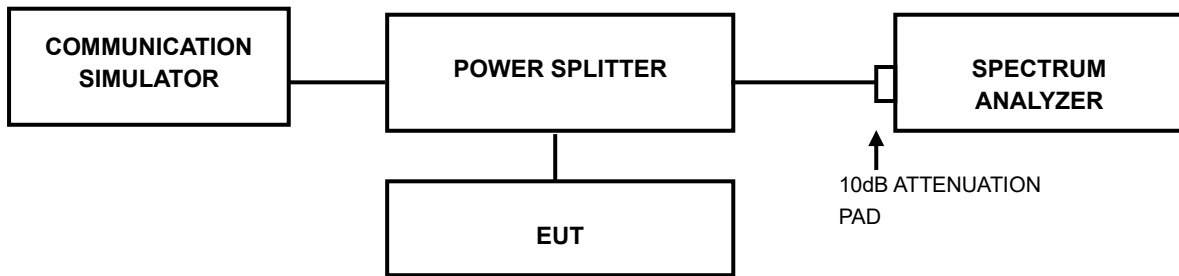

3.7.3 TEST PROCEDURES

1. Set resolution/measurement bandwidth \geq signal's occupied bandwidth;
2. Set the number of counts to a value that stabilizes the measured CCDF curve;
3. Record the maximum PAPR level associated with a probability of 0.1%.



Test Report No.: W7L-P23070009-2RF05

3.7.4 TEST RESULTS

Please Refer to Appendix Of this test report.



Test Report No.: W7L-P23070009-2RF05

4 INFORMATION ON THE TESTING LABORATORIES

We, Huarui 7layers High Technology (Suzhou) Co., Ltd. ,were founded in 2020 to provide our best service in EMC, Radio, Telecom and Safety consultation. Our laboratories are accredited and approved according to ISO/IEC 17025.

If you have any comments, please feel free to contact us at the following:

Suzhou EMC/RF Lab:

Tel: +86 (0557) 368 1008



Test Report No.: W7L-P23070009-2RF05

5 MODIFICATIONS RECORDERS FOR ENGINEERING CHANGES TO THE EUT BY THE LAB

No modifications were made to the EUT by the lab during the test.



Test Report No.: W7L-P23070009-2RF05

6 APPENDIX

BAND14

PEAK-TO-AVERAGE RATIO(CCDF)

Test Result

Band	Bandwidth	Modulation	Channel	RB Configuration	Result(dB)	Limit(dB)	Verdict
Band14	10MHz	QPSK	23330	1RB#0	5.22	13	PASS
Band14	10MHz	QPSK	23330	50RB#0	5.32	13	PASS
Band14	10MHz	16QAM	23330	1RB#0	5.67	13	PASS
Band14	10MHz	16QAM	23330	27RB#0	6.19	13	PASS



Test Report No.: W7L-P23070009-2RF05

Test Graphs

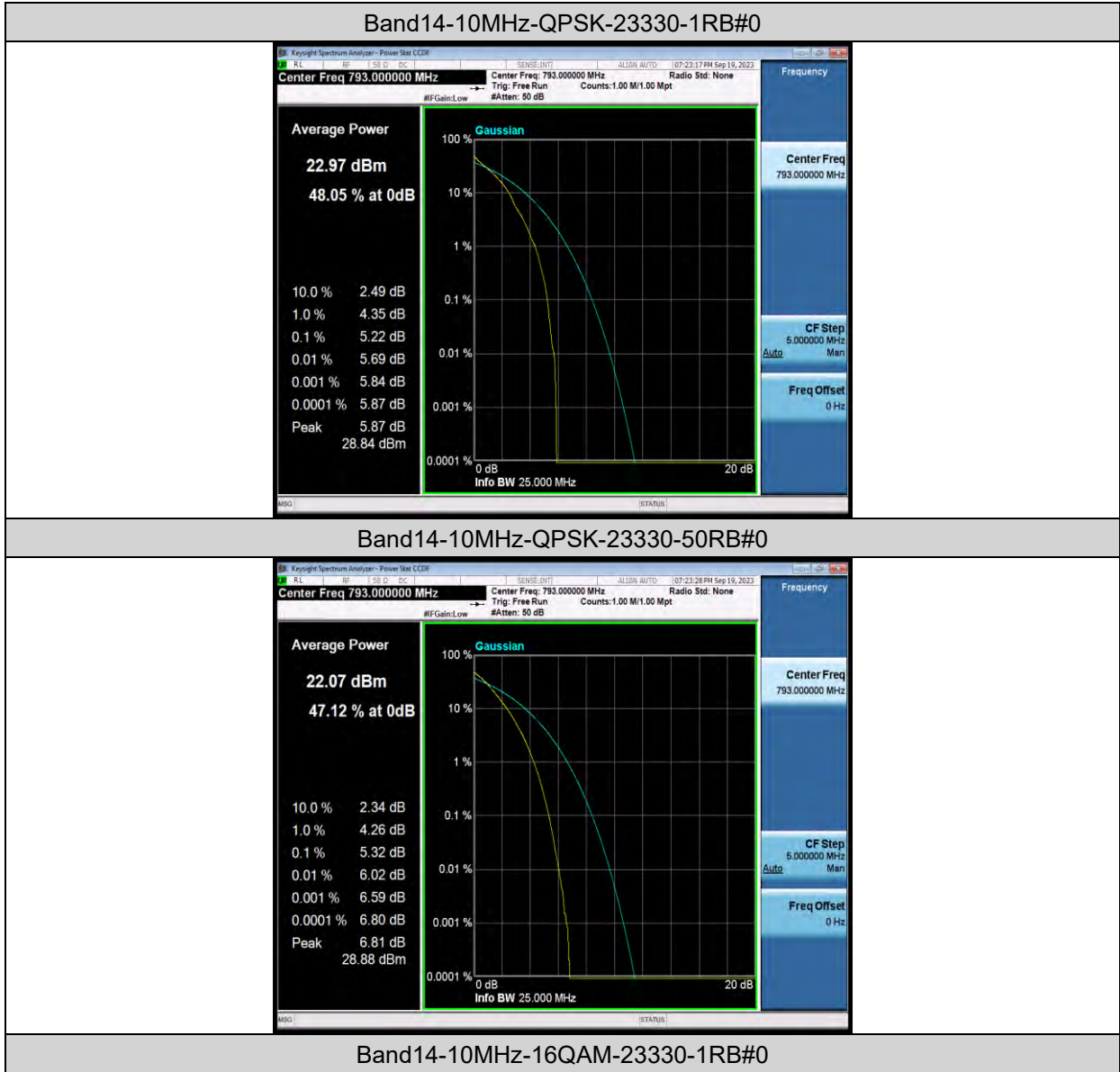



BUREAU VERITAS

Test Report No.: W7L-P23070009-2RF05

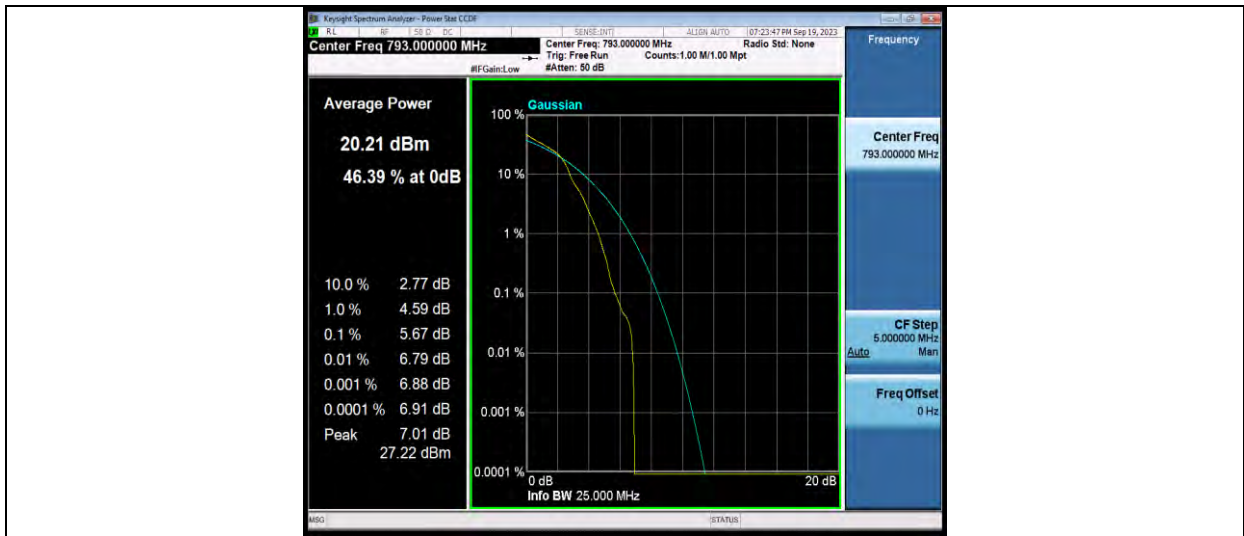

Band14-10MHz-16QAM-23330-27RB#0

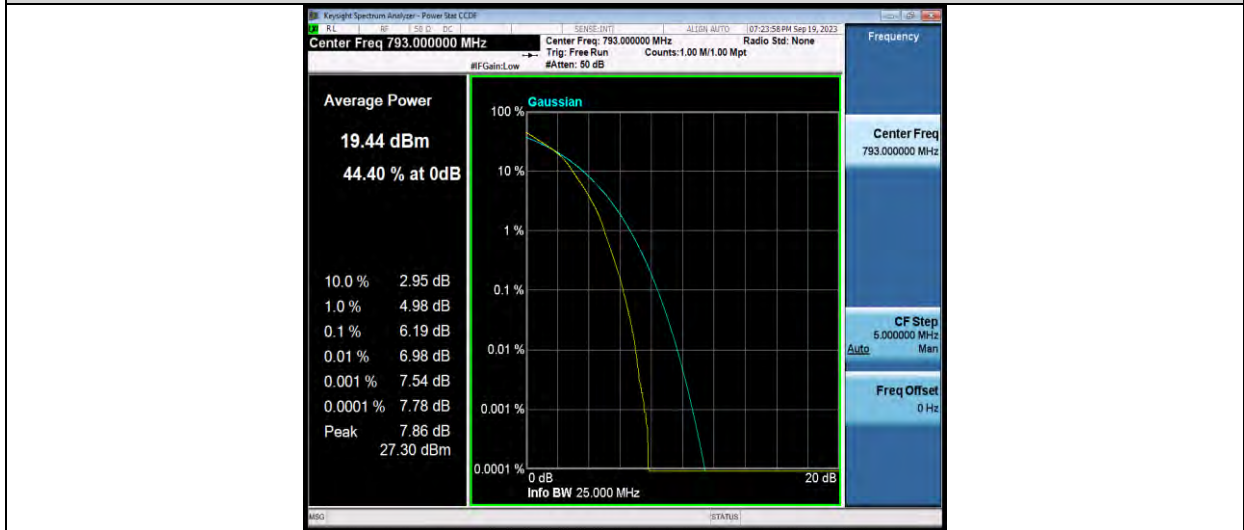



Test Report No.: W7L-P23070009-2RF05

26DB BANDWIDTH AND OCCUPIED BANDWIDTH

Test Result

Band	Bandwidth	Modulation	Channel	RB Configuration	Occupied Bandwidth (MHz)	26dB Bandwidth (MHz)	Verdict
Band14	5MHz	QPSK	23305	25RB#0	4.4800	4.851	PASS
Band14	5MHz	QPSK	23330	25RB#0	4.4968	4.878	PASS
Band14	5MHz	QPSK	23355	25RB#0	4.4956	4.886	PASS
Band14	5MHz	16QAM	23305	25RB#0	4.4808	4.852	PASS
Band14	5MHz	16QAM	23330	25RB#0	4.4856	4.841	PASS
Band14	5MHz	16QAM	23355	25RB#0	4.5020	4.883	PASS
Band14	10MHz	QPSK	23330	50RB#0	8.9298	9.508	PASS
Band14	10MHz	16QAM	23330	27RB#0	4.8191	5.193	PASS



Test Report No.: W7L-P23070009-2RF05

Test Graphs

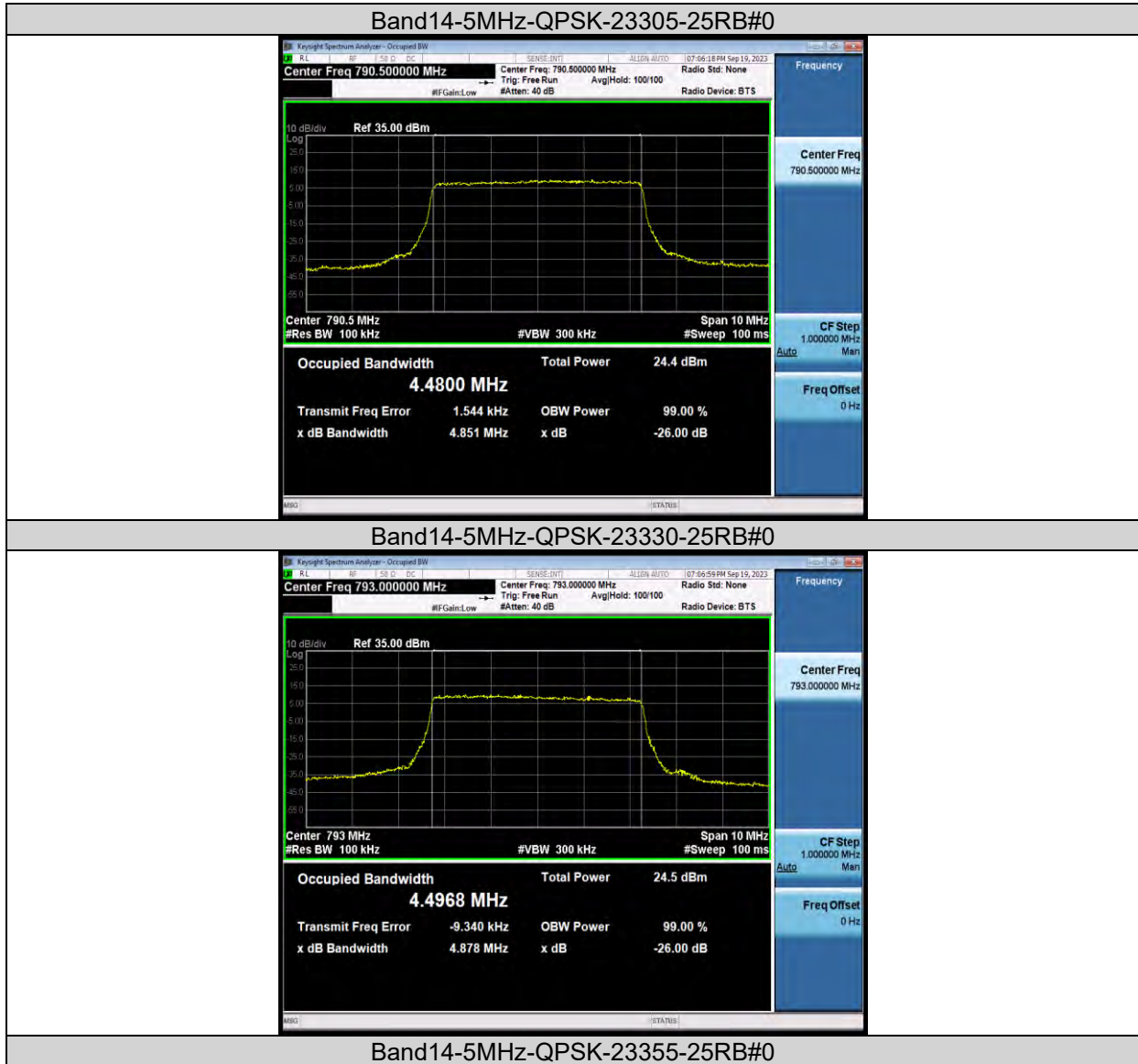



BUREAU
VERITAS

Test Report No.: W7L-P23070009-2RF05



Band14-5MHz-16QAM-23305-25RB#0



Band14-5MHz-16QAM-23330-25RB#0



Band14-5MHz-16QAM-23355-25RB#0



BUREAU
VERITAS

Test Report No.: W7L-P23070009-2RF05

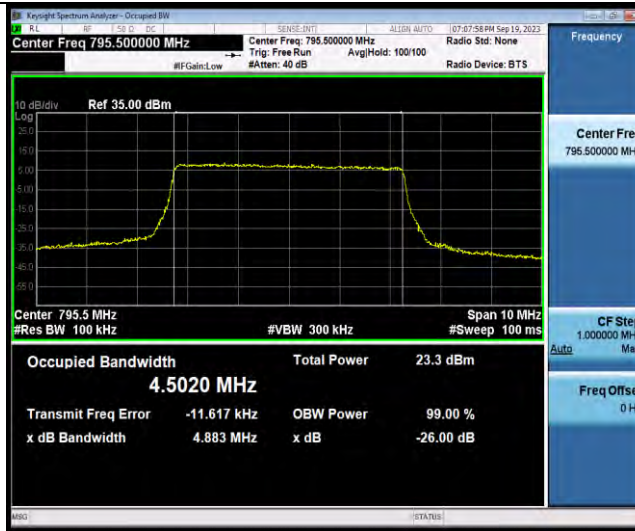

Band14-10MHz-QPSK-23330-50RB#0



Band14-10MHz-16QAM-23330-27RB#0

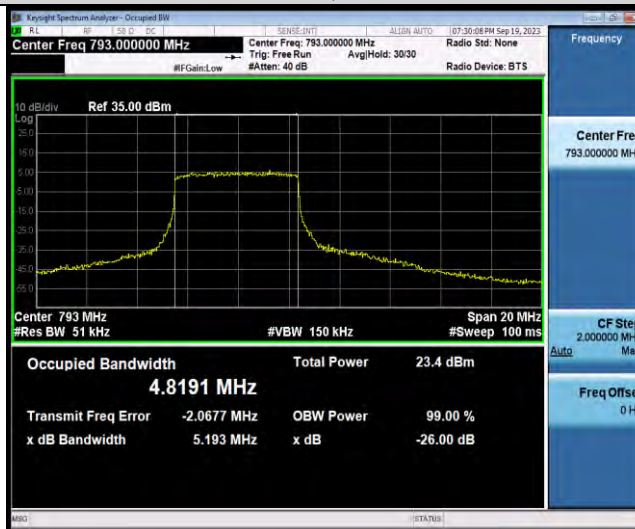



Test Report No.: W7L-P23070009-2RF05

BAND EDGE

Test Result

Band	Bandwidth	Modulation	Channel	RB Configuration	Result(dBm)	Verdict
Band14	5MHz	QPSK	23305	1RB#0	-62.26,-66.95,-35.16,-20.26	PASS
Band14	5MHz	QPSK	23305	25RB#0	-62.23,-67.90,-39.19,-34.24	PASS
Band14	5MHz	QPSK	23355	1RB#24	-20.49,-31.17,-47.07,-61.84	PASS
Band14	5MHz	QPSK	23355	25RB#0	-33.93,-38.43,-49.54,-58.42	PASS
Band14	5MHz	16QAM	23305	1RB#0	-61.87,-66.86,-33.43,-20.46	PASS
Band14	5MHz	16QAM	23305	25RB#0	-62.12,-67.52,-39.07,-34.90	PASS
Band14	5MHz	16QAM	23355	1RB#24	-20.82,-33.15,-48.23,-61.72	PASS
Band14	5MHz	16QAM	23355	25RB#0	-33.80,-38.00,-48.79,-59.23	PASS
Band14	10MHz	QPSK	23330	1RB#0	-62.14,-67.88,-35.83,-24.60	PASS
Band14	10MHz	QPSK	23330	1RB#49	-62.00,-68.44,-52.95,-55.61	PASS
Band14	10MHz	QPSK	23330	50RB#0	-62.03,-67.40,-40.35,-38.54	PASS
Band14	10MHz	16QAM	23330	1RB#0	-62.04,-67.33,-37.37,-25.67	PASS
Band14	10MHz	16QAM	23330	1RB#49	-62.28,-67.75,-53.72,-55.83	PASS
Band14	10MHz	16QAM	23330	27RB#0	-62.02,-68.28,-38.69,-37.47	PASS
Band14	10MHz	16QAM	23330	27RB#23	-62.10,-67.98,-45.55,-47.39	PASS



Test Report No.: W7L-P23070009-2RF05

Test Graphs

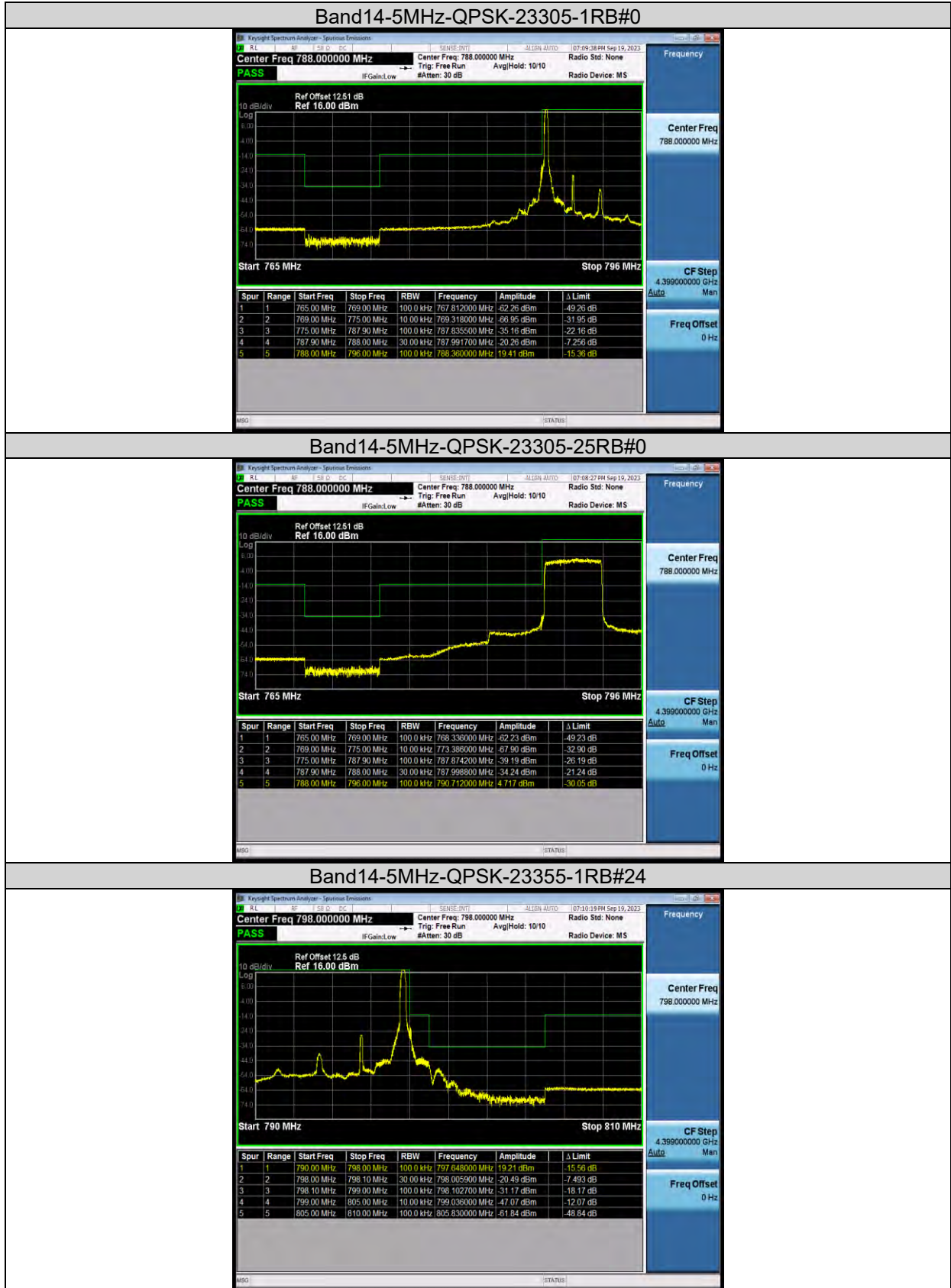



BUREAU VERITAS

Test Report No.: W7L-P23070009-2RF05

Band14-5MHz-QPSK-23355-25RB#0



Band14-5MHz-16QAM-23305-1RB#0

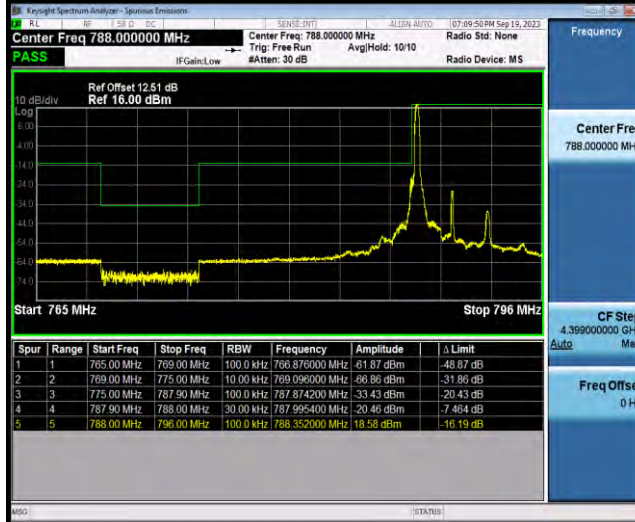

Band14-5MHz-16QAM-23305-25RB#0

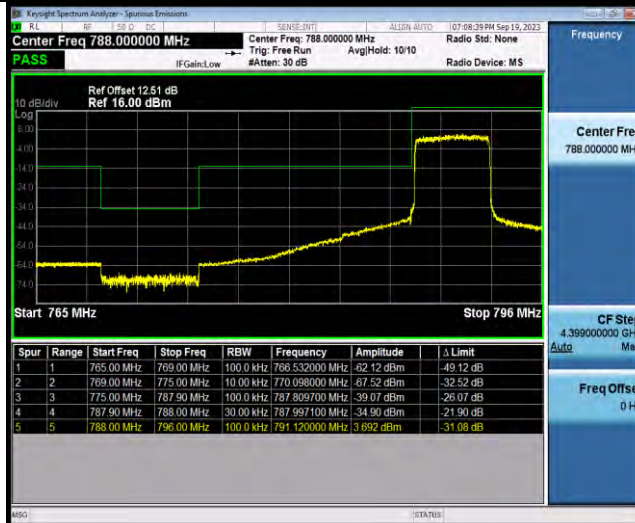

Band14-5MHz-16QAM-23355-1RB#24



BUREAU VERITAS

Test Report No.: W7L-P23070009-2RF05



Band14-5MHz-16QAM-23355-25RB#0



Band14-10MHz-QPSK-23330-1RB#0



Band14-10MHz-QPSK-23330-1RB#49



BUREAU VERITAS

Test Report No.: W7L-P23070009-2RF05



Band14-10MHz-QPSK-23330-50RB#0



Band14-10MHz-16QAM-23330-1RB#0



Band14-10MHz-16QAM-23330-1RB#49



BUREAU VERITAS

Test Report No.: W7L-P23070009-2RF05



Band14-10MHz-16QAM-23330-27RB#0



Band14-10MHz-16QAM-23330-27RB#23





Test Report No.: W7L-P23070009-2RF05

CONDUCTED SPURIOUS EMISSION

Test Result

Band	Bandwidth	Modulation	Channel	RB Configuration	Frequency Range	Result (dBm)	Verdict
Band14	5MHz	QPSK	23305	1RB#0	Range1:30~1000MHz	-40.43	PASS
Band14	5MHz	QPSK	23305	1RB#0	Range2:1000~10000MHz	-33.87	PASS
Band14	5MHz	QPSK	23305	1RB#0	Range3:1559~1610MHz	-50.91	PASS
Band14	5MHz	QPSK	23330	1RB#0	Range1:30~1000MHz	-39.47	PASS
Band14	5MHz	QPSK	23330	1RB#0	Range2:1000~10000MHz	-34.34	PASS
Band14	5MHz	QPSK	23330	1RB#0	Range3:1559~1610MHz	-46.4	PASS
Band14	5MHz	QPSK	23355	1RB#0	Range1:30~1000MHz	-40.12	PASS
Band14	5MHz	QPSK	23355	1RB#0	Range2:1000~10000MHz	-34.29	PASS
Band14	5MHz	QPSK	23355	1RB#0	Range3:1559~1610MHz	-45.73	PASS
Band14	5MHz	16QAM	23305	1RB#0	Range1:30~1000MHz	-40.03	PASS
Band14	5MHz	16QAM	23305	1RB#0	Range2:1000~10000MHz	-33.92	PASS
Band14	5MHz	16QAM	23305	1RB#0	Range3:1559~1610MHz	-51.38	PASS
Band14	5MHz	16QAM	23330	1RB#0	Range1:30~1000MHz	-40.35	PASS
Band14	5MHz	16QAM	23330	1RB#0	Range2:1000~10000MHz	-34.29	PASS
Band14	5MHz	16QAM	23330	1RB#0	Range3:1559~1610MHz	-47.15	PASS
Band14	5MHz	16QAM	23355	1RB#0	Range1:30~1000MHz	-38.97	PASS
Band14	5MHz	16QAM	23355	1RB#0	Range2:1000~10000MHz	-33.74	PASS
Band14	5MHz	16QAM	23355	1RB#0	Range3:1559~1610MHz	-46.47	PASS
Band14	10MHz	QPSK	23330	1RB#0	Range1:30~1000MHz	-39.3	PASS
Band14	10MHz	QPSK	23330	1RB#0	Range2:1000~10000MHz	-33.97	PASS
Band14	10MHz	QPSK	23330	1RB#0	Range3:1559~1610MHz	-49.67	PASS

Test Graphs

Band14-5MHz-QPSK-23305-1RB#0-Range1:30~1000MHz



BUREAU VERITAS

Test Report No.: W7L-P23070009-2RF05

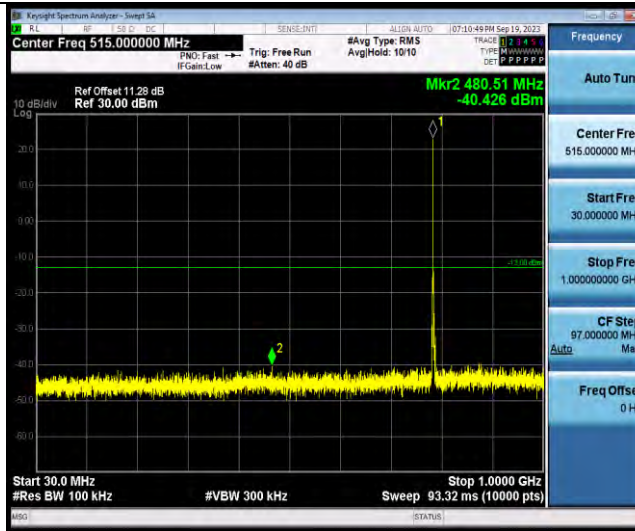

Band14-5MHz-QPSK-23305-1RB#0-Range2:1000~10000MHz

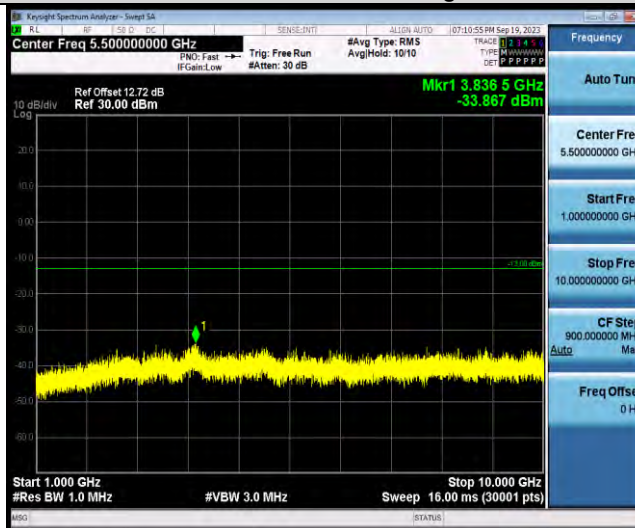

Band14-5MHz-QPSK-23305-1RB#0-Range3:1559~1610MHz

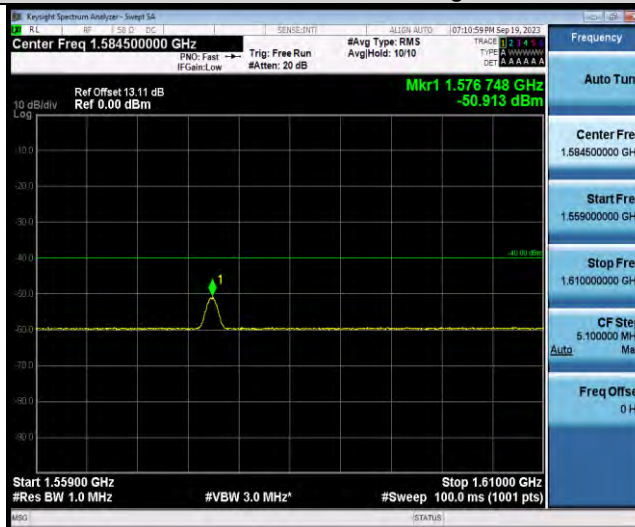

Band14-5MHz-QPSK-23330-1RB#0-Range1:30~1000MHz



BUREAU VERITAS

Test Report No.: W7L-P23070009-2RF05

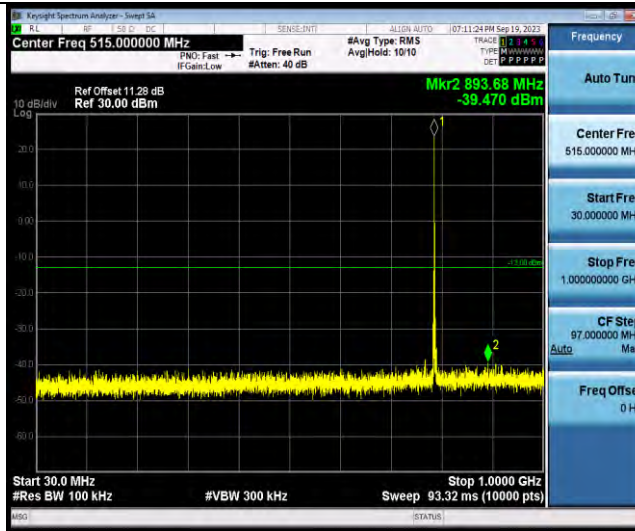

Band14-5MHz-QPSK-23330-1RB#0-Range2:1000~10000MHz

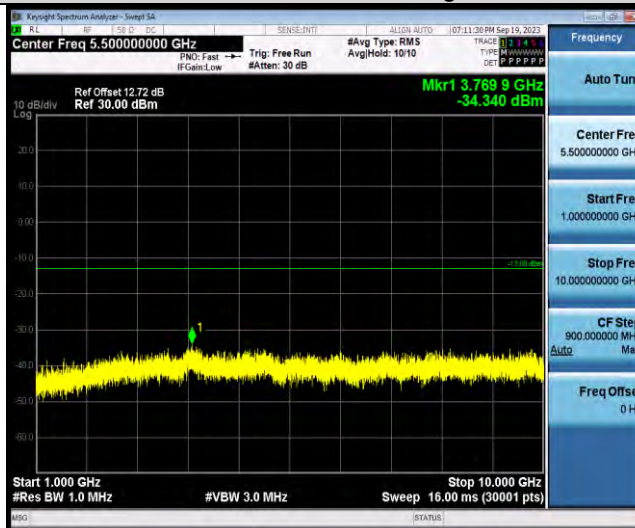

Band14-5MHz-QPSK-23330-1RB#0-Range3:1559~1610MHz

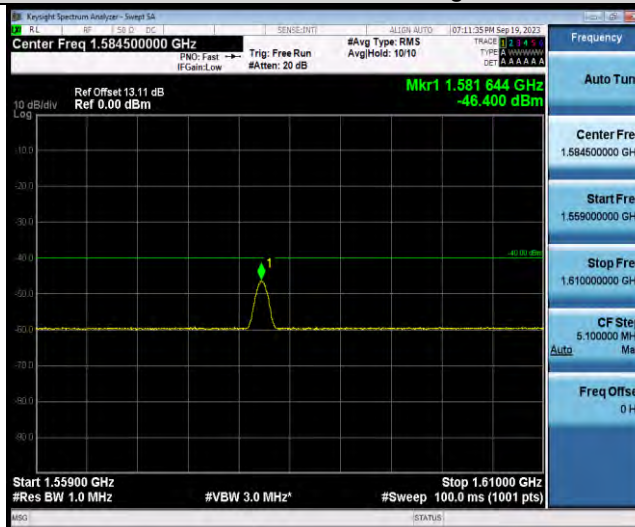

Band14-5MHz-QPSK-23355-1RB#0-Range1:30~1000MHz



BUREAU VERITAS

Test Report No.: W7L-P23070009-2RF05

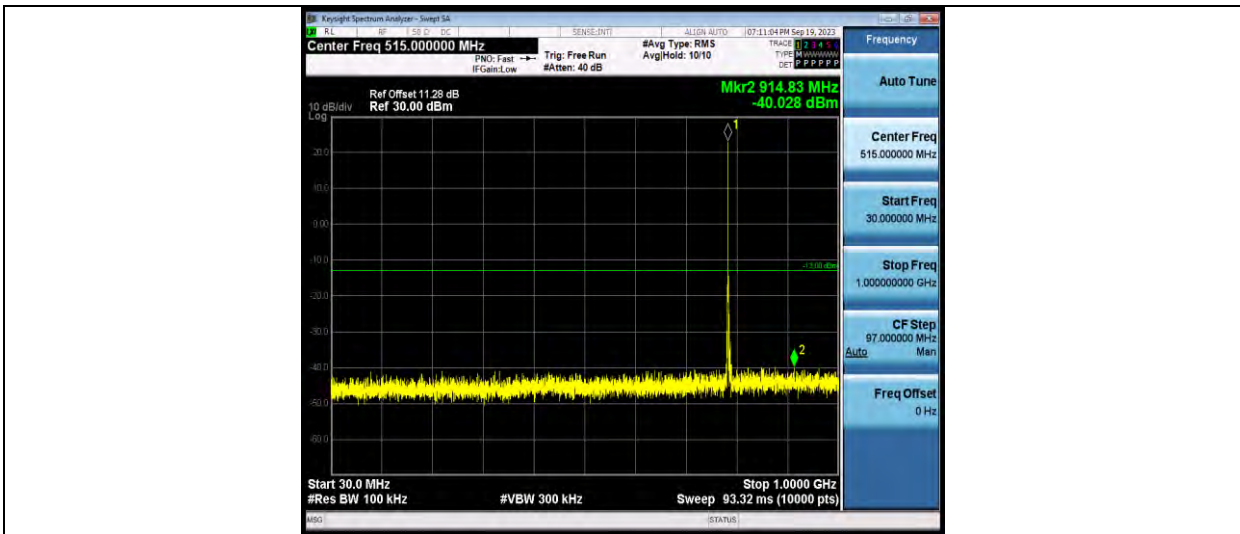

Band14-5MHz-16QAM-23305-1RB#0-Range2:1000~10000MHz

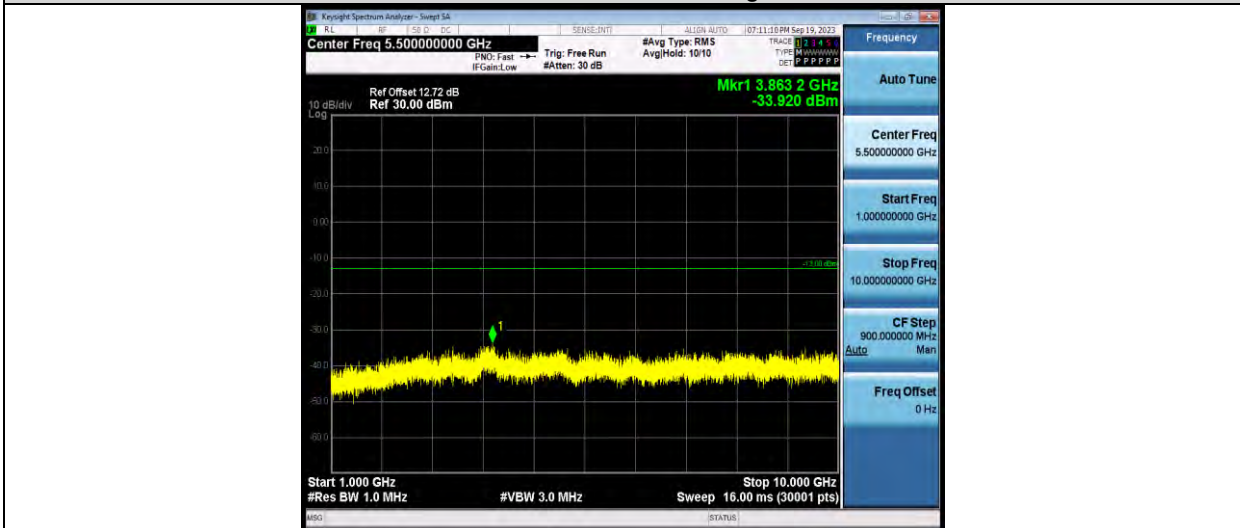

Band14-5MHz-16QAM-23305-1RB#0-Range3:1559~1610MHz

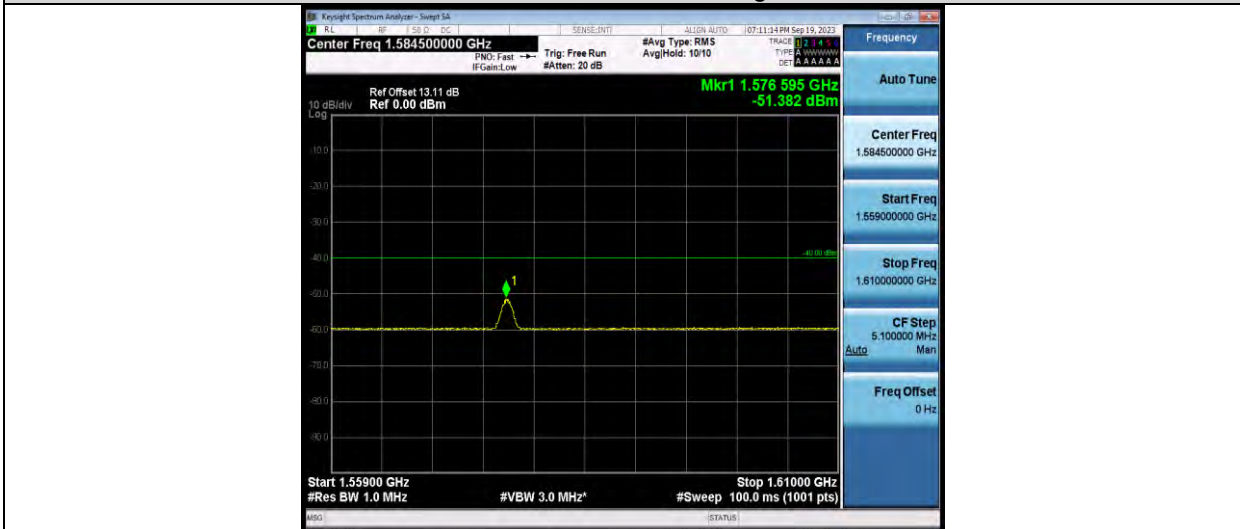

Band14-5MHz-16QAM-23330-1RB#0-Range1:30~1000MHz



BUREAU VERITAS

Test Report No.: W7L-P23070009-2RF05

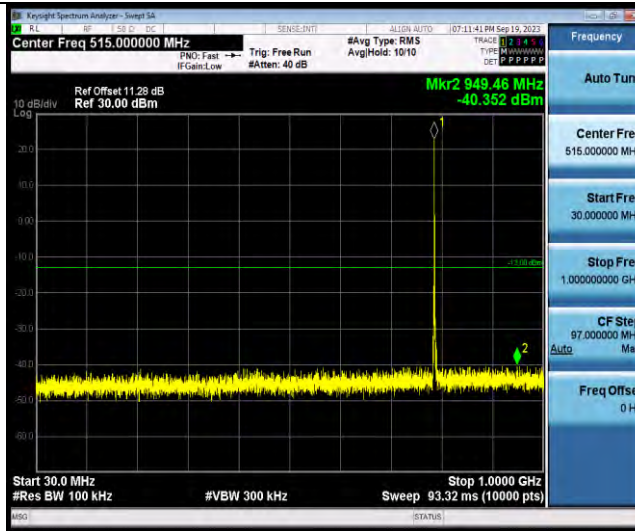

Band14-5MHz-16QAM-23330-1RB#0-Range2:1000~10000MHz

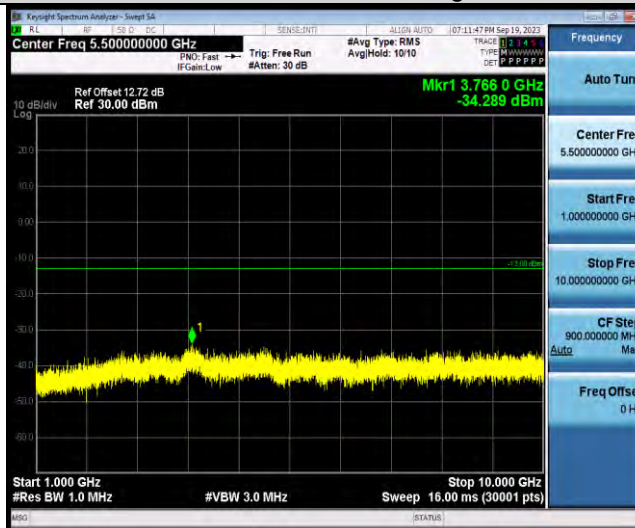

Band14-5MHz-16QAM-23330-1RB#0-Range3:1559~1610MHz

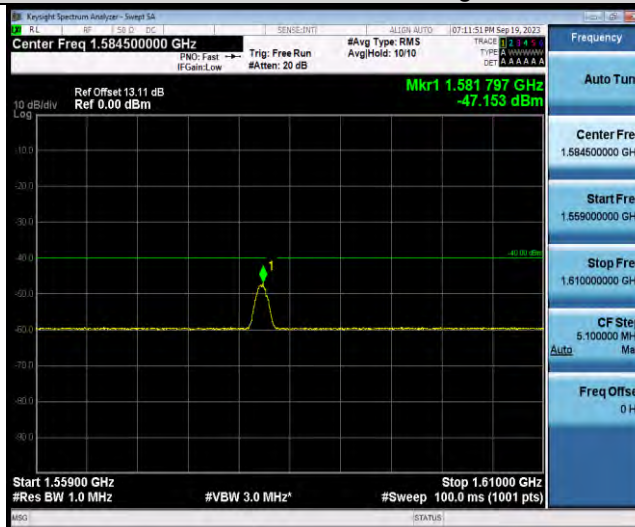

Band14-5MHz-16QAM-23335-1RB#0-Range1:30~1000MHz



BUREAU VERITAS

Test Report No.: W7L-P23070009-2RF05

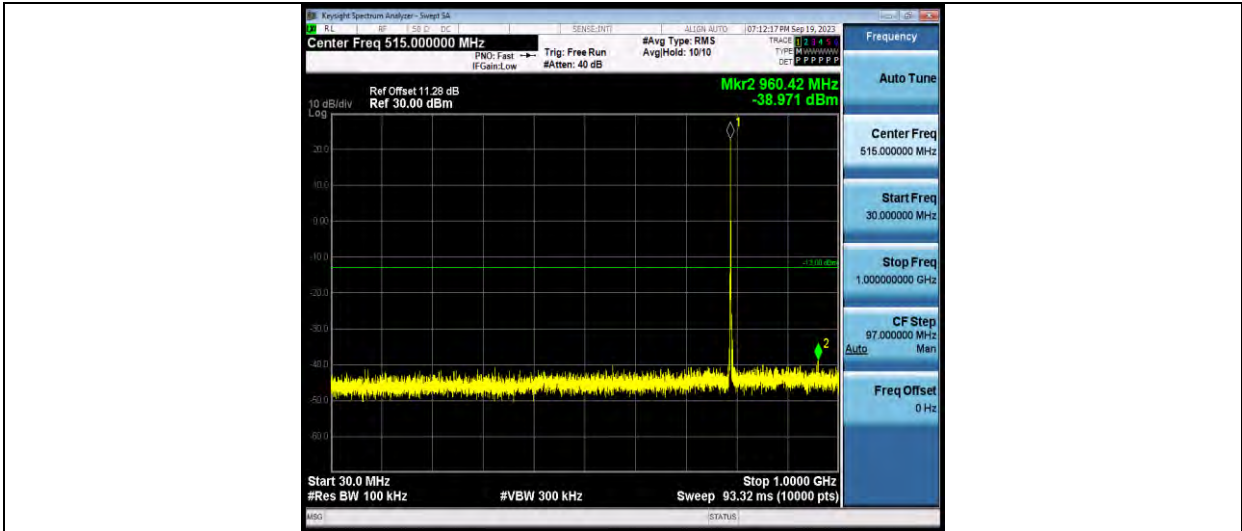

Band14-5MHz-16QAM-23355-1RB#0-Range2:1000~10000MHz

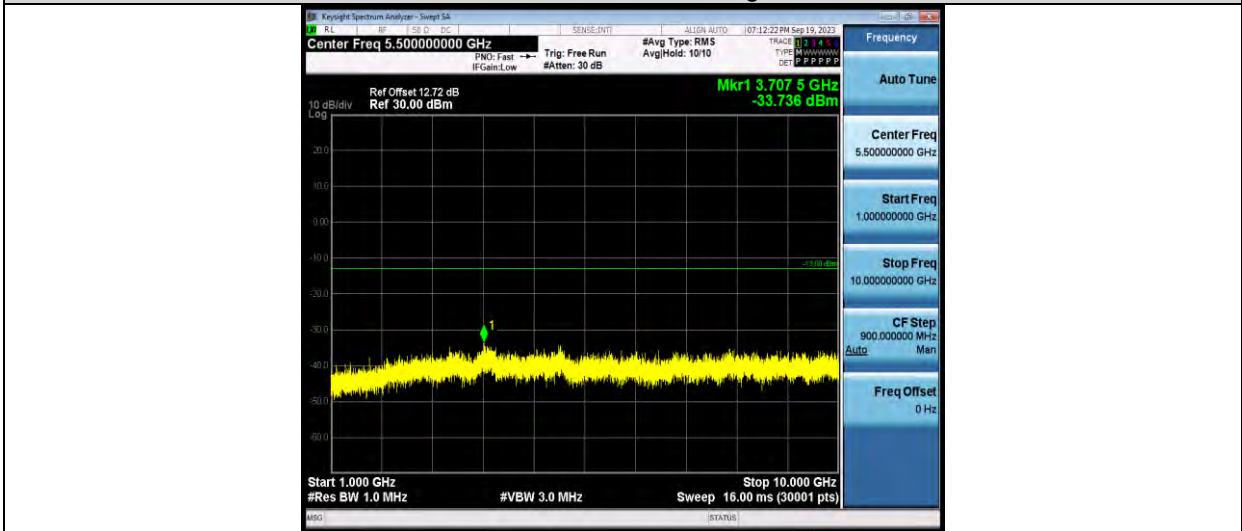

Band14-5MHz-16QAM-23355-1RB#0-Range3:1559~1610MHz

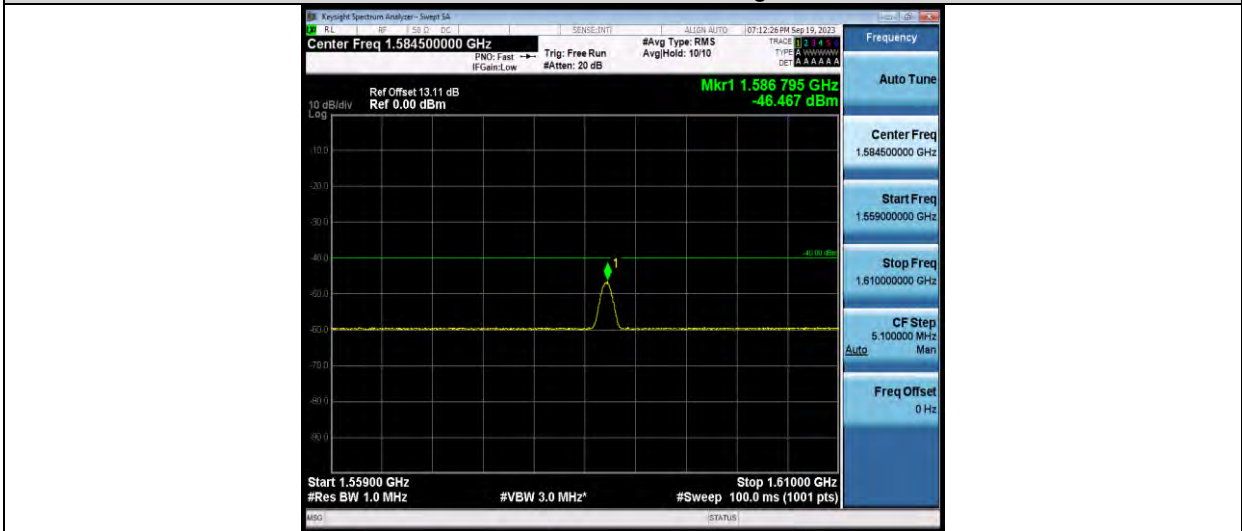

Band14-10MHz-QPSK-23330-1RB#0-Range1:30~1000MHz



BUREAU VERITAS

Test Report No.: W7L-P23070009-2RF05

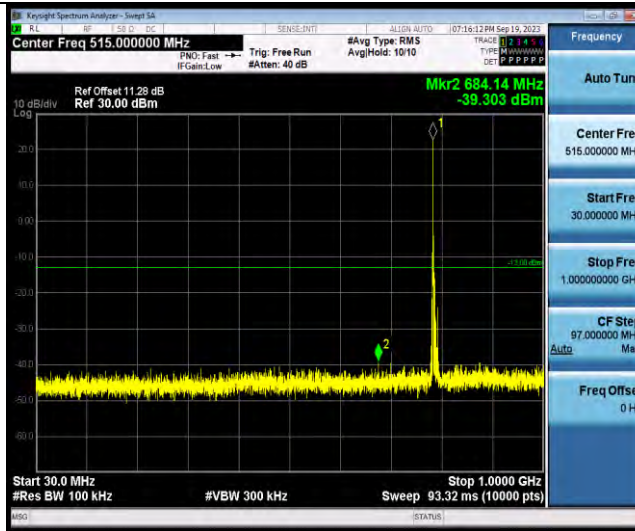

Band14-10MHz-QPSK-23330-1RB#0-Range2:1000~10000MHz

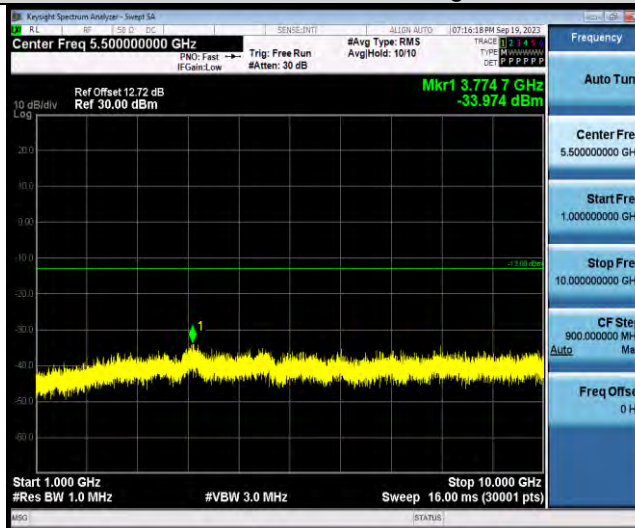

Band14-10MHz-QPSK-23330-1RB#0-Range3:1559~1610MHz

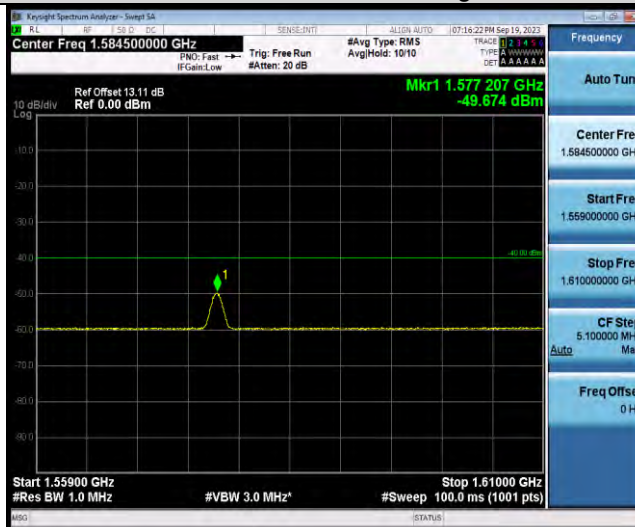



Test Report No.: W7L-P23070009-2RF05

FREQUENCY STABILITY

Test Result

Voltage										
Band	Band width	Modulation	Channel	RB Configure	Voltage [Vdc]	Temperature (°C)	Deviation (Hz)	Deviation (ppm)	Limit (ppm)	Verdict
Band14	10 MHz	QPSK	23330	50RB#0	LV	NT	-6.47	-0.008159	±2.5	PASS
Band14	10 MHz	QPSK	23330	50RB#0	NV	NT	-7.31	-0.009218	±2.5	PASS
Band14	10 MHz	QPSK	23330	50RB#0	HV	NT	-5.59	-0.007049	±2.5	PASS

Temperature										
Band	Band width	Modulation	Channel	RB Configure	Voltage [Vdc]	Temperature (°C)	Deviation (Hz)	Deviation (ppm)	Limit (ppm)	Verdict
Band14	10 MHz	QPSK	23330	50RB#0	NV	-30	-5.36	-0.006759	±2.5	PASS
Band14	10 MHz	QPSK	23330	50RB#0	NV	-20	-8.96	-0.011299	±2.5	PASS
Band14	10 MHz	QPSK	23330	50RB#0	NV	-10	-6.11	-0.007705	±2.5	PASS
Band14	10 MHz	QPSK	23330	50RB#0	NV	0	-3.88	-0.004893	±2.5	PASS
Band14	10 MHz	QPSK	23330	50RB#0	NV	10	-4.55	-0.005738	±2.5	PASS
Band14	10 MHz	QPSK	23330	50RB#0	NV	20	-2.16	-0.002724	±2.5	PASS
Band14	10 MHz	QPSK	23330	50RB#0	NV	30	-4.73	-0.005965	±2.5	PASS
Band14	10 MHz	QPSK	23330	50RB#0	NV	40	-5.92	-0.007465	±2.5	PASS
Band14	10 MHz	QPSK	23330	50RB#0	NV	50	-5.84	-0.007364	±2.5	PASS



Test Report No.: W7L-P23070009-2RF05

MAX Deviation calculation

Frequency Stability	Frequency (MHz)	Limit Line(MHz)	Result
$f- \text{MAX}(\Delta f) $	788.535010	≥ 788	PASS
$f+ \text{MAX}(\Delta f) $	797.464909	≤ 798	

- Note : 1. $|\text{MAX}(\Delta f)|$ = Max Deviation
2. f = Occ channel edge(-13dBm/MHz)
3. $|\text{MAX}(\Delta f)|$ = 8.96Hz.

---END---