



TEST REPORT

REPORT NUMBER: I22W00019-WiFi RF-5.8GHz-Rev4

ON

Type of Equipment: Wi-Fi Module
Type of Designation: W82
Brand Name: SIMCom
Manufacturer: SIMCom Wireless Solutions Limited
FCC ID 2AJYU-8XN0002

ACCORDING TO
FCC Part15 Subpart E
ANSI C63.10-2013

Chongqing Academy of Information and Communications Technology

Month date, year

May, 23, 2023

Signature

Director

Note:

The test results in this test report relate only to the devices specified in this report. This report shall not be reproduced except in full without the written approval of Chongqing Academy of Information and Communications Technology.



Report No.: I22W00019-WiFi RF-5.8GHz-Rev4

Revision Version

Report Number	Revision	Date	Memo
I22W00019-WiFi RF-5.8GHz	00	2023-01-06	Initial creation of test report
I22W00019-WiFi RF-5.8GHz-Rev1	01	2023-05-04	First change of test report
I22W00019-WiFi RF-5.8GHz-Rev2	02	2023-05-17	Second change of test report
I22W00019-WiFi RF-5.8GHz-Rev3	03	2023-05-19	Third change of test report
I22W00019-WiFi RF-5.8GHz-Rev4	04	2023-05-23	Fourth change of test report

Chongqing Academy of Information and Communication Technology

Address: No. 8, Yuma Road, Chayuan New City, Nan'an District, Chongqing, P. R. China, 401336
Tel: 0086-23-88069965 FAX: 0086-23-88608777



Report No.: I22W00019-WiFi RF-5.8GHz-Rev4

CONTENTS

1. Test Laboratory 5

1.1. Testing Location 5

1.2. Testing Environment 5

1.3. Project data 5

1.4. Signature 5

2. Client Information 6

2.1. Applicant Information 6

2.2. Manufacturer Information 6

3. Equipment under Test (EUT) and Ancillary Equipment (AE) 7

3.1. About EUT 7

3.2. Internal Identification of EUT used during the test 9

3.3. Internal Identification of AE used during the test 10

3.4. EUT Test RF Confagle Configuration 10

3.5. Test software line loss compensation list 10

4. Reference Documents 12

4.1. Documents supplied by applicant 12

4.2. Reference Documents for testing 12

5. Test Equipments Utilized 13

5.1. RF Test System 13

5.2. RSE Test System 13

5.3. CE Test System 13

5.4. Climate Chamber 13

5.5. Vibration table 14

5.6. Test software 14

6. Test Results 15

6.1. Summary of Test Results 15

Chongqing Academy of Information and Communication Technology

Address: No. 8,Yuma Road, Chayuan New City, Nan'an District, Chongqing, P. R. China,401336
Tel: 0086-23-88069965 FAX:0086-23-88608777



Report No.: I22W00019-WiFi RF-5.8GHz-Rev4

6.2. 99% Occupied Bandwidth	16
6.3. Maximum Output Power	19
6.4. Power Spectral Density	44
6.5. 6dB Occupied Bandwidth	70
6.6. Band Edges Compliance (Radiated)	83
6.7. Transmitter Spurious Emission-Radiated	93
6.8. AC Powerline Conducted Emission (150kHz- 30MHz)	132
Annex A EUT Photos	135
ANNEX B Deviations from Prescribed Test Methods	136

Chongqing Academy of Information and Communication Technology

Address: No. 8, Yuma Road, Chayuan New City, Nan'an District, Chongqing, P. R. China, 401336
Tel: 0086-23-88069965 FAX: 0086-23-88608777

1. Test Laboratory

1.1. Testing Location

Name:	Chongqing Academy of Information and Communications Technology
Designation Number:	CN1239
Address:	Building C, Technology Innovation Center, No.8, Yuma Road, Chayuan New Area, Nan'an District, Chongqing, People's Republic of China
	No.19 East Road, Xiantao Big-data Valley, Yubei District, Chongqing, People's Republic of China
Postal Code:	401336
Telephone:	0086-23-88069965
Fax:	0086-23-88608777

1.2. Testing Environment

Normal Temperature:	15-35°C
Relative Humidity:	30-60%

1.3. Project data

Testing Start Date:	2022-03-20
Testing End Date:	2023-05-11

1.4. Signature



2023-05-23

Li Quan
(Prepared this test report)

Date

2023-05-23

Xiao Yu
(Reviewed this test report)

Date

2023-05-23

Xiang Luoyong
Director of the laboratory
(Approved this test report)

Date

Chongqing Academy of Information and Communication Technology

Address: No. 8, Yuma Road, Chayuan New City, Nan'an District, Chongqing, P. R. China, 401336
Tel: 0086-23-88069965 FAX: 0086-23-88608777



2. Client Information

2.1. Applicant Information

Company Name:	SIMCom Wireless Solutions Limited
Address /Post:	SIMCom Headquarters Building, Building 3, No.289 Linhong Road, Changning District, Shanghai, China
City:	Shanghai
Country:	China
Telephone:	86 21 3157 5100
Fax:	--
Email:	Yongsheng Li@simcom.com
Contact Person:	Yongsheng Li

2.2. Manufacturer Information

Company Name:	SIMCom Wireless Solutions Limited
Address /Post:	SIMCom Headquarters Building, Building 3, No.289 Linhong Road, Changning District, Shanghai, China
City:	Shanghai
Country:	China
Telephone:	86 21 3157 5100
Fax:	--
Email:	Yongsheng Li@simcom.com
Contact Person:	Yongsheng Li

Chongqing Academy of Information and Communication Technology

Address: No. 8,Yuma Road, Chayuan New City, Nan'an District, Chongqing, P. R. China,401336
Tel: 0086-23-88069965 FAX:0086-23-88608777

3. Equipment under Test (EUT) and Ancillary Equipment (AE)

3.1. About EUT

EUT Description	Wi-Fi Module
Model name	W82
Brand name	SIMCom
WLAN Frequency Band	2.4G/UNII 1/2A/2C/3/5/6/7/8
Product Type	UNII-1/2A/2C/3:Indoor Access Point
	UNII-5/6/7/8:Low-power Indoor Client
Frequency Range	2.4G: 802.11b/g/n20/ax20: 2412-2462MHz; 802.11n40/ax40: 2422-2452MHz
	5.1G : UNII-1:802.11a/n20/ac20/ax20 : 5180-5240MHz ; 802.11n40/ac40/ax40 : 5190-5230MHz; 802.11ac80/ax80: 5210MHz
	UNII-2A: 802.11a/n20/ac20/ax20: 5260-5320MHz; 802.11n40/ac40/ax40: 5270-5310MHz 802.11ac80/ax80: 5290MHz; UNII-1and UNII-2A: 802.11ac160/ax160: 5250MHz
	UNII-2C:802.11a/n20/ac20/ax20: 5500-5700MHz; 802.11n40/ac40/ax40: 5510-5670MHz 802.11ac80/ax80: 5530-5610MHz; 802.11ac160/ax160: 5570MHz
	UNII-3:802.11a/n20/ac20/ax20:5745-5825MHz; 802.11n40/ac40/ax40: 5755-5795MHz 802.11ac80/ax80: 5775MHz
	Band5 : 802.11ax20 : 5955-6415MHz ; 802.11ax40 : 5965-6405MHz ; 802.11ax80 : 5985-6385MHz; 802.11ax160: 6025-6345MHz
	Band6: 802.11ax20: 6435-6515MHz; 802.11ax40: 6445-6525MHz; 802.11ax80: 6465MHz; 802.11ax160: 6505MHz
Band7 : 802.11ax20 : 6535-6855MHz ; 802.11ax40 : 6565-6845MHz ; 802.11ax80 : 6545-6865MHz; 802.11ax160: 6665-6825MHz	
Band8 : 802.11ax20 : 6895-7115MHz ; 802.11ax40 : 6885-7085MHz ; 802.11ax80 : 6945-7025MHz; 802.11ax160: 6985MHz	
802.11 mode	b/g/a/n/ac/ax
Modulation mode	DSSS/CCK/OFDM/OFDMA
Antenna port	Ant0/Ant1
Extreme Temperature	-30/+70°C
Nominal Voltage	3.8V
Extreme High Voltage	4.4V
Extreme Low Voltage	3.3V

Note1: Photographs of EUT are shown in ANNEX A of this test report.

Chongqing Academy of Information and Communication Technology

Address: No. 8,Yuma Road, Chayuan New City, Nan'an District, Chongqing, P. R. China,401336
Tel: 0086-23-88069965 FAX:0086-23-88608777



Report No.: I22W00019-WiFi RF-5.8GHz-Rev4

Note2: High and low voltage values in extreme condition test are given by manufacturer.

Note3: This report is only for U-NII 3 test results.

Test frequency list:

WLAN_2.4G:

BW_20M	Channel	1	6	11
	Fre.(MHz)	2412	2437	2462
BW_40M	Channel	3	6	9
	Fre.(MHz)	2422	2437	2452

UNII-1 and UNII-2A:

BW_20M	Channel	36	40	44	48	52	56	60	64
	Fre.(MHz)	5180	5200	5220	5240	5260	5280	5300	5320
BW_40M	Channel	38		46		54		62	
	Fre.(MHz)	5190		5230		5270		5310	
BW_80M	Channel	42				58			
	Fre.(MHz)	5210				5290			
BW_160M	Channel	50							
	Fre.(MHz)	5250							

UNII-2C:

BW_20M	Channel	100	104	108	112	116	120	124	128	132	136	140
	Fre.(MHz)	5500	5520	5540	5560	5580	5600	5620	5640	5660	5680	5700
BW_40M	Channel	102		110		118		126		134		/
	Fre.(MHz)	5510		5550		5590		5630		5670		/
BW_80M	Channel	106				122				/		
	Fre.(MHz)	5530				5610						
BW_160M	Channel	114								/		
	Fre.(MHz)	5570										

Note: "/" Represents empty

UNII-3:

BW_20M	Channel	149	153	157	161	165
	Fre.(MHz)	5745	5765	5785	5805	5825
BW_40M	Channel	151		159		/
	Fre.(MHz)	5755		5795		
BW_80M	Channel	155				/
	Fre.(MHz)	5775				
BW_160M	Channel	/				/
	Fre.(MHz)	/				

Note: "/" Represents empty

WLAN_6G:

Chongqing Academy of Information and Communication Technology

Address: No. 8, Yuma Road, Chayuan New City, Nan'an District, Chongqing, P. R. China, 401336
 Tel: 0086-23-88069965 FAX: 0086-23-88608777



Report No.: I22W00019-WiFi RF-5.8GHz-Rev4

		UNII-5			UNII-6			UNII-7			UNII-8		
BW_20M	Channel	1	45	93	97	105	113	117	149	181	185	209	233
	Fre.(MHz)	5955	6175	6415	6435	6475	6515	6535	6695	6855	6875	6995	7115
BW_40M	Channel	3	43	91	99	107	115	123	147	179	187	203	227
	Fre.(MHz)	5965	6165	6405	6445	6485	6525	6565	6685	6845	6885	6965	7085
BW_80M	Channel	7	39	87	103	/	/	119	151	183	199	215	/
	Fre.(MHz)	5985	6145	6385	6465	/	/	6545	6705	6865	6945	7025	/
BW_160M	Channel	15	47	79	111	/	/	143	175	/	207	/	/
	Fre.(MHz)	6025	6185	6345	6505	/	/	6665	6825	/	6985	/	/

Note1: CH115/119/183/111/175/187 includes cross frequency
 Note2: "/" Represents empty

3.2. Internal Identification of EUT used during the test

EUT ID*	SN or IMEI	HW Version	SW Version	Date of receipt
S1	SN:MP0622033CCC290	V1.01	V1.0.01	2022-03-04
S2	SN:MP0622033CCC308	V1.01	V1.0.01	2022-03-04

*EUT ID: is used to identify the test sample in the lab internally.

Technology	Band	Frequency range(MHz)	Support mode	Antenna gain ^{note2}	MIMO Tx function ^{note3}	Directional gain ^{note4}
WLAN	2.4G	2400-2483.5	802.11b/g/n(HT20/40)/ ax(HE20/40) ^{note1}	2.97dBi	2TX	b/g:2.97dBi n/ax:2.97dBi+10log(2)=5.98dBi
	5G	UNII 1: 5150MHz-5250MHz UNII 2A: 5250MHz-5350MHz UNII 2C: 5470MHz-5725MHz UNII 3: 5725MHz-5850MHz	802.11a/n(HT20/40)/ac (VHT20/40/80/160)/ax (HE20/40/80/160) ^{note1}	UNII 1: 3.50dBi UNII 2A:3.47dBi UNII 2C: 3.94dBi UNII 3: 3.52dBi	2TX	a:UNII 1: 3.50dBi a:UNII 2A:3.47dBi a:UNII 2C: 3.94dBi a:UNII 3: 3.52dBi n/ac/ax:UNII 1: 3.50dBi+10log(2)=6.51dBi n/ac/ax:UNII 2A:3.47dBi+10log(2)=6.48dBi n/ac/ax:UNII 2C:3.94dBi+10log(2)=6.95dBi n/ac/ax:UNII 3: 3.52dBi+10log(2)=6.53dBi
	6G	UNII 5: 5925MHz-6425MHz UNII 6: 6425MHz-6525MHz UNII 7: 6525MHz-6875MHz UNII 8: 6875MHz-7125MHz	802.11ax(HE20/40/80/ 160) ^{note1}	UNII 5: 3.99dBi UNII 6: 3.29dBi UNII 7: 3.95dBi UNII 8: 3.82dBi	2TX	UNII 5: 3.99dBi+10log(2)=7.00dBi UNII 6: 3.29dBi+10log(2)=6.30dBi UNII 7: 3.95dBi+10log(2)=6.96dBi UNII 8: 3.82dBi+10log(2)=6.83dBi

Note1: This device only supports full RU transmission.

Note2: Antenna gain data provided by the customer.ANT0 and ANT1 antennas have the same gain.

Note3:Only 802.11n/ac/ax supports MIMO.MIMO function don't support simultaneous CDD technology and Beamforming .

Note4:According to KDB 662911D01 Multiple Transmitter Output V02R01, If any transmit signals are correlated with each other, Directional gain = Gant + 10 log (Nant) dBi

Chongqing Academy of Information and Communication Technology

Address: No. 8,Yuma Road, Chayuan New City, Nan'an District, Chongqing, P. R. China,401336
 Tel: 0086-23-88069965 FAX:0086-23-88608777

3.3. Internal Identification of AE used during the test

AE ID*	Description	dB*
AE1	RF cable	2.4GHz: 1.2 5GHz: 2.5 6GHz: 2.5

*AE ID: is used to identify the test sample in the lab internally.
dB*: is provided customer.

3.4. EUT Test RF Confagle Configuration

EUT uses tool to control emission measurement, Change power level, channel, rate and HT .11a/n/ac/ax transmitter power level set to 8.

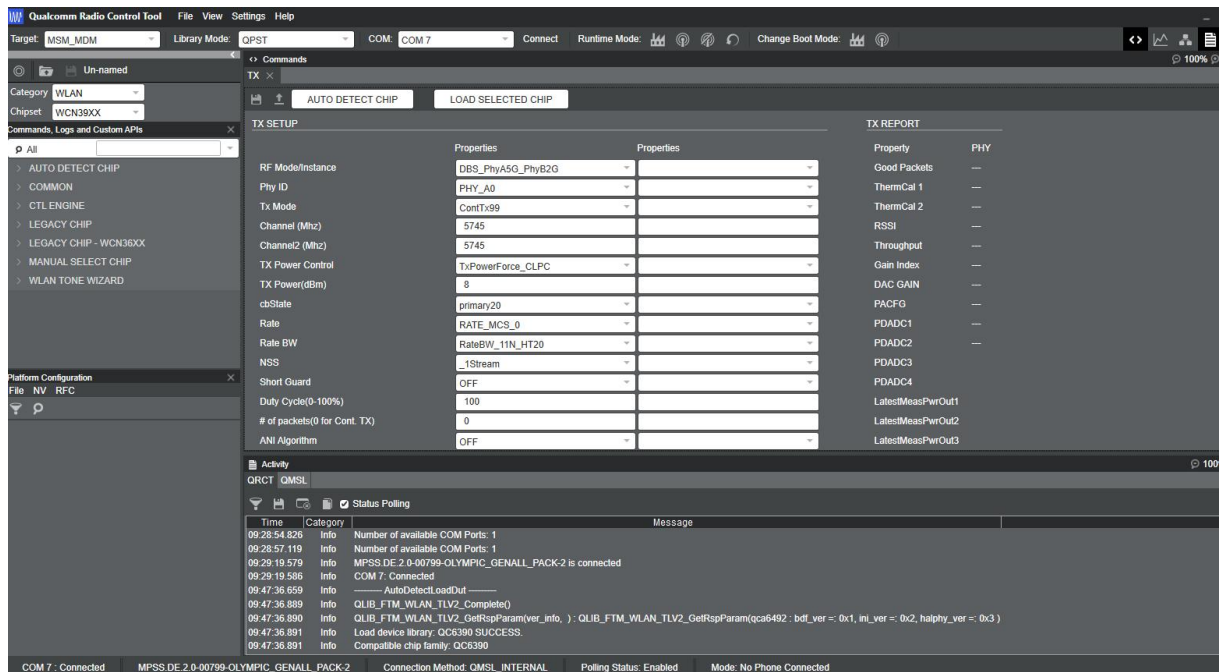

3.5. Test software line loss compensation list

Frequency(MHz)	Cable loss(dB)
2400	1.2
5000	1.8
5800	2.0
6000	2.2
7000	2.5

Chongqing Academy of Information and Communication Technology

Address: No. 8, Yuma Road, Chayuan New City, Nan'an District, Chongqing, P. R. China, 401336
Tel: 0086-23-88069965 FAX: 0086-23-88608777



Report No.: I22W00019-WiFi RF-5.8GHz-Rev4

Note: The test line loss file consists of two parts: the cable line loss provided by the customer, see report 3.3RF cable for details; All cable losses used in system construction are detailed in this table. The test line loss file value was called by the testing software and has been compensated for in the test power test project and PSD test project.

Chongqing Academy of Information and Communication Technology

Address: No. 8, Yuma Road, Chayuan New City, Nan'an District, Chongqing, P. R. China, 401336
Tel: 0086-23-88069965 FAX: 0086-23-88608777

4. Reference Documents

4.1. Documents supplied by applicant

PICS/PIXIT, referring to Annex B for detailed information, is supplied by the client or manufacturer, which is the basis of testing.

4.2. Reference Documents for testing

The following documents listed in this section are referred for testing.

Reference	Title	Version
FCC Part 15, Subpart E	Title 47 of the Code of Federal Regulations; Chapter I Part 15 - General technical requirements.	--
ANSI C63.10	American National Standard of Procedures for Compliance Testing of Unlicensed Wireless Devices	2013
KDB 789033 D02 General U-NII Test Procedures New Rules v02r01	GUIDELINES FOR COMPLIANCE TESTING OF UNLICENSED NATIONAL INFORMATION INFRASTRUCTURE (U-NII) DEVICES PART 15, SUBPART E	2017
KDB 662911 D01 Multiple Transmitter Output v02r01	Emissions Testing of Transmitters with Multiple Outputs in the Same Band	2013

Note1: KDB 789033/662911 is not A2AL certified.



5. Test Equipments Utilized

5.1. RF Test System

No.	Equipment	Model	SN	HW Version	SW Version	Manufacture	Cal.Due Date
1	spectrum analyzer	N9030A	MY55410223	--	--	Keysight	2023-06-29
2	spectrum analyzer	N9030B	MY57140708	--	--	Keysight	2023-06-29

5.2. RSE Test System

No.	Equipment	Model	SN	HW Version	SW Version	Manufacture	Cal.Due Date
1	Test Receiver	ESU40	100350	01	4.43 SP3	R&S	2023-06-29
2	Ultra-wideband Log Periodic Antenna	VULB 9163	9163-586	--	--	Schwarzbeck	2024-10-28
3	Double Ridged Guide Antenna	9120D	9120D-1103	--	--	Schwarzbeck	2024-05-05
4	Test Receiver	ESW 26	101382	00	1.50 SP1	R&S	2023-06-29
5	18GHz-26.5GHz Horn Antenna	DATE 1152	LM7127	--	--	ETS	2024-09-06
6	26.5GHz-40GHz Horn Antenna	DATE 1012	LM5945	--	--	ETS	2024-09-06
7	Loop Antenna	6502	00143163	--	--	ETS	2024-09-06
8	Preamplifier	SCU-08F1	08320027	--	--	R&S	--
9	Preamplifier	SCU-18F	180093	--	--	R&S	--

5.3. CE Test System

No.	Equipment	Model	SN	HW Version	SW Version	Manufacture	Cal.Due Date
1	Test Receiver	ESR 3	102477	03	3.48 SP2	R&S	2023-06-29
2	Artificial Main Network	ENV 216	102368	--	--	R&S	2023-04-31

5.4. Climate Chamber

No.	Name	Type	SN	Manufacture	Cal.Due Date
1	Fully anechoic chamber	FAC-5	--	TDK	2024-08-30
2	Semi-anechoic chamber	FAC-10	--	TDK	2024-08-28

Chongqing Academy of Information and Communication Technology

Address: No. 8, Yuma Road, Chayuan New City, Nan'an District, Chongqing, P. R. China, 401336
Tel: 0086-23-88069965 FAX: 0086-23-88608777

5.5. Vibration table

No.	Name	Type	SN	Manufacture	Cal.Due Date
--	--	--	--	--	--

Anechoic chamber

Fully anechoic chamber by TDK.

5.6. Test software

No.	Name	version	SN	Manufacture
1	EMC32	V 9.26.01	--	R&S
2	EMC32	V10.20.10	--	R&S
3	T-RFS500	V2.0	--	Manufacturer:Beijing Zhiwang Xince Technology Co., Ltd.

6. Test Results

6.1. Summary of Test Results

A brief summary of the tests carried out is shown as following.

FCC Rules	Name of Test	Result
FCC Part 15.407	99% Occupied Bandwidth	Pass
FCC CFR Part 15.407(a)	Maximum Output Power	Pass
FCC CFR Part 15.407(a)	Power Spectral Density	Pass
FCC 47 CFR Part 15.407(e)	6dB Occupied Bandwidth	Pass
FCC 47 CFR Part 15.407(b)	Band Edges Compliance (Radiated)	Pass
FCC 47 CFR Part 15.407(b)	Transmitter Spurious Emission-Radiated	Pass
FCC 47 CFR Part 15.407(b)	AC Powerline Conducted Emission (150kHz- 30MHz)	Pass
FCC 47 CFR Part 15.203	Antenna requiemment	Pass ^{Note1}

Note1: The EUT have two RF welding disc interfaces for connecting external antennas and contain the two unique antenna connectors. Antenna type is Sector Glue Stick Antenna; Two antenna ports use same antennas. The max antenna gain is : 2.4G: 2.97dBi, UNII 1: 3.50dBi, UNII 2C: 3.94dBi, UNII 3: 3.52dBi, UNII 5: 3.99dBi, UNII 6: 3.29dBi, UNII 7: 3.95dBi, UNII 8: 3.82dBi; So this EUT Complies with the FCC section 15.203 antenna requirements, please refer to the internal photos.

6.2. 99% Occupied Bandwidth

SpeciPications:	--
DUT Serial Number:	S1
Test conditions:	Ambient Temperature:15℃-35℃ Relative Humidity:30%-60% Air pressure: 86-106kPa
Test Results:	Pass

Limit Level Construction:

Standard	Limit (dBm)
--	--

Measurement Uncertainty:

Measurement Uncertainty	±10.04kHz
-------------------------	-----------

Test Procedure

The measurement is according to KDB 789033 D02 clause II.D

The following procedure shall be used for measuring (99%) power bandwidth:

1. Set center frequency to the nominal EUT channel center frequency.
2. Set span = 1.5 times to 5.0 times the OBW.
3. Set RBW = 1% to 5% of the OBW
4. Set VBW $\geq 3 \times$ RBW
5. Video averaging is not permitted. Where practical, a sample detection and single sweep mode shall be used. Otherwise, peak detection and max hold mode (until the trace stabilizes) shall be used.
6. Use the 99% power bandwidth function of the instrument (if available).
7. If the instrument does not have a 99% power bandwidth function, the trace data points are recovered and directly summed in power units. The recovered amplitude data points, beginning at the lowest frequency, are placed in a running sum until 0.5% of the total is reached; that frequency is recorded as the lower frequency. The process is repeated until 99.5% of the total is reached; that frequency is recorded as the upper frequency. The 99% occupied bandwidth is the difference between these two frequencies.

Chongqing Academy of Information and Communication Technology

Address: No. 8,Yuma Road, Chayuan New City, Nan'an District, Chongqing, P. R. China,401336
Tel: 0086-23-88069965 FAX:0086-23-88608777

Test block diagram:

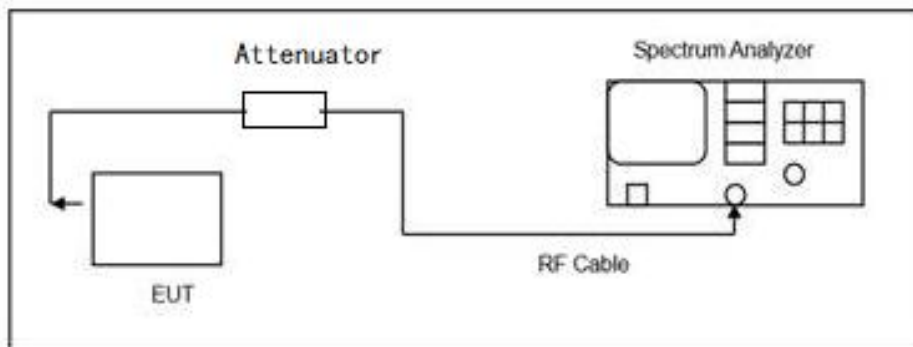

Measurement Results:

Chain.0

Mode	RU Con.	Channel		99% OBW(MHz)	Conclusion
802.11a-20	NA	149	Pic.1	16.537	PASS
		157	Pic.2	16.584	PASS
		165	Pic.3	16.516	PASS
802.11n-HT20	NA	149	Pic.4	17.686	PASS
		157	Pic.5	17.781	PASS
		165	Pic.6	17.680	PASS
802.11n-HT40	NA	151	Pic.7	35.997	PASS
		159	Pic.8	36.142	PASS
802.11ac-VHT20	NA	149	Pic.9	17.824	PASS
		157	Pic.10	17.751	PASS
		165	Pic.11	17.761	PASS
802.11ac-VHT40	NA	151	Pic.12	36.115	PASS
		159	Pic.13	36.175	PASS
802.11ac-VHT80	NA	155	Pic.14	75.500	PASS
802.11ax-HE20	Full	149	Pic.15	19.054	PASS
		157	Pic.16	18.991	PASS
		165	Pic.17	19.021	PASS
802.11ax-HE40	Full	151	Pic.18	38.016	PASS
		159	Pic.19	37.994	PASS
802.11ax-HE80	Full	155	Pic.20	77.075	PASS

Test Picture as below:

Note: Test screenshots can be found in Chapter 6.3

6.3. Maximum Output Power

Specifications:	FCC Part 15.407 (a)
DUT Serial Number:	S1
Test conditions:	Ambient Temperature:15°C-35°C Relative Humidity:30%-60% Air pressure: 86-106kPa
Test Results:	Pass

Limit Level Construction:

Standard	Frequency (MHz)	Limit (dBm)
FCC Part 15.407 (a)	5725MHz-5850MHz	For the band 5.725-5.850 GHz, the maximum conducted output power over the frequency band of operation shall not exceed 1 W.If transmitting antennas of directional gain greater than 6 dBi are used, both the maximum conducted output power and the maximum power spectral density shall be reduced by the amount in dB that the directional gain of the antenna exceeds 6 dBi.

Note: Directional gain according to section 3.2 of this report

Band	802.11a Directional gain (dBi)	802.11n/ac/ax Directional gain (dBi)
UNII 3	3.52	6.53

UNII 3: 802.11a limit=1w=30dBm;

802.11n/ac/ax limit=1W-(DG-6)=29.47dBm

Measurement Uncertainty:

Measurement Uncertainty	±0.50dB
-------------------------	---------

Test Procedure

The measurement is according to ANSI C63.10 clause12.3.2.2

- Set span to encompass the entire 26 dB EBW or 99% OBW of the signal.
- Set RBW = 1 MHz.
- Set VBW \geq 3 MHz.
- Number of points in sweep \geq $[2 \cdot \text{span} / \text{RBW}]$. (This gives bin-to-bin spacing \leq RBW / 2, so that narrowband signals are not lost between frequency bins.)
- Sweep time = auto.
- Detector = RMS (i.e., power averaging), if available. Otherwise, use sample detector mode.
- If transmit duty cycle $<$ 98%, use a video trigger with the trigger level set to enable triggering

Chongqing Academy of Information and Communication Technology

Address: No. 8,Yuma Road, Chayuan New City, Nan'an District, Chongqing, P. R. China,401336
Tel: 0086-23-88069965 FAX:0086-23-88608777

Report No.: I22W00019-WiFi RF-5.8GHz-Rev4

only on full power pulses. The transmitter shall operate at maximum power control level for the entire duration of every sweep. If the EUT transmits continuously (i.e., with no OFF intervals) or at duty cycle $\geq 98\%$, and if each transmission is entirely at the maximum power control level, then the trigger shall be set to “free run.”

h) Trace average at least 100 traces in power averaging (rms) mode.

i) Compute power by integrating the spectrum across the 26 dB EBW or 99% OBW of the signal using the instrument’s band power measurement function, with band limits set equal to the EBW or OBW band edges. If the instrument does not have a band power function, then sum the spectrum levels (in power units) at 1 MHz intervals extending across the 26 dB EBW or 99% OBW of the spectrum.

Note: The test screenshot only reflects the worst-case rate results.

Test block diagram:

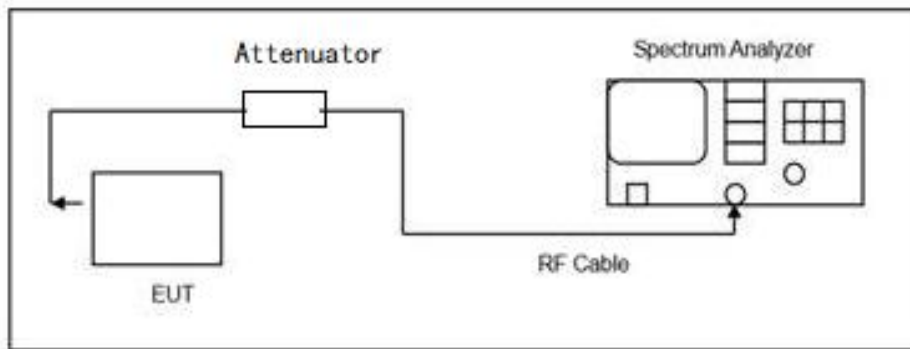

Measurement Results:

Chain.0

Mode	Data Rate(Mbps)	Teat Result(dBm)			Conclusion
		Ch149	Ch157	Ch165	
802.11a	6 Mbps	10.33	/	/	PASS
	9 Mbps	10.34	/	/	PASS
	12 Mbps	10.39	/	/	PASS
	18 Mbps	10.45	/	/	PASS
	24 Mbps	11.19	10.91	10.52	PASS
	36 Mbps	10.70	/	/	PASS
	48 Mbps	10.59	/	/	PASS
	54 Mbps	10.58	/	/	PASS

The data rate 24 Mbps is selected as worse condition, and the following cases are performed with this condition.

Chongqing Academy of Information and Communication Technology

Address: No. 8,Yuma Road, Chayuan New City, Nan'an District, Chongqing, P. R. China,401336
 Tel: 0086-23-88069965 FAX:0086-23-88608777

**Report No.: I22W00019-WiFi RF-5.8GHz-Rev4**

Mode	Data Rate(Mbps)	Teat Result(dBm)			Conclusion
		Ch149	Ch157	Ch165	
802.11n-HT20	MCS 0	10.23	/	/	PASS
	MCS 1	10.57	/	/	PASS
	MCS 2	10.69	/	/	PASS
	MCS 3	10.69	/	/	PASS
	MCS 4	10.80	/	/	PASS
	MCS 5	10.84	/	/	PASS
	MCS 6	10.79	/	/	PASS
	MCS 7	11.19	11.29	10.72	PASS

The data rate MCS7 is selected as worse condition, and the following cases are performed with this condition.

Mode	Data Rate(Mbps)	Teat Result(dBm)		Conclusion
		Ch151	Ch159	
802.11n-HT40	MCS 0	11.04	/	PASS
	MCS 1	11.05	10.84	PASS
	MCS 2	11.03	/	PASS
	MCS 3	11.00	/	PASS
	MCS 4	10.92	/	PASS
	MCS 5	10.90	/	PASS
	MCS 6	10.87	/	PASS
	MCS 7	10.85	/	PASS

The data rate MCS1 is selected as worse condition, and the following cases are performed with this condition.

Mode	Data Rate(Mbps)	Teat Result(dBm)			Conclusion
		Ch149	Ch157	Ch165	
802.11ac-VHT20	MCS 0	10.71	/	/	PASS
	MCS 1	10.75	/	/	PASS
	MCS 2	10.72	/	/	PASS
	MCS 3	10.71	/	/	PASS
	MCS 4	11.42	11.22	10.76	PASS
	MCS 5	10.83	/	/	PASS
	MCS 6	10.86	/	/	PASS
	MCS 7	10.87	/	/	PASS
	MCS 8	10.89	/	/	PASS
	MCS 9	10.88	/	/	PASS

The data rate MCS4 is selected as worse condition, and the following cases are performed with this condition.

Chongqing Academy of Information and Communication Technology

Address: No. 8,Yuma Road, Chayuan New City, Nan'an District, Chongqing, P. R. China,401336
 Tel: 0086-23-88069965 FAX:0086-23-88608777



Report No.: I22W00019-WiFi RF-5.8GHz-Rev4

Mode	Data Rate(Mbps)	Teat Result(dBm)		Conclusion
		Ch151	Ch159	
802.11ac-VHT40	MCS 0	10.75	/	PASS
	MCS 1	10.88	/	PASS
	MCS 2	10.89	/	PASS
	MCS 3	11.47	11.21	PASS
	MCS 4	10.90	/	PASS
	MCS 5	10.88	/	PASS
	MCS 6	10.93	/	PASS
	MCS 7	10.90	/	PASS
	MCS 8	10.87	/	PASS
	MCS 9	10.87	/	PASS

The data rate MCS3 is selected as worse condition, and the following cases are performed with this condition.

Mode	Data Rate(Mbps)	Teat Result(dBm)	Conclusion
		Ch155	
802.11ac-VHT80	MCS 0	10.93	PASS
	MCS 1	11.00	PASS
	MCS 2	10.95	PASS
	MCS 3	11.04	PASS
	MCS 4	10.56	PASS
	MCS 5	10.61	PASS
	MCS 6	10.53	PASS
	MCS 7	10.60	PASS
	MCS 8	10.66	PASS
	MCS 9	10.62	PASS

The data rate MCS3 is selected as worse condition, and the following cases are performed with this condition.

Mode	RU Con.	Data Rate(Mbps)	Teat Result(dBm)			Conclusion
			Ch149	Ch157	Ch165	
802.11ax-HE20	Full	MCS 0	12.05	11.91	11.35	PASS
	Full	MCS 1	10.66	/	/	PASS
	Full	MCS 2	10.71	/	/	PASS
	Full	MCS 3	10.80	/	/	PASS
	Full	MCS 4	10.77	/	/	PASS
	Full	MCS 5	10.72	/	/	PASS
	Full	MCS 6	10.83	/	/	PASS
	Full	MCS 7	10.72	/	/	PASS
	Full	MCS 8	10.76	/	/	PASS

Chongqing Academy of Information and Communication Technology

Address: No. 8,Yuma Road, Chayuan New City, Nan'an District, Chongqing, P. R. China,401336
Tel: 0086-23-88069965 FAX:0086-23-88608777

**Report No.: I22W00019-WiFi RF-5.8GHz-Rev4**

	Full	MCS 9	10.71	/	/	PASS
--	------	-------	-------	---	---	------

The data rate MCS0 is selected as worse condition, and the following cases are performed with this condition.

Mode	RU Con.	Data Rate(Mbps)	Teat Result(dBm)		Conclusion
			Ch151	Ch159	
802.11ax-HE40	Full	MCS 0	10.52	/	PASS
	Full	MCS 1	10.48	/	PASS
	Full	MCS 2	10.50	/	PASS
	Full	MCS 3	10.54	/	PASS
	Full	MCS 4	10.64	/	PASS
	Full	MCS 5	12.25	12.07	PASS
	Full	MCS 6	10.63	/	PASS
	Full	MCS 7	10.71	/	PASS
	Full	MCS 8	10.73	/	PASS
Full	MCS 9	10.67	/	PASS	

The data rate MCS5 is selected as worse condition, and the following cases are performed with this condition.

Mode	RU Con.	Data Rate(Mbps)	Teat Result(dBm)	Conclusion
			Ch155	
802.11ax-HE80	Full	MCS 0	11.40	PASS
	Full	MCS 1	10.64	PASS
	Full	MCS 2	10.67	PASS
	Full	MCS 3	10.66	PASS
	Full	MCS 4	10.49	PASS
	Full	MCS 5	10.66	PASS
	Full	MCS 6	10.50	PASS
	Full	MCS 7	10.58	PASS
	Full	MCS 8	10.50	PASS
Full	MCS 9	10.51	PASS	

The data rate MCS0 is selected as worse condition, and the following cases are performed with this condition.

Chain.1

Mode	Data Rate(Mbps)	Teat Result(dBm)			Conclusion
		Ch149	Ch157	Ch165	
802.11a	6 Mbps	10.83	/	/	PASS
	9 Mbps	10.98	/	/	PASS
	12 Mbps	10.95	/	/	PASS

Chongqing Academy of Information and Communication Technology

Address: No. 8,Yuma Road, Chayuan New City, Nan'an District, Chongqing, P. R. China,401336
 Tel: 0086-23-88069965 FAX:0086-23-88608777

**Report No.: I22W00019-WiFi RF-5.8GHz-Rev4**

	18 Mbps	11.02	/	/	PASS
	24 Mbps	11.20	10.76	9.90	PASS
	36 Mbps	11.10	/	/	PASS
	48 Mbps	11.17	/	/	PASS
	54 Mbps	11.18	/	/	PASS

The data rate 24 Mbps is selected as worse condition, and the following cases are performed with this condition.

Mode	Data Rate(Mbps)	Teat Result(dBm)			Conclusion
		Ch149	Ch157	Ch165	
802.11n-HT20	MCS 0	11.06	/	/	PASS
	MCS 1	10.98	/	/	PASS
	MCS 2	10.96	/	/	PASS
	MCS 3	11.16	/	/	PASS
	MCS 4	11.21	/	/	PASS
	MCS 5	11.21	/	/	PASS
	MCS 6	11.19	/	/	PASS
	MCS 7	11.55	11.17	10.28	PASS

The data rate MCS7 is selected as worse condition, and the following cases are performed with this condition.

Mode	Data Rate(Mbps)	Teat Result(dBm)		Conclusion
		Ch151	Ch159	
802.11n-HT40	MCS 0	11.08	/	PASS
	MCS 1	11.20	10.76	PASS
	MCS 2	11.08	/	PASS
	MCS 3	10.99	/	PASS
	MCS 4	10.88	/	PASS
	MCS 5	10.89	/	PASS
	MCS 6	10.88	/	PASS
	MCS 7	10.86	/	PASS

The data rate MCS1 is selected as worse condition, and the following cases are performed with this condition.

Mode	Data Rate(Mbps)	Teat Result(dBm)			Conclusion
		Ch149	Ch157	Ch165	
802.11ac-VHT20	MCS 0	11.22	/	/	PASS
	MCS 1	11.23	/	/	PASS
	MCS 2	11.22	/	/	PASS
	MCS 3	11.14	/	/	PASS
	MCS 4	11.50	11.12	10.18	PASS
	MCS 5	11.28	/	/	PASS

Chongqing Academy of Information and Communication Technology

Address: No. 8,Yuma Road, Chayuan New City, Nan'an District, Chongqing, P. R. China,401336
 Tel: 0086-23-88069965 FAX:0086-23-88608777

**Report No.: I22W00019-WiFi RF-5.8GHz-Rev4**

	MCS 6	11.22	/	/	PASS
	MCS 7	11.22	/	/	PASS
	MCS 8	11.24	/	/	PASS
	MCS 9	11.18	/	/	PASS

The data rate MCS4 is selected as worse condition, and the following cases are performed with this condition.

Mode	Data Rate(Mbps)	Teat Result(dBm)		Conclusion
		Ch151	Ch159	
802.11ac-VHT40	MCS 0	11.50	/	PASS
	MCS 1	11.41	/	PASS
	MCS 2	11.36	/	PASS
	MCS 3	11.70	11.31	PASS
	MCS 4	11.17	/	PASS
	MCS 5	11.19	/	PASS
	MCS 6	11.19	/	PASS
	MCS 7	11.15	/	PASS
	MCS 8	11.18	/	PASS
	MCS 9	11.18	/	PASS

The data rate MCS3 is selected as worse condition, and the following cases are performed with this condition.

Mode	Data Rate(Mbps)	Teat Result(dBm)	Conclusion
		Ch155	
802.11ac-VHT80	MCS 0	11.42	PASS
	MCS 1	11.32	PASS
	MCS 2	11.38	PASS
	MCS 3	11.91	PASS
	MCS 4	11.13	PASS
	MCS 5	11.09	PASS
	MCS 6	11.12	PASS
	MCS 7	11.17	PASS
	MCS 8	11.20	PASS
	MCS 9	11.12	PASS

The data rate MCS3 is selected as worse condition, and the following cases are performed with this condition.

Mode	RU Con.	Data Rate(Mbps)	Teat Result(dBm)			Conclusion
			Ch149	Ch157	Ch165	
802.11ax-HE20	Full	MCS 0	11.53	11.27	10.35	PASS
	Full	MCS 1	11.21	/	/	PASS
	Full	MCS 2	11.18	/	/	PASS

Chongqing Academy of Information and Communication Technology

Address: No. 8, Yuma Road, Chayuan New City, Nan'an District, Chongqing, P. R. China, 401336
 Tel: 0086-23-88069965 FAX: 0086-23-88608777



Report No.: I22W00019-WiFi RF-5.8GHz-Rev4

	Full	MCS 3	11.07	/	/	PASS
	Full	MCS 4	11.02	/	/	PASS
	Full	MCS 5	11.02	/	/	PASS
	Full	MCS 6	11.01	/	/	PASS
	Full	MCS 7	10.82	/	/	PASS
	Full	MCS 8	10.86	/	/	PASS
	Full	MCS 9	10.90	/	/	PASS

The data rate MCS0 is selected as worse condition, and the following cases are performed with this condition.

Mode	RU Con.	Data Rate(Mbps)	Teat Result(dBm)		Conclusion
			Ch151	Ch159	
802.11ax-HE40	Full	MCS 0	11.46	/	PASS
	Full	MCS 1	11.42	/	PASS
	Full	MCS 2	11.34	/	PASS
	Full	MCS 3	11.32	/	PASS
	Full	MCS 4	11.39	/	PASS
	Full	MCS 5	11.57	11.15	PASS
	Full	MCS 6	11.37	/	PASS
	Full	MCS 7	11.36	/	PASS
	Full	MCS 8	11.34	/	PASS
	Full	MCS 9	11.31	/	PASS

The data rate MCS5 is selected as worse condition, and the following cases are performed with this condition.

Mode	RU Con.	Data Rate(Mbps)	Teat Result(dBm)	Conclusion
			Ch155	
802.11ax-HE80	Full	MCS 0	11.60	PASS
	Full	MCS 1	11.25	PASS
	Full	MCS 2	11.26	PASS
	Full	MCS 3	11.14	PASS
	Full	MCS 4	11.18	PASS
	Full	MCS 5	11.16	PASS
	Full	MCS 6	11.14	PASS
	Full	MCS 7	11.09	PASS
	Full	MCS 8	11.10	PASS
	Full	MCS 9	11.17	PASS

The data rate MCS3 is selected as worse condition, and the following cases are performed with this condition.

Chongqing Academy of Information and Communication Technology

Address: No. 8,Yuma Road, Chayuan New City, Nan'an District, Chongqing, P. R. China,401336
Tel: 0086-23-88069965 FAX:0086-23-88608777



Report No.: I22W00019-WiFi RF-5.8GHz-Rev4

MIMO

Mode	Chain0 Test Result(dBm)			Chain1 Test Result(dBm)			Totle Result(dBm)			Conclusion
	Ch149	Ch157	Ch165	Ch149	Ch157	Ch165	Ch149	Ch157	Ch165	
802.11n-HT20	11.19	11.29	10.72	11.55	11.17	10.28	14.38	14.24	13.52	PASS
802.11ac-VHT20	11.42	11.22	10.76	11.50	11.12	10.18	14.47	14.18	13.49	PASS
802.11ax-HE20	12.05	11.91	11.35	11.53	11.27	10.35	14.81	14.61	13.89	PASS

Mode	Chain0 Test Result(dBm)		Chain1 Test Result(dBm)		Totle Result(dBm)		Conclusion
	Ch151	Ch159	Ch151	Ch159	Ch151	Ch159	
802.11n-HT40	11.05	10.84	11.20	10.76	14.14	13.81	PASS
802.11ac-VHT40	11.47	11.21	11.70	11.31	14.60	14.27	PASS
802.11ax-HE40	12.25	12.07	11.57	11.15	14.93	14.64	PASS

Mode	Chain0 Test Result(dBm)	Chain1 Test Result(dBm)	Teat Result(dBm)	Conclusion
	Ch155	Ch155	Ch155	
802.11ac-VHT80	11.04	11.91	14.51	PASS
802.11ax-HE80	11.40	11.60	14.51	PASS

Test Picture as below:

Duty cycle:

Mode	UNII-3
11a	>98%
11n HT20	>98%
11n HT40	>98%
11ac-VHT20	>98%
11ac-VHT40	>98%
11ac-VHT80	>98%
11ax-HE20	>98%
11ax-HE40	>98%
11ax-HE80	>98%

Chongqing Academy of Information and Communication Technology

Address: No. 8,Yuma Road, Chayuan New City, Nan'an District, Chongqing, P. R. China,401336
Tel: 0086-23-88069965 FAX:0086-23-88608777

Report No.: I22W00019-WiFi RF-5.8GHz-Rev4

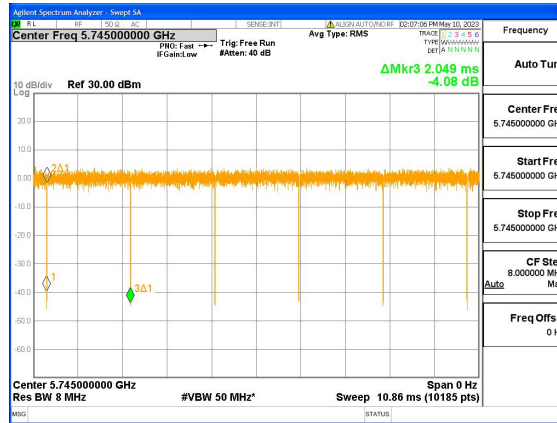

UNII-3-11a-Duty cycle

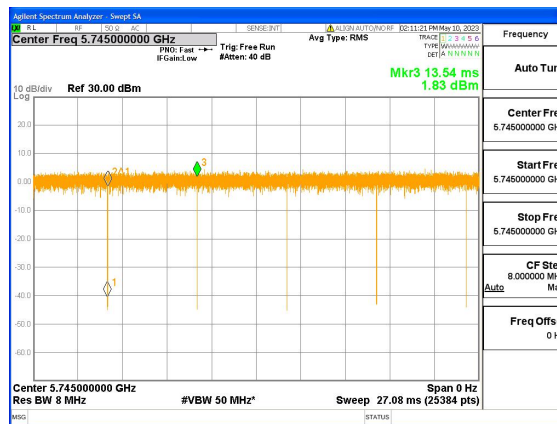

UNII-3-11n-HT20-Duty cycle

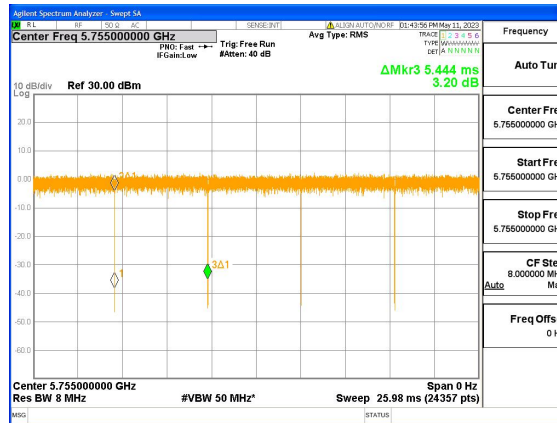

UNII-3-11n-HT40-Duty cycle

Chongqing Academy of Information and Communication Technology

Address: No. 8, Yuma Road, Chayuan New City, Nan'an District, Chongqing, P. R. China, 401336
 Tel: 0086-23-88069965 FAX: 0086-23-88608777

Report No.: I22W00019-WiFi RF-5.8GHz-Rev4

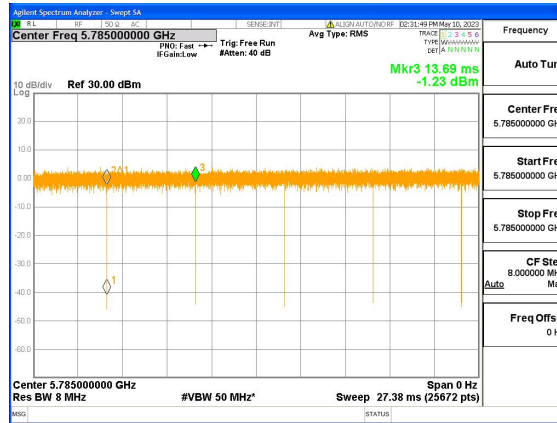

UNII-3-11ac-VHT20-Duty cycle

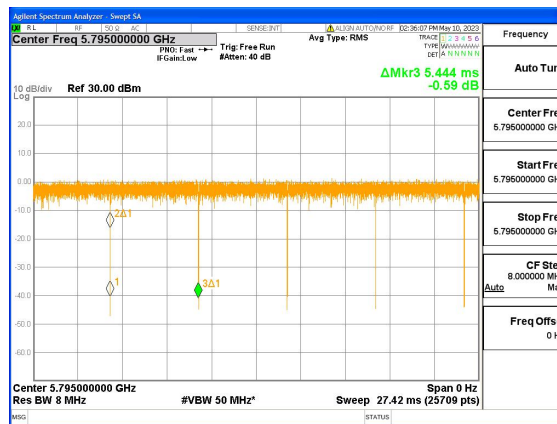

UNII-3-11ac-VHT40-Duty cycle

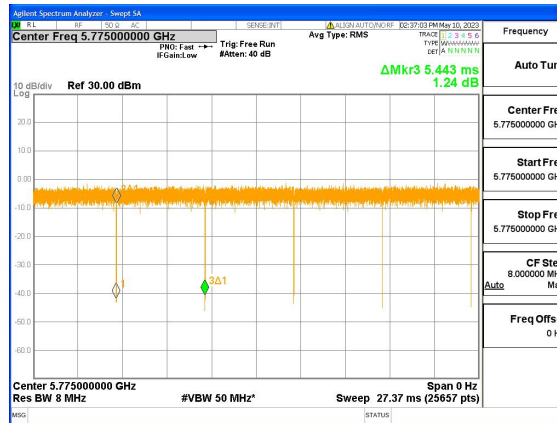

UNII-3-11ac-VHT80-Duty cycle

Chongqing Academy of Information and Communication Technology

Address: No. 8, Yuma Road, Chayuan New City, Nan'an District, Chongqing, P. R. China, 401336
Tel: 0086-23-88069965 FAX: 0086-23-88608777

Report No.: I22W00019-WiFi RF-5.8GHz-Rev4

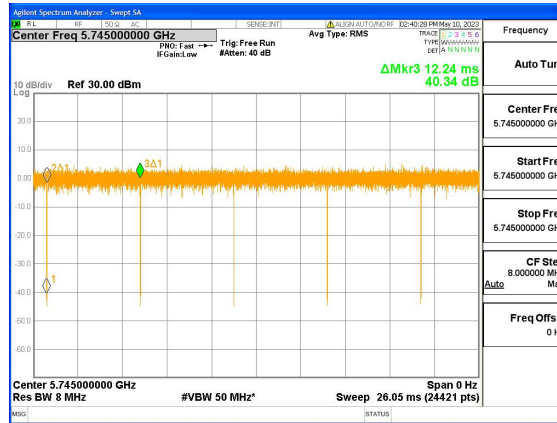

UNII-3-11ax-HE20-Duty cycle

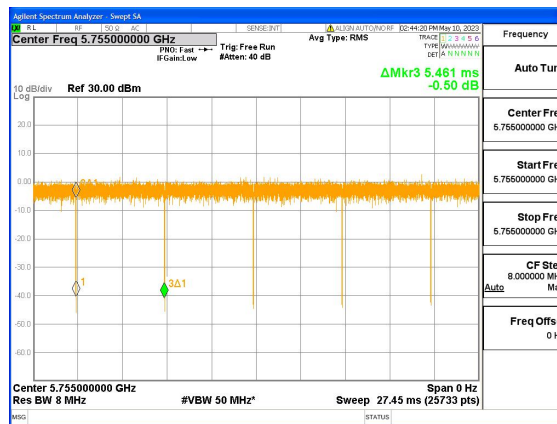

UNII-3-11ax-HE40-Duty cycle

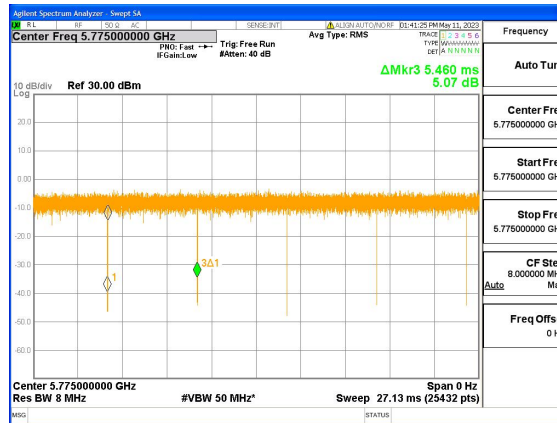

UNII-3-11ax-HE80-Duty cycle

Chain.0
11a:

pic1_Obw	pic1_Rms
----------	----------

Chongqing Academy of Information and Communication Technology

Address: No. 8, Yuma Road, Chayuan New City, Nan'an District, Chongqing, P. R. China, 401336
Tel: 0086-23-88069965 FAX: 0086-23-88608777



Report No.: I22W00019-WiFi RF-5.8GHz-Rev4

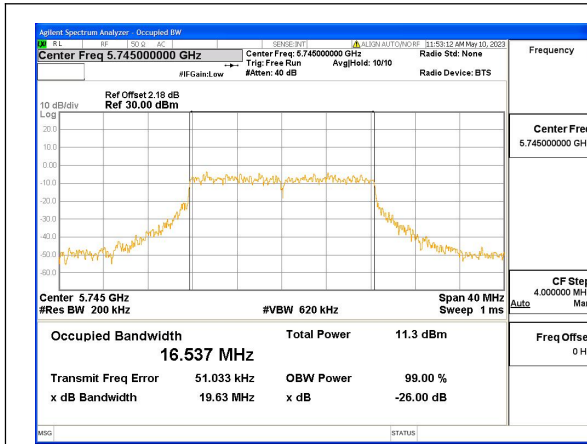

pic2_Obw

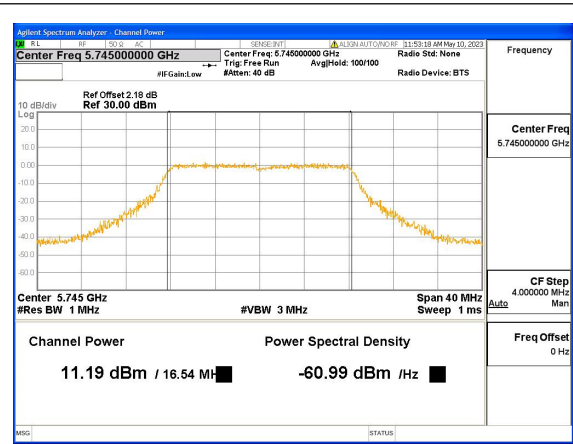

pic2_Rms

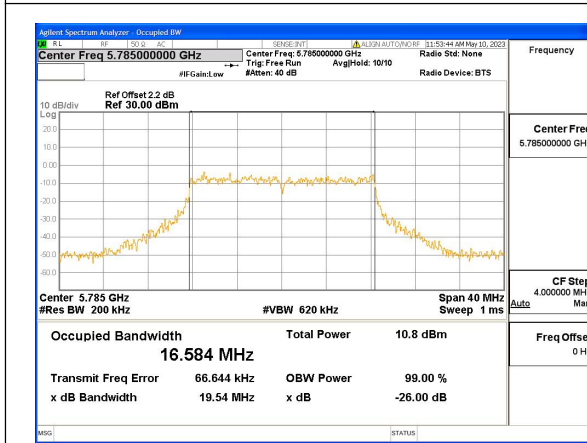

pic3_Obw

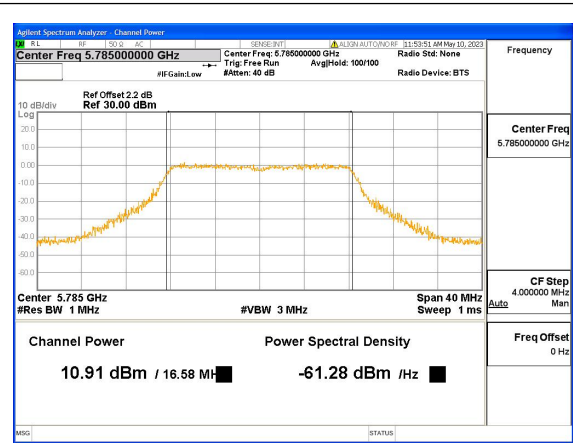

pic3_Rms

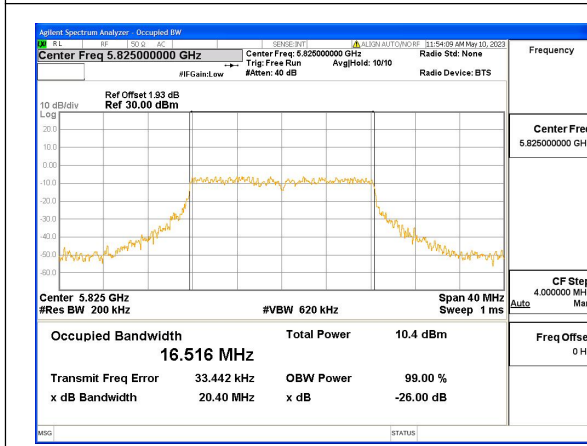

pic1_Obw



pic1_Rms

11n-HT20:

pic1_Obw	pic1_Rms
----------	----------

Chongqing Academy of Information and Communication Technology

Address: No. 8, Yuma Road, Chayuan New City, Nan'an District, Chongqing, P. R. China, 401336
 Tel: 0086-23-88069965 FAX: 0086-23-88608777



Report No.: I22W00019-WiFi RF-5.8GHz-Rev4

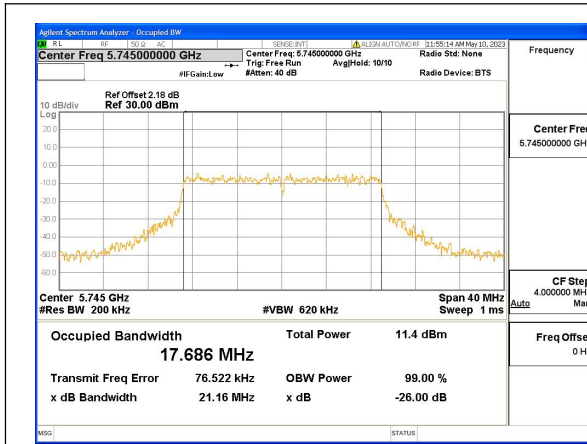

pic2_Obw

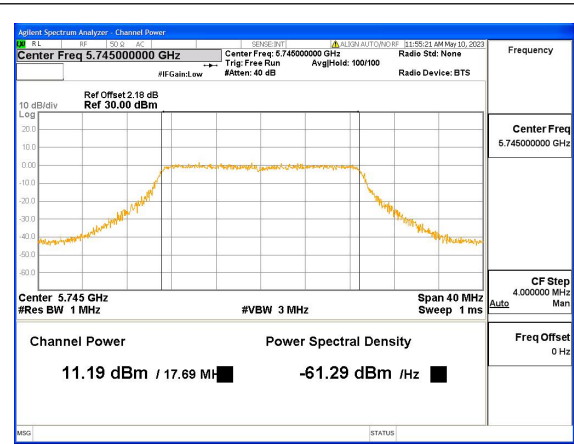

pic2_Rms

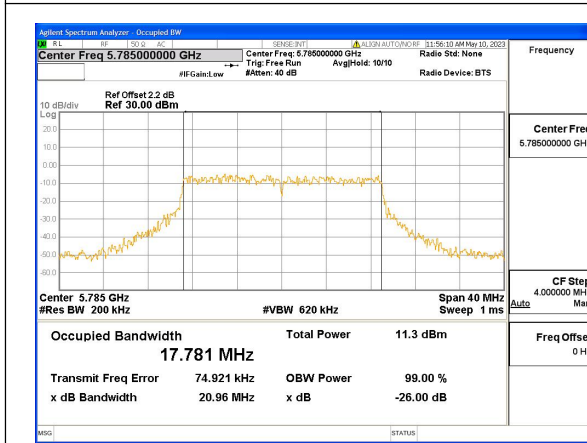

pic3_Obw



pic3_Rms

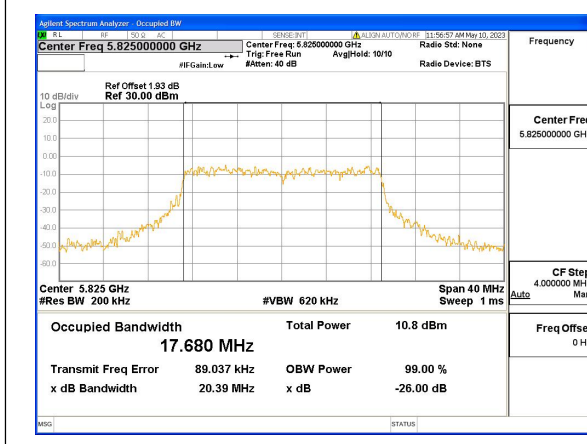

pic1_Obw

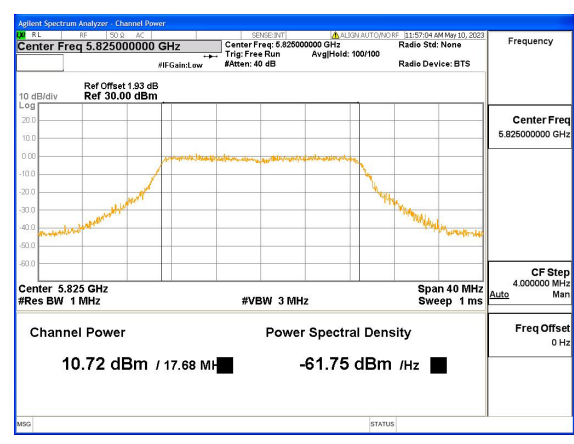

pic1_Rms

11n-HT40:

Chongqing Academy of Information and Communication Technology

Address: No. 8, Yuma Road, Chayuan New City, Nan'an District, Chongqing, P. R. China, 401336
Tel: 0086-23-88069965 FAX: 0086-23-88608777



Report No.: I22W00019-WiFi RF-5.8GHz-Rev4

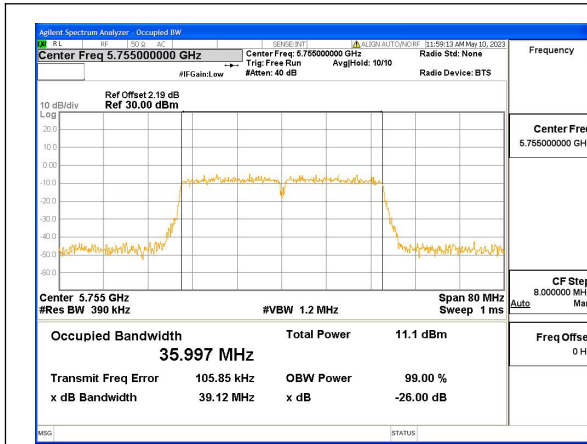

pic2_Obw



pic2_Rms

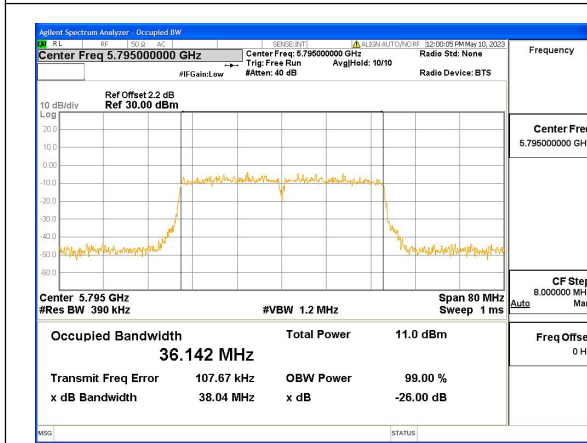

11ac-VHT20:

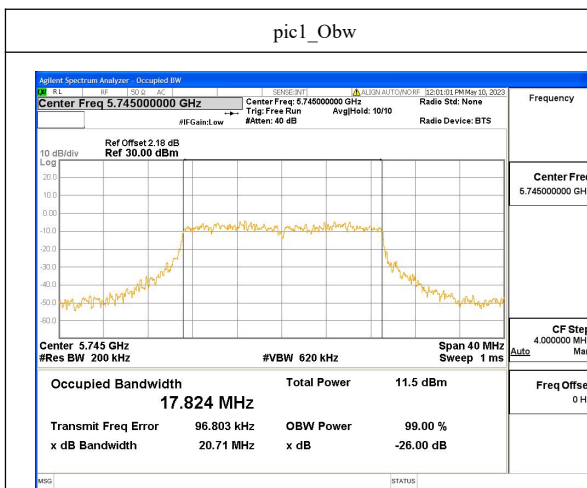

pic1_Obw

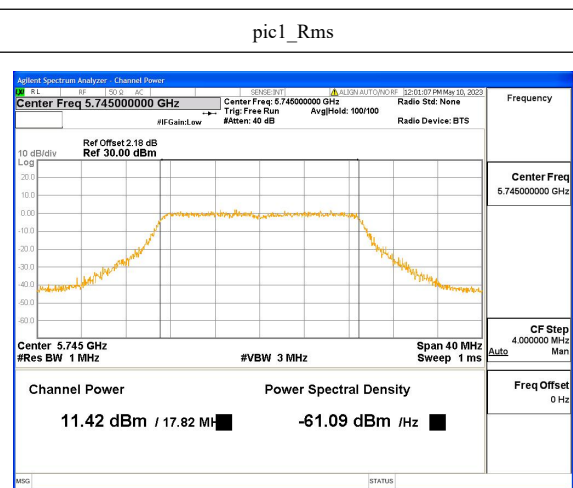

pic1_Rms

pic2_Obw

pic2_Rms

Chongqing Academy of Information and Communication Technology

Address: No. 8, Yuma Road, Chayuan New City, Nan'an District, Chongqing, P. R. China, 401336
Tel: 0086-23-88069965 FAX: 0086-23-88608777



Report No.: I22W00019-WiFi RF-5.8GHz-Rev4

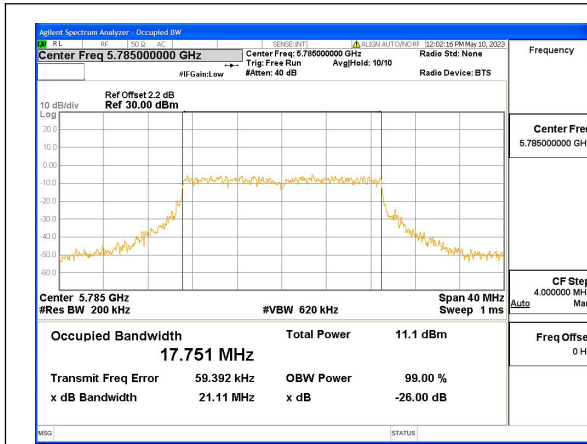

pic3_Obw

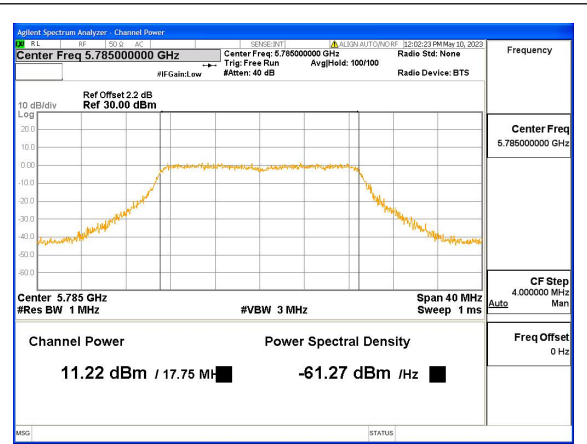

pic3_Rms

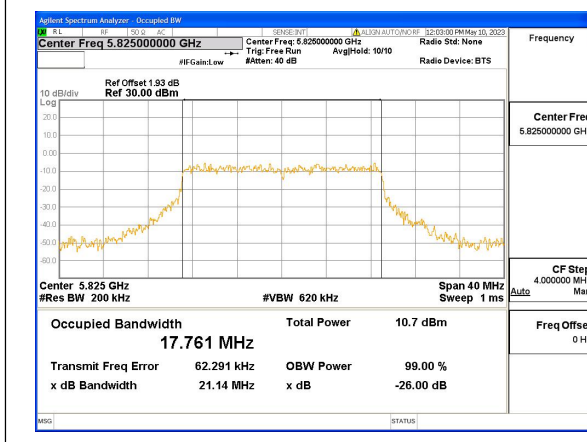

11ac-VHT40:

pic1_Obw

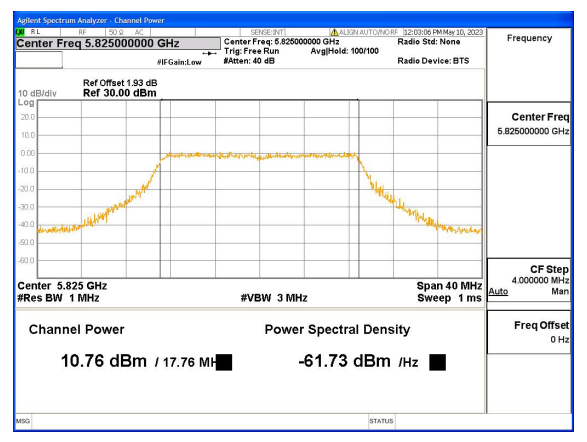

pic1_Rms

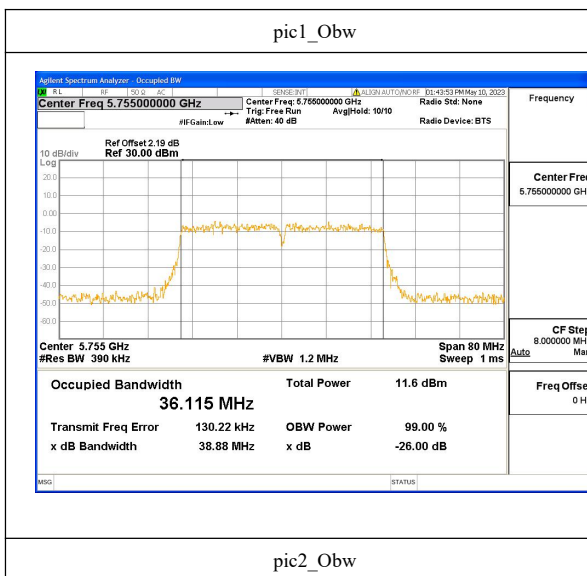

pic2_Obw

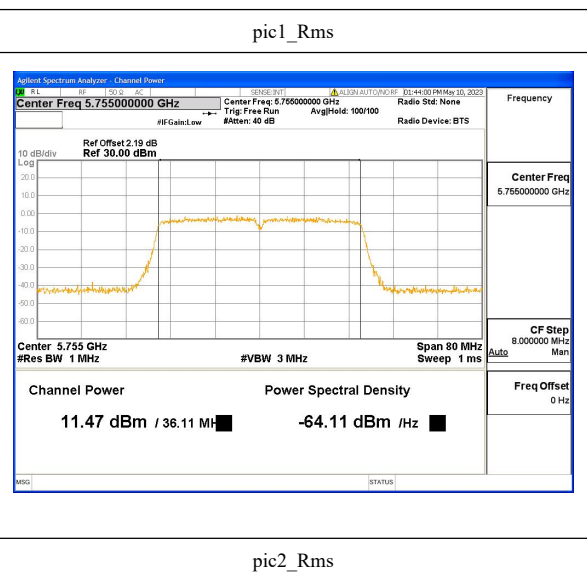

pic2_Rms

Chongqing Academy of Information and Communication Technology

Address: No. 8, Yuma Road, Chayuan New City, Nan'an District, Chongqing, P. R. China, 401336
Tel: 0086-23-88069965 FAX: 0086-23-88608777



Report No.: I22W00019-WiFi RF-5.8GHz-Rev4

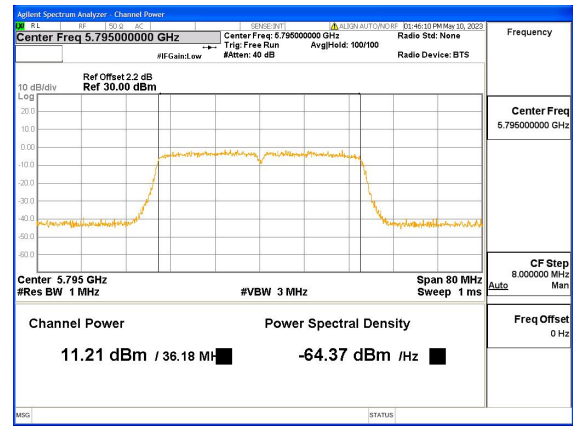
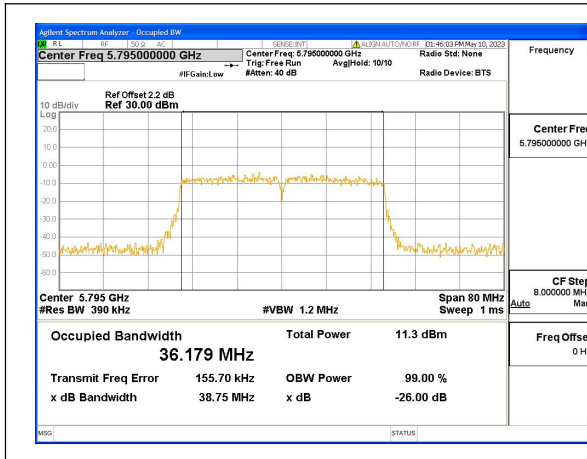

11ac-VHT80:

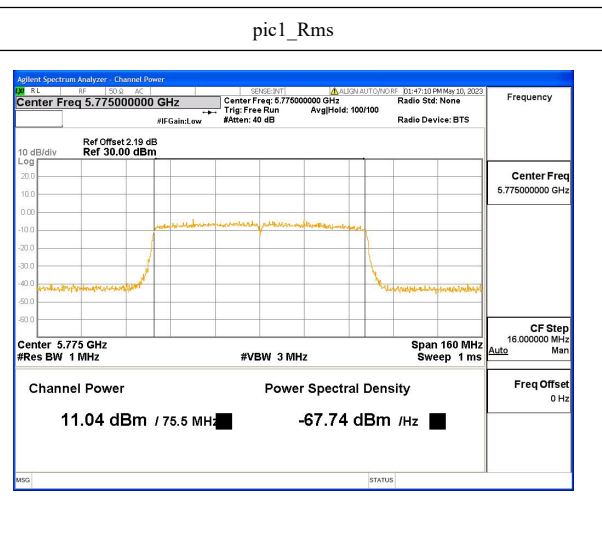
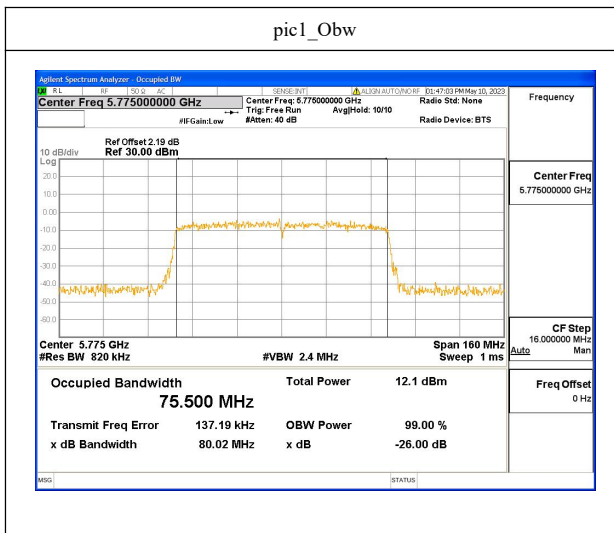

11ax-HE20:

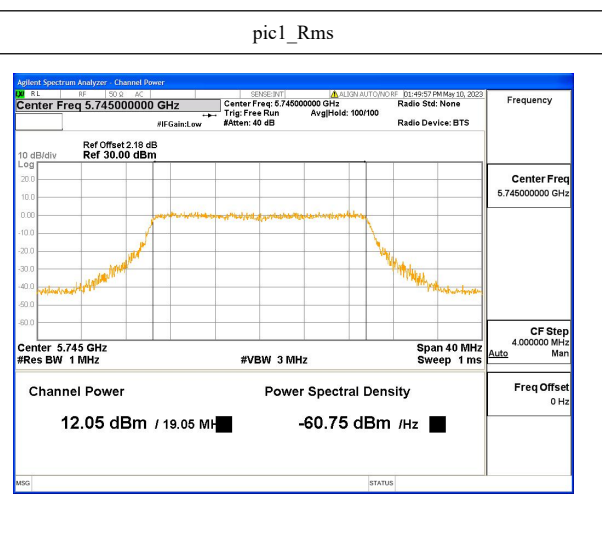
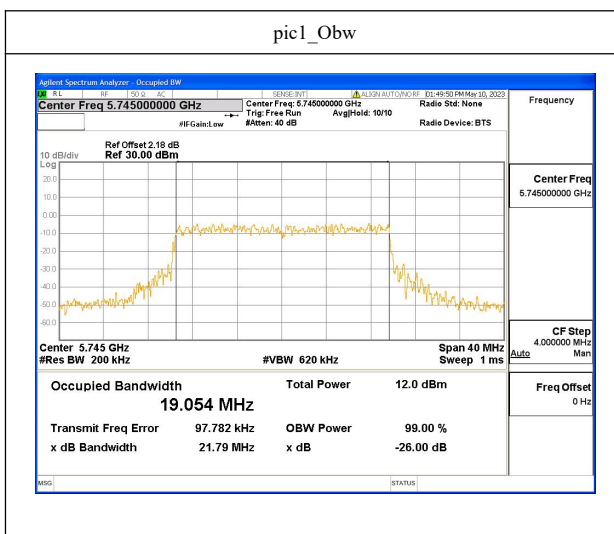

Chongqing Academy of Information and Communication Technology

Address: No. 8, Yuma Road, Chayuan New City, Nan'an District, Chongqing, P. R. China, 401336
Tel: 0086-23-88069965

FAX: 0086-23-88608777