

TEST REPORT

Report No.: SHE23060104-02BE

Date: 2023-08-08

Page 1 of 61

Applicant : SIMCom Wireless Solutions Limited.
Address of Applicant : SIMCom Headquarters Building, Building 3, No.289
Linhong Road, Changning District, Shanghai,China

Product Name : Wireless Data Module
Brand Name : SIMCom
Model Name : SIM8070
Sample Acquisition Method : Sent by Client

Sample No. : E23060104-01#01

FCC ID : 2AJYU-8XK0002

Standards : FCC CFR47 Part 15, Subpart C

Date of Receipt : 2023-07-07
Date of Test : 2023-07-13~ 2023-08-04
Date of Issue : 2023-08-08

Remark:

This report details the results of the testing carried out on one sample, the results contained in this report do not relate to other samples of the same product. The manufacturer should ensure that all products in series production are in conformity with the product sample detailed in this report.

Prepared by: Erik Yang
(Erik Yang)

Reviewed by: Jennifer Zhou
(Jennifer Zhou)

Approved by: Echo Mu
(Authorized signatory: Echo Mu)

TEST REPORT

Report No.: SHE23060104-02BE

Date: 2023-08-08

Page 2 of 61

Contents

1	GENERAL INFORMATION	3
1.1	TESTING LABORATORY	3
1.2	DETAILS OF APPLICATION	3
1.3	DETAILS OF EUT	3
1.4	TEST METHODOLOGY	4
1.5	TEST SUMMARY	5
2	TEST CONDITION	6
2.1	ENVIRONMENTAL CONDITIONS	6
2.2	EQUIPMENT LIST	6
2.3	MEASUREMENT UNCERTAINTY	7
3	TEST SET-UP AND OPERATION MODES	8
3.1	DETAILS OF TEST MODE	8
3.2	SPECIAL ACCESSORIES AND AUXILIARY EQUIPMENT	9
3.3	SUPPORT SOFTWARE	9
3.4	TEST SETUP DIAGRAM	9
4	TEST RESULTS	11
4.1	TRANSMITTER REQUIREMENT & TEST SUITES	11
4.1.1	<i>Antenna Requirement</i>	11
4.1.2	<i>Maximum peak conducted output power</i>	12
4.1.3	<i>6dB Bandwidth</i>	13
4.1.4	<i>Maximum conducted output power spectral density</i>	20
4.1.5	<i>Conducted Spurious Emission & Authorized-band band-edge</i>	27
4.1.6	<i>Radiated Emission</i>	50
4.1.7	<i>Band Edge (Restricted-band band-edge)</i>	51
4.2	MAINS EMISSIONS	52
4.2.1	<i>Conducted Emission on AC Mains</i>	52
5	APPENDIXES	55
5.1	PHOTOGRAPHS OF THE SAMPLE	55
5.2	SET-UP FOR CONDUCTED EMISSIONS	60
5.3	SET-UP FOR CONDUCTED RF TEST AT ANTENNA PORT	60
5.4	SET-UP FOR SPURIOUS EMISSIONS BELOW 1GHZ	61
5.5	SET-UP FOR SPURIOUS EMISSIONS ABOVE 1GHZ	61

TEST REPORT

Report No.: SHE23060104-02BE

Date: 2023-08-08

Page 3 of 61

1 General Information

1.1 Testing Laboratory

Company Name	ICAS Testing Technology Service (Shanghai) Co., Ltd.
Address	No.1298 Pingan Rd, Minhang District, Shanghai, China
Telephone	0086 21-51682999
Fax	0086 21-54711112
Homepage	www.icasiso.com

1.2 Details of Application

Applicant Company Name	SIMCom Wireless Solutions Limited
Address	SIMCom Headquarters Building, Building 3, No.289 Linhong Road, Changning District, Shanghai,China
Contact Person	Yongsheng Li
Telephone	+86 21 3252 3134
Email	yongsheng.li@simcom.com
Manufacturer Company Name	SIMCom Wireless Solutions Limited
Address	SIMCom Headquarters Building, Building 3, No.289 Linhong Road, Changning District, Shanghai,China
Factory Company Name	SIMCom Wireless Solutions Limited
Address	SIMCom Headquarters Building, Building 3, No.289 Linhong Road, Changning District, Shanghai,China

1.3 Details of EUT

Product Name	Wireless Data Module
Brand Name	SIMCom
Test Model Name	SIM8070
FCC ID	2AJYU-8XK0002
Mode of Operation	WLAN 802.11b/g/n(HT20/40)
RF Output Power	IEEE 802.11b: 15.41dBm IEEE 802.11g: 13.19dBm IEEE 802.11n(20): 13.27dBm IEEE 802.11n(40):12.48dBm
Frequency Range	2400MHz ~ 2483.5MHz
Channel Separation	5 MHz
Number of channels	11
Modulation Type	802.11b: DSSS(CCK, DQPSK, DBPSK) 802.11g/n(20M/40M): OFDM(64QAM, 16QAM, QPSK, BPSK)
Antenna Type	External Antenna

TEST REPORT

Report No.: SHE23060104-02BE

Date: 2023-08-08

Page 4 of 61

Antenna Gain	4.01dBi
Extreme Temperature Range	-30°C~ +75°C
Test Voltage	DC 3.8V
Hardware Version	SIM8970CE_V1.02
Software Version	SIM8070B01V01_A10
RF power setting in TEST SW	802.11b: QRCT_Power level setting_13dBm 802.11g: QRCT_Power level setting_13dBm 802.11n(HT20): QRCT_Power level setting_13dBm 802.11n(HT40): QRCT_Power level setting_12dBm

Note:

1. The above information was declared by the manufacture.
2. For more details, please refer to the User's manual of the EUT.

Channel List

Channel	Frequency	Channel	Frequency	Channel	Frequency
1	2.412GHz	5	2.432GHz	9	2.452GHz
2	2.417GHz	6	2.437GHz	10	2.457GHz
3	2.422GHz	7	2.442GHz	11	2.462GHz
4	2.427GHz	8	2.447GHz		

Note:

For 20MHz bandwidth system use Channel 1 to Channel 11

For 40MHz bandwidth system use Channel 3 to Channel 9

1.4 Test Methodology

47 CFR Part 15, Subpart C	Telecommunication-Radio Frequency Devices-Intentional Radiators
KDB Publication 558074 D01 v05r02	15.247 Meas Guidance.
ANSI C63.10-2013	American National Standard for Testing Unlicensed Wireless Devices

Note(s):

All test items were verified and recorded according to the standards and without any addition/deviation/exclusion during the test.

TEST REPORT

Report No.: SHE23060104-02BE

Date: 2023-08-08

Page 5 of 61

1.5 Test Summary

Test Item	FCC Rules	Result
Antenna Requirement	FCC Part 15.247(b)(4), Part 15.203	PASS
Maximum peak conducted output power	FCC Part 15.247(b)(3)	PASS
6dB Bandwidth	FCC Part 15.247(a)(2)	PASS
Maximum conducted output power spectral density	FCC Part 15.247(e)	PASS
Conducted Spurious Emission & Authorized-band band-edge	FCC Part 15.247(d)	PASS
Radiated Emission	FCC Part 15.247(d), 15.205, 15.209	PASS
Band Edge (Restricted-band band-edge)	FCC Part 15.247(d), 15.205, 15.209	PASS
Conducted Emission on AC Mains	FCC Part 15.207(a)	PASS

TEST REPORT

Report No.: SHE23060104-02BE

Date: 2023-08-08

Page 6 of 61

2 Test Condition

2.1 Environmental conditions

Temperature (°C)	18-25
Humidity (%RH)	40-65
Barometric Pressure (mbar)	960-1060

2.2 Equipment List

Name of Equipment	Manufacturer	Model	Serial No.	Cal. Date	Cal. Due Date
Spectrum Analyzer	Keysight	N9020B	MY59260184	2022-08-02	2023-08-01
Spectrum Analyzer	Rohde & Schwarz	FSV40N	101450	2023-06-08	2024-06-07
Signal Generator	Rohde & Schwarz	SMR27	100184	2022-08-02	2023-08-01
EMI Test Receiver	Rohde & Schwarz	ESPI3	100173	2023-06-08	2024-06-07
EMI Test Receiver	Rohde & Schwarz	ESR 7	101911	2023-06-08	2024-06-07
V-network	SCHWARZBECK	NSLK 8127	8127-902	2023-06-07	2024-06-06
Attenuator	SCHWARZBECK	VTSD 9561-FN	/	2023-06-06	2024-06-05
Broadband Antenna	SCHWARZBECK	VULB9163	9163-1037	2023-03-22	2025-03-21
Horn Antenna-18G	SCHWARZBECK	BBHA9120D	9120D-1775	2023-06-13	2025-06-12
Loop Antenna	SCHWARZBECK	FMZB 1513	N/A	2023-06-09	2024-06-08
Horn Antenna-40G	YINGLIAN	LB-180400-KF	N/A	2023-06-18	2025-06-17
Broadband Preamplifier	SCHWARZBECK	BBV 9718	346	2023-06-08	2024-06-07
EMC chamber 9*6*6(L*W*H)	CHANGNING	966	N/A	2023-06-09	2024-06-08
Shielded Enclosure 8*5*4 (L*W*H)	CHANGNING	854	N/A	2023-06-09	2025-06-08
Test Software	BL	BL410_E	Version:1.0.0.117	N/A	N/A
Test Software	BL	BL410_R	Version:2.1.1.409	N/A	N/A

Equipment Calibration Date Updated:

Name of Equipment	Manufacturer	Model	Serial No.	Cal. Date	Cal. Due
Spectrum Analyzer	Keysight	N9020B	MY59260184	2023-07-27	2024-07-26
Signal Generator	Rohde & Schwarz	SMR27	100184	2023-07-27	2024-07-26

TEST REPORT

Report No.: SHE23060104-02BE

Date: 2023-08-08

Page 7 of 61

2.3 Measurement Uncertainty

The uncertainty is calculated using the methods suggested in the "Guide to the Expression of Uncertainty in measurement" (GUM) published by CISPR and ANSI. The reported uncertainty of measurement $y \pm U$, where expanded uncertainty U is based on a standard uncertainty multiplied by a coverage factor of $k=2$, providing a level of confidence of approximately 95.45%.

Parameter		Uncertainty
Antenna Port Conducted Emission	< 1GHz	± 1.5 dB
	> 1GHz	± 1.5 dB
Radiated Emission	9KHz – 30MHz	± 3.42 dB
	30 MHz – 1GHz	± 5.00 dB
	> 1GHz	± 4.88 dB
Conducted Emission on AC Mains	150kHz-30MHz	± 2.68 dB
Occupied Channel Bandwidth		± 5 %
RF output power		± 0.65 dB
PSD		± 0.60 dB

TEST REPORT

Report No.: SHE23060104-02BE

Date: 2023-08-08

Page 8 of 61

3 Test Set-up and Operation Modes

3.1 Details of Test Mode

Using test software (Linux operation Command) was control EUT work in continuous transmitter and receiver mode.
Select test channel as below:

For 802.11b/g/n (HT20)

Channel	Frequency
The lowest channel (CH1)	2412MHz
The middle channel (CH6)	2437MHz
The highest channel (CH11)	2462MHz

For 802.11n(HT40)

Channel	Frequency
The lowest channel (CH3)	2422MHz
The middle channel (CH6)	2437MHz
The highest channel (CH9)	2452MHz

Through Pre-scan under all rate at lowest channel, the data rate as below table described is the worst case, so we choose these data rate for test.

Type	Data rate
802.11b	11Mbps
802.11g	48Mbps
802.11n(20M)	MCS6
802.11n(40M)	MCS6

The basic operation modes are:

- A. On
 - 1. WLAN mode
 - a. Transmitting
 - i. Low Channel
 - ii. Middle Channel
 - iii. High Channel
 - b. Receiving
- B. Standby
- C. Off

TEST REPORT

Report No.: SHE23060104-02BE

Date: 2023-08-08

Page 9 of 61

3.2 Special Accessories and Auxiliary Equipment

Description	Manufacturer	Model Name	Serial No.
Laptop	Lenovo	TP00083A	N/A
SWITCHING POWER SUPPLY	N/A	P-050B-050200EU	N/A
EVB Debug Board 1	N/A	8PYA00-SIMCOM-EVB_V1.02	N/A
EVB Debug Board 2	N/A	8XK000-SIM8970-EVB I	N/A
USB Cable	N/A	N/A	1.00m Unshielded

3.3 Support Software

Description	Manufacturer	Software Name
Software	Qualcomm	QRCT Version 4.0.00166.0

3.4 Test Setup Diagram

Diagram of Measurement Configuration for Radiation Test

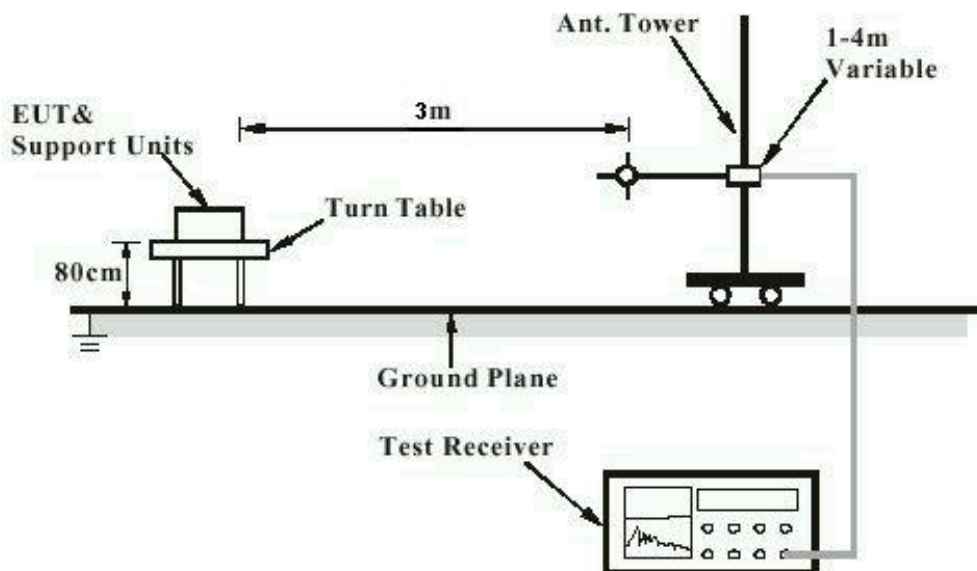

Note: Measurements above 1GHz are done with a table height of 1.5m. In addition, there is RF absorbing material on the floor of the test site for above 1GHz measurement.

TEST REPORT

Report No.: SHE23060104-02BE

Date: 2023-08-08

Page 10 of 61

Diagram of Measurement Equipment Configuration for Conduction Measurement

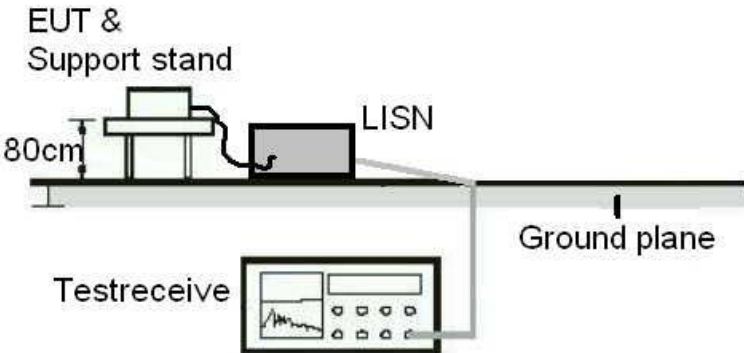
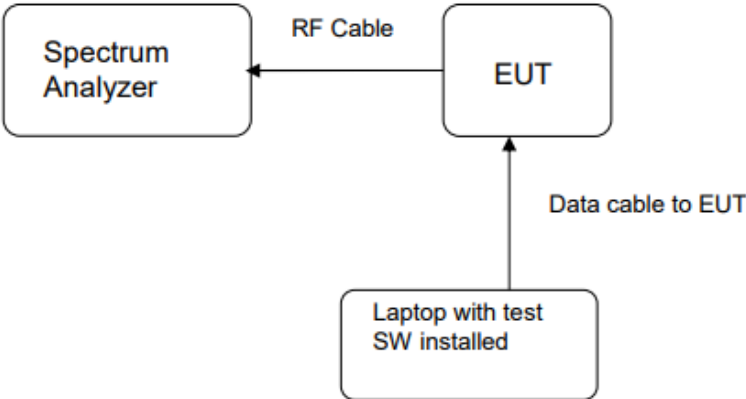

Diagram of Measurement Equipment Configuration for Transmitter Measurement



TEST REPORT

Report No.: SHE23060104-02BE

Date: 2023-08-08

Page 11 of 61

4 Test Results

4.1 Transmitter Requirement & Test Suites

4.1.1 Antenna Requirement

RESULT:

PASS

Test standard : FCC Part 15.247(b)(4), Part 15.203

Requirement : The use of approved antennas only with directional gains that do not exceed 6dBi

According to the manufacturer declaration, the EUT has an antenna with a directional gain of 4.01dBi. The antenna is an external antenna with no possibility of replacement with a non-approved antenna by the end-user.

The manufacturer may design the unit so that a broken antenna can be replaced by the user, but the use of a standard antenna jack or electrical connector is prohibited.

Therefore, the EUT is considered to comply with this provision.

TEST REPORT

Report No.: SHE23060104-02BE

Date: 2023-08-08

Page 12 of 61

4.1.2 Maximum peak conducted output power

RESULT:

PASS

Test standard : FCC Part 15.247(b)(3)
Requirement : ANSI C63.10-2013, Clause 11.9.1
KDB 558074 D01 v05r02, Clause 8.3.1
Kind of test site : Shielded room

Test setup

Test Channel : Low/Middle/High
Operation Mode : A.1.a
Ambient temperature : 23.8°C
Relative humidity : 46%

Table 1: Maximum peak conducted output power

Test Mode	Test Channel (MHz)	Maximum peak conducted output power		Limit (W)
		(dBm)	(mW)	
802.11b	2412	15.41	34.75	≤1
	2437	14.10	25.70	
	2462	14.61	28.91	
802.11g	2412	13.19	20.84	
	2437	12.60	18.20	
	2462	12.69	18.58	
802.11n(HT20)	2412	13.27	21.23	
	2437	12.79	19.01	
	2462	12.85	19.28	
802.11n(HT40)	2422	12.44	17.54	
	2437	12.48	17.70	
	2452	11.40	13.80	

TEST REPORT

Report No.: SHE23060104-02BE

Date: 2023-08-08

Page 13 of 61

4.1.3 6dB Bandwidth

RESULT:

PASS

Test standard : FCC Part 15.247(a)(2)
Requirement : ANSI C63.10-2013, Clause 11.8.1
KDB 558074 D01 v05r02, Clause 8.2
Kind of test site : Shielded room

Test setup

Test Channel : Low/Middle/High
Operation Mode : A.1.a
Ambient temperature : 23.8°C
Relative humidity : 46%

Table 2: 6dB Bandwidth

Test Mode	Test Channel (MHz)	6dB Bandwidth (MHz)	Limit (MHz)
802.11b	2412	8.83	≥0.5
	2437	7.36	
	2462	8.84	
802.11g	2412	16.38	
	2437	16.48	
	2462	16.27	
802.11n(HT20)	2412	17.60	
	2437	17.73	
	2462	17.51	
802.11n(HT40)	2422	35.79	
	2437	36.34	
	2452	35.39	

TEST REPORT

Report No.: SHE23060104-02BE

Date: 2023-08-08

Page 14 of 61

Figure 1: 6dB Bandwidth, 802.11b, 2412MHz



Figure 2: 6dB Bandwidth, 802.11b, 2437MHz

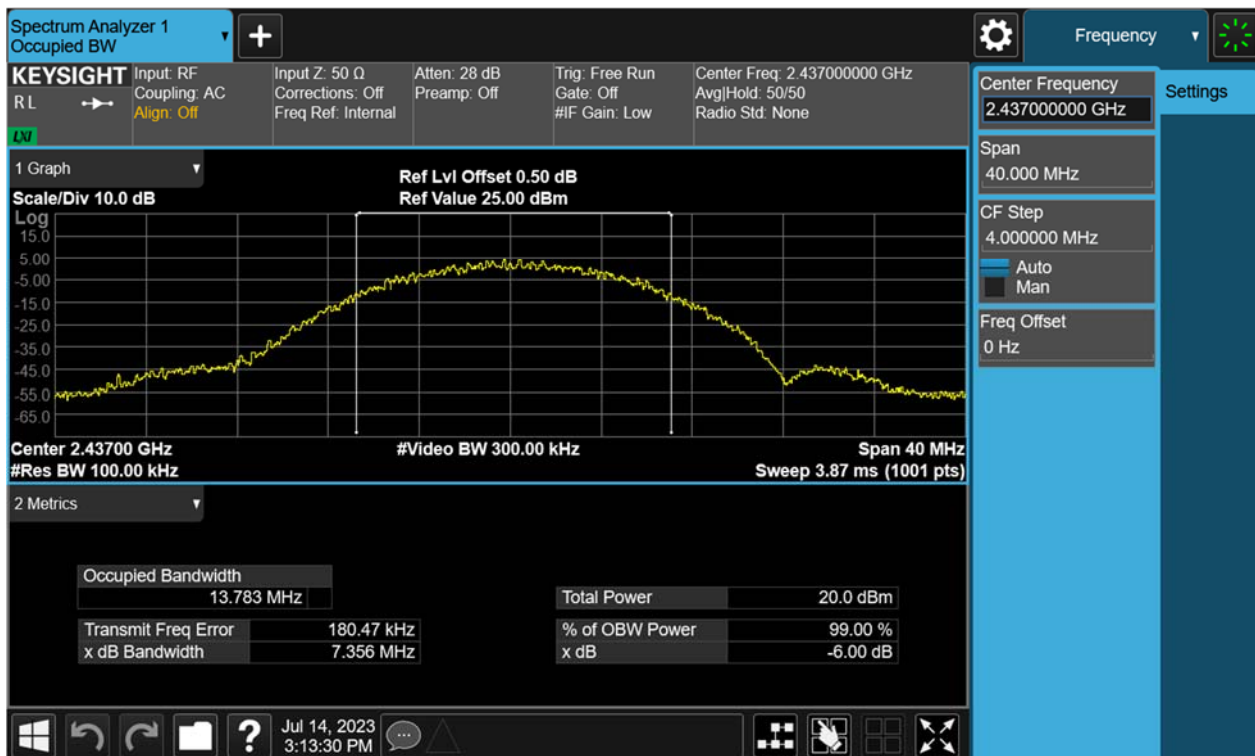

TEST REPORT

Report No.: SHE23060104-02BE

Date: 2023-08-08

Page 15 of 61

Figure 3: 6dB Bandwidth, 802.11b, 2462MHz



Figure 4: 6dB Bandwidth, 802.11g, 2412MHz

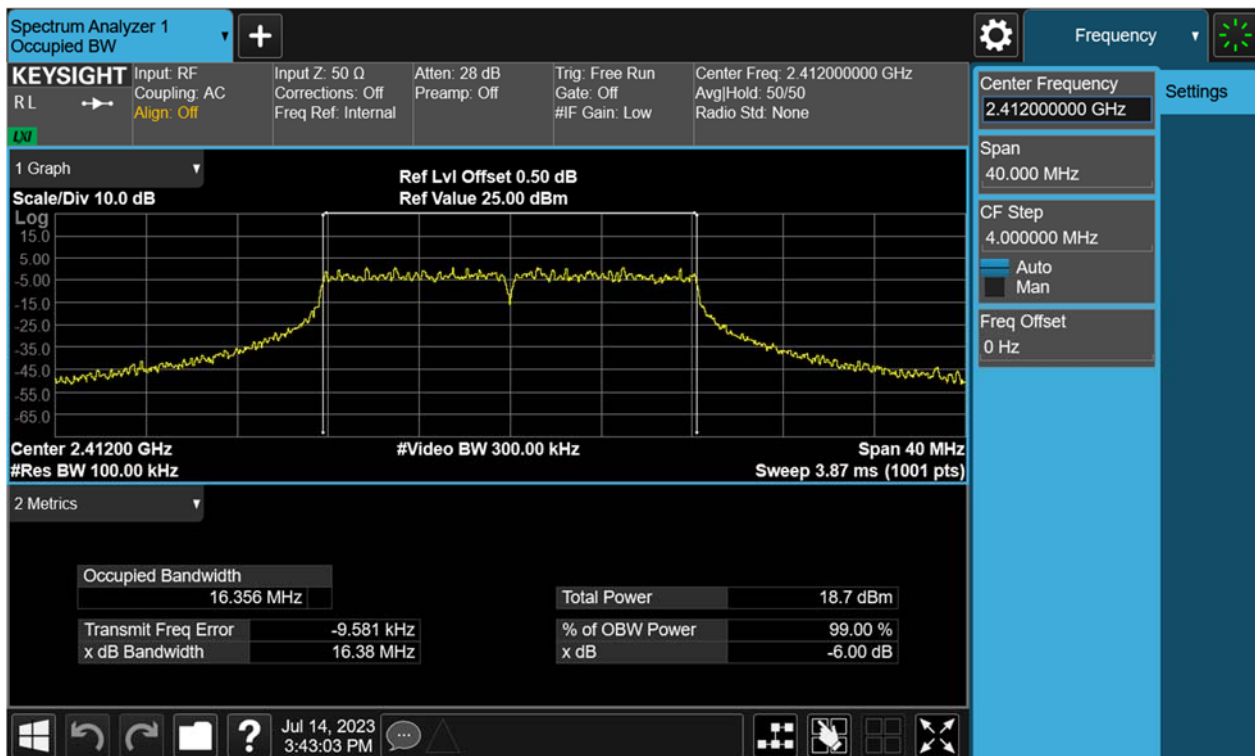

TEST REPORT

Report No.: SHE23060104-02BE

Date: 2023-08-08

Page 16 of 61

Figure 5: 6dB Bandwidth, 802.11g, 2437MHz

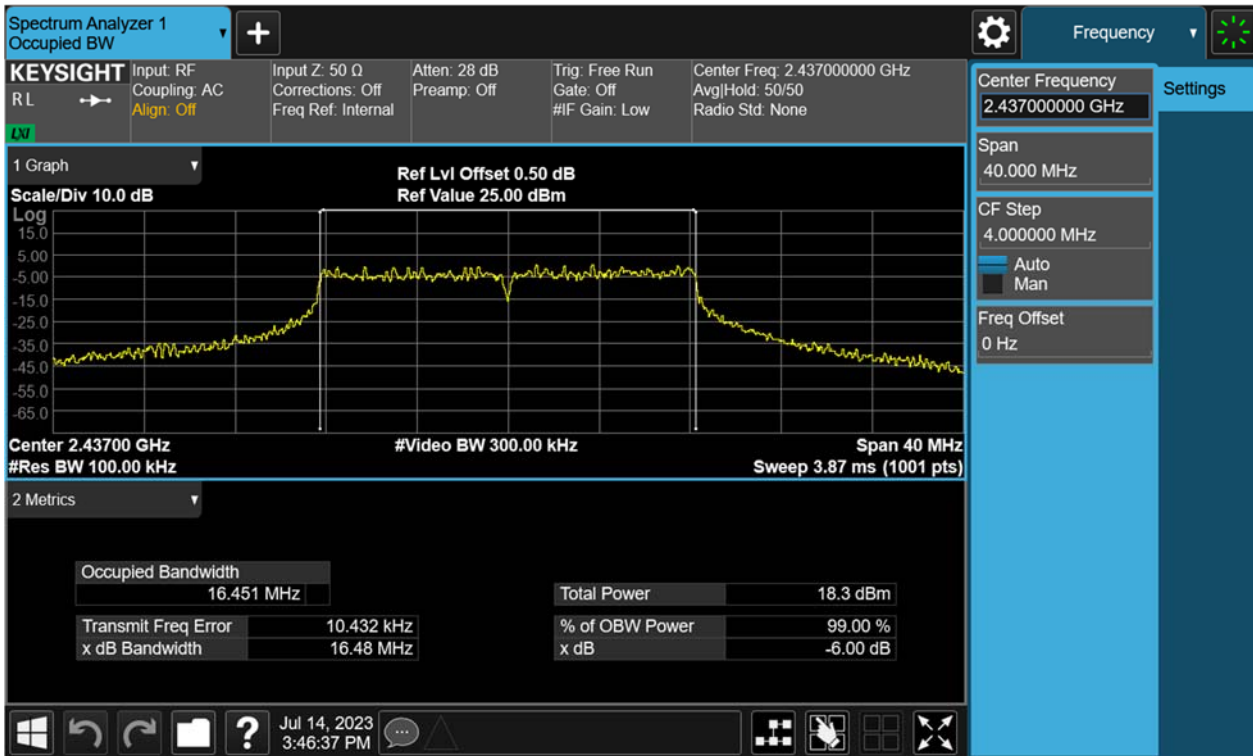
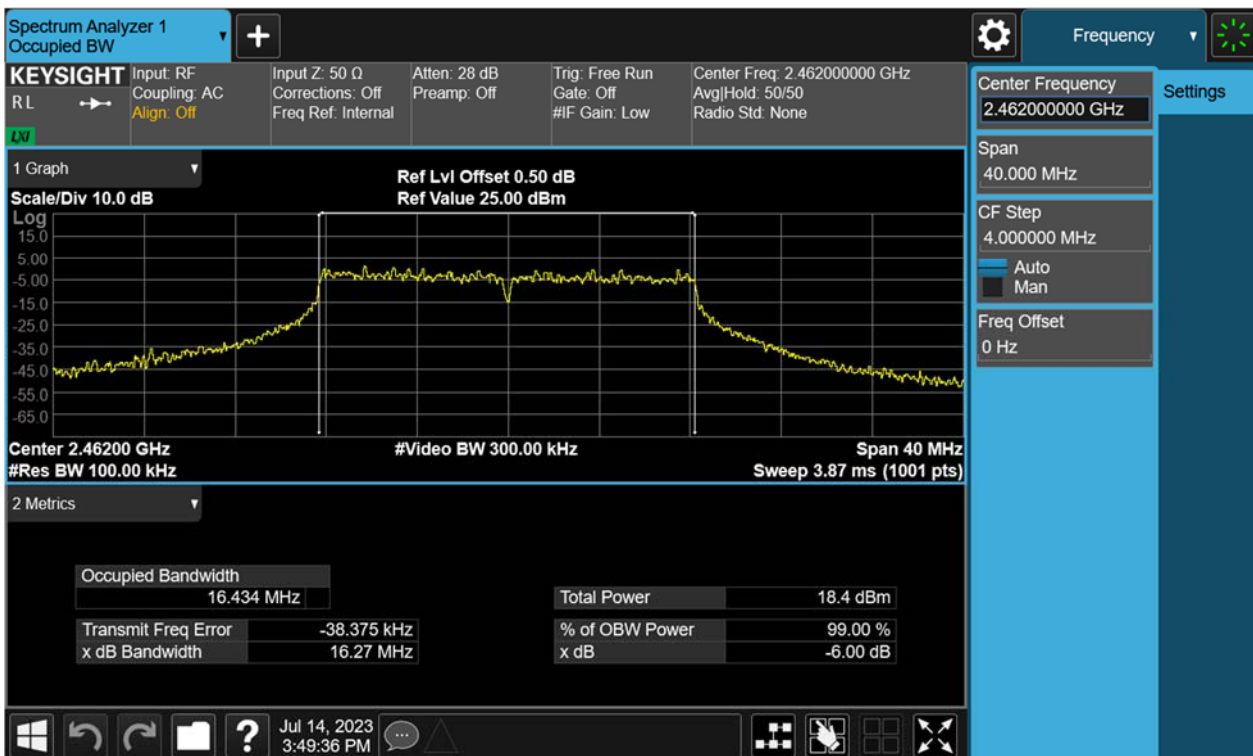

Figure 6: 6dB Bandwidth, 802.11g, 2462MHz



TEST REPORT

Report No.: SHE23060104-02BE

Date: 2023-08-08

Page 17 of 61

Figure 7: 6dB Bandwidth, 802.11n(HT20), 2412MHz

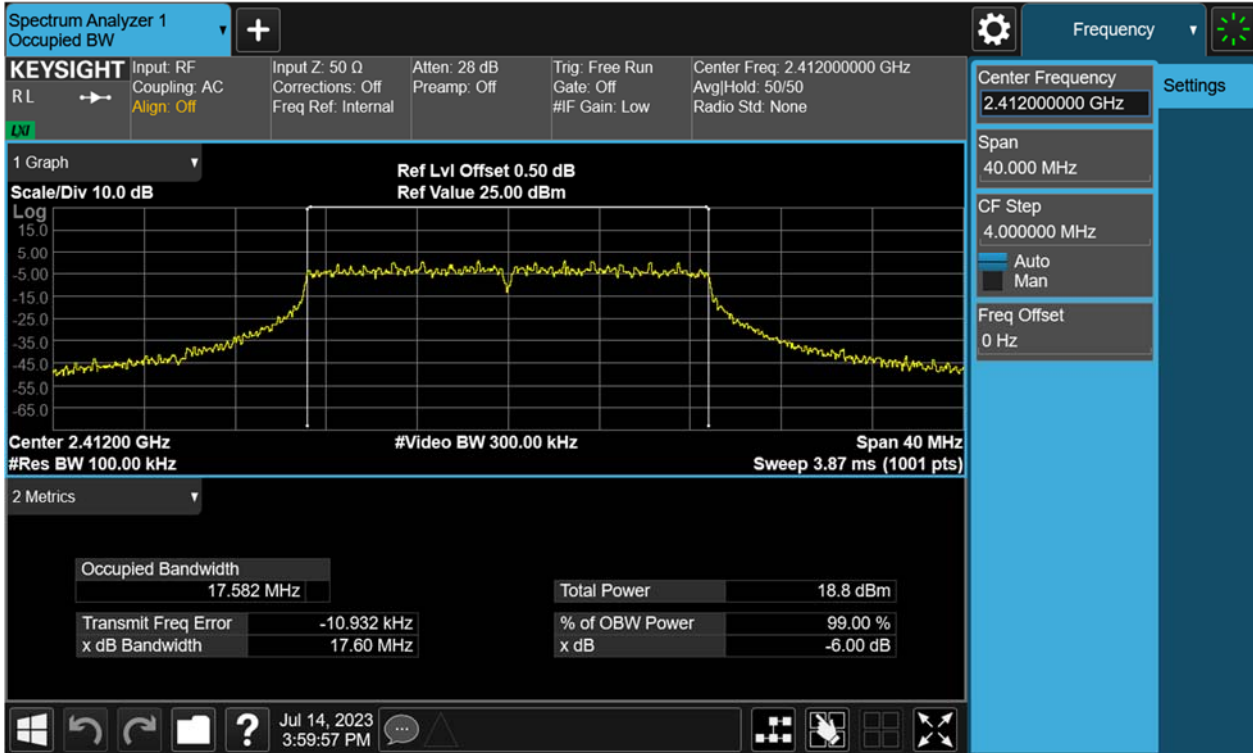
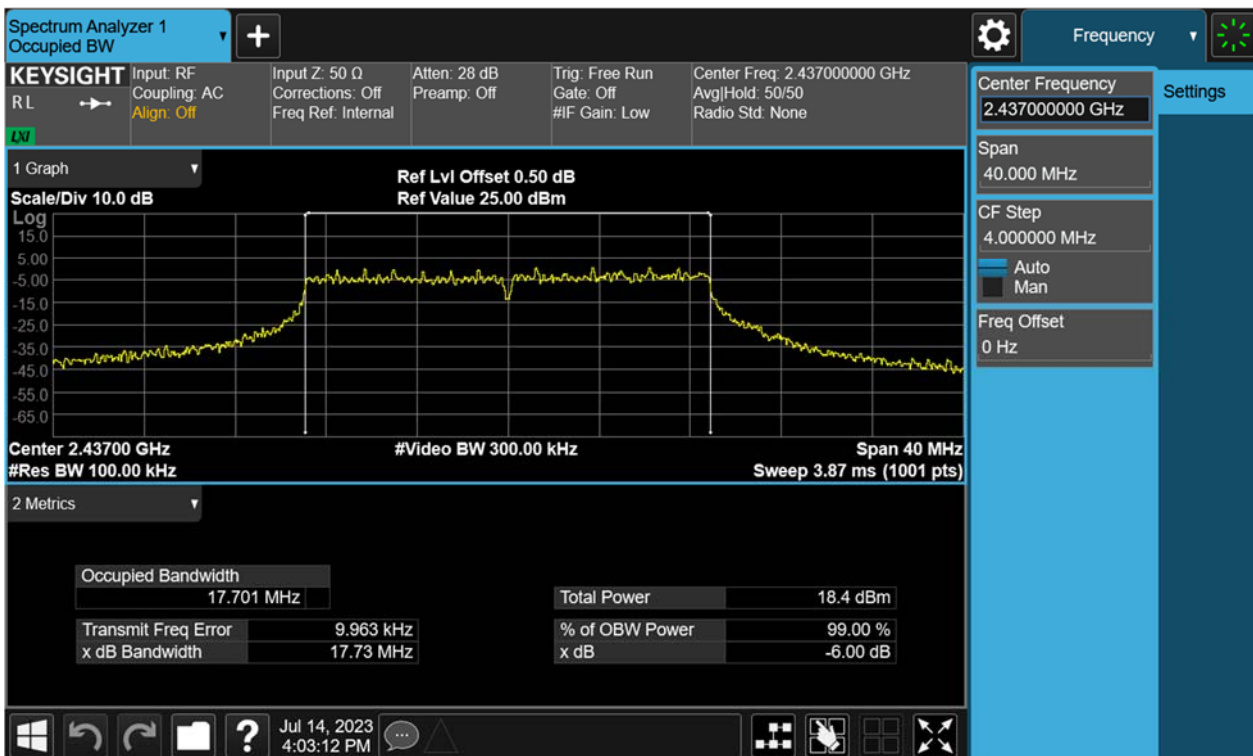

Figure 8: 6dB Bandwidth, 802.11n(HT20), 2437MHz



TEST REPORT

Report No.: SHE23060104-02BE

Date: 2023-08-08

Page 18 of 61

Figure 9: 6dB Bandwidth, 802.11n(HT20), 2462MHz

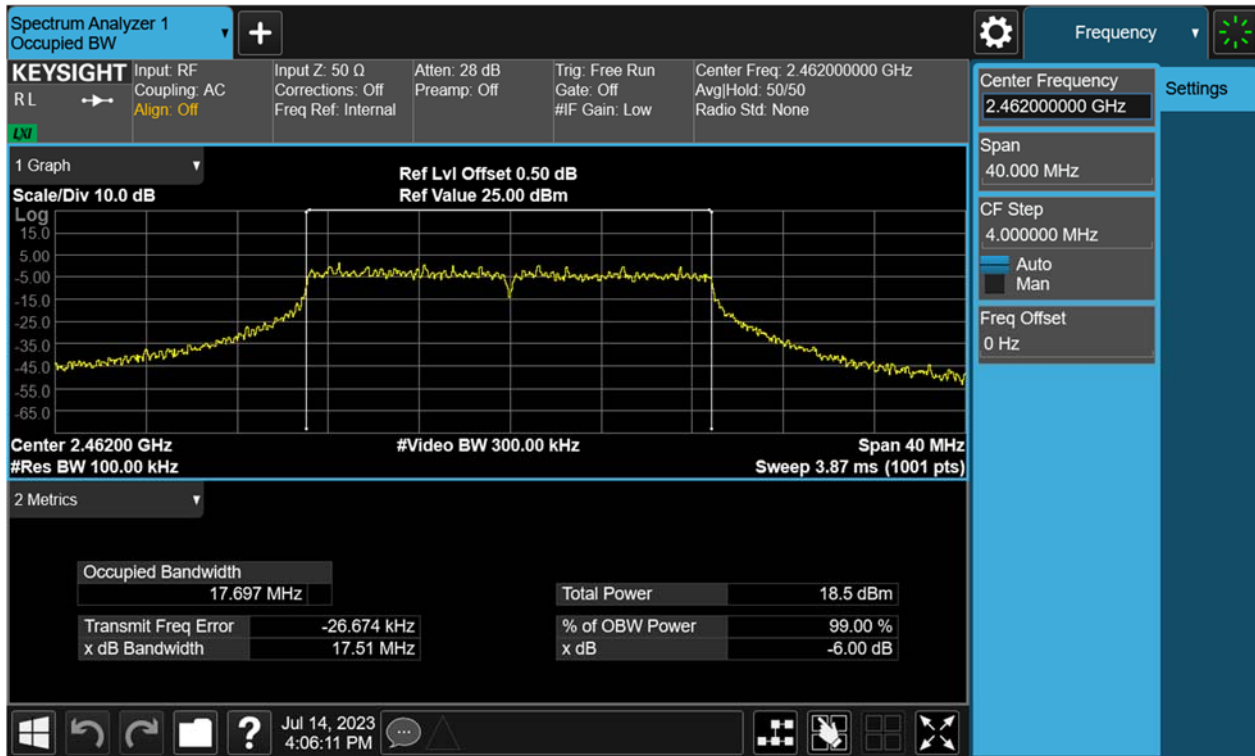
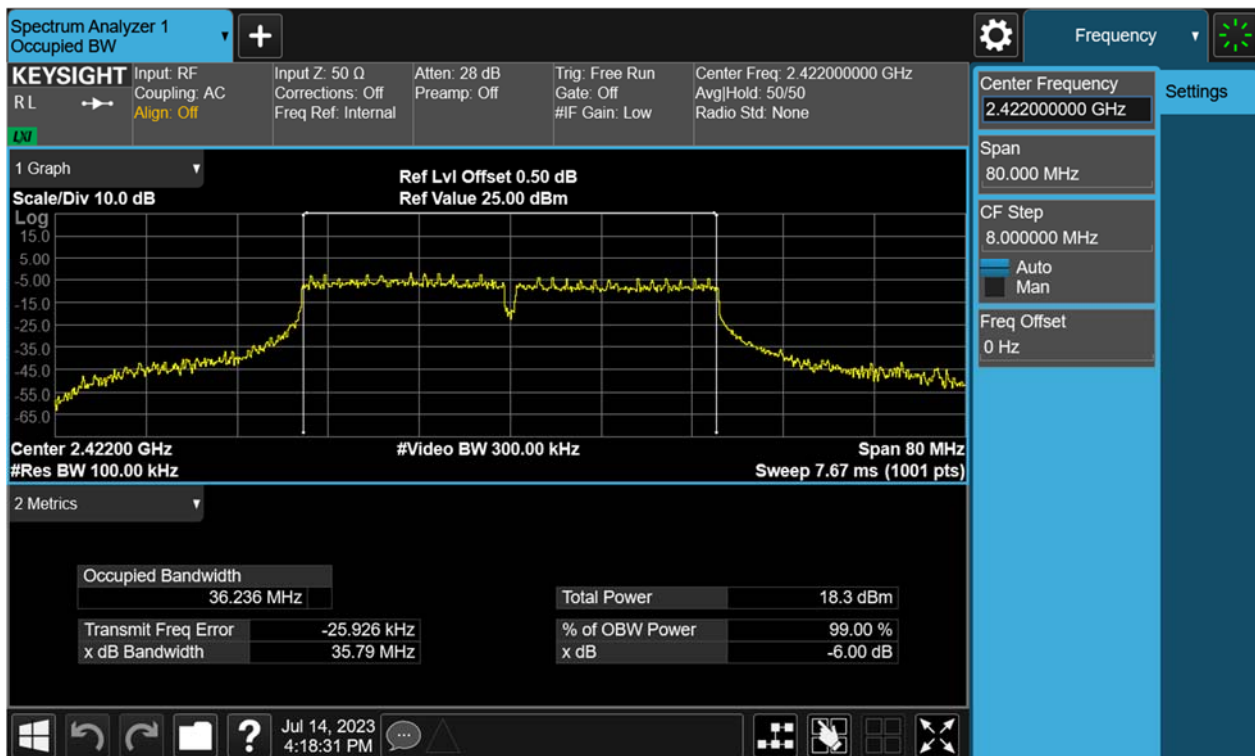

Figure 10: 6dB Bandwidth, 802.11n(HT40), 2422MHz



TEST REPORT

Report No.: SHE23060104-02BE

Date: 2023-08-08

Page 19 of 61

Figure 11: 6dB Bandwidth, 802.11n(HT40), 2437MHz

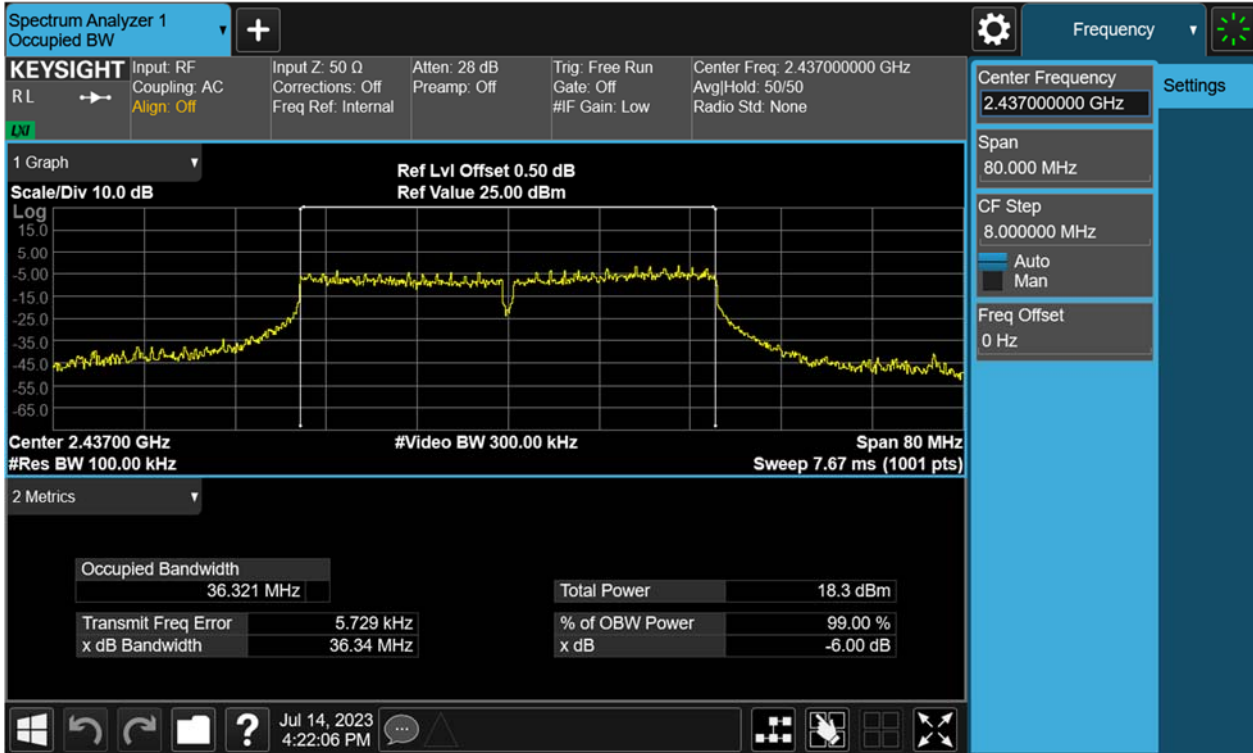
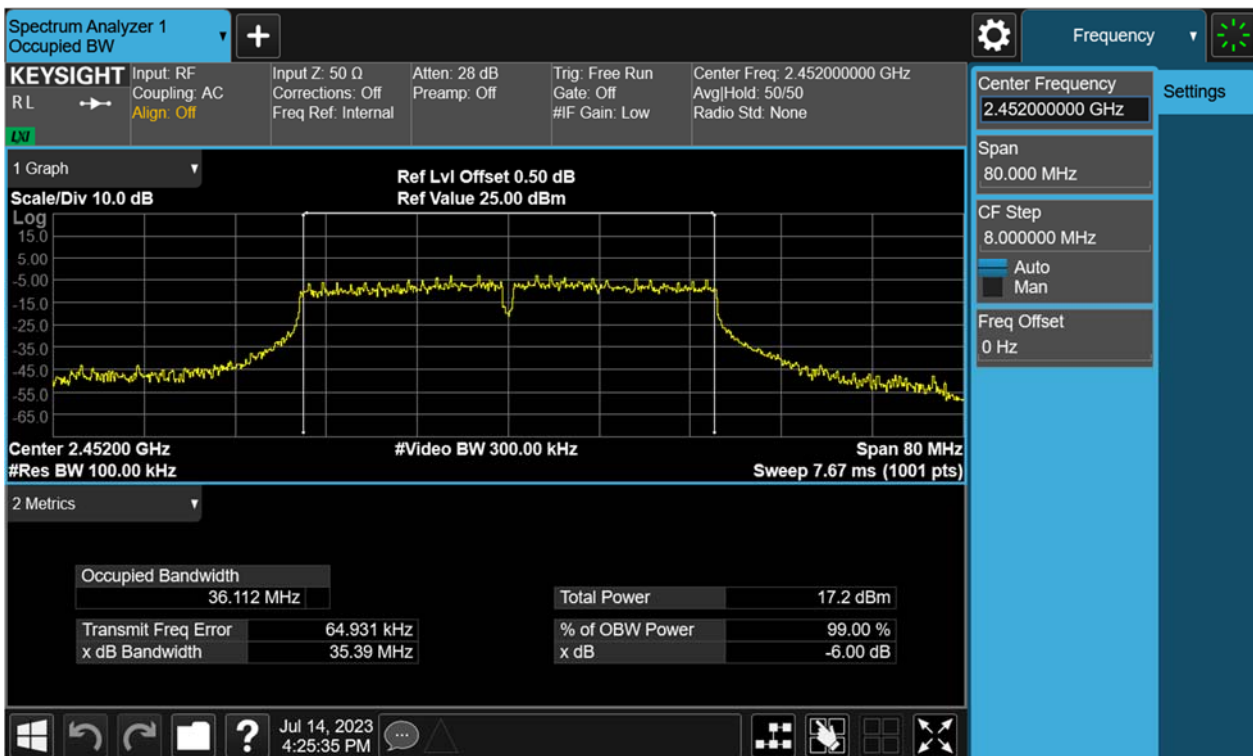

Figure 12: 6dB Bandwidth, 802.11n(HT40), 2452MHz



TEST REPORT

Report No.: SHE23060104-02BE

Date: 2023-08-08

Page 20 of 61

4.1.4 Maximum conducted output power spectral density

RESULT:

PASS

Test standard : FCC Part 15.247(e)
Requirement : ANSI C63.10-2013, Clause 11.10.2
KDB 558074 D01 v05r02, Clause 8.4
Kind of test site : Shielded room

Test setup

Test Channel : Low/Middle/High
Operation Mode : A.1.a
Ambient temperature : 23.8°C
Relative humidity : 46%

Table 3: Maximum peak conducted output power

Test Mode	Test Channel (MHz)	Maximum peak conducted output power (dBm/3kHz)	Limit (dBm/3kHz)
802.11b	2412	-8.62	≤8
	2437	-10.25	
	2462	-9.48	
802.11g	2412	-14.01	
	2437	-13.45	
	2462	-13.62	
802.11n(HT20)	2412	-13.56	
	2437	-13.67	
	2462	-14.03	
802.11n(HT40)	2422	-15.92	
	2437	-16.03	
	2452	-18.05	

TEST REPORT

Report No.: SHE23060104-02BE

Date: 2023-08-08

Page 21 of 61

Figure 13: Power Spectral Density, 802.11b, 2412MHz

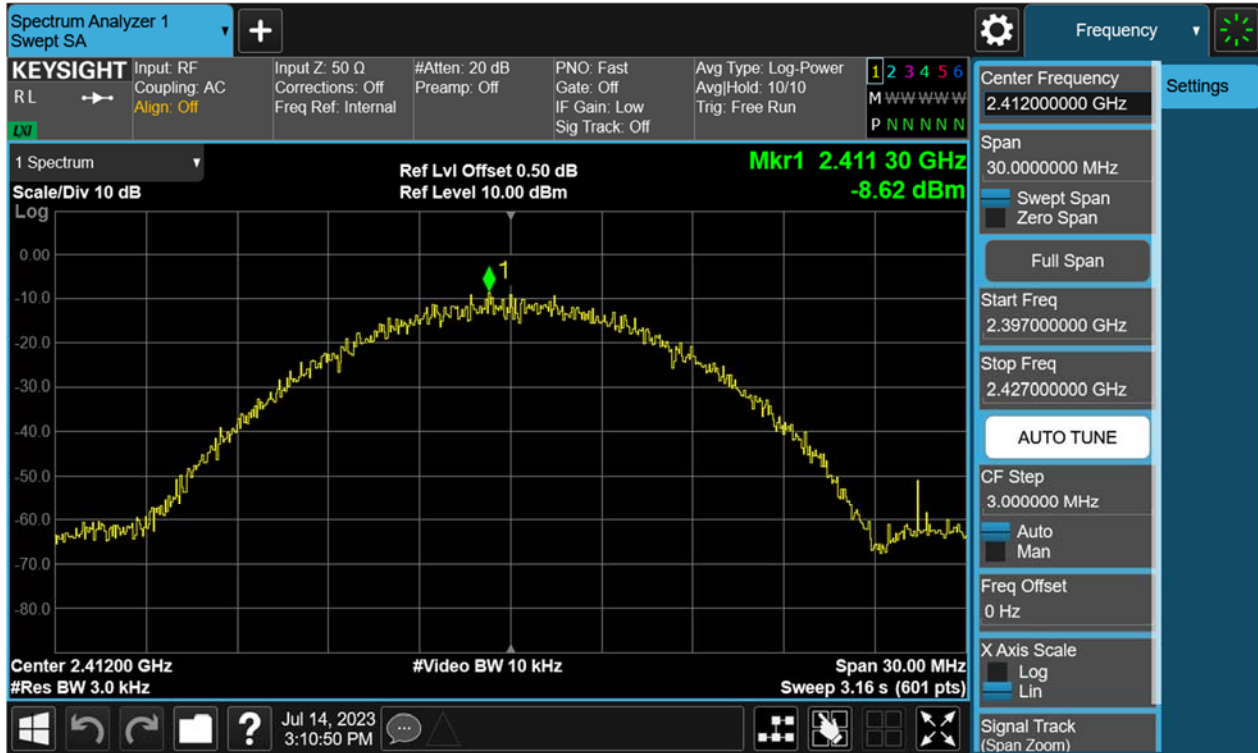
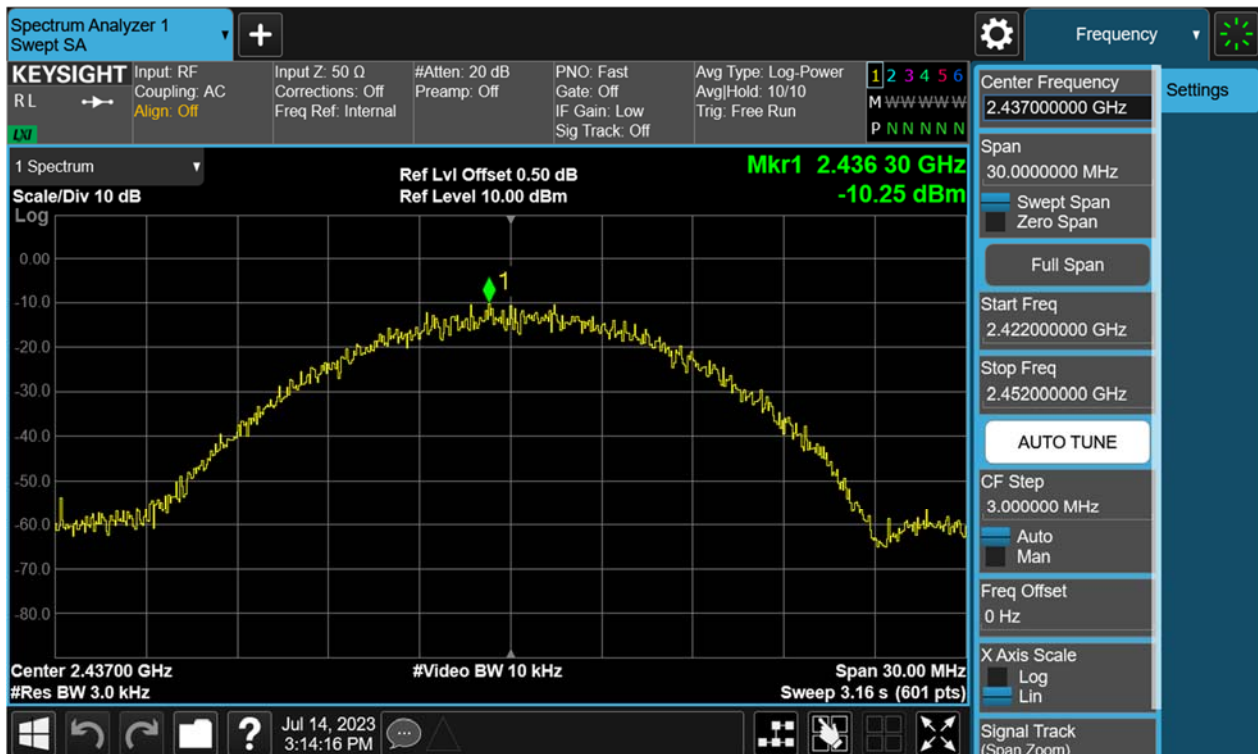

Figure 14: Power Spectral Density, 802.11b, 2437MHz



TEST REPORT

Report No.: SHE23060104-02BE

Date: 2023-08-08

Page 22 of 61

Figure 15: Power Spectral Density, 802.11b, 2462MHz

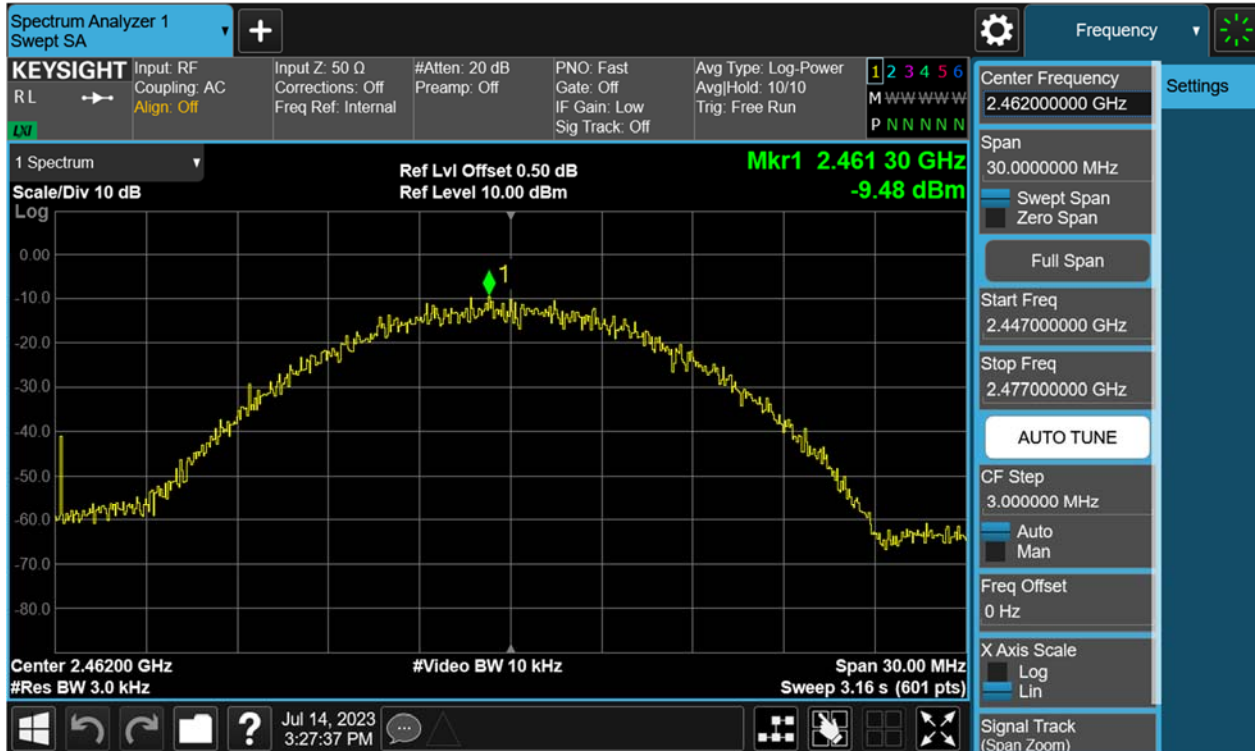
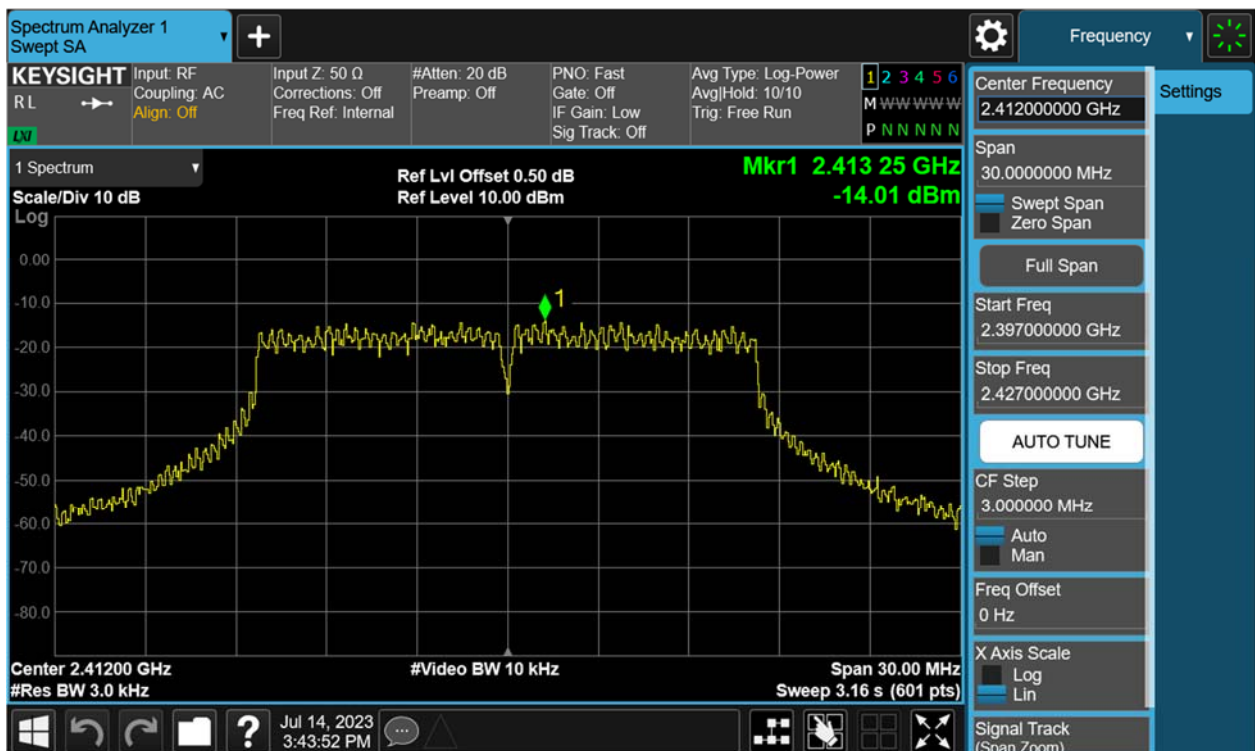

Figure 16: Power Spectral Density, 802.11g, 2412MHz



TEST REPORT

Report No.: SHE23060104-02BE

Date: 2023-08-08

Page 23 of 61

Figure 17: Power Spectral Density, 802.11g, 2437MHz

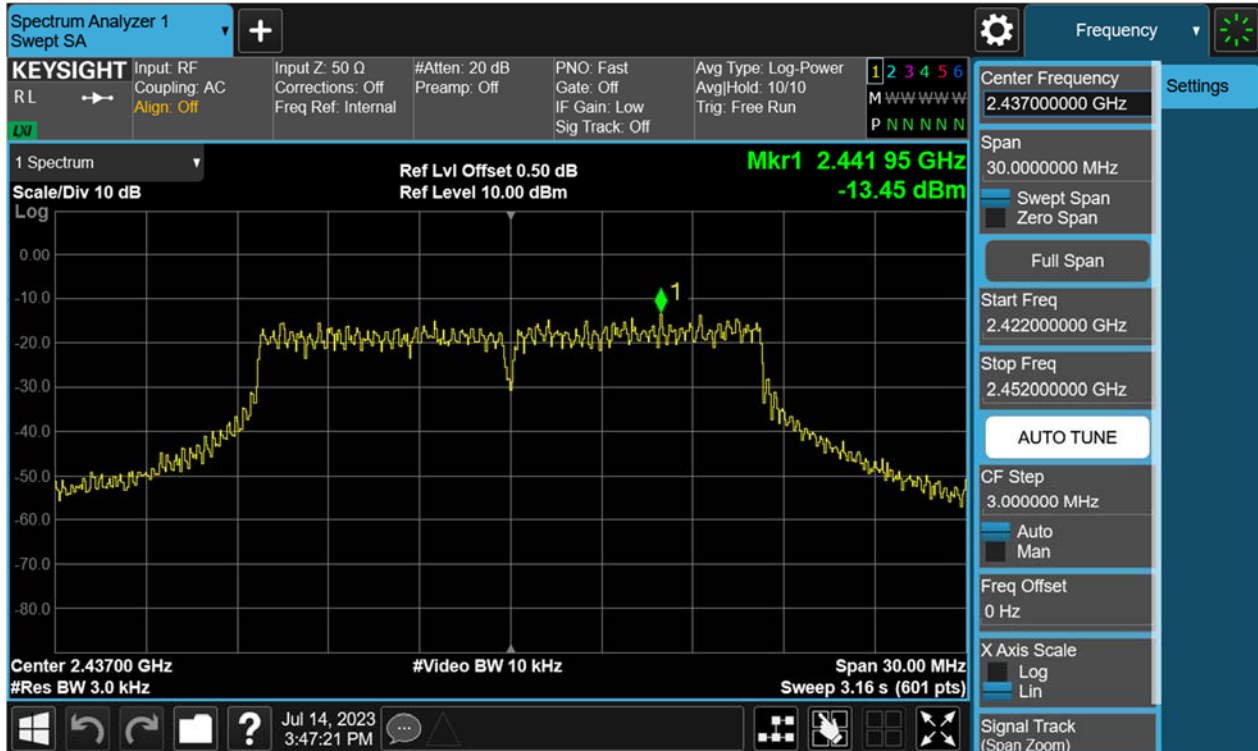
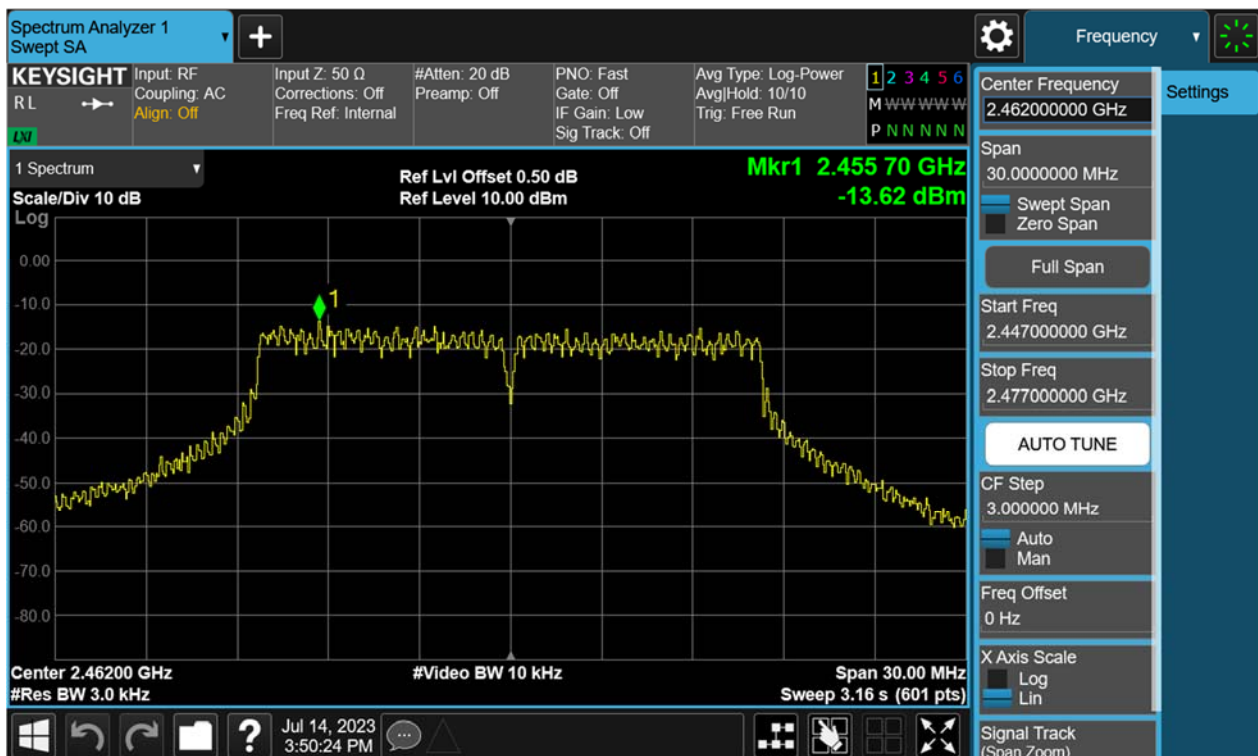

Figure 18: Power Spectral Density, 802.11g, 2462MHz



TEST REPORT

Report No.: SHE23060104-02BE

Date: 2023-08-08

Page 24 of 61

Figure 19: Power Spectral Density, 802.11n(HT20), 2412MHz

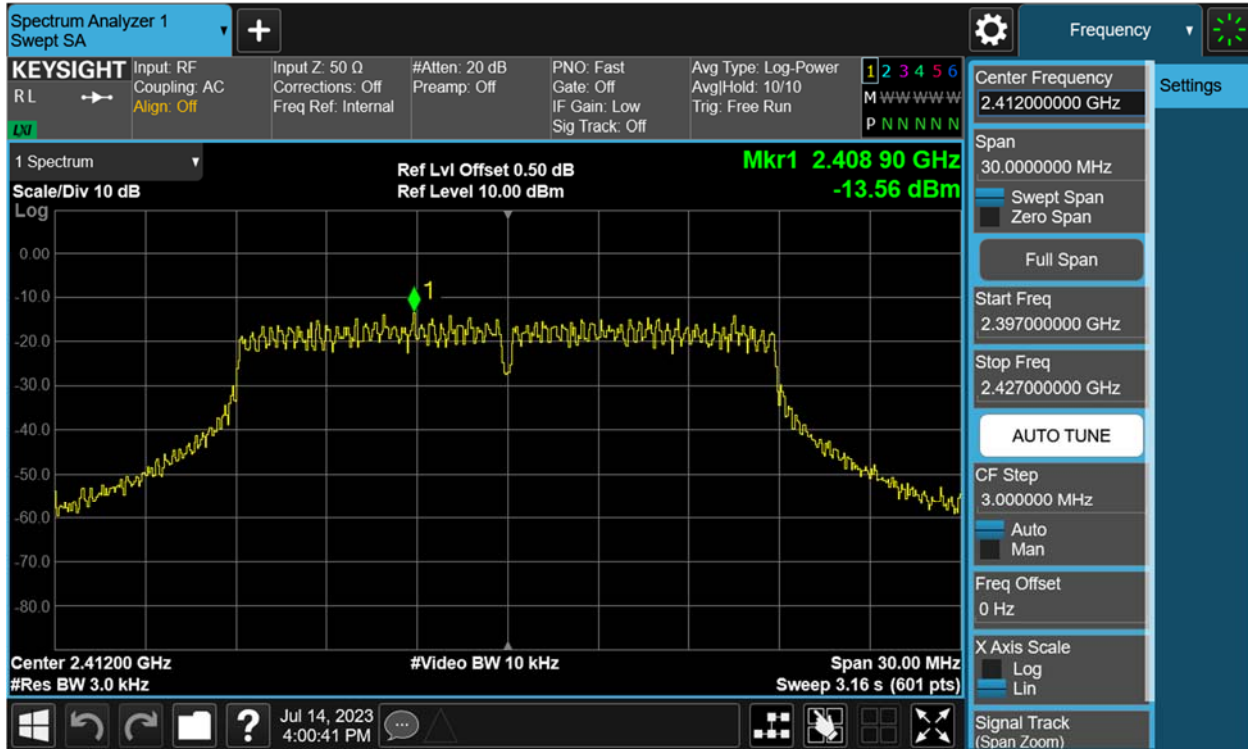
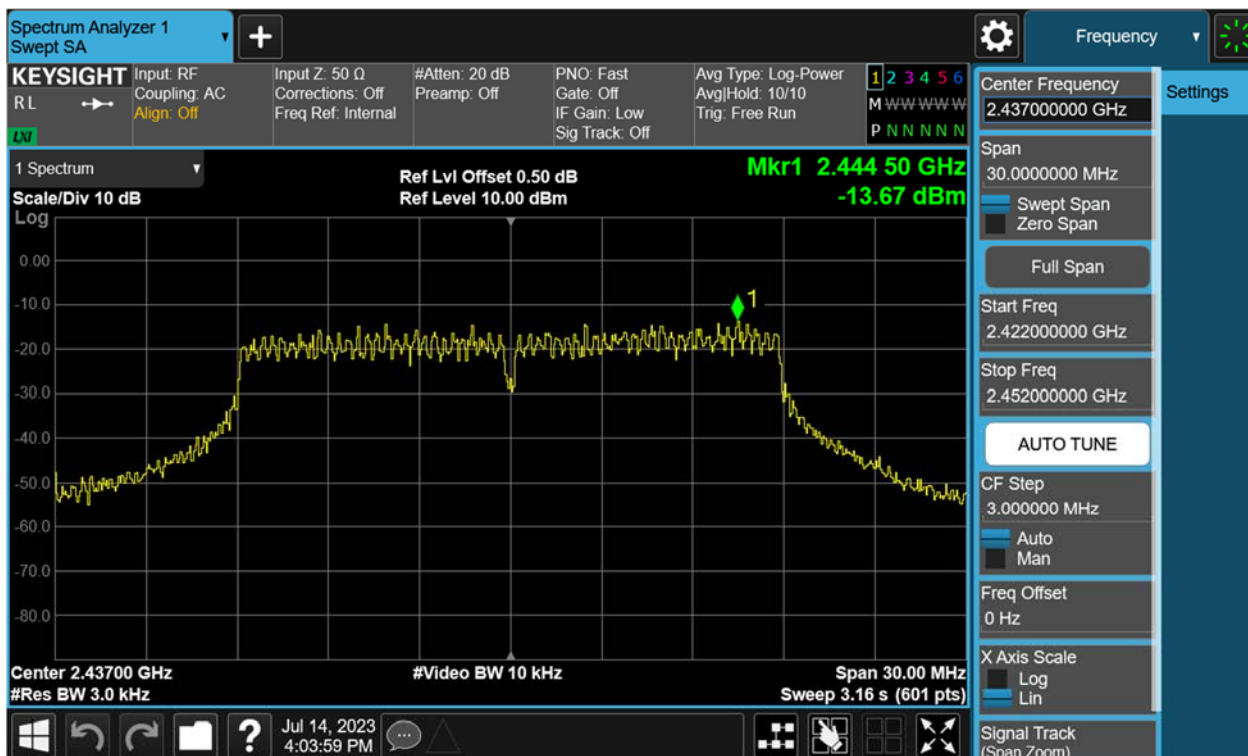

Figure 20: Power Spectral Density, 802.11n(HT20), 2437MHz



TEST REPORT

Report No.: SHE23060104-02BE

Date: 2023-08-08

Page 25 of 61

Figure 21: Power Spectral Density, 802.11n(HT20), 2462MHz

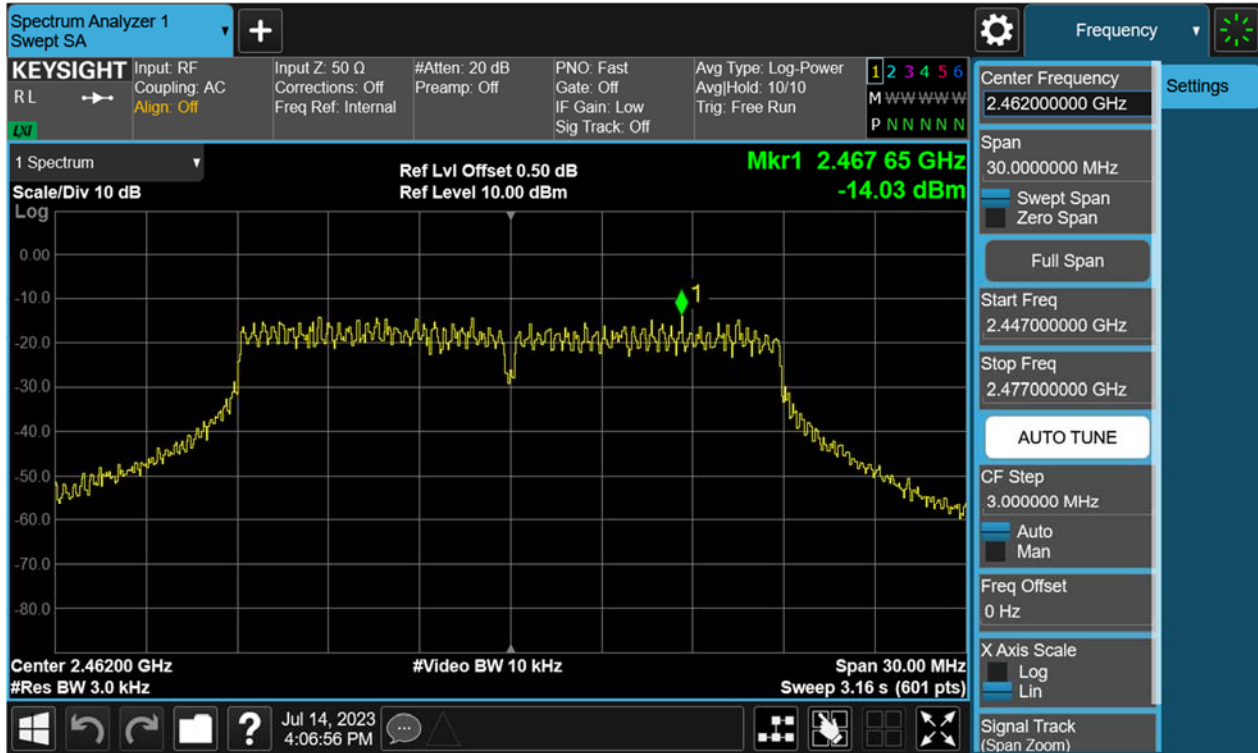
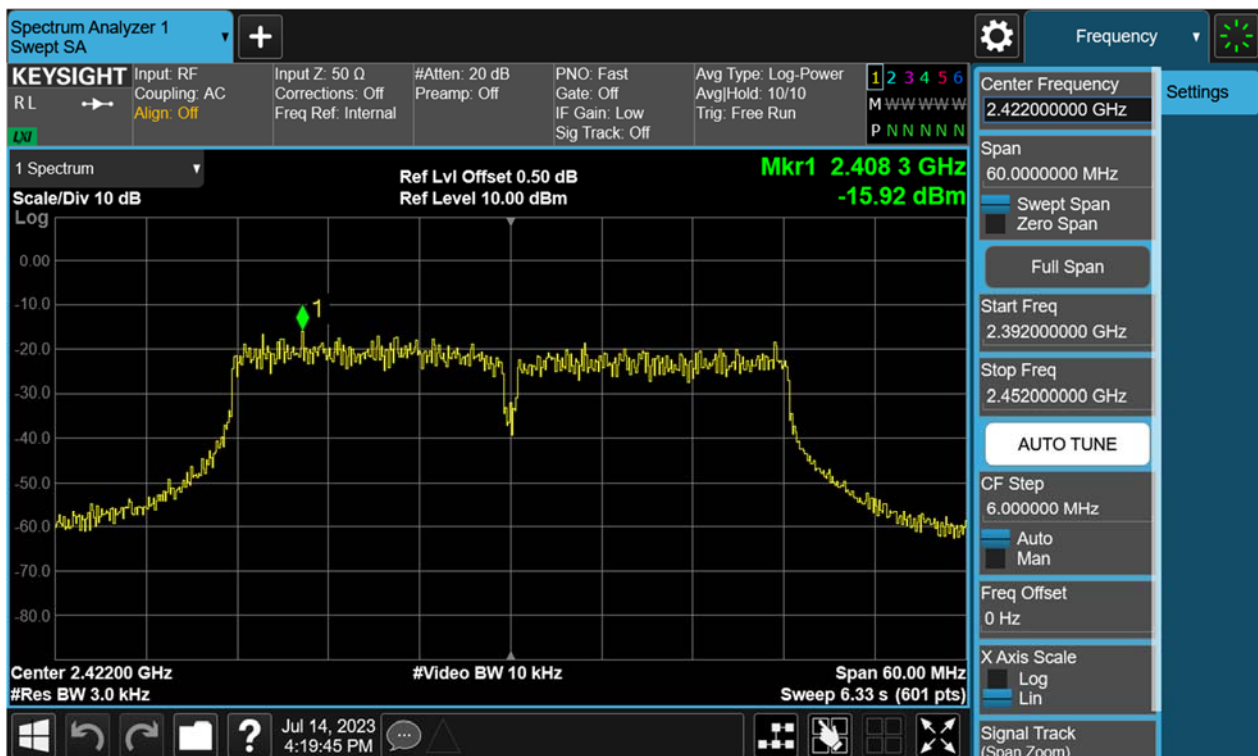

Figure 22: Power Spectral Density, 802.11n(HT40), 2422MHz



TEST REPORT

Report No.: SHE23060104-02BE

Date: 2023-08-08

Page 26 of 61

Figure 23: Power Spectral Density, 802.11n(HT40), 2437MHz

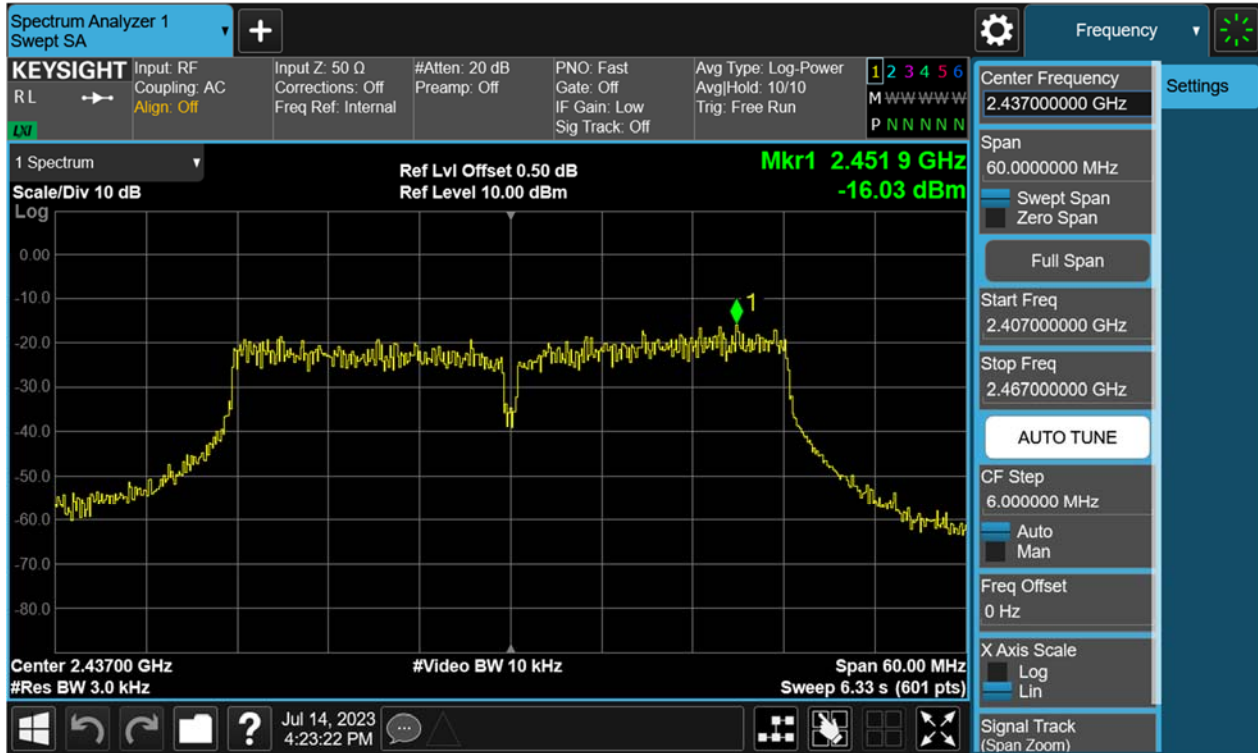
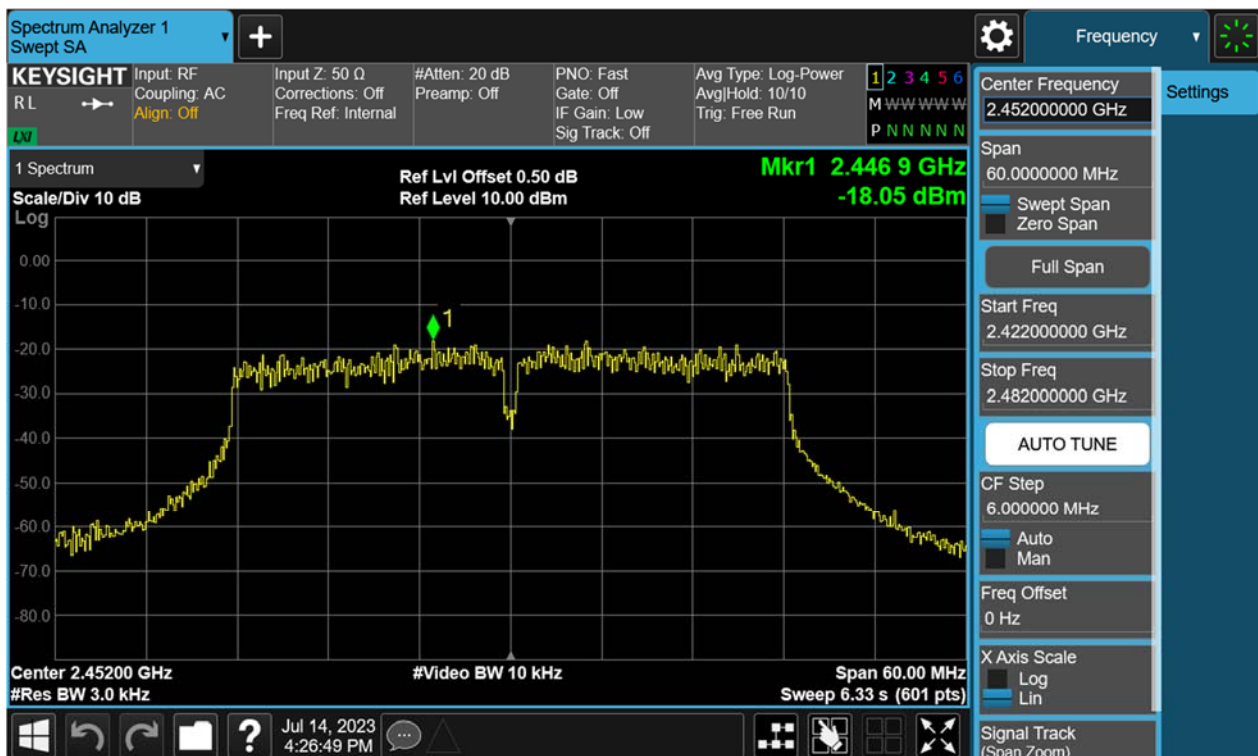

Figure 24: Power Spectral Density, 802.11n(HT40), 2452MHz



TEST REPORT

Report No.: SHE23060104-02BE

Date: 2023-08-08

Page 27 of 61

4.1.5 Conducted Spurious Emission & Authorized-band band-edge

RESULT:

PASS

Test standard : FCC Part 15.247(d), 15.209
Requirement : ANSI C63.10-2013, Clause 11.11.1(a)
KDB 558074 D01 v05r02, Clause 8.5
Kind of test site : Shielded room

Test setup

Test Channel : Low/Middle/High for spurious, Low/High for Band
Edge
Operation Mode : A.1.a
Ambient temperature : 23.8°C
Relative humidity : 46%

For details refer to following test plot.

TEST REPORT

Report No.: SHE23060104-02BE

Date: 2023-08-08

Page 28 of 61

Figure 25: Conducted Spurious Emission & Authorized-band band-edge, 802.11b, 2412MHz Carrier Level

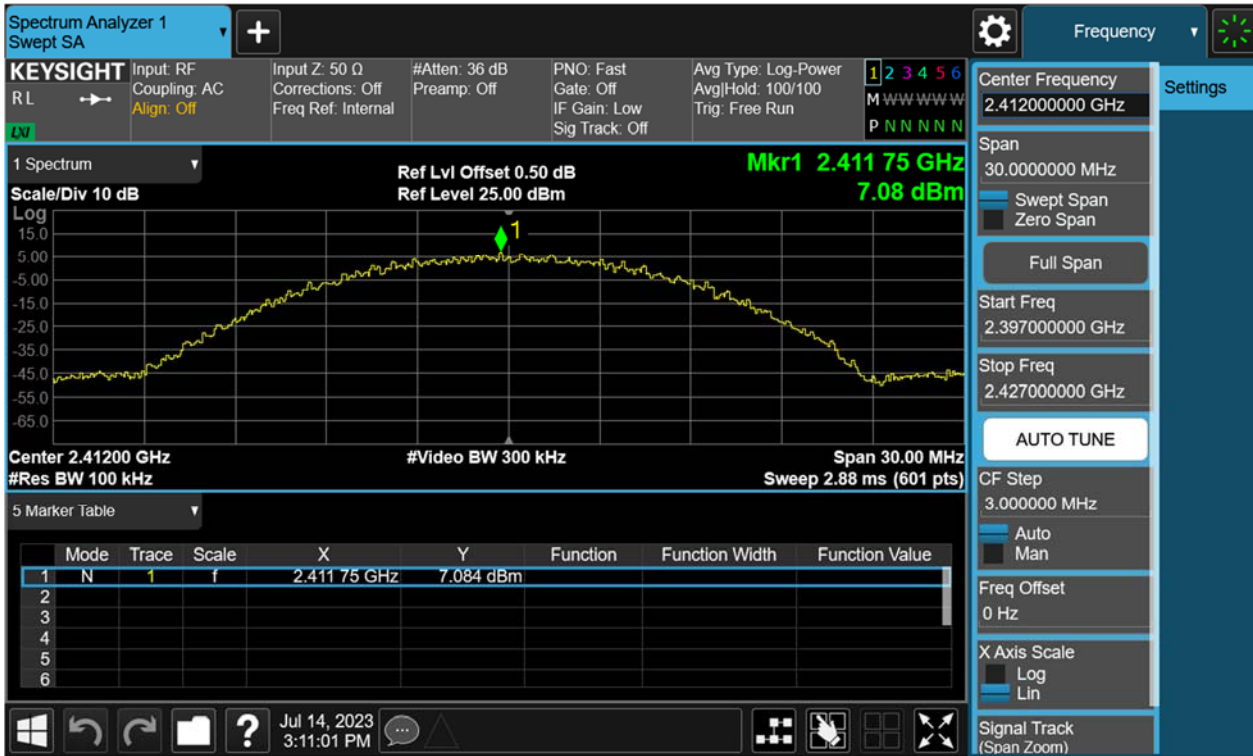

Band Edge

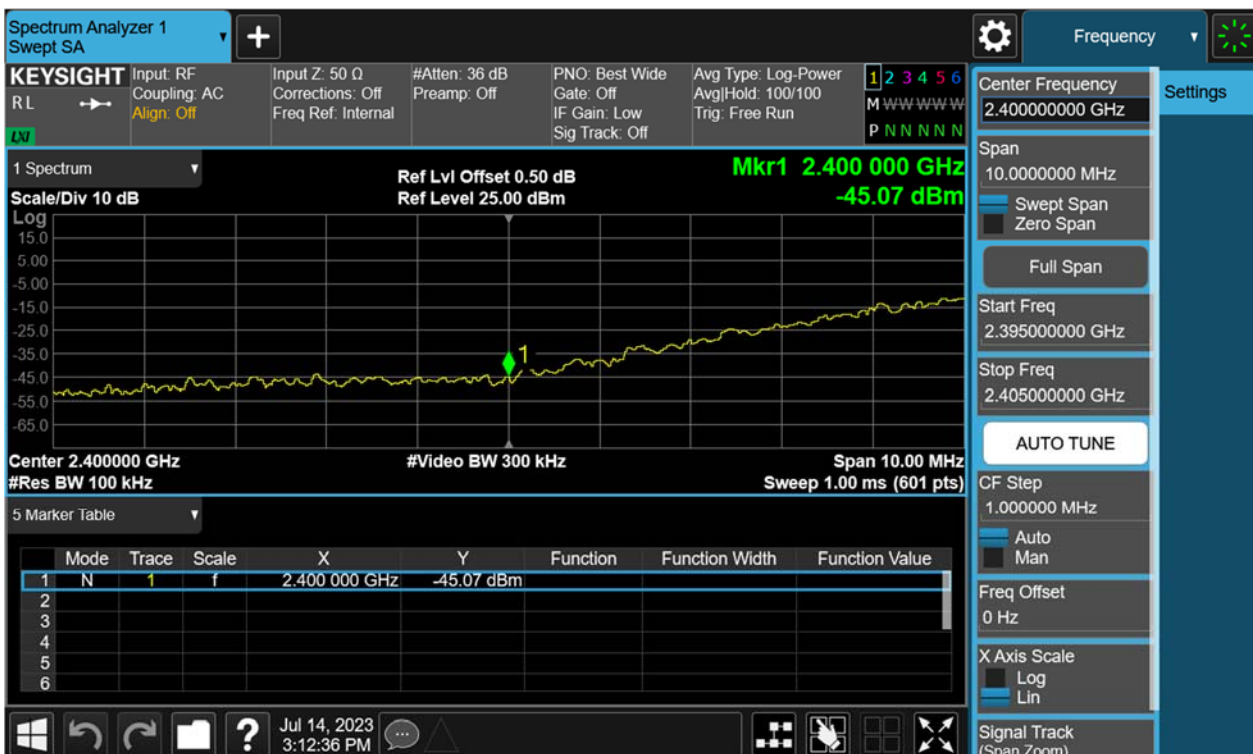

TEST REPORT

Report No.: SHE23060104-02BE

Date: 2023-08-08

Page 30 of 61

Figure 26: Conducted Spurious Emission & Authorized-band band-edge, 802.11b, 2437MHz Carrier Level

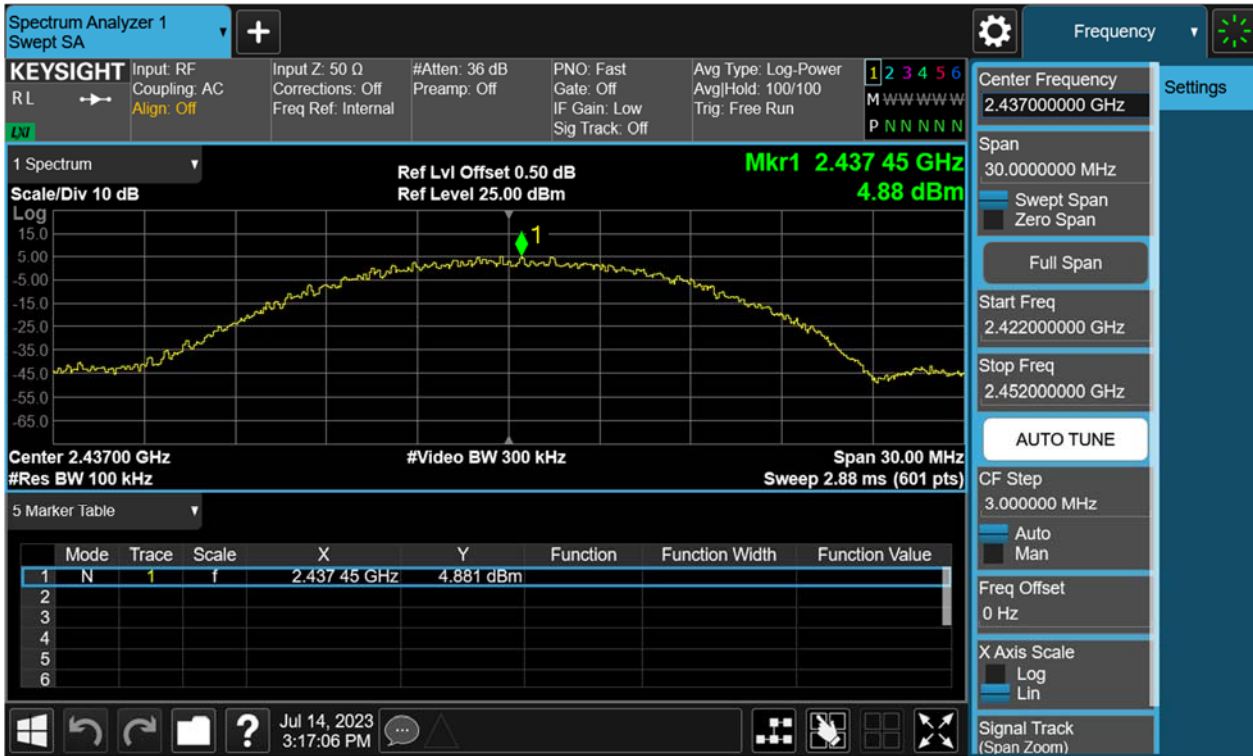

Conducted spurious emissions 30MHz-25GHz

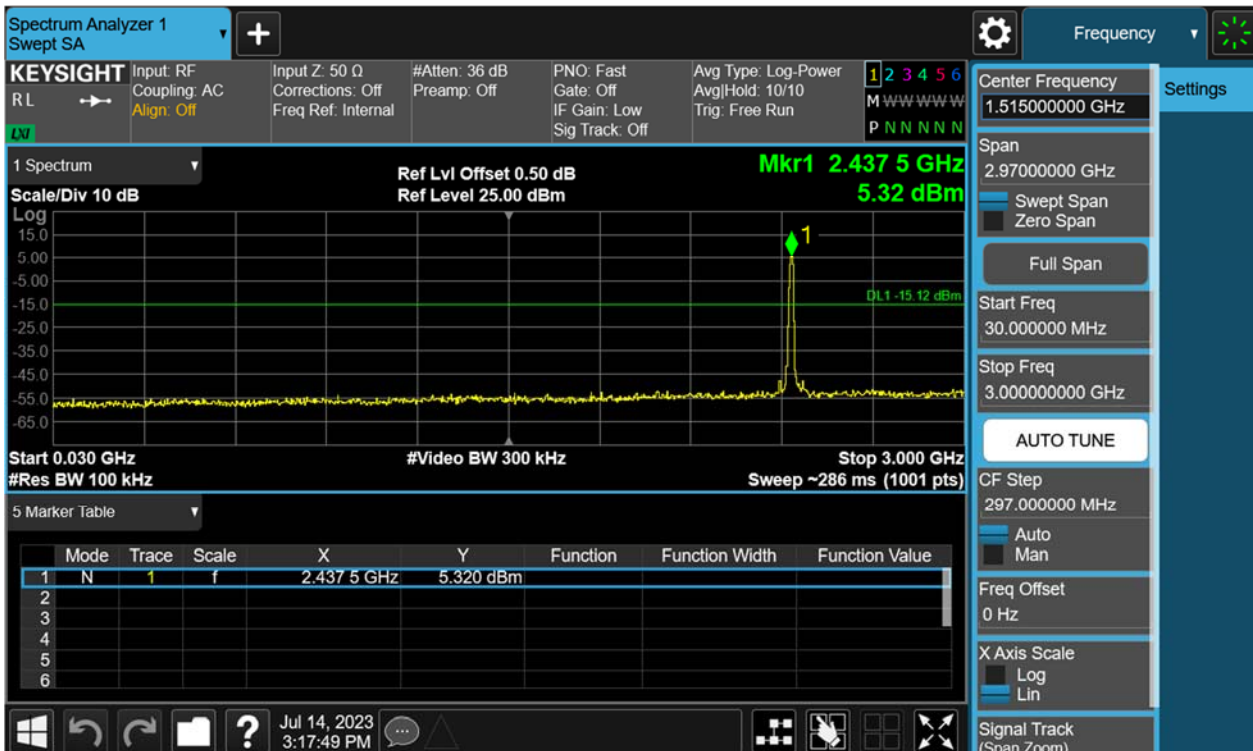

TEST REPORT

Report No.: SHE23060104-02BE

Date: 2023-08-08

Page 31 of 61



Figure 27: Conducted Spurious Emission & Authorized-band band-edge, 802.11b, 2462MHz Carrier Level

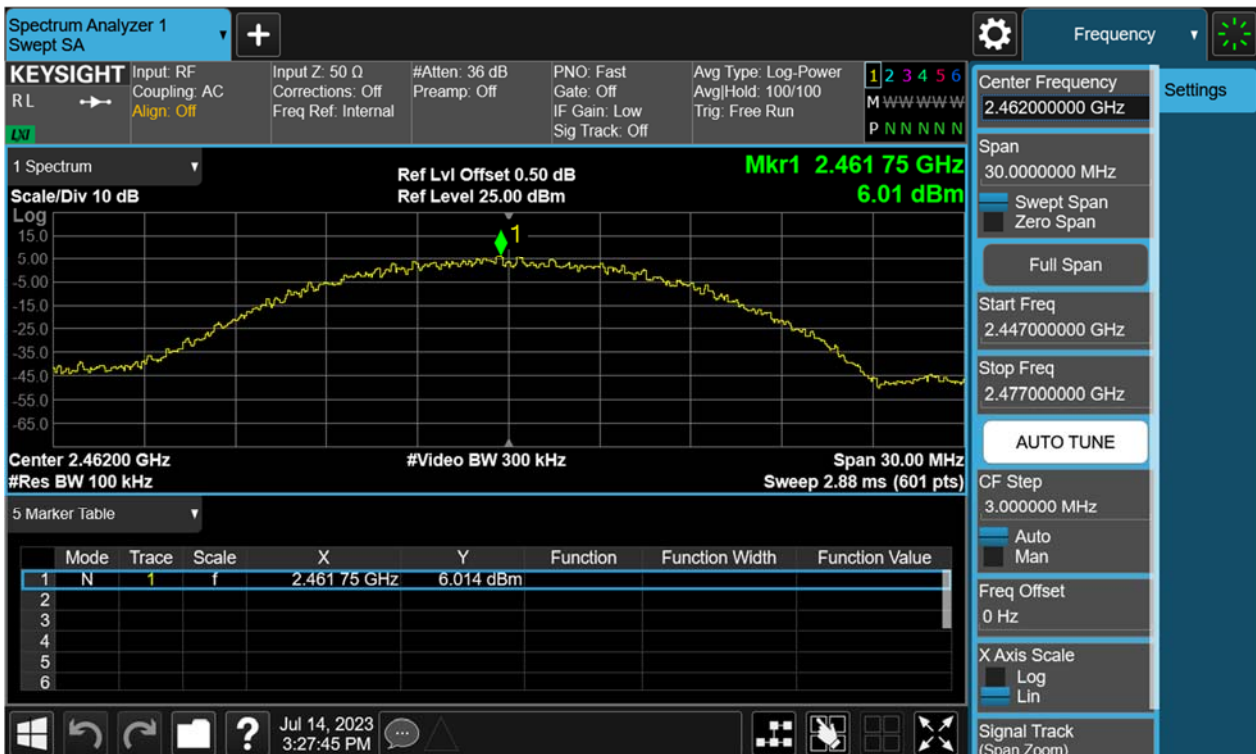

TEST REPORT

Report No.: SHE23060104-02BE

Date: 2023-08-08

Page 32 of 61

Band Edge

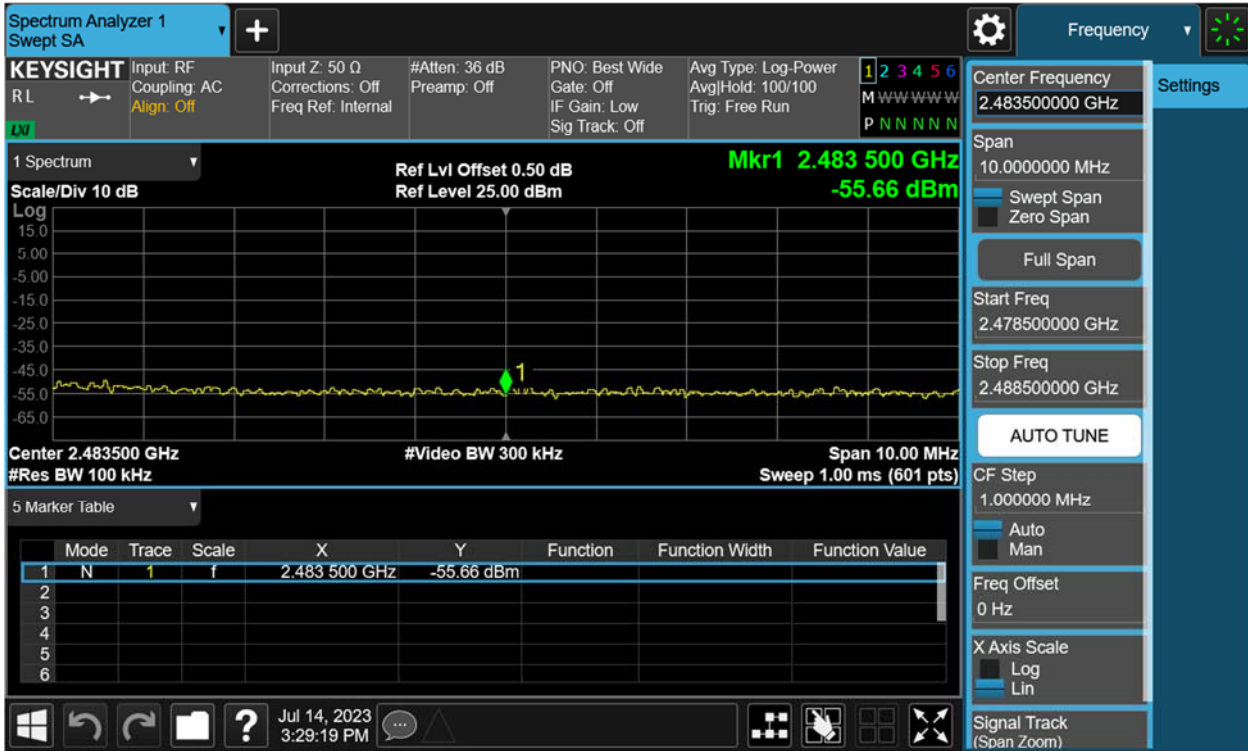

Conducted spurious emissions 30MHz-25GHz

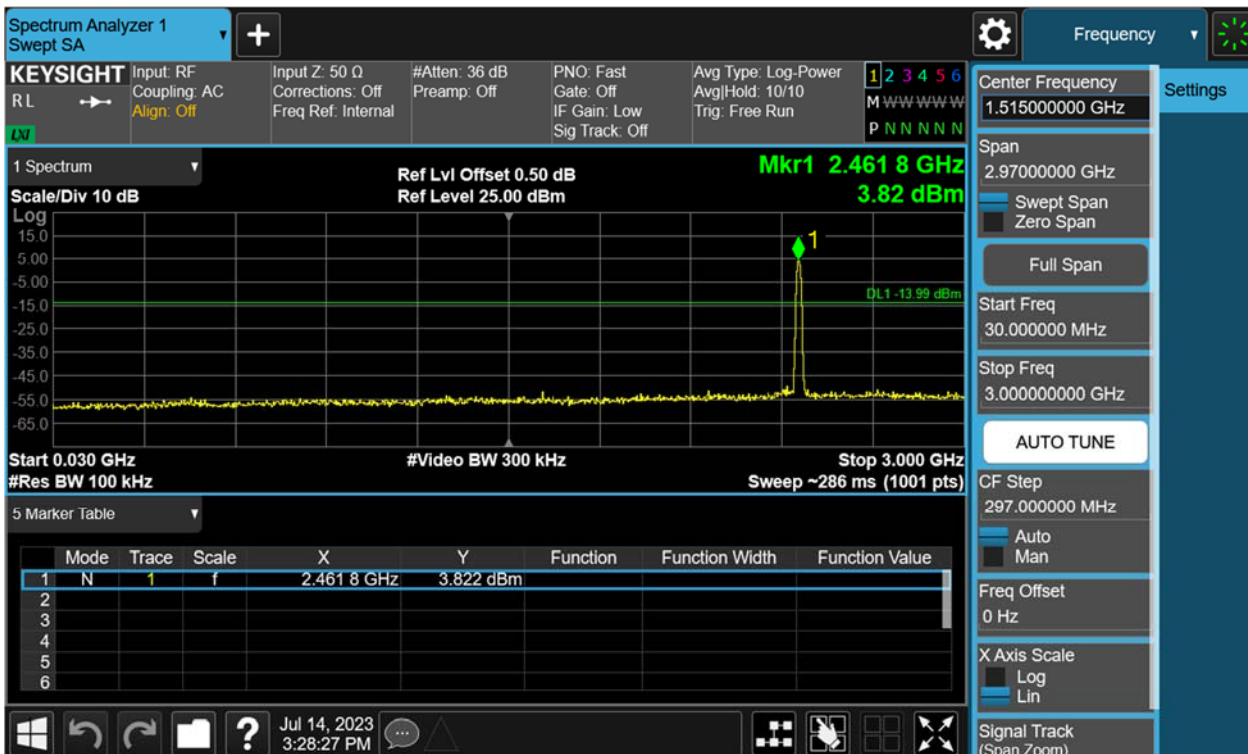

TEST REPORT

Report No.: SHE23060104-02BE

Date: 2023-08-08

Page 33 of 61



Figure 28: Conducted Spurious Emission & Authorized-band band-edge, 802.11g, 2412MHz Carrier Level



TEST REPORT

Report No.: SHE23060104-02BE

Date: 2023-08-08

Page 34 of 61

Band Edge

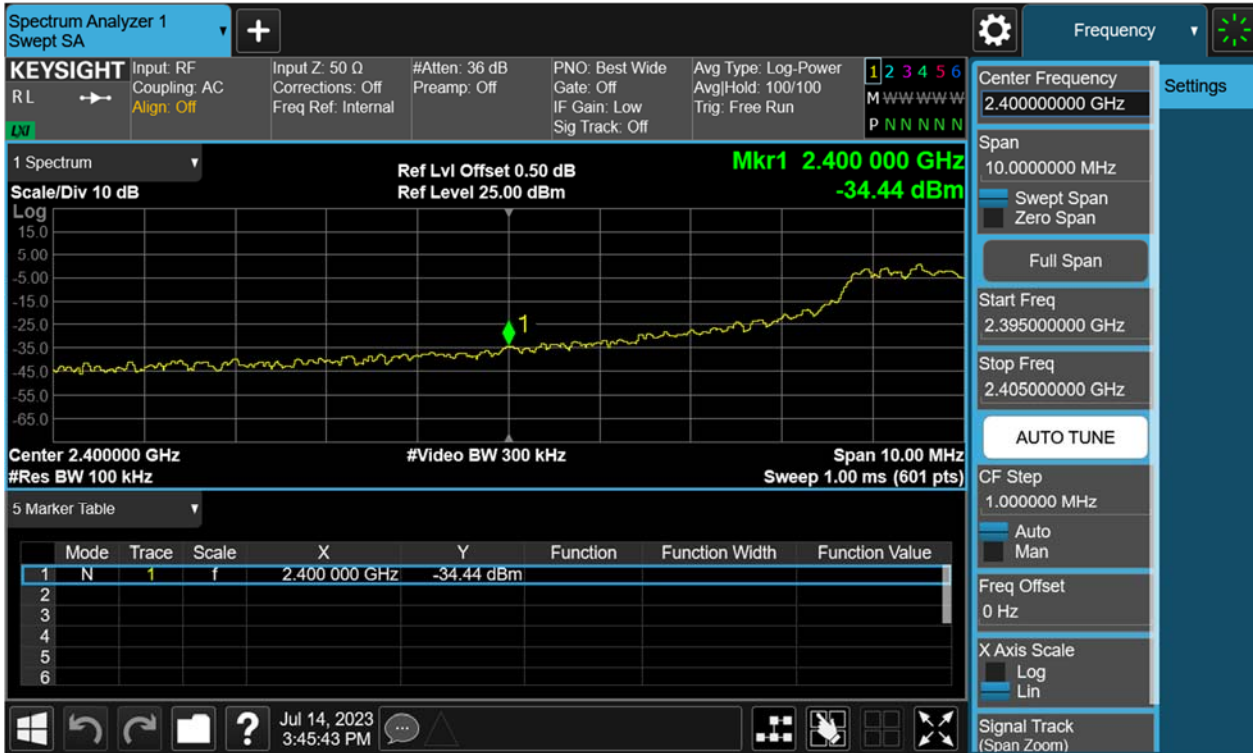

Conducted spurious emissions 30MHz-25GHz



TEST REPORT

Report No.: SHE23060104-02BE

Date: 2023-08-08

Page 35 of 61



Figure 29: Conducted Spurious Emission & Authorized-band band-edge, 802.11g, 2437MHz Carrier Level

