



## 2 Test Summary

Test Items	Test Requirement	Result
RF Output Power	2.1046 22.913 (a) 24.232 (c)	PASS
Peak-to-Average Ratio	24.232 (d)	PASS
Bandwidth	2.1049 22.905 22.917 24.238	PASS
Spurious Emissions at Antenna Terminal	2.1051 22.917 (a) 24.238 (a)	PASS
Field Strength of Spurious Radiation	2.1053 22.917 (a) 24.238 (a)	PASS
Out of band emission, Band Edge	22.917 (a) 24.238 (a)	PASS
Frequency Stability	2.1055 22.355 24.235	PASS
Maximum Permissible Exposure (SAR)	1.1307 2.1093	PASS

### 3 Contents

	<b>Page</b>
<b>1 COVER PAGE.....</b>	<b>1</b>
<b>2 TEST SUMMARY .....</b>	<b>2</b>
<b>3 CONTENTS .....</b>	<b>3</b>
<b>4 REPORT REVISION HISTORY.....</b>	<b>5</b>
<b>5 GENERAL INFORMATION.....</b>	<b>6</b>
5.1 GENERAL DESCRIPTION OF E.U.T. ....	6
5.2 DETAILS OF E.U.T. ....	6
5.3 TEST MODE .....	7
5.4 TEST FACILITY.....	7
<b>6 EQUIPMENT USED DURING TEST .....</b>	<b>8</b>
6.1 EQUIPMENTS LIST .....	8
6.2 MEASUREMENT UNCERTAINTY .....	9
6.3 TEST EQUIPMENT CALIBRATION .....	9
<b>7 RF OUTPUT POWER .....</b>	<b>10</b>
7.1 EUT OPERATION.....	10
7.2 TEST PROCEDURE .....	10
7.3 TEST RESULT .....	11
<b>8 PEAK-TO-AVERAGE RATIO.....</b>	<b>14</b>
8.1 EUT OPERATION.....	14
8.2 TEST PROCEDURE .....	14
8.3 TEST RESULT .....	15
<b>9 BANDWIDTH.....</b>	<b>17</b>
9.1 EUT OPERATION.....	17
9.2 TEST PROCEDURE .....	17
9.3 TEST RESULT .....	18
<b>10 SPURIOUS EMISSIONS AT ANTENNA TERMINALS .....</b>	<b>21</b>
10.1 EUT OPERATION .....	21
10.2 TEST PROCEDURE.....	21
10.3 TEST RESULT .....	22
<b>11 SPURIOUS RADIATED EMISSIONS.....</b>	<b>26</b>
11.1 EUT OPERATION .....	26
11.2 TEST SETUP .....	26
11.3 SPECTRUM ANALYZER SETUP .....	27
11.4 TEST PROCEDURE.....	28
11.5 SUMMARY OF TEST RESULTS .....	29
<b>12 BAND EDGE MEASUREMENT .....</b>	<b>30</b>
12.1 EUT OPERATION .....	30
12.2 TEST PROCEDURE.....	30
12.3 TEST RESULT .....	31
<b>13 FREQUENCY STABILITY.....</b>	<b>35</b>
13.1 EUT OPERATION .....	35
13.2 TEST PROCEDURE.....	35
13.3 TEST RESULT .....	36

**14 RF EXPOSURE.....38**

#### 4 Report Revision History

Report No.	Report Version	Description	Issue Date
WTS16S0961752-2E	NONE	Original	Oct. 14, 2016
WTS16S0961752-2E V1	V1	Version 1	Oct. 24, 2016

## 5 General Information

### 5.1 General Description of E.U.T.

Product Name	: Mobile Phone
Model No.	: Serie2
Model Description	: N/A
GSM Band(s)	: GSM 850/1900MHz
GPRS Class	: 12
WCDMA Band(s)	: N/A
LTE Bnad(s)	: N/A
Wi-Fi Specification	: N/A
Bluetooth Version	: Bluetooth v3.0+EDR
GPS	: N/A
Hardware Version	: KCX915_MAIN_PCB(V1.1)
Software Version	: C39_V09_0726
Storage Location	: Internal Storage

Note: This EUT has two SIM card slots, and use same one RF module. We found that RF parameters are the same, when we insert the card 1 and card 2. So we usually performed the test under main card slot 1.

### 5.2 Details of E.U.T.

Operation Frequency	: GSM/GPRS 850: 824~849MHz PCS/GPRS 1900: 1850~1910MHz Bluetooth: 2402~2480MHz
Max. RF output power	: GSM 850: 32.60dBm PCS1900: 29.54dBm Bluetooth: 3.34dBm
Type of Modulation	: GSM,GPRS: GMSK Bluetooth: GFSK, Pi/4 DQPSK,8DPSK
Antenna installation	: GSM: internal permanent antenna Bluetooth: internal permanent antenna
Antenna Gain	:GSM 850: 1.0dBi PCS1900: 0.8dBi Bluetooth: 0.5dBi
Technical Data	: Battery DC 3.7V, 300mAh DC 5.7V, 0.8A, charging from adapter (Adapter Input: 100-240V~50/60Hz 0.125A)
Adapter	: Manufacture: Shenzhen ZhengHengda Technology Co. Ltd. Model No.: ZHD-002

Type of Emission : GSM850: 252KGXW, GPRS850: 243KGXW  
 PCS1900: 247KGXW, GPRS1900: 248KGXW

### 5.3 Test Mode

All test mode(s) and condition(s) mentioned were considered and evaluated respectively by performing full tests, the worst data were recorded and reported.

Support Band	Test Mode	Channel Frequency	Channel Number
GSM 850	GSM/GPRS	824.2 MHz	128
		836.6 MHz	190
		848.8 MHz	251
PCS 1900	GSM/GPRS	1850.2 MHz	512
		1880.0 MHz	661
		1909.8 MHz	810
Remark: All mode(s) were tested and the worst data was recorded.			

### 5.4 Test Facility

The test facility has a test site registered with the following organizations:

- IC – Registration No.: 7760A**  
 Waltek Services(Shenzhen) Co., Ltd. Has been registered and fully described in a report filed with the Industry Canada. The acceptance letter from the Industry Canada is maintained in our files. Registration number 7760A, October 15, 2015.
- FCC Test Site 1#– Registration No.: 880581**  
 Waltek Services(Shenzhen) Co., Ltd. EMC Laboratory `has been registered and fully described in a report filed with the (FCC) Federal Communications Commission. The acceptance letter from the FCC is maintained in our files. Registration 880581, April 29, 2014.
- FCC Test Site 2#– Registration No.: 328995**  
 Waltek Services(Shenzhen) Co., Ltd. EMC Laboratory `has been registered and fully described in a report filed with the (FCC) Federal Communications Commission. The acceptance letter from the FCC is maintained in our files. Registration 328995, December 3, 2014.

## 6 Equipment Used during Test

### 6.1 Equipments List

RF Conducted Test						
Item	Equipment	Manufacturer	Model No.	Serial No.	Last Calibration Date	Calibration Due Date
1.	EMC Analyzer (9k~26.5GHz)	Agilent	E7405A	MY45114943	Mar.17,2016	Mar.16,2017
2.	Spectrum Analyzer (9k-6GHz)	R&S	FSL6	100959	Mar.17,2016	Mar.16,2017
3.	Humidity Chamber	GF	GTH-225-40-1P	IAA061213	Mar.17,2016	Mar.16,2017
4.	Universal Radio Communication Tester	R&S	CMU 200	112461	Apr.10,2016	Apr.09,2017
3m Semi-anechoic Chamber for Radiated Emissions						
Item	Equipment	Manufacturer	Model No.	Serial No.	Last Calibration Date	Calibration Due Date
1	EMC Analyzer	Agilent	E7405A	MY45114943	Mar.17,2016	Mar.16,2017
2	Active Loop Antenna	Beijing Dazhi	ZN30900A	-	Mar.17,2016	Mar.16,2017
3	Trilog Broadband Antenna	SCHWARZBECK	VULB9163	336	Apr.18,2016	Apr.17,2017
4	Coaxial Cable (below 1GHz)	Top	TYPE16(13M)	-	Mar.17,2016	Mar.16,2017
5	Broad-band Horn Antenna	SCHWARZBECK	BBHA 9120 D	667	Apr.18,2016	Apr.17,2017
6	Broad-band Horn Antenna	SCHWARZBECK	BBHA 9120 D	669	Apr.18,2016	Apr.17,2017
7	Broadband Preamplifier	COMPLIANCE DIRECTION	PAP-1G18	2004	Mar.17,2016	Mar.16,2017
8	Coaxial Cable (above 1GHz)	Top	1000MHz- 25GHz	EW02014-7	Apr.09,2016	Apr.08,2017
9	Broad-band Horn Antenna	SCHWARZBECK	BBHA 9170	335	Apr.18,2016	Apr.17,2017
10	Universal Radio Communication Tester	R&S	CMU 200	112461	Apr.10,2016	Apr.09,2017
11	Signal Generator	R&S	SMR20	100046	Mar.17,2016	Mar.16,2017
12	Smart Antenna	SCHWARZBECK	HA08	-	Apr.18,2016	Apr.17,2017

## 6.2 Measurement Uncertainty

Parameter	Uncertainty
Radio Frequency	$\pm 1 \times 10^{-6}$
RF Power	$\pm 1.0$ dB
RF Power Density	$\pm 2.2$ dB
Radiated Spurious Emissions test	$\pm 5.03$ dB (Bilog antenna 30M~1000MHz)
	$\pm 5.47$ dB (Horn antenna 1000M~25000MHz)
Conducted Spurious Emissions test	$\pm 3.64$ dB (AC mains 150KHz~30MHz)

## 6.3 Test Equipment Calibration

All the test equipments used are valid and calibrated by CEPREI Certification Body that address is No.110 Dongguan Zhuang RD. Guangzhou, P.R.China.

## 7 RF OUTPUT POWER

Test Requirement:	FCC Part 2.1046,22.913 (a),24.232 (c)
Test Method:	TIA/EIA-603-D:2010 KDB971168 D01 v02r02
Test Mode:	Transmitting

### 7.1 EUT Operation

Operating Environment :

Temperature:	22.5 °C
Humidity:	52.1 % RH
Atmospheric Pressure:	101.2kPa

### 7.2 Test Procedure

Conducted method:

The RF output of the transmitter was connected to the wireless test set and the spectrum analyzer through sufficient attenuation.

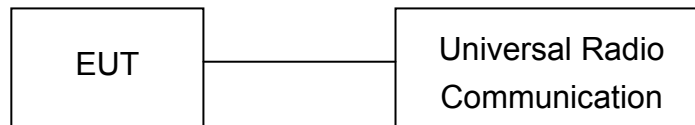

Radiated method:

1. The setup of EUT is according with per TIA/EIA Standard 603D.
2. The measurement antenna was placed at a distance of 3 meters from the EUT. During the tests, the antenna height and polarization as well as EUT azimuth were varied in order to identify the maximum level of emissions from the EUT. The test was performed by placing the EUT on 3-orthogonal axis.
3. The frequency range up to tenth harmonic of the fundamental frequency was investigated.
4. Remove the EUT and replace it with substitution antenna. A signal generator was connected to the substitution antenna by a non-radiating cable. The absolute levels of the spurious emissions were measured by the substitution.

### 7.3 Test Result

Conducted Power						
GSM - Burst Average Power (dBm)						
Band	GSM850			PCS1900		
Channel	128	190	251	512	661	810
Frequency (MHz)	824.2	836.6	848.8	1850.2	1880	1909.8
GSM	32.60	32.36	32.59	29.43	29.42	28.92
GPRS (1 slot)	32.24	32.59	32.24	29.54	29.37	28.92
GPRS (2 slots)	31.14	31.20	31.11	28.70	28.90	28.66
GPRS (3 slots)	28.80	28.89	28.83	27.07	27.21	27.07
GPRS (4 slots)	27.82	27.92	27.90	26.25	26.53	26.15

**Radiated Power**

ERP and EIRP

Cellular Band (Part 22H)

Frequency	Receiver Reading	Turn table Angle	RX Antenna		Substituted			Absolute Level	Part 22H	
			Height	Polar	SG Level	Cable	Antenna Gain		Limit	Margin
(MHz)	(dB $\mu$ V)	Degree	(m)	(H/V)	(dBm)	(dB)	(dB)	(dBm)	(dBm)	(dB)
GSM 850 Channel 128										
824.20	91.68	275	1.6	H	24.65	0.20	0.00	24.45	38.45	-14.00
824.20	97.09	280	1.6	V	29.99	0.20	0.00	29.79	38.45	-8.66
GSM 850 Channel 190										
836.60	90.45	149	2.4	H	23.42	0.20	0.00	23.22	38.45	-15.23
836.60	97.24	74	2.3	V	30.14	0.20	0.00	29.94	38.45	-8.51
GSM 850 Channel 251										
848.80	92.84	163	2.3	H	25.81	0.20	0.00	25.61	38.45	-12.84
848.80	97.06	84	1.8	V	29.96	0.20	0.00	29.76	38.45	-8.69
GPRS 850 Channel 128										
824.20	90.37	64	1.5	H	23.34	0.20	0.00	23.14	38.45	-15.31
824.20	97.68	254	1.9	V	30.58	0.20	0.00	30.38	38.45	-8.07
GPRS 850 Channel 190										
836.60	92.23	111	1.9	H	25.20	0.20	0.00	25.00	38.45	-13.45
836.60	97.73	169	2.1	V	30.63	0.20	0.00	30.43	38.45	-8.02
GPRS 850 Channel 251										
848.80	90.52	11	1.4	H	23.49	0.20	0.00	23.29	38.45	-15.16
848.80	97.13	179	1.9	V	30.03	0.20	0.00	29.83	38.45	-8.62

## Cellular Band (Part 24E)

Frequency	Receiver Reading	Turn table Angle	RX Antenna		Substituted			Absolute Level	Part 24E	
			Height	Polar	SG Level	Cable	Antenna Gain		Limit	Margin
(MHz)	(dBμV)	Degree	(m)	(H/V)	(dBm)	(dB)	(dB)	(dBm)	(dBm)	(dB)
PCS 1900 Channel 512										
1850.20	86.33	91	2.0	H	12.36	0.31	10.40	22.45	33	-10.55
1850.20	92.74	330	1.3	V	19.46	0.31	10.40	29.55	33	-3.45
PCS 1900 Channel 661										
1880.00	85.74	63	1.3	H	11.89	0.31	10.40	21.98	33	-11.02
1880.00	92.29	4	2.5	V	19.17	0.31	10.40	29.26	33	-3.74
PCS 1900 Channel 810										
1909.80	86.97	124	2.0	H	13.24	0.32	10.40	23.32	33	-9.68
1909.80	92.49	314	1.7	V	19.53	0.32	10.40	29.61	33	-3.39
GPRS 1900 Channel 512										
1850.20	84.92	352	2.3	H	10.95	0.31	10.40	21.04	33	-11.96
1850.20	92.60	356	1.9	V	19.32	0.31	10.40	29.41	33	-3.59
GPRS 1900 Channel 661										
1880.00	85.09	327	2.1	H	11.24	0.31	10.40	21.33	33	-11.67
1880.00	92.74	50	2.1	V	19.62	0.31	10.40	29.71	33	-3.29
GPRS 1900 Channel 810										
1909.80	87.96	310	1.3	H	14.23	0.32	10.40	24.31	33	-8.69
1909.80	92.75	22	1.8	V	19.79	0.32	10.40	29.87	33	-3.13

## 8 Peak-to-Average Ratio

Test Requirement:	24.232 (d)
Test Method:	N/A
Test Mode:	Transmitting

### 8.1 EUT Operation

Operating Environment :

Temperature:	22.5 °C
Humidity:	52.3% RH
Atmospheric Pressure:	101.2kPa

### 8.2 Test Procedure

1. The EUT was connected to spectrum analyzer and system simulator via a power divider.
2. Set EUT to transmit at maximum output power.
3. When the duty cycle is less than 98%, then signal gating will be implemented on the spectrum analyzer by triggering from the system simulator.
4. Set the CCDF (Complementary Cumulative Distribution Function) option of the spectrum analyzer. Record the maximum PAPR level associated with a probability of 0.1%.

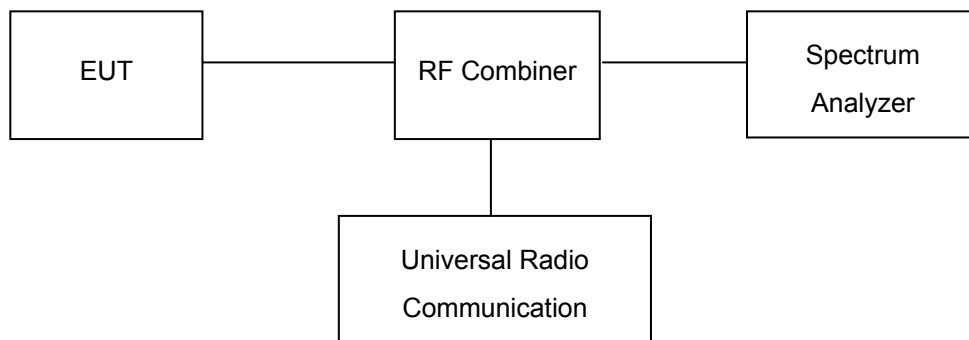

### 8.3 Test Result

Remark: Only the worst case (middle channel mode) were reported

Cellular Band (Part 24E)

Mode	PCS 1900			GPRS 1900			Limit (dB)
	Channel	512	661	810	512	661	
Frequency (MHz)	1850.2	1880.0	1909.8	1850.2	1880.0	1909.8	
Peak-to-Average Ratio (dB)	8.86	9.02	8.95	9.53	9.55	9.49	13

Test Plots (Part 24E)

PCS1900 Middle Channel

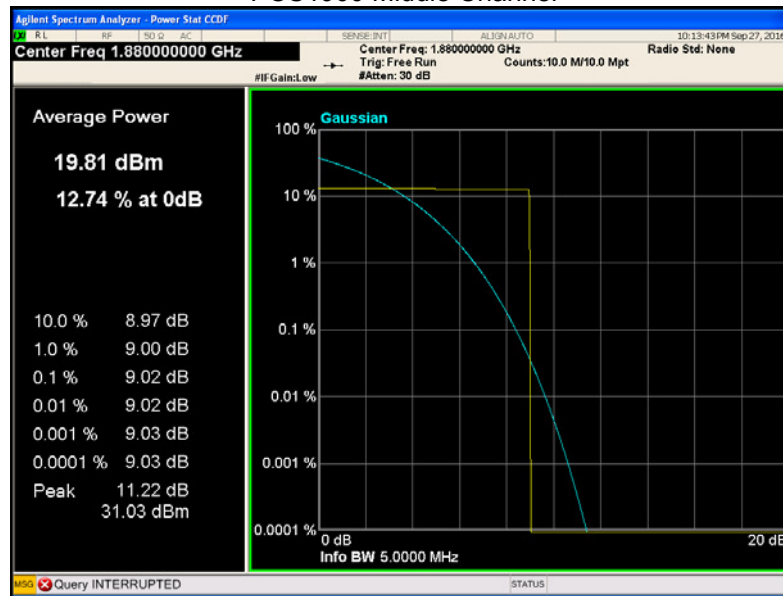

### GPRS 1900 Middle Channel

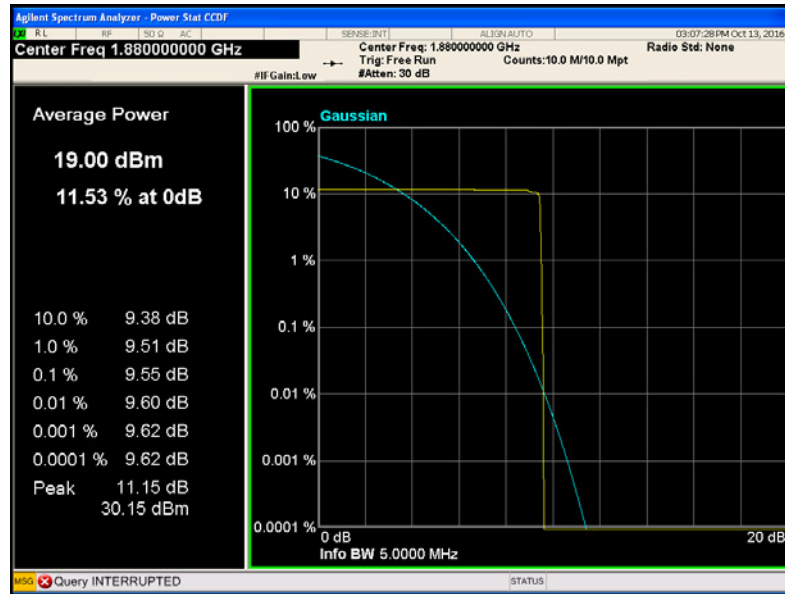

## 9 BANDWIDTH

Test Requirement: FCC Part 2.1049,22.917,22.905,24.238

Test Method: TIA/EIA-603-D:2010  
KDB971168 D01 v02r02

Test Mode: Transmitting

### 9.1 EUT Operation

Operating Environment :

Temperature: 22.5 °C

Humidity: 52.3% RH

Atmospheric Pressure: 101.2kPa

### 9.2 Test Procedure

The RF output of the transmitter was connected to the wireless test set and the spectrum analyzer through sufficient attenuation.

The resolution bandwidth of the spectrum analyzer was set at 3 kHz (Cellular /PCS) and the 26 dB & 99%bandwidth was recorded.

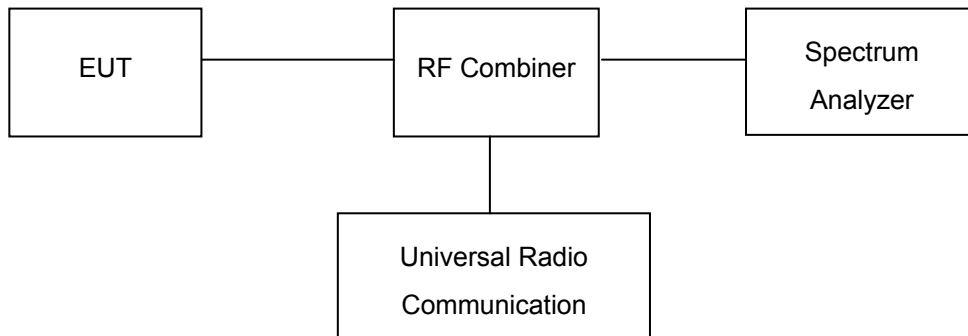

### 9.3 Test Result

Remark: Only the worst case (middle channel mode) were reported

Cellular Band (Part 22H)

Test Mode	Channel	Frequency (MHz)	99% Occupied Bandwidth(kHz)	26 dB Emission Bandwidth(kHz)
GSM 850	128	824.2	251.98	314.88
	190	836.6	252.10	315.00
	251	848.8	252.01	314.86
GPRS 850	128	824.2	243.11	312.14
	190	836.6	243.23	312.30
	251	848.8	243.14	312.17

Cellular Band (Part 24E)

Test Mode	Channel	Frequency (MHz)	99% Occupied Bandwidth(kHz)	26 dB Emission Bandwidth(kHz)
PCS 1900	512	1850.2	246.94	313.30
	661	1880.0	247.08	313.40
	810	1909.8	246.92	313.32
GPRS 1900	512	1850.2	247.55	312.60
	661	1880.0	247.65	312.70
	810	1909.8	247.49	312.62

Test Plots (worst case)  
 Cellular Band (Part 22H)  
 GSM 850

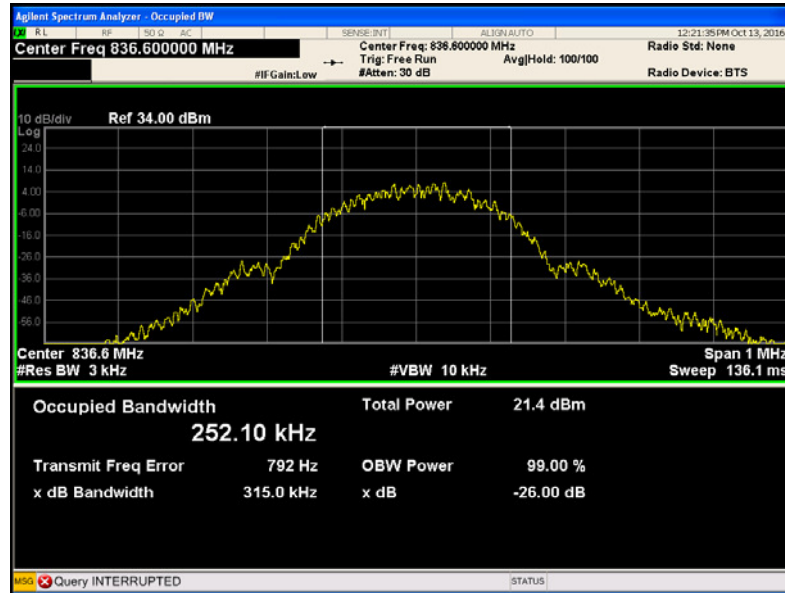

GPRS 850

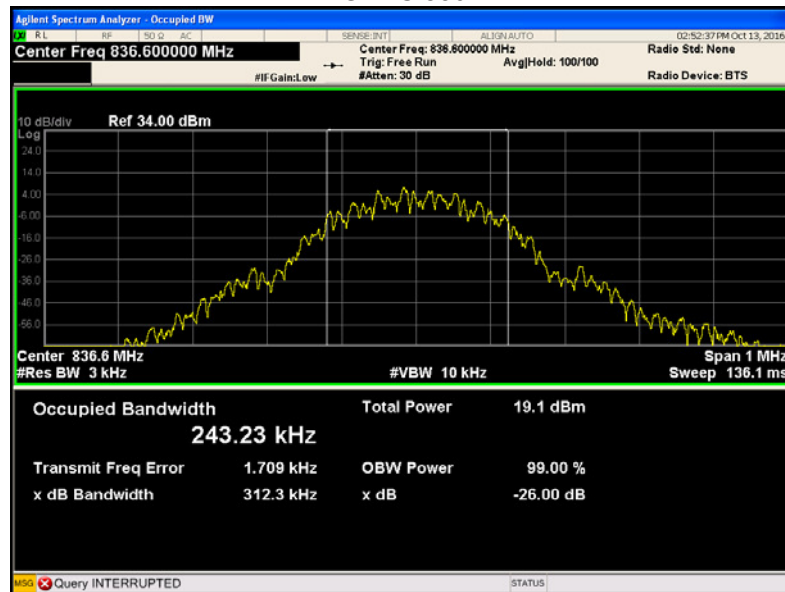

Cellular Band (Part 24E)

PCS 1900

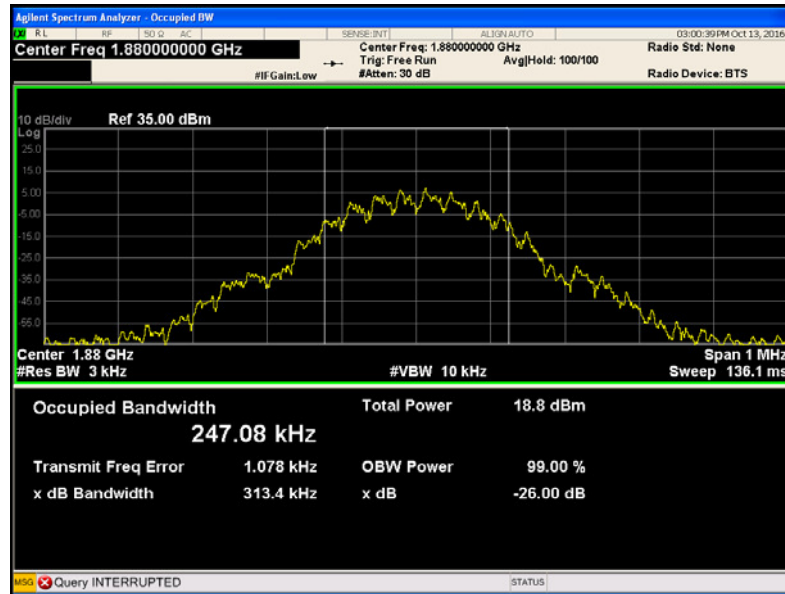

GPRS 1900

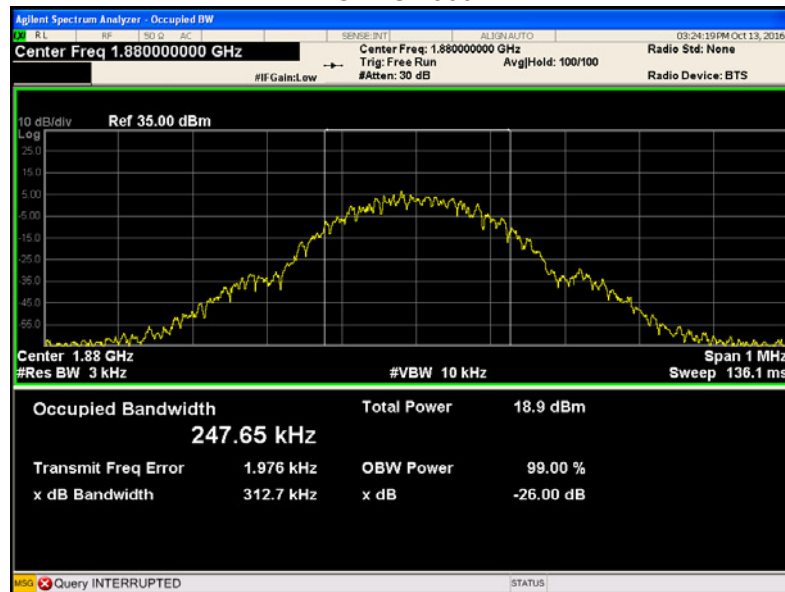

## 10 SPURIOUS EMISSIONS AT ANTENNA TERMINALS

Test Requirement:	FCC Part 2.1051,22.917(a),24.238(a)
Test Method:	TIA/EIA-603-D:2010 KDB971168 D01 v02r02
Test Mode:	Transmitting

### 10.1 EUT Operation

Operating Environment :

Temperature:	23.5 °C
Humidity:	52.1 % RH
Atmospheric Pressure:	101.3kPa

### 10.2 Test Procedure

The RF output of the transceiver was connected to a spectrum analyzer and simulator through appropriate attenuation. The resolution bandwidth of the spectrum analyzer was set at 1MHz. Sufficient scans were taken to show any out of band emissions up to 10th harmonics.

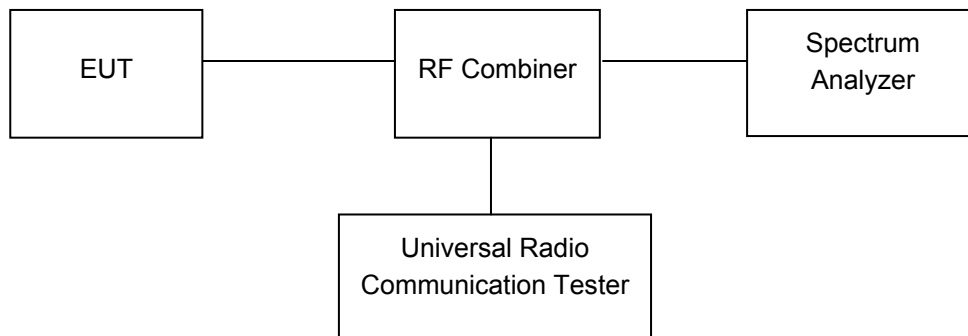

### 10.3 Test Result

Remark: only the worst data were recorded.

Cellular Band (Part 22H)

GSM 850 - channel 128

30MHz-1GHz

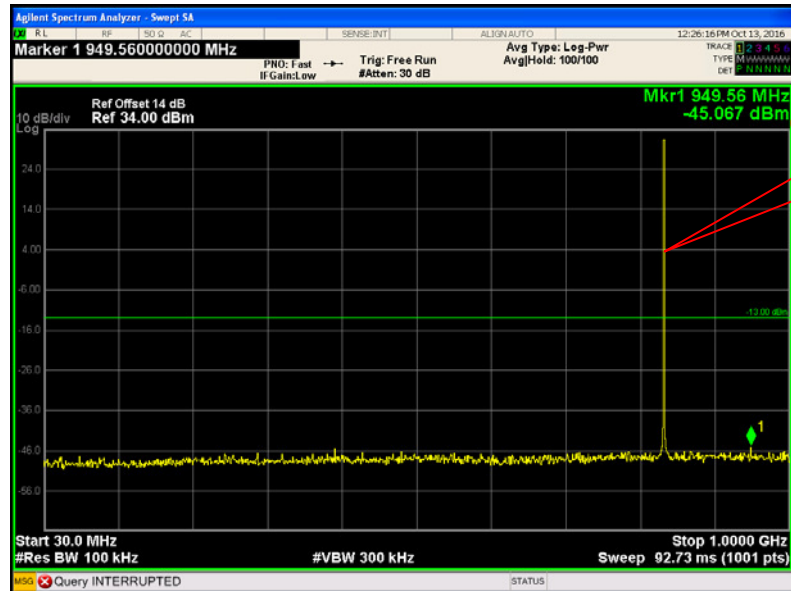

Above 1GHz

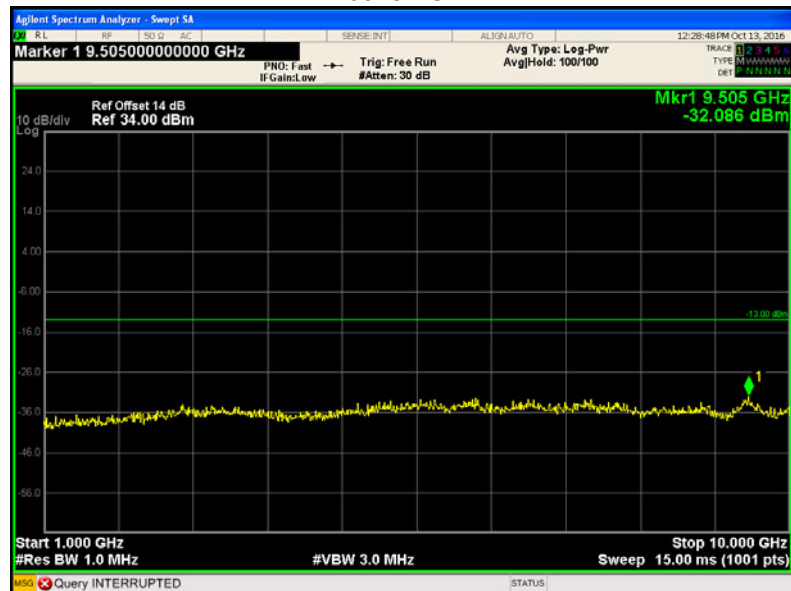

Cellular Band (Part 22H)

GPRS 850 - channel 128

30MHz-1GHz

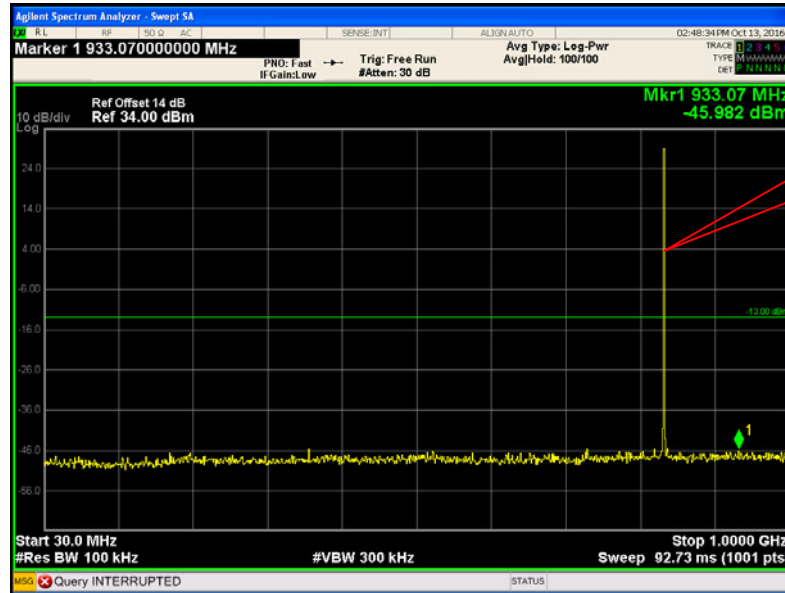

Above 1GHz

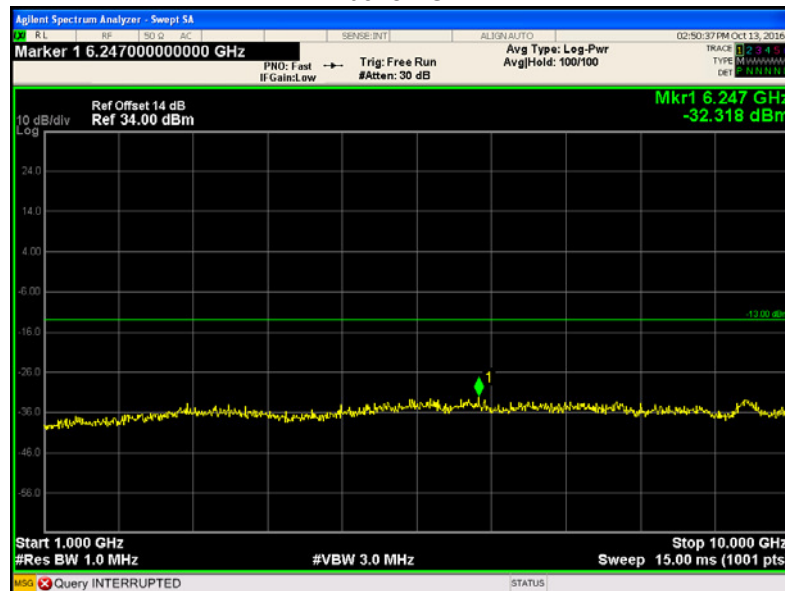

Cellular Band (Part 24E)  
PCS 1900 - channel 512  
30MHz-1GHz

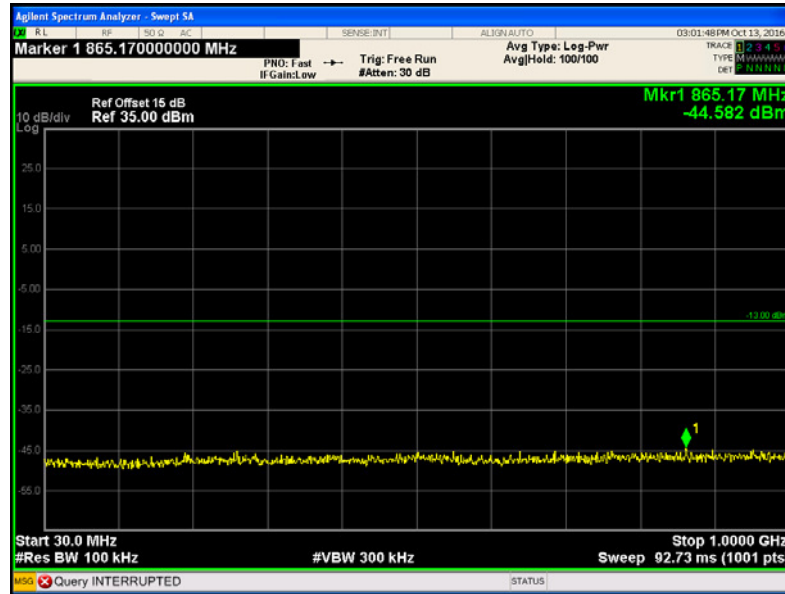

Above 1GHz

Fundamental

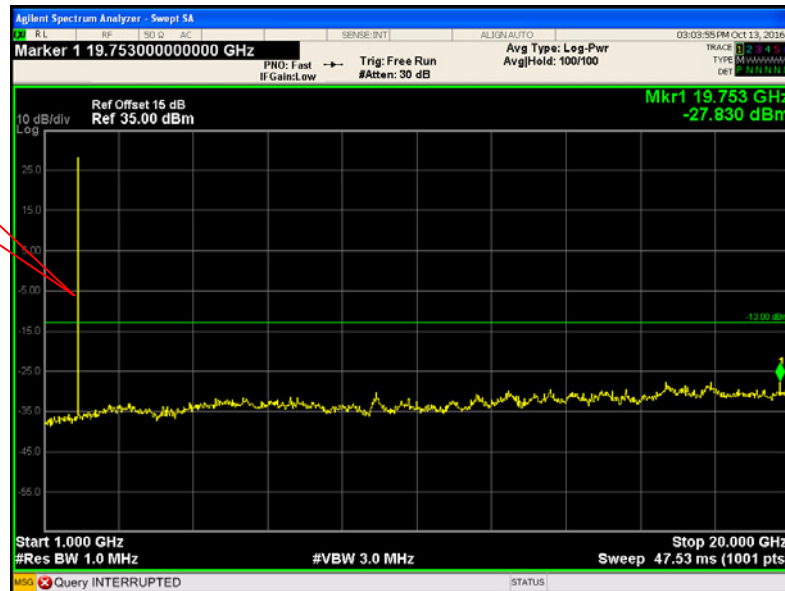

Cellular Band (Part 24E)  
GPRS 1900 - channel 512  
30MHz-1GHz

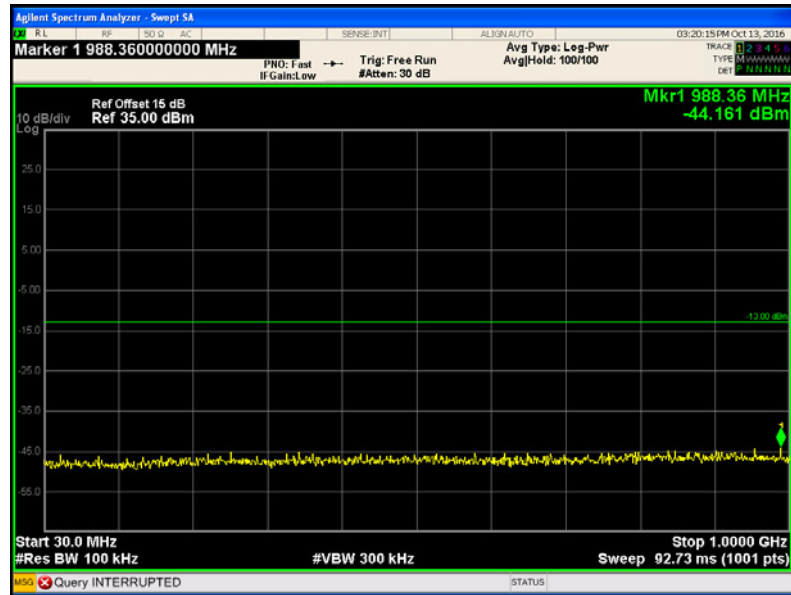

Above 1GHz

Fundamental

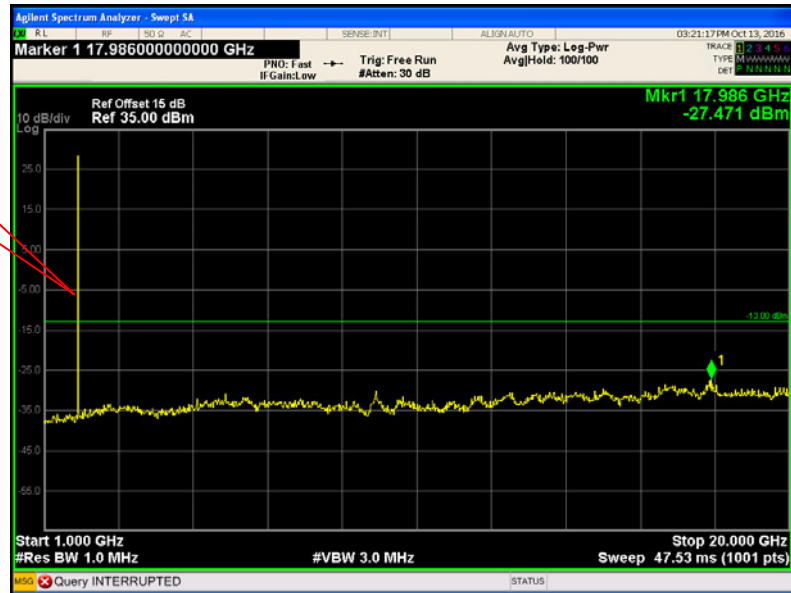

## 11 SPURIOUS RADIATED EMISSIONS

Test Requirement: FCC Part 2.1053,22.917,24.238

Test Method: TIA/EIA-603-D:2010  
KDB971168 D01 v02r02

Test Mode: Transmitting

### 11.1 EUT Operation

Operating Environment :

Temperature: 23.5 °C

Humidity: 52.1 % RH

Atmospheric Pressure: 101.2kPa

### 11.2 Test Setup

The radiated emission tests were performed in the 3m Semi- Anechoic Chamber test site.  
The test setup for emission measurement from 30 MHz to 1 GHz.

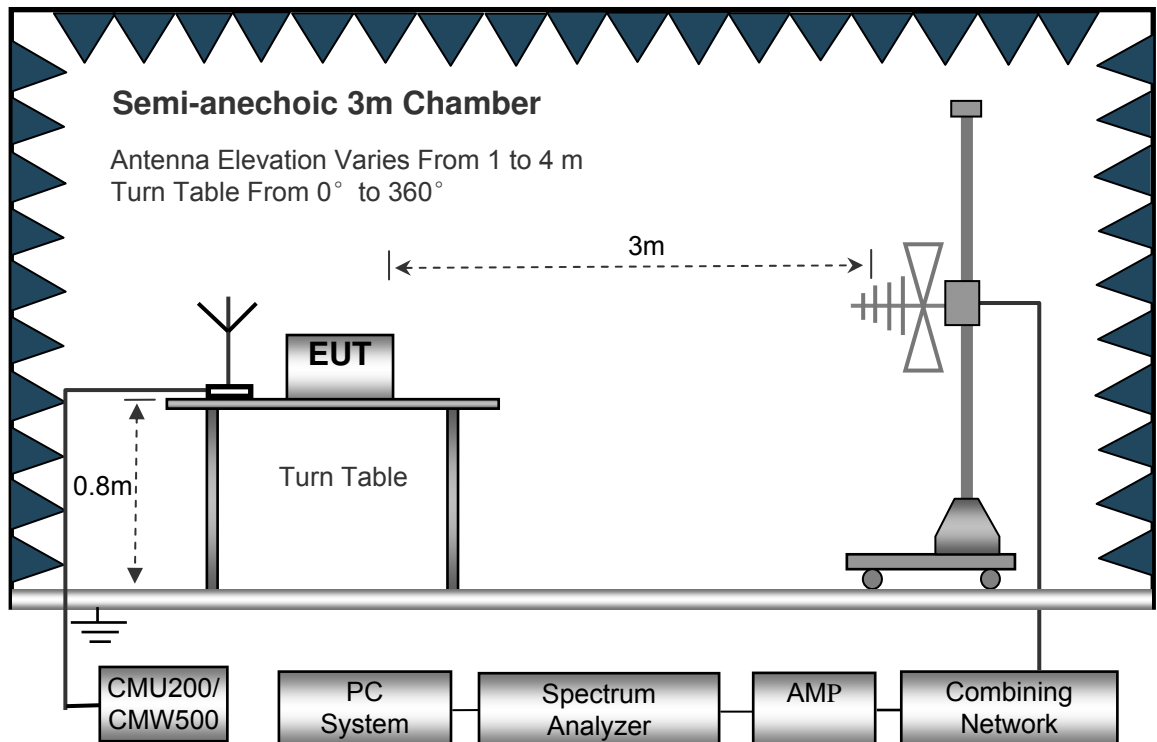

The test setup for emission measurement above 1 GHz.

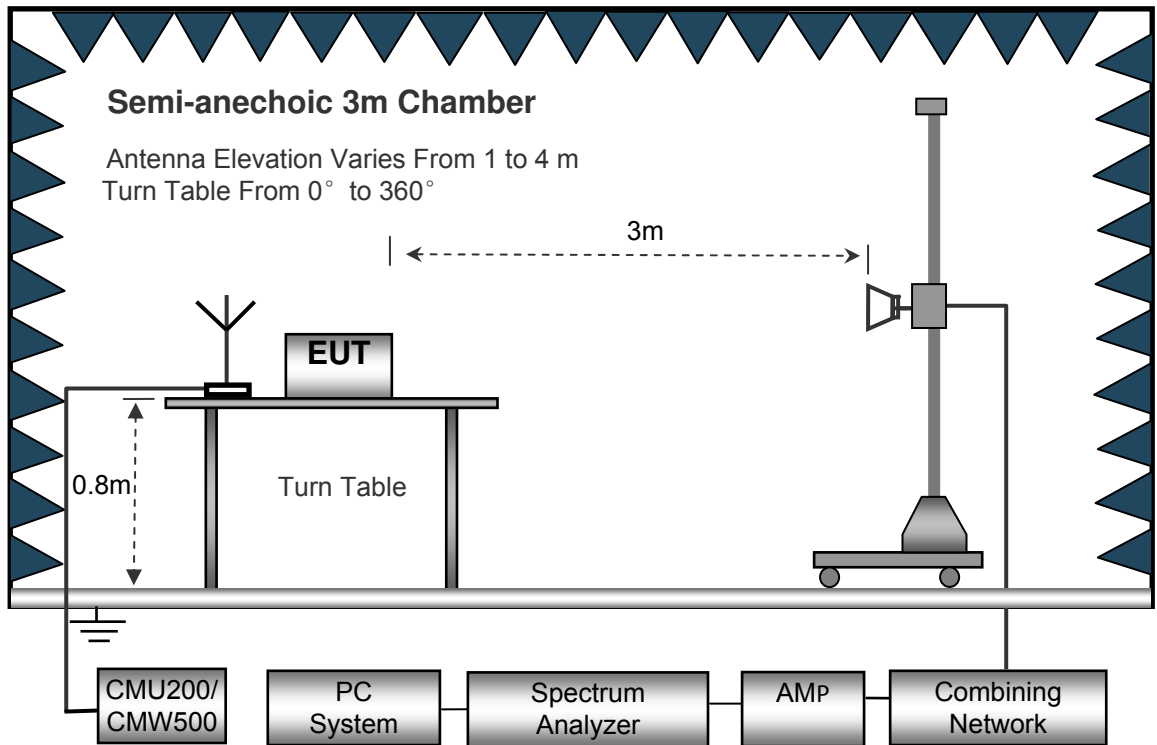

### 11.3 Spectrum Analyzer Setup

30MHz ~ 1GHz

Sweep Speed ..... Auto  
 Detector ..... PK  
 Resolution Bandwidth..... 100kHz  
 Video Bandwidth..... 300kHz

Above 1GHz

Sweep Speed ..... Auto  
 Detector ..... PK  
 Resolution Bandwidth..... 1MHz  
 Video Bandwidth..... 3MHz  
 Detector ..... Ave.  
 Resolution Bandwidth..... 1MHz  
 Video Bandwidth..... 10Hz

## 11.4 Test Procedure

1. The EUT is placed on a turntable, which is 0.8m above ground plane.
2. The turntable shall be rotated for 360 degrees to determine the position of maximum emission level.
3. EUT is set 3m away from the receiving antenna, which is moved from 1m to 4m to find out the maximum emissions. The spectrum was investigated from 30MHz up to the tenth harmonic of the highest fundamental frequency.
4. Maximum procedure was performed on the six highest emissions to ensure EUT compliance.
5. And also, each emission was to be maximized by changing the polarization of receiving antenna both horizontal and vertical.
6. The radiation measurements are tested under 3-axes(X,Y,Z) position(X denotes lying on the table, Y denotes side stand and Z denotes vertical stand), After pre-test, It was found that the worse radiation emission was get at the Z position. So the data shown was the Z position only.
7. Remove the EUT and replace it with substitution antenna. A signal generator was connected to the substitution antenna by a non-radiating cable. The absolute levels of the spurious emissions were measured by the substitution.  
Spurious emissions in dB =  $10 \lg(\text{TXpwr in Watts}/0.001)$  – the absolute level  
Spurious attenuation limit in dB =  $43 + 10 \text{Log}_{10}(\text{power out in Watts})$
8. Repeat above procedures until the measurements for all frequencies are completed.

## 11.5 Summary of Test Results

For 26MHz~30MHz,

The measurements were more than 20 dB below the limit and not reported.

Remark: Test performed from 30MHz to 10<sup>th</sup> harmonics with low/middle/high channels, only the worst data were recorded.

### Cellular Band (Part 22H)

Frequency	Receiver Reading	Turn table Angle	RX Antenna		Substituted			Absolute Level	Result	
			Height	Polar	SG Level	Cable	Antenna Gain		Limit	Margin
(MHz)	(dBμV)	Degree	(m)	(H/V)	(dBm)	(dB)	(dB)	(dBm)	(dBm)	(dB)
GSM 850 Channel 128										
199.38	41.43	80	1.7	H	-69.08	0.15	0.00	-69.23	-13.00	-56.23
199.38	45.65	99	1.0	V	-61.94	0.15	0.00	-62.09	-13.00	-49.09
1648.40	67.84	134	1.6	H	-46.13	0.30	9.40	-37.03	-13.00	-24.03
1648.40	58.32	39	1.1	V	-55.21	0.30	9.40	-46.11	-13.00	-33.11
2472.60	57.83	257	1.4	H	-56.17	0.43	10.60	-46.00	-13.00	-33.00
2472.60	48.14	111	1.9	V	-62.14	0.43	10.60	-51.97	-13.00	-38.97

### Cellular Band (Part 24E)

Frequency	Receiver Reading	Turn table Angle	RX Antenna		Substituted			Absolute Level	Result	
			Height	Polar	SG Level	Cable	Antenna Gain		Limit	Margin
(MHz)	(dBμV)	Degree	(m)	(H/V)	(dBm)	(dB)	(dB)	(dBm)	(dBm)	(dB)
PCS 1900 Channel 512										
216.37	50.29	192	1.9	H	-60.22	0.15	0.00	-60.37	-13.00	-47.37
216.37	39.93	158	1.5	V	-67.66	0.15	0.00	-67.81	-13.00	-54.81
3700.40	65.95	309	1.3	H	-45.59	2.37	12.50	-35.46	-13.00	-22.46
3700.40	59.98	169	1.6	V	-49.83	2.37	12.50	-39.70	-13.00	-26.70
5550.60	53.58	338	1.2	H	-56.03	2.86	12.90	-45.99	-13.00	-32.99
5550.60	44.73	57	1.1	V	-64.15	2.86	12.90	-54.11	-13.00	-41.11

Note: 1) Absolute Level = SG Level - Cable loss + Antenna Gain

2) Margin = Limit- Absolute Level

## 12 Band Edge Measurement

Test Requirement:	FCC Part 2.1051,22.917(a),24.238(a)
Test Method:	TIA/EIA-603-D:2010 KDB971168 D01 v02r02
Test Mode:	Transmitting

### 12.1 EUT Operation

Operating Environment :

Temperature:	23.5 °C
Humidity:	52.3 % RH
Atmospheric Pressure:	101.3kPa

### 12.2 Test Procedure

The RF output of the transmitter was connected to the input of the spectrum analyzer through sufficient attenuation.

According to FCC Part 22.917(a), the power of any emissions outside of the authorized operating frequency ranges must be attenuated below the transmitting power (P) by a factor of at least  $43 + 10 \log(P)$  dB.

According to FCC Part 24.238(a), the power of any emissions outside of the authorized operating frequency ranges must be attenuated below the transmitting power (P) by a factor of at least  $43 + 10 \log(P)$  dB.

The center of the spectrum analyzer was set to block edge frequency

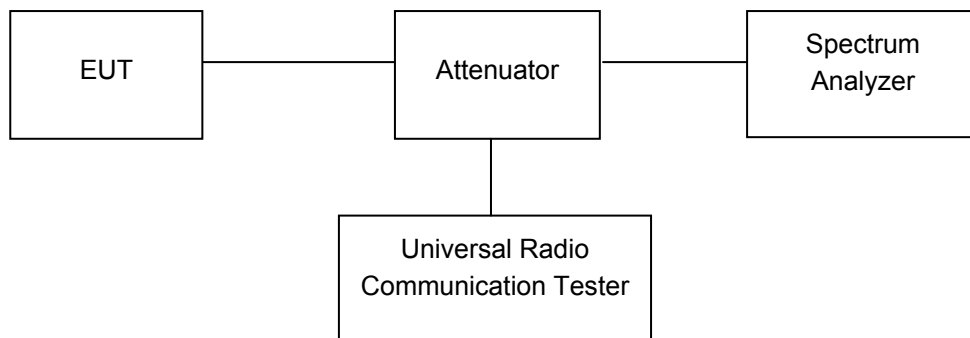

### 12.3 Test Result

Test plots  
Cellular Band (Part 22H)  
GSM 850 band edge-left side

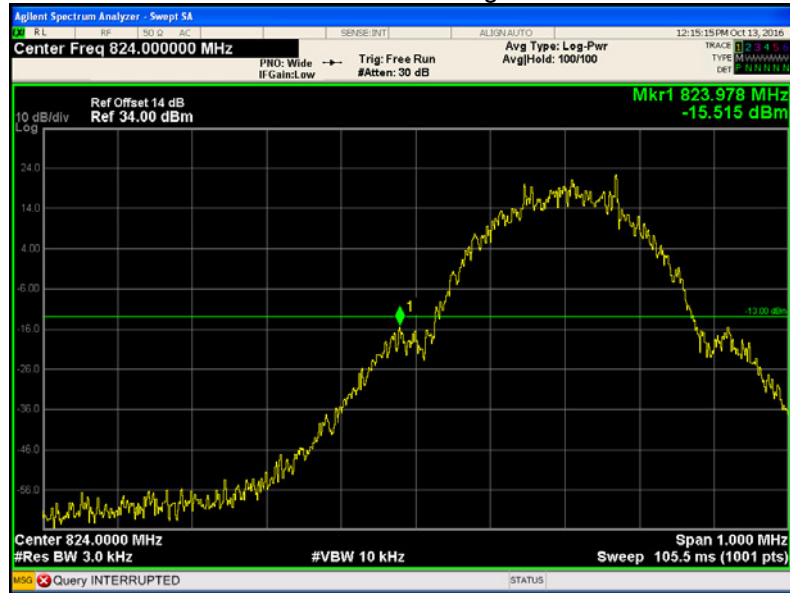

GSM 850 band edge-right side



GPRS 850 band edge-left side

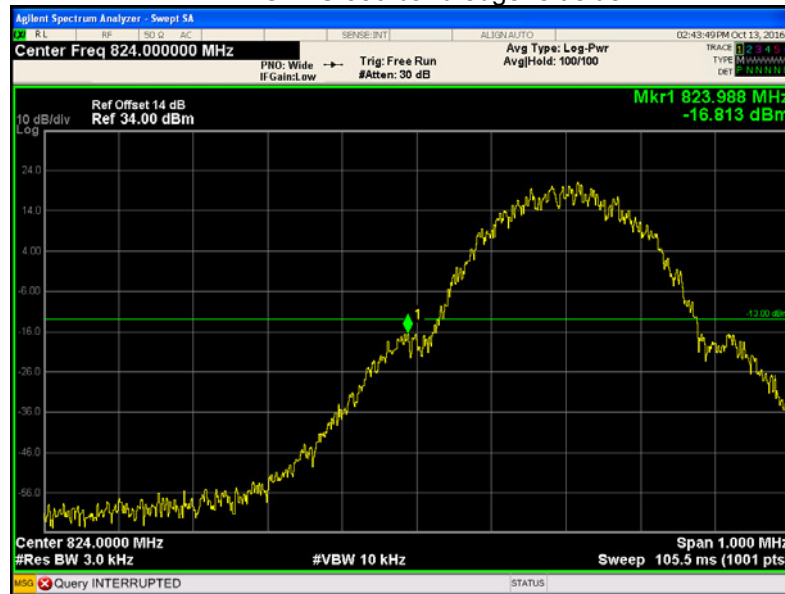

GPRS 850 band edge-right side



Cellular Band (Part 24E)  
PCS 1900 band edge-left side

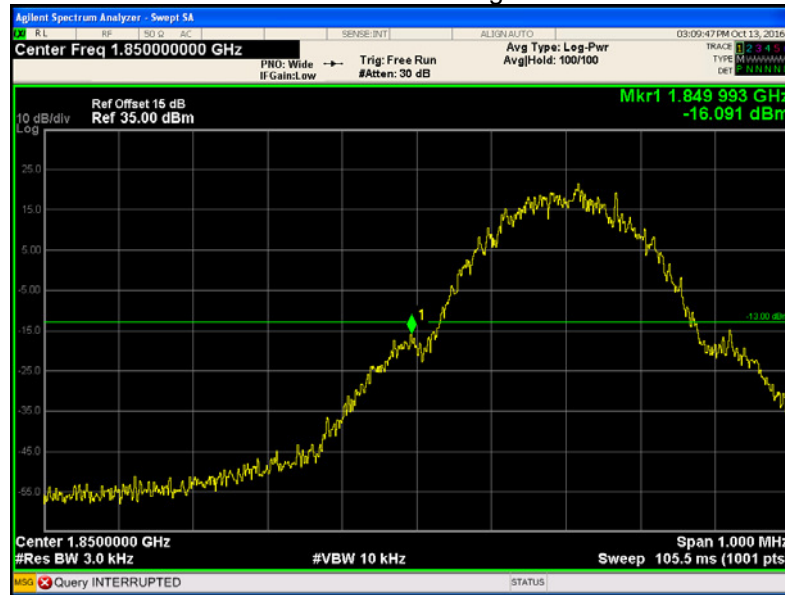

PCS 1900 band edge-right side



GPRS 1900 band edge-left side

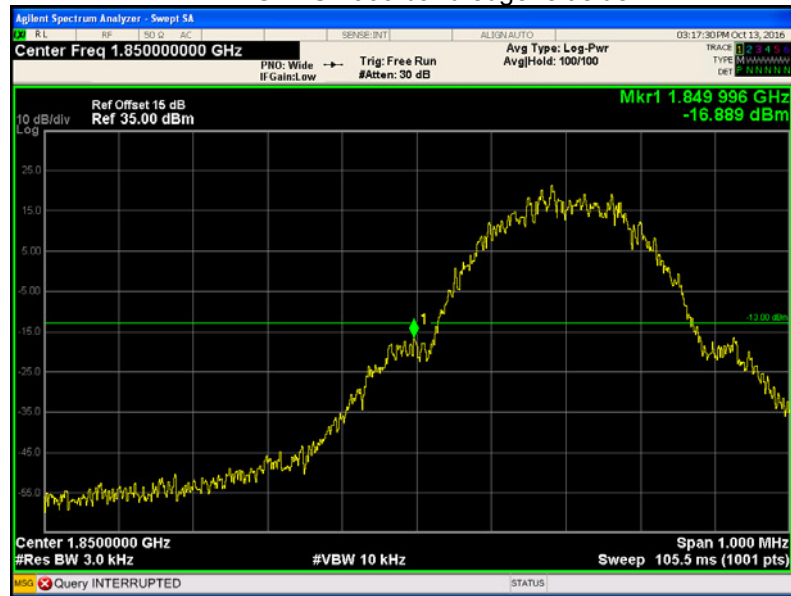

GPRS 1900 band edge-right side

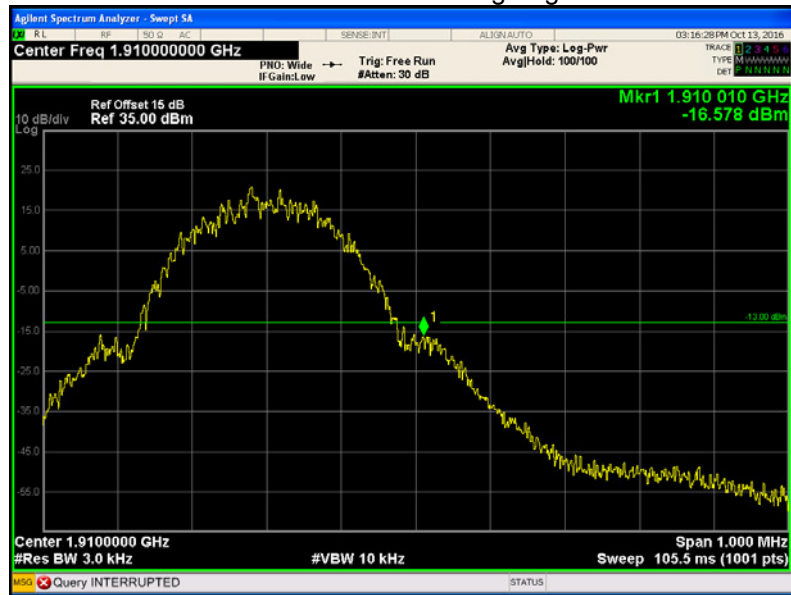

## 13 FREQUENCY STABILITY

Test Requirement:	FCC Part 2.1055,22.355,24.235
Test Method:	TIA/EIA-603-D:2010 KDB971168 D01 v02r02
Test Mode:	Transmitting

### 13.1 EUT Operation

Operating Environment :

Temperature:	22.9 °C
Humidity:	52.0 % RH
Atmospheric Pressure:	101.3kPa

### 13.2 Test Procedure

Frequency Stability vs. Temperature: The equipment under test was connected to an external DC power supply and the RF output was connected to communication test set via feed-through attenuators. The EUT was placed inside the temperature chamber. The DC leads and RF output cable exited the chamber through an opening made for the purpose.

After the temperature stabilized for approximately 20 minutes, the frequency output was recorded from the communication test set.

Frequency Stability vs. Voltage: For hand carried, battery powered equipment; reduce primary supply voltage to the battery operating end point which shall be specified by the manufacturer.

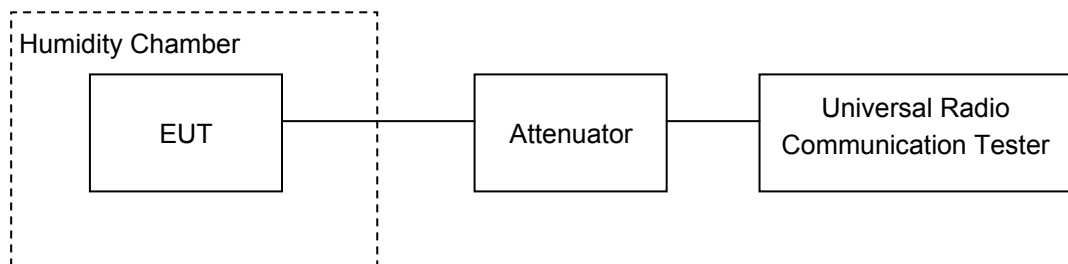

### 13.3 Test Result

Cellular Band (Part 22H)				
GSM 850 Test Frequency:836.6MHz				
Temperature (°C)	Power Supply (VDC)	Frequency Error (Hz)	Frequency Error (ppm)	Limit (ppm)
50	3.7	6	0.0072	2.5
40		8	0.0096	2.5
30		1	0.0012	2.5
20		10	0.0120	2.5
10		6	0.0072	2.5
0		13	0.0155	2.5
-10		7	0.0084	2.5
-20		14	0.0167	2.5
-30		10	0.0120	2.5
20		3.3	15	0.0179
20	4.2	15	0.0179	2.5

GPRS 850 Test Frequency:836.6MHz				
Temperature (°C)	Power Supply (VDC)	Frequency Error (Hz)	Frequency Error (ppm)	Limit (ppm)
50	3.7	5	0.0060	2.5
40		6	0.0072	2.5
30		4	0.0048	2.5
20		6	0.0072	2.5
10		3	0.0036	2.5
0		-2	-0.0024	2.5
-10		12	0.0143	2.5
-20		12	0.0143	2.5
-30		12	0.0143	2.5
20		3.3	9	0.0108
20	4.2	12	0.0143	2.5

## PCS Band (Part 24E)

PCS 1900 Test Frequency:1880.0MHz				
Temperature (°C)	Power Supply (VDC)	Frequency Error (Hz)	Frequency Error (ppm)	Limit (ppm)
50	3.7	24	0.0128	2.5
40		20	0.0106	2.5
30		28	0.0149	2.5
20		23	0.0122	2.5
10		27	0.0144	2.5
0		19	0.0101	2.5
-10		15	0.0080	2.5
-20		16	0.0085	2.5
-30		24	0.0128	2.5
20		3.3	20	0.0106
20	4.2	15	0.0080	2.5

GPRS 1900 Test Frequency:1880.0MHz				
Temperature (°C)	Power Supply (VDC)	Frequency Error (Hz)	Frequency Error (ppm)	Limit (ppm)
50	3.7	13	0.0069	2.5
40		28	0.0149	2.5
30		28	0.0149	2.5
20		21	0.0112	2.5
10		23	0.0122	2.5
0		22	0.0117	2.5
-10		20	0.0106	2.5
-20		16	0.0085	2.5
-30		20	0.0106	2.5
20		3.3	20	0.0106
20	4.2	26	0.0138	2.5

