



FCC Part 15C Test Report

FCC ID: 2AJXDBH-01

Product Name:	Bluetooth Headset
Trademark:	N/A
Model Name :	BH-01 G6, RQ7, RQ8, BH-02, DS-01, DS-02, BH-03, KW-01
Prepared For :	Shenzhen Jieku Technology Co., LTD
Address :	C Block,3floor Honggida Industrial Park, Longsheng Industrial, Baoan District ,Guangdong,China
Prepared By :	Shenzhen BCTC Technology Co., Ltd.
Address :	No.101,Yousong Road,Longhua New District, Shenzhen,China
Test Date:	Sep. 13, - Sep. 20, 2016
Date of Report :	Sep. 20, 2016
Report No.:	BCTC-LH160910815E



TEST RESULT CERTIFICATION

Applicant's name..... : Shenzhen Jieku Technology Co., LTD
Address..... : C Block,3floor Honggida Industrial Park, Longsheng Industrial, Baoan District ,Guangdong,China
Manufacture's Name..... : Shenzhen Jieku Technology Co., LTD
Address..... : C Block,3floor Honggida Industrial Park, Longsheng Industrial, Baoan District ,Guangdong,China

Product description

Product name.....: Bluetooth Headset
Trademark.....: N/A
Model and/or type reference : BH-01
 G6, RQ7, RQ8, BH-02, DS-01, DS-02, BH-03, KW-01

Standards..... : FCC Part15.249
 ANSI C63.10-2013

This device described above has been tested by BCTC, and the test results show that the equipment under test (EUT) is in compliance with the FCC requirements. And it is applicable only to the tested sample identified in the report.

This report shall not be reproduced except in full, without the written approval of BCTC, this document may be altered or revised by BCTC, personal only, and shall be noted in the revision of the document.

Testing Engineer

:

Eric Yang

Eric Yang

Reviewer Supervisor

:

Jade Yang

Jade Yang

Approved & Authorized Manager

:



Carson Zhang

**Table of Contents**

	Page
1 . SUMMARY OF TEST RESULTS	5
1.1 TEST FACILITY	5
1.2 MEASUREMENT UNCERTAINTY	5
2 . GENERAL INFORMATION	6
2.1 GENERAL DESCRIPTION OF EUT	6
2.2 DESCRIPTION OF TEST MODES	7
2.3 BLOCK DIGRAM SHOWING THE CONFIGURATION OF SYSTEM TESTED	8
2.4 DESCRIPTION OF SUPPORT UNITS(CONDUCTED MODE)	8
2.5 EQUIPMENTS LIST FOR ALL TEST ITEMS	9
3 . EMC EMISSION TEST	10
3.1 CONDUCTED EMISSION MEASUREMENT	10
3.1.1 POWER LINE CONDUCTED EMISSION LIMITS	10
3.1.2 TEST PROCEDURE	10
3.1.3 DEVIATION FROM TEST STANDARD	10
3.1.4 TEST SETUP	11
3.1.5 EUT OPERATING CONDITIONS	11
3.1.6 TEST RESULTS	11
3.2 RADIATED EMISSION MEASUREMENT	14
3.2.1 RADIATED EMISSION LIMITS	14
3.2.2 TEST PROCEDURE	15
3.2.3 DEVIATION FROM TEST STANDARD	15
3.2.4 TEST SETUP	15
3.2.5 EUT OPERATING CONDITIONS	16
3.2.6 TEST RESULTS (BETWEEN 9KHZ – 30 MHZ)	17
3.2.7 TEST RESULTS (BETWEEN 30MHZ – 1GHZ)	18
3.2.8 TEST RESULTS (1GHZ~25GHZ)	20
3.3 RADIATED BAND EMISSION MEASUREMENT	23
3.3.1 TEST REQUIREMENT:	23
3.3.2 TEST PROCEDURE	23
3.3.3 DEVIATION FROM TEST STANDARD	24
3.3.4 TEST SETUP	24
3.3.5 EUT OPERATING CONDITIONS	24
4 . BANDWIDTH TEST	28
4.1 APPLIED PROCEDURES / LIMIT	28
4.1.1 TEST PROCEDURE	28



	Page
4.1.2 DEVIATION FROM STANDARD	28
4.1.3 TEST SETUP	28
4.1.4 EUT OPERATION CONDITIONS	28
4.1.5 TEST RESULTS	29
5 . ANTENNA REQUIREMENT	34
5.1 STANDARD REQUIREMENT	34
5.2 EUT ANTENNA	34
6 . TEST SEUUP PHOTO	35
7 . EUT PHOTO	37



1. SUMMARY OF TEST RESULTS

Test procedures according to the technical standards:

FCC Part15 (15.249) , Subpart C			
Standard Section	Test Item	Judgment	Remark
15.207	Conducted Emission	PASS	
15.249	Radiated Spurious Emission	PASS	
15.249	Bandwidth	PASS	
15.205	Band Edge Emission	PASS	
15.203	Antenna Requirement	PASS	

NOTE:

(1) "N/A" denotes test is not applicable in this Test Report

1.1 TEST FACILITY

Shenzhen BCTC Technology Co., Ltd.

Add. : No.101,Yousong Road,Longhua New District, Shenzhen,China

FCC Registered No.: 187086

1.2 MEASUREMENT UNCERTAINTY

The reported uncertainty of measurement $y \pm U$, where expended uncertainty U is based on a standard uncertainty multiplied by a coverage factor of $k=2$, providing a level of confidence of approximately **95** %.

No.	Item	Uncertainty
1	Conducted Emission Test	$\pm 1.38\text{dB}$
2	RF power,conducted	$\pm 0.16\text{dB}$
3	Spurious emissions,conducted	$\pm 0.21\text{dB}$
4	All emissions,radiated(<1G)	$\pm 4.68\text{dB}$
5	All emissions,radiated(>1G)	$\pm 4.89\text{dB}$
6	Temperature	$\pm 0.5^{\circ}\text{C}$
7	Humidity	$\pm 2\%$



2. GENERAL INFORMATION

2.1 GENERAL DESCRIPTION OF EUT

Equipment	Bluetooth Headset	
Trademark	N/A	
Model Name	BH-01 G6, RQ7, RQ8, BH-02, DS-01, DS-02, BH-03, KW-01	
Model Difference	The product's different for model number.	
Product Description	The EUT is a Bluetooth Headset	
	Operation Frequency:	2402~2480 MHz
	Modulation Type:	GFSK,PI/4 DPSK,8DPSK
	Bit Rate of Transmitter	1/2/3Mbps
	Number Of Channel	79 CH
	Antenna type:	Internal Antenna
	Antenna Gain (dBi)	1.5dBi
	Based on the application, features, or specification exhibited in User's Manual, the EUT is considered as an ITE/Computing Device. More details of EUT technical specification, please refer to the User's Manual.	
Channel List	Please refer to the Note 2.	
Power	DC 3.7V DC 5V from USB	
hardware version	--	
Software version	--	
Serial number	--	
Connecting I/O Port(s)	Please refer to the User's Manual	

Note:

1. For a more detailed features description, please refer to the manufacturer's specifications or the User's Manual.



2.

Channel List					
Channel	Frequency (MHz)	Channel	Frequency (MHz)	Channel	Frequency (MHz)
00	2402	27	2429	54	2456
01	2403	28	2430	55	2457
02	2404	29	2431	56	2458
~	~	~	~	~	~
08	2410	35	2437	62	2464
09	2411	36	2438	63	2465
10	2412	37	2439	64	2466
11	2413	38	2440	65	2467
12	2414	39	2441	66	2468
13	2415	40	2442	67	2469
~	~	~	~	~	~
14	2416	41	2443	68	2470
22	2424	49	2451	76	2478
23	2425	50	2452	77	2479
24	2426	51	2453	78	2480
25	2427	52	2454		
26	2428	53	2455		

2.2 DESCRIPTION OF TEST MODES

To investigate the maximum EMI emission characteristics generated from EUT, the test system was pre-scanning tested based on the consideration of following EUT operation mode or test configuration mode which possibly have effect on EMI emission level. Each of these EUT operation mode(s) or test configuration mode(s) mentioned above was evaluated respectively.

Test Mode	Description	
Mode 1	CH00	GFSK,PI/4 DPSK,8DPSK
Mode 2	CH39	
Mode 3	CH78	
Mode 4	Link Mode	

Note:

(1) The measurements are performed at the highest, middle, lowest available channels.



2.3 BLOCK DIGRAM SHOWING THE CONFIGURATION OF SYSTEM TESTED

Radiated Spurious Emission Test

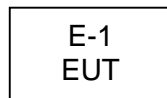

Conducted Spurious Emission Test

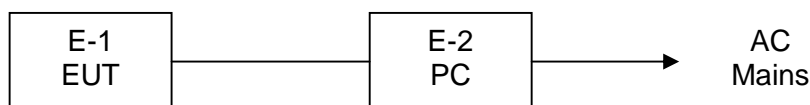

2.4 DESCRIPTION OF SUPPORT UNITS(CONDUCTED MODE)

The EUT has been tested as an independent unit together with other necessary accessories or support units. The following support units or accessories were used to form a representative test configuration during the tests.

Item	Equipment	Mfr/Brand	Model/Type No.	Series No.	Note
E-1	Bluetooth Headset	N/A	BH-01	N/A	EUT
E-2	PC	ASUS	AWT8000	N/A	

Item	Shielded Type	Ferrite Core	Length	Note
C-1	NO	NO	0.8M	Mini USB cable

Note:

- (1) The support equipment was authorized by Declaration of Confirmation.
- (2) For detachable type I/O cable should be specified the length in cm in 『Length』 column.



2.5 EQUIPMENTS LIST FOR ALL TEST ITEMS

Radiation Test equipment

Item	Kind of Equipment	Manufacturer	Type No.	Serial No.	Last calibration	Calibrated until
1	Spectrum Analyzer	Agilent	E4407B	MY45109572	2016.08.27	2017.08.26
2	Test Receiver	R&S	ESPI	101396	2016.08.27	2017.08.26
3	Bilog Antenna	SCHWARZBECK	VULB9160	VULB9160-3369	2016.08.27	2017.08.26
4	50Ω Coaxial Switch	Anritsu	MP59B	6200264416	2016.08.27	2017.08.26
5	Spectrum Analyzer	Agilent	N9020A	MY5051041	2016.08.27	2017.08.26
6	Horn Antenna	SCHWARZBECK	9120D	9120D-1275	2016.08.27	2017.08.26
7	Horn Ant	Schwarzbeck	BBHA 9170	9170-181	2016.09.03	2017.09.02
8	Amplifier	SCHWARZBECK	BBV9718	9718-270	2016.08.27	2017.08.26
9	Amplifier	SCHWARZBECK	BBV9743	9743-119	2016.08.27	2017.08.26
10	Loop Antenna	ARA	PLES130/B	1029	2016.09.04	2017.09.03
11	Power Meter	R&S	NRVS	100696	2016.08.27	2017.08.26
12	Power Sensor	R&S	URV5-Z4	0395.1619.05	2016.08.27	2017.08.26
13	RF cables	R&S	N/A	N/A	2016.08.27	2017.08.26

Conduction Test equipment

Item	Kind of Equipment	Manufacturer	Type No.	Serial No.	Last calibration	Calibrated until
1	Test Receiver	R&S	ESCI	1166.5950K03-101165-ha	2016.08.27	2017.08.26
2	LISN	R&S	NSLK8126	8126466	2016.08.27	2017.08.26
3	LISN	R&S	NSLK8126	8126487	2016.08.27	2017.08.26
4	50Ω Coaxial Switch	Anritsu	MP59B	6200264417	2016.08.27	2017.08.26
5	RF cables	R&S	R204	R20X	2016.08.27	2017.08.26



3. EMC EMISSION TEST

3.1 CONDUCTED EMISSION MEASUREMENT

3.1.1 POWER LINE CONDUCTED EMISSION Limits (Frequency Range 150KHz-30MHz)

FREQUENCY (M z)	Class A (dBuV)		Class B (dBuV)		Standard
	Quasi-peak	Average	Quasi-peak	Average	
0.15 -0.5	79.00	66.00	66 - 56 *	56 - 46 *	FCC
0.50 -5.0	73.00	60.00	56.00	46.00	FCC
5.0 -30.0	73.00	60.00	60.00	50.00	FCC

Note:

- (1) The tighter limit applies at the band edges.
- (2) The limit of " * " marked band means the limitation decreases linearly with the logarithm of the frequency in the range.

The following table is the setting of the receiver

Receiver Parameters	Setting
Attenuation	10 dB
Start Frequency	0.15 MHz
Stop Frequency	30 MHz
IF Bandwidth	9 kHz

3.1.2 TEST PROCEDURE

- a. The EUT was placed 0.8 meters from the horizontal ground plane with EUT being connected to the power mains through a line impedance stabilization network (LISN). All other support equipments powered from additional LISN(s). The LISN provide 50 Ohm/ 50uH of coupling impedance for the measuring instrument.
- b. Interconnecting cables that hang closer than 40 cm to the ground plane shall be folded back and forth in the center forming a bundle 30 to 40 cm long.
- c. I/O cables that are not connected to a peripheral shall be bundled in the center. The end of the cable may be terminated, if required, using the correct terminating impedance. The overall length shall not exceed 1 m.
- d. LISN at least 80 cm from nearest part of EUT chassis.
- e. For the actual test configuration, please refer to the related Item –EUT Test Photos.

3.1.3 DEVIATION FROM TEST STANDARD

No deviation

3.1.4 TEST SETUP

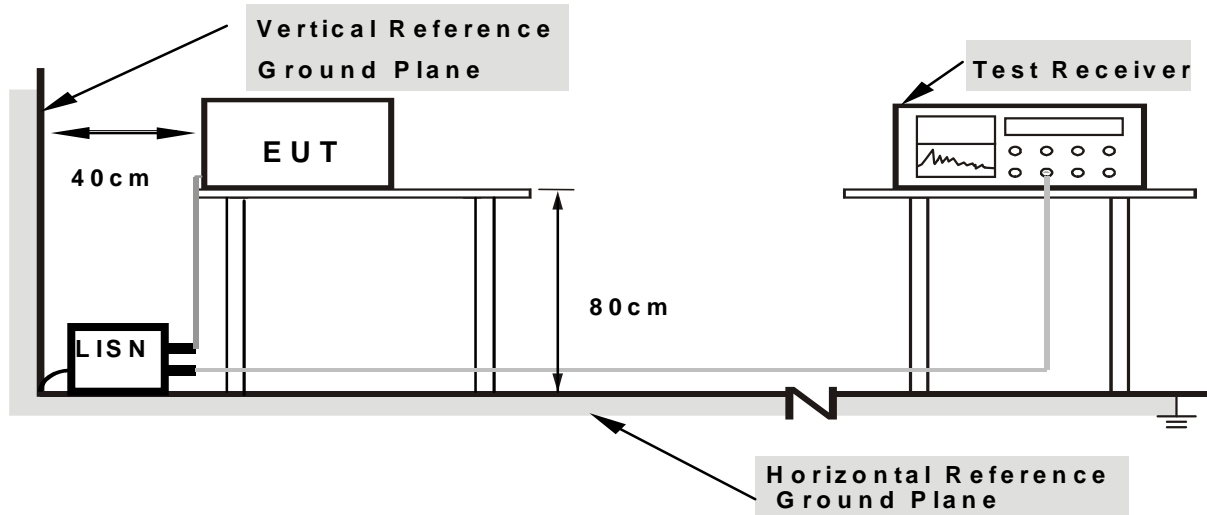

Note: 1.Support units were connected to second LISN.

2.Both of LISNs (AMN) are 80 cm from EUT and at least 80 from other units and other metal planes

3.1.5 EUT OPERATING CONDITIONS

The EUT was configured for testing in a typical fashion (as a customer would normally use it). The EUT has been programmed to continuously transmit during test. This operating condition was tested and used to collect the included data.

3.1.6 TEST RESULTS



Temperature :	25 °C	Relative Humidity :	54%
Pressure :	1010hPa	Phase :	L
Test Voltage :	DC 5V from PC input AC 120V/60Hz	Test Mode :	Mode 4

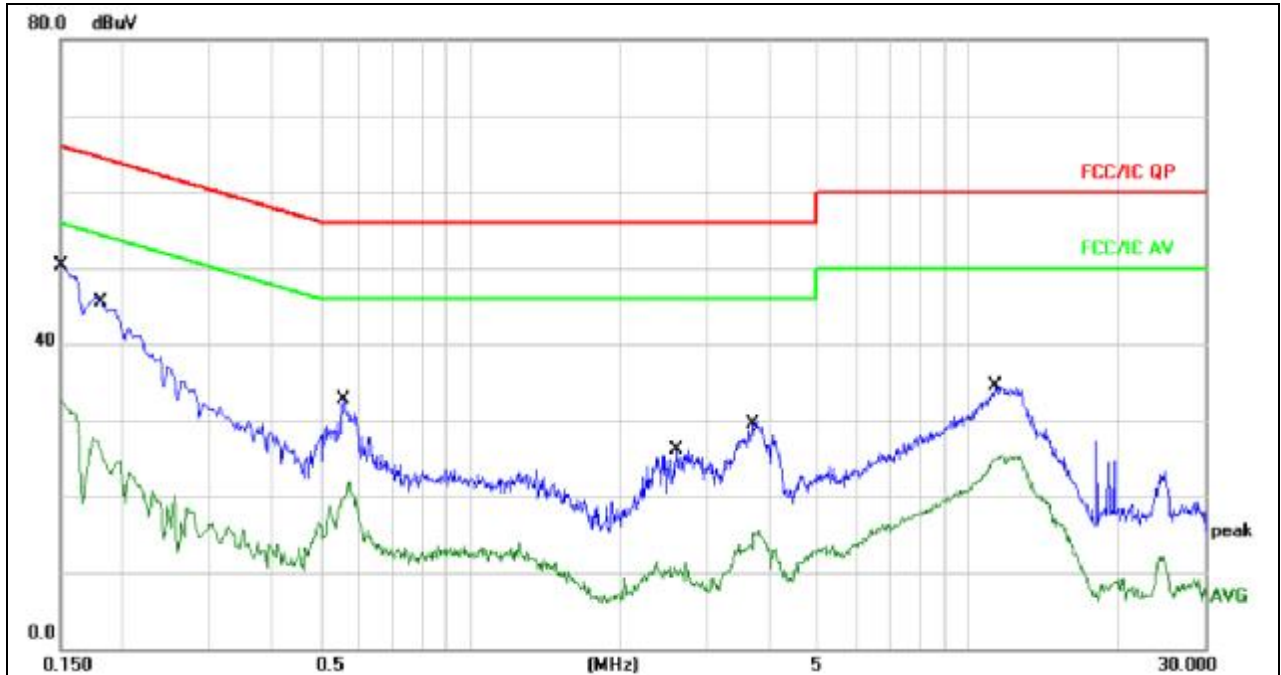

Remark:

1. All readings are Quasi-Peak and Average values.
2. Factor = Insertion Loss + Cable Loss.

No.	Mk.	Freq. MHz	Reading Level dBuV	Correct Factor dB	Measurement dBuV	Limit dBuV	Over dB	Detector	Comment
1	*	0.1500	40.32	10.05	50.37	65.99	-15.62	QP	
2		0.1500	22.58	10.05	32.63	55.99	-23.36	AVG	
3		0.1835	34.57	10.06	44.63	64.32	-19.69	QP	
4		0.1835	14.90	10.06	24.96	54.32	-29.36	AVG	
5		0.5580	22.67	10.12	32.79	56.00	-23.21	QP	
6		0.5580	9.74	10.12	19.86	46.00	-26.14	AVG	
7		2.6220	15.88	10.19	26.07	56.00	-29.93	QP	
8		2.6220	-0.56	10.19	9.63	46.00	-36.37	AVG	
9		3.7060	19.67	10.17	29.84	56.00	-26.16	QP	
10		3.7060	4.89	10.17	15.06	46.00	-30.94	AVG	
11		11.3660	24.29	10.13	34.42	60.00	-25.58	QP	
12		11.3660	14.69	10.13	24.82	50.00	-25.18	AVG	



Temperature :	25 °C	Relative Humidity :	54%
Pressure :	1010hPa	Phase :	N
Test Voltage :	DC 5V from PC input AC 120V/60Hz	Test Mode :	Mode 4

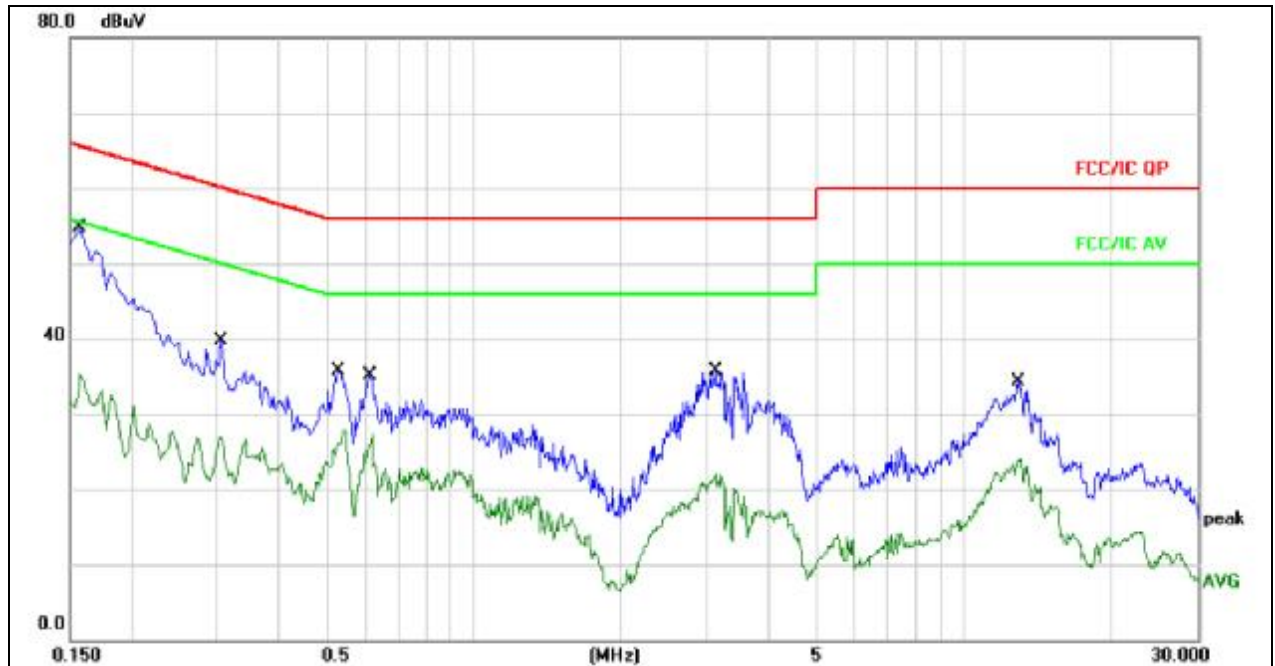

Remark:

1. All readings are Quasi-Peak and Average values.
2. Factor = Insertion Loss + Cable Loss.

No.	Mk.	Freq.	Reading Level	Correct Factor	Measurement	Limit	Over	Detector	Comment
		MHz	dBuV	dB	dBuV	dBuV	dB		
1	*	0.1580	44.56	10.05	54.61	65.56	-10.95	QP	
2		0.1580	25.25	10.05	35.30	55.56	-20.26	AVG	
3		0.3060	29.58	10.09	39.67	60.08	-20.41	QP	
4		0.3060	16.23	10.09	26.32	50.08	-23.76	AVG	
5		0.5299	25.68	10.12	35.80	56.00	-20.20	QP	
6		0.5299	15.91	10.12	26.03	46.00	-19.97	AVG	
7		0.6108	24.92	10.13	35.05	56.00	-20.95	QP	
8		0.6108	15.79	10.13	25.92	46.00	-20.08	AVG	
9		3.1099	25.46	10.19	35.65	56.00	-20.35	QP	
10		3.1099	10.73	10.19	20.92	46.00	-25.08	AVG	
11		12.8380	24.09	10.14	34.23	60.00	-25.77	QP	
12		12.8380	13.44	10.14	23.58	50.00	-26.42	AVG	



3.2 RADIATED EMISSION MEASUREMENT

3.2.1 RADIATED EMISSION LIMITS (Frequency Range 9kHz-1000MHz)

In case the emission fall within the restricted band specified on 15.205(a), then the 15.209(a) limit in the table below has to be followed.

Frequencies (MHz)	Field Strength (micorvolts/meter)	Measurement Distance (meters)
0.009~0.490	2400/F(KHz)	300
0.490~1.705	24000/F(KHz)	30
1.705~30.0	30	30
30~88	100	3
88~216	150	3
216~960	200	3
Above 960	500	3

LIMITS OF RADIATED EMISSION MEASUREMENT (Above 1000MHz)

FREQUENCY (MHz)	Class B (dBuV/m) (at 3M)	
	PEAK	AVERAGE
Above 1000	74	54

Notes:

- (1) The limit for radiated test was performed according to FCC PART 15C.
- (2) The tighter limit applies at the band edges.
- (3) Emission level (dBuV/m)=20log Emission level (uV/m).

Spectrum Parameter	Setting
Attenuation	Auto
Start Frequency	1000 MHz
Stop Frequency	25GHz
RB / VB (emission in restricted band)	1 MHz / 1 MHz for Peak, 1 MHz / 10Hz for Average

Receiver Parameter	Setting
Attenuation	Auto
Start ~ Stop Frequency	9kHz~150kHz / RB 200Hz for QP
Start ~ Stop Frequency	150kHz~30MHz / RB 9kHz for QP
Start ~ Stop Frequency	30MHz~1000MHz / RB 120kHz for QP

3.2.2 TEST PROCEDURE

Below 1GHz test procedure as below:

- a. The EUT was placed on the top of a rotating table 0.8 meters above the ground at a 3 meter semi-anechoic chamber. The table was rotated 360 degrees to determine the position of the highest radiation.
- b. The EUT was set 3 meters away from the interference-receiving antenna, which was mounted on the top of a variable-height antenna tower.
- c. The antenna height is varied from one meter to four meters above the ground to determine the maximum value of the field strength. Both horizontal and vertical polarizations of the antenna are set to make the measurement.
- d. For each suspected emission, the EUT was arranged to its worst case and then the antenna was tuned to heights from 1 meter to 4 meters (for the test frequency of below 30MHz, the antenna was tuned to heights 1 meter) and the rotatable table was turned from 0 degrees to 360 degrees to find the maximum reading.
- e. The test-receiver system was set to Peak Detect Function and Specified Bandwidth with Maximum Hold Mode.
- f. If the emission level of the EUT in peak mode was 10dB lower than the limit specified, then testing could be stopped and the peak values of the EUT would be reported. Otherwise the emissions that did not have 10dB margin would be re-tested one by one using peak, quasi-peak or average method as specified and then reported in a data sheet.

Above 1GHz test procedure as below:

- g. Different between above is the test site, change from Semi- Anechoic Chamber to fully Anechoic Chamber and change form table 0.8 metre to 1.5 metre(Above 18GHz the distance is 1 meter and table is 1.5 metre).
- h. Test the EUT in the lowest channel ,the middle channel ,the Highest channel

Note:

Both horizontal and vertical antenna polarities were tested and performed pretest to three orthogonal axis. The worst case emissions were reported

3.2.3 DEVIATION FROM TEST STANDARD

No deviation

3.2.4 TEST SETUP

(A) Radiated Emission Test-Up Frequency Below 30MHz

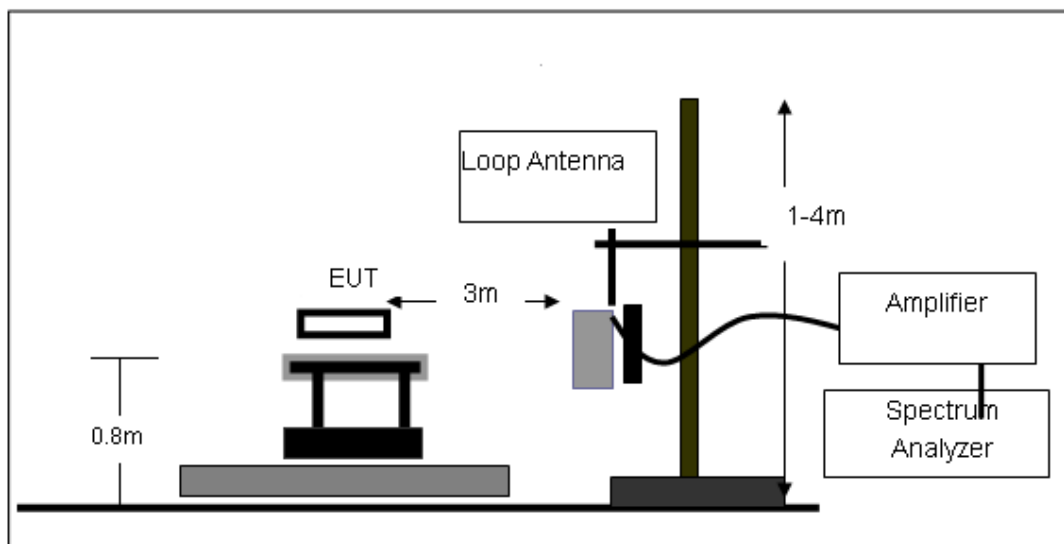

(B) Radiated Emission Test-Up Frequency 30MHz~1GHz

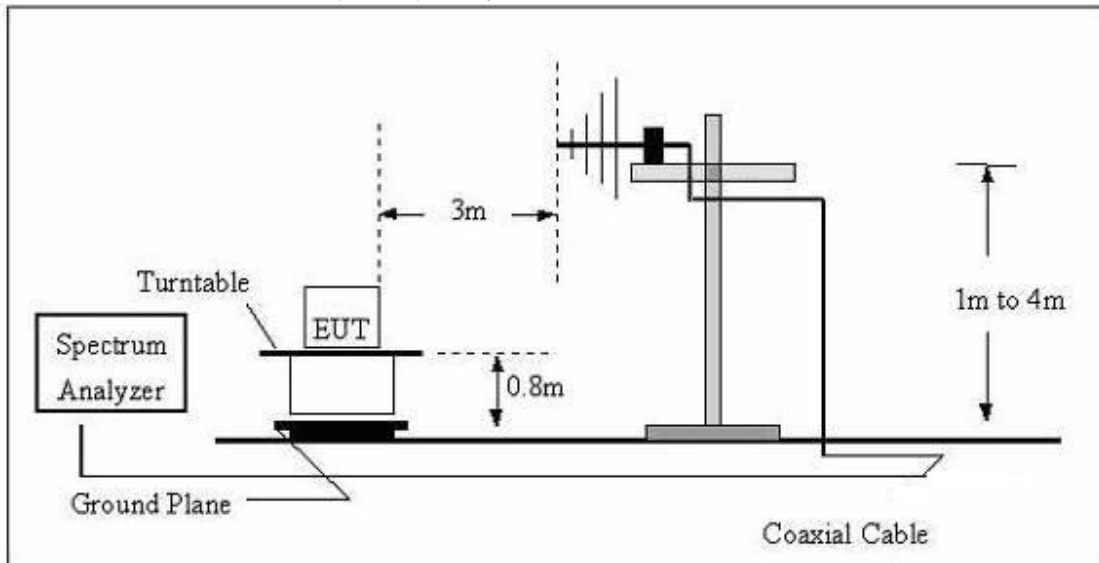

(C) Radiated Emission Test-Up Frequency Above 1GHz

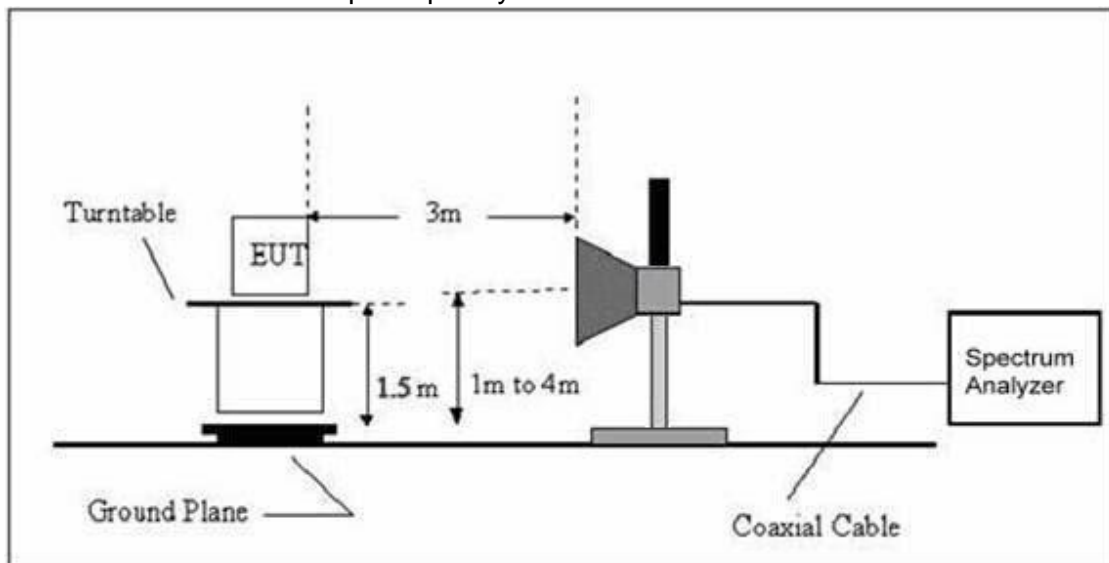

3.2.5 EUT OPERATING CONDITIONS

The EUT tested system was configured as the statements of 2.3 Unless otherwise a special operating condition is specified in the follows during the testing.

**3.2.6 TEST RESULTS (BETWEEN 9KHZ – 30 MHZ)**

Temperature:	20°C	Relative Humidity:	48%
Pressure:	1010 hPa	Test Voltage :	DC 3.7V
Test Mode :	Mode 4	Polarization :	--

Freq. (MHz)	Reading (dBuV/m)	Limit (dBuV/m)	Margin (dB)	State P/F
--	--	--	--	PASS
--	--	--	--	PASS

NOTE:

The amplitude of spurious emissions which are attenuated by more than 20dB below the permissible value has no need to be reported.

Distance extrapolation factor = $40 \log(\text{specific distance}/\text{test distance})$ (dB);

Limit line = specific limits(dBuv) + distance extrapolation factor.



3.2.7 TEST RESULTS (BETWEEN 30MHZ – 1GHZ)

Temperature :	26°C	Relative Humidity :	54%
Pressure :	1010 hPa	Polarization :	Horizontal
Test Voltage :	DC 3.7V		
Test Mode :	Mode 4		

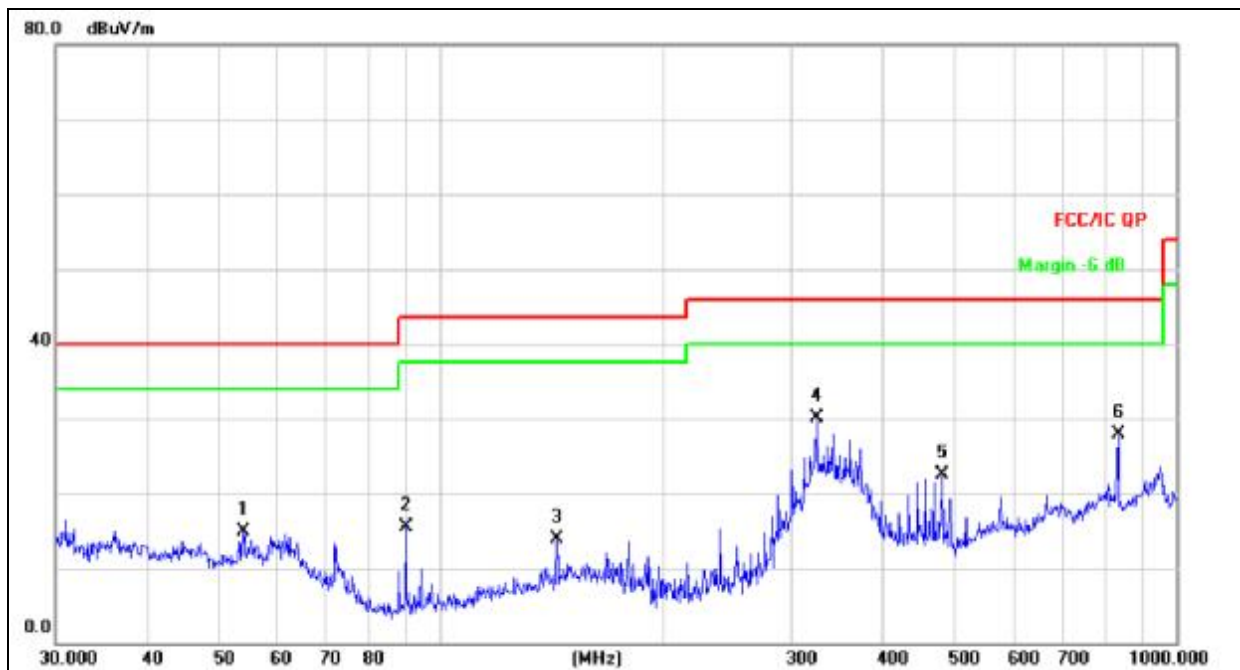

Remark:
Factor = Antenna Factor + Cable Loss – Pre-amplifier.

No.	Mk.	Freq.	Reading Level	Correct Factor	Measurement	Limit	Over	Antenna Height	Table Degree	
		MHz	dBuV	dB/m	dBuV/m	dBuV/m	dB	cm	degree	Comment
1		53.8818	25.81	-10.93	14.88	40.00	-25.12			QP
2		89.5899	33.03	-17.55	15.48	43.50	-28.02			QP
3		143.8295	27.08	-13.18	13.90	43.50	-29.60			QP
4	*	324.4561	42.11	-11.95	30.16	46.00	-15.84			QP
5		480.5276	30.88	-8.42	22.46	46.00	-23.54			QP
6		833.3171	30.04	-2.22	27.82	46.00	-18.18			QP



Temperature :	26°C	Relative Humidity :	54%
Pressure :	1010 hPa	Polarization :	Vertical
Test Voltage :	DC 3.7V		
Test Mode :	Mode 4		

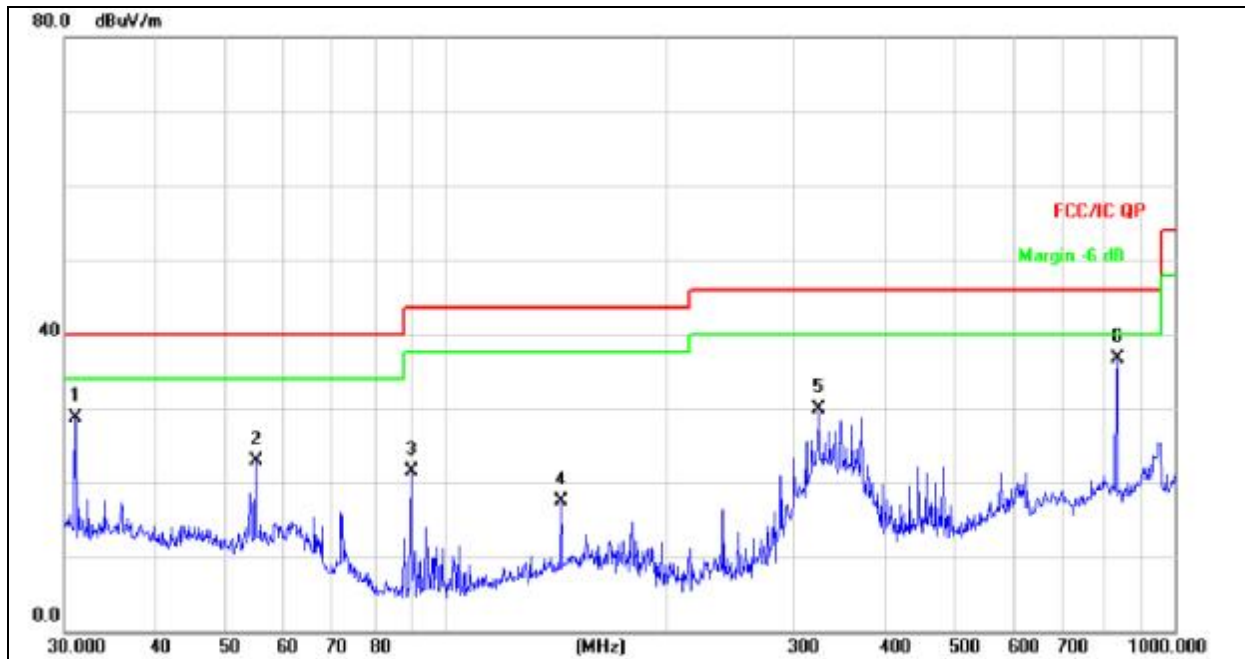

Remark:
Factor = Antenna Factor + Cable Loss – Pre-amplifier.

No.	Mk.	Freq. MHz	Reading Level dBuV	Correct Factor dB/m	Measure- ment dBuV/m	Limit dBuV/m	Over dB	Detector	Antenna Height cm	Table Degree	Comment
1		31.0706	36.94	-8.17	28.77	40.00	-11.23	QP			
2		54.8348	34.00	-11.10	22.90	40.00	-17.10	QP			
3		89.5899	39.00	-17.55	21.45	43.50	-22.05	QP			
4		143.8295	30.60	-13.18	17.42	43.50	-26.08	QP			
5		324.4561	41.82	-11.95	29.87	46.00	-16.13	QP			
6	*	833.3171	38.92	-2.22	36.70	46.00	-9.30	QP			



3.2.8 TEST RESULTS (1GHZ~25GHZ)

GFSK

Polar (H/V)	Frequency	Meter Reading	Pre-amplifier	Cable Loss	Antenna Factor	Emission Level	Limits	Margin	Detector Type
	(MHz)	(dBuV)	(dB)	(dB)	(dB/m)	(dBuV/m)	(dBuV/m)	(dB)	
operation frequency:2402									
V	2402.00	110.37	38.06	7.42	20.15	99.88	114.00	-14.12	PK
V	2402.00	98.07	38.06	7.42	20.15	87.58	94.00	-6.42	AV
V	4804.00	59.54	38.53	7.78	23.25	52.04	74.00	-21.96	PK
V	4804.00	45.87	38.53	7.78	23.25	38.37	54.00	-15.63	AV
V	16132.00	50.09	38.75	10.36	26.57	48.27	74.00	-25.73	PK
H	2402.00	111.34	38.06	7.42	20.15	100.85	114.00	-13.15	PK
H	2402.00	97.66	38.06	7.42	20.15	87.17	94.00	-6.83	AV
H	4804.00	60.37	38.53	7.78	23.25	52.87	74.00	-21.13	PK
H	4804.00	45.75	38.53	7.78	23.25	38.25	54.00	-15.75	AV
H	16132.00	49.83	38.75	10.36	26.57	48.01	74.00	-25.99	PK
operation frequency:2440									
V	2440.00	110.87	38.11	7.42	20.36	100.54	114.00	-13.46	PK
V	2440.00	98.22	38.11	7.42	20.36	87.89	94.00	-6.11	AV
V	4880.00	60.47	38.65	7.78	23.61	53.21	74.00	-20.79	PK
V	4880.00	45.91	38.65	7.78	23.61	38.65	54.00	-15.35	AV
V	16132.00	48.34	38.75	10.36	26.57	46.52	74.00	-27.48	PK
H	2440.00	110.89	38.11	7.42	20.36	100.56	114.00	-13.44	PK
H	2440.00	98.09	38.11	7.42	20.36	87.76	94.00	-6.24	AV
H	4880.00	61.54	38.65	7.78	23.61	54.28	74.00	-19.72	PK
H	4880.00	46.63	38.65	7.78	23.61	39.37	54.00	-14.63	AV
H	16132.00	50.00	38.75	10.36	26.57	48.18	74.00	-25.82	PK
operation frequency:2480									
V	2480.00	111.92	38.17	7.42	20.51	101.68	114.00	-12.32	PK
V	2480.00	99.31	38.17	7.42	20.51	89.07	94.00	-4.93	AV
V	4960.00	61.29	38.69	7.78	23.83	54.21	74.00	-19.79	PK
V	4960.00	46.19	38.69	7.78	23.83	39.11	54.00	-14.89	AV
V	16132.00	50.22	38.75	10.36	26.57	48.4	74.00	-25.6	PK
H	2480.00	110.95	38.17	7.42	20.51	100.71	114.00	-13.29	PK
H	2480.00	99.17	38.17	7.42	20.51	88.93	94.00	-5.07	AV
H	4960.00	61.49	38.69	7.78	23.83	54.41	74.00	-19.59	PK
H	4960.00	46.22	38.69	7.78	23.83	39.14	54.00	-14.86	AV
H	16132.00	50.54	38.75	10.36	26.57	48.72	74.00	-25.28	PK
Remark:									
1. Emission Level = Meter Reading + Antenna Factor + Cable Loss – Pre-amplifier, Margin= Emission Level - Limit									
2. If peak below the average limit, the average emission was no test.									
3. The amplitude of spurious emissions which are attenuated by more than 20dB below the permissible value has no need to be reported.									



PI/4 DPSK

Polar (H/V)	Frequency	Meter Reading	Pre-amplifier	Cable Loss	Antenna Factor	Emission Level	Limits	Margin	Detector Type
	(MHz)	(dBuV)	(dB)	(dB)	(dB/m)	(dBuV/m)	(dBuV/m)	(dB)	
operation frequency:2402									
V	2402.00	110.40	38.06	7.42	20.15	99.91	114.00	-14.09	PK
V	2402.00	97.24	38.06	7.42	20.15	86.75	94.00	-7.25	AV
V	4804.00	59.01	38.53	7.78	23.25	51.51	74.00	-22.49	PK
V	4804.00	45.46	38.53	7.78	23.25	37.96	54.00	-16.04	AV
V	16132.00	49.65	38.75	10.36	26.57	47.83	74.00	-26.17	PK
H	2402.00	110.37	38.06	7.42	20.15	99.88	114.00	-14.12	PK
H	2402.00	97.83	38.06	7.42	20.15	87.34	94.00	-6.66	AV
H	4804.00	59.83	38.53	7.78	23.25	52.33	74.00	-21.67	PK
H	4804.00	45.34	38.53	7.78	23.25	37.84	54.00	-16.16	AV
H	16132.00	49.39	38.75	10.36	26.57	47.57	74.00	-26.43	PK
operation frequency:2440									
V	2440.00	110.90	38.11	7.42	20.36	100.57	114.00	-13.43	PK
V	2440.00	97.38	38.11	7.42	20.36	87.05	94.00	-6.95	AV
V	4880.00	59.93	38.65	7.78	23.61	52.67	74.00	-21.33	PK
V	4880.00	45.50	38.65	7.78	23.61	38.24	54.00	-15.76	AV
V	16132.00	47.91	38.75	10.36	26.57	46.09	74.00	-27.91	PK
H	2440.00	110.92	38.11	7.42	20.36	100.59	114.00	-13.41	PK
H	2440.00	98.25	38.11	7.42	20.36	87.92	94.00	-6.08	AV
H	4880.00	60.98	38.65	7.78	23.61	53.72	74.00	-20.28	PK
H	4880.00	46.22	38.65	7.78	23.61	38.96	54.00	-15.04	AV
H	16132.00	49.56	38.75	10.36	26.57	47.74	74.00	-26.26	PK
operation frequency:2480									
V	2480.00	110.95	38.17	7.42	20.51	100.71	114.00	-13.29	PK
V	2480.00	92.45	38.17	7.42	20.51	82.21	94.00	-11.79	AV
V	4960.00	60.74	38.69	7.78	23.83	53.66	74.00	-20.34	PK
V	4960.00	45.78	38.69	7.78	23.83	38.7	54.00	-15.30	AV
V	16132.00	49.78	38.75	10.36	26.57	47.96	74.00	-26.04	PK
H	2480.00	110.98	38.17	7.42	20.51	100.74	114.00	-13.26	PK
H	2480.00	98.34	38.17	7.42	20.51	88.1	94.00	-5.90	AV
H	4960.00	60.93	38.69	7.78	23.83	53.85	74.00	-20.15	PK
H	4960.00	45.81	38.69	7.78	23.83	38.73	54.00	-15.27	AV
H	16132.00	50.09	38.75	10.36	26.57	48.27	74.00	-25.73	PK

Remark:

1. Emission Level = Meter Reading + Antenna Factor + Cable Loss – Pre-amplifier,
Margin= Emission Level - Limit
2. If peak below the average limit, the average emission was no test.
3. The amplitude of spurious emissions which are attenuated by more than 20dB below the permissible value has no need to be reported.



8DPSK

Polar (H/V)	Frequency	Meter Reading	Pre-amplifier	Cable Loss	Antenna Factor	Emission Level	Limits	Margin	Detector Type
	(MHz)	(dBuV)	(dB)	(dB)	(dB/m)	(dBuV/m)	(dBuV/m)	(dB)	
operation frequency:2402									
V	2402.00	110.72	38.06	7.42	20.15	100.23	114.00	-13.77	PK
V	2402.00	97.36	38.06	7.42	20.15	86.87	94.00	-7.13	AV
V	4804.00	59.73	38.53	7.78	23.25	52.23	74.00	-21.77	PK
V	4804.00	46.02	38.53	7.78	23.25	38.52	54.00	-15.48	AV
V	16132.00	50.25	38.75	10.36	26.57	48.43	74.00	-25.57	PK
H	2402.00	108.69	38.06	7.42	20.15	98.2	114.00	-15.80	PK
H	2402.00	93.96	38.06	7.42	20.15	83.47	94.00	-10.53	AV
H	4804.00	60.56	38.53	7.78	23.25	53.06	74.00	-20.94	PK
H	4804.00	45.90	38.53	7.78	23.25	38.4	54.00	-15.60	AV
H	16132.00	49.99	38.75	10.36	26.57	48.17	74.00	-25.83	PK
operation frequency:2440									
V	2440.00	110.22	38.11	7.42	20.36	99.89	114.00	-14.11	PK
V	2440.00	97.50	38.11	7.42	20.36	87.17	94.00	-6.83	AV
V	4880.00	60.66	38.65	7.78	23.61	53.4	74.00	-20.60	PK
V	4880.00	46.06	38.65	7.78	23.61	38.8	54.00	-15.20	AV
V	16132.00	48.50	38.75	10.36	26.57	46.68	74.00	-27.32	PK
H	2440.00	110.24	38.11	7.42	20.36	99.91	114.00	-14.09	PK
H	2440.00	97.39	38.11	7.42	20.36	87.06	94.00	-6.94	AV
H	4880.00	61.73	38.65	7.78	23.61	54.47	74.00	-19.53	PK
H	4880.00	46.78	38.65	7.78	23.61	39.52	54.00	-14.48	AV
H	16132.00	50.16	38.75	10.36	26.57	48.34	74.00	-25.66	PK
operation frequency:2480									
V	2480.00	110.27	38.17	7.42	20.51	100.03	114.00	-13.97	PK
V	2480.00	97.60	38.17	7.42	20.51	87.36	94.00	-6.64	AV
V	4960.00	61.48	38.69	7.78	23.83	54.4	74.00	-19.60	PK
V	4960.00	46.34	38.69	7.78	23.83	39.26	54.00	-14.74	AV
V	16132.00	50.38	38.75	10.36	26.57	48.56	74.00	-25.44	PK
H	2480.00	110.30	38.17	7.42	20.51	100.06	114.00	-13.94	PK
H	2480.00	97.45	38.17	7.42	20.51	87.21	94.00	-6.79	AV
H	4960.00	61.68	38.69	7.78	23.83	54.6	74.00	-19.40	PK
H	4960.00	46.37	38.69	7.78	23.83	39.29	54.00	-14.71	AV
H	16132.00	50.71	38.75	10.36	26.57	48.89	74.00	-25.11	PK

Remark:

1. Emission Level = Meter Reading + Antenna Factor + Cable Loss – Pre-amplifier,
Margin= Emission Level - Limit
2. If peak below the average limit, the average emission was no test.
3. The amplitude of spurious emissions which are attenuated by more than 20dB below the permissible value has no need to be reported.



3.3 RADIATED BAND EMISSION MEASUREMENT

3.3.1 TEST REQUIREMENT:

FCC Part15 C Section 15.209 and 15.205

LIMITS OF RADIATED EMISSION MEASUREMENT (Above 1000MHz)

FREQUENCY (MHz)	Class B (dBuV/m) (at 3M)	
	PEAK	AVERAGE
Above 1000	74	54

Notes:

- (1) The limit for radiated test was performed according to FCC PART 15C.
- (2) The tighter limit applies at the band edges.
- (3) Emission level (dBuV/m)=20log Emission level (uV/m).

Spectrum Parameter	Setting
Attenuation	Auto
Start Frequency	2300MHz
Stop Frequency	2520
RB / VB (emission in restricted band)	1 MHz / 1 MHz for Peak, 1 MHz / 10Hz for Average

3.3.2 TEST PROCEDURE

Above 1GHz test procedure as below:

- a. 1. The EUT was placed on the top of a rotating table 1.5 meters above the ground at a 3 meter camber. The table was rotated 360 degrees to determine the position of the highest radiation.
- b. The EUT was set 3 meters away from the interference-receiving antenna, which was mounted on the top of a variable-height antenna tower.
- c. The antenna height is varied from one meter to four meters above the ground to determine the maximum value of the field strength. Both horizontal and vertical polarizations of the antenna are set to make the measurement.
- d. For each suspected emission, the EUT was arranged to its worst case and then the antenna was tuned to heights from 1 meter to 4 meters and the rota table was turned from 0 degrees to 360 degrees to find the maximum reading.
- e. The test-receiver system was set to Peak Detect Function and Specified Bandwidth with Maximum Hold Mode.
- f. If the emission level of the EUT in peak mode was 10dB lower than the limit specified, then testing could be stopped and the peak values of the EUT would be reported. Otherwise the emissions that did not have 10dB margin would be re-tested one by one using peak, quasi-peak or average method as specified and then reported in a data sheet.
- g. Test the EUT in the lowest channel,the Highest channel

Note:

Both horizontal and vertical antenna polarities were tested and performed pretest to three orthogonal axis. The worst case emissions were reported

3.3.3 DEVIATION FROM TEST STANDARD

No deviation

3.3.4 TEST SETUP

Radiated Emission Test-Up Frequency Above 1GHz

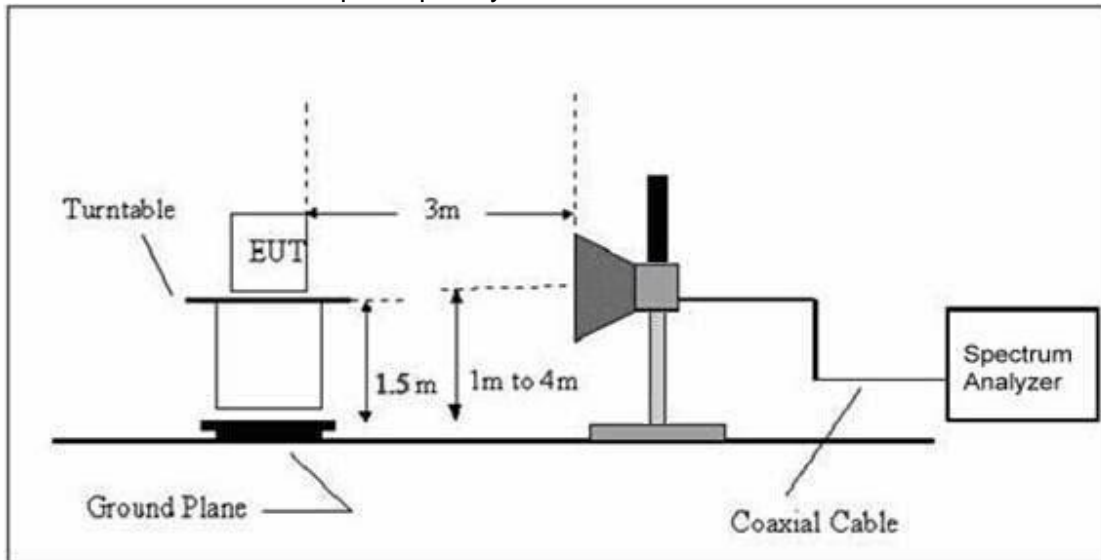

3.3.5 EUT OPERATING CONDITIONS

The EUT tested system was configured as the statements of 2.3 Unless otherwise a special operating condition is specified in the follows during the testing.

The plot only show the Horizontal's average data.



3.3.6 TEST RESULT

GFSK

Polar (H/V)	Frequency	Meter Reading	Pre-amplifier	Cable Loss	Antenna Factor	Emission level	Limits	Margin	Detector Type
	(MHz)	(dBuV)	(dB)	(dB)	(dB/m)	(dBuV/m)	(dBuV/m)	(dB)	
operation frequency:2402									
V	2390.00	66.96	38.06	7.42	20.15	56.47	74.00	-17.53	PK
V	2390.00	55.63	38.06	7.42	20.15	45.14	54.00	-8.86	AV
V	2400.00	67.17	38.06	7.42	20.15	56.68	74.00	-17.32	PK
V	2400.00	55.21	38.06	7.42	20.15	44.72	54.00	-9.28	AV
H	2390.00	67.25	38.06	7.42	20.15	56.76	74.00	-17.24	PK
H	2390.00	55.66	38.06	7.42	20.15	45.17	54.00	-8.83	AV
H	2400.00	67.12	38.06	7.42	20.15	56.63	74.00	-17.37	PK
H	2400.00	55.60	38.06	7.42	20.15	45.11	54.00	-8.89	AV

Polar (H/V)	Frequency	Meter Reading	Pre-amplifier	Cable Loss	Antenna Factor	Emission Level	Limits	Margin	Detector Type
	(MHz)	(dBuV)	(dB)	(dB)	(dB/m)	(dBuV/m)	(dBuV/m)	(dB)	
operation frequency:2480									
V	2483.50	67.17	38.17	7.42	20.51	56.93	74.00	-17.07	PK
V	2483.50	55.87	38.17	7.42	20.51	45.63	54.00	-8.37	AV
V	2500.00	67.11	38.20	7.45	20.54	56.9	74.00	-17.10	PK
V	2500.00	55.32	38.20	7.45	20.54	45.11	54.00	-8.89	AV
H	2483.50	67.29	38.17	7.42	20.51	57.05	74.00	-16.95	PK
H	2483.50	55.91	38.17	7.42	20.51	45.67	54.00	-8.33	AV
H	2500.00	66.91	38.20	7.45	20.54	56.7	74.00	-17.30	PK
H	2500.00	56.16	38.20	7.45	20.54	45.95	54.00	-8.05	AV

Remark:

1. Emission Level = Meter Reading + Factor, Margin= Emission Level - Limit
2. If peak below the average limit, the average emission was no test.
3. The amplitude of spurious emissions which are attenuated by more than 20dB below the permissible value has no need to be reported.



PI/4 DPSK

Polar (H/V)	Frequency	Meter Reading	Pre-amplifier	Cable Loss	Antenna Factor	Emission level	Limits	Margin	Detector Type
	(MHz)	(dBuV)	(dB)	(dB)	(dB/m)	(dBuV/m)	(dBuV/m)	(dB)	
operation frequency:2402									
V	2390.00	67.12	38.06	7.42	20.15	56.63	74.00	-17.37	PK
V	2390.00	55.76	38.06	7.42	20.15	45.27	54.00	-8.73	AV
V	2400.00	67.33	38.06	7.42	20.15	56.84	74.00	-17.16	PK
V	2400.00	55.34	38.06	7.42	20.15	44.85	54.00	-9.15	AV
H	2390.00	67.41	38.06	7.42	20.15	56.92	74.00	-17.08	PK
H	2390.00	55.79	38.06	7.42	20.15	45.30	54.00	-8.70	AV
H	2400.00	67.28	38.06	7.42	20.15	56.79	74.00	-17.21	PK
H	2400.00	55.73	38.06	7.42	20.15	45.24	54.00	-8.76	AV

Polar (H/V)	Frequency	Meter Reading	Pre-amplifier	Cable Loss	Antenna Factor	Emission Level	Limits	Margin	Detector Type
	(MHz)	(dBuV)	(dB)	(dB)	(dB/m)	(dBuV/m)	(dBuV/m)	(dB)	
operation frequency:2480									
V	2483.50	67.33	38.17	7.42	20.51	57.09	74.00	-16.91	PK
V	2483.50	56.00	38.17	7.42	20.51	45.76	54.00	-8.24	AV
V	2500.00	67.27	38.20	7.45	20.54	57.06	74.00	-16.94	PK
V	2500.00	55.45	38.20	7.45	20.54	45.24	54.00	-8.76	AV
H	2483.50	67.45	38.17	7.42	20.51	57.21	74.00	-16.79	PK
H	2483.50	56.04	38.17	7.42	20.51	45.80	54.00	-8.20	AV
H	2500.00	67.07	38.20	7.45	20.54	56.86	74.00	-17.14	PK
H	2500.00	56.29	38.20	7.45	20.54	46.08	54.00	-7.92	AV

Remark:

1. Emission Level = Meter Reading + Factor, Margin= Emission Level - Limit
2. If peak below the average limit, the average emission was no test.
3. The amplitude of spurious emissions which are attenuated by more than 20dB below the permissible value has no need to be reported.



8DPSK

Polar (H/V)	Frequency	Meter Reading	Pre-amplifier	Cable Loss	Antenna Factor	Emission Level	Limits	Margin	Detector Type
	(MHz)	(dBuV)	(dB)	(dB)	(dB/m)	(dBuV/m)	(dBuV/m)	(dB)	
operation frequency:2402									
V	2390.00	67.46	38.06	7.42	20.15	56.97	74.00	-17.03	PK
V	2390.00	56.05	38.06	7.42	20.15	45.56	54.00	-8.44	AV
V	2400.00	67.68	38.06	7.42	20.15	57.19	74.00	-16.81	PK
V	2400.00	55.62	38.06	7.42	20.15	45.13	54.00	-8.87	AV
H	2390.00	67.76	38.06	7.42	20.15	57.27	74.00	-16.73	PK
H	2390.00	56.08	38.06	7.42	20.15	45.59	54.00	-8.41	AV
H	2400.00	67.62	38.06	7.42	20.15	57.13	74.00	-16.87	PK
H	2400.00	56.02	38.06	7.42	20.15	45.53	54.00	-8.47	AV

Polar (H/V)	Frequency	Meter Reading	Pre-amplifier	Cable Loss	Antenna Factor	Emission Level	Limits	Margin	Detector Type
	(MHz)	(dBuV)	(dB)	(dB)	(dB/m)	(dBuV/m)	(dBuV/m)	(dB)	
operation frequency:2480									
V	2483.50	67.68	38.17	7.42	20.51	57.44	74.00	-16.56	PK
V	2483.50	56.29	38.17	7.42	20.51	46.05	54.00	-7.95	AV
V	2500.00	67.61	38.20	7.45	20.54	57.40	74.00	-16.60	PK
V	2500.00	55.73	38.20	7.45	20.54	45.52	54.00	-8.48	AV
H	2483.50	67.80	38.17	7.42	20.51	57.56	74.00	-16.44	PK
H	2483.50	56.33	38.17	7.42	20.51	46.09	54.00	-7.91	AV
H	2500.00	67.41	38.20	7.45	20.54	57.20	74.00	-16.80	PK
H	2500.00	56.58	38.20	7.45	20.54	46.37	54.00	-7.63	AV

Remark:

1. Emission Level = Meter Reading + Factor, Margin= Emission Level - Limit
2. If peak below the average limit, the average emission was no test.
3. The amplitude of spurious emissions which are attenuated by more than 20dB below the permissible value has no need to be reported.



4. BANDWIDTH TEST

4.1 APPLIED PROCEDURES / LIMIT

FCC Part15 (15.249) ,	
Section	Test Item
15.249	Bandwidth

4.1.1 TEST PROCEDURE

1. Set RBW = 100 kHz.
2. Set the video bandwidth (VBW) $\geq 3 \times$ RBW.
3. Detector = Peak.
4. Trace mode = max hold.
5. Sweep = auto couple.
6. Allow the trace to stabilize.
7. Measure the maximum width of the emission that is constrained by the frequencies associated with the two outermost amplitude points (upper and lower frequencies) that are attenuated by 6 dB relative to the maximum level measured in the fundamental emission.

4.1.2 DEVIATION FROM STANDARD

No deviation.

4.1.3 TEST SETUP

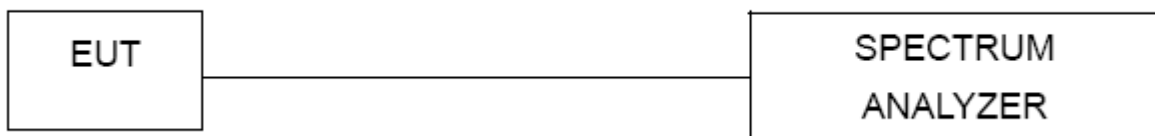

4.1.4 EUT OPERATION CONDITIONS

The EUT tested system was configured as the statements of 2.3 Unless otherwise a special operating condition is specified in the follows during the testing.



4.1.5 TEST RESULTS

Temperature :	25°C	Relative Humidity :	60%
Pressure :	1012 hPa	Test Voltage :	DC 3.7V
Test Mode :	TX Mode /CH01, CH39, CH79		

	Frequency (MHz)	20dB bandwidth (MHz)	Result
GFSK	2402	1.034	Pass
	2441	1.031	Pass
	2480	1.029	Pass
PI/4 DPSK	2402	1.294	Pass
	2441	1.297	Pass
	2480	1.303	Pass
8DPSK	2402	1.300	Pass
	2441	1.298	Pass
	2480	1.297	Pass

GFSK

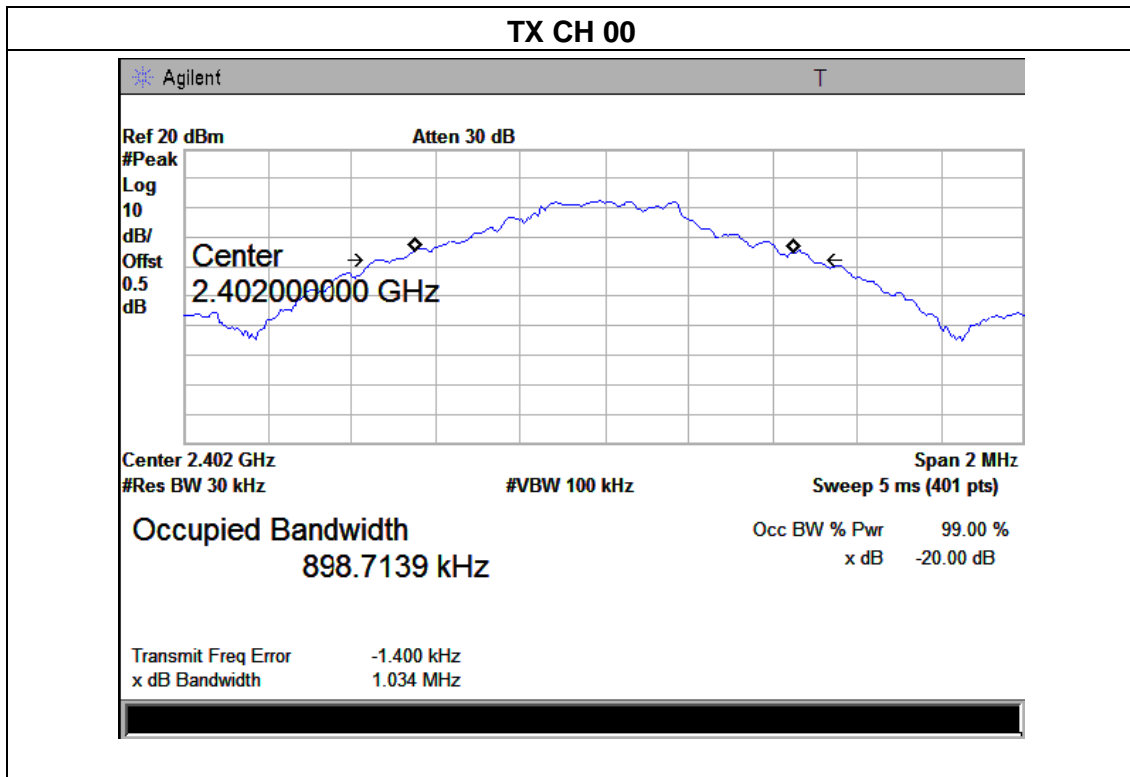

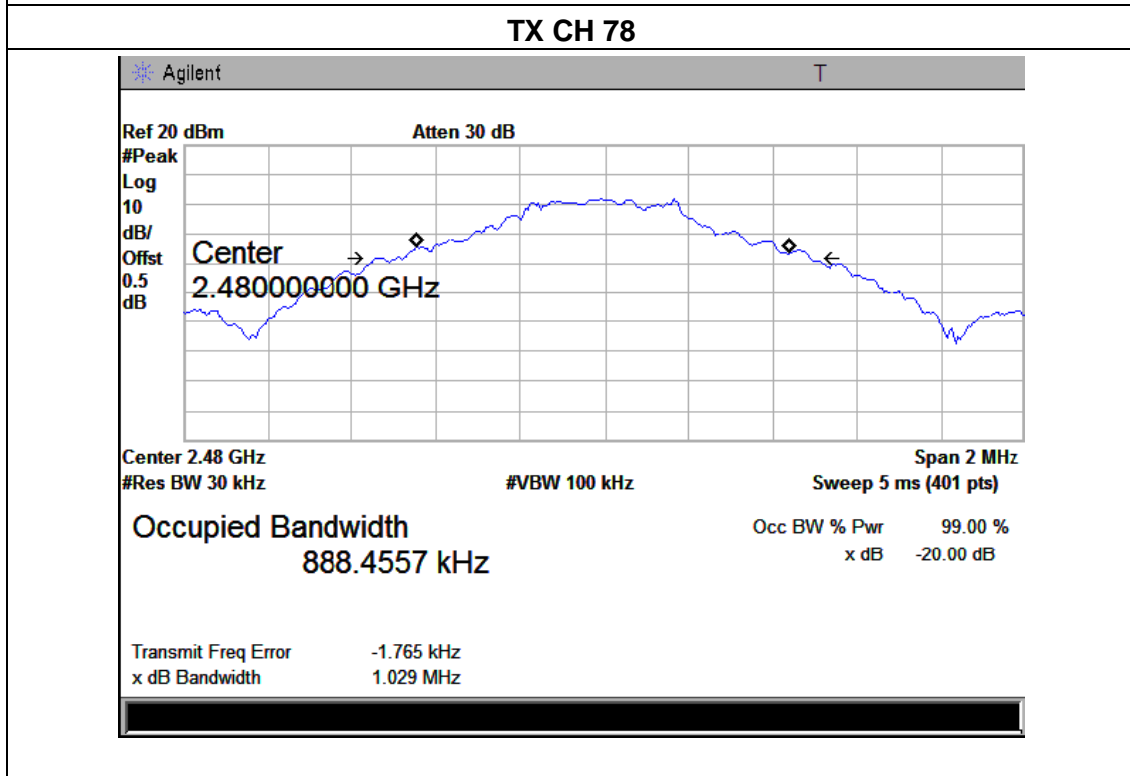
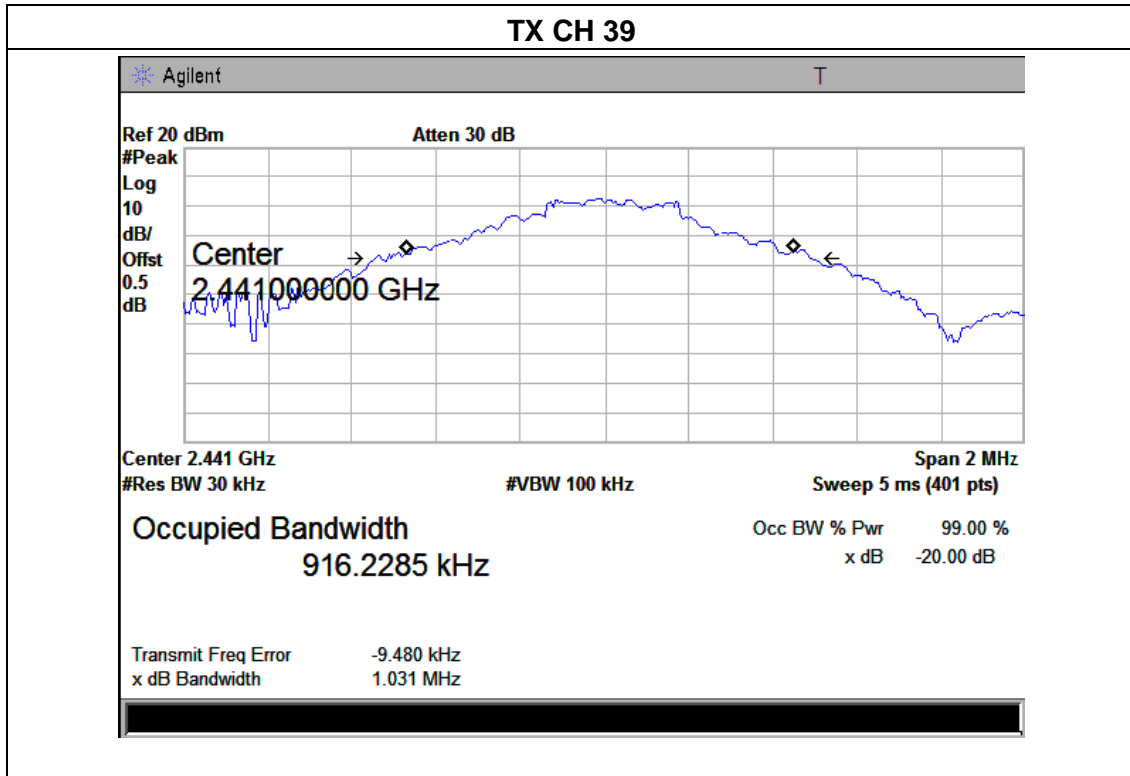



PI/4 DPSK

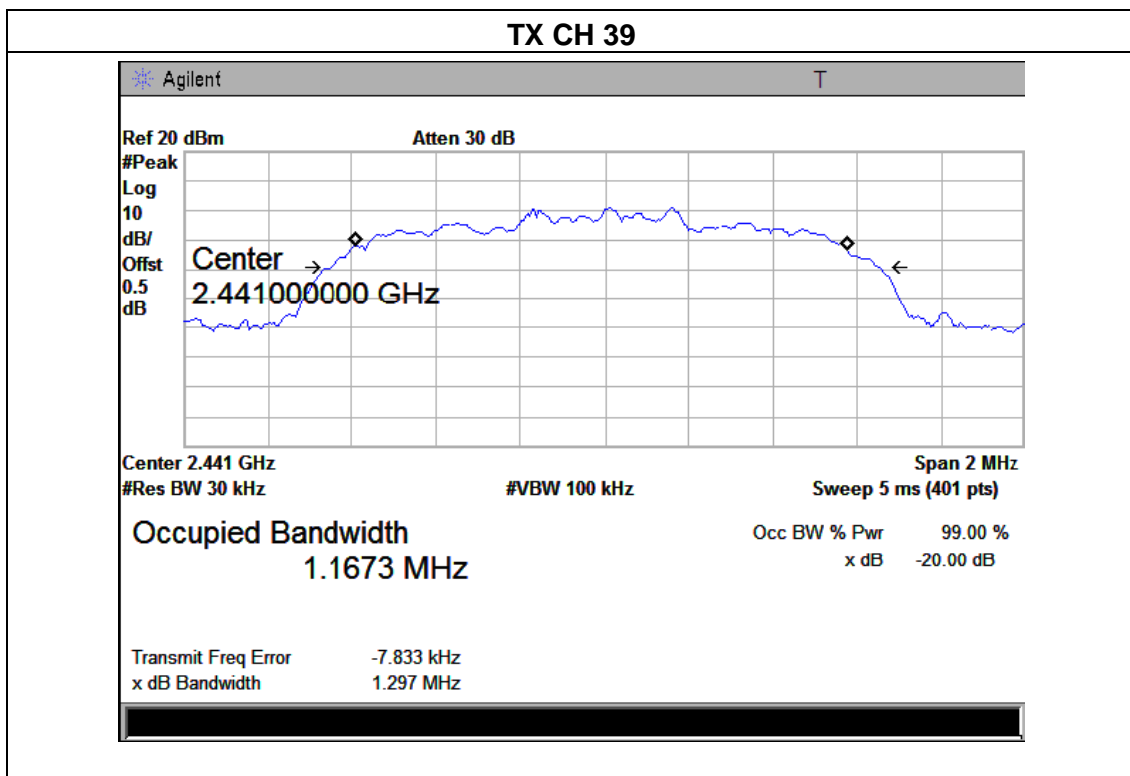
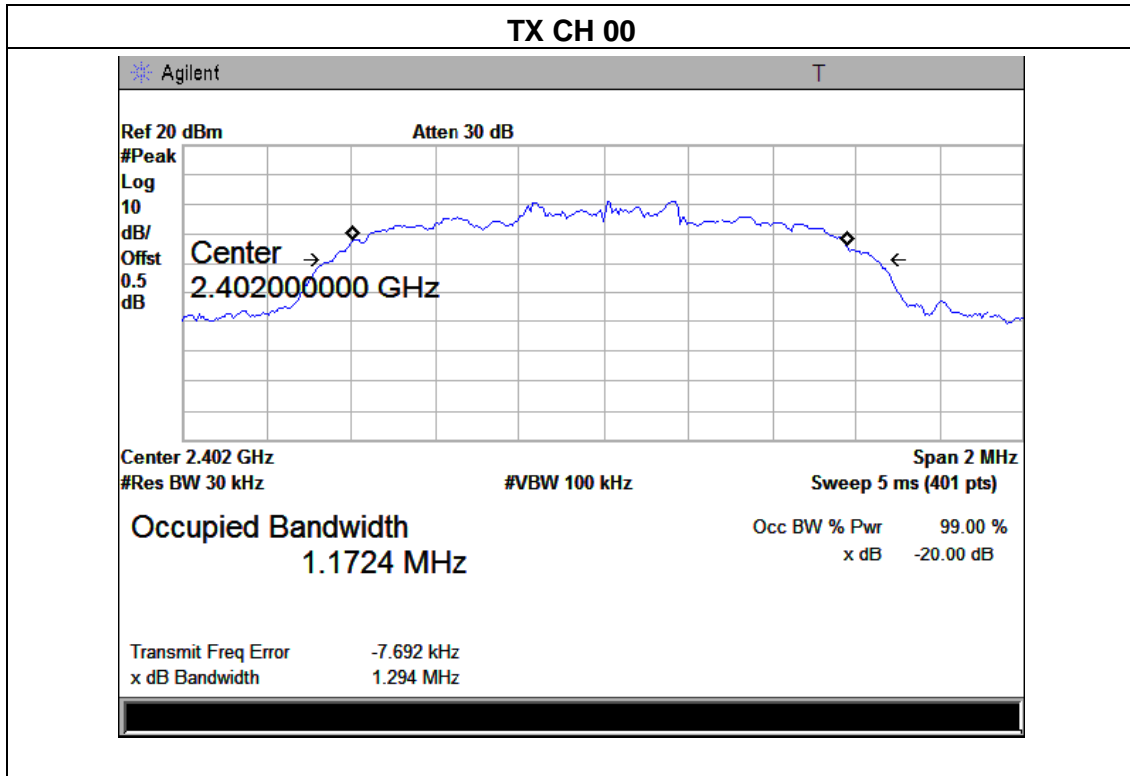

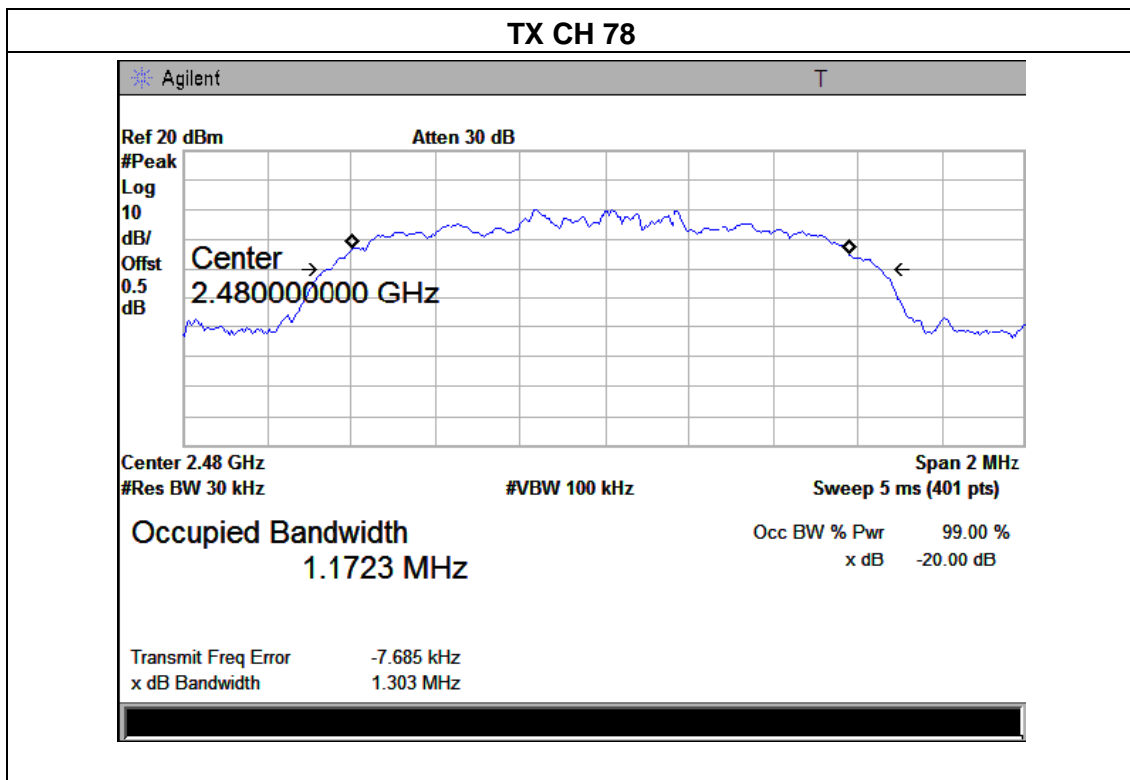

8DPSK

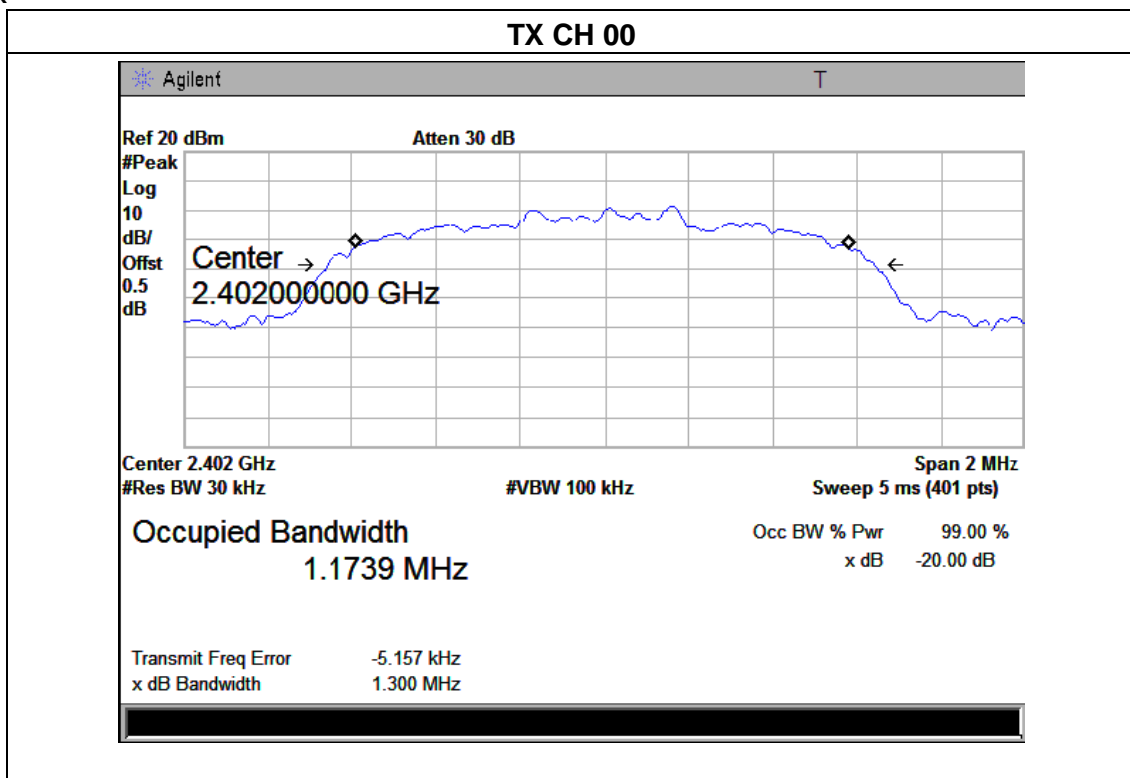

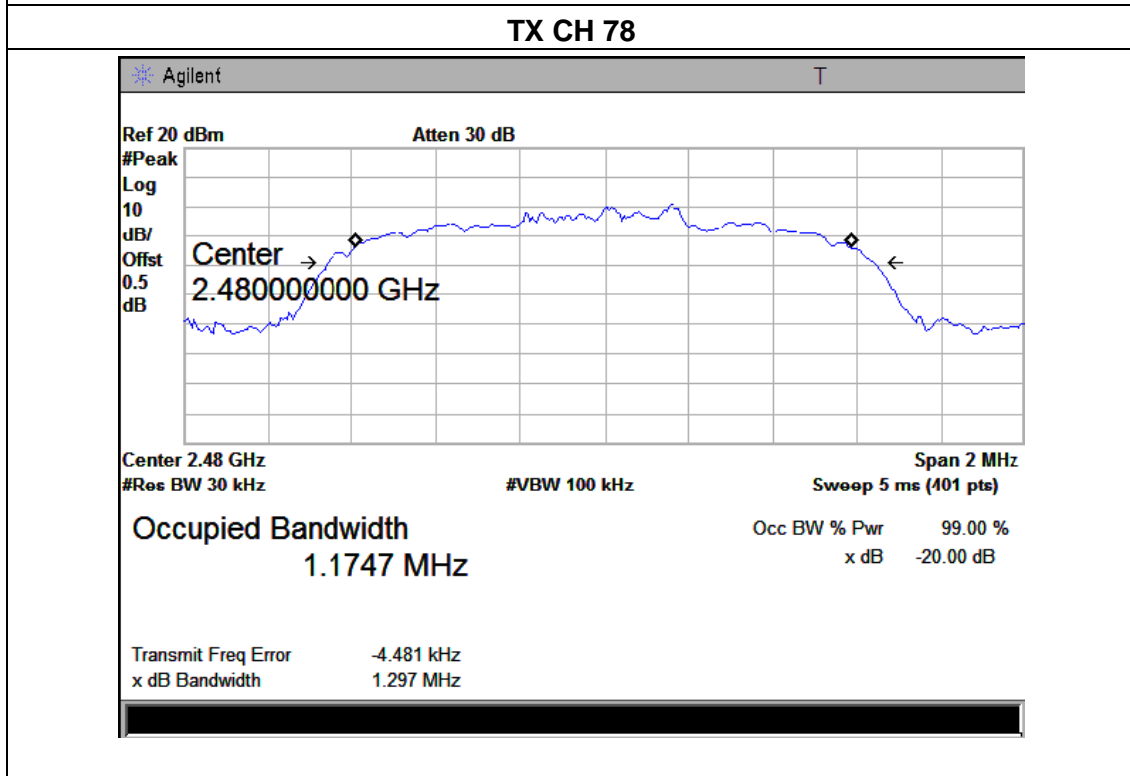
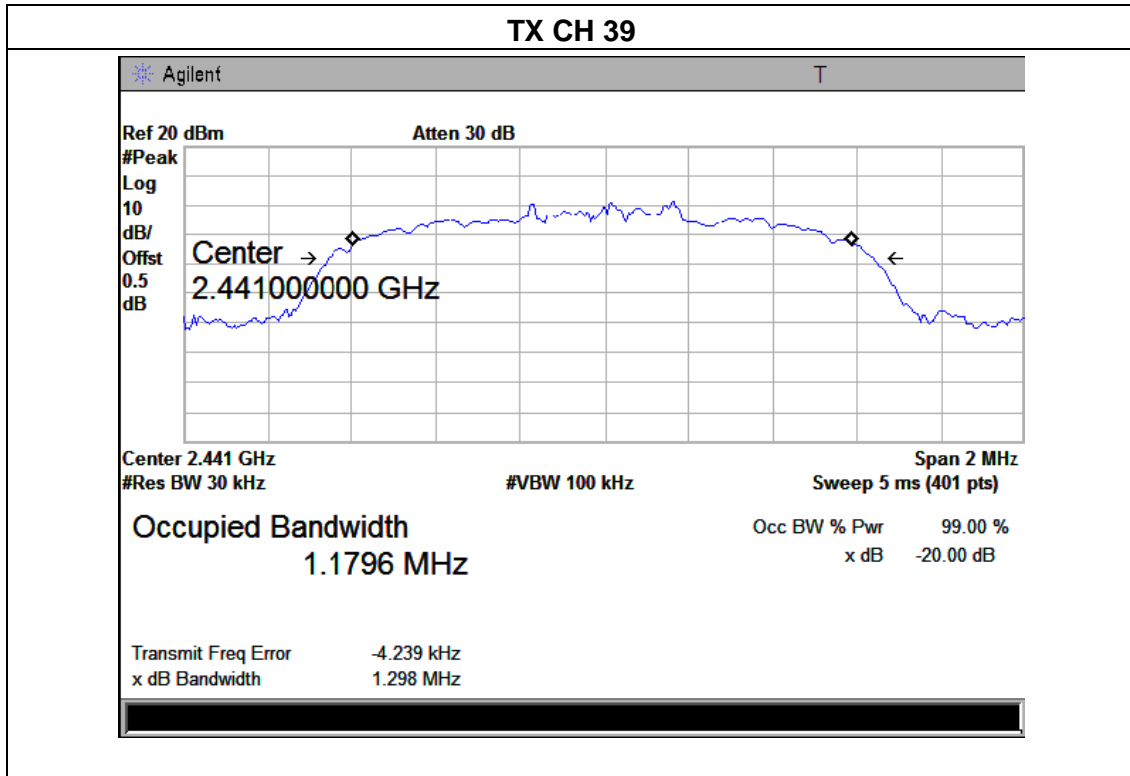



5. ANTENNA REQUIREMENT

5.1 STANDARD REQUIREMENT

15.203 requirement: For intentional device, according to 15.203: an intentional radiator shall be designed to ensure that no antenna other than that furnished by the responsible party shall be used with the device.

5.2 EUT ANTENNA

The EUT antenna is internal antenna,. It comply with the standard requirement.

6. TEST SEUUP PHOTO

Radiated Measurement Photos

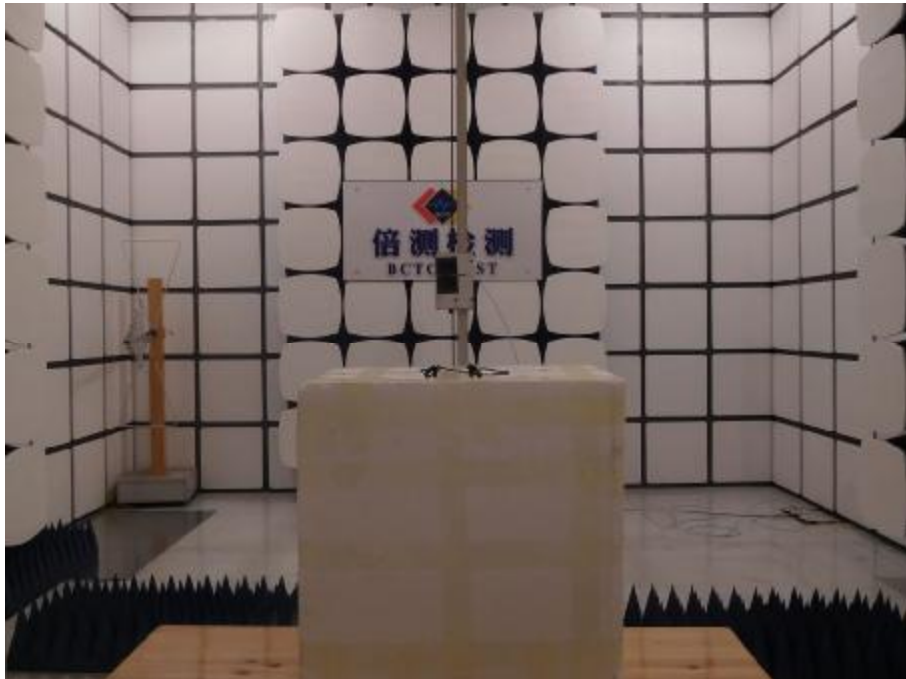



Conducted Measurement Photos



7. EUT PHOTO





***** END OF REPORT *****