



FCC TEST REPORT

Test report
On Behalf of
Shenzhen Jieku Technology Co., LTD
For
Bluetooth Earphone
Model No.:B4, R5, R6, B5, B6, B7, B8, B9
FCC ID: 2AJXD-B4

Prepared for : Shenzhen Jieku Technology Co., Ltd.
C Block, 3floor Honggida Industrial Park Longsheng Industrial, Baoan District,
Guangdong, China

Prepared By : Shenzhen HUAKE Testing Technology Co., Ltd.
1F, B2 Building, Junfeng Zhongcheng Zhizao Innovation Park, Fuhai Street,
Bao'an District, Shenzhen City, China

Date of Test: Nov. 05, 2019 ~Nov. 11, 2019

Date of Report: Nov. 11, 2019

Report Number: HK1911112839-E



TEST RESULT CERTIFICATION

Applicant's name : Shenzhen Jieku Technology Co., Ltd.
Address : C Block, 3floor Honggida Industrial Park Longsheng Industrial,
 Baoan District, Guangdong, China
Manufacture's Name..... : Shenzhen Jieku Technology Co., Ltd.
Address : C Block, 3floor Honggida Industrial Park Longsheng Industrial,
 Baoan District, Guangdong, China

Product description

Trade Mark: N/A
Product name : Bluetooth Earphone
Model and/or type reference : B4, R5, R6, B5, B6, B7, B8, B9

Standards : FCC Rules and Regulations Part 15 Subpart C Section 15.249
 ANSI C63.10: 2013

This publication may be reproduced in whole or in part for non-commercial purposes as long as the Shenzhen HUAK Testing Technology Co., Ltd. is acknowledged as copyright owner and source of the material. Shenzhen HUAK Testing Technology Co., Ltd. takes no responsibility for and will not assume liability for damages resulting from the reader's interpretation of the reproduced material due to its placement and context.

Date of Test :
Date (s) of performance of tests : Nov. 05, 2019 ~Nov. 11, 2019
Date of Issue..... : Nov. 11, 2019
Test Result..... : **Pass**

Testing Engineer : Gary Qian
 (Gary Qian)

Technical Manager : Eden Hu
 (Eden Hu)

Authorized Signatory : Jason Zhou
 (Jason Zhou)



| Table of Contents | Page |
|---|-------------|
| 1 . TEST SUMMARY | 4 |
| 2 . GENERAL INFORMATION | 5 |
| 2.1 GENERAL DESCRIPTION OF EUT | 5 |
| 2.2 Operation of EUT during testing | 6 |
| 2.3 DESCRIPTION OF TEST SETUP | 7 |
| 2.4 MEASUREMENT INSTRUMENTS LIST | 8 |
| 3 . CONDUCTED EMISSIONS TEST | 9 |
| 3.1 Conducted Power Line Emission Limit | 9 |
| 3.2 Test Setup | 9 |
| 3.3 Test Procedure | 9 |
| 3.4 Test Result | 10 |
| 4 RADIATED EMISSION TEST | 12 |
| 4.1 Radiation Limit | 12 |
| 4.2 Test Setup | 12 |
| 4.3 Test Procedure | 13 |
| 4.4 Test Result | 13 |
| 5 out of Band Emissions | 19 |
| 5.1 Limits | 19 |
| 5.2 Test Procedure | 19 |
| 5.3 Test Result | 19 |
| 6 OCCUPIED BANDWIDTH MEASUREMENT | 21 |
| 6.1 Test Setup | 21 |
| 6.2 Test Procedure | 21 |
| 6.3 Measurement Equipment Used | 21 |
| 6.4 Test Result | 21 |
| 7 ANTENNA REQUIREMENT | 27 |
| 8 PHOTOGRAPH OF TEST | 28 |
| 8.1 Radiated Emission | 28 |
| 8.2 Conducted Emission | 29 |
| 9 PHOTOGRAPH OF TEST | 30 |



1. TEST SUMMARY

1.1 TEST PROCEDURES AND RESULTS

| FCC PART 15.249 | | |
|--------------------------------|--------------------------|------|
| CONDUCTED EMISSIONS TEST | §15.207 | PASS |
| RADIATED EMISSION TEST | §15.249 (a) (d)/ §15.209 | PASS |
| out of Band Emissions | §15.249 (d)/ §15.205 | PASS |
| OCCUPIED BANDWIDTH MEASUREMENT | §15.215 (c) | PASS |
| ANTENNA REQUIREMENT | §15.203 | PASS |

1.2 TEST FACILITY

| | | |
|--------------------|---|---|
| Test Firm | : | Shenzhen HUAKE Testing Technology Co., Ltd. |
| Address | : | 1F, B2 Building, Junfeng Zhongcheng Zhizao Innovation Park, Fuhai Street, Bao'an District, Shenzhen City, China |
| Designation Number | : | CN1229 |

1.3 MEASUREMENT UNCERTAINTY

| Measurement Uncertainty | | |
|---|---|-------------|
| Conducted Emission Expanded Uncertainty | = | 2.23dB, k=2 |
| Radiated emission expanded uncertainty(9kHz-30MHz) | = | 3.08dB, k=2 |
| Radiated emission expanded uncertainty(30MHz-1000MHz) | = | 4.42dB, k=2 |
| Radiated emission expanded uncertainty(Above 1GHz) | = | 4.06dB, k=2 |



2. GENERAL INFORMATION

2.1 GENERAL DESCRIPTION OF EUT

| | |
|------------------------|--|
| Equipment | Bluetooth Earphone |
| Model Name | B4 |
| Serial No | R5, R6, B5, B6, B7, B8, B9 |
| Model Difference | All model's the function, software and electric circuit are the same, only with a product color and model named different. Test sample model: B4 |
| FCC ID | 2AJXD-B4 |
| Antenna Type | PCB Antenna |
| Antenna Gain | 0dBi |
| BT Operation frequency | 2402-2480MHz |
| Number of Channels | 79CH |
| Modulation Type | GFSK, $\pi/4$ DQPSK, 8DPSK |
| Power Source | DC 3.7V from Battery or DC 5V from USB |
| Power Rating | DC 3.7V from Battery or DC 5V from USB |



2.1.1 Carrier Frequency of Channels

| Channel List | | | | | |
|--------------|-----------------|---------|-----------------|---------|-----------------|
| Channel | Frequency (MHz) | Channel | Frequency (MHz) | Channel | Frequency (MHz) |
| 00 | 2402 | 27 | 2429 | 54 | 2456 |
| 01 | 2403 | 28 | 2430 | 55 | 2457 |
| 02 | 2404 | 29 | 2431 | 56 | 2458 |
| 03 | 2405 | 30 | 2432 | 57 | 2459 |
| 04 | 2406 | 31 | 2433 | 58 | 2460 |
| 05 | 2407 | 32 | 2434 | 59 | 2461 |
| 06 | 2408 | 33 | 2435 | 60 | 2462 |
| 07 | 2409 | 34 | 2436 | 61 | 2463 |
| 08 | 2410 | 35 | 2437 | 62 | 2464 |
| 09 | 2411 | 36 | 2438 | 63 | 2465 |
| 10 | 2412 | 37 | 2439 | 64 | 2466 |
| 11 | 2413 | 38 | 2440 | 65 | 2467 |
| 12 | 2414 | 39 | 2441 | 66 | 2468 |
| 13 | 2415 | 40 | 2442 | 67 | 2469 |
| 14 | 2416 | 41 | 2443 | 68 | 2470 |
| 15 | 2417 | 42 | 2444 | 69 | 2471 |
| 16 | 2418 | 43 | 2445 | 70 | 2472 |
| 17 | 2419 | 44 | 2446 | 71 | 2473 |
| 18 | 2420 | 45 | 2447 | 72 | 2474 |
| 19 | 2421 | 46 | 2448 | 73 | 2475 |
| 20 | 2422 | 47 | 2449 | 74 | 2476 |
| 21 | 2423 | 48 | 2450 | 75 | 2477 |
| 22 | 2424 | 49 | 2451 | 76 | 2478 |
| 23 | 2425 | 50 | 2452 | 77 | 2479 |
| 24 | 2426 | 51 | 2453 | 78 | 2480 |
| 25 | 2427 | 52 | 2454 | | |
| 26 | 2428 | 53 | 2455 | | |

2.2 Operation of EUT during testing

Operating Mode

The mode is used: **Transmitting mode**

Low Channel: 2402MHz

Middle Channel: 2441MHz

High Channel: 2480MHz



2.3 DESCRIPTION OF TEST SETUP

Operation of EUT during conducted testing and Radiation testing:

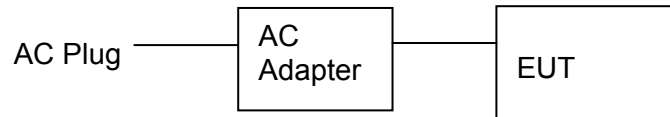

Operation of EUT Above 1GHz Radiation testing:



- Adapter information

Model: HW-050500DFQ

Input: 100-240V~, 50/60Hz, 0.5A

Output: 5VDC

The sample was placed (0.8m below 1GHz, 1.5m above 1GHz) above the ground plane of 3m chamber. Measurements in both horizontal and vertical polarities were performed. During the test, each emission was maximized by: having the EUT continuously working, investigated all operating modes, rotated about all 3 axis (X, Y & Z) and considered typical configuration to obtain worst position, manipulating interconnecting cables, rotating the turntable, varying antenna height from 1m to 4m in both horizontal and vertical polarizations. The emissions worst-case are shown in Test Results of the following pages. The worst case is X position



2.4 MEASUREMENT INSTRUMENTS LIST

| Item | Equipment | Manufacturer | Model No. | Serial No. | Last Cal. | Cal. Interval |
|------|---|-----------------|---------------------|------------|---------------|---------------|
| 1. | L.I.S.N. Artificial Mains Network | R&S | ENV216 | HKE-002 | Dec. 27, 2018 | 1 Year |
| 2. | Receiver | R&S | ESCI 7 | HKE-010 | Dec. 27, 2018 | 1 Year |
| 3. | RF automatic control unit | Tonscend | JS0806-2 | HKE-060 | Dec. 27, 2018 | 1 Year |
| 4. | Spectrum analyzer | R&S | FSP40 | HKE-025 | Dec. 27, 2018 | 1 Year |
| 5. | Spectrum analyzer | Agilent | N9020A | HKE-048 | Dec. 27, 2018 | 1 Year |
| 6. | Preamplifier | Schwarzbeck | BBV 9743 | HKE-006 | Dec. 27, 2018 | 1 Year |
| 7. | EMI Test Receiver | Rohde & Schwarz | ESCI 7 | HKE-010 | Dec. 27, 2018 | 1 Year |
| 8. | Bilog Broadband Antenna | Schwarzbeck | VULB9163 | HKE-012 | Dec. 27, 2018 | 1 Year |
| 9. | Loop Antenna | Schwarzbeck | FMZB 1519 B | HKE-014 | Dec. 27, 2018 | 1 Year |
| 10. | Horn Antenna | Schwarzbeck | 9120D | HKE-013 | Dec. 27, 2018 | 1 Year |
| 11. | Pre-amplifier | EMCI | EMC051845 SE | HKE-015 | Dec. 27, 2018 | 1 Year |
| 12. | Pre-amplifier | Agilent | 83051A | HKE-016 | Dec. 27, 2018 | 1 Year |
| 13. | EMI Test Software EZ-EMC | Tonscend | JS1120-B Version | HKE-083 | Dec. 27, 2018 | N/A |
| 14. | Power Sensor | Agilent | E9300A | HKE-086 | Dec. 27, 2018 | 1 Year |
| 15. | Spectrum analyzer | Agilent | N9020A | HKE-048 | Dec. 27, 2018 | 1 Year |
| 16. | Signal generator | Agilent | N5182A | HKE-029 | Dec. 27, 2018 | 1 Year |
| 17. | Signal Generator | Agilent | 83630A | HKE-028 | Dec. 27, 2018 | 1 Year |
| 18. | Shielded room | Shiel Hong | 4*3*3 | HKE-039 | Dec. 27, 2018 | 3 Year |
| 19. | Horn Antenna | Schwarzbeck | BBHA 9170 | HKE-017 | Dec. 27, 2018 | 1 Year |



3. CONDUCTED EMISSIONS TEST

3.1 Conducted Power Line Emission Limit

For intentional device, according to § 15.207(a) Line Conducted Emission Limits is as following

| Frequency (MHz) | Maximum RF Line Voltage (dB μ V) | | | |
|-----------------|--------------------------------------|------|---------|--------|
| | CLASS A | | CLASS B | |
| | Q.P. | Ave. | Q.P. | Ave. |
| 0.15 - 0.50 | 79 | 66 | 66-56* | 56-46* |
| 0.50 - 5.00 | 73 | 60 | 56 | 46 |
| 5.00 - 30.0 | 73 | 60 | 60 | 50 |

* Decreasing linearly with the logarithm of the frequency

3.2 Test Setup

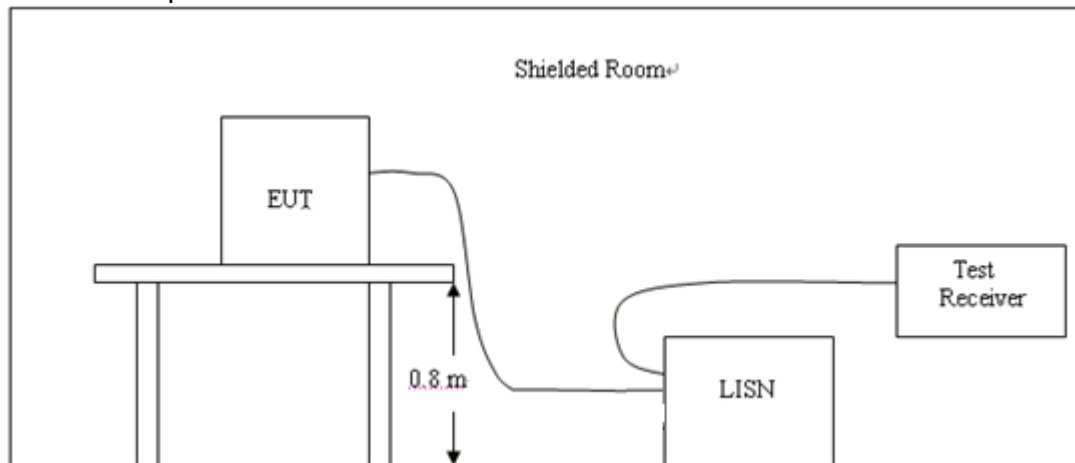

3.3 Test Procedure

- 1, The equipment was set up as per the test configuration to simulate typical actual usage per the user's manual. The EUT is a tabletop system, a wooden table with a height of 0.8 meters is used and is placed on the ground plane as per ANSI C63.10.
- 2, Support equipment, if needed, was placed as per ANSI C63.10.
- 3, All I/O cables were positioned to simulate typical actual usage as per ANSI C63.10.
- 4, If a EUT received DC power from the USB Port of Notebook PC, the PC's adapter received AC120V/60Hz power through a Line Impedance Stabilization Network (LISN) which supplied power source and was grounded to the ground plane.
- 5, All support equipments received AC power from a second LISN, if any.
- 6, The EUT test program was started. Emissions were measured on each current carrying line of the EUT using a spectrum Analyzer / Receiver connected to the LISN powering the EUT. The LISN has two monitoring points: Line 1 (Hot Side) and Line 2 (Neutral Side). Two scans were taken: one with Line 1 connected to Analyzer / Receiver and Line 2 connected to a 50 ohm load; the second scan had Line 1 connected to a 50 ohm load and Line 2 connected to the Analyzer / Receiver.
- 7, Analyzer / Receiver scanned from 150 KHz to 30MHz for emissions in each of the test modes.



3.4 Test Result

PASS

All the test modes completed for test. only the worst result of GFSK High Channel was reported as below:

Test Specification: Line

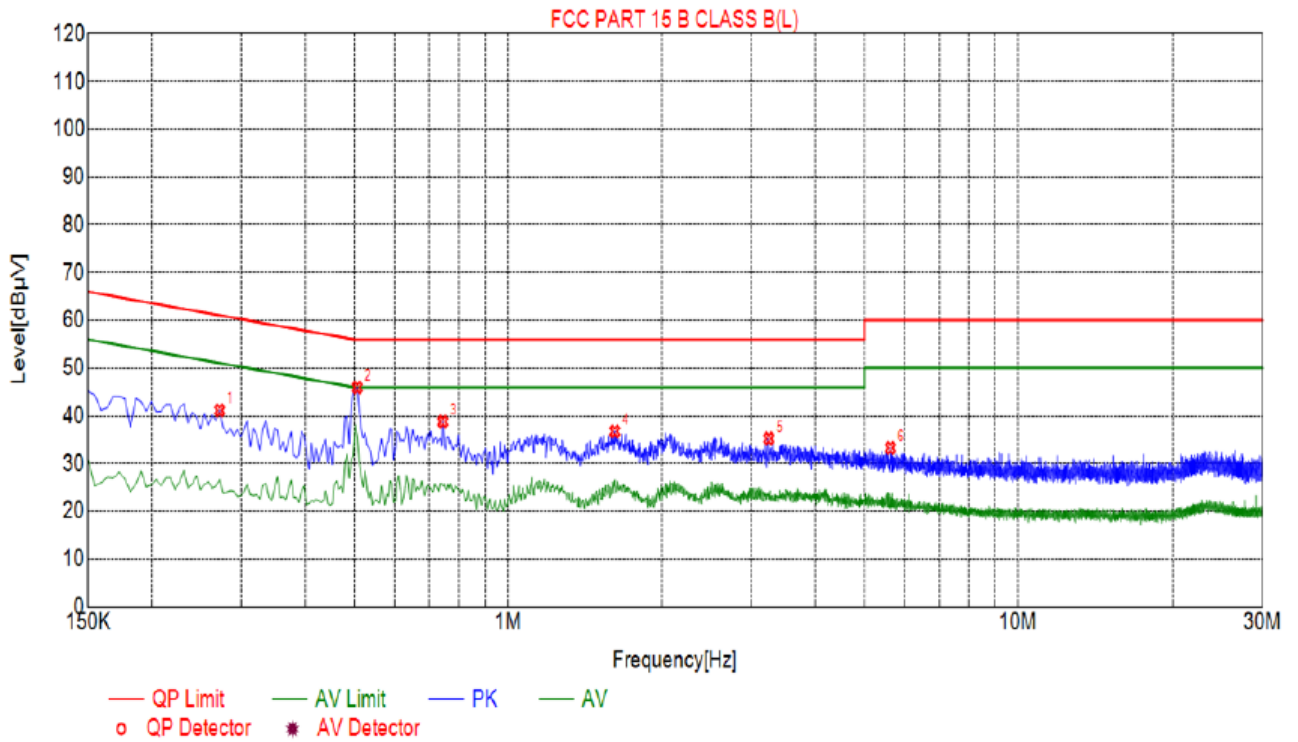

| Suspected List | | | | | | |
|----------------|----------------|-----------------|----------------|-----------------|----------------|----------|
| NO. | Freq. [MHz] | Level [dBµV] | Factor [dB] | Limit [dBµV] | Margin [dB] | Detector |
| 1 | 0.2715 | 41.19 | 10.03 | 61.07 | 19.88 | PK |
| 2 | 0.5055 | 45.96 | 10.04 | 56.00 | 10.04 | PK |
| 3 | 0.7440 | 38.81 | 10.06 | 56.00 | 17.19 | PK |
| 4 | 1.6170 | 36.77 | 10.11 | 56.00 | 19.23 | PK |
| 5 | 3.2460 | 35.28 | 10.23 | 56.00 | 20.72 | PK |
| 6 | 5.6220 | 33.30 | 10.25 | 60.00 | 26.70 | PK |

Remark: Margin = Limit – Level
 Correction factor = Cable lose + LISN insertion loss
 Level=Test receiver reading + correction factor



Test Specification: Neutral

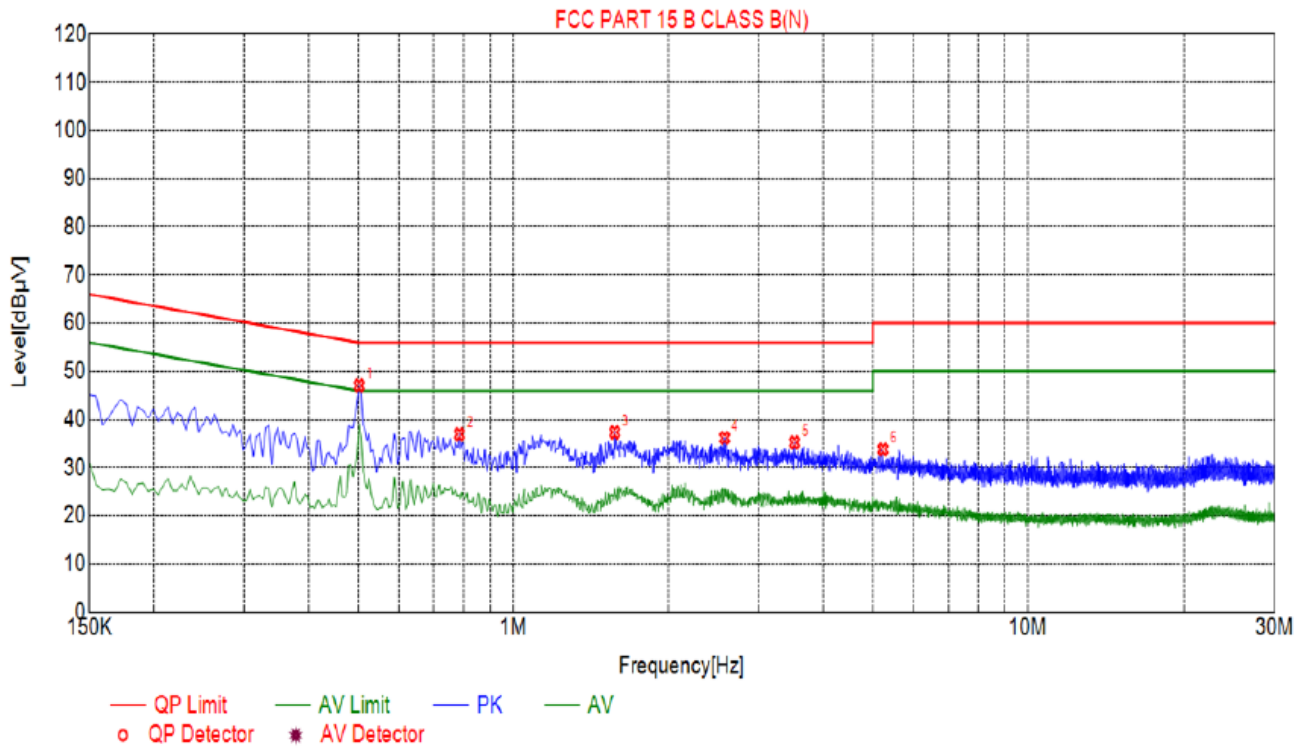

| Suspected List | | | | | | |
|----------------|-------------|--------------|-------------|--------------|-------------|----------|
| NO. | Freq. [MHz] | Level [dBµV] | Factor [dB] | Limit [dBµV] | Margin [dB] | Detector |
| 1 | 0.5010 | 47.10 | 10.04 | 56.00 | 8.90 | PK |
| 2 | 0.7845 | 36.96 | 10.05 | 56.00 | 19.04 | PK |
| 3 | 1.5720 | 37.36 | 10.11 | 56.00 | 18.64 | PK |
| 4 | 2.5755 | 36.21 | 10.20 | 56.00 | 19.79 | PK |
| 5 | 3.5205 | 35.27 | 10.25 | 56.00 | 20.73 | PK |
| 6 | 5.2305 | 33.84 | 10.26 | 60.00 | 26.16 | PK |

Remark: Margin = Limit – Level

Correction factor = Cable lose + LISN insertion loss

Level=Test receiver reading + correction factor

4 RADIATED EMISSION TEST

4.1 Radiation Limit

For intentional device, according to § 15.209(a), the field strength of radiated emissions from unintentional radiators at a distance of 3 meters shall not exceed the following values:

| Frequency (MHz) | Distance (Meters) | Radiated (dBµV/m) | Radiated (µV/m) |
|-----------------|-------------------|--|-----------------------|
| 0.009-0.49 | 3 | $20\log(2400/F(\text{KHz}))+40\log(300/3)$ | $2400/F(\text{KHz})$ |
| 0.49-1.705 | 3 | $20\log(24000/F(\text{KHz}))+40\log(30/3)$ | $24000/F(\text{KHz})$ |
| 1.705-30 | 3 | $20\log(30)+40\log(30/3)$ | 30 |
| 30-88 | 3 | 40.0 | 100 |
| 88-216 | 3 | 43.5 | 150 |
| 216-960 | 3 | 46.0 | 200 |
| Above 960 | 3 | 54.0 | 500 |

§15.249(a) The field strength of emissions from intentional radiators operated within these frequency bands shall comply with the following:

| Fundamental frequency | Field strength of fundamental (millivolts/meter) | Field strength of harmonics (microvolts/meter) |
|-----------------------|--|--|
| 2400-2483.5 MHz | 50 | 500 |

§15.249(e) – As shown in §15.35(b), for frequencies above 1000 MHz, the field strength limits in paragraphs (a) and (b) of this section are based on average limits. However, the peak field strength of any emission shall not exceed the maximum permitted average limits specified above by more than 20 dB under any condition of modulation.

4.2 Test Setup

(1) Radiated Emission Test-Up Frequency Below 30MHz

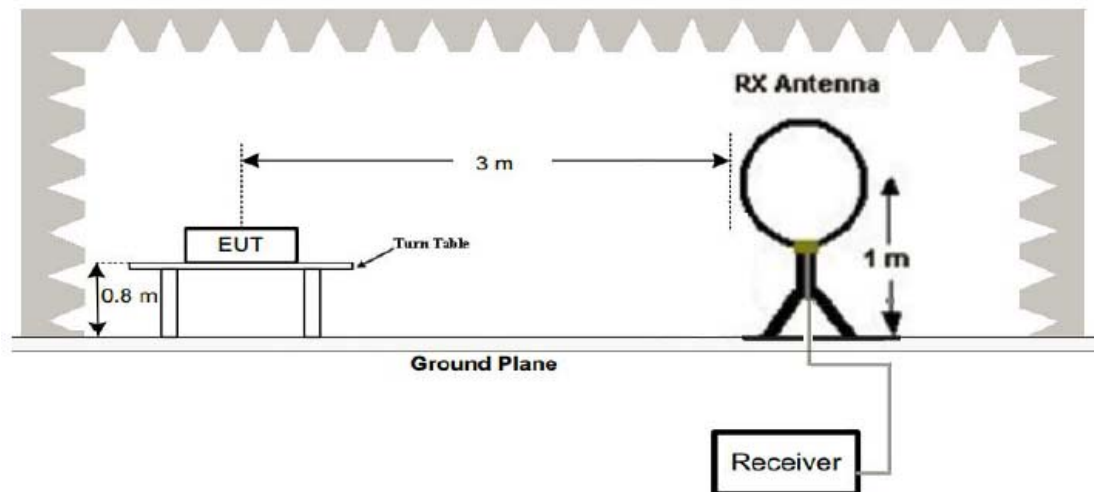

(2) Radiated Emission Test-Up Frequency 30MHz~1GHz

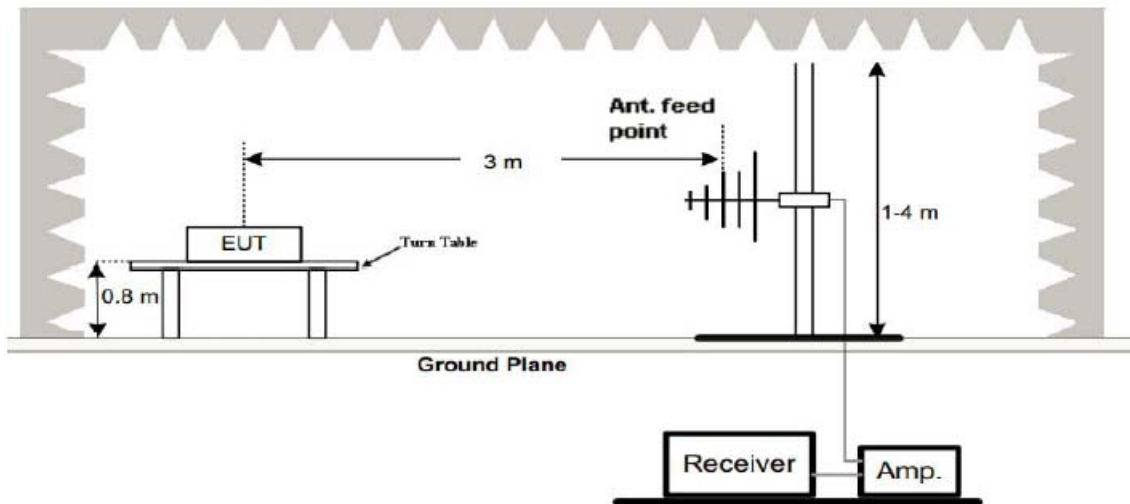

(3) Radiated Emission Test-Up Frequency Above 1GHz

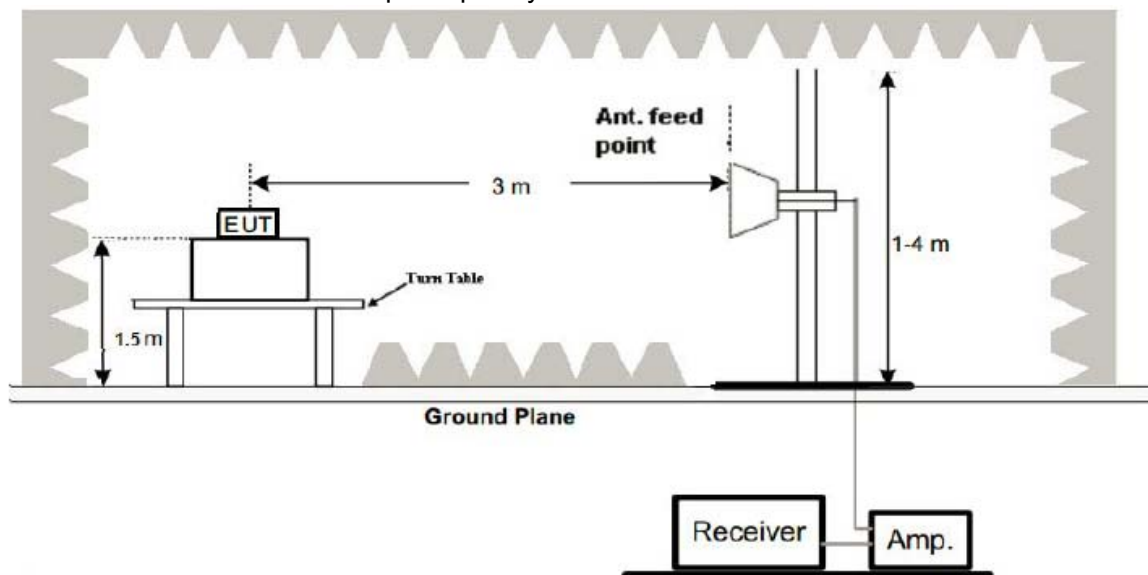

4.3 Test Procedure

1. Below 1GHz measurement the EUT is placed on turntable which is 0.8m above ground plane. And above 1GHz measurement EUT was placed on low permittivity and low tangent turn table which is 1.5m above ground plane.
2. The turntable shall be rotated for 360 degrees to determine the position of maximum emission level..
3. EUT is set 3m away from the receiving antenna, which is varied from 1m to 4m to find out the highest emissions.
4. Maximum procedure was performed on the six highest emissions to ensure EUT compliance.
5. And also, each emission was to be maximized by changing the polarization of receiving antenna both horizontal and vertical.
6. Repeat above procedures until the measurements for all frequencies are complete.
7. The test frequency range from 9KHz to 25GHz per FCC PART 15.33(a).

Note:

For battery operated equipment, the equipment tests shall be performed using a new battery.

4.4 Test Result

PASS



About 30MHz-1GHz

Note:

All the test modes completed for test. only the worst result of GFSK High Channel was reported as below:

Horizontal

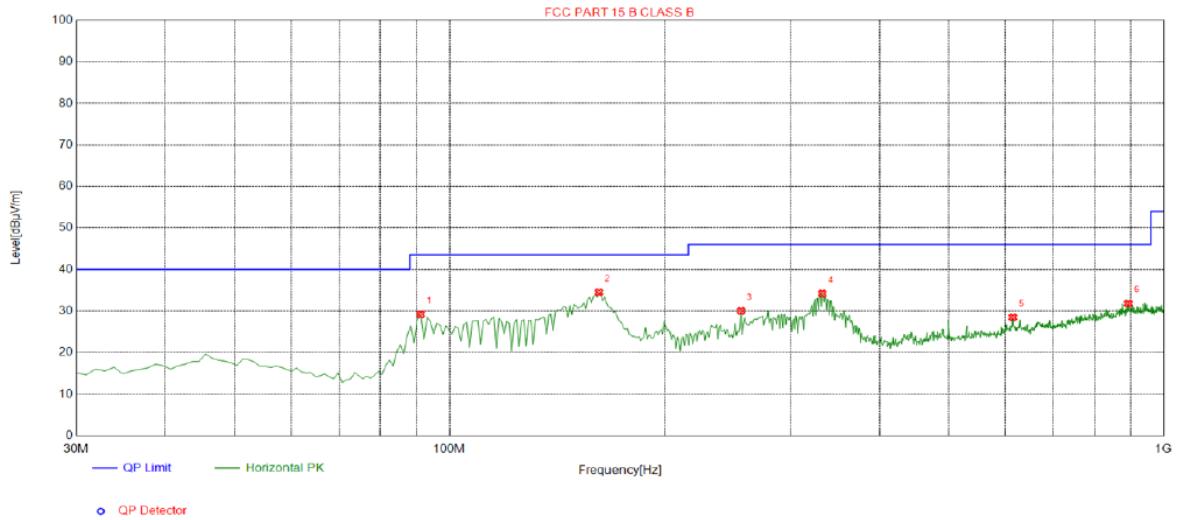

| Suspected List | | | | | | | | |
|----------------|-------------|----------------|-------------|----------------|-------------|-------------|-----------|------------|
| NO. | Freq. [MHz] | Level [dBµV/m] | Factor [dB] | Limit [dBµV/m] | Margin [dB] | Height [cm] | Angle [°] | Polarity |
| 1 | 91.1100 | 29.18 | -16.88 | 43.50 | 14.32 | 100 | 15 | Horizontal |
| 2 | 161.920 | 34.52 | -18.04 | 43.50 | 8.98 | 100 | 350 | Horizontal |
| 3 | 256.010 | 30.03 | -13.47 | 46.00 | 15.97 | 100 | 69 | Horizontal |
| 4 | 332.640 | 34.20 | -11.60 | 46.00 | 11.80 | 100 | 296 | Horizontal |
| 5 | 614.910 | 28.49 | -5.54 | 46.00 | 17.51 | 100 | 69 | Horizontal |
| 6 | 892.330 | 31.81 | -1.86 | 46.00 | 14.19 | 100 | 314 | Horizontal |

Remark:

Margin = Limit – Level

Level=Test receiver reading + factor

Factor= Antenna factor + cable loss- Amp factor



Vertical

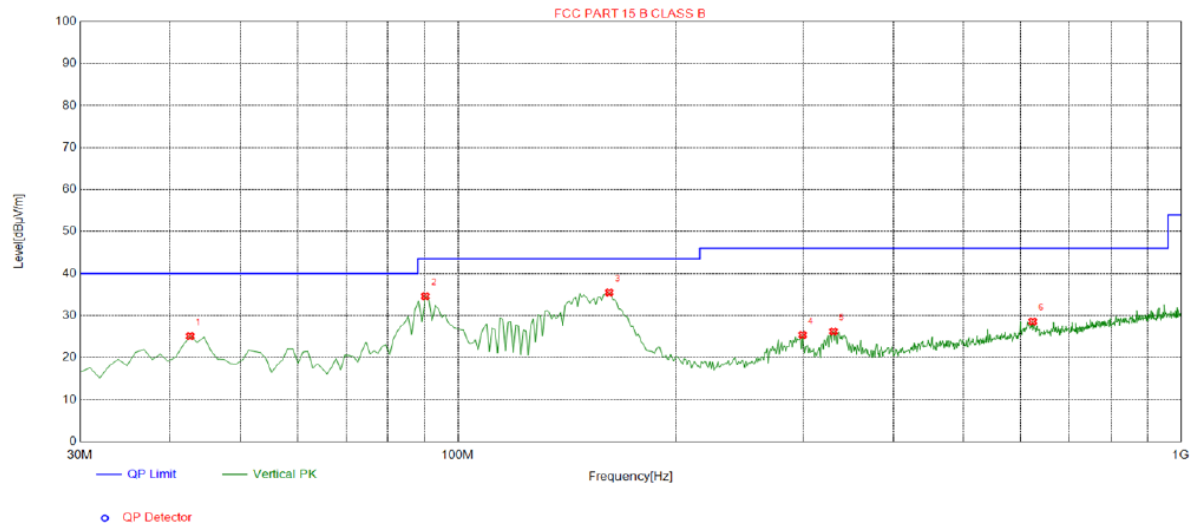

| Suspected List | | | | | | | | |
|----------------|-------------|----------------|-------------|----------------|-------------|-------------|-----------|----------|
| NO. | Freq. [MHz] | Level [dBµV/m] | Factor [dB] | Limit [dBµV/m] | Margin [dB] | Height [cm] | Angle [°] | Polarity |
| 1 | 42.6100 | 25.11 | -14.08 | 40.00 | 14.89 | 100 | 286 | Vertical |
| 2 | 90.1400 | 34.62 | -17.05 | 43.50 | 8.88 | 100 | 74 | Vertical |
| 3 | 161.920 | 35.52 | -18.04 | 43.50 | 7.98 | 100 | 200 | Vertical |
| 4 | 299.660 | 25.40 | -12.74 | 46.00 | 20.60 | 100 | 43 | Vertical |
| 5 | 330.700 | 26.24 | -11.59 | 46.00 | 19.76 | 100 | 216 | Vertical |
| 6 | 623.640 | 28.59 | -5.51 | 46.00 | 17.41 | 100 | 46 | Vertical |

Remark:
 Margin = Limit – Level
 Level=Test receiver reading + factor
 Factor= Antenna factor + cable loss- Amp factor

Harmonics and Spurious Emissions

Frequency Range (9 kHz-30MHz)

| Frequency (MHz) | Level@3m (dBµV/m) | Limit@3m (dBµV/m) |
|-----------------|-------------------|-------------------|
| -- | -- | -- |
| -- | -- | -- |
| -- | -- | -- |
| -- | -- | -- |

Note:1. Emission Level=Reading+ Cable loss+ Antenna factor-Amp factor

2. The emission levels are 20 dB below the limit value, which are not reported. It is deemed to comply with the requirement



Above 1 GHz Test Results:

CH Low (2402MHz)

Horizontal:

| Frequency | Reading Result | Factor | Emission Level | Limits | Margin | Detector Type |
|-----------|----------------|--------|----------------|----------|--------|---------------|
| (MHz) | (dBµV) | (dB) | (dBµV/m) | (dBµV/m) | (dB) | |
| 2402 | 111.14 | -5.81 | 105.33 | 114.00 | -8.67 | peak |
| 2402 | 87.35 | -5.81 | 81.54 | 94.00 | -12.46 | AVG |
| 4804 | 55.13 | -3.65 | 51.48 | 74.00 | -22.52 | peak |
| 4804 | 51.28 | -3.65 | 47.63 | 54.00 | -6.37 | AVG |
| 7206 | 57.03 | -0.95 | 56.08 | 74.00 | -17.92 | peak |
| 7206 | 40.38 | -0.95 | 39.43 | 54.00 | -14.57 | AVG |

Remark: Factor = Antenna Factor + Cable Loss – Pre-amplifier.

Vertical:

| Frequency | Reading Result | Factor | Emission Level | Limits | Margin | Detector Type |
|-----------|----------------|--------|----------------|----------|--------|---------------|
| (MHz) | (dBµV) | (dB) | (dBµV/m) | (dBµV/m) | (dB) | |
| 2402 | 110.47 | -5.81 | 104.66 | 114.00 | -9.34 | peak |
| 2402 | 83.25 | -5.81 | 77.44 | 94.00 | -16.56 | AVG |
| 4804 | 58.41 | -3.65 | 54.76 | 74.00 | -19.24 | peak |
| 4804 | 46.19 | -3.65 | 42.54 | 54.00 | -11.46 | AVG |
| 7206 | 59.66 | -0.95 | 58.71 | 74.00 | -15.29 | peak |
| 7206 | 42.02 | -0.95 | 41.07 | 54.00 | -12.93 | AVG |

Remark: Factor = Antenna Factor + Cable Loss – Pre-amplifier.



CH Middle (2441MHz)

Horizontal:

| Frequency | Reading Result | Factor | Emission Level | Limits | Margin | Detector Type |
|-----------|----------------|--------|----------------|----------------|--------|---------------|
| (MHz) | (dB μ V) | (dB) | (dB μ V/m) | (dB μ V/m) | (dB) | |
| 2441.00 | 107.74 | -5.73 | 102.01 | 114.00 | -11.99 | peak |
| 2441.00 | 85.26 | -5.73 | 79.53 | 94.00 | -14.47 | AVG |
| 4882.00 | 56.38 | -3.54 | 52.84 | 74.00 | -21.16 | peak |
| 4882.00 | 46.22 | -3.54 | 42.68 | 54.00 | -11.32 | AVG |
| 7323.00 | 55.07 | -0.81 | 54.26 | 74.00 | -19.74 | peak |
| 7323.00 | 40.69 | -0.81 | 39.88 | 54.00 | -14.12 | AVG |

Remark: Factor = Antenna Factor + Cable Loss – Pre-amplifier.

Vertical:

| Frequency | Reading Result | Factor | Emission Level | Limits | Margin | Detector Type |
|-----------|----------------|--------|----------------|----------------|--------|---------------|
| (MHz) | (dB μ V) | (dB) | (dB μ V/m) | (dB μ V/m) | (dB) | |
| 2441.00 | 107.12 | -5.73 | 101.39 | 114.00 | -12.61 | peak |
| 2441.00 | 85.66 | -5.73 | 79.93 | 94.00 | -14.07 | AVG |
| 4882.00 | 58.17 | -3.54 | 54.63 | 74.00 | -19.37 | peak |
| 4882.00 | 46.58 | -3.54 | 43.04 | 54.00 | -10.96 | AVG |
| 7323.00 | 58.02 | -0.81 | 57.21 | 74.00 | -16.79 | peak |
| 7323.00 | 38.75 | -0.81 | 37.94 | 54.00 | -16.06 | AVG |

Remark: Factor = Antenna Factor + Cable Loss – Pre-amplifier.



CH High (2480MHz)

Horizontal:

| Frequency | Reading Result | Factor | Emission Level | Limits | Margin | Detector Type |
|-----------|----------------|--------|----------------|----------------|--------|---------------|
| (MHz) | (dB μ V) | (dB) | (dB μ V/m) | (dB μ V/m) | (dB) | |
| 2480 | 109.45 | -5.63 | 103.82 | 114.00 | -10.18 | peak |
| 2480 | 86.36 | -5.63 | 80.73 | 94.00 | -13.27 | AVG |
| 4960 | 55.12 | -3.43 | 51.69 | 74.00 | -22.31 | peak |
| 4960 | 46.75 | -3.44 | 43.31 | 54.00 | -10.69 | AVG |
| 7440 | 57.15 | -0.77 | 56.38 | 74.00 | -17.62 | peak |
| 7440 | 38.52 | -0.77 | 37.75 | 54.00 | -16.25 | AVG |

Remark: Factor = Antenna Factor + Cable Loss – Pre-amplifier.

Vertical:

| Frequency | Reading Result | Factor | Emission Level | Limits | Margin | Detector Type |
|-----------|----------------|--------|----------------|----------------|--------|---------------|
| (MHz) | (dB μ V) | (dB) | (dB μ V/m) | (dB μ V/m) | (dB) | |
| 2480 | 110.74 | -5.63 | 105.11 | 114.00 | -8.89 | peak |
| 2480 | 81.55 | -5.63 | 75.92 | 94.00 | -18.08 | AVG |
| 4960 | 56.02 | -3.43 | 52.59 | 74.00 | -21.41 | peak |
| 4960 | 49.86 | -3.44 | 46.42 | 54.00 | -7.58 | AVG |
| 7440 | 53.28 | -0.77 | 52.51 | 74.00 | -21.49 | peak |
| 7440 | 39.69 | -0.77 | 38.92 | 54.00 | -15.08 | AVG |

Remark: Factor = Antenna Factor + Cable Loss – Pre-amplifier.

Remark :

- (1) Measuring frequencies from 1 GHz to the 25 GHz.
- (2) "F" denotes fundamental frequency; "H" denotes spurious frequency. "E" denotes band edge frequency.
- (3) * denotes emission frequency which appearing within the Restricted Bands specified in provision of 15.205, then the general radiated emission limits in 15.209 apply.
- (4) Data of measurement within this frequency range shown "---" in the table above means the reading of emissions are attenuated more than 20dB below the permissible limits or the field strength is too small to be measured.
- (5) The IF bandwidth of EMI Test Receiver between 30MHz to 1GHz was 120KHz, 1 MHz for measuring above 1 GHz, below 30MHz was 9KHz. The resolution bandwidth of test receiver/spectrum analyzer is 1MHz and video bandwidth is 3MHz for peak measurement with peak detector at frequency above 1GHz. The resolution bandwidth of test receiver/spectrum analyzer is 1MHz and video bandwidth is 10Hz for Average measurement with peak detection at frequency above 1GHz.
- (6) When the test results of Peak Detected below the limits of Average Detected, the Average Detected is not need completed. For example: Top Channel at Fundamental 73.16dBuV/m(PK Value) <93.98(AV Limit), at harmonic 53.20 dBuV/m(PK Value) <54 dBuV/m(AV Limit), the Average Detected not need to completed.
- (7) All modes of operation were investigated and the worst-case(GFSK) emissions is reported.



5 out of Band Emissions

5.1 Limits

FCC PART 15.249(d) Emissions radiated outside of the specified frequency bands, except for harmonics, shall be attenuated by at least 50 dB below the level of the fundamental or to the general radiated emission limits in §15.209, whichever is the lesser attenuation.

5.2 Test Procedure

The out of band emission should be measured by following guidance in ANSI C63.10:2013 with respect to maximizing the emission by rotating the EUT, measuring the emission while the EUT is situated in three orthogonal planes (if appropriate), adjusting the measurement antenna height and polarization ect.

1. The resolution bandwidth and video bandwidth of test receiver/spectrum analyzer is 120kHz for Quasi-peak detection (QP) at frequency below 1GHz.
2. The resolution bandwidth of test receiver/spectrum analyzer is 1 MHz and the video bandwidth is 3 MHz for Peak detection (PK) at frequency above 1GHz.
3. The resolution bandwidth of test receiver/spectrum analyzer is 1 MHz and the video bandwidth is 3 MHz for Average detection (AV) at frequency above 1GHz.

5.3 Test Result

PASS

All the test modes completed for test. The worst case of Band Edge is GFSK mode; the test data of this mode was reported.

Radiated Band Edge Test:

Operation Mode: TX CH Low (2402MHz)

Horizontal (Worst case):

| Frequency (MHz) | Reading Result (dB μ V) | Factor (dB) | Emission Level (dB μ V/m) | Limits (dB μ V/m) | Margin (dB) | Detector Type |
|--------------------|-----------------------------------|----------------|----------------------------------|--------------------------|----------------|------------------|
| 2310.00 | 59.77 | -5.81 | 53.96 | 74 | -20.04 | peak |
| 2310.00 | 40.25 | -5.81 | 34.44 | 54 | -19.56 | AVG |
| 2390.00 | 55.36 | -5.84 | 49.52 | 74 | -24.48 | peak |
| 2390.00 | 44.19 | -5.84 | 38.35 | 54 | -15.65 | AVG |
| 2400.00 | 54.28 | -5.84 | 48.44 | 74 | -25.56 | peak |
| 2400.00 | 39.07 | -5.84 | 33.23 | 54 | -20.77 | AVG |

Remark: Factor = Antenna Factor + Cable Loss – Pre-amplifier.



Vertical:

| Frequency | Reading Result | Factor | Emission Level | Limits | Margin | Detector Type |
|-----------|----------------|--------|----------------|----------------|--------|---------------|
| (MHz) | (dB μ V) | (dB) | (dB μ V/m) | (dB μ V/m) | (dB) | |
| 2310.00 | 62.14 | -5.81 | 56.33 | 74 | -17.67 | peak |
| 2310.00 | 42.66 | -5.81 | 36.85 | 54 | -17.15 | AVG |
| 2390.00 | 57.08 | -5.84 | 51.24 | 74 | -22.76 | peak |
| 2390.00 | 43.27 | -5.84 | 37.43 | 54 | -16.57 | AVG |
| 2400.00 | 53.16 | -5.84 | 47.32 | 74 | -26.68 | peak |
| 2400.00 | 39.45 | -5.84 | 33.61 | 54 | -20.39 | AVG |

Remark: Factor = Antenna Factor + Cable Loss – Pre-amplifier.

Operation Mode: TX CH High (2480MHz)

Horizontal (Worst case)

| Frequency | Reading Result | Factor | Emission Level | Limits | Margin | Detector Type |
|-----------|----------------|--------|----------------|----------------|--------|---------------|
| (MHz) | (dB μ V) | (dB) | (dB μ V/m) | (dB μ V/m) | (dB) | |
| 2483.50 | 55.66 | -5.81 | 49.85 | 74 | -24.15 | peak |
| 2483.50 | / | -5.81 | / | 54 | / | AVG |
| 2500.00 | 52.37 | -6.06 | 46.31 | 74 | -27.69 | peak |
| 2500.00 | / | -6.06 | / | 54 | / | AVG |

Remark: Factor = Antenna Factor + Cable Loss – Pre-amplifier.

Vertical:

| Frequency | Reading Result | Factor | Emission Level | Limits | Margin | Detector Type |
|-----------|----------------|--------|----------------|----------------|--------|---------------|
| (MHz) | (dB μ V) | (dB) | (dB μ V/m) | (dB μ V/m) | (dB) | |
| 2483.50 | 54.04 | -5.81 | 48.23 | 74 | -25.77 | peak |
| 2483.50 | / | -5.81 | / | 54 | / | AVG |
| 2500.00 | 51.32 | -6.06 | 45.26 | 74 | -28.74 | peak |
| 2500.00 | / | -6.06 | / | 54 | / | AVG |

Remark: Factor = Antenna Factor + Cable Loss – Pre-amplifier.

Remark: All the other emissions not reported were too low to read and deemed to comply with FCC limit.



6 OCCUPIED BANDWIDTH MEASUREMENT

6.1 Test Setup

Same as Radiated Emission Measurement

6.2 Test Procedure

1. The EUT was placed on a turn table which is 0.8m above ground plane.
2. Set EUT as normal operation.
3. Based on ANSI C63.10 section 6.9.2: RBW= 30KHz. VBW= 100 KHz, Span=2MHz.
4. The useful radiated emission from the EUT was detected by the spectrum analyser with peak detector.

6.3 Measurement Equipment Used

Same as Radiated Emission Measurement

6.4 Test Result

PASS

| Test Mode | Frequency | 20dB Bandwidth (MHz) | Result |
|---------------|-----------|-------------------------|-------------|
| GFSK | 2402 MHz | 1.038 | PASS |
| | 2441 MHz | 1.030 | PASS |
| | 2480 MHz | 1.039 | PASS |
| $\pi/4$ DQPSK | 2402 MHz | 1.285 | PASS |
| | 2441 MHz | 1.284 | PASS |
| | 2480 MHz | 1.281 | PASS |
| 8DPSK | 2402 MHz | 1.284 | PASS |
| | 2441 MHz | 1.284 | PASS |
| | 2480 MHz | 1.282 | PASS |



Test Mode: GFSK

CH: 2402MHz



CH: 2441MHz





CH: 2480MHz

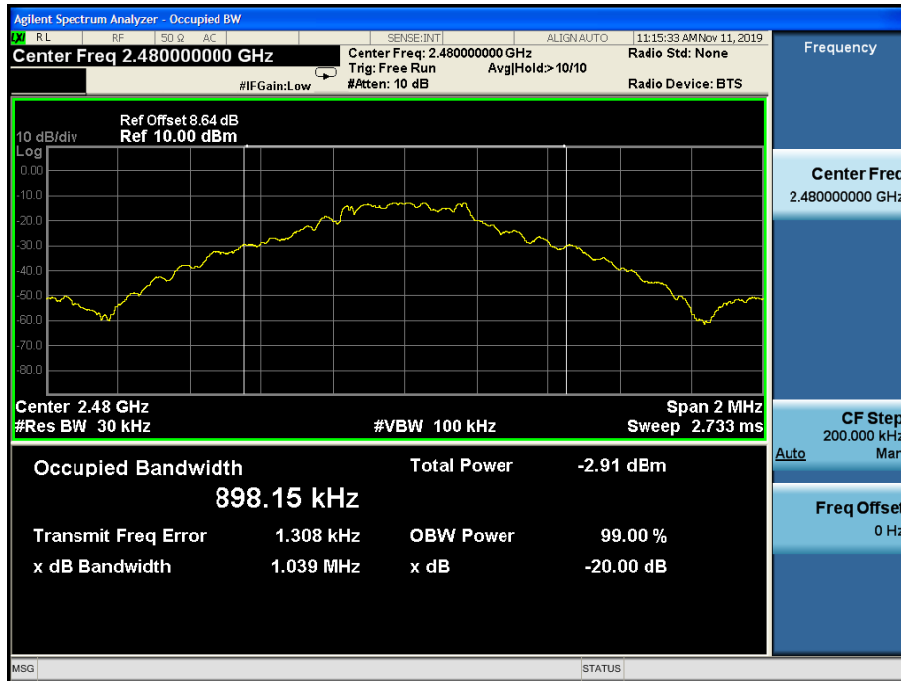

Test Mode: $\pi/4$ DQPSK

CH: 2402MHz

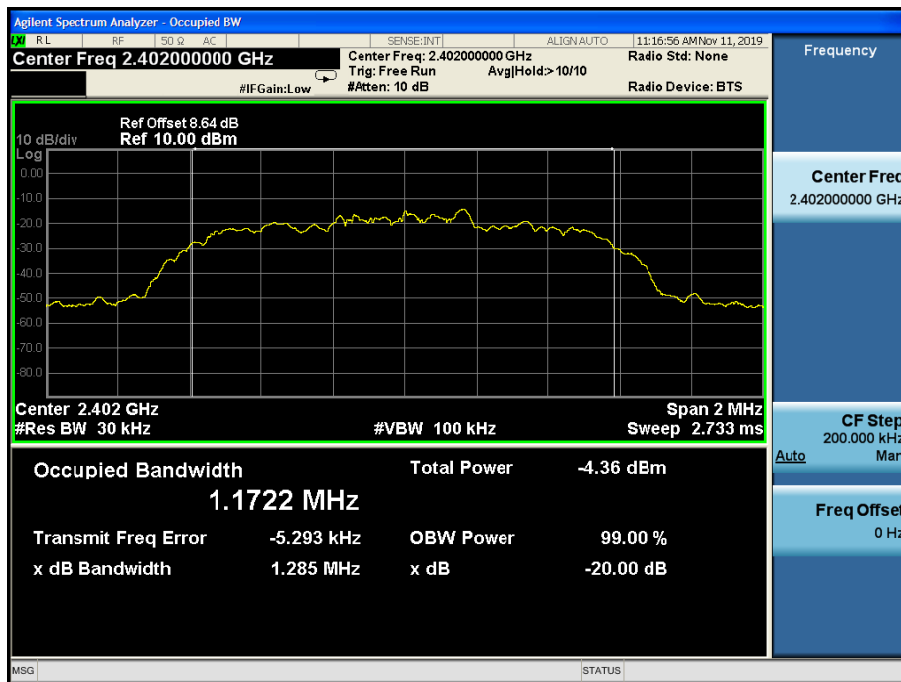



CH: 2441MHz

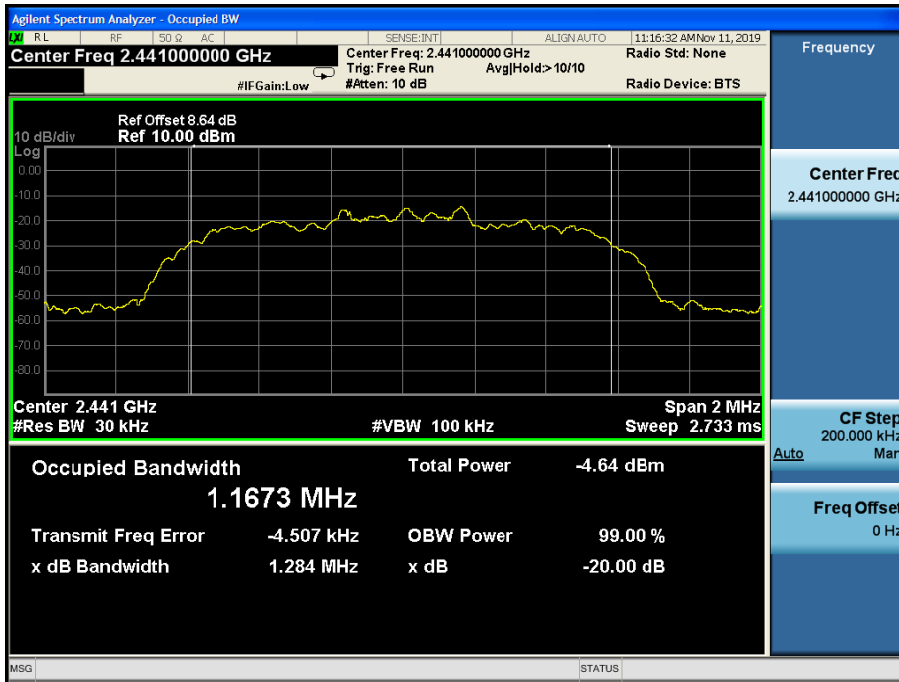

CH: 2480MHz

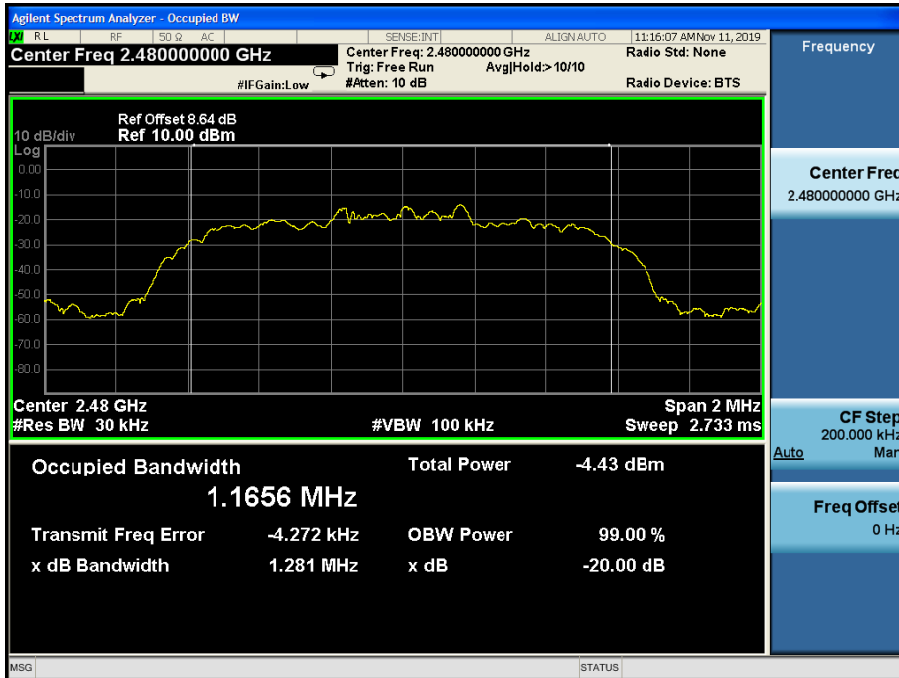



Test Mode: 8DPSK

CH: 2402MHz

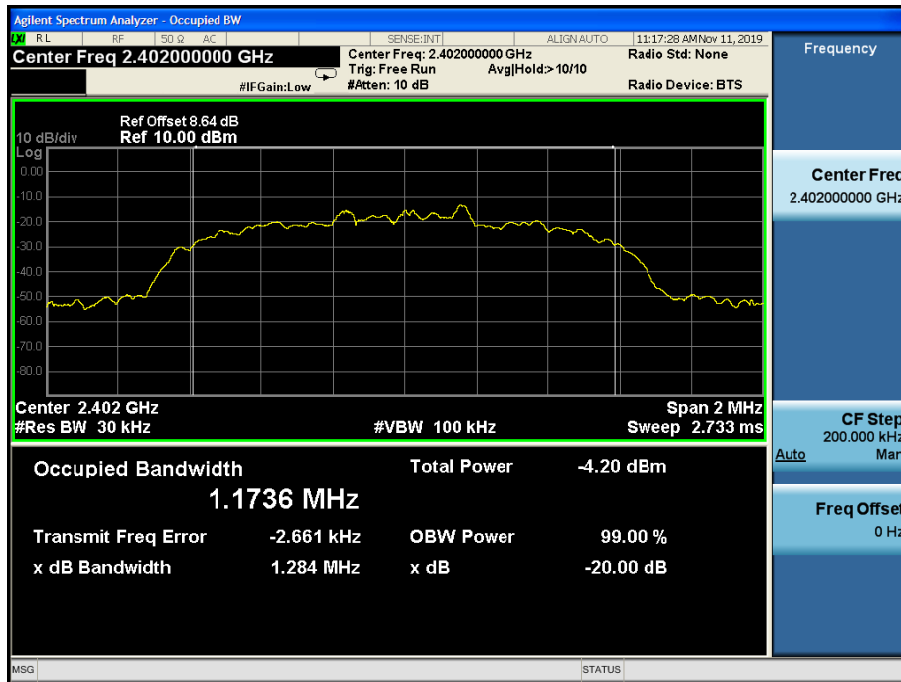

CH: 2441MHz

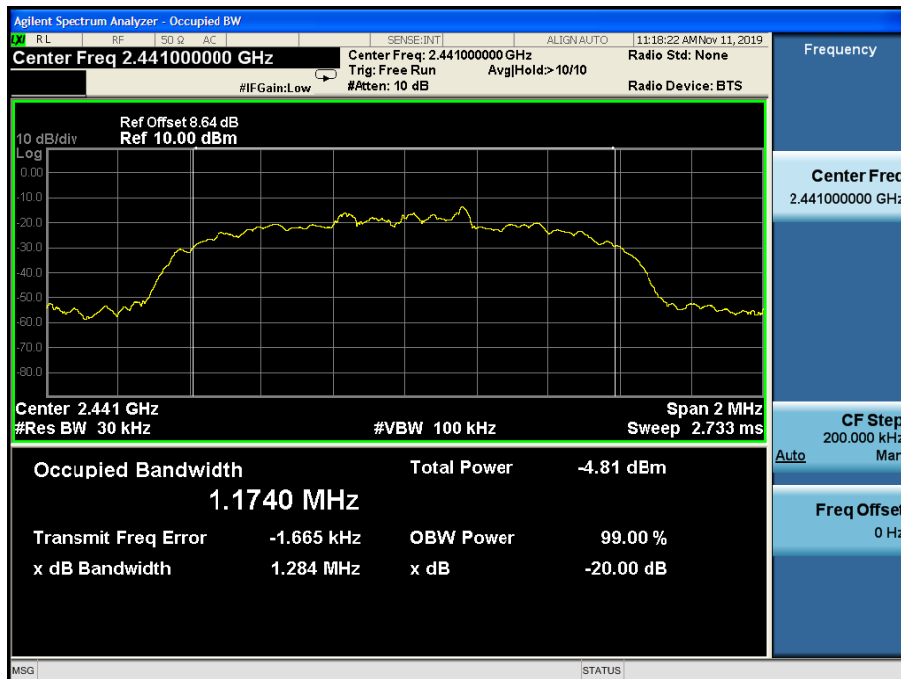



CH: 2480MHz

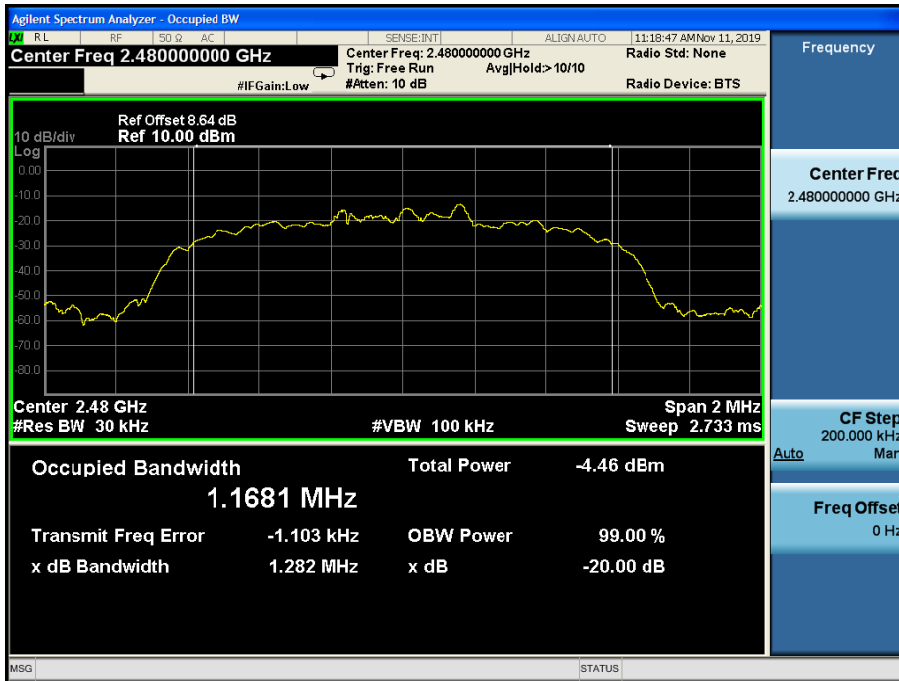

7 ANTENNA REQUIREMENT

Standard Applicable

For intentional device, according to FCC 47 CFR Section 15.203, an intentional radiator shall be designed to ensure that no antenna other than that furnished by the responsible party shall be used with the device. And according to FCC 47 CFR Section 15.249, if transmitting antennas of directional gain greater than 6dBi are used, the power shall be reduced by the amount in dB that the directional gain of the antenna exceeds 6dBi.

Antenna Connected Construction

The antenna used in this product is a PCB Antenna, The directional gains of antenna used for transmitting is 0dBi.

ANTENNA

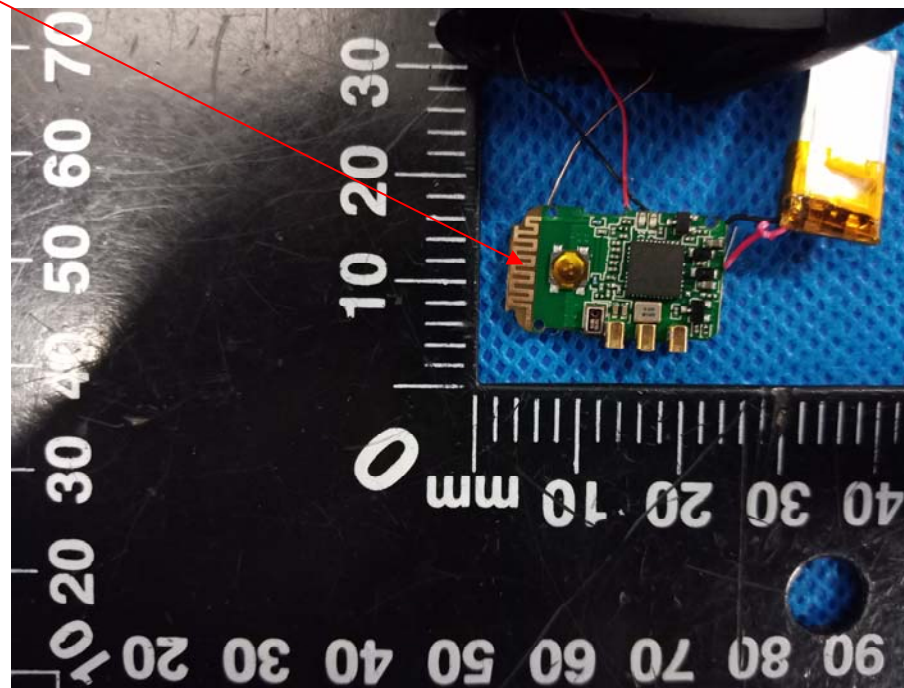



8 PHOTOGRAPH OF TEST

8.1 Radiated Emission

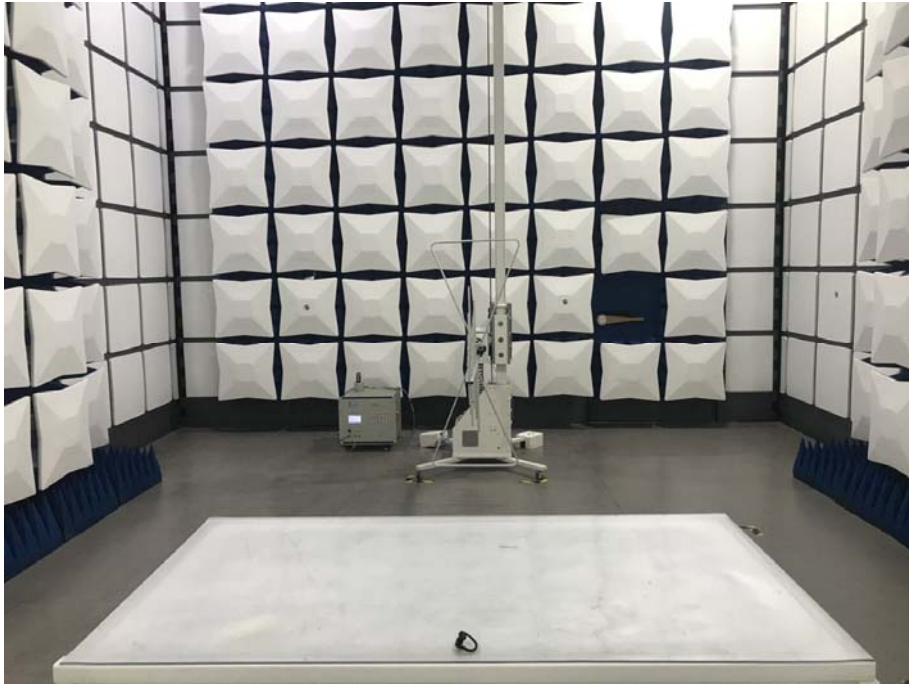

8.2 Conducted Emission





9 PHOTOGRAPH OF TEST

Reference to the report: ANNEX A of external photos and ANNEX B of Internal photos

-----End of test report-----