

Shenzhen Qianmu Communication Technology Co., Ltd

Shenzhen Qianmu Communication Technology Co., Ltd.

Acceptance of antenna sample

Applicable model	G01A		
Customer	Dongxin Taihe (Guangzhou) Co., Ltd.		
Specification description			
	Product content	Specification	Customer material code
description Specification	Bluetooth antenna	Electron wire, 0.6*25mm, single end exposed tin, black	04.11.00026
Change resume			
Serial number	Date	Version	Brief introduction of changes
1	2021-11-01	V1.0	New project
2			
3			

Supplier sample confirmation					
R&D	Structure	Audit	Judge		
			PASS <input checked="" type="checkbox"/>		
Customer sample confirmation					
Electron	Structure	Project	Procurement	Quality	Audit
Reasons for rejection or other precautions:					

1、 Matching circuit-BT antenna

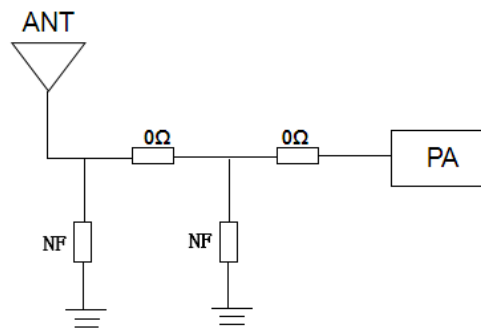

Your original matching circuit has not been changed

2、 BT antenna size



BT antenna diameter 0.6mm
length 25mm

3. WIFI/BT Antenna-Antenna Passive Efficiency and Gain

	A	B	C	D	E	F	G	H	I	J	K
1	Passive Test For 2.4GWIFI										
2	Freq	Effi	Effi	Gain	Gain	UHS	DHIS	Max	Min	Attenut	Attenut
3	(MHz)	(%)	(dB)	(dBi)	(dBd)	(%)	(%)	(dB)	(dB)	Hor	Ver
4	2400	18.36	-7.36	-1.71	-3.86	8.129	10.232	-1.71	-14.59	48.51	48.38
5	2410	19.44	-7.11	-1.48	-3.63	8.483	10.956	-1.48	-14.79	48.83	48.65
6	2420	19.83	-7.03	-1.41	-3.56	8.474	11.352	-1.41	-16.27	49.05	49
7	2430	19.14	-7.18	-1.72	-3.87	7.893	11.244	-1.72	-21.14	49.05	48.89
8	2440	18.43	-7.35	-1.8	-3.95	7.284	11.144	-1.8	-31.27	49.08	48.97
9	2450	18.52	-7.32	-1.19	-3.34	7.118	11.404	-1.19	-23.99	49.01	48.85
10	2460	17.78	-7.5	-0.93	-3.08	6.699	11.077	-0.93	-22.35	48.86	48.7
11	2470	17.32	-7.61	-0.81	-2.96	6.521	10.803	-0.81	-24.35	48.86	48.78
12	2480	16.81	-7.74	-0.96	-3.11	6.386	10.421	-0.96	-25.65	49.29	49.19
13	2490	18.25	-7.39	-0.53	-2.68	7.124	11.125	-0.53	-25.82	49.92	49.75
14	2500	17.68	-7.53	-0.81	-2.96	7.09	10.586	-0.81	-24.49	49.95	49.77
15	2400.00MHz - 2500.00MHz Gain										

4. Antenna Pattern and Apple Pattern

2400.000MHz E1

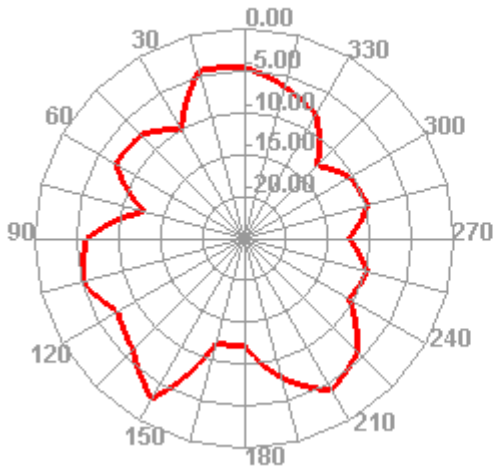

2400.000MHz E2

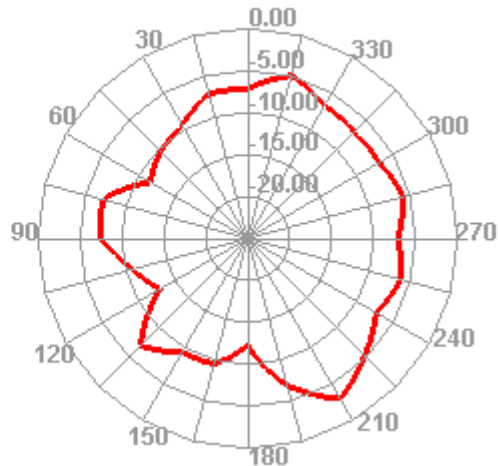

2450.000MHz E1

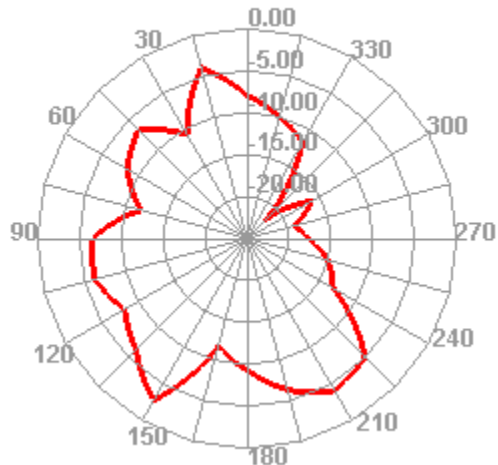

2450.000MHz E2

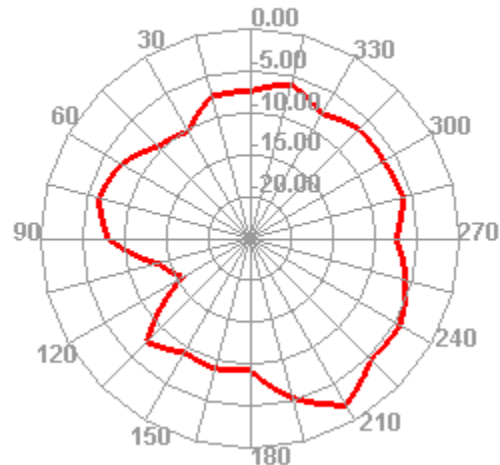

2500.000MHz E1

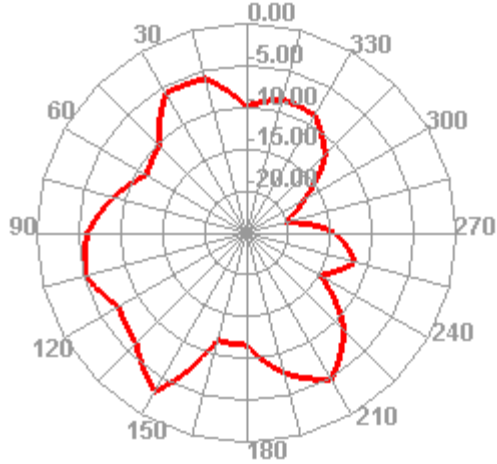

2500.000MHz E2

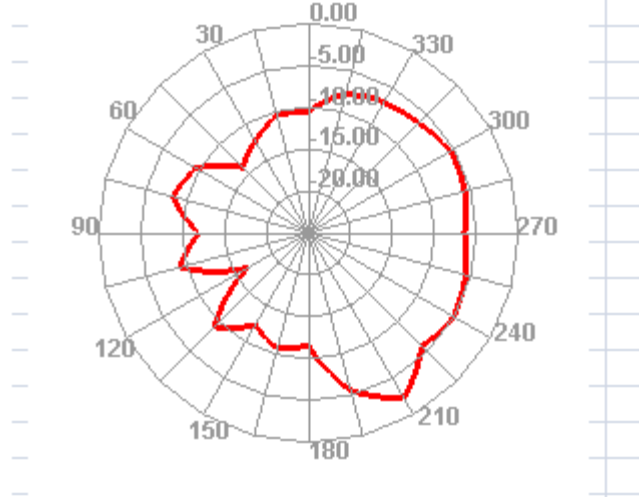

5. BT antenna type

Monopole

6、 Measurement of BT Antenna

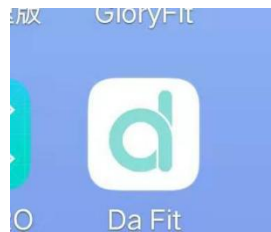

Test software

BT actual connection APP test:

1. Android mobile phone is connected with bracelet to control the straight distance of mobile phone singing room, which is more than 25 meters without barrier.
2. Bluetooth wire specification: L=25mm D=0.6mm

Music control test

7、 Structural drawing

2	3	4	5	6	7
---	---	---	---	---	---

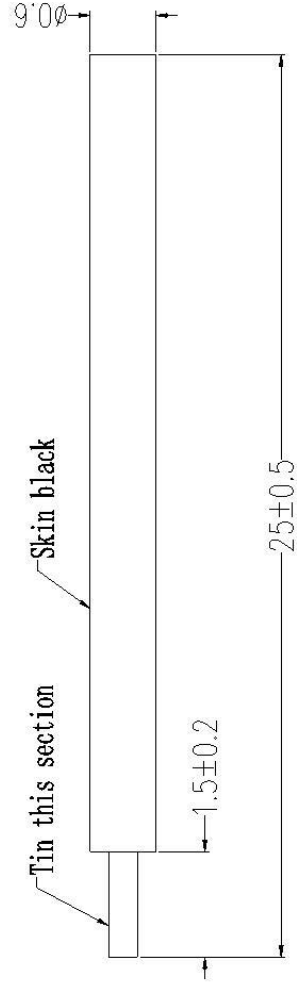

深圳市千目通讯科技有限公司									
ShenZhen QianMu Communication Technology Co., Ltd									
algorithm		DATE		DATE		DATE		DATE	
0~10	± 0.10	\circ	0.02	Design	2022/10/	Design	2022/10/	Design	KING
10~20	± 0.12	\odot	$\phi 0.03$	number		RE		number	LIUHO Z
20~40	± 0.15	\perp	0.02						
40~50	± 0.20	∇	0.04						
		∇	0.02						
POSITION					Company				
2	3	4	5	6	7	Company	DATE	DATE	DATE