

ENGINEERING TEST REPORT

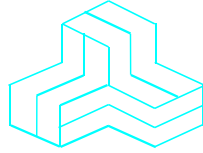

Scout Connected Adapter
Model: SKN
FCC ID: 2AJX2-SKN

Applicant:

Miovision Technologies Inc
148 Manitou Drive
Kitchener, Ontario
Canada N2C 1L3

In Accordance With

Federal Communications Commission (FCC)
Part 15, Subpart C, Section 15.247
Digital Modulation Systems (DTS) Operating in 2400 – 2483.5 MHz Band

UltraTech's File No.: 16SWIF019_FCC15C247DTS

This Test report is Issued under the Authority of
Tri M. Luu
Vice President of Engineering
UltraTech Group of Labs

Date: November 16, 2016

Report Prepared by: Dan Huynh

Tested by: Hung Trinh

Issued Date: November 16, 2016

Test Dates: October 7-19, 2016

- *The results in this Test Report apply only to the sample(s) tested, and the sample tested is randomly selected.*
- *This report must not be used by the client to claim product endorsement by NVLAP or any agency of the US Government.*
- *This test report shall not be reproduced, except in full, without a written approval from UltraTech*

UltraTech

3000 Bristol Circle, Oakville, Ontario, Canada, L6H 6G4
Tel.: (905) 829-1570 Fax.: (905) 829-8050
Website: www.ultratech-labs.com, Email: vic@ultratech-labs.com, Email: tri@ultratech-labs.com



91038



1309



46390-2049



AT-1945



SL2-IN-E-1119R



Korea
KCC-RRR
CA2049

TABLE OF CONTENTS

EXHIBIT 1. INTRODUCTION..... 1

1.1. SCOPE 1

1.2. RELATED SUBMITTAL(S)/GRANT(S)..... 1

1.3. NORMATIVE REFERENCES 1

EXHIBIT 2. PERFORMANCE ASSESSMENT..... 2

2.1. CLIENT INFORMATION 2

2.2. EQUIPMENT UNDER TEST (EUT) INFORMATION 2

2.3. EUT’S TECHNICAL SPECIFICATIONS 3

2.4. LIST OF EUT’S PORTS 3

2.5. ANCILLARY EQUIPMENT 4

EXHIBIT 3. EUT OPERATING CONDITIONS AND CONFIGURATIONS DURING TESTS..... 5

3.1. CLIMATE TEST CONDITIONS 5

3.2. OPERATIONAL TEST CONDITIONS & ARRANGEMENT FOR TESTS 5

EXHIBIT 4. SUMMARY OF TEST RESULTS..... 6

4.1. LOCATION OF TESTS..... 6

4.2. APPLICABILITY & SUMMARY OF EMC EMISSION TEST RESULTS 6

4.3. MODIFICATIONS INCORPORATED IN THE EUT FOR COMPLIANCE PURPOSES 6

EXHIBIT 5. TEST DATA 7

5.1. POWER LINE CONDUCTED EMISSIONS [§15.207(A)]..... 7

5.2. OCCUPIED BANDWIDTH [§ 15.247(A)(2)]..... 10

5.3. PEAK CONDUCTED OUTPUT POWER - DTS [§ 15.247(B)] 29

5.4. TRANSMITTER SPURIOUS RADIATED EMISSIONS AT 3 METERS [§§ 15.247(D), 15.209 & 15.205] 32

5.5. POWER SPECTRAL DENSITY [§ 15.247(E)]..... 54

5.6. RF EXPOSURE REQUIRMENTS [§§ 15.247(I), 1.1310 & 2.1091] 73

EXHIBIT 6. TEST EQUIPMENT LIST 75

EXHIBIT 7. MEASUREMENT UNCERTAINTY..... 76

7.1. LINE CONDUCTED EMISSION MEASUREMENT UNCERTAINTY 76

7.2. RADIATED EMISSION MEASUREMENT UNCERTAINTY 76

EXHIBIT 1. INTRODUCTION

1.1. SCOPE

Reference:	FCC Part 15, Subpart C, Section 15.247
Title:	Code of Federal Regulations (CFR), Title 47 – Telecommunication, Part 15 – Radio Frequency Devices
Purpose of Test:	Equipment Certification for Digital Modulation Systems (DTS) Transmitter Operating in the Frequency Band 2400-2483.5 MHz.
Test Procedures:	<ul style="list-style-type: none"> ▪ ANSI C63.4 ▪ ANSI C63.10 ▪ FCC KDB Publication No. 558074 D01 DTS Meas Guidance v03r05
Environmental Classification:	<input checked="" type="checkbox"/> Commercial, industrial or business environment <input type="checkbox"/> Residential environment

1.2. RELATED SUBMITTAL(S)/GRANT(S)

None.

1.3. NORMATIVE REFERENCES

Publication	Year	Title
47 CFR Parts 0-19	2016	Code of Federal Regulations (CFR), Title 47 – Telecommunication
ANSI C63.4	2014	American National Standard for Methods of Measurement of Radio-Noise Emissions from Low-Voltage Electrical and Electronic Equipment in the Range of 9 KHz to 40 GHz
ANSI C63.10	2013	American National Standard of Procedures for Compliance Testing of Unlicensed Wireless Devices
CISPR 22 & EN 55022	2008-09, Edition 6.0 2006	Information Technology Equipment - Radio Disturbance Characteristics - Limits and Methods of Measurement
CISPR 16-1-1 +A1 +A2	2006 2006 2007	Specification for radio disturbance and immunity measuring apparatus and methods. Part 1-1: Measuring Apparatus
CISPR 16-1-2 +A1 +A2	2003 2004 2006	Specification for radio disturbance and immunity measuring apparatus and methods. Part 1-2: Conducted disturbances
FCC, KDB Publication No. 558074 D01 DTS Meas Guidance v03r05	2016	Guidance for Performing Compliance Measurements on Digital Transmission Systems (DTS) Operating Under §15.247

EXHIBIT 2. PERFORMANCE ASSESSMENT

2.1. CLIENT INFORMATION

APPLICANT	
Name:	Miovision Technologies Inc
Address:	148 Manitou Dr #101 Kitchener, Ontario Canada N2C 1L3
Contact Person:	Ms. Bobbi Holte Phone #: 519-513-2407 Fax #: N/A Email Address: bholte@miovision.com

MANUFACTURER	
Name:	Miovision Technologies Inc
Address:	148 Manitou Dr #101 Kitchener, Ontario Canada N2C 1L3
Contact Person:	Ms. Bobbi Holte Phone #: 519-513-2407 Fax #: N/A Email Address: bholte@miovision.com

2.2. EQUIPMENT UNDER TEST (EUT) INFORMATION

The following information (with the exception of the Date of Receipt) has been supplied by the applicant.

Brand Name:	Miovision Technologies Inc
Product Name:	Scout Connected Adapter
Model Name or Number:	SKN
Serial Number:	Test Sample
Type of Equipment:	Digital Transmission System (DTS)
Input Power Supply Type:	5.0 VDC
Primary User Functions of EUT:	The EUT uses WiFi and Cellular technology to facilitate communication between a host unit and a cloud-based user portal.

2.3. EUT’S TECHNICAL SPECIFICATIONS

Transmitter	
Equipment Type:	Mobile
Intended Operating Environment:	Commercial, industrial or business environment
Power Supply Requirement:	5.0 VDC
RF Output Power Rating:	802.11b: 17.74 dBm (59.43 mW) 802.11g: 20.19 dBm (104.47 mW) 802.11n: 20.28 dBm (106.66 mW)
Operating Frequency Range:	2412-2472 MHz
RF Output Impedance:	50 Ω
Duty Cycle:	Continuous
Modulation Type:	As per the 802.11 bgn protocol.
Antenna Connector Types:	Integral
Antenna Description:	Manufacturer: Jumanji Type: Antenna flex Model: N/A (customer) Frequency Range: 2412 to 2484 MHz Gain (dBi): 2.0 dBi

2.4. LIST OF EUT’S PORTS

Port Number	EUT’s Port Description	Number of Identical Ports	Connector Type	Cable Type (Shielded/Non-shielded)
1	USB101	1	USB Power Input	Shielded
2	USB102	1	USB	Shielded
3	USB103	1	USB 2.0 Full speed	Shielded
4	SW501	1	50 ohm RF connector to Wi-Fi radio	Shielded

2.5. ANCILLARY EQUIPMENT

The EUT was tested while connected to the following representative configuration of ancillary equipment necessary to exercise the ports during tests:

Ancillary Equipment # 1	
Description:	Laptop
Brand name:	Lenovo
Model Name or Number:	ThinkPad
Connected to EUT's Port:	USB

Ancillary Equipment # 2	
Description:	Laptop AC Adapter
Brand name:	Lenovo
Model Name or Number:	ADLX45NCC2A
Connected to EUT's Port:	N/A

EXHIBIT 3. EUT OPERATING CONDITIONS AND CONFIGURATIONS DURING TESTS

3.1. CLIMATE TEST CONDITIONS

The climate conditions of the test environment are as follows:

Temperature:	21 to 23 °C
Humidity:	45 to 58%
Pressure:	102 kPa
Power Input Source:	5.0 VDC

3.2. OPERATIONAL TEST CONDITIONS & ARRANGEMENT FOR TESTS

Operating Modes:	The transmitter was operated in a continuous transmission mode with the carrier modulated as specified in the Test Data.
Special Test Software:	Test software provided by the Applicant to operate the EUT at each channel frequency continuously and in the range of typical modes of operation.
Special Hardware Used:	None.
Transmitter Test Antenna:	The EUT is tested with the antenna fitted in a manner typical of normal intended use as integral antenna equipment as described with the test results.

Transmitter Test Signals	
Frequency Band(s):	2412 - 2472 MHz
Frequency(ies) Tested:	2412, 2437, 2462, 2467, 2472
RF Power Output: (measured maximum output power at antenna terminals)	802.11b: 17.74 dBm (59.43 mW) 802.11g: 20.19 dBm (104.47 mW) 802.11n: 20.28 dBm (106.66 mW)
Normal Test Modulation:	DSSS/OFDM
Modulating Signal Source:	Internal

EXHIBIT 4. SUMMARY OF TEST RESULTS

4.1. LOCATION OF TESTS

All of the measurements described in this report were performed at Ultratech Group of Labs located in the city of Oakville, Province of Ontario, Canada.

- AC Power Line Conducted Emissions were performed in UltraTech's shielded room, 24'(L) by 16'(W) by 8'(H).
- Radiated Emissions were performed at the Ultratech's 3-10 TDK Semi-Anechoic Chamber situated in the Town of Oakville, province of Ontario. This test site been calibrated in accordance with ANSI C63.4, and found to be in compliance with the requirements of Sec. 2.948 of the FCC Rules. The descriptions and site measurement data of the Oakville 3-10 TDK Semi-Anechoic Chamber has been filed with FCC office (FCC File No.: 91038) and Industry Canada office (Industry Canada File No.: 2049A-3). Expiry Date: 2017-04-02.

4.2. APPLICABILITY & SUMMARY OF EMC EMISSION TEST RESULTS

FCC Section(s)	Test Requirements	Compliance (Yes/No)
15.203	Antenna requirements	Yes
15.207(a)	AC Power Line Conducted Emissions	Yes
15.247(a)(2)	6 dB Bandwidth	Yes
15.247(b)(3)	Peak Conducted Output Power - DTS	Yes
15.247(d), 15.209 & 15.205	Transmitter Spurious Radiated Emissions	Yes
15.247(e)	Power Spectral Density	Yes
15.247(i), 1.1307, 1.1310, 2.1091	RF Exposure	Yes

4.3. MODIFICATIONS INCORPORATED IN THE EUT FOR COMPLIANCE PURPOSES

None.

EXHIBIT 5. TEST DATA

5.1. POWER LINE CONDUCTED EMISSIONS [§15.207(a)]

5.1.1. Limit(s)

The equipment shall meet the limits of the following table:

Frequency of emission (MHz)	Conducted Limits (dBµV)	
	Quasi-peak	Average
0.15–0.5	66 to 56*	56 to 46*
0.5–5	56	46
5–30	60	50

*Decreases linearly with the logarithm of the frequency

5.1.2. Method of Measurements

ANSI C63.4-2014

5.1.3. Test Arrangement

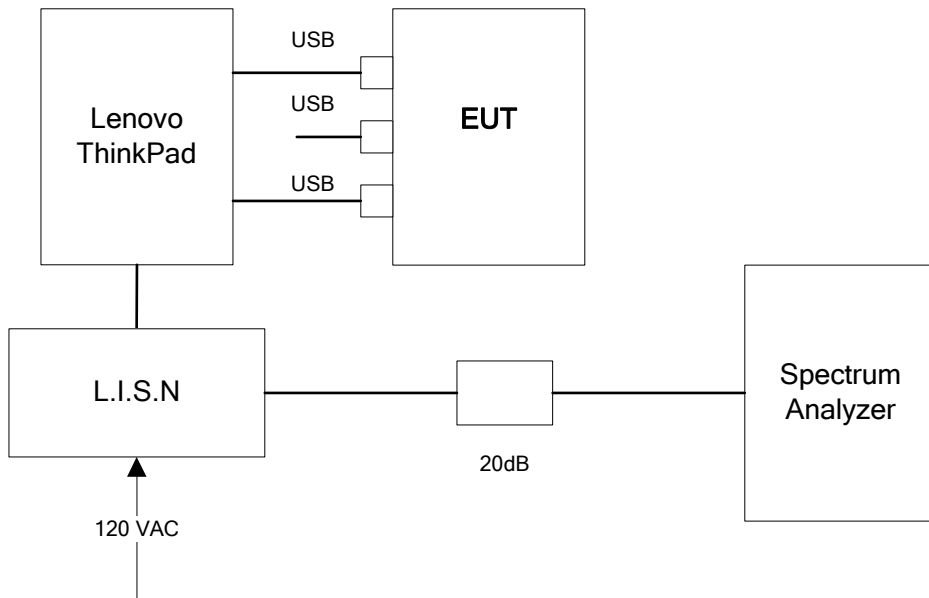

5.1.4. Test Data

Plot 5.1.4.1. Power Line Conducted Emissions; Line Voltage: 120 VAC; Line Tested: Hot

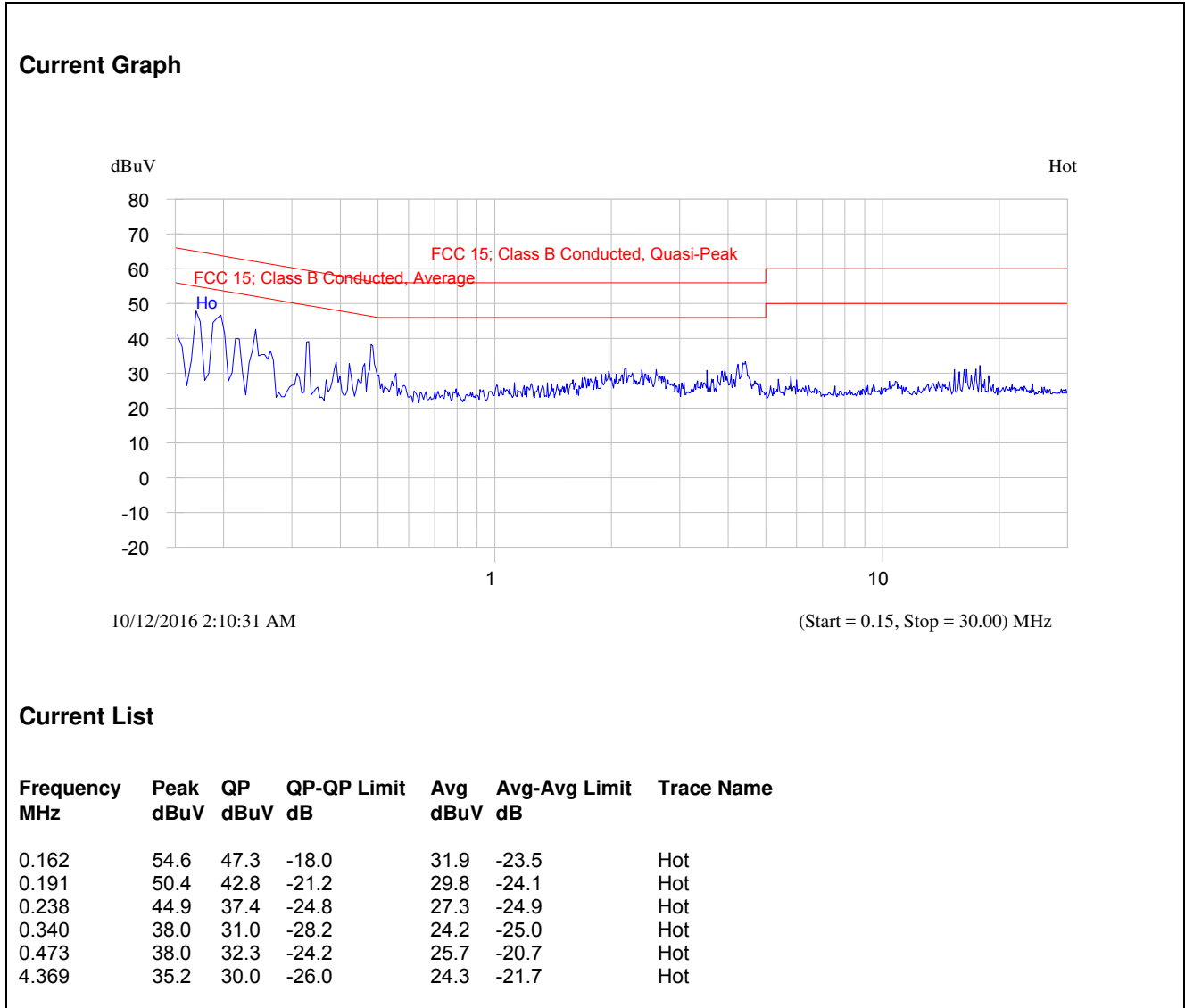

Plot 5.1.4.2. Power Line Conducted Emissions; Line Voltage 120 VAC; Line Tested: Neutral

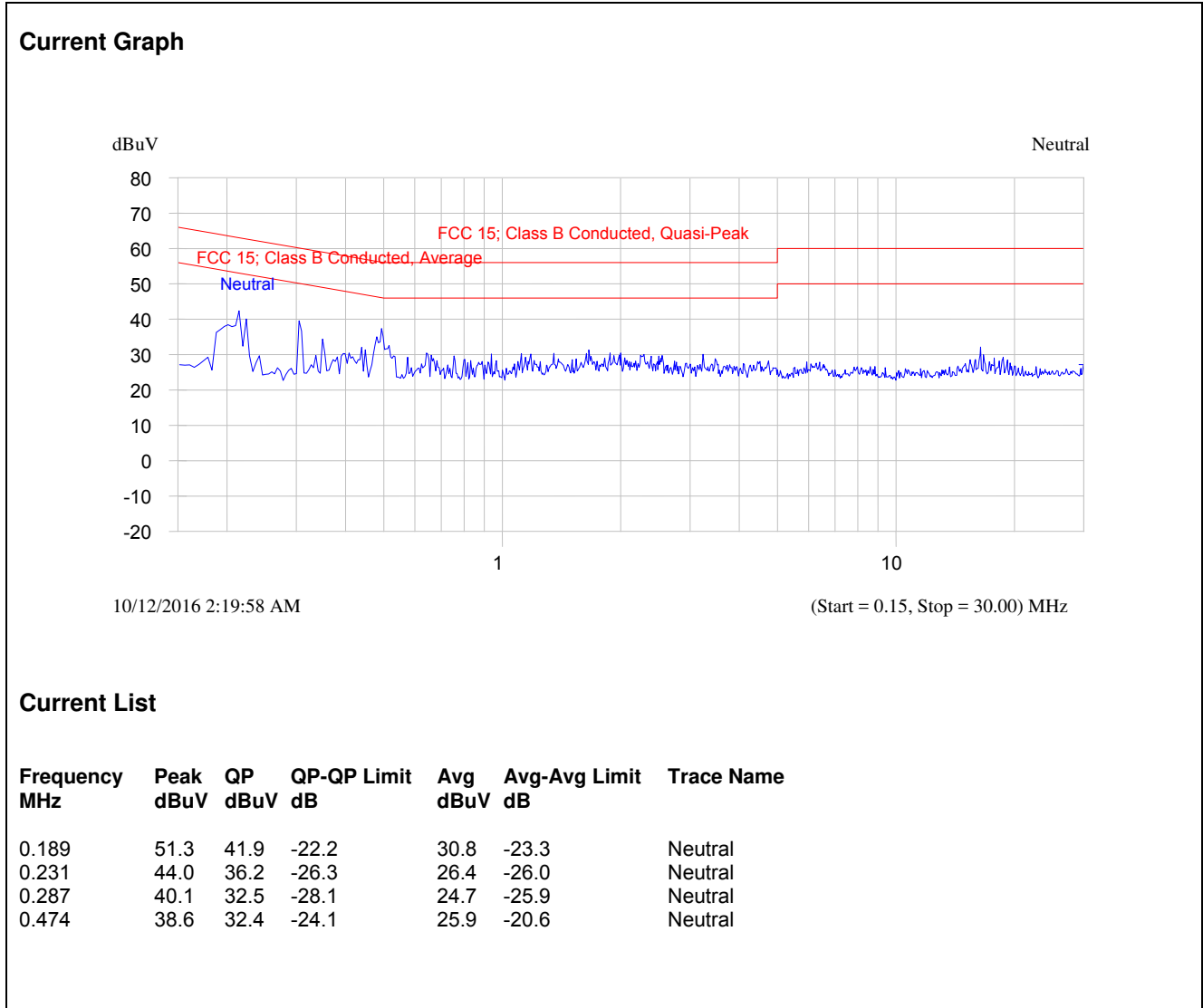

5.2. OCCUPIED BANDWIDTH [§ 15.247(a)(2)]

5.2.1. Limit(s)

The minimum 6 dB bandwidth shall be at least 500 kHz.

5.2.2. Method of Measurements

KDB 558074 D01 DTS Meas Guidance v03r05, Section 8.0 DTS bandwidth Option 1 Method

5.2.3. Test Arrangement

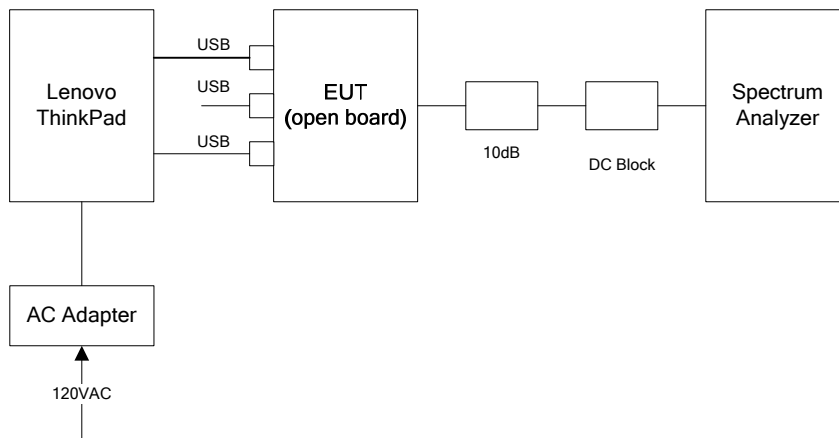

5.2.4. Test Data

Remark(s): Exploratory tests performed to determined worst-case test configurations, the following test results represent the worst-case.

802.11b					
Modulation	Data Rate (Mbps)	Frequency (MHz)	6dB BW (MHz)	Software Rate #	Power Setting
DBPSK	1	2412	9.97	1	0
		2437	10.07	1	0
		2472	9.97	1	1
DQPSK	2	2412	10.07	2	0
		2437	10.07	2	0
		2472	9.97	2	1
CCK	5.5	2412	9.97	3	0
		2437	9.92	3	0
		2472	9.42	3	1

802.11g					
Modulation	Data Rate (Mbps)	Frequency (MHz)	6dB BW (MHz)	Software Rate #	Power Setting
BPSK	6	2412	15.15	6	0
		2437	15.15	6	0
		2472	15.15	6	8
QPSK	12	2412	15.15	8	0
		2437	15.15	8	0
		2472	15.15	8	8
16-QAM	24	2412	16.55	10	0
		2437	16.55	10	0
		2472	16.55	10	8
64-QAM	48	2412	16.55	12	0
		2437	16.55	12	0
		2472	16.55	12	8

802.11n					
Modulation	Data Rate (Mbps)	Frequency (MHz)	6dB BW (MHz)	Software Rate #	Power Setting
BPSK 1/2 MCS 0	6.5	2412	15.15	14	0
		2437	15.15	14	0
		2472	15.15	14	10
QPSK 1/2 MCS 1	13	2412	15.15	15	0
		2437	15.15	15	0
		2472	15.15	15	10
16-QAM 1/2 MCS 3	26	2412	17.82	17	0
		2437	17.82	17	0
		2472	17.82	17	10
64-QAM 2/3 MCS 5	52	2412	17.82	19	0
		2437	17.82	19	0
		2472	17.82	19	10

Plot 5.2.4.1. 6 dB Bandwidth, 802.11b, DBPSK 1 Mbps, 2412 MHz, Power Setting 0

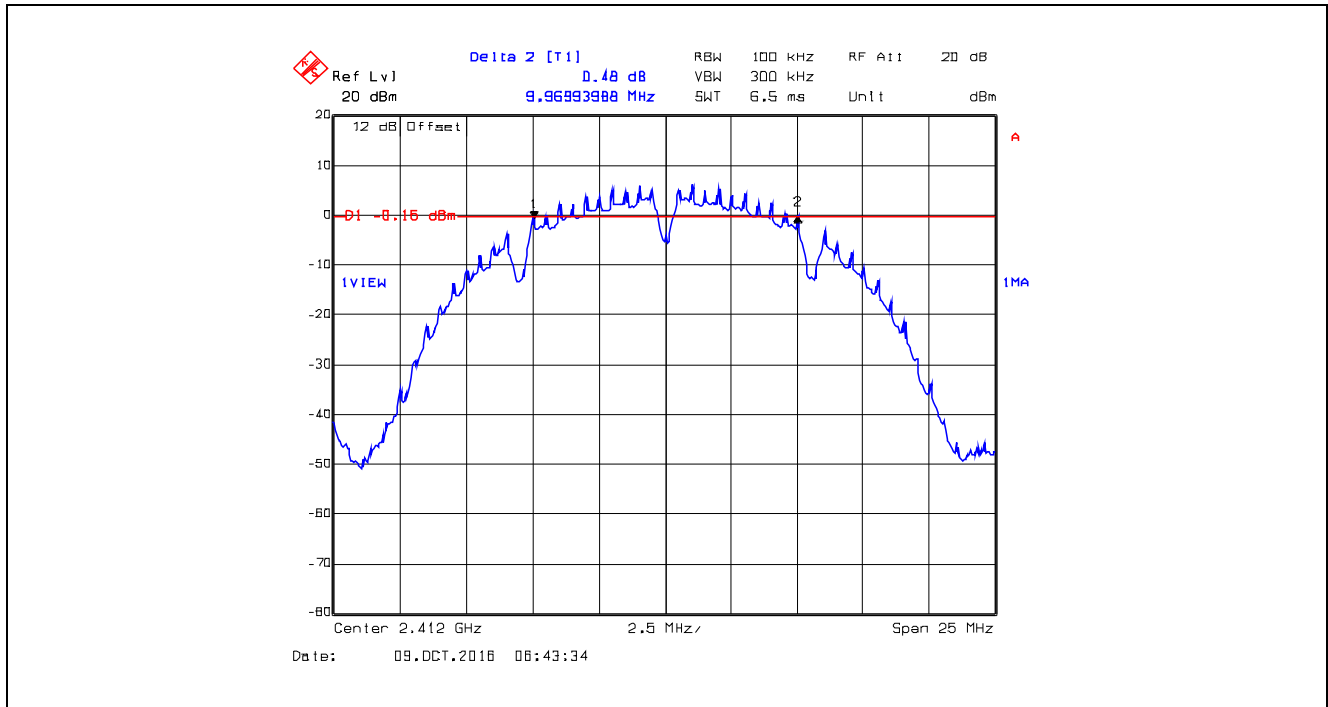

Plot 5.2.4.2. 6 dB Bandwidth, 802.11b, DBPSK 1 Mbps, 2437 MHz, Power Setting 0

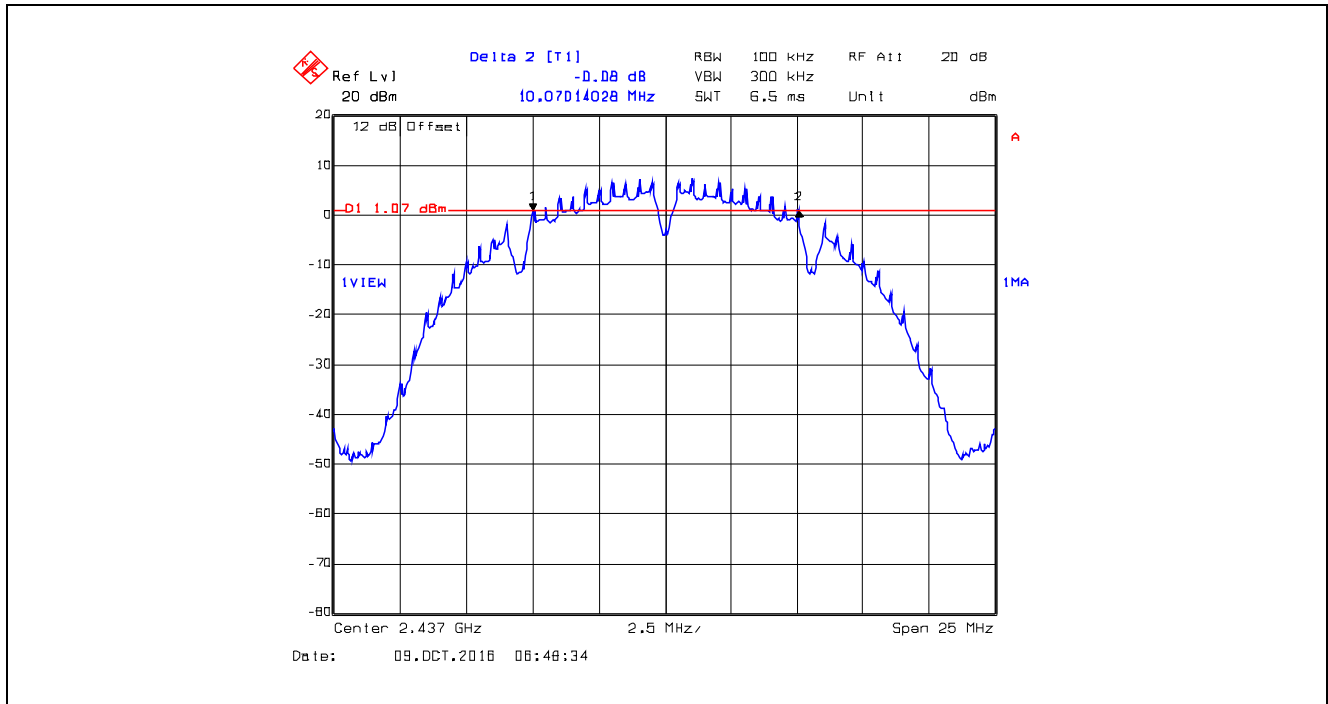

Plot 5.2.4.3. 6 dB Bandwidth, 802.11b, DBPSK 1 Mbps, 2472 MHz, Power Setting 1

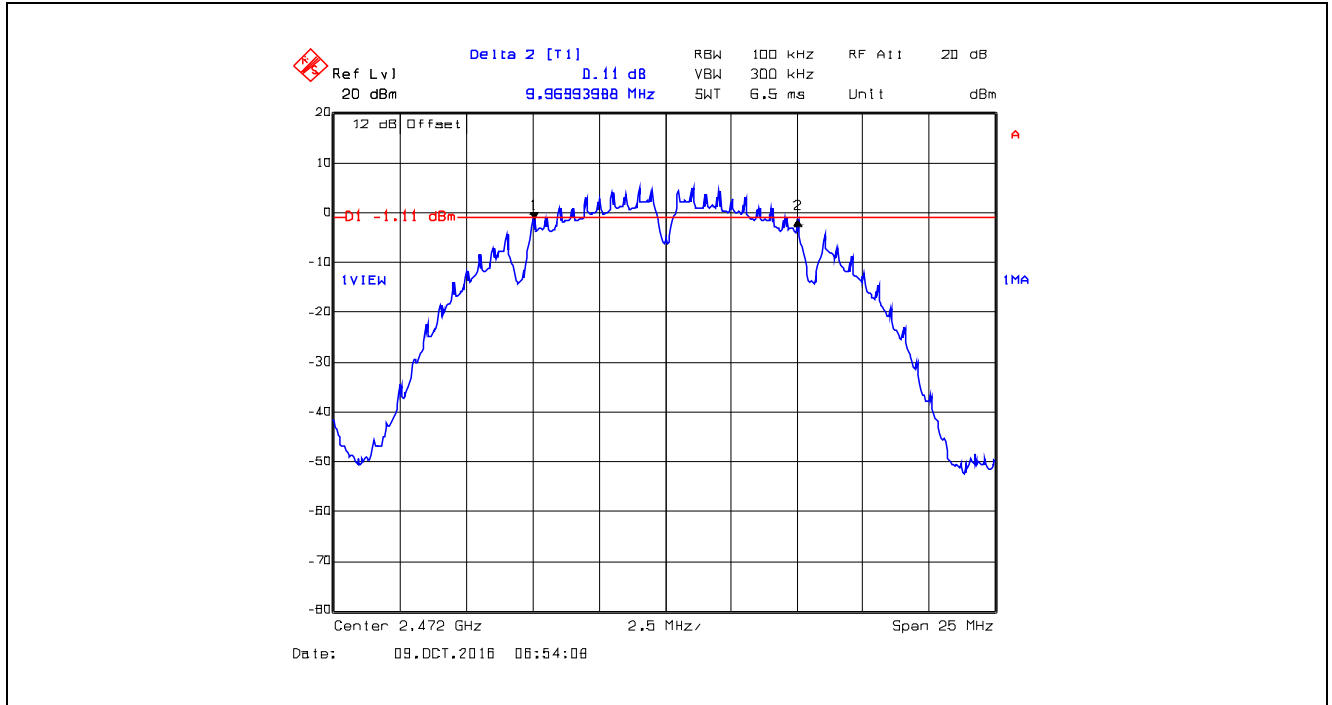

Plot 5.2.4.4. 6 dB Bandwidth, 802.11b, DQPSK 2 Mbps, 2412 MHz, Power Setting 0

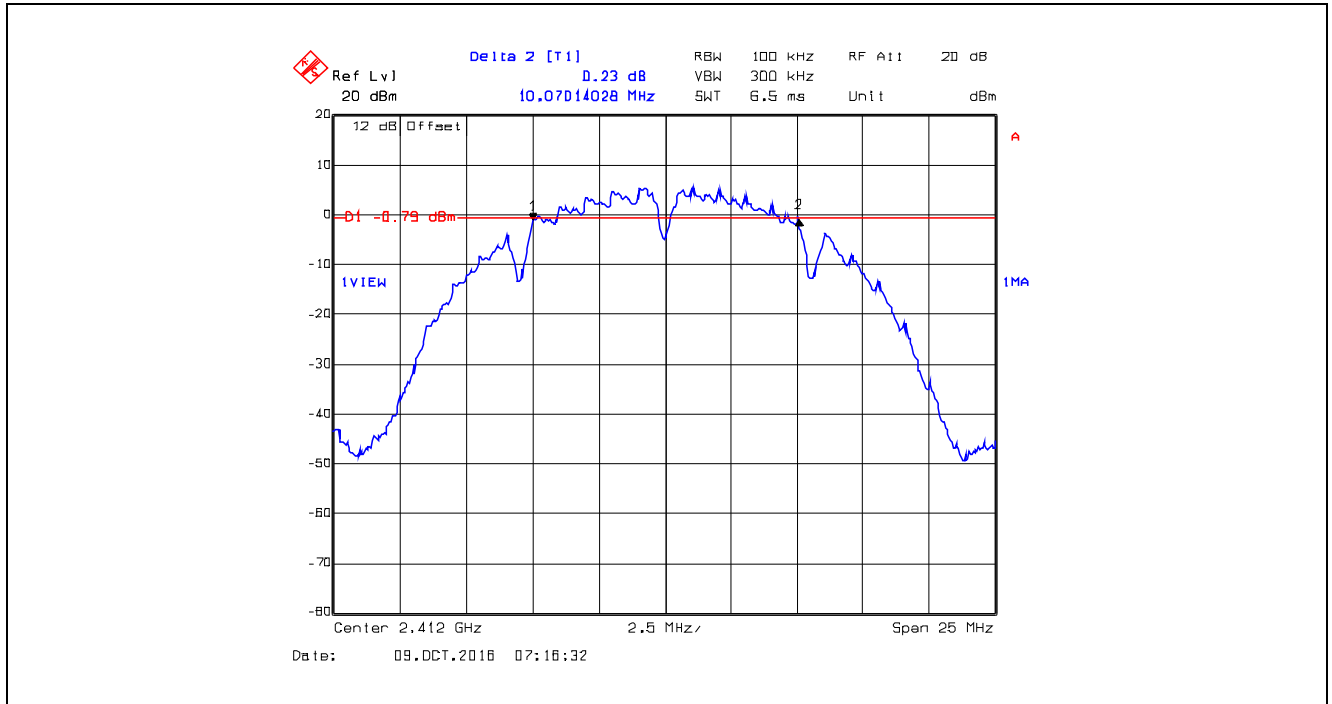

Plot 5.2.4.5. 6 dB Bandwidth, 802.11b, DQPSK 2 Mbps, 2437 MHz, Power Setting 0

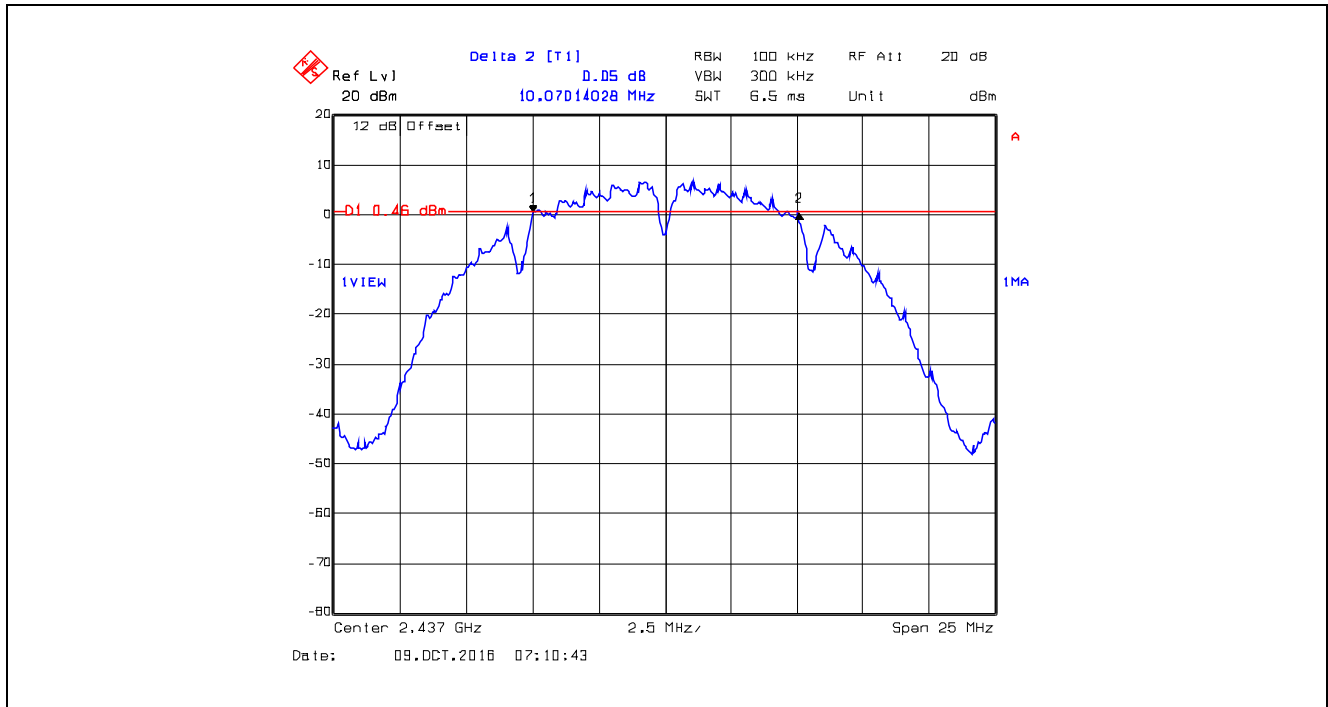

Plot 5.2.4.6. 6 dB Bandwidth, 802.11b, DQPSK 2 Mbps, 2472 MHz, Power Setting 1

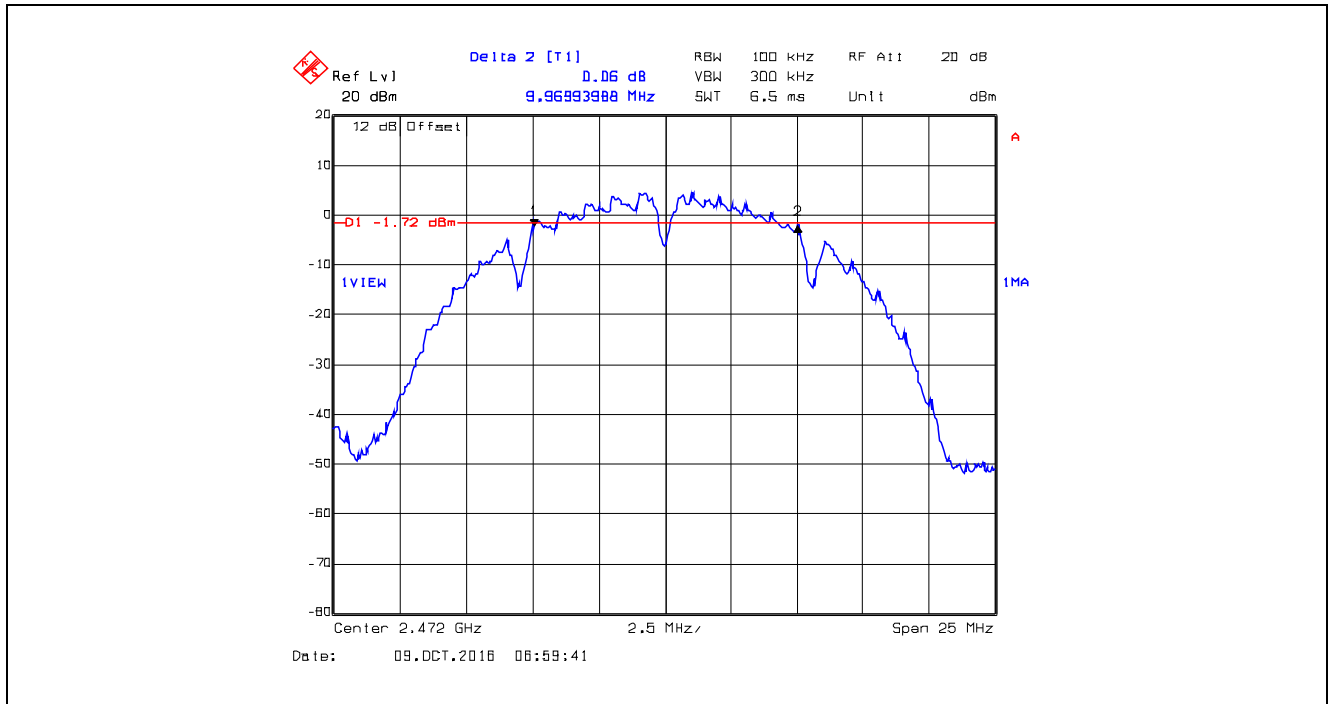

Plot 5.2.4.7. 6 dB Bandwidth, 802.11b, CCK 5.5 Mbps, 2412 MHz, Power Setting 0

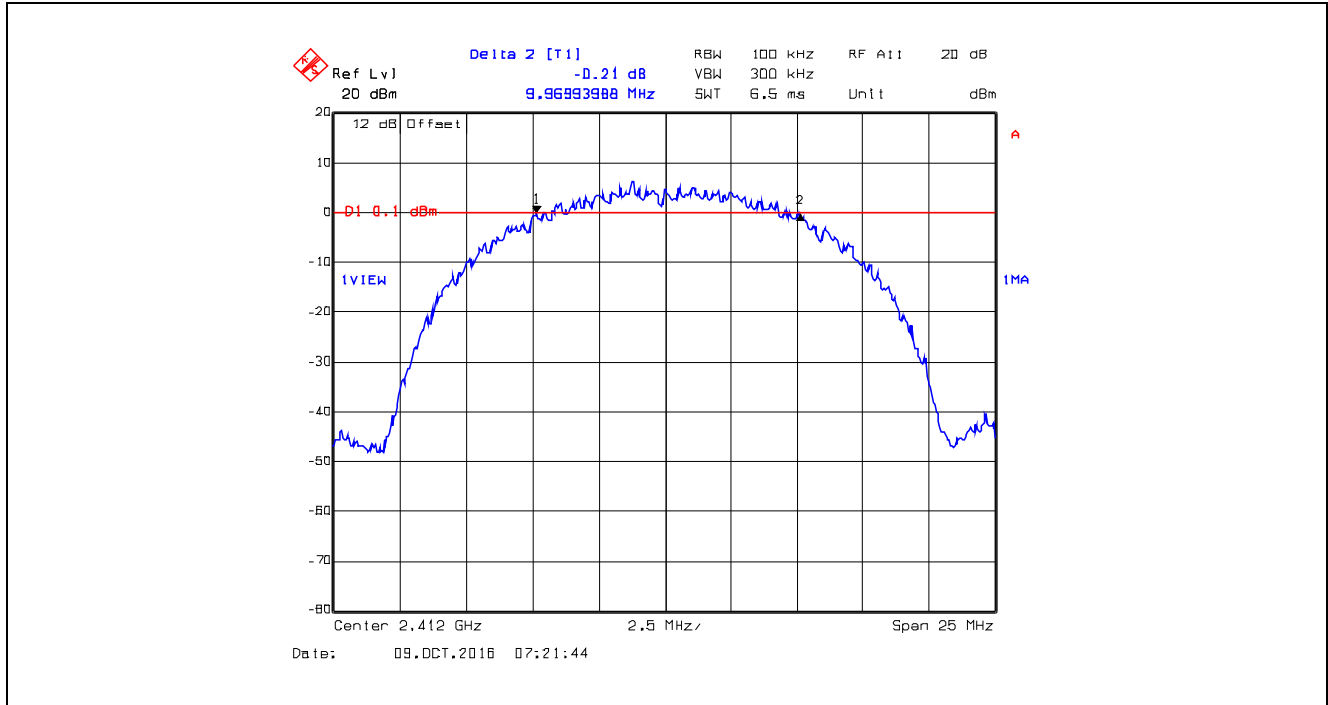

Plot 5.2.4.8. 6 dB Bandwidth, 802.11b, CCK 5.5 Mbps, 2437 MHz, Power Setting 0

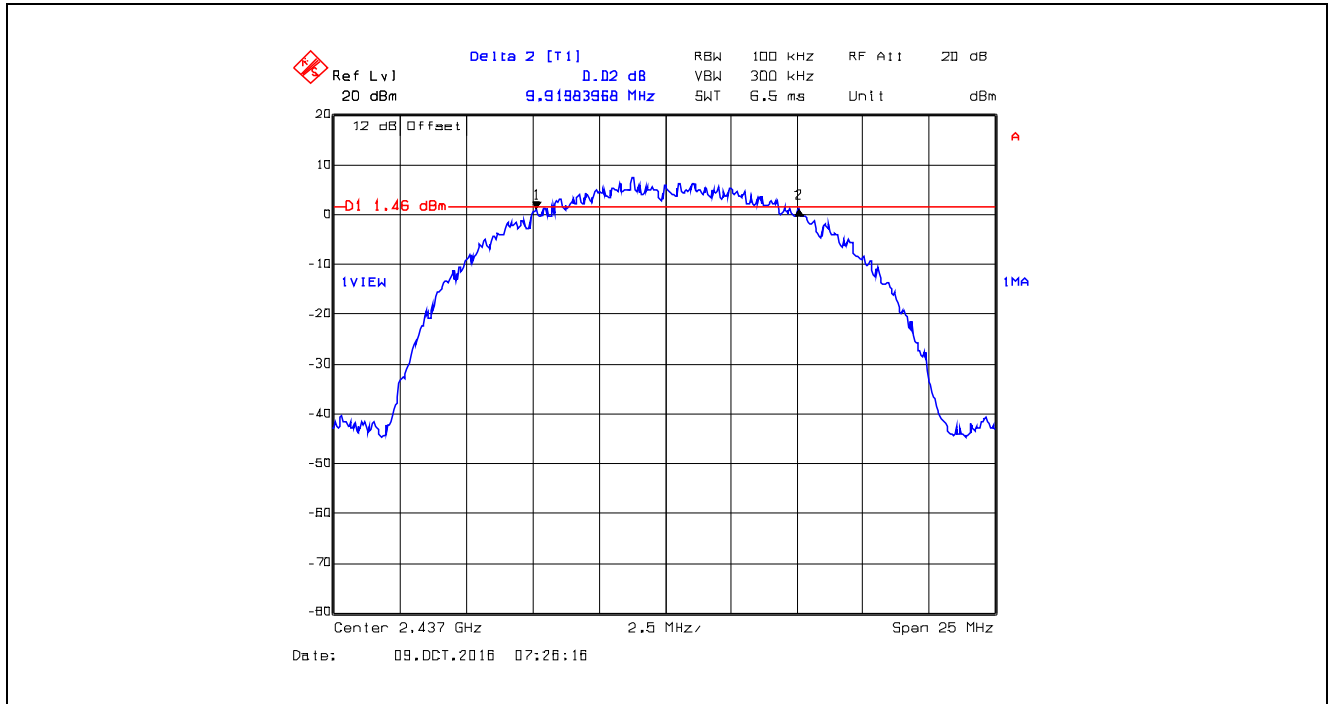

Plot 5.2.4.9. 6 dB Bandwidth, 802.11b, CCK 5.5 Mbps, 2472 MHz, Power Setting 1

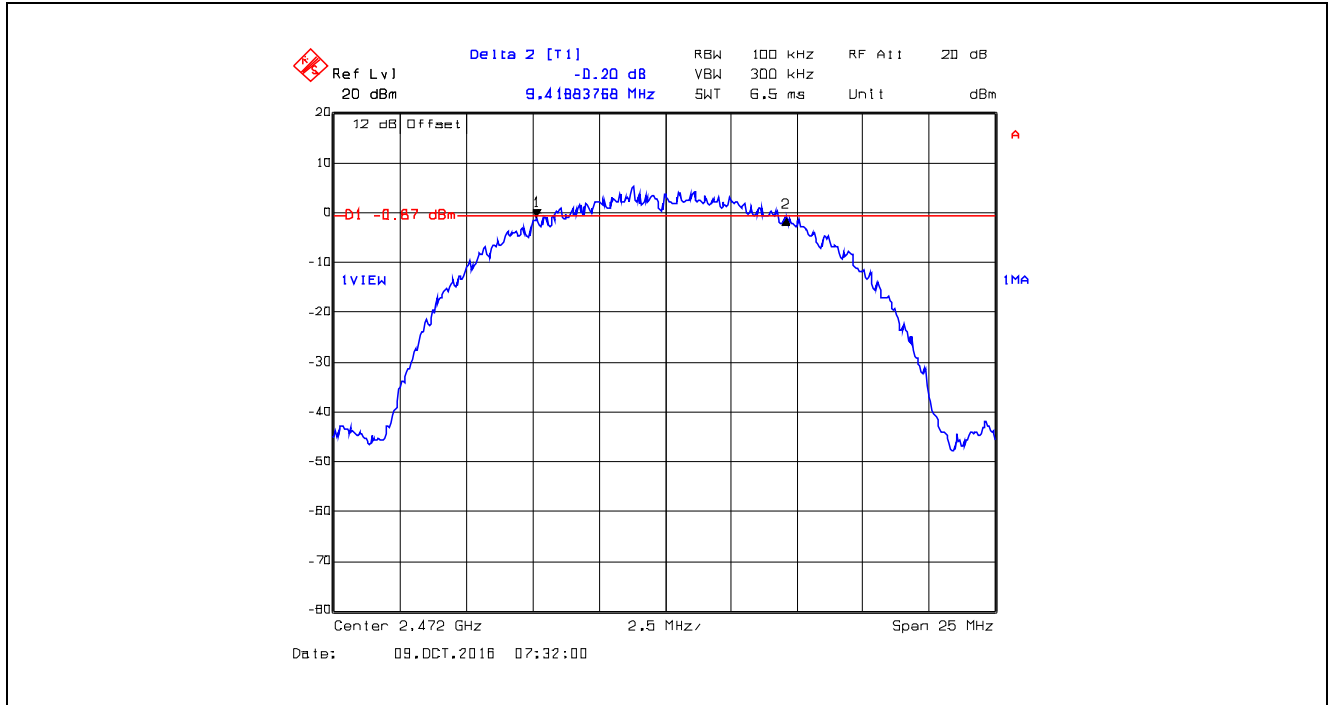

Plot 5.2.4.10. 6 dB Bandwidth, 802.11g, BPSK 6 Mbps, 2412 MHz, Power Setting 0

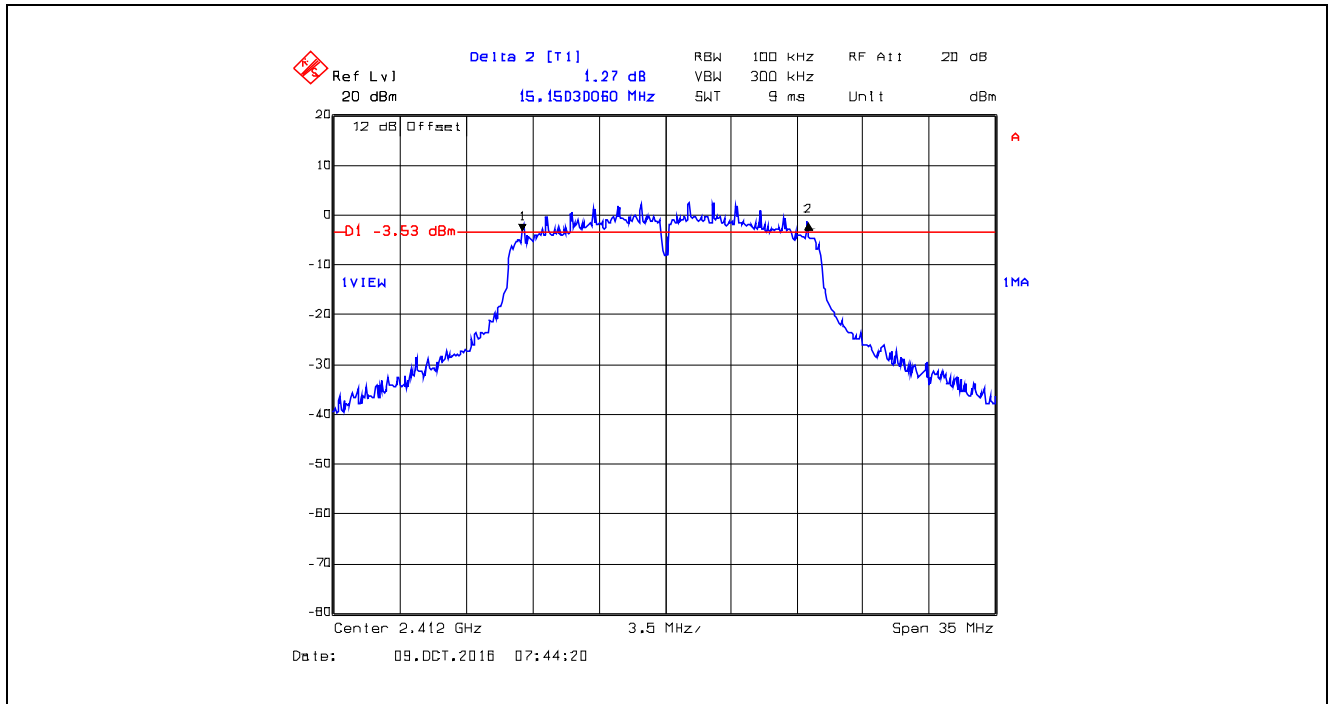

Plot 5.2.4.11. 6 dB Bandwidth, 802.11g, BPSK 6 Mbps, 2437 MHz, Power Setting 0

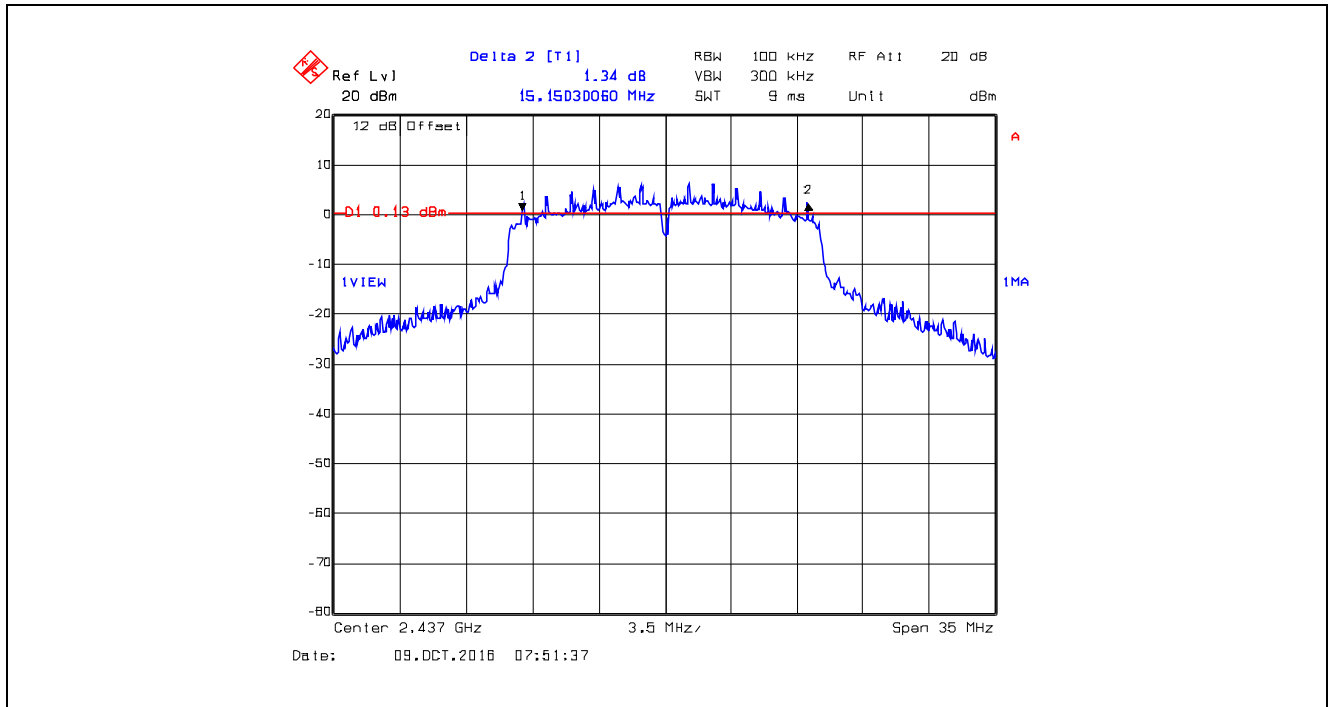

Plot 5.2.4.12. 6 dB Bandwidth, 802.11g, BPSK 6 Mbps, 2472 MHz, Power Setting 8

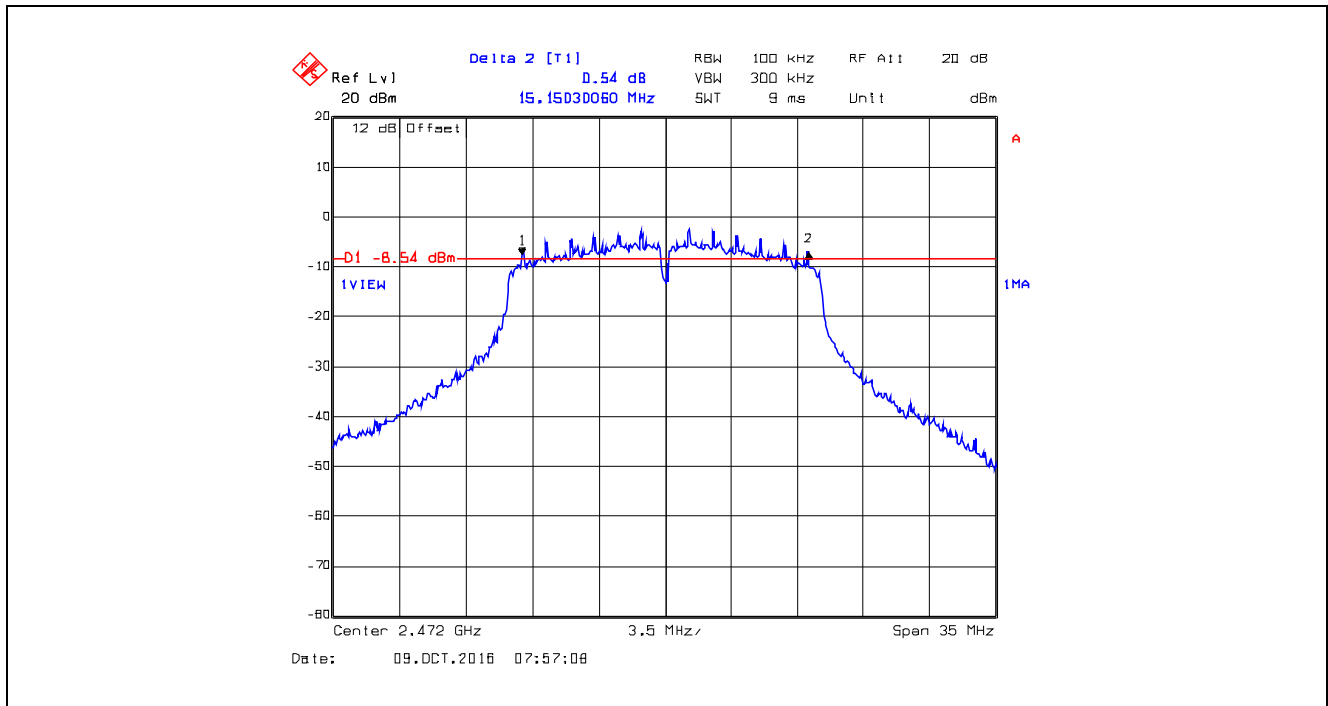

Plot 5.2.4.13. 6 dB Bandwidth, 802.11g, QPSK 12 Mbps, 2412 MHz, Power Setting 0

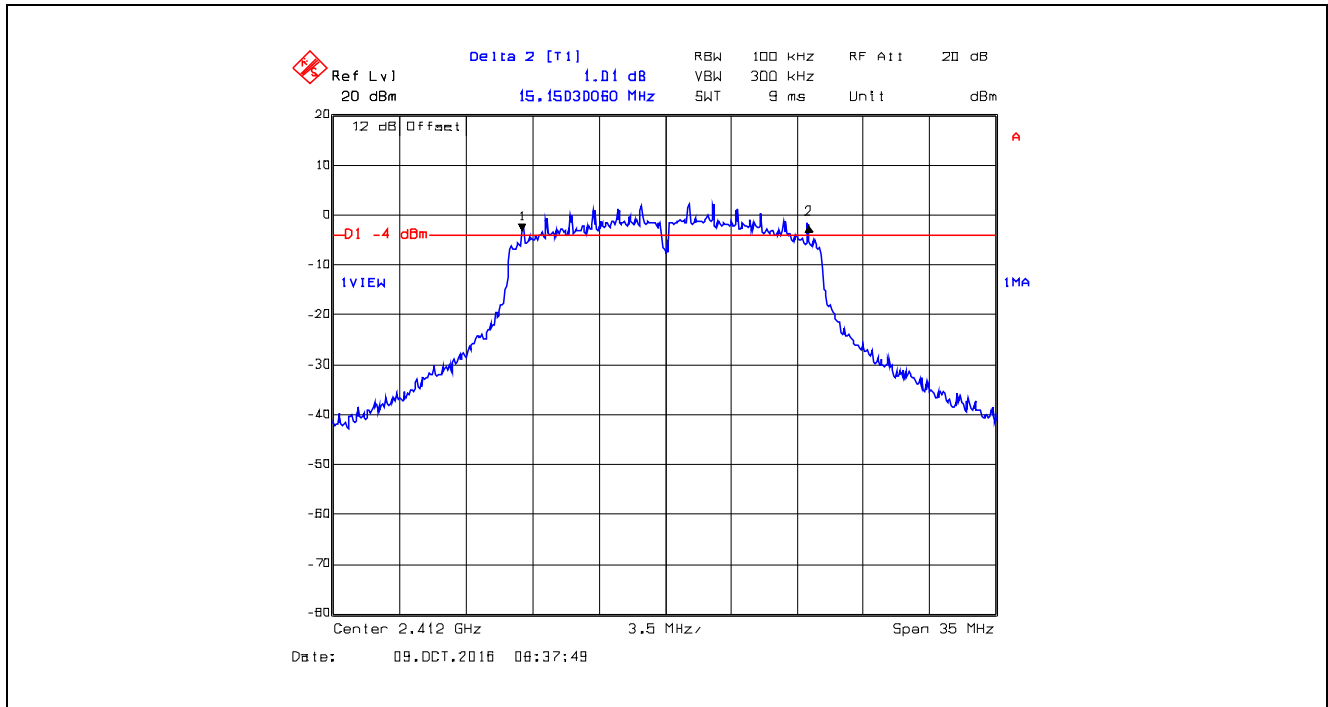

Plot 5.2.4.14. 6 dB Bandwidth, 802.11g, QPSK 12 Mbps, 2437 MHz, Power Setting 0

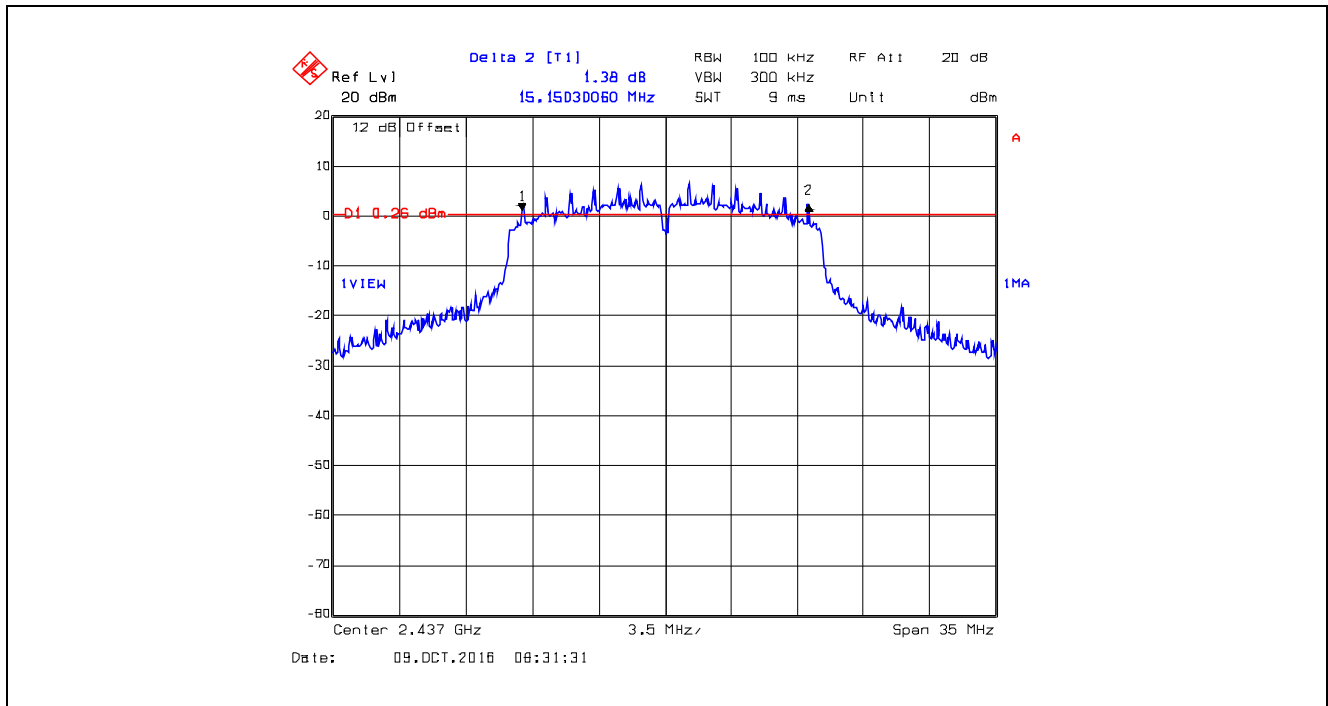

Plot 5.2.4.15. 6 dB Bandwidth, 802.11g, QPSK 12 Mbps, 2472 MHz, Power Setting 8

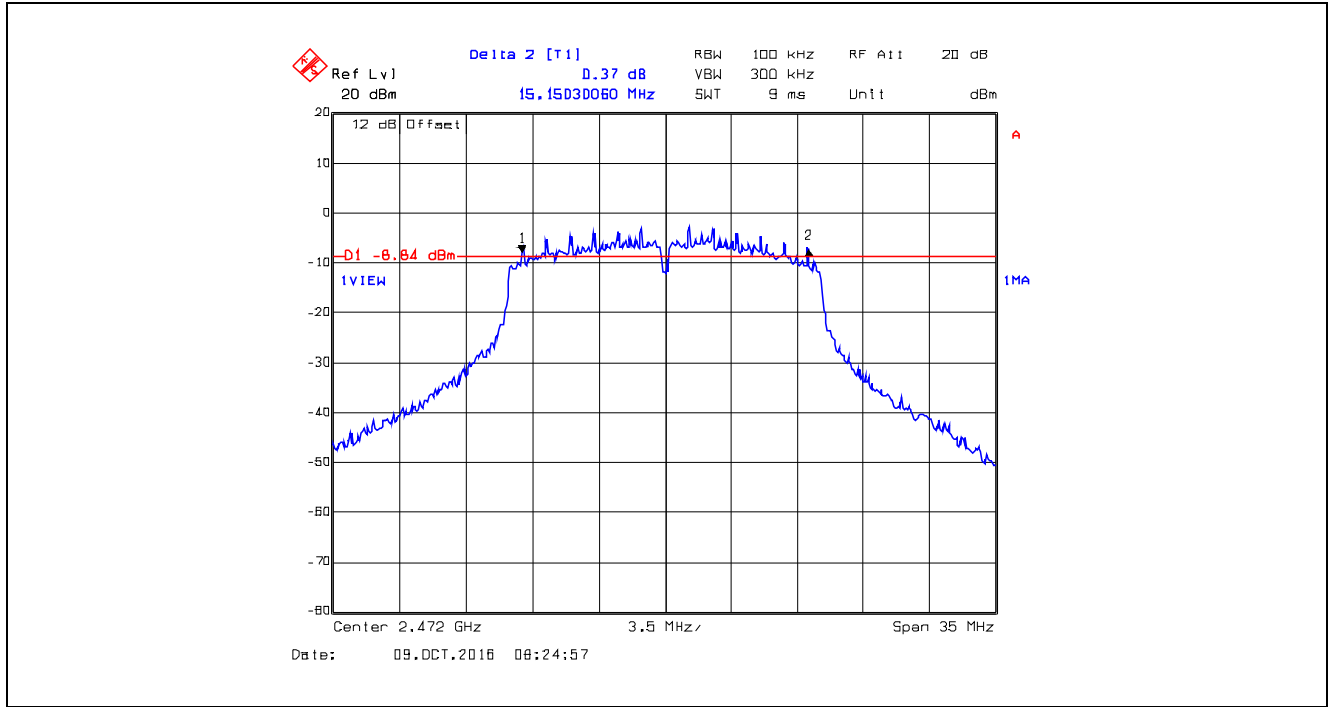

Plot 5.2.4.16. 6 dB Bandwidth, 802.11g, 16-QAM 24 Mbps, 2412 MHz, Power Setting 0

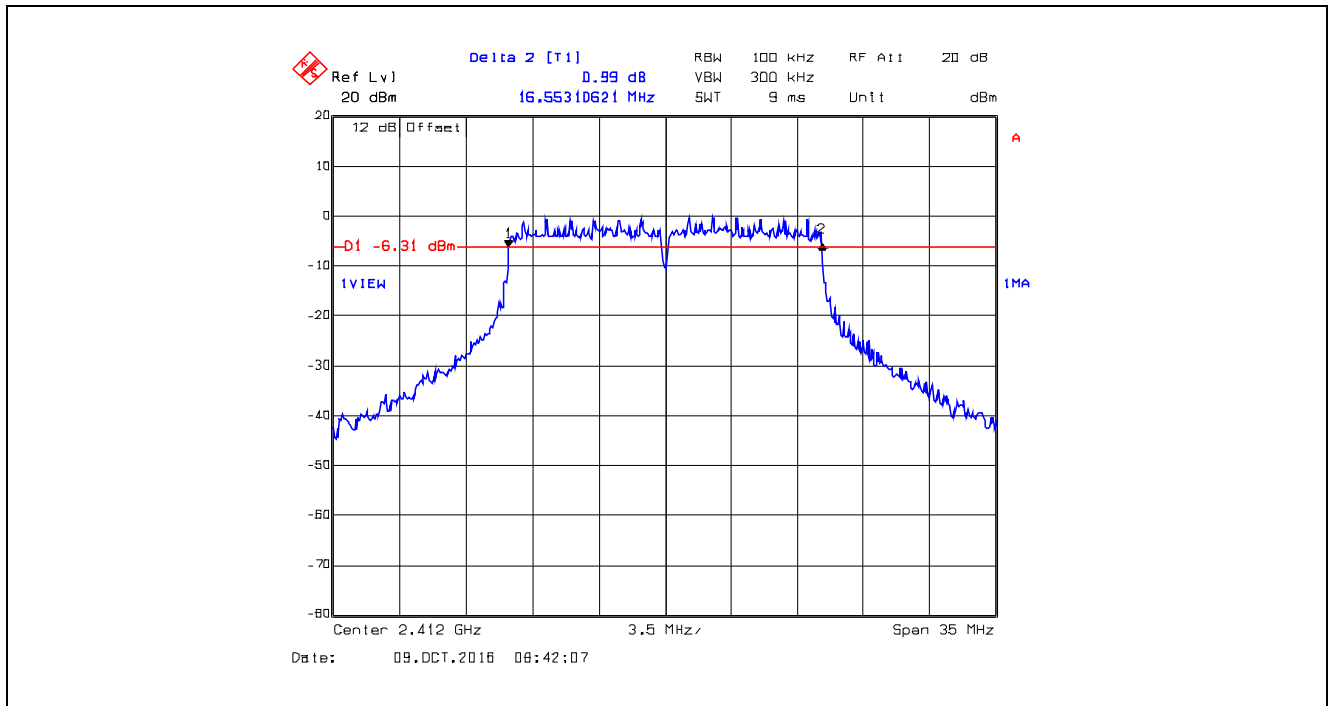

Plot 5.2.4.17. 6 dB Bandwidth, 802.11g, 16-QAM 24 Mbps, 2437 MHz, Power Setting 0

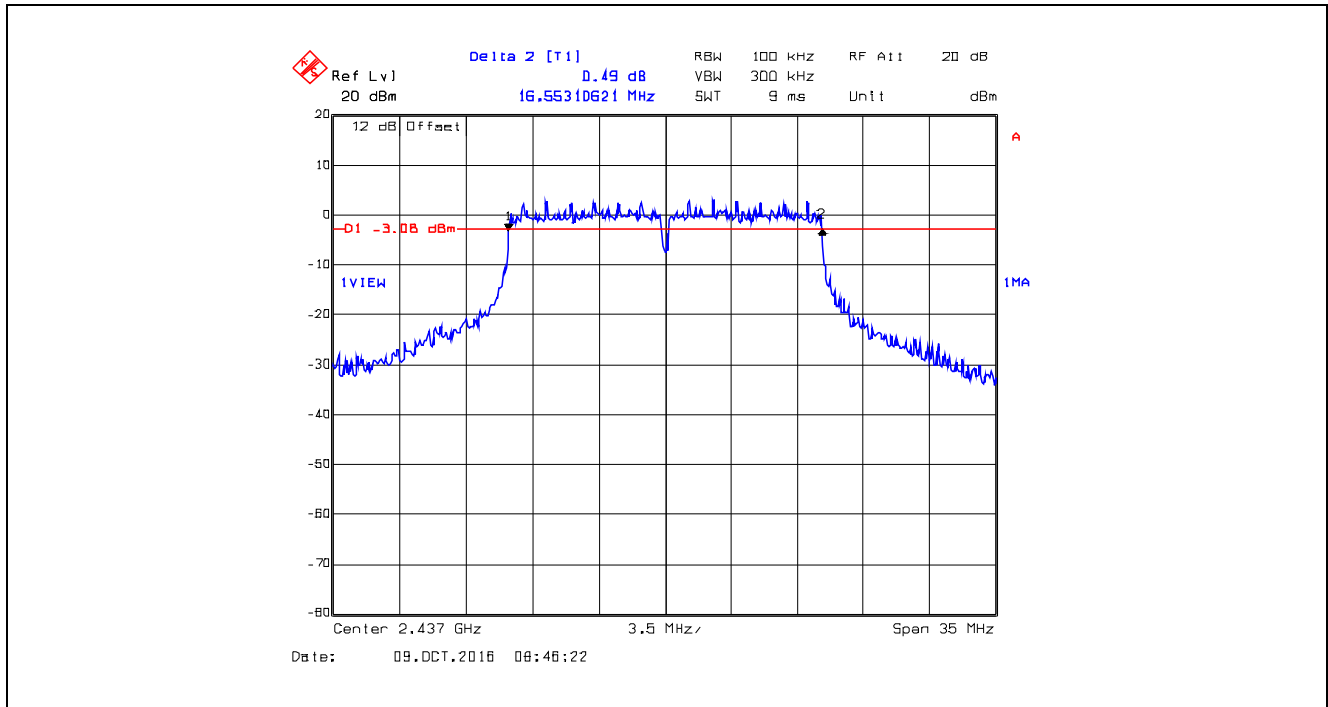

Plot 5.2.4.18. 6 dB Bandwidth, 802.11g, 16-QAM 24 Mbps, 2472 MHz, Power Setting 8

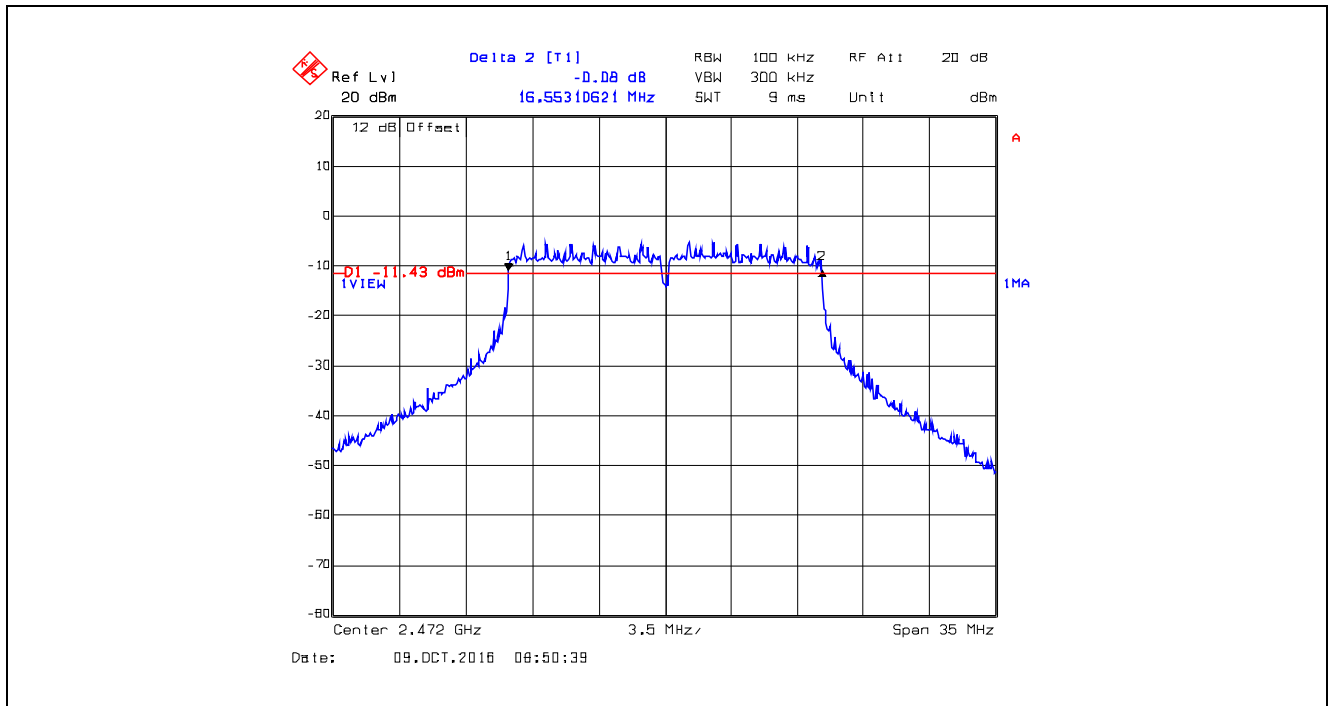

Plot 5.2.4.19. 6 dB Bandwidth, 802.11g, 64-QAM 48 Mbps, 2412 MHz, Power Setting 0

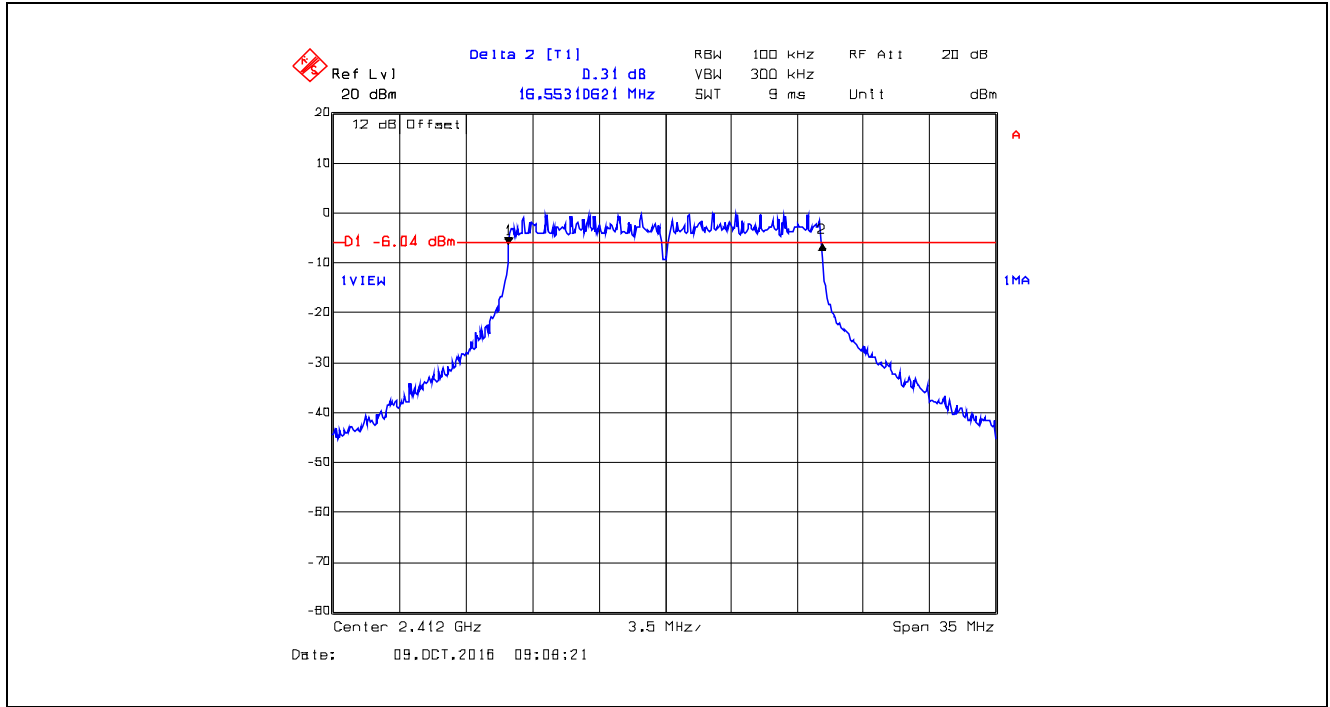

Plot 5.2.4.20. 6 dB Bandwidth, 802.11g, 64-QAM 48 Mbps, 2437 MHz, Power Setting 0

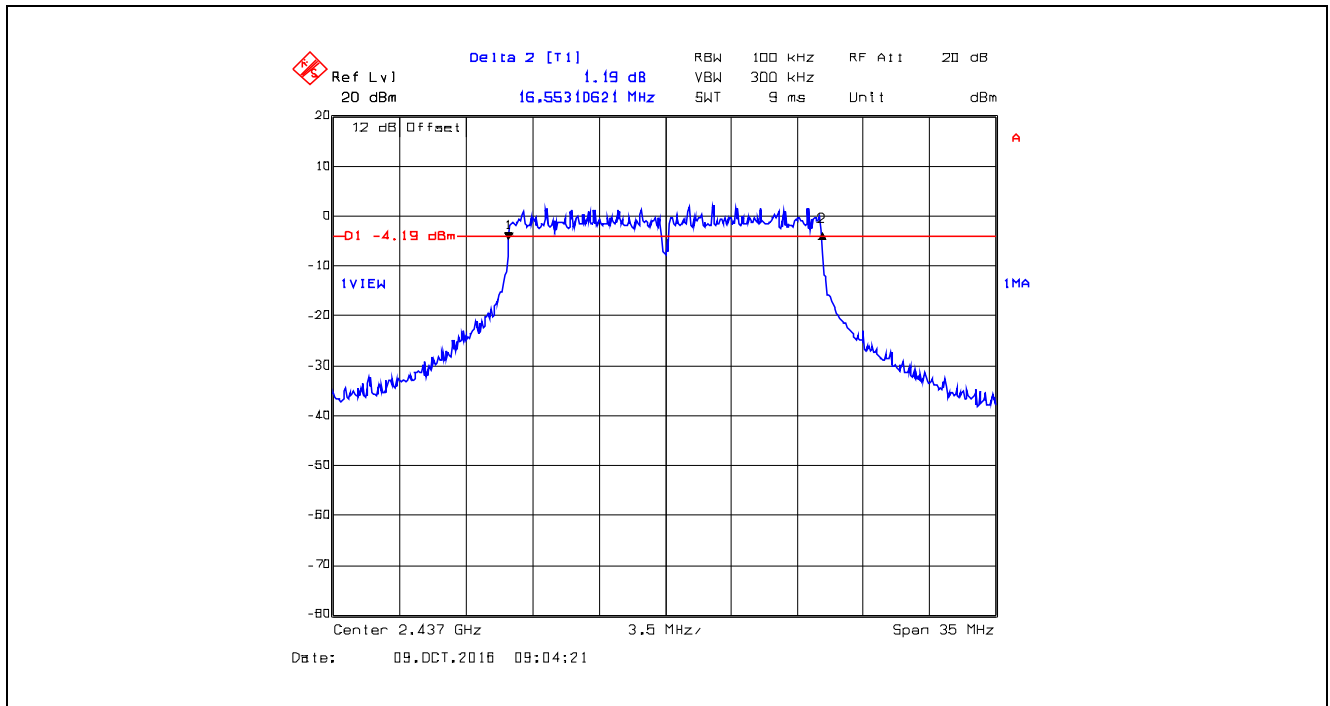

Plot 5.2.4.21. 6 dB Bandwidth, 802.11g, 64-QAM 48 Mbps, 2472 MHz, Power Setting 8

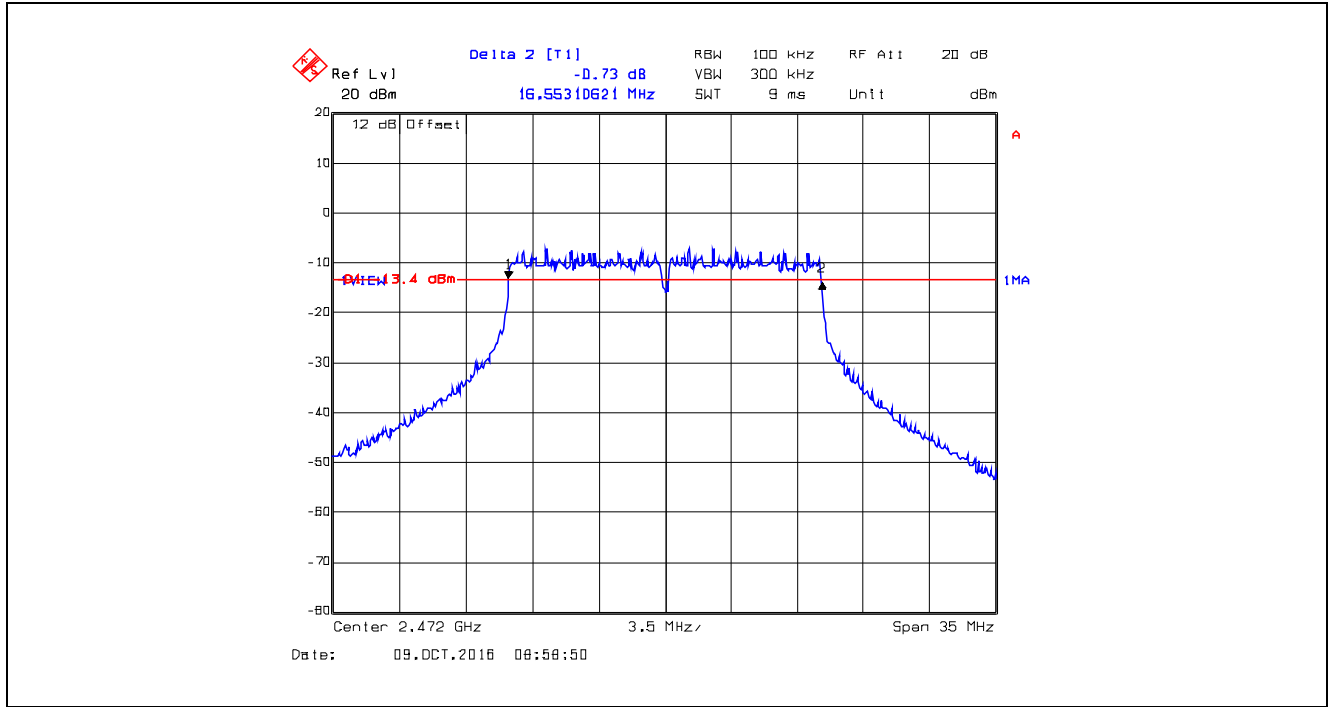

Plot 5.2.4.22. 6 dB Bandwidth, 802.11n, BPSK 1/2 MCS 0, 6.5 Mbps, 2412 MHz, Power Setting 0

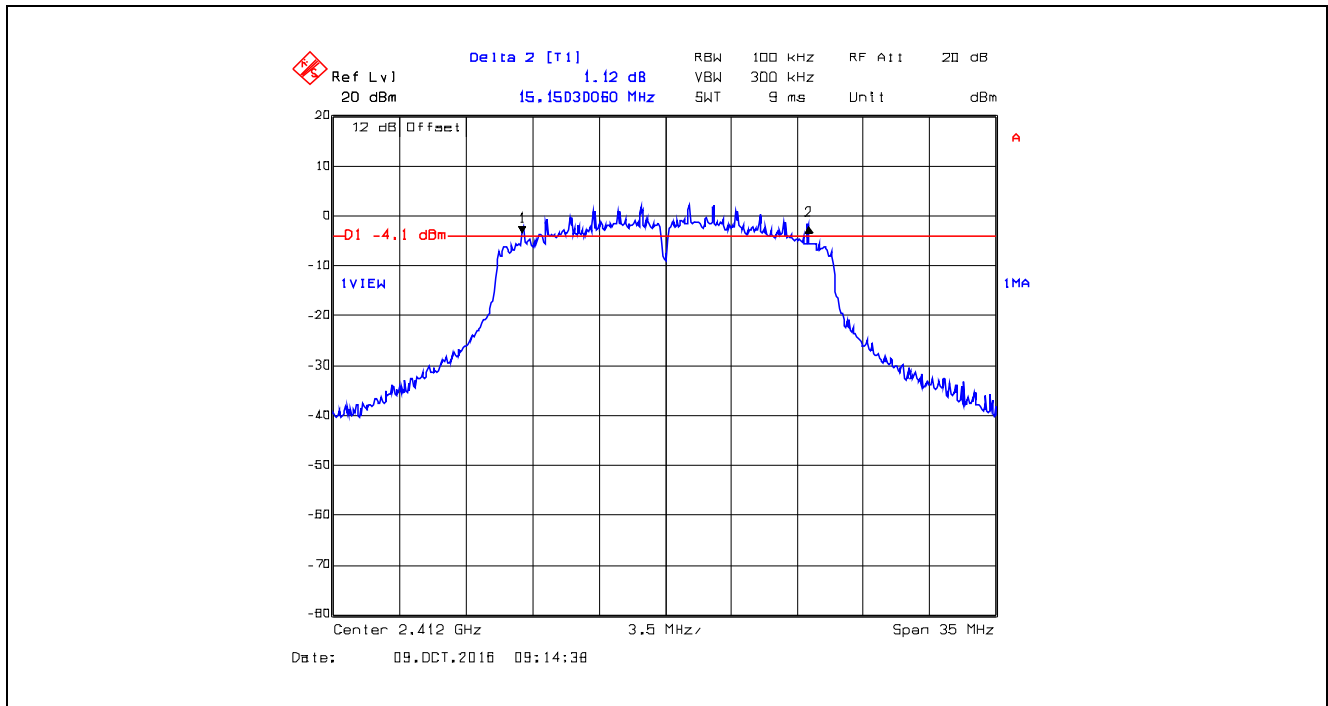

Plot 5.2.4.23. 6 dB Bandwidth, 802.11n, BPSK 1/2 MCS 0, 6.5 Mbps, 2437 MHz, Power Setting 0

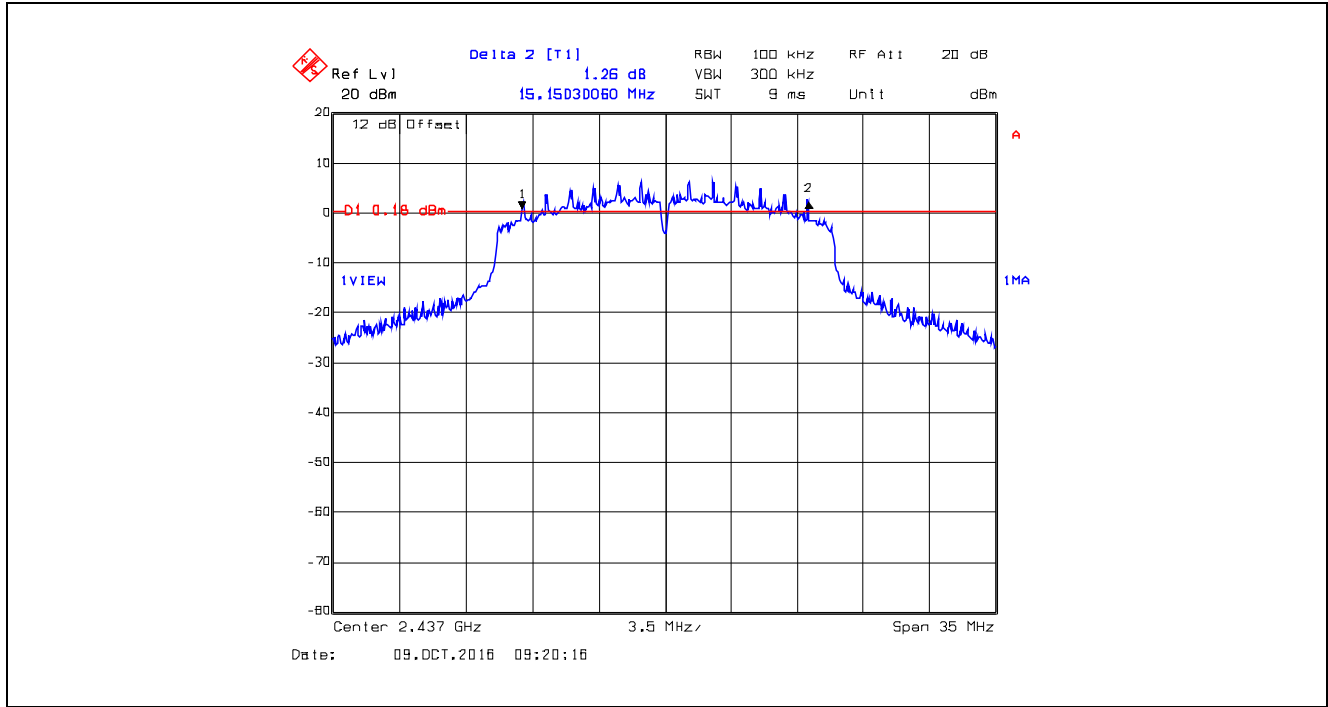

Plot 5.2.4.24. 6 dB Bandwidth, 802.11n, BPSK 1/2 MCS 0, 6.5 Mbps, 2472 MHz, Power Setting 10

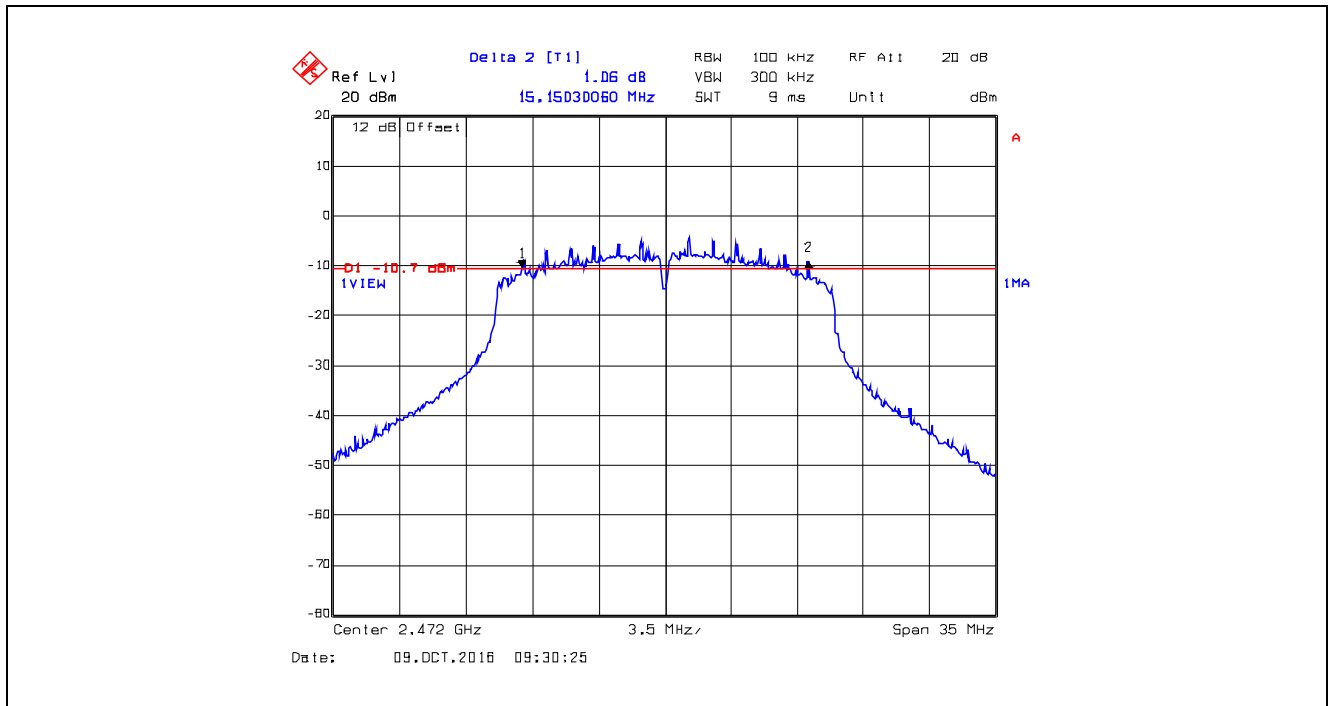

Plot 5.2.4.25. 6 dB Bandwidth, 802.11n, QPSK 1/2 MCS 1, 13 Mbps, 2412 MHz, Power Setting 0

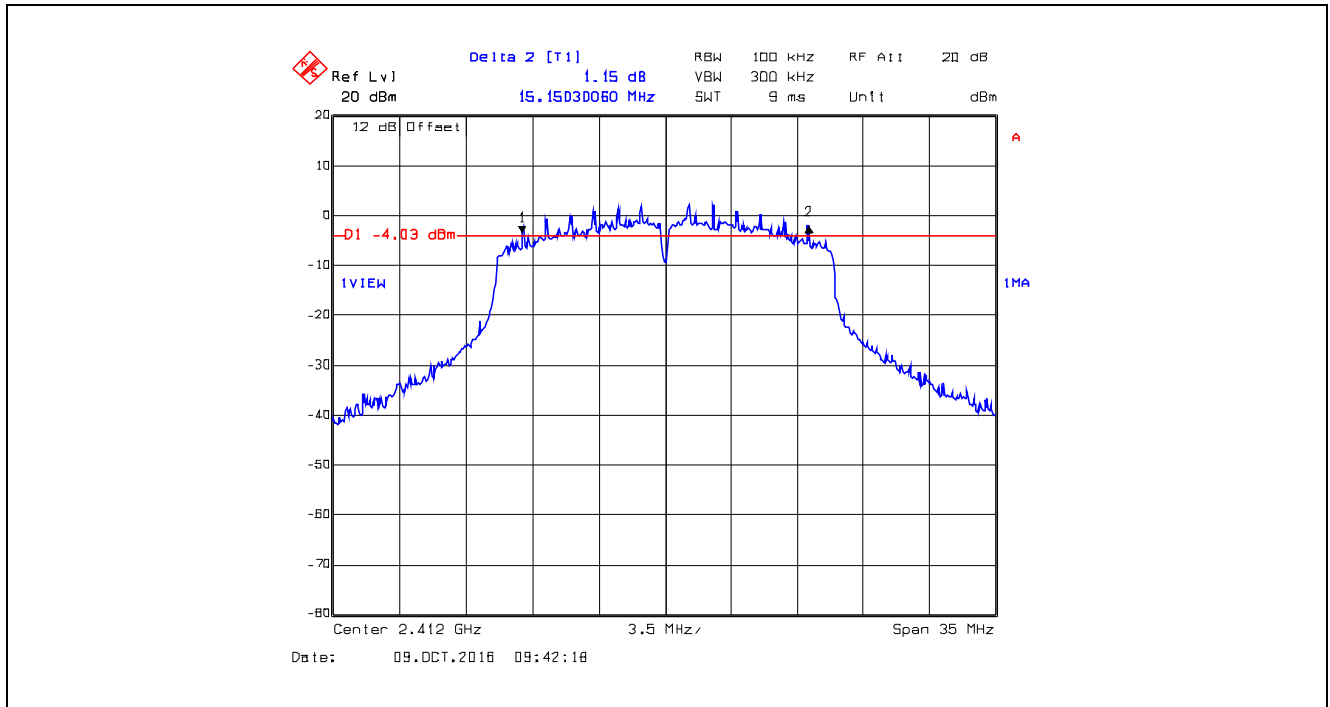

Plot 5.2.4.26. 6 dB Bandwidth, 802.11n, QPSK 1/2 MCS 1, 13 Mbps, 2437 MHz, Power Setting 0

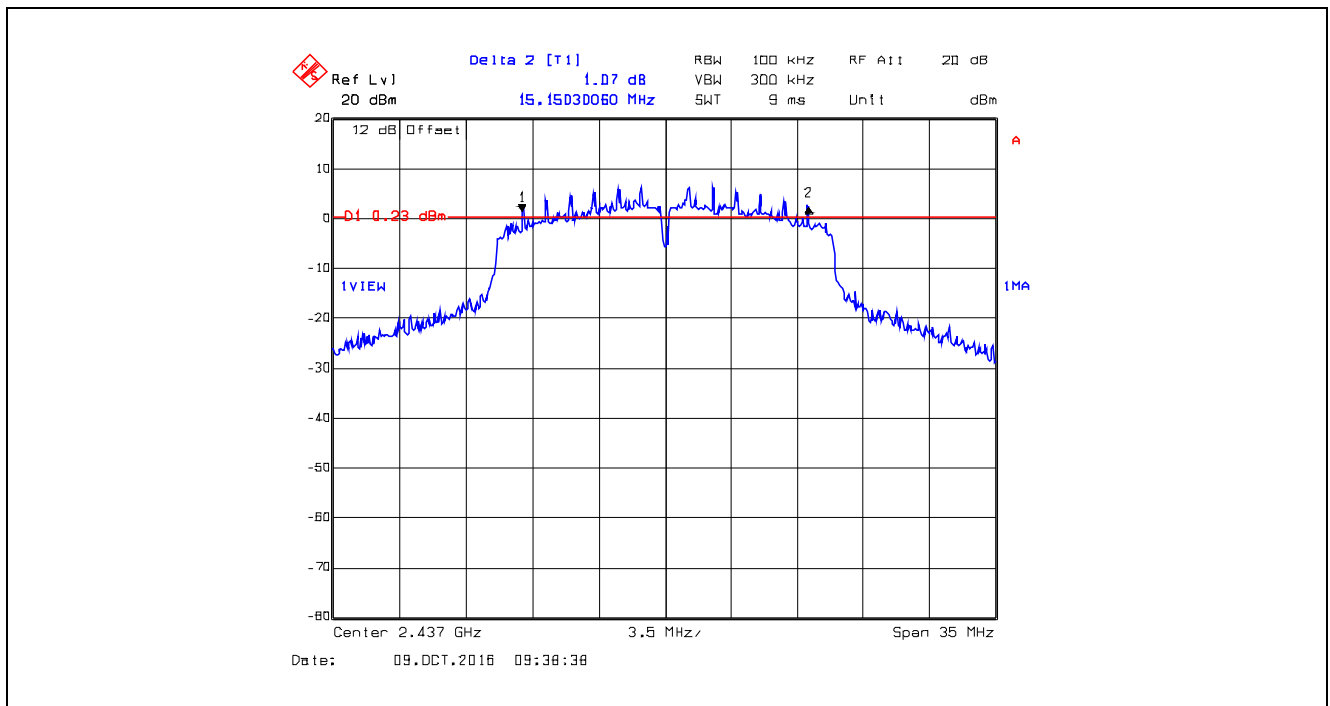

Plot 5.2.4.27. 6 dB Bandwidth, 802.11n, QPSK 1/2 MCS 1, 13 Mbps, 2472 MHz, Power Setting 10

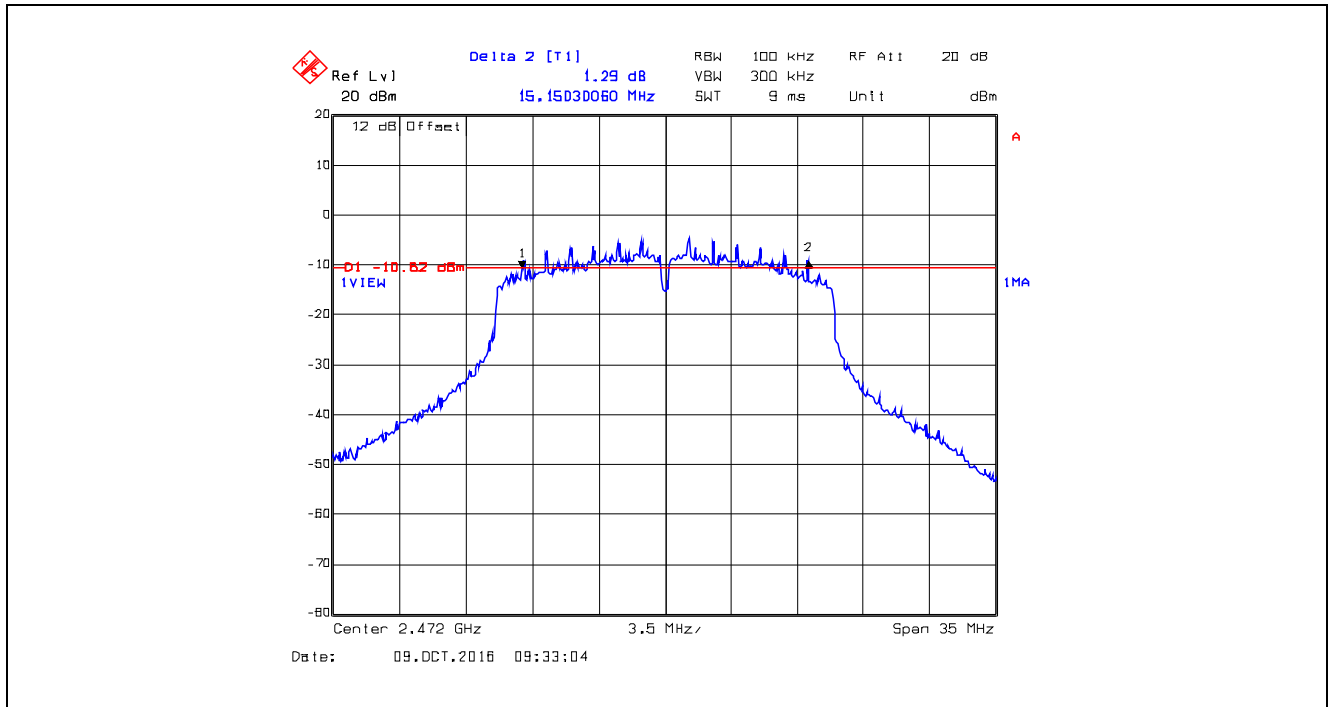

Plot 5.2.4.28. 6 dB Bandwidth, 802.11n, 16-QAM 1/2 MCS 3, 26 Mbps, 2412 MHz, Power Setting 0

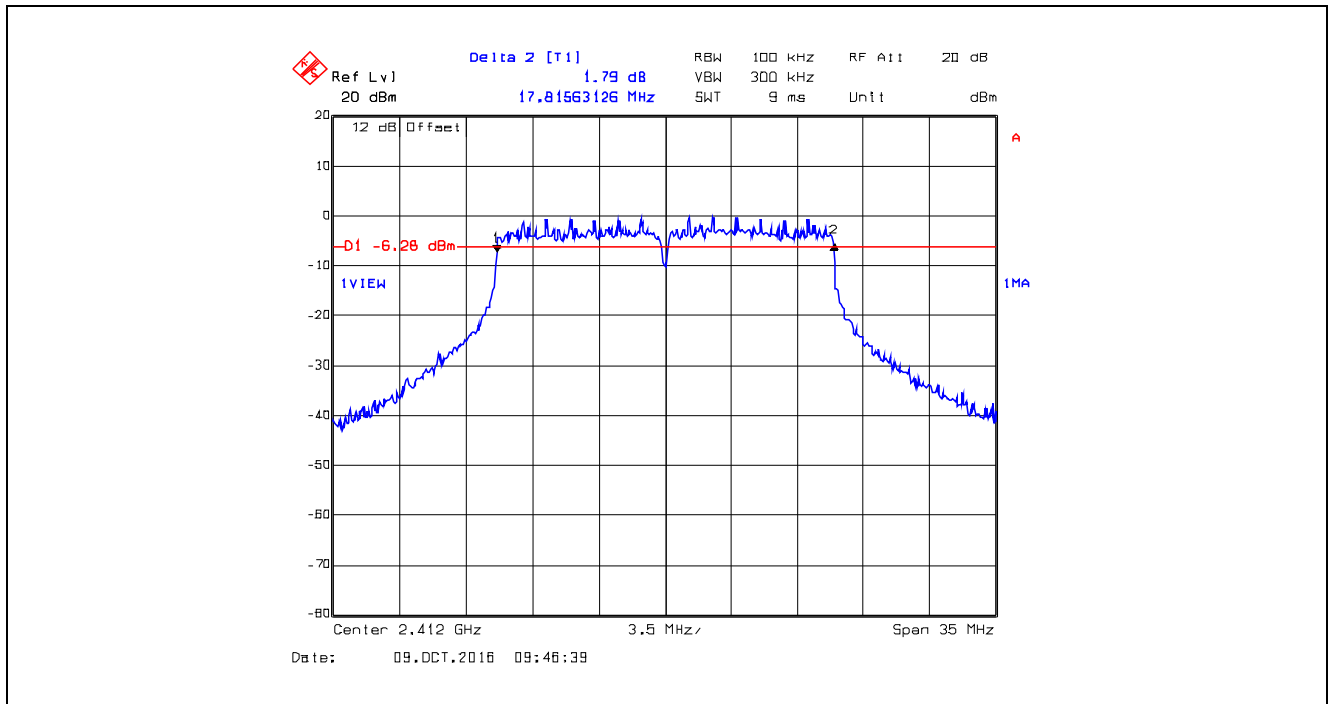

Plot 5.2.4.29. 6 dB Bandwidth, 802.11n, 16-QAM 1/2 MCS 3, 26 Mbps, 2437 MHz, Power Setting 0

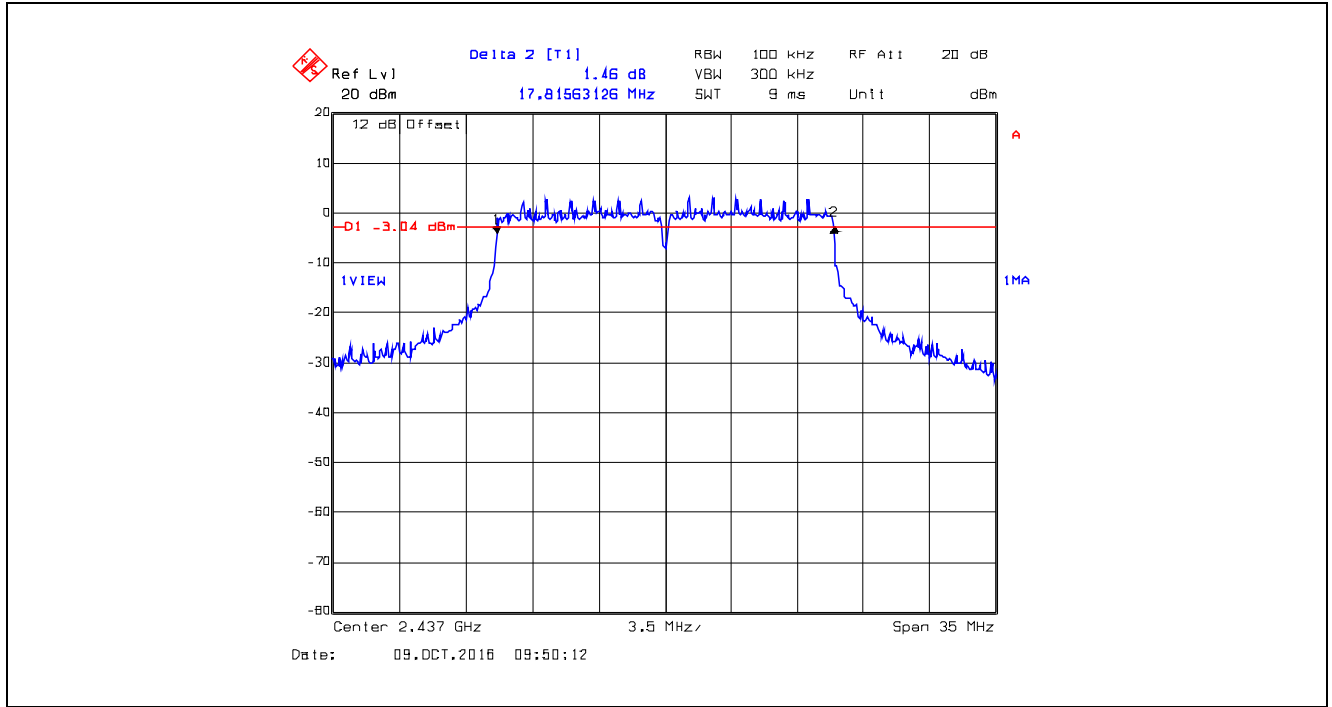

Plot 5.2.4.30. 6 dB Bandwidth, 802.11n, 16-QAM 1/2 MCS 3, 26 Mbps, 2472 MHz, Power Setting 10

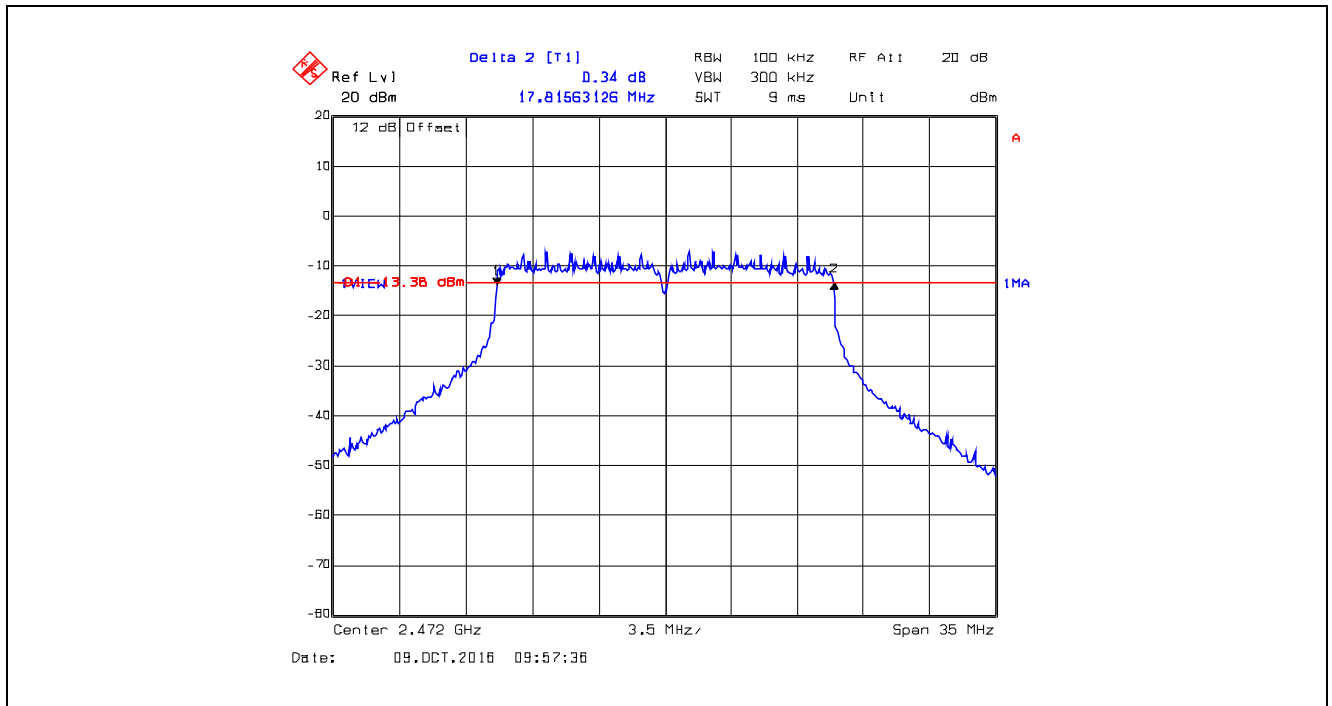

Plot 5.2.4.31. 6 dB Bandwidth, 802.11n, 64-QAM 2/3 MCS 5, 52 Mbps, 2412 MHz, Power Setting 0

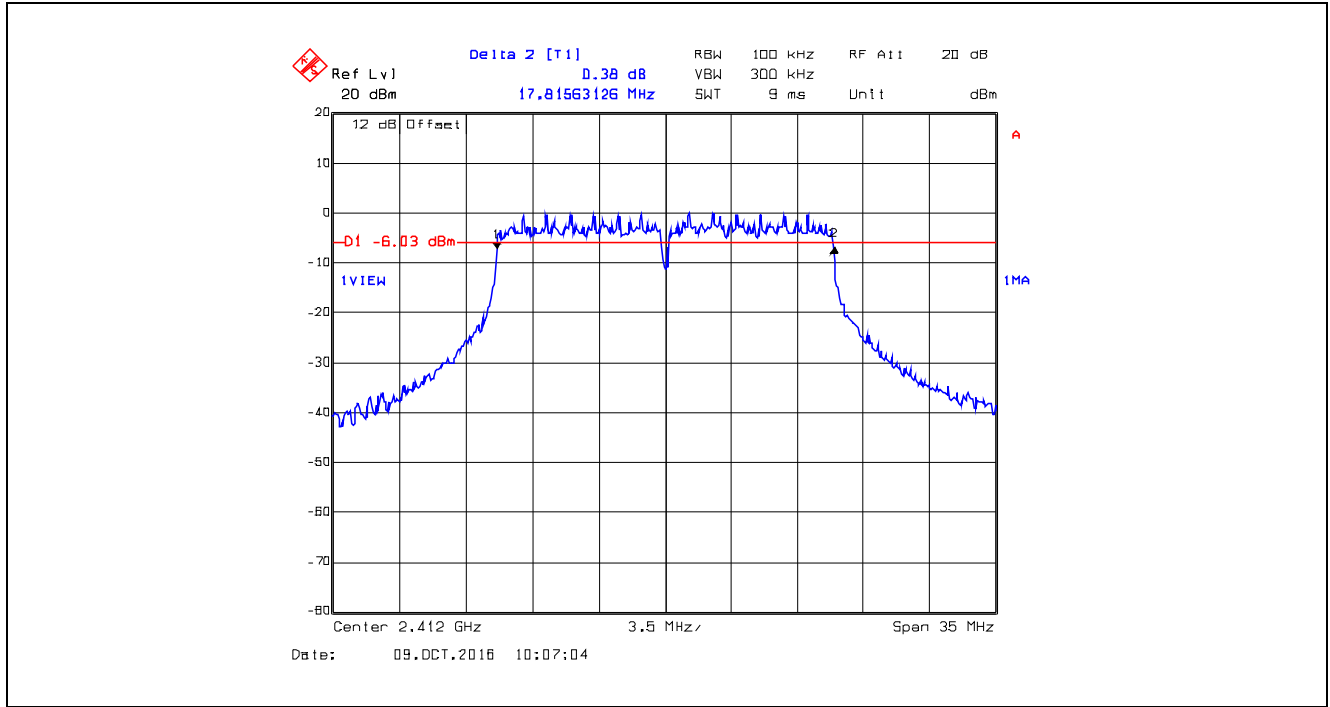

Plot 5.2.4.32. 6 dB Bandwidth, 802.11n, 64-QAM 2/3 MCS 5, 52 Mbps, 2437 MHz, Power Setting 0

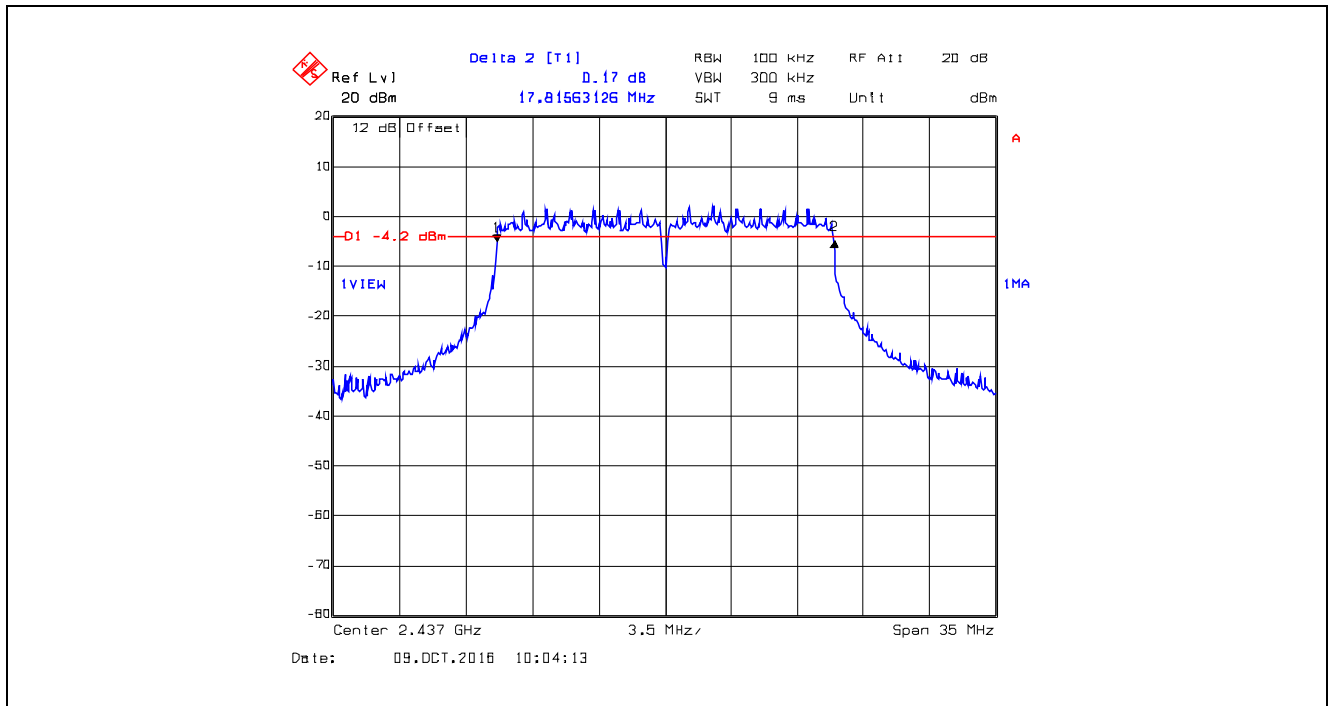

Plot 5.2.4.33. 6 dB Bandwidth, 802.11n, 64-QAM 2/3 MCS 5, 52 Mbps, 2472 MHz, Power Setting 10

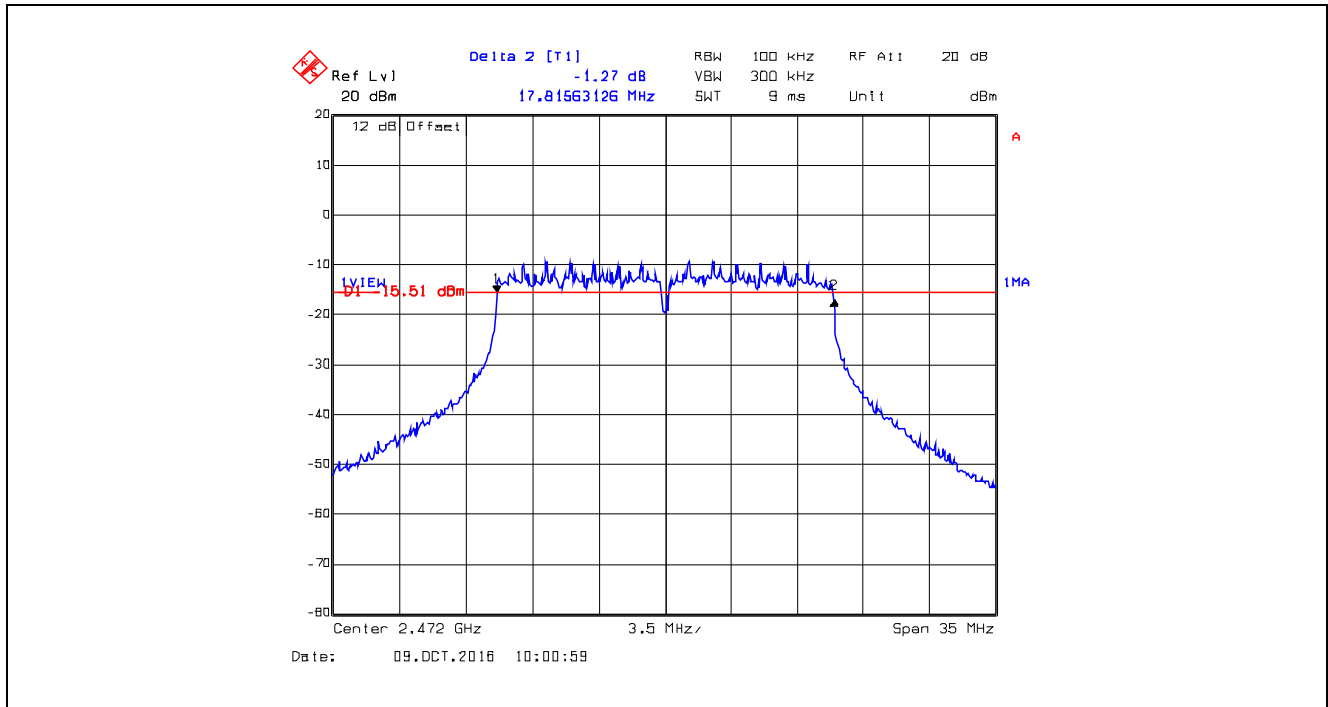

5.3. PEAK CONDUCTED OUTPUT POWER - DTS [§ 15.247(b)]

5.3.1. Limit(s)

§ 15.247(b)(3): For systems using digital modulation in the 902-928 MHz, 2400-2483.5 MHz, and 5725-5850 MHz bands: 1 Watt. As an alternative to a peak power measurement, compliance with the one Watt limit can be based on a measurement of the maximum conducted output power. Maximum Conducted Output Power is defined as the total transmit power delivered to all antennas and antenna elements averaged across all symbols in the signaling alphabet when the transmitter is operating at its maximum power control level. Power must be summed across all antennas and antenna elements. The average must not include any time intervals during which the transmitter is off or is transmitting at a reduced power level. If multiple modes of operation are possible (e.g., alternative modulation methods), the *maximum conducted output power* is the highest total transmit power occurring in any mode.

§ 15.247(b)(4): The conducted output power limit specified in paragraph (b) of this section is based on the use of antennas with directional gains that do not exceed 6 dBi. Except as shown in paragraph (c) of this section, if transmitting antennas of directional gain greater than 6 dBi are used, the conducted output power from the intentional radiator shall be reduced below the stated values in paragraphs (b)(1), (b)(2), and (b)(3) of this section, as appropriate, by the amount in dB that the directional gain of the antenna exceeds 6 dBi.

5.3.2. Method of Measurements

KDB 558074 D01 DTS Meas Guidance v03r05, Section 9.1.2 PKPM1 Peak power meter method

5.3.3. Test Arrangement

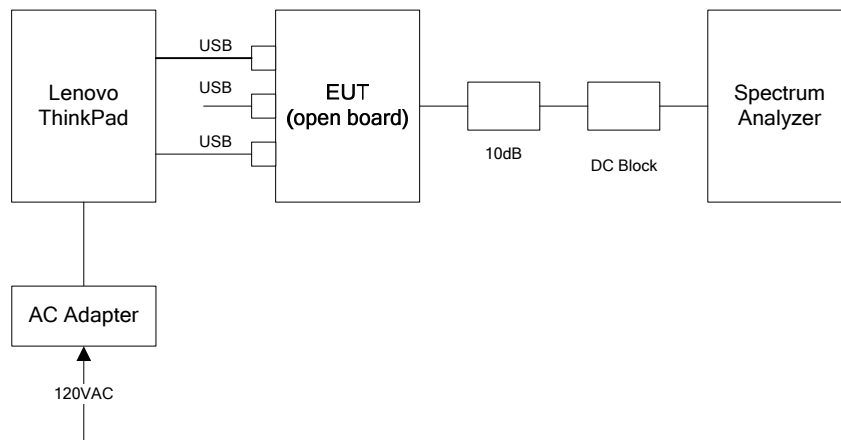

5.3.4. Test Data

802.11b						
Modulation	Data Rate (Mbps)	Frequency (MHz)	Peak Power (dBm)	EIRP (dBm)	Software Rate #	Power Setting
DBPSK	1	2412	16.19	18.19	1	0
		2437	17.74	19.74	1	0
		2462	17.21	19.21	1	0
		2467	16.25	18.25	1	0
		2472	15.33	17.33	1	1
DQPSK	2	2412	16.43	18.43	2	0
		2437	17.74	19.74	2	0
		2462	17.06	19.06	2	0
		2467	16.29	18.29	2	0
		2472	15.35	17.35	2	1
CCK	5.5	2412	16.44	18.44	3	0
		2437	17.71	19.71	3	0
		2462	17.06	19.06	3	0
		2467	16.44	18.44	3	0
		2472	15.51	17.51	3	1

802.11g						
Modulation	Data Rate (Mbps)	Frequency (MHz)	Peak Power (dBm)	EIRP (dBm)	Software Rate #	Power Setting
BPSK	6	2412	19.22	21.22	6	0
		2437	20.11	22.11	6	0
		2462	19.39	21.39	6	0
		2467	19.23	21.23	6	1
		2472	14.76	16.76	6	8
QPSK	12	2412	18.86	20.86	8	0
		2437	20.19	22.19	8	0
		2462	18.79	20.79	8	0
		2467	19.25	21.25	8	1
		2472	14.45	16.45	8	8
16-QAM	24	2412	17.72	19.72	10	0
		2437	19.83	21.83	10	0
		2462	18.25	20.25	10	0
		2467	18.75	20.75	10	1
		2472	12.93	14.93	10	8
64-QAM	48	2412	18.09	20.09	12	0
		2437	19.78	21.78	12	0
		2462	18.34	20.34	12	0
		2467	17.06	19.06	12	1
		2472	10.27	12.27	12	8

ULTRATECH GROUP OF LABS

3000 Bristol Circle, Oakville, Ontario, Canada L6H 6G4
 Tel. #: 905-829-1570, Fax. #: 905-829-8050, Email: vic@ultratech-labs.com, Website: <http://www.ultratech-labs.com>

File #: 16SWIF019_FCC15C247DTS
 November 16, 2016

All test results contained in this engineering test report are traceable to National Institute of Standards and Technology (NIST)

802.11n						
Modulation	Data Rate (Mbps)	Frequency (MHz)	Peak Power (dBm)	EIRP (dBm)	Software Rate #	Power Setting
BPSK 1/2 MCS 0	6.5	2412	18.95	20.95	14	0
		2437	20.28	22.28	14	0
		2462	19.14	21.14	14	0
		2467	19.44	21.44	14	1
		2472	12.89	14.89	14	10
QPSK 1/2 MCS 1	13	2412	18.82	20.82	15	0
		2437	20.24	22.24	15	0
		2462	18.94	20.94	15	0
		2467	19.32	21.32	15	1
		2472	12.28	14.28	15	10
16-QAM 1/2 MCS 3	26	2412	18.32	20.32	17	0
		2437	19.95	21.95	17	0
		2462	18.17	20.17	17	0
		2467	18.59	20.59	17	1
		2472	11.13	13.13	17	10
64-QAM 2/3 MCS 5	52	2412	18.33	20.33	19	0
		2437	19.47	21.47	19	0
		2462	18.32	20.32	19	0
		2467	17.71	19.71	19	1
		2472	8.32	10.32	19	10

5.4. TRANSMITTER SPURIOUS RADIATED EMISSIONS AT 3 METERS [§§ 15.247(d), 15.209 & 15.205]

5.4.1. Limit(s)

§ 15.247 (d): In any 100 kHz bandwidth outside the frequency band in which the spread spectrum or digitally modulated intentional radiator is operating, the radio frequency power that is produced by the intentional radiator shall be at least 20 dB below that in the 100 kHz bandwidth within the band that contains the highest level of the desired power, based on either an RF conducted or a radiated measurement, provided the transmitter demonstrates compliance with the peak conducted power limits. If the transmitter complies with the conducted power limits based on the use of RMS averaging over a time interval, as permitted under paragraph (b)(3) of this section, the attenuation required under this paragraph shall be 30 dB instead of 20 dB. Attenuation below the general limits specified in Section 15.209(a) is not required. In addition, radiated emissions which fall in the restricted bands, as defined in Section 15.205(a), must also comply with the radiated emission limits specified in Section 15.209(a) (see Section 15.205(c)).

Section 15.205(a) - Restricted Bands of Operation

MHz	MHz	MHz	GHz
0.090–0.110	16.42–16.423	399.9–410	4.5–5.15
¹ 0.495–0.505	16.69475–16.69525	608–614	5.35–5.46
2.1735–2.1905	16.80425–16.80475	960–1240	7.25–7.75
4.125–4.128	25.5–25.67	1300–1427	8.025–8.5
4.17725–4.17775	37.5–38.25	1435–1626.5	9.0–9.2
4.20725–4.20775	73–74.6	1645.5–1646.5	9.3–9.5
6.215–6.218	74.8–75.2	1660–1710	10.6–12.7
6.26775–6.26825	108–121.94	1718.8–1722.2	13.25–13.4
6.31175–6.31225	123–138	2200–2300	14.47–14.5
8.291–8.294	149.9–150.05	2310–2390	15.35–16.2
8.362–8.366	156.52475–156.52525	2483.5–2500	17.7–21.4
8.37625–8.38675	156.7–156.9	2655–2900	22.01–23.12
8.41425–8.41475	162.0125–167.17	3260–3267	23.6–24.0
12.29–12.293	167.72–173.2	3332–3339	31.2–31.8
12.51975–12.52025	240–285	3345.8–3358	36.43–36.5
12.57675–12.57725	322–335.4	3600–4400	(²)
13.36–13.41			

¹ Until February 1, 1999, this restricted band shall be 0.490–0.510 MHz.
² Above 38.6

Section 15.209(a) - Field Strength Limits within Restricted Frequency Bands

Frequency (MHz)	Field Strength (microvolts/meter)	Measurement Distance (meters)
0.009 - 0.490	2,400 / F (kHz)	300
0.490 - 1.705	24,000 / F (kHz)	30
1.705 - 30.0	30	30
30 – 88	100	3
88 – 216	150	3
216 – 960	200	3
Above 960	500	3

5.4.2. Method of Measurements

FCC Public Notice DA 00-705, ANSI C63.10 and ANSI 63.4 procedures.

5.4.3. Test Arrangement

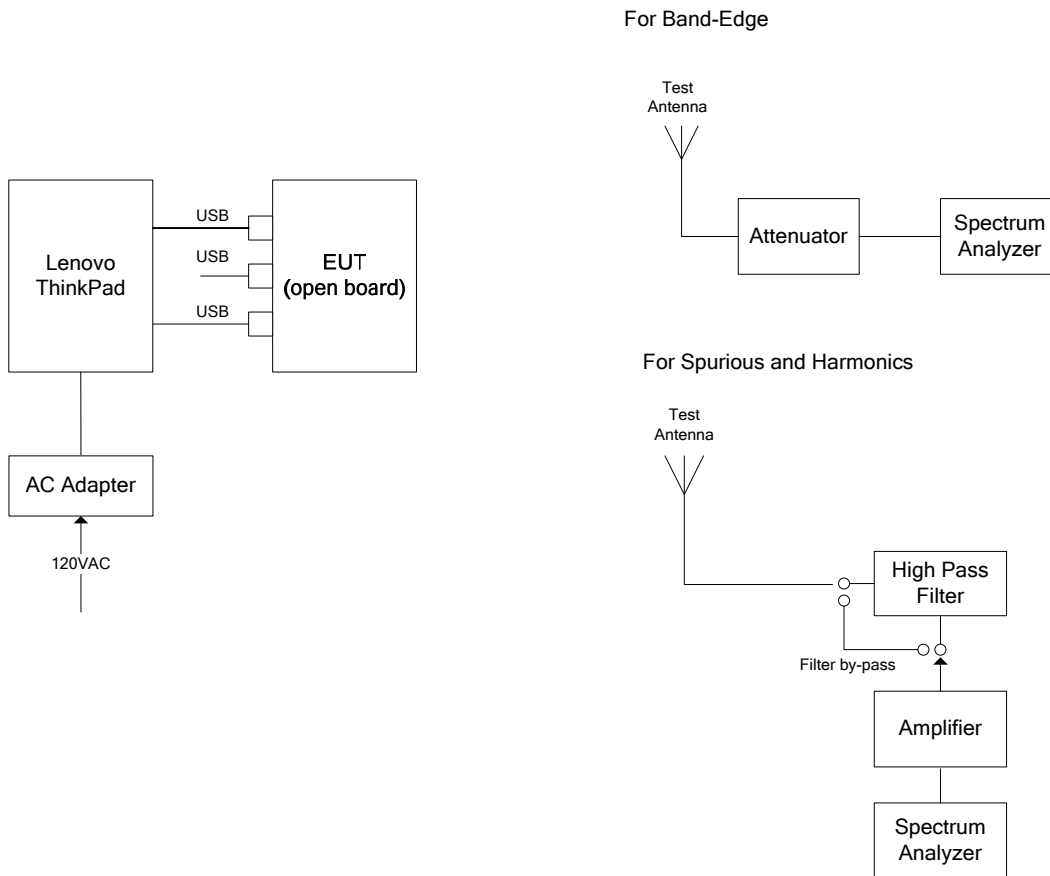

5.4.4. Test Data

Remark(s):

- All spurious emissions that are in excess of 20 dB below the specified limit shall be recorded.
- EUT shall be tested in three orthogonal positions.
- Exploratory tests performed to determined worst-case test configurations, the following test results represent the worst-case.

5.4.4.1. 802.11b, DBPSK Modulation, 1 Mbps Data Rate

5.4.4.1.1. Spurious Radiated Emissions

Fundamental Frequency:		2412 MHz					
Measured Conducted Power:		16.19 dBm					
Power Setting:		0					
Frequency Test Range:		30 MHz – 25 GHz					
Frequency (MHz)	RF Peak Level (dBµV/m)	RF Avg Level (dBµV/m)	Antenna Plane (H/V)	Limit 15.209 (dBµV/m)	Limit 15.247 (dBµV/m)	Margin (dB)	Pass/Fail
2412.00	105.77	--	V	--	--	--	--
2412.00	104.66	--	H	--	--	--	--
4020.06	54.97	48.86	V	54.0	85.8	-5.1	Pass*
4020.06	55.73	48.89	H	54.0	85.8	-5.1	Pass*
4824.00	48.65	39.76	V	54.0	85.8	-14.2	Pass*
4824.00	51.22	43.63	H	54.0	85.8	-10.4	Pass*
All other spurious emissions and harmonics are more than 20 dB below the applicable limit.							

*Field strength of emissions appearing within restricted frequency bands shall not exceed the limits in § 15.209.

Fundamental Frequency:		2437 MHz					
Measured Conducted Power:		17.74 dBm					
Power Setting:		0					
Frequency Test Range:		30 MHz – 25 GHz					
Frequency (MHz)	RF Peak Level (dBµV/m)	RF Avg Level (dBµV/m)	Antenna Plane (H/V)	Limit 15.209 (dBµV/m)	Limit 15.247 (dBµV/m)	Margin (dB)	Pass/Fail
2437	104.32	--	V	--	--	--	--
2437	104.55	--	H	--	--	--	--
4061.73	55.83	49.32	V	54.0	84.6	-4.7	Pass*
4061.73	56.43	49.81	H	54.0	84.6	-4.2	Pass*
4874.00	48.13	38.91	V	54.0	84.6	-15.1	Pass*
4874.00	50.14	41.64	H	54.0	84.6	-12.4	Pass*
All other spurious emissions and harmonics are more than 20 dB below the applicable limit.							

*Field strength of emissions appearing within restricted frequency bands shall not exceed the limits in § 15.209.

ULTRATECH GROUP OF LABS

3000 Bristol Circle, Oakville, Ontario, Canada L6H 6G4
 Tel. #: 905-829-1570, Fax. #: 905-829-8050, Email: vic@ultratech-labs.com, Website: <http://www.ultratech-labs.com>

File #: 16SWIF019_FCC15C247DTS
 November 16, 2016

All test results contained in this engineering test report are traceable to National Institute of Standards and Technology (NIST)

Fundamental Frequency:		2462 MHz					
Measured Conducted Power:		17.21 dBm					
Power Setting:		0					
Frequency Test Range:		30 MHz – 25 GHz					
Frequency (MHz)	RF Peak Level (dBµV/m)	RF Avg Level (dBµV/m)	Antenna Plane (H/V)	Limit 15.209 (dBµV/m)	Limit 15.247 (dBµV/m)	Margin (dB)	Pass/Fail
2462.00	104.16	--	V	--	--	--	--
2462.00	104.75	--	H	--	--	--	--
4102.95	55.80	49.61	V	54.0	84.8	-4.4	Pass*
4102.95	56.63	50.28	H	54.0	84.8	-3.7	Pass*
All other spurious emissions and harmonics are more than 20 dB below the applicable limit.							

*Field strength of emissions appearing within restricted frequency bands shall not exceed the limits in § 15.209.

Fundamental Frequency:		2472 MHz					
Measured Conducted Power:		15.33 dBm					
Power Setting:		1					
Frequency Test Range:		30 MHz – 25 GHz					
Frequency (MHz)	RF Peak Level (dBµV/m)	RF Avg Level (dBµV/m)	Antenna Plane (H/V)	Limit 15.209 (dBµV/m)	Limit 15.247 (dBµV/m)	Margin (dB)	Pass/Fail
2472.00	103.10	--	V	--	--	--	--
2472.00	105.28	--	H	--	--	--	--
4120.04	54.87	47.21	V	54.0	85.3	-6.8	Pass*
4120.04	54.91	47.17	H	54.0	85.3	-6.8	Pass*
All other spurious emissions and harmonics are more than 20 dB below the applicable limit.							

*Field strength of emissions appearing within restricted frequency bands shall not exceed the limits in § 15.209.

5.4.4.1.2. Band –Edge RF Radiated Emissions

Plot 5.4.4.1.2.1. Band-Edge RF Radiated Emissions at 3 m, Horizontal Polarization
802.11b, DBPSK, 1 Mbps, 2412 MHz, Power Setting 0

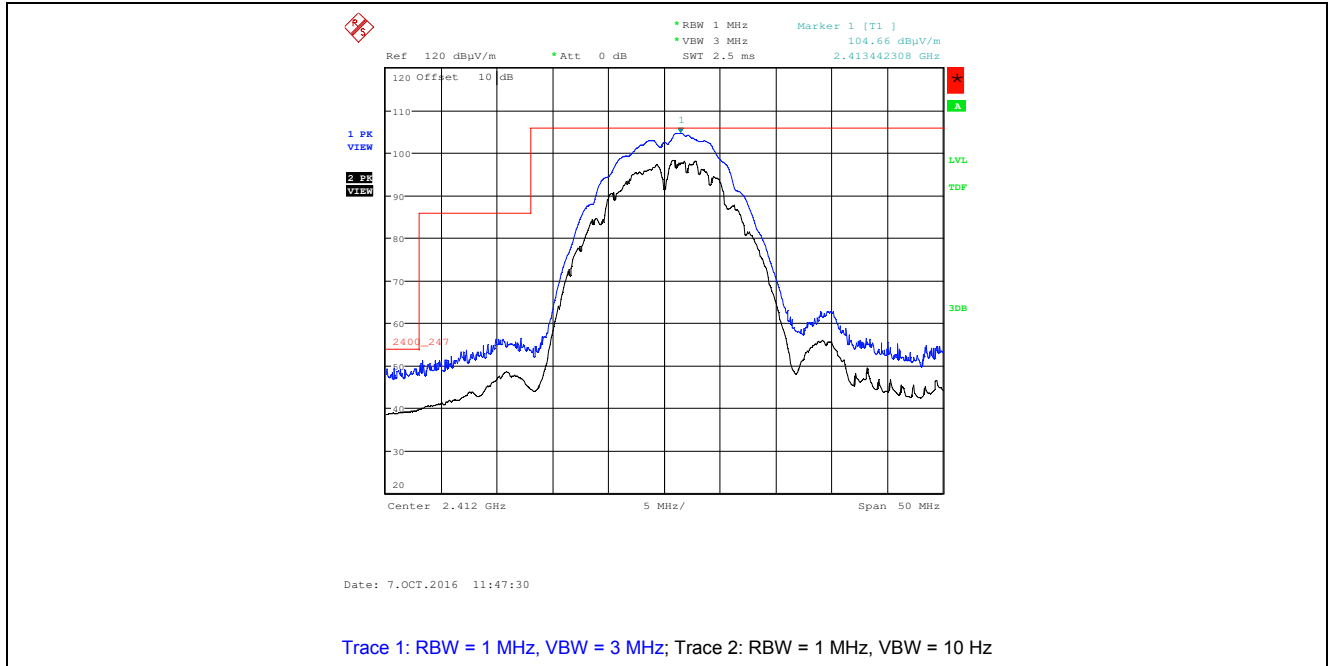

Plot 5.4.4.1.2.2. Band-Edge RF Radiated Emissions at 3 m, Vertical Polarization
. 802.11b, DBPSK, 1 Mbps, 2412 MHz, Power Setting 0

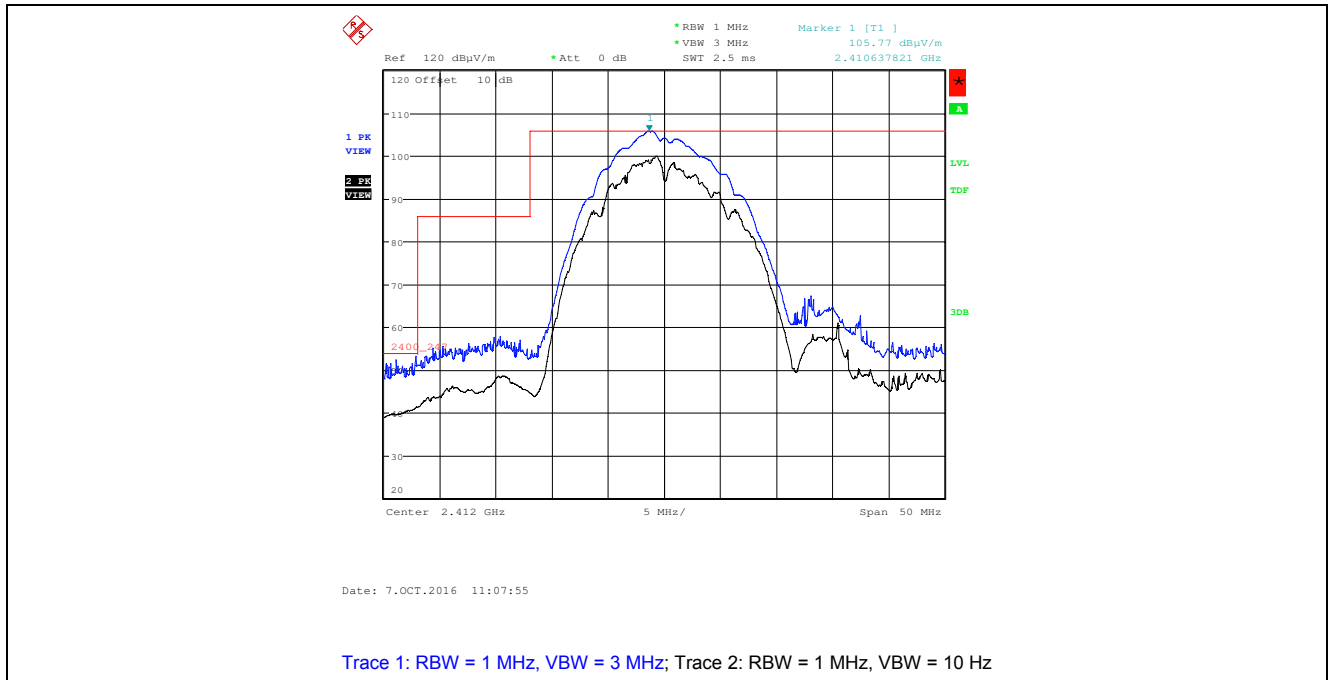

Plot 5.4.4.1.2.3. Band-Edge RF Radiated Emissions at 3 m, Horizontal Polarization
802.11b, DBPSK, 1 Mbps, 2462 MHz, Power Setting 0

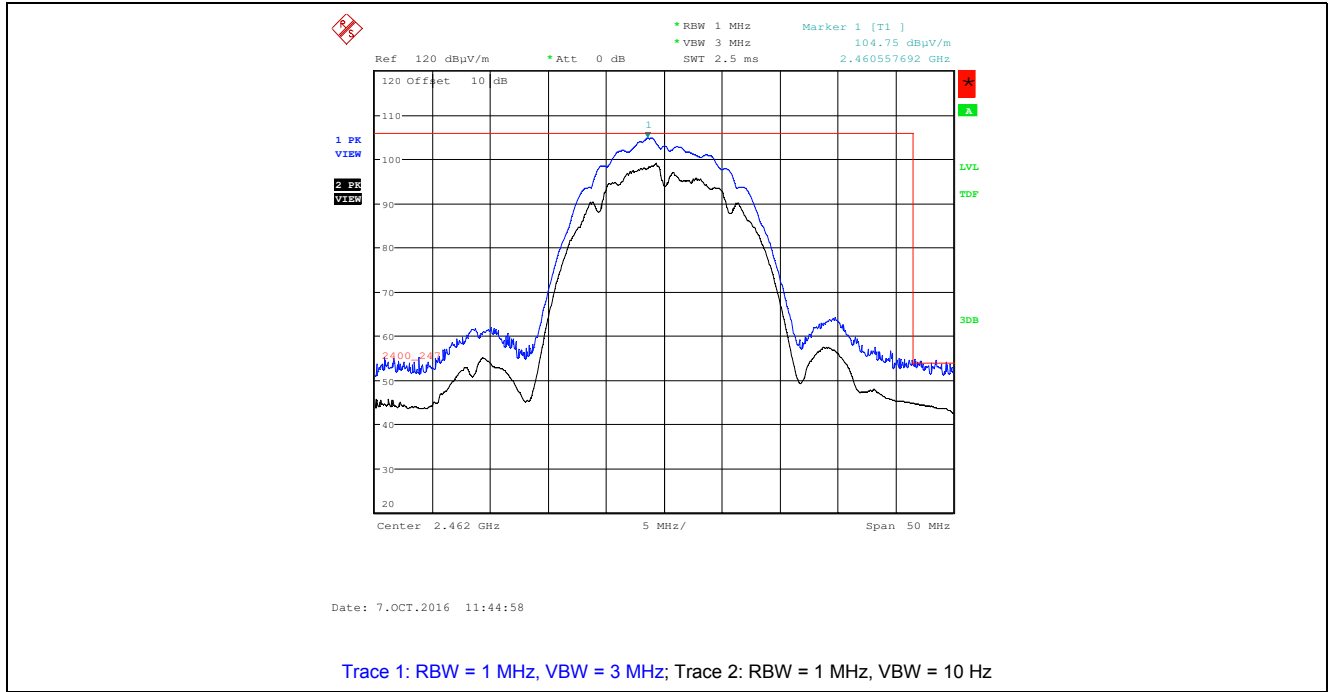

Plot 5.4.4.1.2.4. Band-Edge RF Radiated Emissions at 3 m, Vertical Polarization
802.11b, DBPSK, 1 Mbps, 2462 MHz, Power Setting 0

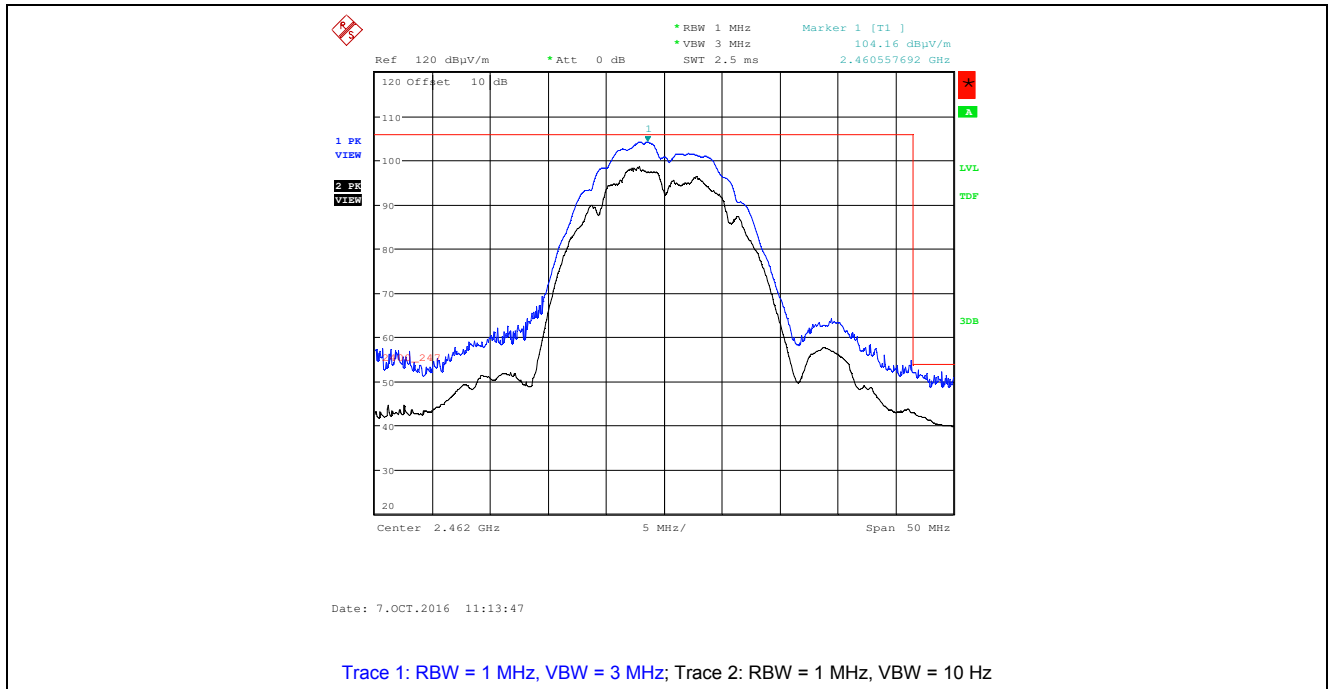

Plot 5.4.4.1.2.5. Band-Edge RF Radiated Emissions at 3 m, Horizontal Polarization
802.11b, DBPSK, 1 Mbps, 2467 MHz, Power Setting 0

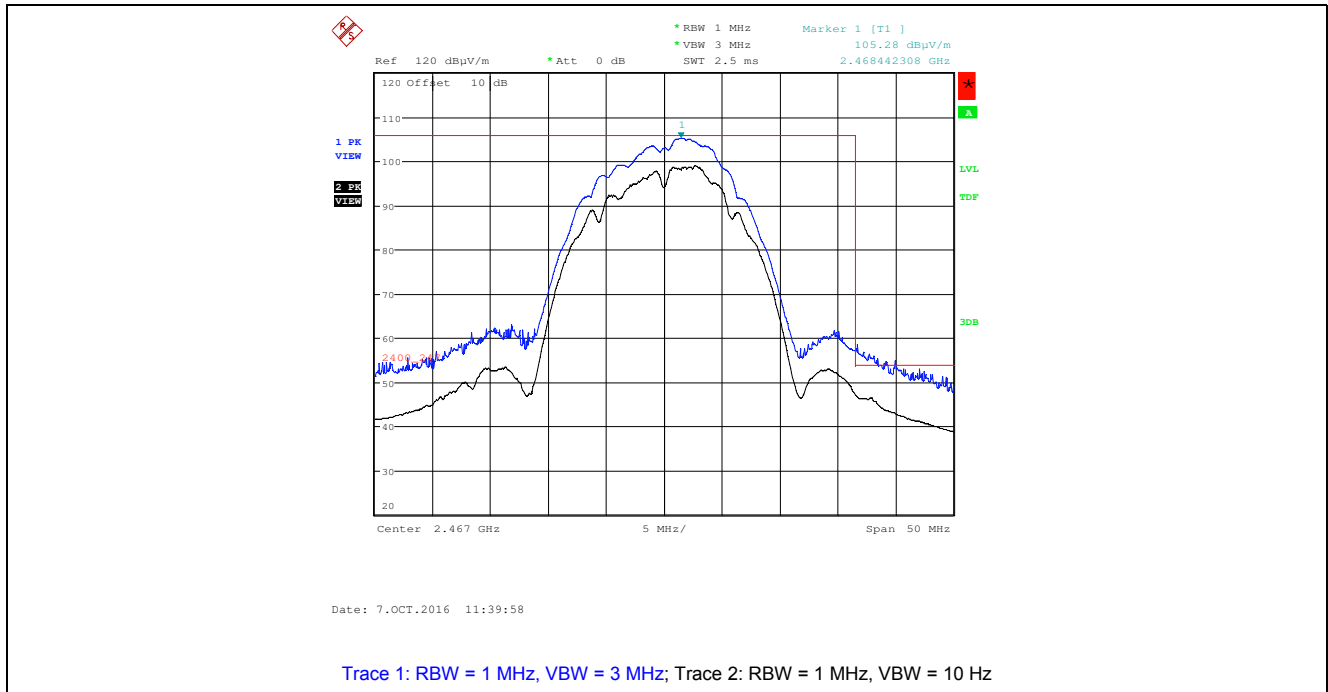

Plot 5.4.4.1.2.6. Band-Edge RF Radiated Emissions at 3 m, Vertical Polarization
802.11b, DBPSK, 1 Mbps, 2467 MHz, Power Setting 0

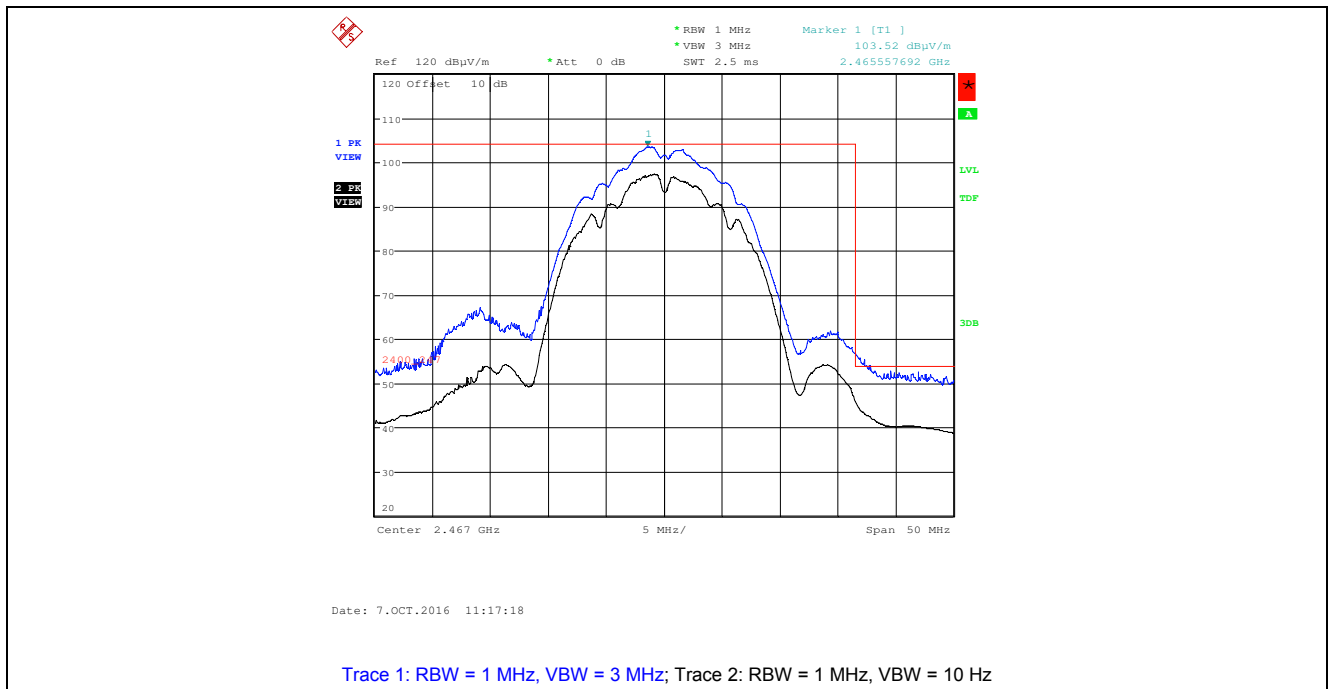

Plot 5.4.4.1.2.7. Band-Edge RF Radiated Emissions at 3 m, Horizontal Polarization
802.11b, DBPSK, 1 Mbps, 2472MHz, Power Setting 1

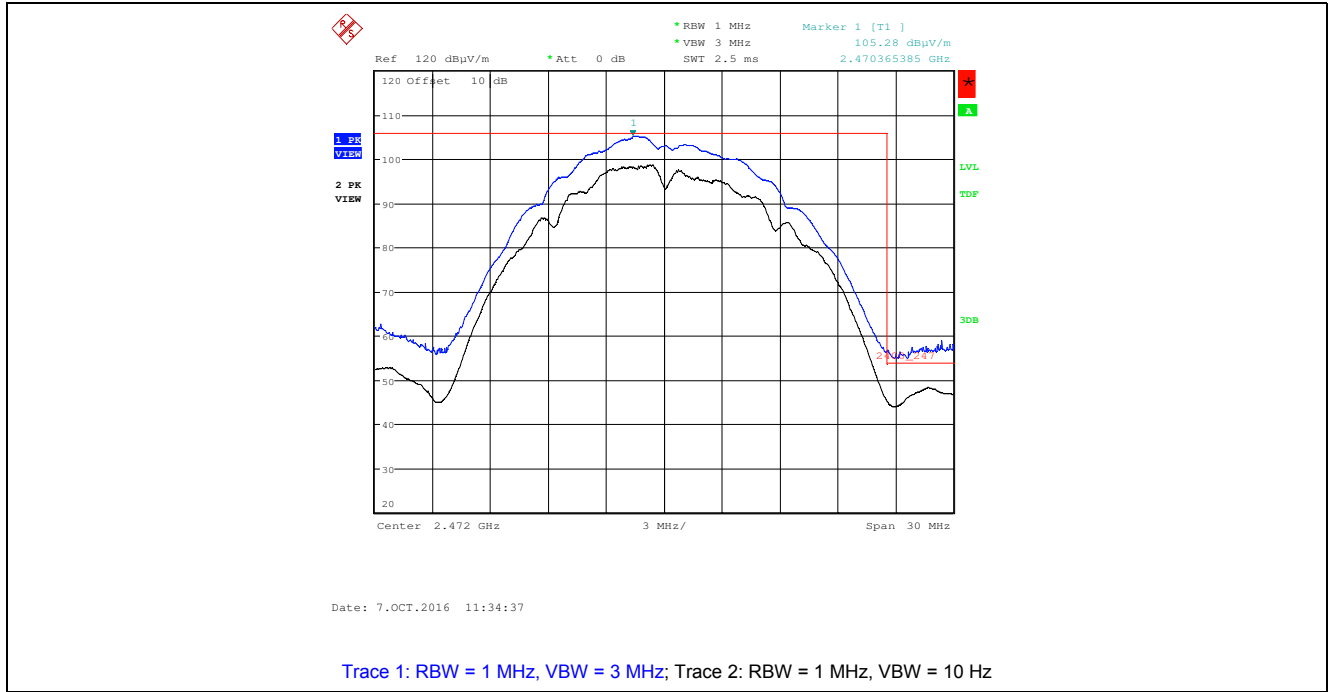

Plot 5.4.4.1.2.8. Band-Edge RF Radiated Emissions at 3 m, Vertical Polarization
802.11b, DBPSK, 1 Mbps, 2472MHz, Power Setting 1

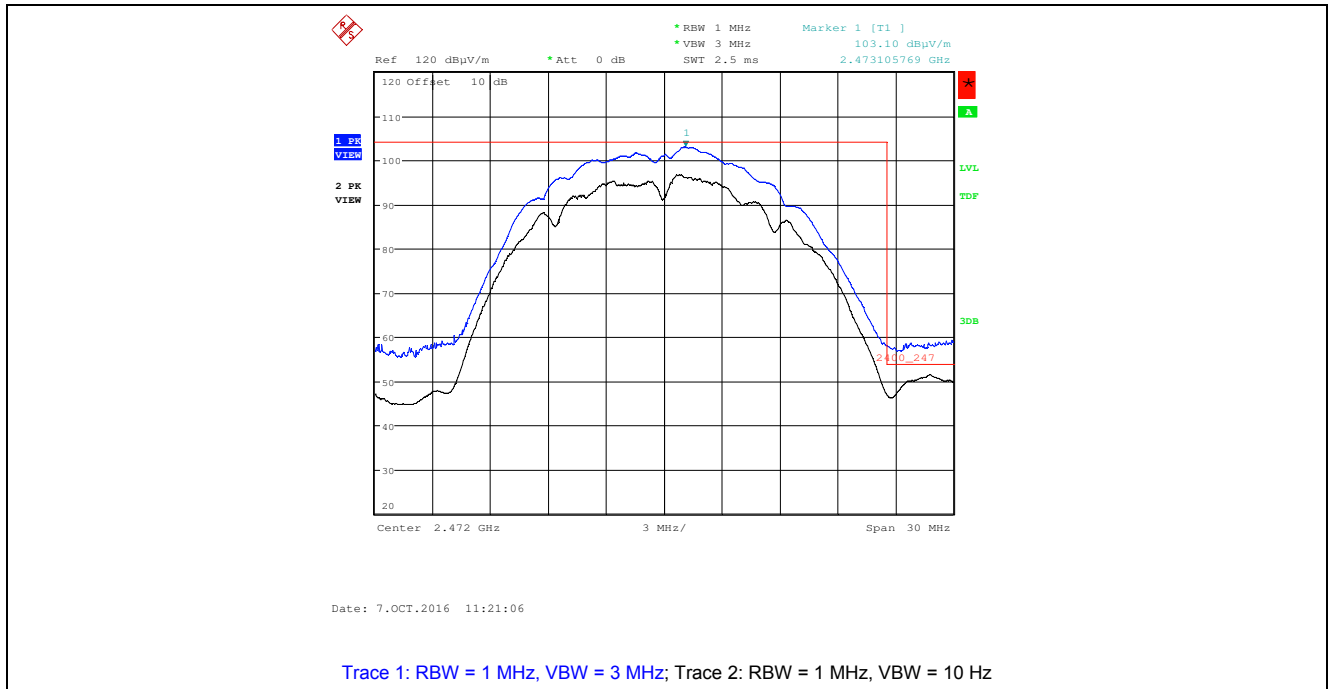

5.4.4.2. 802.11g, BPSK Modulation, 6 Mbps Data Rate

5.4.4.2.1. Spurious Radiated Emissions

Fundamental Frequency:		2412 MHz					
Measured Conducted Power:		19.22 dBm					
Power Setting:		0					
Frequency Test Range:		30 MHz – 25 GHz					
Frequency (MHz)	RF Peak Level (dBµV/m)	RF Avg Level (dBµV/m)	Antenna Plane (H/V)	Limit 15.209 (dBµV/m)	Limit 15.247 (dBµV/m)	Margin (dB)	Pass/Fail
2412.00	105.82	--	V	--	--	--	--
2412.00	106.84	--	H	--	--	--	--
4020.06	53.68	41.79	V	54.0	86.8	-12.2	Pass*
4020.06	55.09	42.84	H	54.0	86.8	-11.2	Pass*
All other spurious emissions and harmonics are more than 20 dB below the applicable limit.							

*Field strength of emissions appearing within restricted frequency bands shall not exceed the limits in § 15.209.

Fundamental Frequency:		2437 MHz					
Measured Conducted Power:		20.11 dBm					
Power Setting:		0					
Frequency Test Range:		30 MHz – 25 GHz					
Frequency (MHz)	RF Peak Level (dBµV/m)	RF Avg Level (dBµV/m)	Antenna Plane (H/V)	Limit 15.209 (dBµV/m)	Limit 15.247 (dBµV/m)	Margin (dB)	Pass/Fail
2437.00	106.01	--	V	--	--	--	--
2437.00	105.47	--	H	--	--	--	--
4061.73	55.98	40.06	V	54.0	86.0	-13.9	Pass*
4061.73	57.42	45.31	H	54.0	86.0	-8.7	Pass*
4874.00	48.70	34.72	H	54.0	86.0	-19.3	Pass*
All other spurious emissions and harmonics are more than 20 dB below the applicable limit.							

*Field strength of emissions appearing within restricted frequency bands shall not exceed the limits in § 15.209.

Fundamental Frequency:		2462 MHz					
Measured Conducted Power:		19.39 dBm					
Power Setting:		0					
Frequency Test Range:		30 MHz – 25 GHz					
Frequency (MHz)	RF Peak Level (dBµV/m)	RF Avg Level (dBµV/m)	Antenna Plane (H/V)	Limit 15.209 (dBµV/m)	Limit 15.247 (dBµV/m)	Margin (dB)	Pass/Fail
2462.00	106.65	--	V	--	--	--	--
2462.00	104.67	--	H	--	--	--	--
4102.95	53.99	42.93	V	54.0	86.7	-11.1	Pass*
4102.95	57.02	44.90	H	54.0	86.7	-9.1	Pass*
All other spurious emissions and harmonics are more than 20 dB below the applicable limit.							

*Field strength of emissions appearing within restricted frequency bands shall not exceed the limits in § 15.209.

Fundamental Frequency:		2472 MHz					
Measured Conducted Power:		14.76 dBm					
Power Setting:		8					
Frequency Test Range:		30 MHz – 25 GHz					
Frequency (MHz)	RF Peak Level (dBµV/m)	RF Avg Level (dBµV/m)	Antenna Plane (H/V)	Limit 15.209 (dBµV/m)	Limit 15.247 (dBµV/m)	Margin (dB)	Pass/Fail
2472.00	102.42	--	V	--	--	--	--
2472.00	102.31	--	H	--	--	--	--
4120.04	50.47	37.97	V	54.0	82.4	-16.0	Pass*
4120.04	50.28	38.46	H	54.0	82.4	-15.5	Pass*
All other spurious emissions and harmonics are more than 20 dB below the applicable limit.							

*Field strength of emissions appearing within restricted frequency bands shall not exceed the limits in § 15.209.

5.4.4.2.2. Band –Edge RF Radiated Emissions

Plot 5.4.4.2.2.1. Band-Edge RF Radiated Emissions at 3 m, Horizontal Polarization
802.11g, BPSK 6 Mbps, 2412 MHz, Power Setting 0

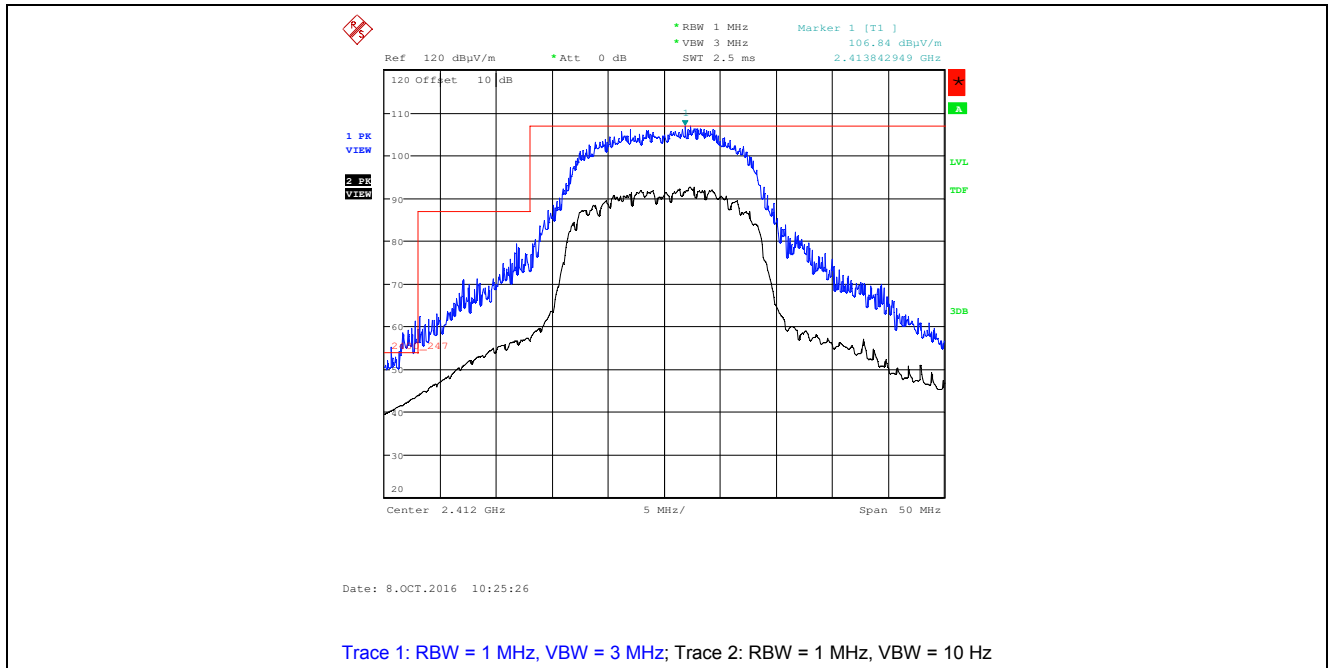

Plot 5.4.4.2.2.2. Band-Edge RF Radiated Emissions at 3 m, Vertical Polarization
802.11g, BPSK 6 Mbps, 2412 MHz, Power Setting 0

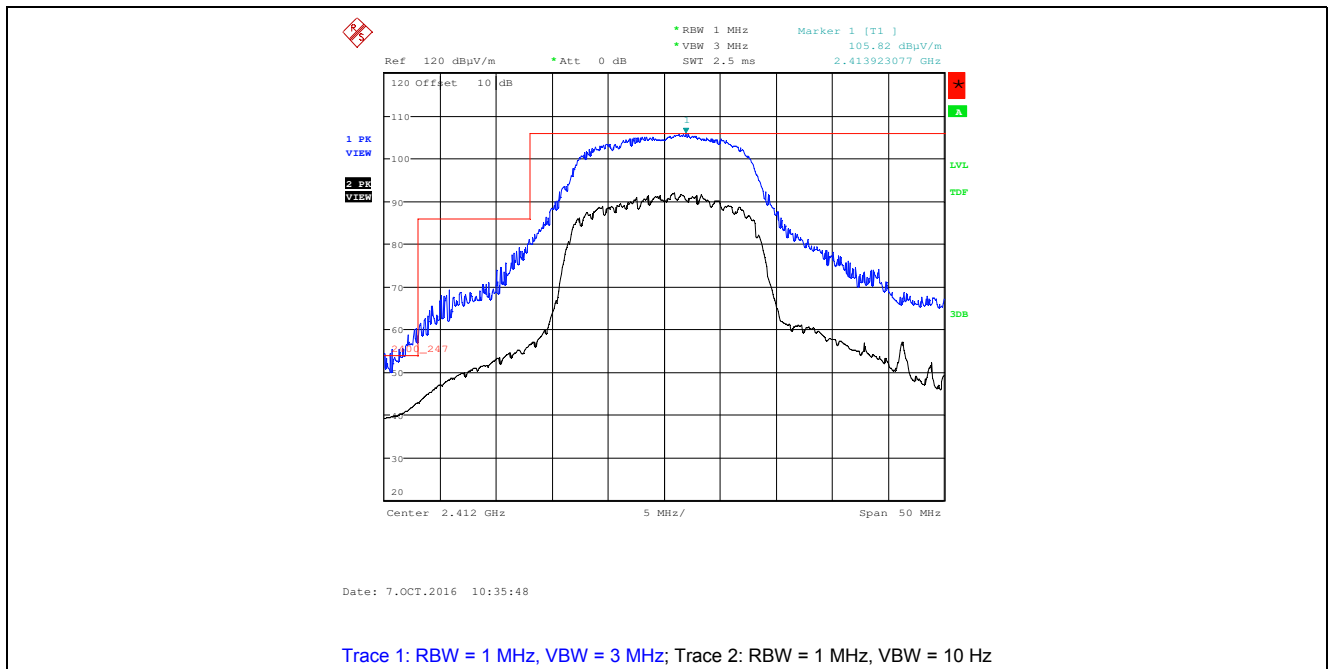

Plot 5.4.4.2.3. Band-Edge RF Radiated Emissions at 3 m, Horizontal Polarization
802.11g, BPSK 6 Mbps, 2462 MHz, Power Setting 0

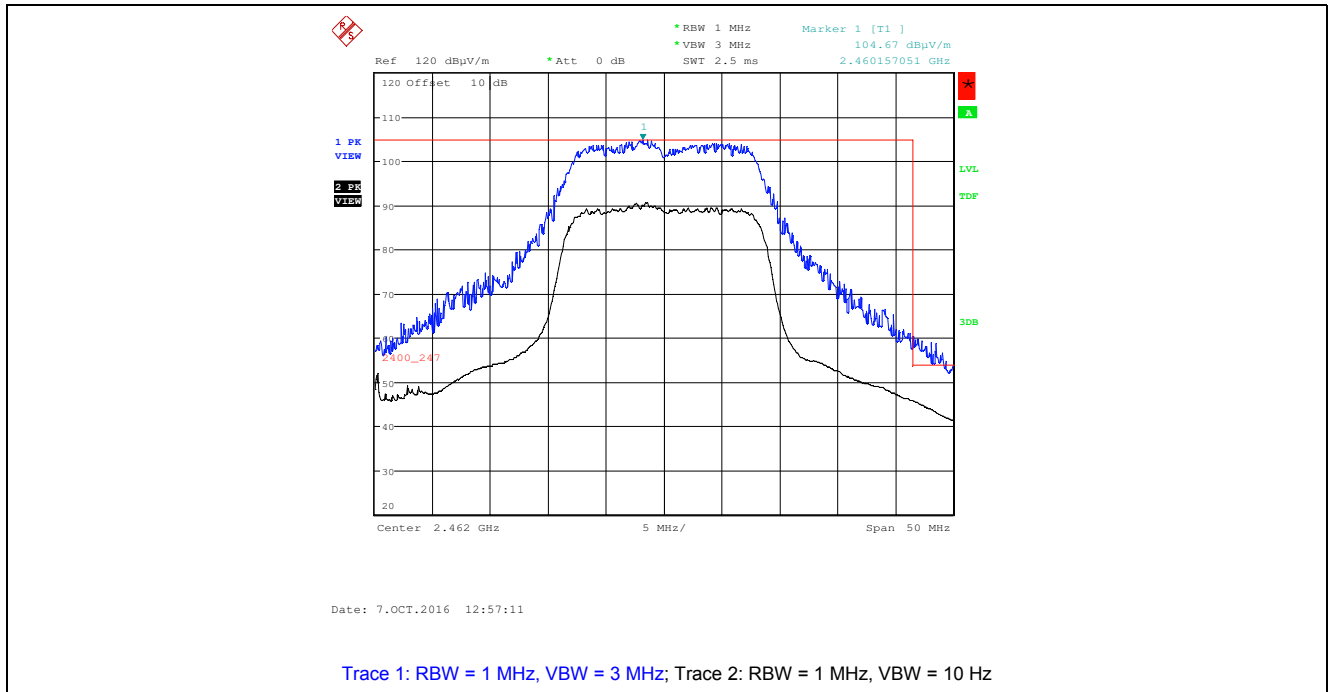

Plot 5.4.4.2.4. Band-Edge RF Radiated Emissions at 3 m, Vertical Polarization
802.11g, BPSK 6 Mbps, 2462 MHz, Power Setting 0

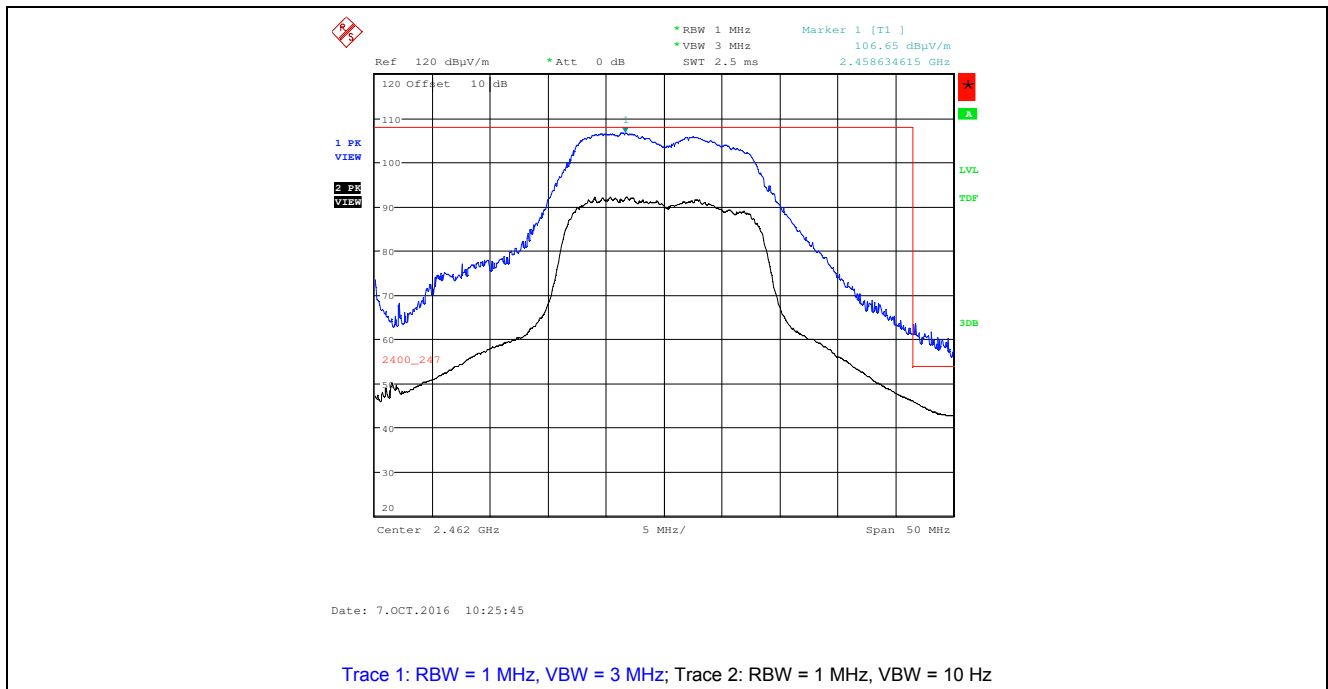

Plot 5.4.4.2.2.5. Band-Edge RF Radiated Emissions at 3 m, Horizontal Polarization
 802.11g, BPSK 6 Mbps, 2467 MHz, Power Setting 1

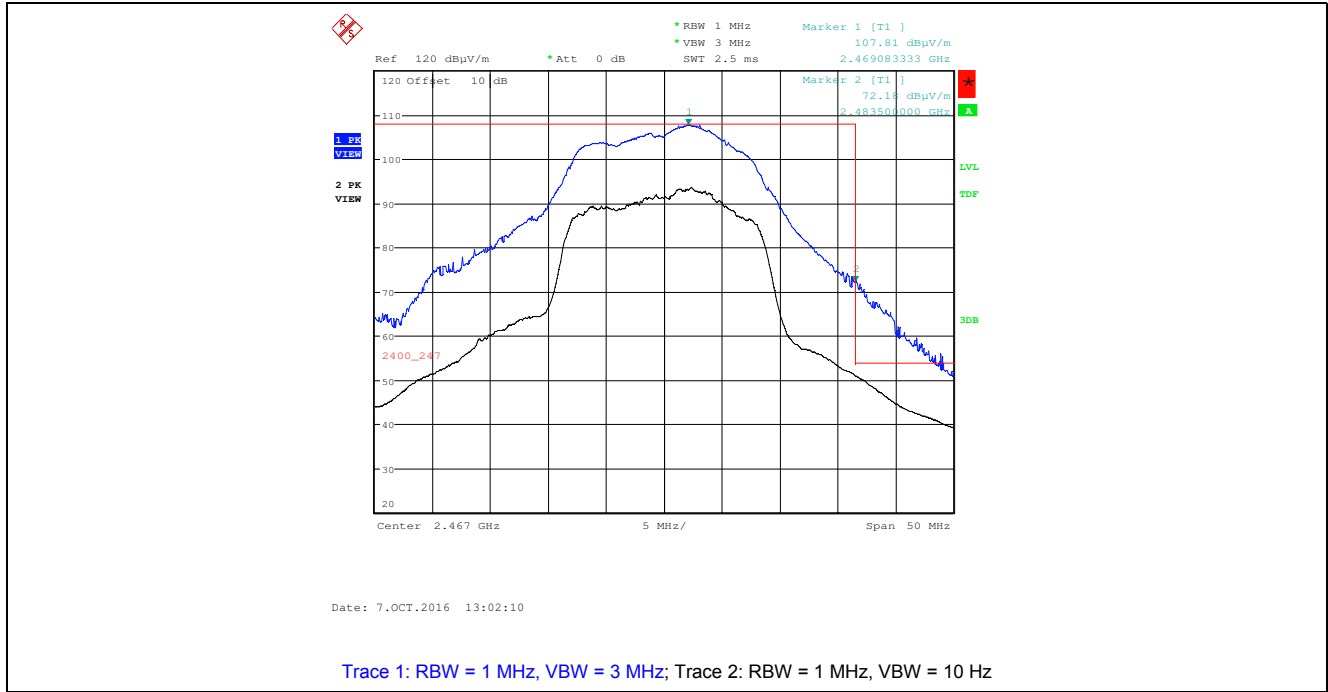

Plot 5.4.4.2.2.6. Band-Edge RF Radiated Emissions at 3 m, Vertical Polarization
 802.11g, BPSK 6 Mbps, 2467 MHz, Power Setting 1

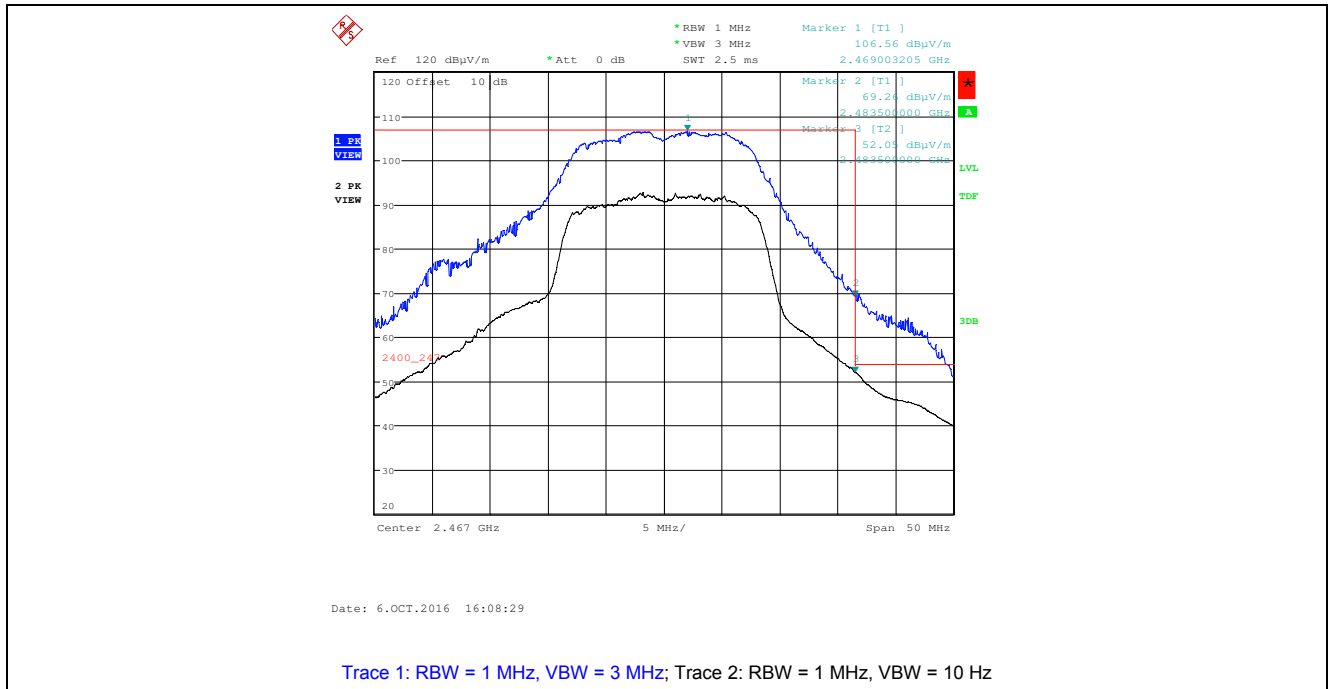

Plot 5.4.4.2.2.7. Band-Edge RF Radiated Emissions at 3 m, Horizontal Polarization
 802.11g, BPSK 6 Mbps, 2472MHz, Power Setting 8

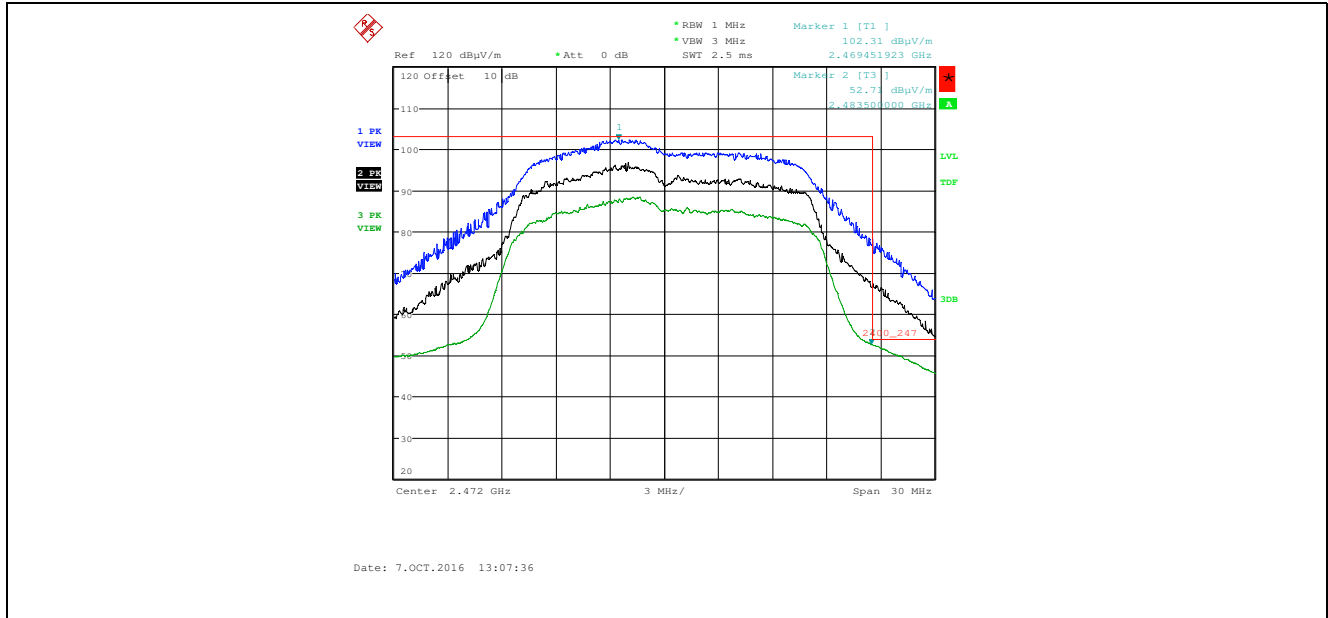

Plot 5.4.4.2.2.8. Band-Edge RF Radiated Emissions at 3 m, Horizontal Polarization
 802.11g, BPSK 6 Mbps, 2472MHz, Power Setting 8

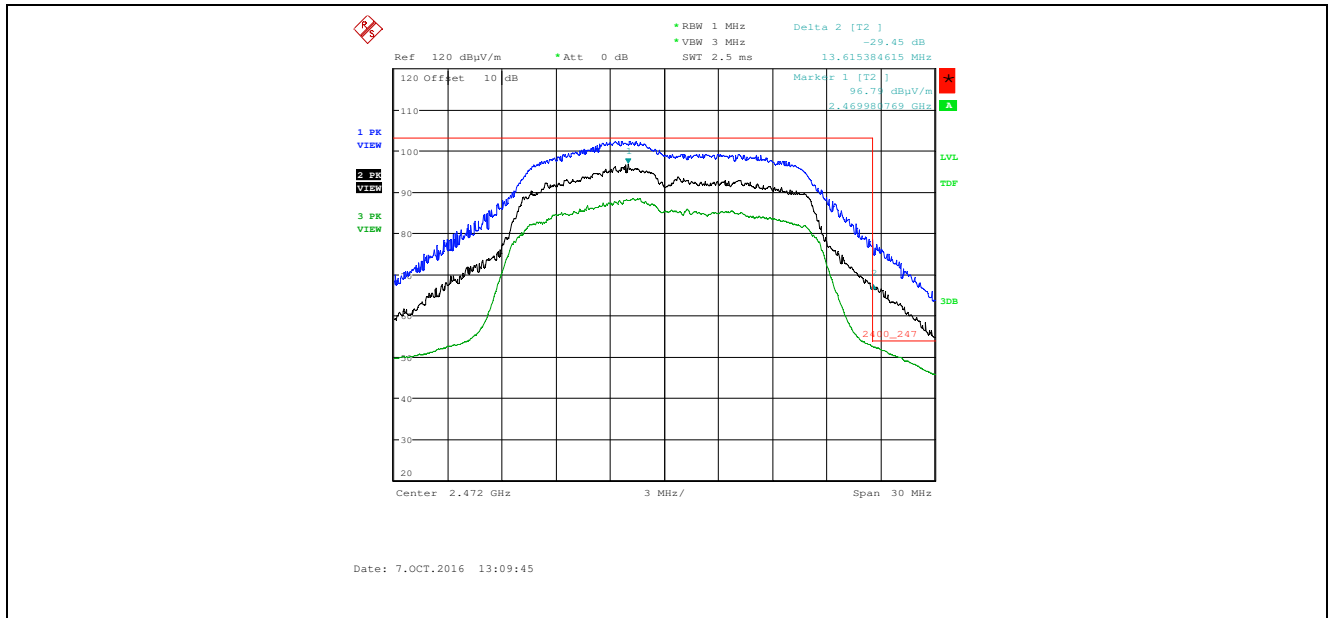

Trace 1: RBW = 1 MHz, VBW = 3 MHz
 Trace 2: RBW = 300 kHz, VBW = 1 MHz, Delta (Peak to Band-Edge): 29.45dB
 Trace 3: RBW = 1 MHz, VBW = 10 Hz
 Peak Band-Edge at 2483.5 MHz: Peak = 102.31 dBμV/m – 29.45 dB = 72.86 dBμV/m

Plot 5.4.4.2.9. Band-Edge RF Radiated Emissions at 3 m, Vertical Polarization
 802.11g, BPSK 6 Mbps, 2472MHz, Power Setting 8

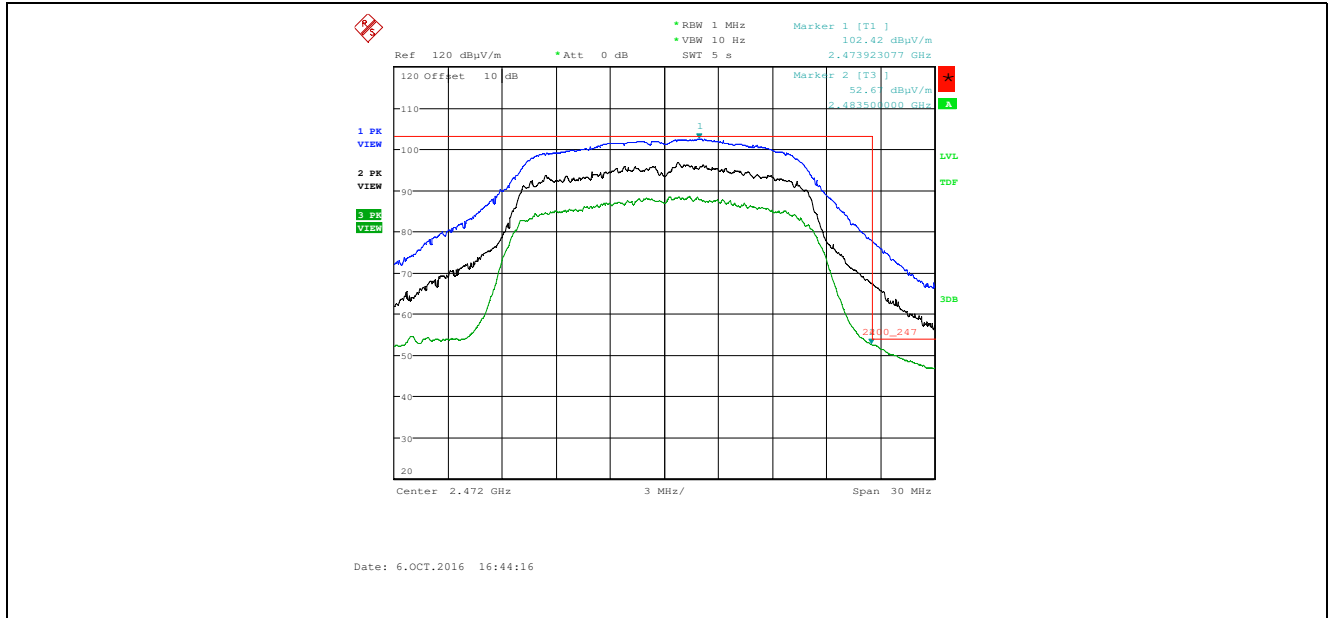

Plot 5.4.4.2.10. Band-Edge RF Radiated Emissions at 3 m, Vertical Polarization
 802.11g, BPSK 6 Mbps, 2472MHz, Power Setting 8

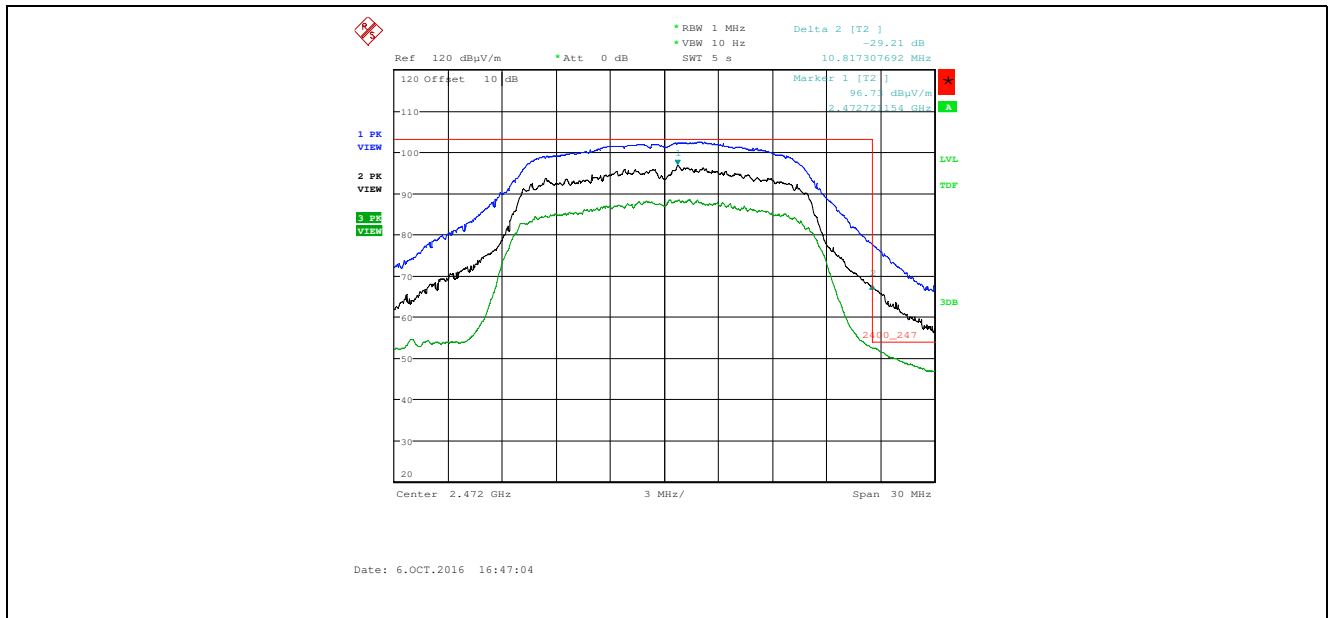

Trace 1: RBW = 1 MHz, VBW = 3 MHz
 Trace 2: RBW = 300 kHz, VBW = 1 MHz, Delta (Peak to Band-Edge): 29.21 dB
 Trace 3: RBW = 1 MHz, VBW = 10 Hz
 Peak Band-Edge at 2483.5 MHz: Peak = 102.42 dBμV/m – 29.21 dB = 73.21 dBμV/m

5.4.4.3. 802.11n, BPSK 1/2 MCS 0, 6.5 Mbps Data Rate

5.4.4.3.1. Spurious Radiated Emissions

Fundamental Frequency:		2412 MHz					
Measured Conducted Power:		18.95 dBm					
Power Setting:		0					
Frequency Test Range:		30 MHz – 25 GHz					
Frequency (MHz)	RF Peak Level (dBµV/m)	RF Avg Level (dBµV/m)	Antenna Plane (H/V)	Limit 15.209 (dBµV/m)	Limit 15.247 (dBµV/m)	Margin (dB)	Pass/Fail
2412.00	105.55	--	V	--	--	--	--
2412.00	105.83	--	H	--	--	--	--
4020.06	53.46	40.31	V	54.0	85.8	-13.7	Pass*
4020.06	54.62	42.31	H	54.0	85.8	-11.7	Pass*
4824.00	47.29	34.27	V	54.0	85.8	-19.7	Pass*
All other spurious emissions and harmonics are more than 20 dB below the applicable limit.							

*Field strength of emissions appearing within restricted frequency bands shall not exceed the limits in § 15.209.

Fundamental Frequency:		2437 MHz					
Measured Conducted Power:		20.28 dBm					
Power Setting:		0					
Frequency Test Range:		30 MHz – 25 GHz					
Frequency (MHz)	RF Peak Level (dBµV/m)	RF Avg Level (dBµV/m)	Antenna Plane (H/V)	Limit 15.209 (dBµV/m)	Limit 15.247 (dBµV/m)	Margin (dB)	Pass/Fail
2437.00	105.21	--	V	--	--	--	--
2437.00	105.07	--	H	--	--	--	--
4061.73	54.74	42.72	V	54.0	85.2	-11.3	Pass*
4061.73	58.68	45.92	H	54.0	85.2	-8.1	Pass*
4874.00	46.98	34.43	H	54.0	85.2	-19.6	Pass*
All other spurious emissions and harmonics are more than 20 dB below the applicable limit.							

*Field strength of emissions appearing within restricted frequency bands shall not exceed the limits in § 15.209.

Fundamental Frequency:		2462 MHz					
Measured Conducted Power:		19.14 dBm					
Power Setting:		0					
Frequency Test Range:		30 MHz – 25 GHz					
Frequency (MHz)	RF Peak Level (dBµV/m)	RF Avg Level (dBµV/m)	Antenna Plane (H/V)	Limit 15.209 (dBµV/m)	Limit 15.247 (dBµV/m)	Margin (dB)	Pass/Fail
2462.00	105.89	--	V	--	--	--	--
2462.00	104.00	--	H	--	--	--	--
4102.95	53.44	40.45	V	54.0	85.9	-13.6	Pass*
4102.95	56.41	43.06	H	54.0	85.9	-10.9	Pass*
All other spurious emissions and harmonics are more than 20 dB below the applicable limit.							

*Field strength of emissions appearing within restricted frequency bands shall not exceed the limits in § 15.209.

Fundamental Frequency:		2472 MHz					
Measured Conducted Power:		12.89 dBm					
Power Setting:		10					
Frequency Test Range:		30 MHz – 25 GHz					
Frequency (MHz)	RF Peak Level (dBµV/m)	RF Avg Level (dBµV/m)	Antenna Plane (H/V)	Limit 15.209 (dBµV/m)	Limit 15.247 (dBµV/m)	Margin (dB)	Pass/Fail
2472.00	101.34	--	V	--	--	--	--
2472.00	100.42	--	H	--	--	--	--
4120.04	49.38	36.64	V	54.0	81.3	-17.4	Pass*
4120.04	50.51	37.01	H	54.0	81.3	-17.0	Pass*
All other spurious emissions and harmonics are more than 20 dB below the applicable limit.							

*Field strength of emissions appearing within restricted frequency bands shall not exceed the limits in § 15.209.

5.4.4.3.2. Band –Edge RF Radiated Emissions

Plot 5.4.4.3.2.1. Band-Edge RF Radiated Emissions at 3 m, Horizontal Polarization
802.11n, BPSK 1/2, 6.5 Mbps, 2412 MHz, Power Setting 0

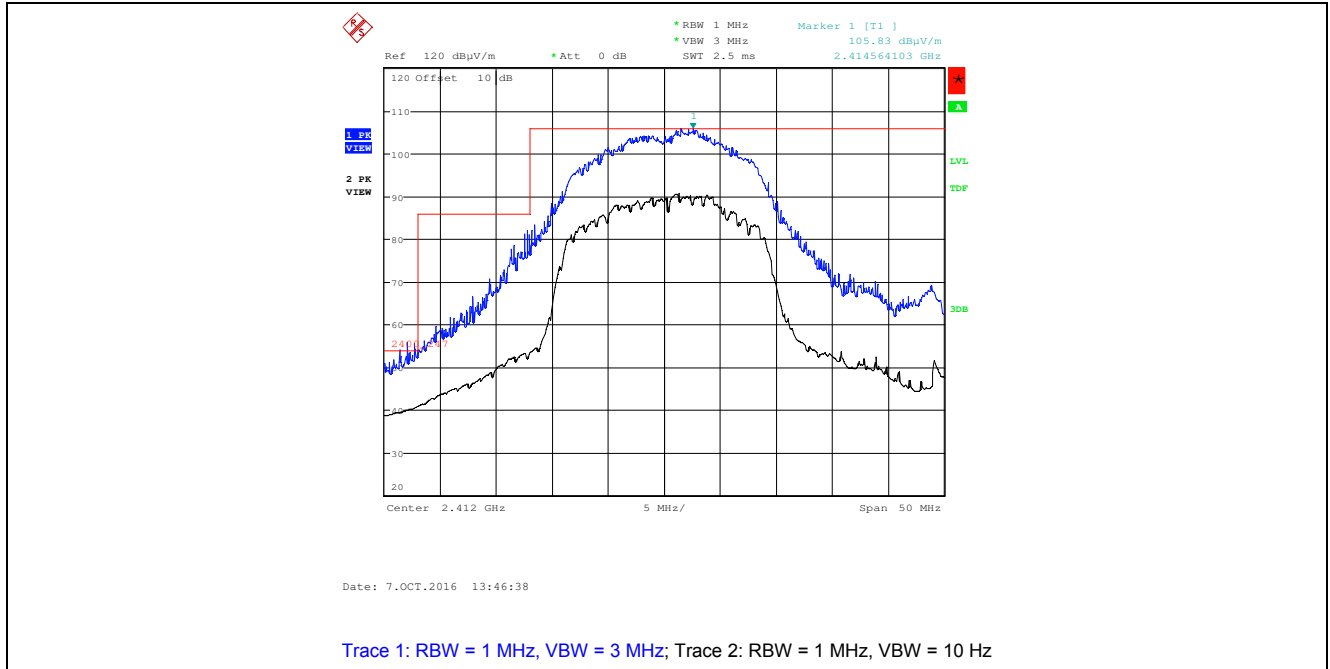

Plot 5.4.4.3.2.2. Band-Edge RF Radiated Emissions at 3 m, Vertical Polarization
802.11n, BPSK 1/2, 6.5 Mbps, 2412 MHz, Power Setting 0

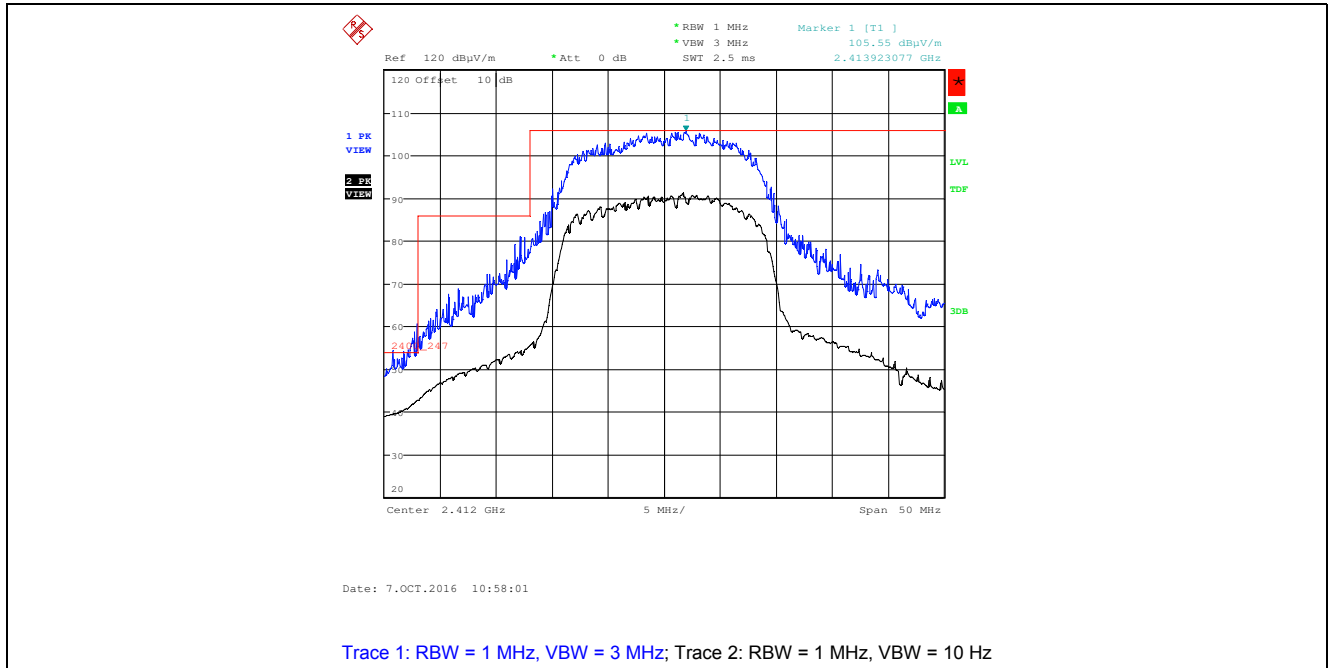

Plot 5.4.4.3.2.3. Band-Edge RF Radiated Emissions at 3 m, Horizontal Polarization
802.11n, BPSK 1/2, 6.5 Mbps, 2462 MHz, Power Setting 0

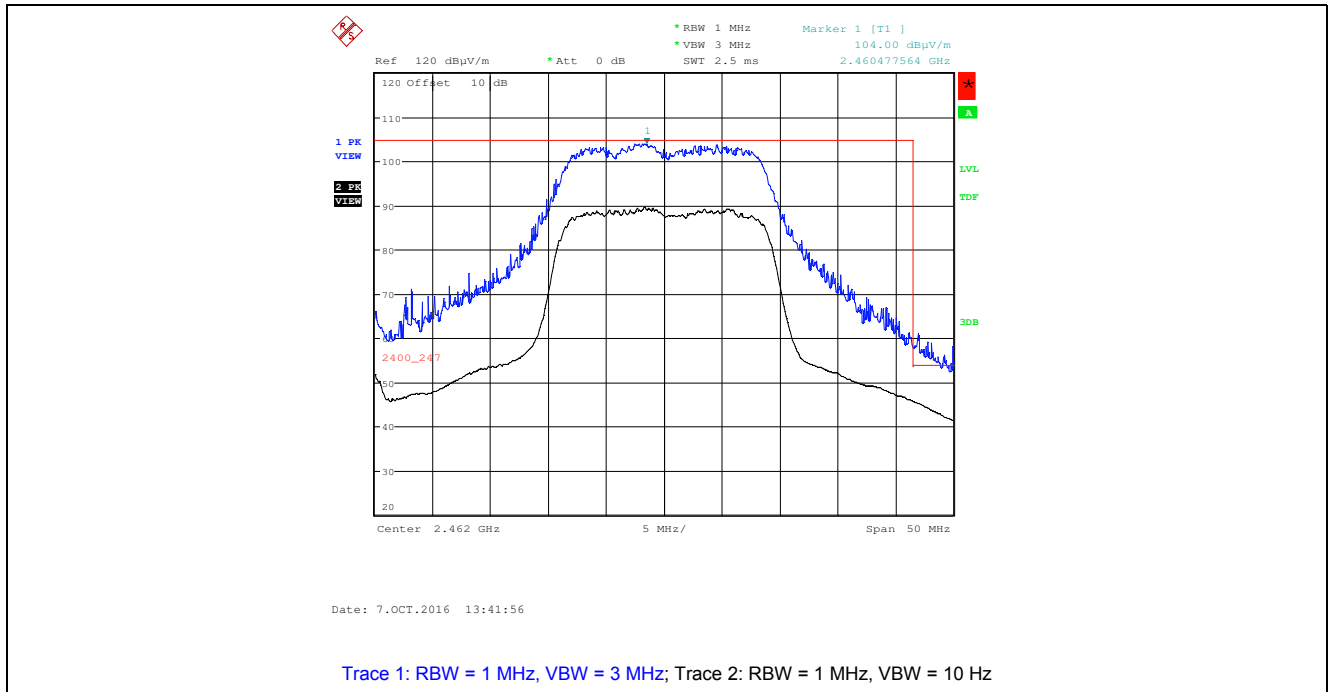

Plot 5.4.4.3.2.4. Band-Edge RF Radiated Emissions at 3 m, Vertical Polarization
802.11n, BPSK 1/2, 6.5 Mbps, 2462 MHz, Power Setting 0

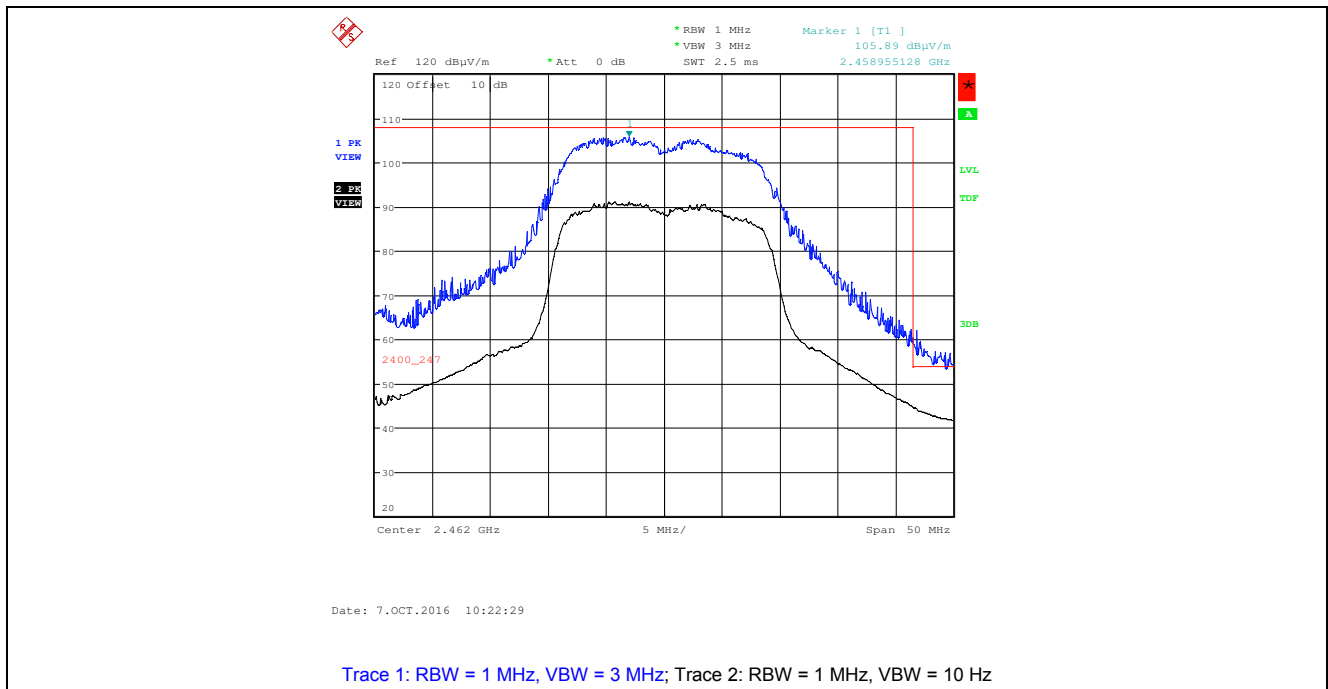

Plot 5.4.4.3.2.5. Band-Edge RF Radiated Emissions at 3 m, Horizontal Polarization
802.11n, BPSK 1/2, 6.5 Mbps, 2467 MHz, Power Setting 1

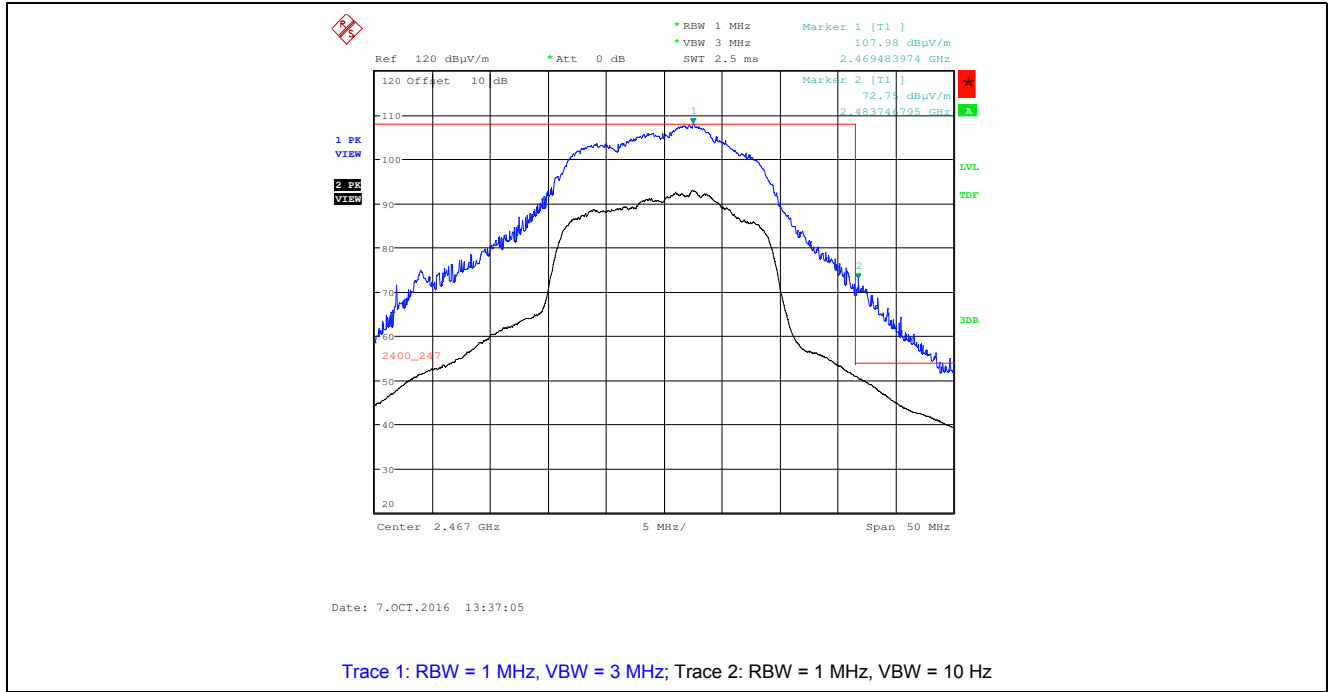

Plot 5.4.4.3.2.6. Band-Edge RF Radiated Emissions at 3 m, Vertical Polarization
802.11n, BPSK 1/2, 6.5 Mbps, 2467 MHz, Power Setting 1

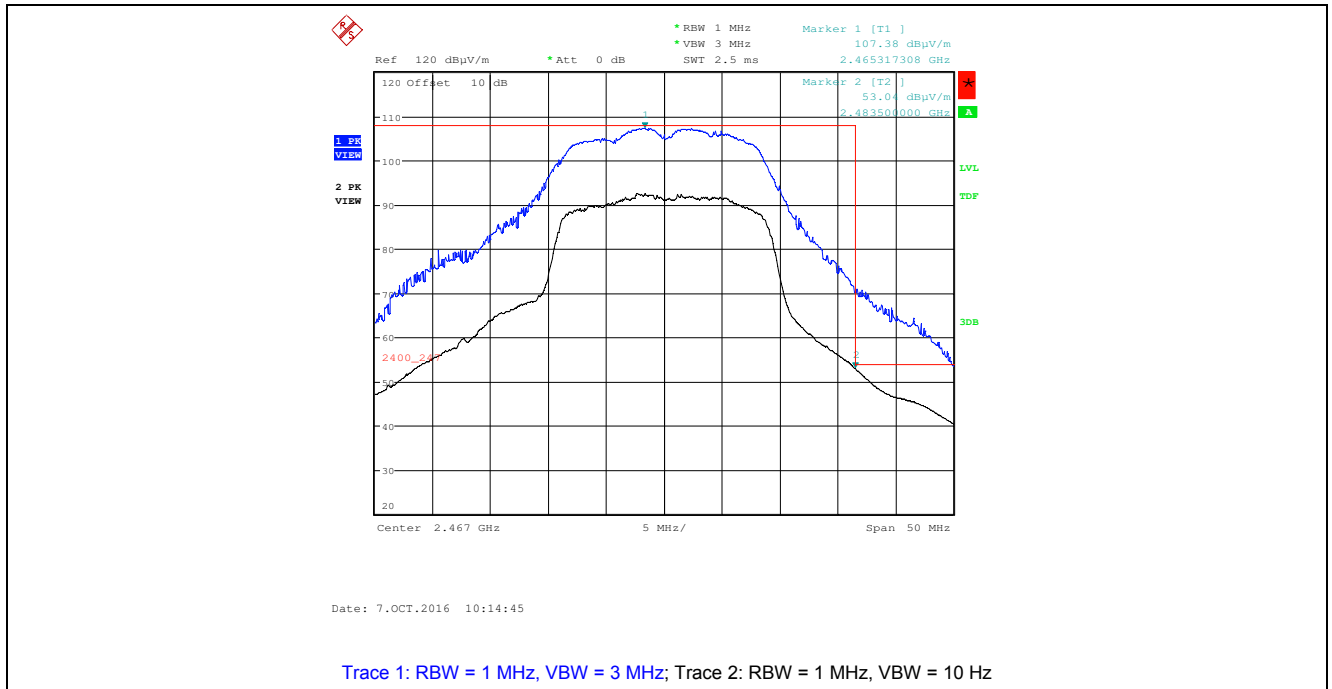

Plot 5.4.4.3.2.7. Band-Edge RF Radiated Emissions at 3 m, Horizontal Polarization
 802.11n, BPSK 1/2, 6.5 Mbps, 2472MHz, Power Setting 10

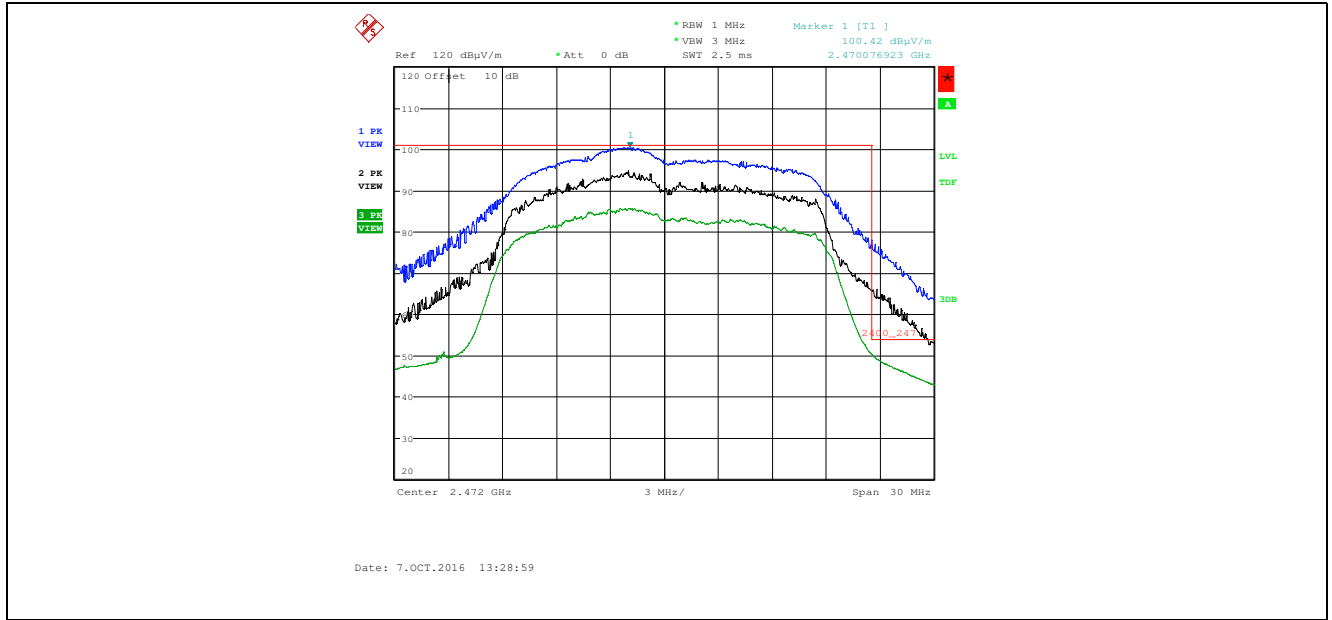

Plot 5.4.4.3.2.8. Band-Edge RF Radiated Emissions at 3 m, Horizontal Polarization
 802.11n, BPSK 1/2, 6.5 Mbps, 2472MHz, Power Setting 10

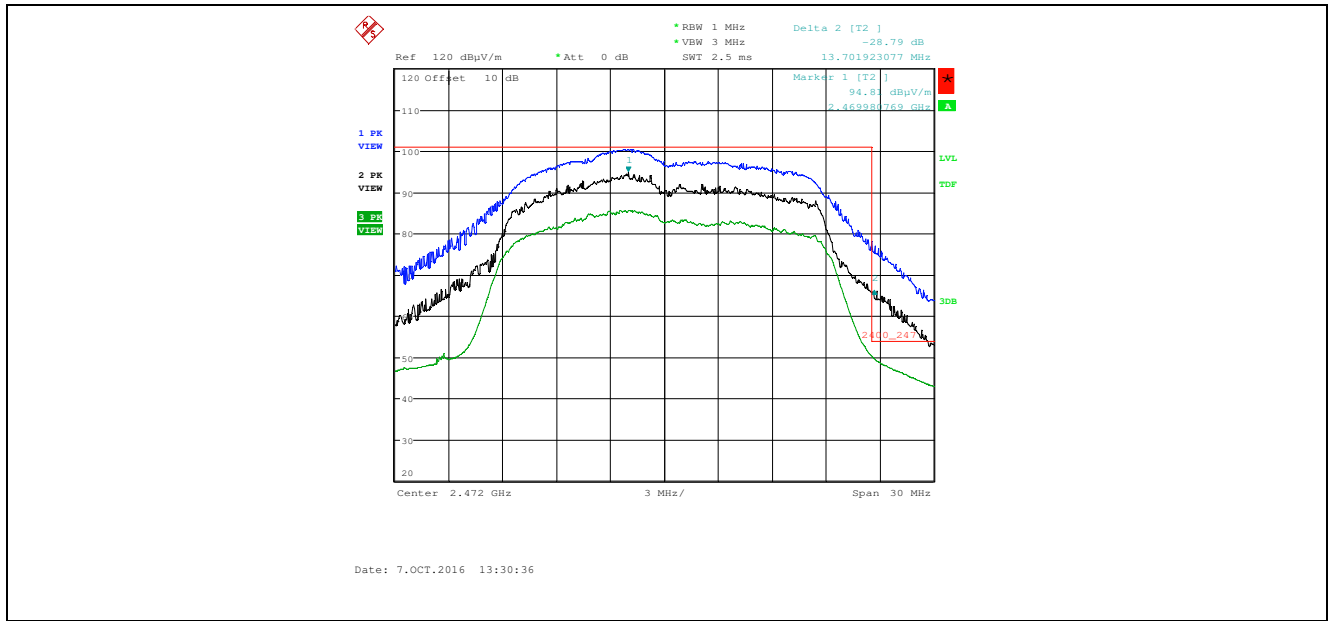

Trace 1: RBW = 1 MHz, VBW = 3 MHz
 Trace 2: RBW = 300 kHz, VBW = 1 MHz, Delta (Peak to Band-Edge): 28.79 dB
 Trace 3: RBW = 1 MHz, VBW = 10 Hz
 Peak Band-Edge at 2483.5 MHz: Peak = 100.42 dBμV/m – 28.79 dB = 71.63 dBμV/m

Plot 5.4.4.3.2.9. Band-Edge RF Radiated Emissions at 3 m, Vertical Polarization
 802.11n, BPSK 1/2, 6.5 Mbps, 2472MHz, Power Setting 10

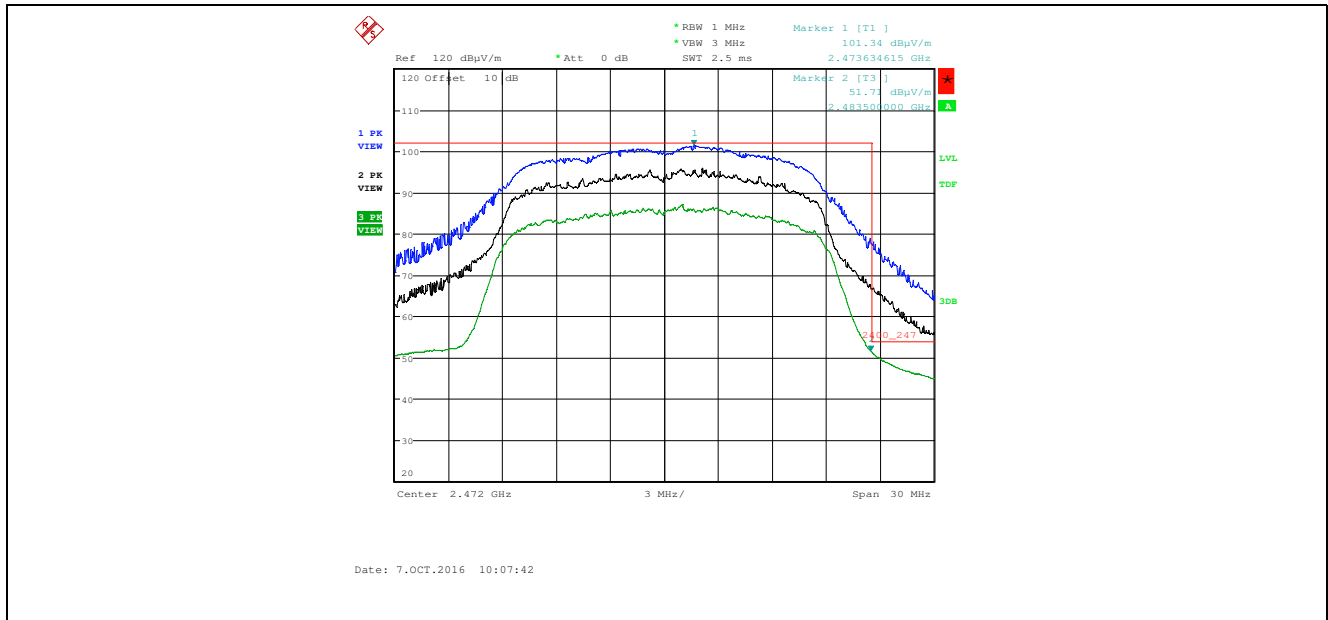

Plot 5.4.4.3.2.10. Band-Edge RF Radiated Emissions at 3 m, Vertical Polarization
 802.11n, BPSK 1/2, 6.5 Mbps, 2472MHz, Power Setting 10

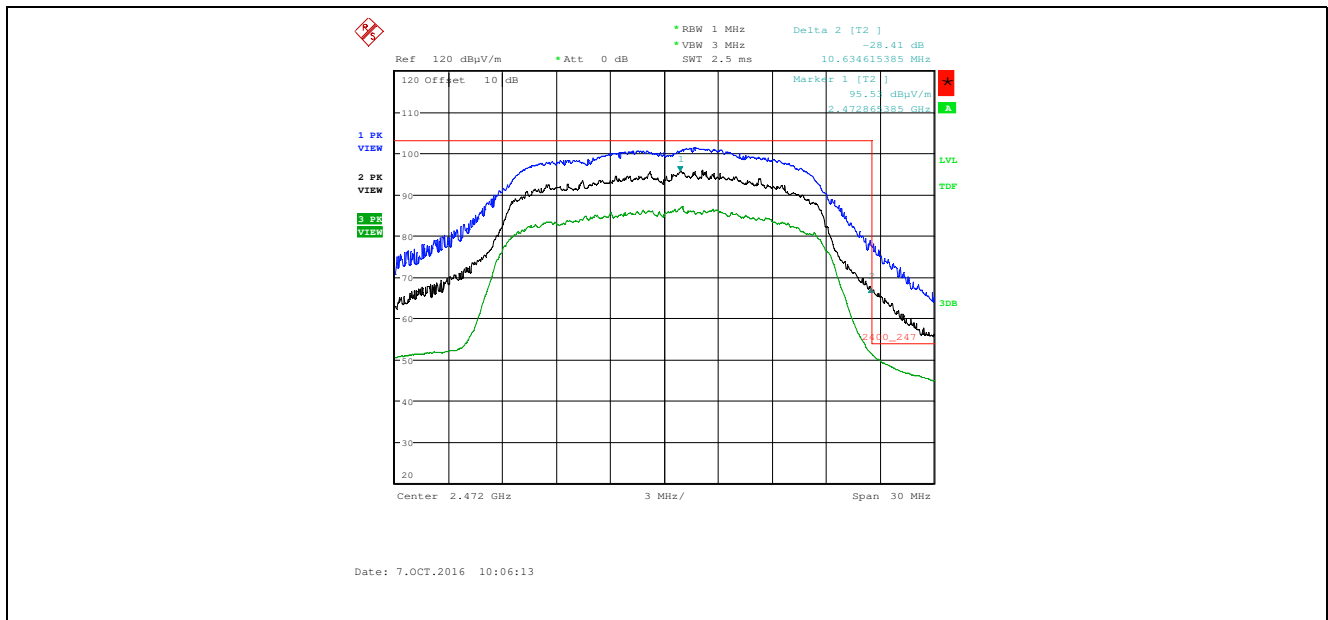

Trace 1: RBW = 1 MHz, VBW = 3 MHz
 Trace 2: RBW = 300 kHz, VBW = 1 MHz, Delta (Peak to Band-Edge): 28.41 dB
 Trace 3: RBW = 1 MHz, VBW = 10 Hz
 Peak Band-Edge at 2483.5 MHz: Peak = 101.34 dBμV/m – 28.41 dB = 72.93 dBμV/m

5.5. POWER SPECTRAL DENSITY [§ 15.247(e)]

5.5.1. Limit(s)

For digitally modulated systems, the power spectral density conducted from the intentional radiator to the antenna shall not be greater than 8 dBm in any 3 kHz band during any time interval of continuous transmission.

5.5.2. Method of Measurements

KDB 558074D01 DTS Meas Guidance v03r05, Section 10.2 Peak PSD

5.5.3. Test Arrangement

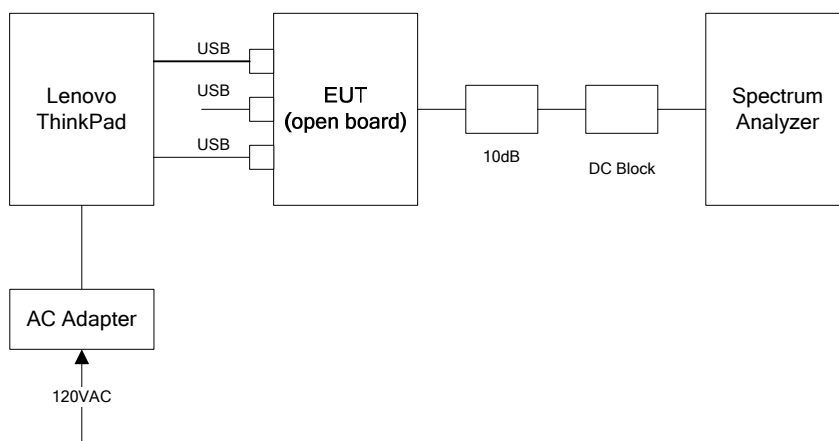

5.5.4. Test Data

802.11b					
Modulation	Data Rate (Mbps)	Frequency (MHz)	PSD (dBm)	Software Rate #	Power Setting
DBPSK	1	2412	-9.93	1	0
		2437	-8.69	1	0
		2472	-11.08	1	1
DQPSK	2	2412	-9.22	2	0
		2437	-7.92	2	0
		2472	-10.09	2	1
CCK	5.5	2412	-7.20	3	0
		2437	-6.01	3	0
		2472	-8.12	3	1

802.11g					
Modulation	Data Rate (Mbps)	Frequency (MHz)	PSD (dBm)	Software Rate #	Power Setting
BPSK	6	2412	-14.06	6	0
		2437	-10.72	6	0
		2472	-19.10	6	8
QPSK	12	2412	-13.21	8	0
		2437	-10.42	8	0
		2472	-19.01	8	8
16-QAM	24	2412	-14.29	10	0
		2437	-11.11	10	0
		2472	-19.37	10	8
64-QAM	48	2412	-15.59	12	0
		2437	-13.83	12	0
		2472	-22.82	12	8

802.11n					
Modulation	Data Rate (Mbps)	Frequency (MHz)	PSD (dBm)	Software Rate #	Power Setting
BPSK 1/2 MCS 0	6.5	2412	-13.34	14	0
		2437	-9.48	14	0
		2472	-20.28	14	10
QPSK 1/2 MCS 1	13	2412	-13.55	15	0
		2437	-9.58	15	0
		2472	-20.32	15	10
16-QAM 1/2 MCS 3	26	2412	-15.74	17	0
		2437	-12.79	17	0
		2472	-22.25	17	10
64-QAM 2/3 MCS 5	52	2412	-15.55	19	0
		2437	-13.16	19	0
		2472	-25.27	19	10

Plot 5.5.4.1. Power Spectral Density, 802.11b, DBPSK 1 Mbps, 2412 MHz, Power Setting 0

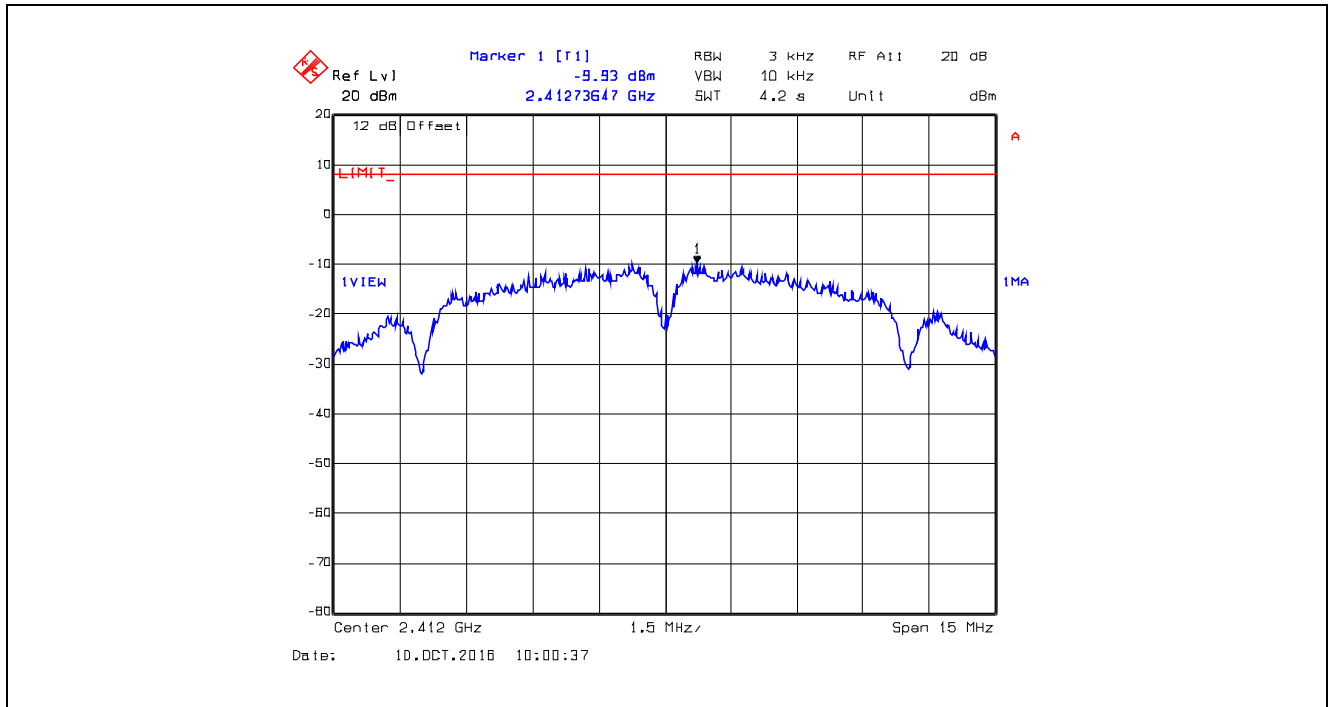

Plot 5.5.4.2. Power Spectral Density, 802.11b, DBPSK 1 Mbps, 2437 MHz, Power Setting 0

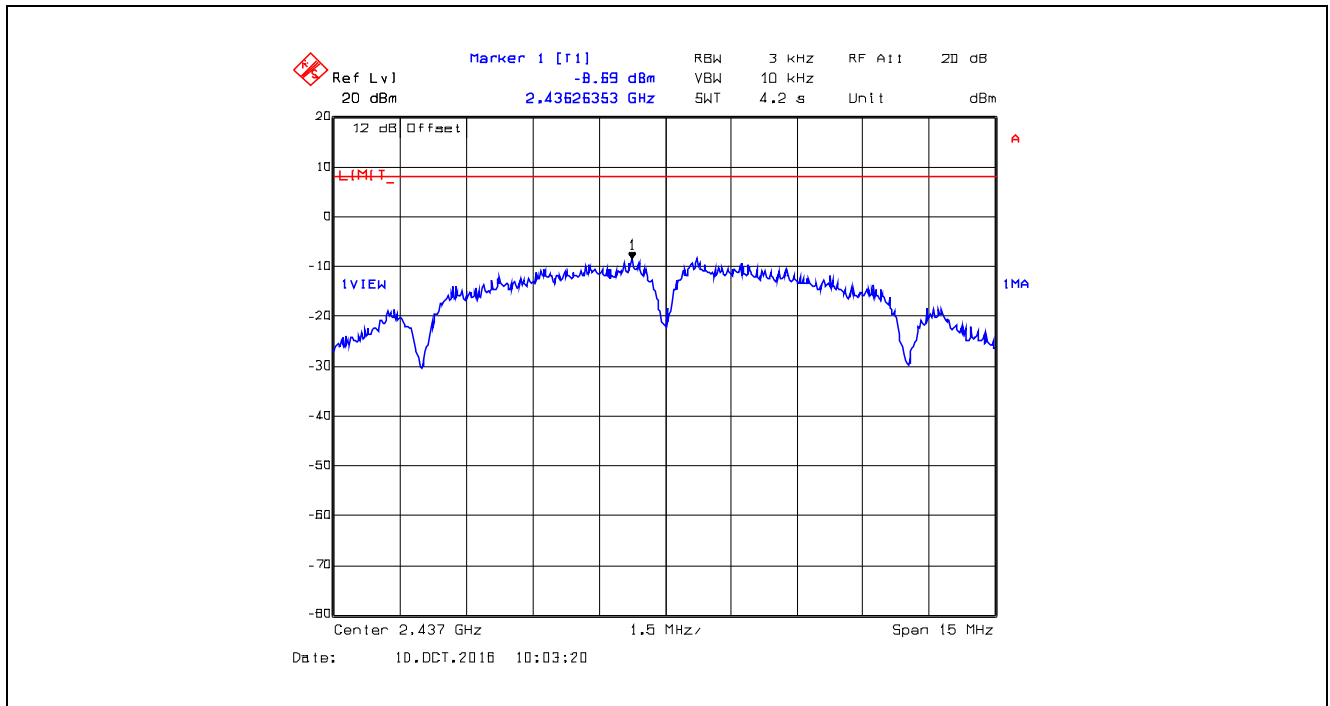

Plot 5.5.4.3. Power Spectral Density, 802.11b, DBPSK 1 Mbps, 2472 MHz, Power Setting 1

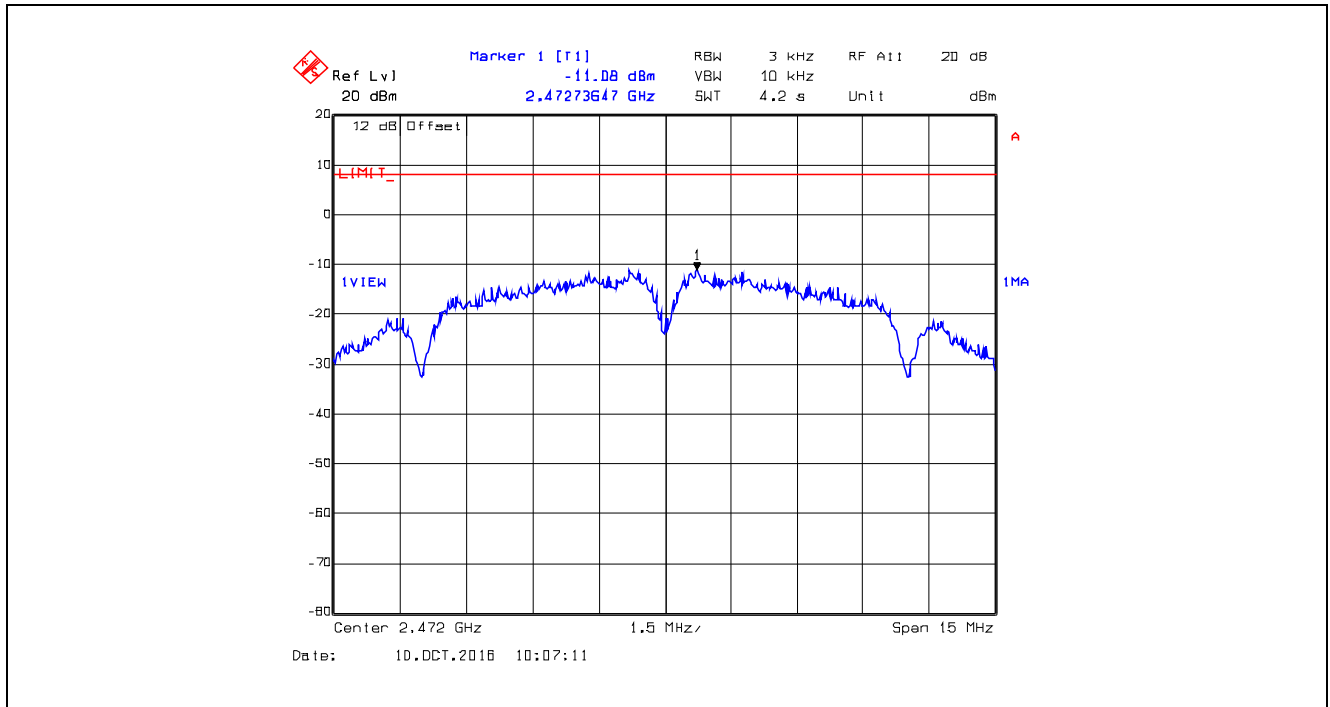

Plot 5.5.4.4. Power Spectral Density, 802.11b, DQPSK 2 Mbps, 2412 MHz, Power Setting 0

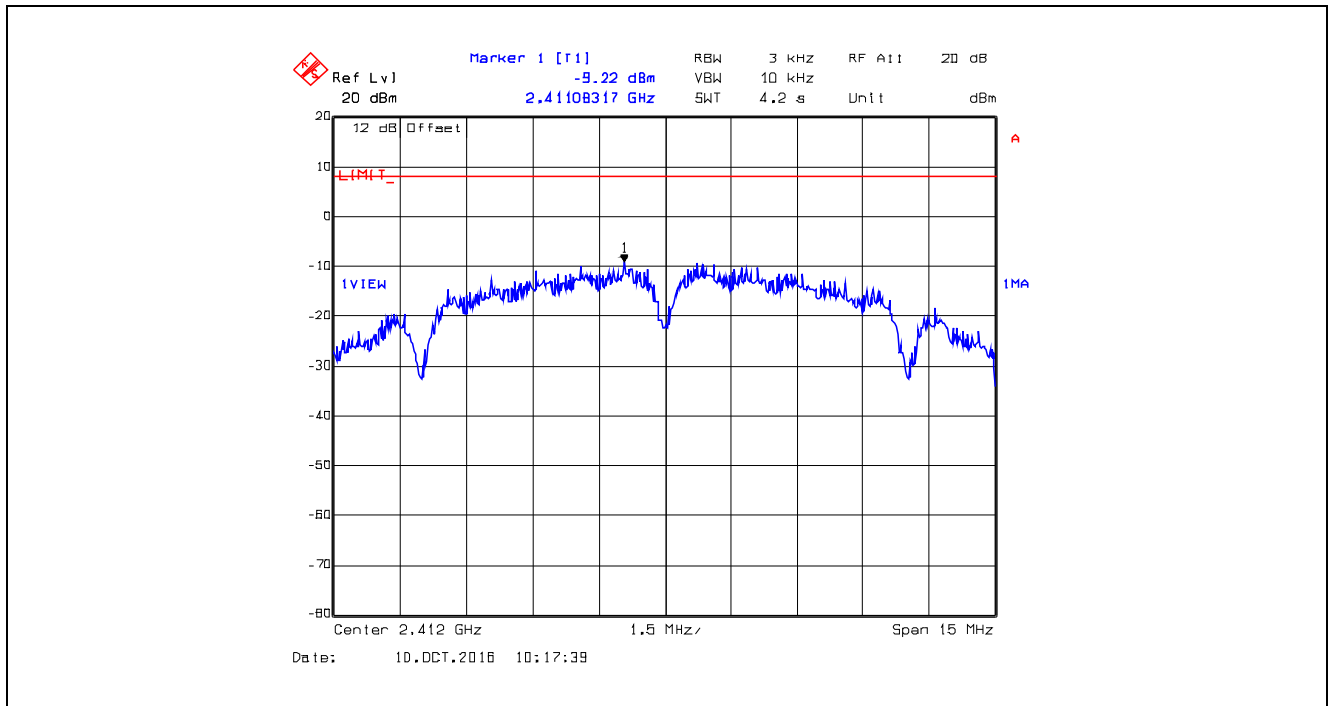

Plot 5.5.4.5. Power Spectral Density, 802.11b, DQPSK 2 Mbps, 2437 MHz, Power Setting 0

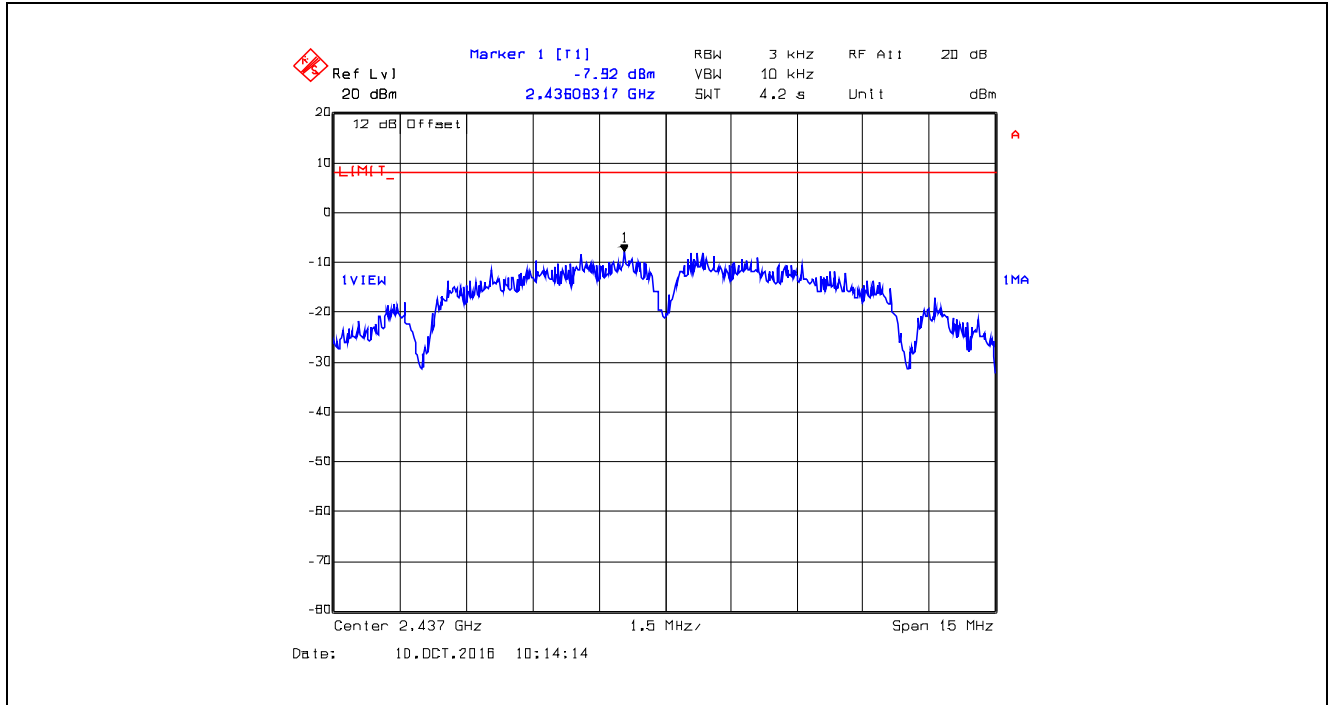

Plot 5.5.4.6. Power Spectral Density, 802.11b, DQPSK 2 Mbps, 2472 MHz, Power Setting 1

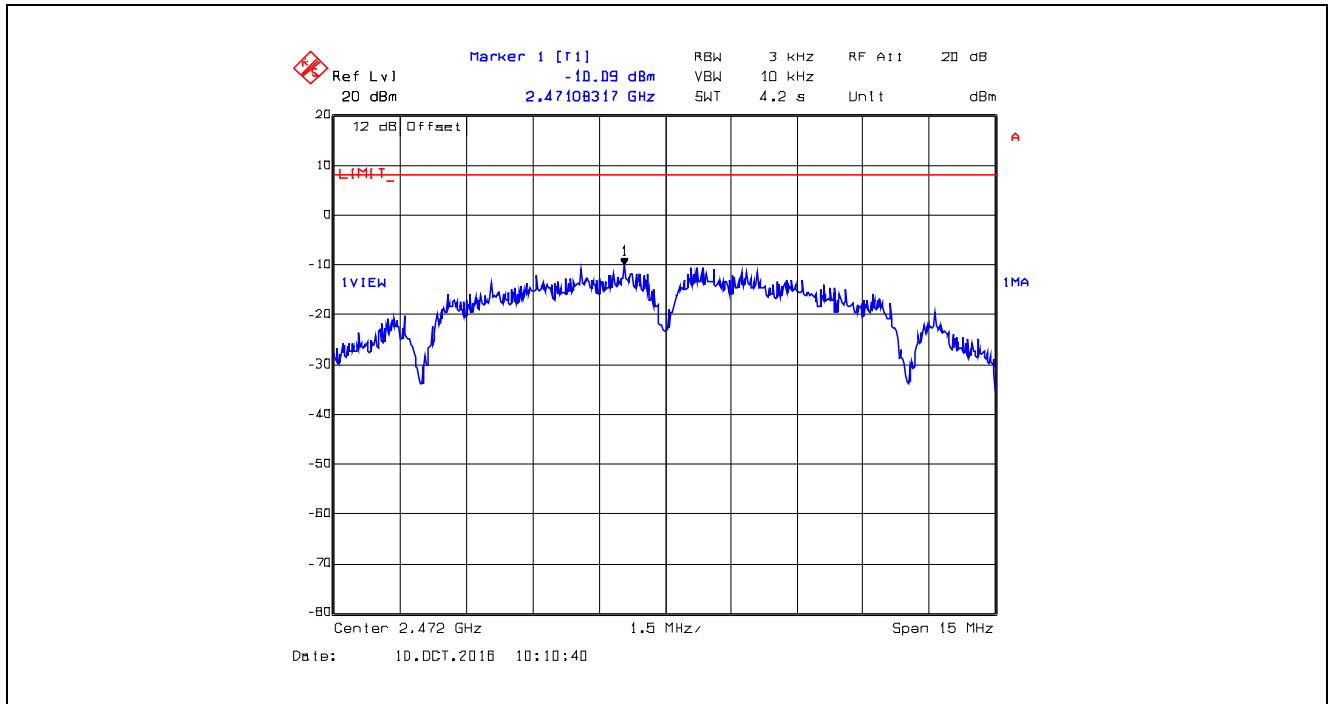

Plot 5.5.4.7. Power Spectral Density, 802.11b, CCK 5.5 Mbps, 2412 MHz, Power Setting 0

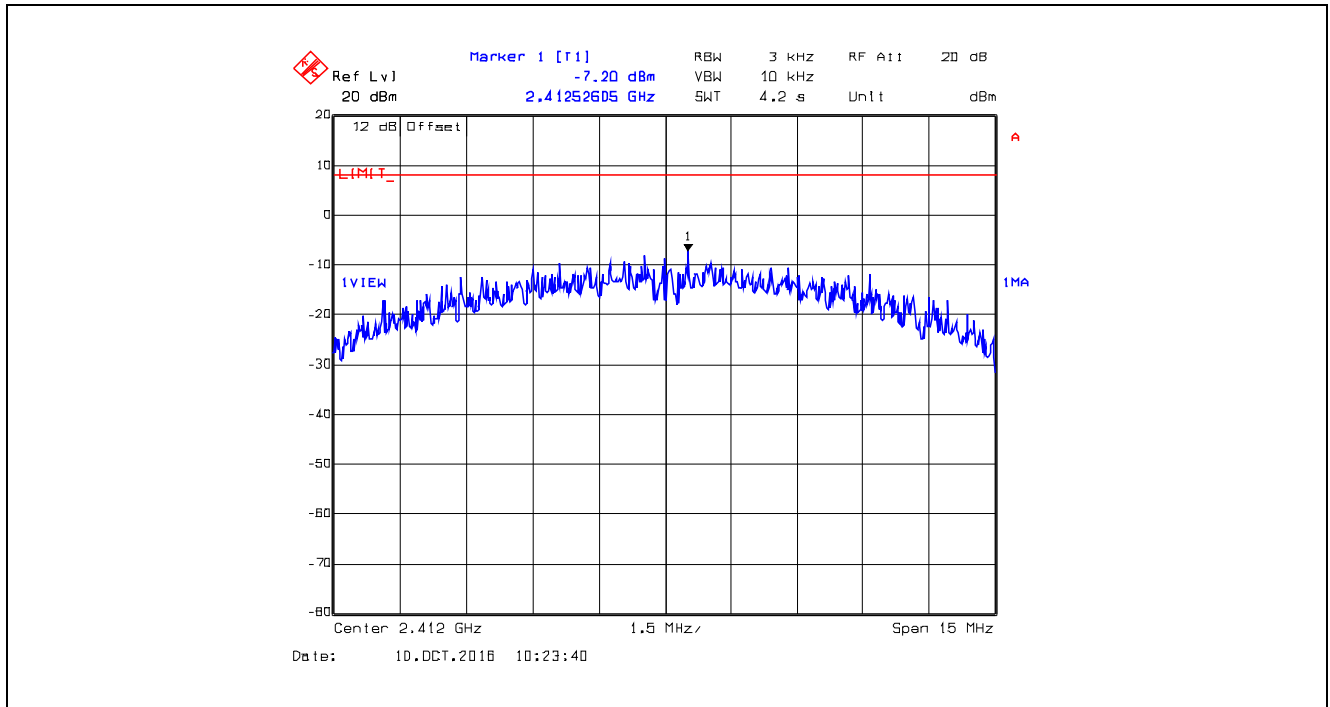

Plot 5.5.4.8. Power Spectral Density, 802.11b, CCK 5.5 Mbps, 2437 MHz, Power Setting 0

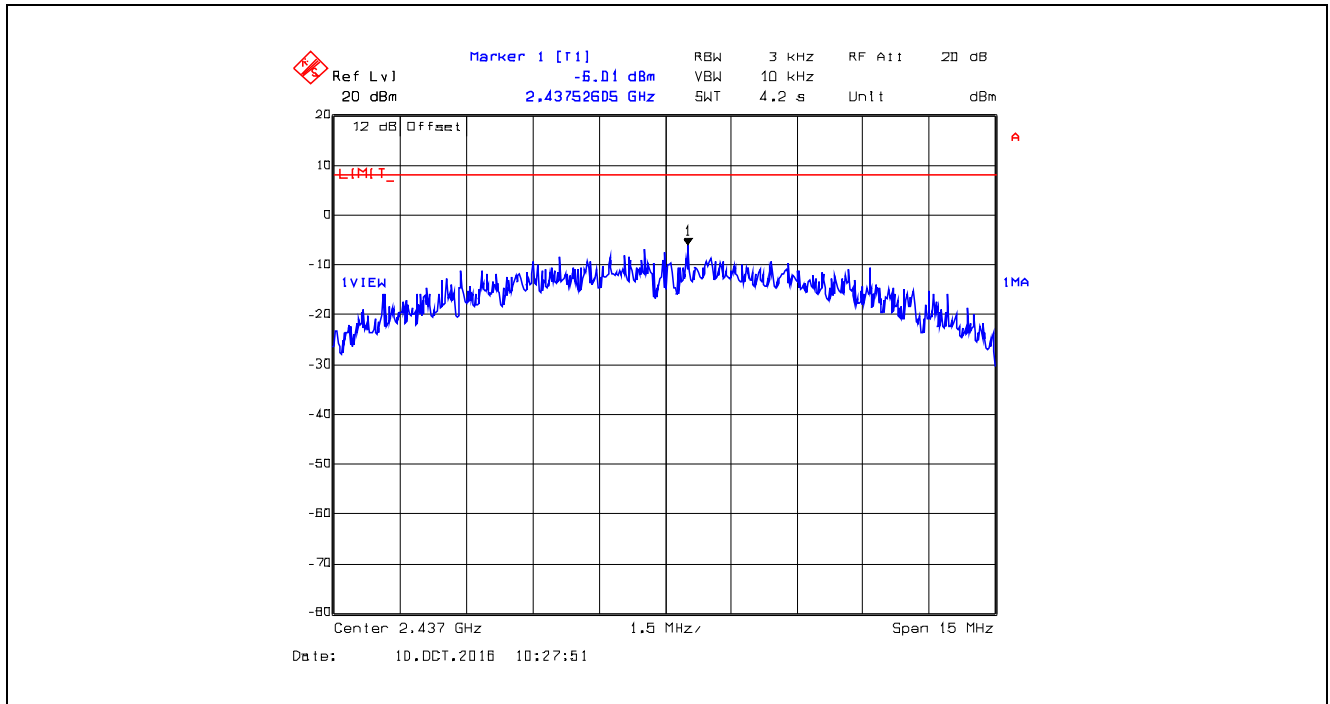

Plot 5.5.4.9. Power Spectral Density, 802.11b, CCK 5.5 Mbps, 2472 MHz, Power Setting 1

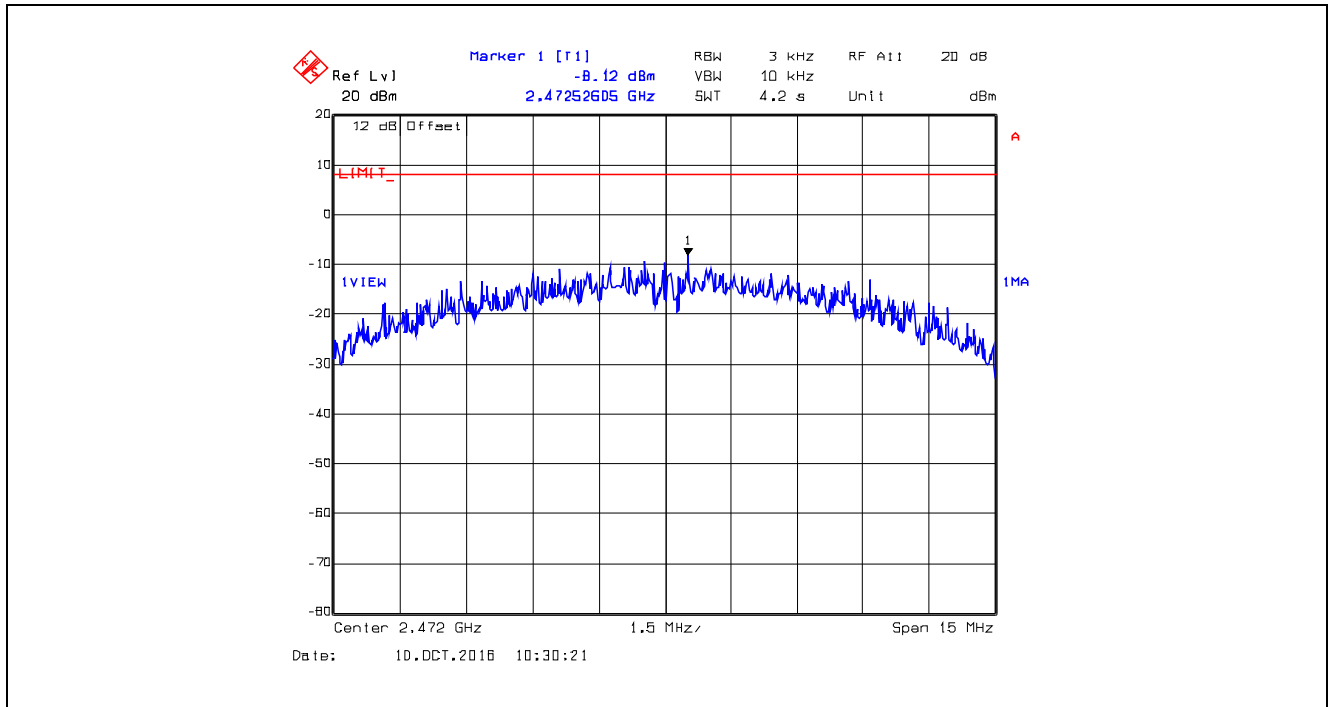

Plot 5.5.4.10. Power Spectral Density, 802.11g, BPSK 6 Mbps, 2412 MHz, Power Setting 0

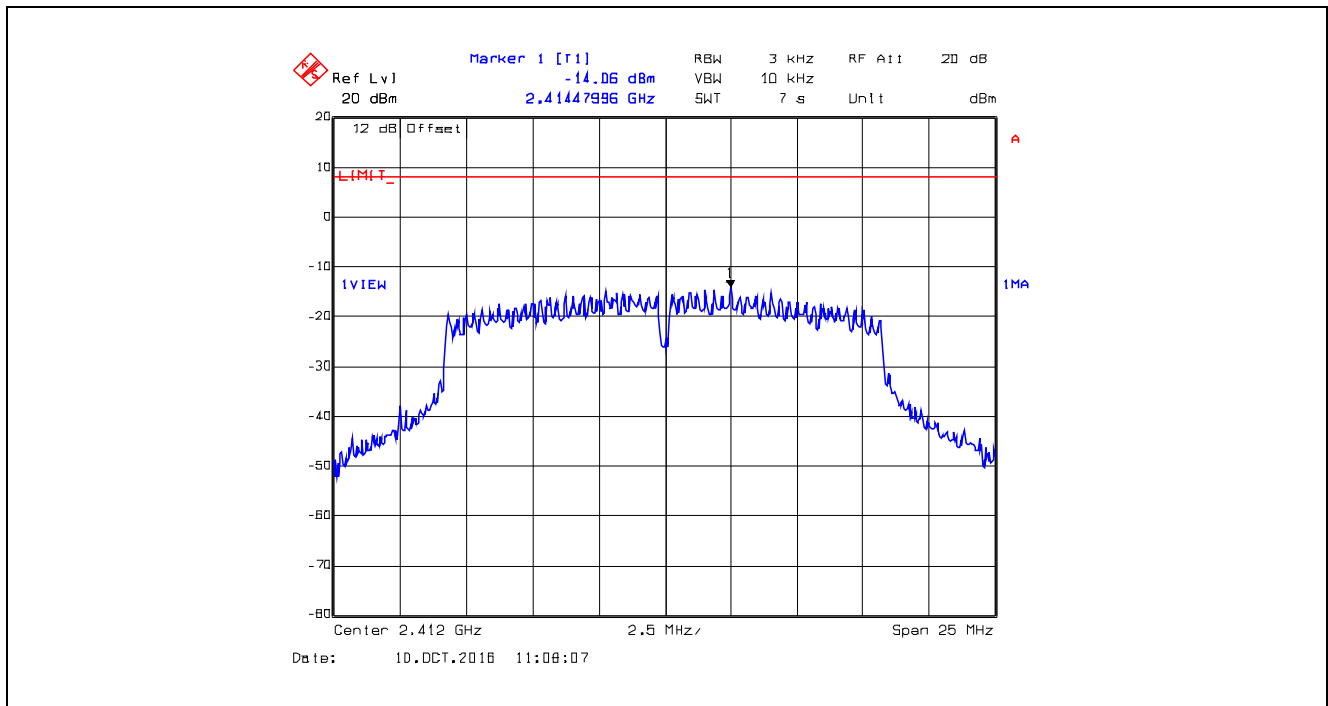

Plot 5.5.4.11. Power Spectral Density, 802.11g, BPSK 6 Mbps, 2437 MHz, Power Setting 0

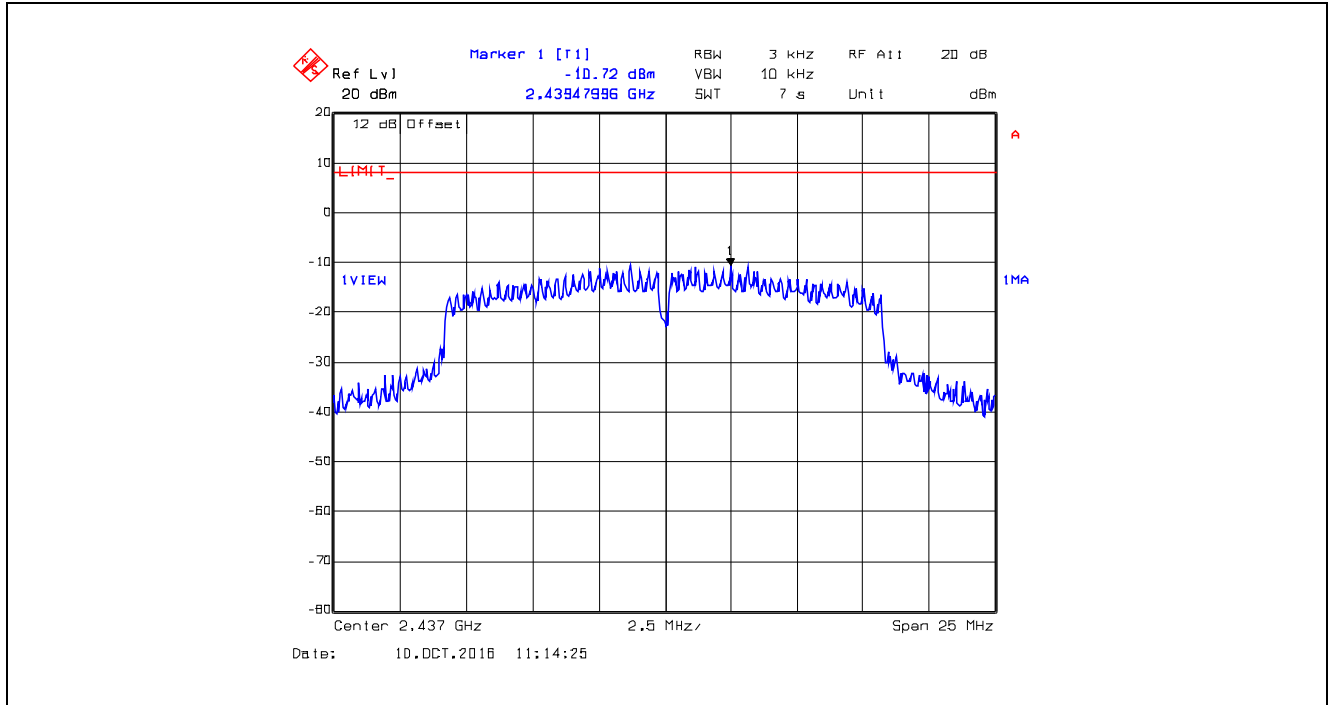

Plot 5.5.4.12. Power Spectral Density, 802.11g, BPSK 6 Mbps, 2472 MHz, Power Setting 8

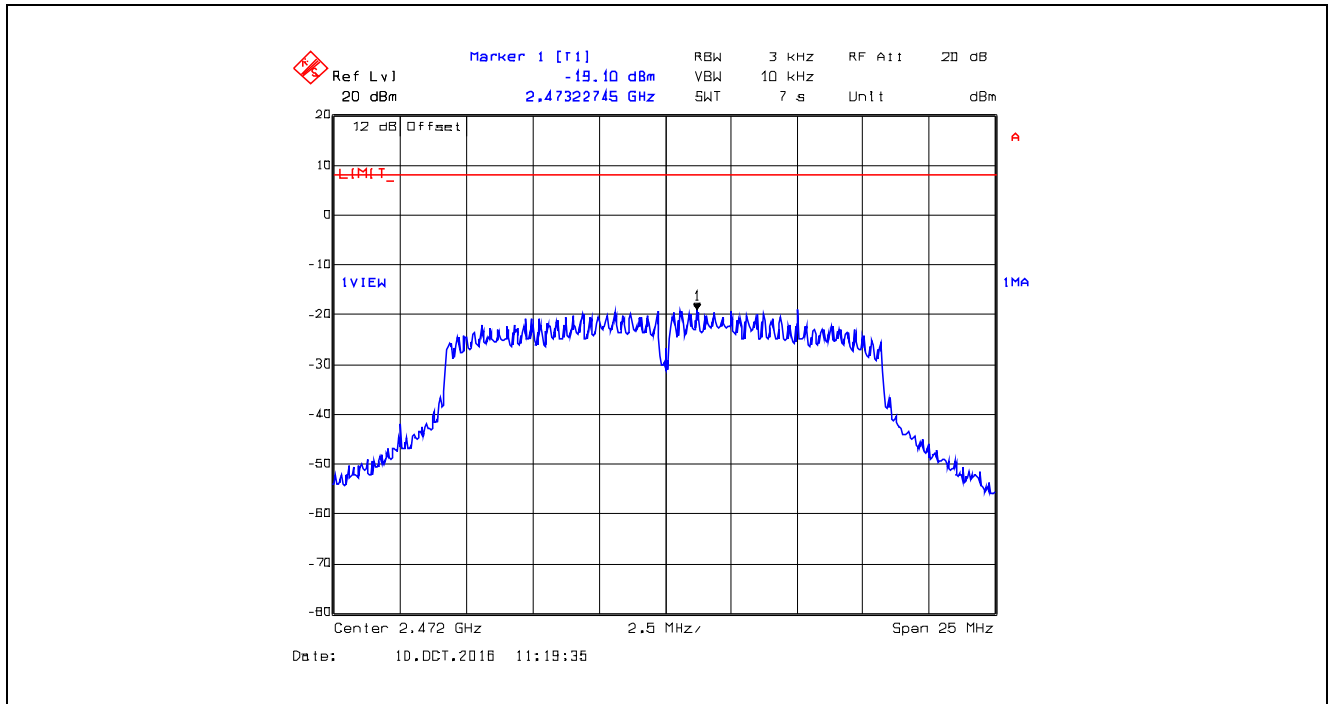

Plot 5.5.4.13. Power Spectral Density, 802.11g, QPSK 12 Mbps, 2412 MHz, Power Setting 0

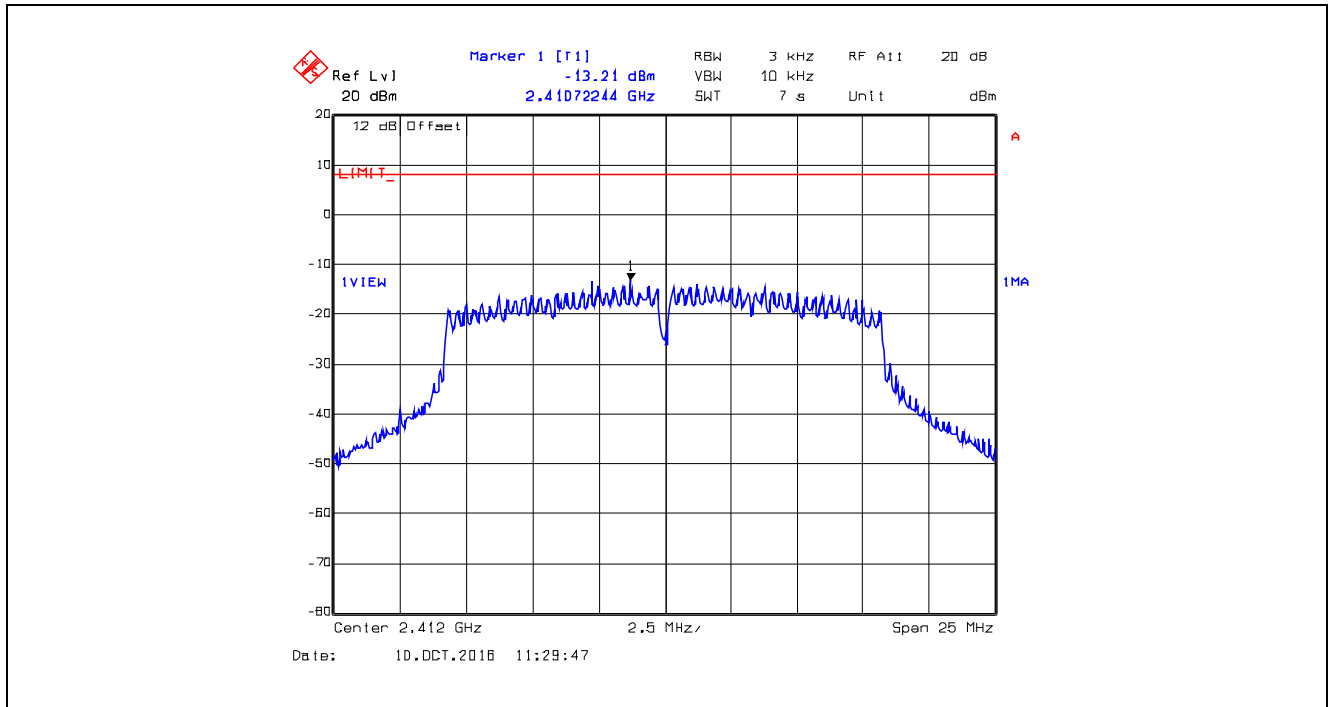

Plot 5.5.4.14. Power Spectral Density, 802.11g, QPSK 12 Mbps, 2437 MHz, Power Setting 0

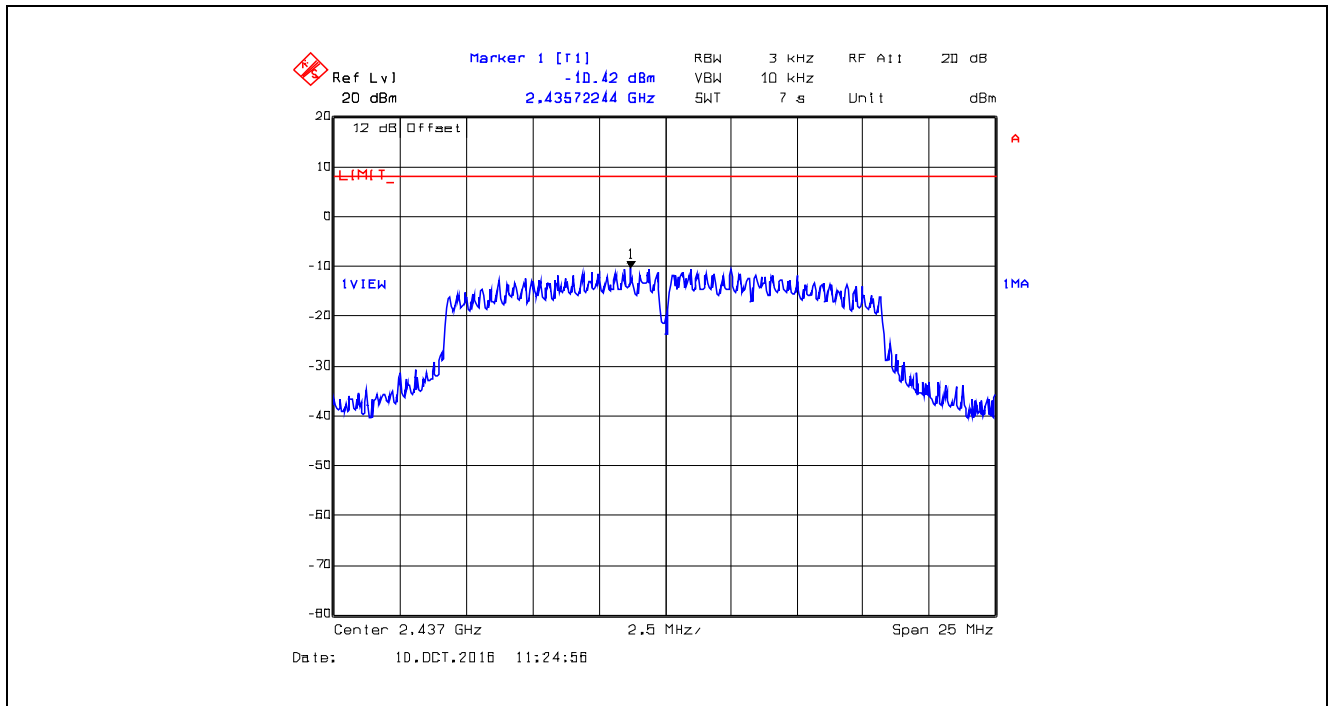

Plot 5.5.4.15. Power Spectral Density, 802.11g, QPSK, 12 Mbps, 2472 MHz, Power Setting 8

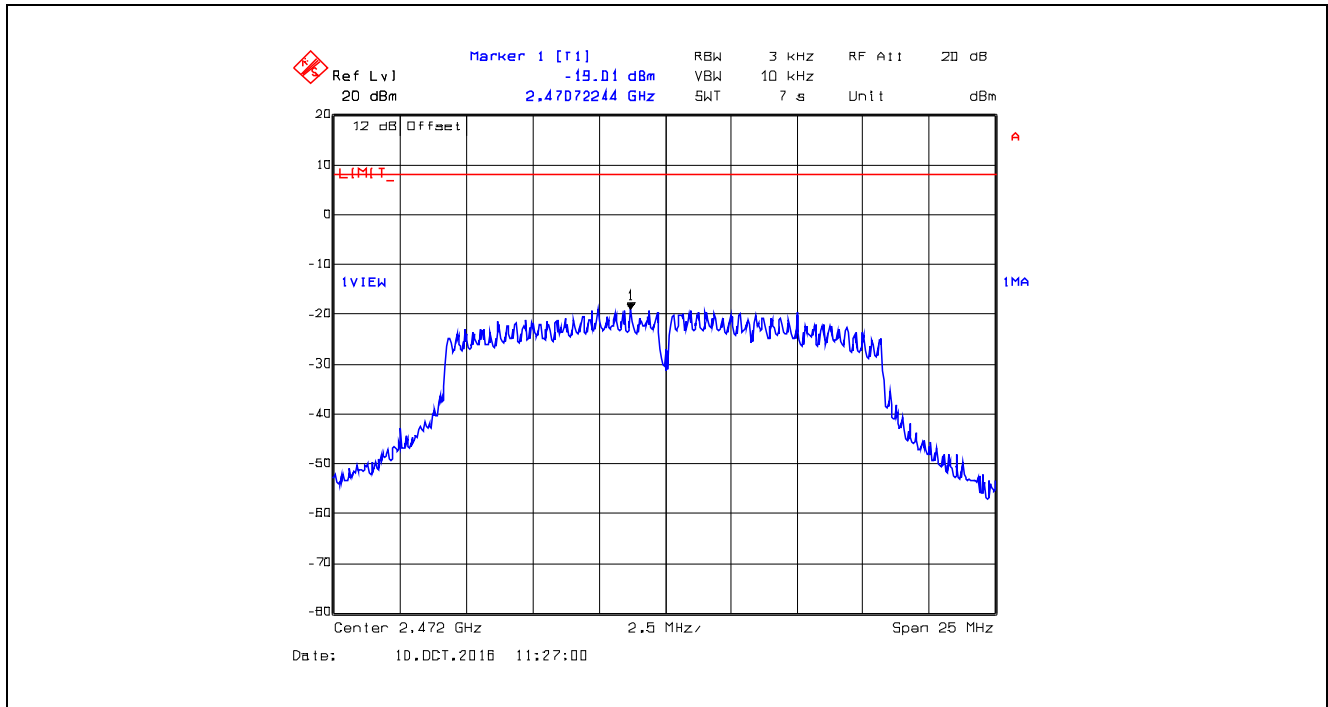

Plot 5.5.4.16. Power Spectral Density, 802.11g, 16-QAM, 24 Mbps, 2412 MHz, Power Setting 0

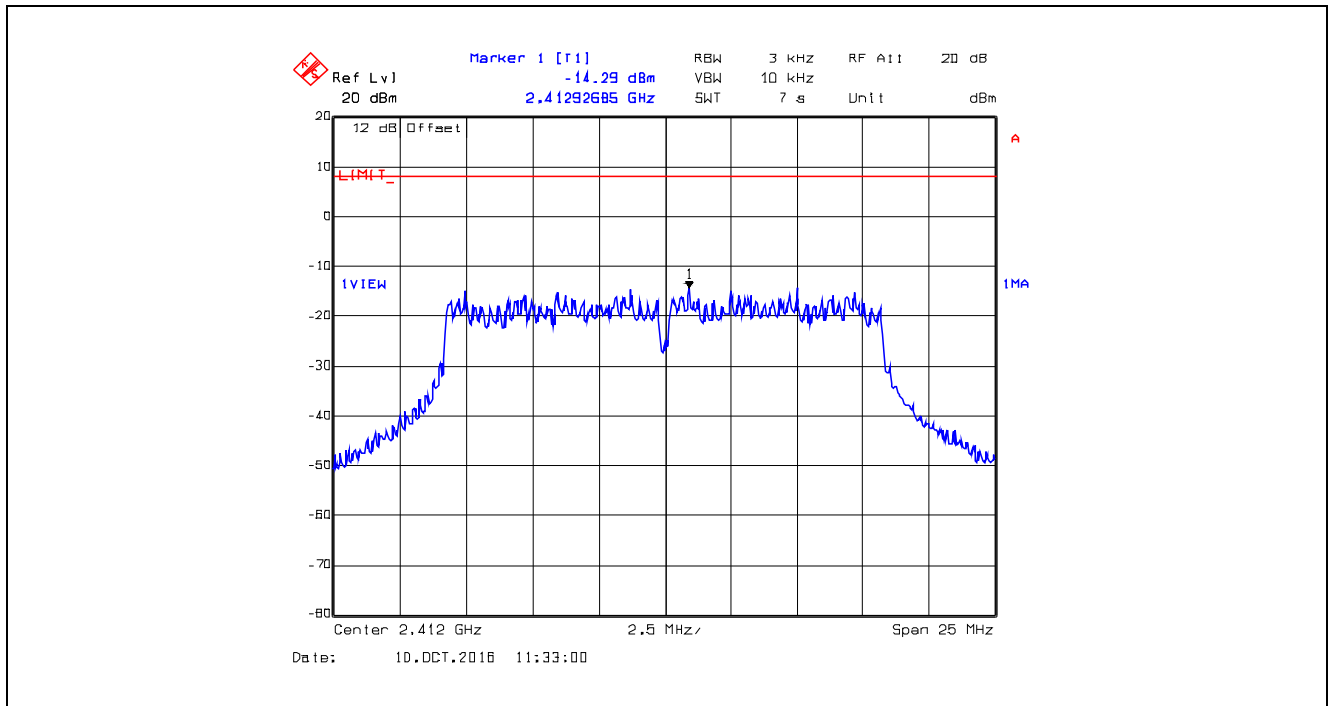

Plot 5.5.4.17. Power Spectral Density, 802.11g, 16-QAM 24 Mbps, 2437 MHz, Power Setting 0

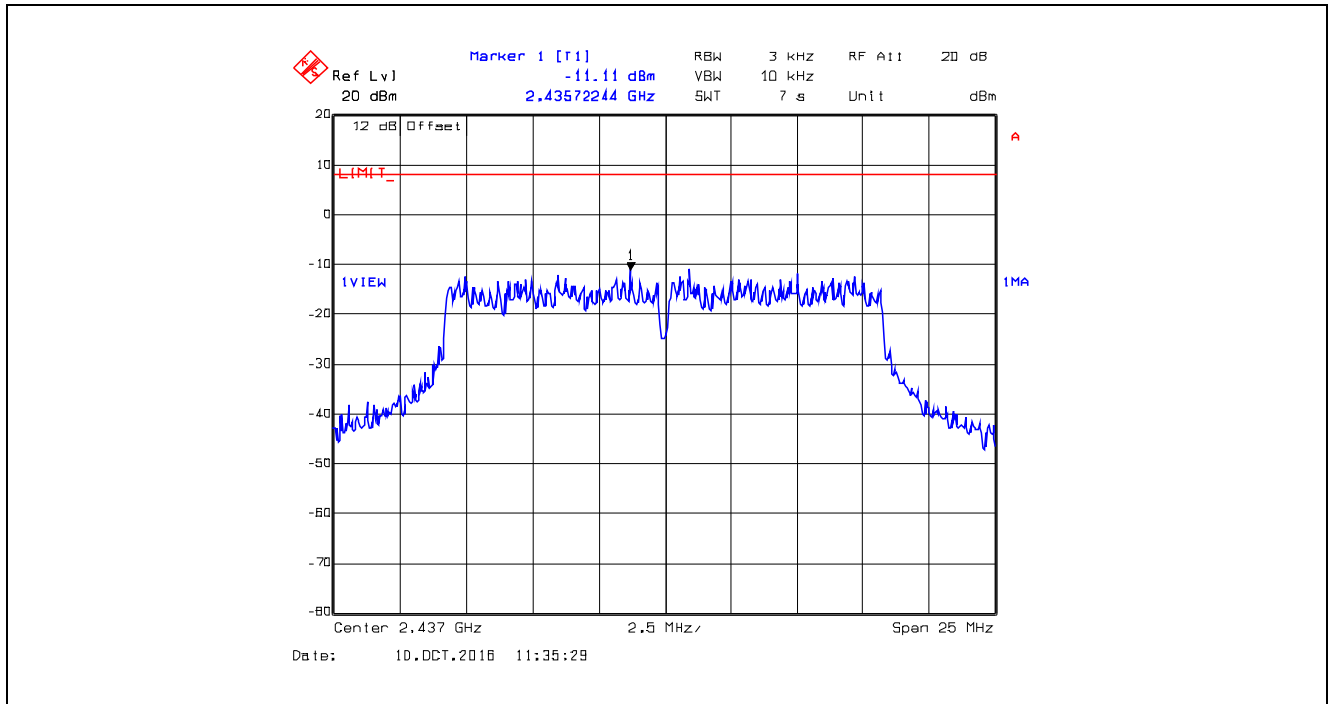

Plot 5.5.4.18. Power Spectral Density, 802.11g, 16-QAM 24 Mbps, 2472 MHz, Power Setting 8

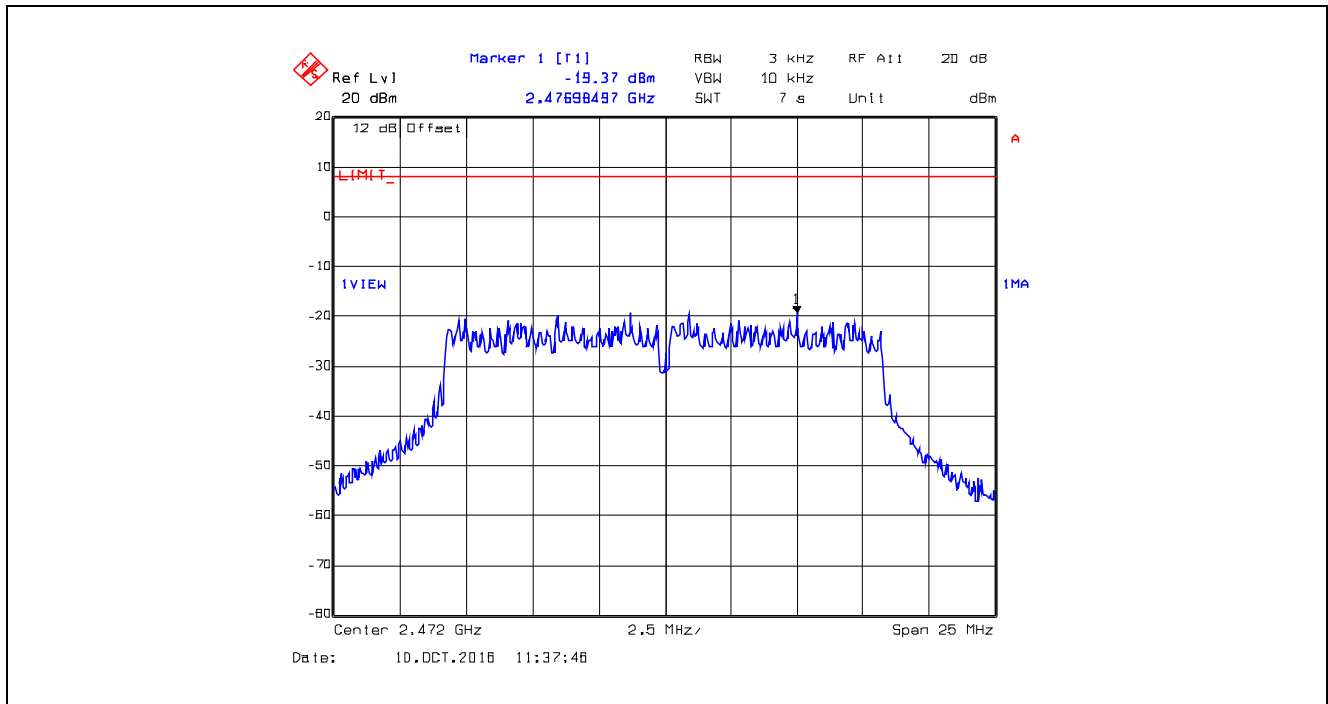

Plot 5.5.4.19. Power Spectral Density, 802.11g, 64-QAM, 48 Mbps, 2412 MHz, Power Setting 0

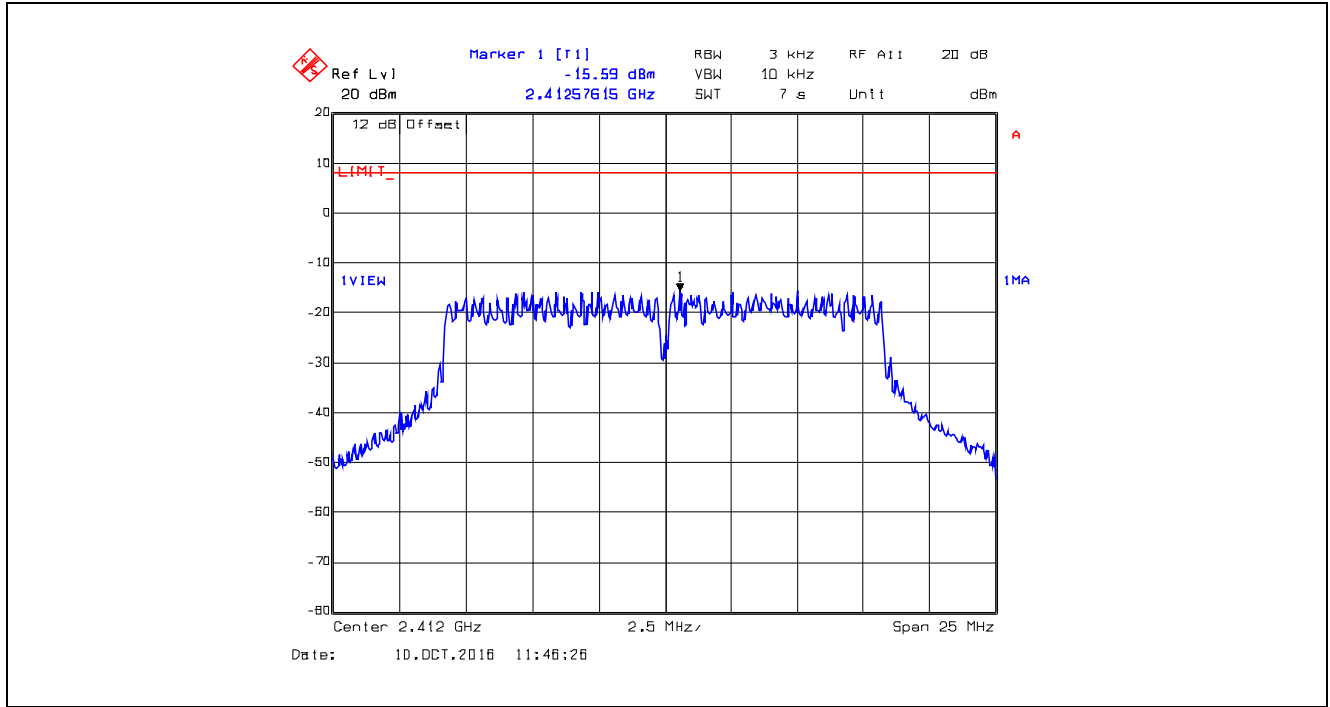

Plot 5.5.4.20. Power Spectral Density, 802.11g, 64-QAM 48 Mbps, 2437 MHz, Power Setting 0

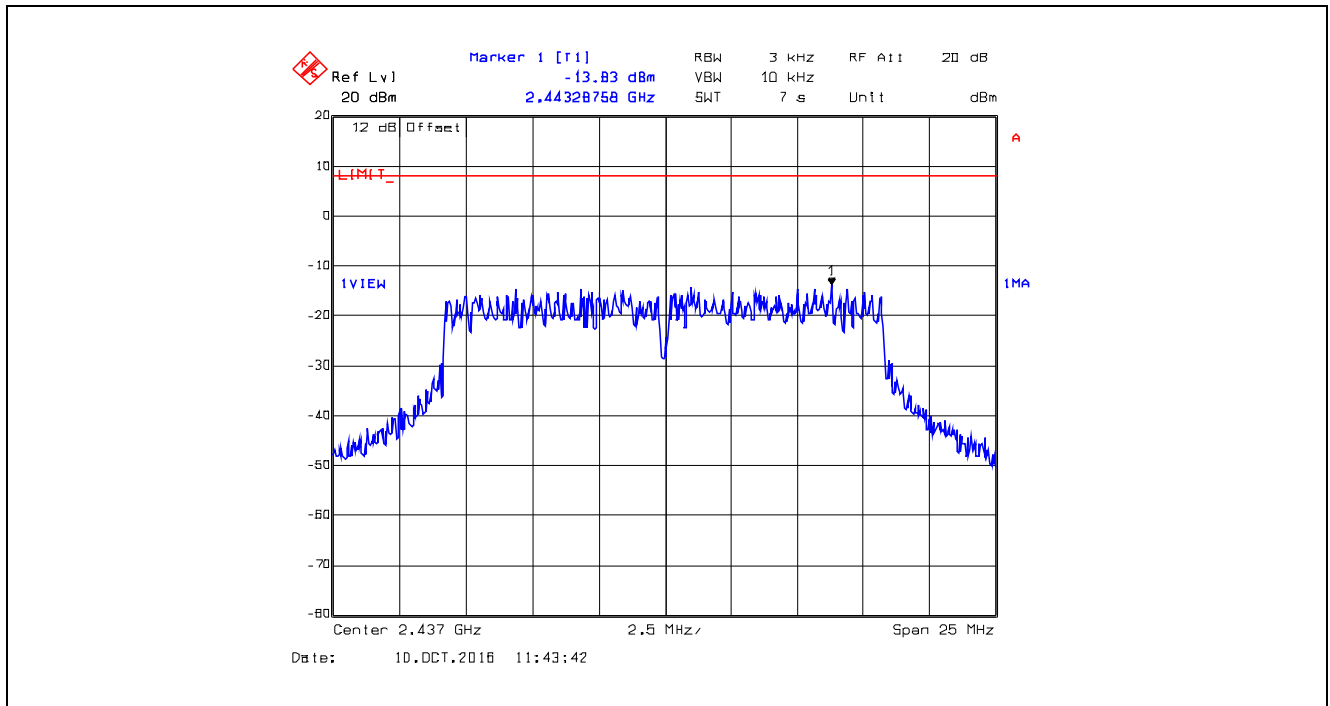

Plot 5.5.4.21. Power Spectral Density, 802.11g, 64-QAM, 48 Mbps, 2472 MHz, Power Setting 8

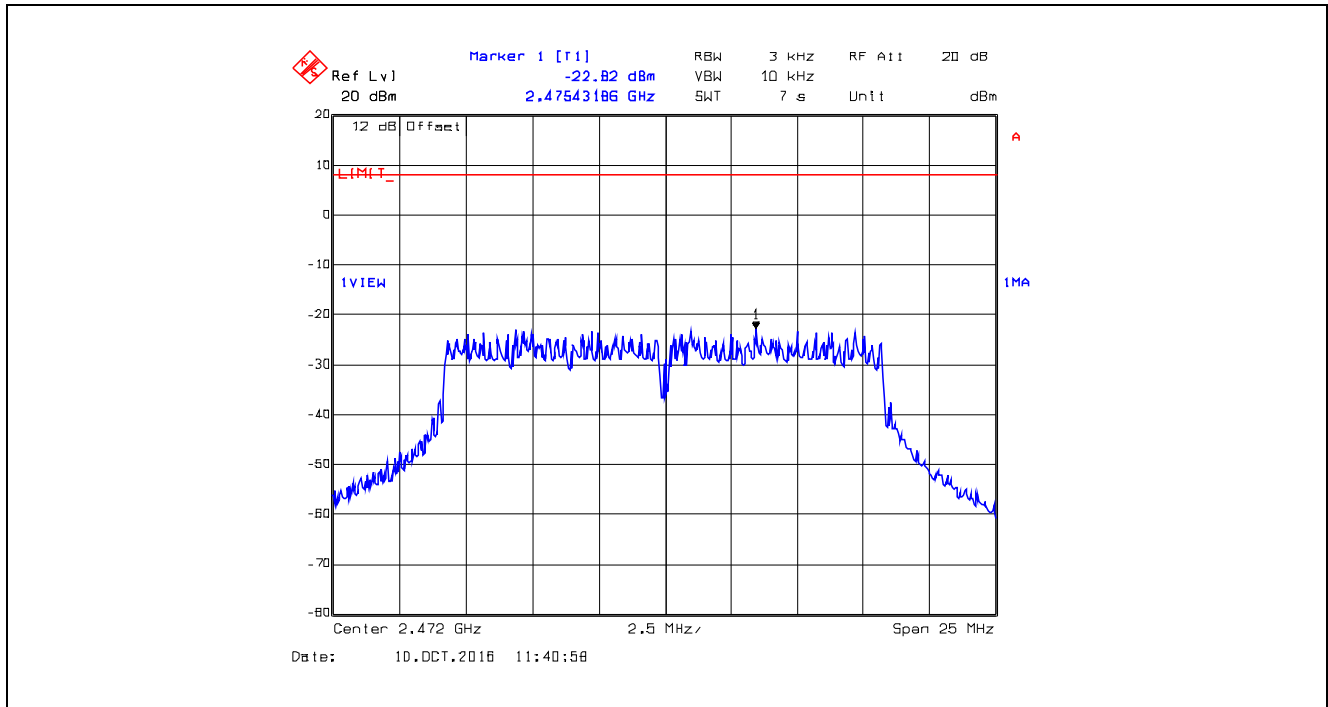

Plot 5.5.4.22. Power Spectral Density, 802.11n, BPSK 1/2 MCS 0, 6.5 Mbps, 2412 MHz, Power Setting 0

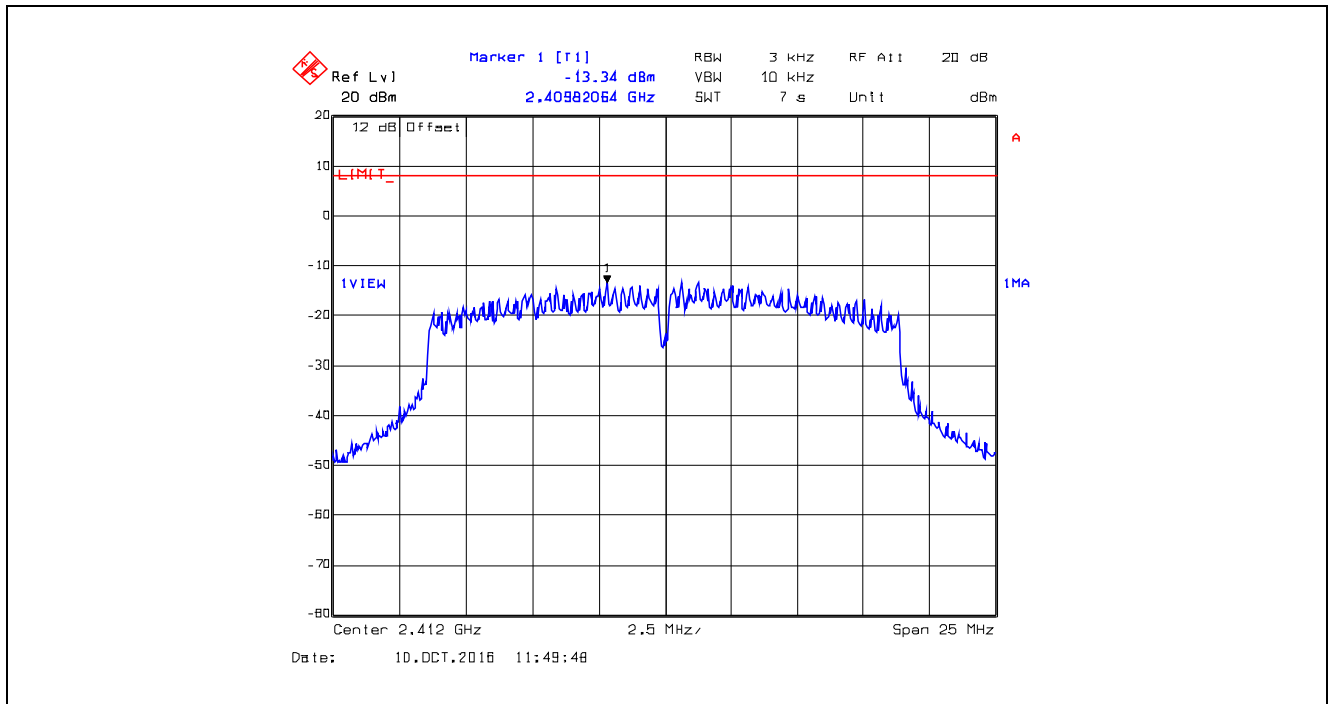

Plot 5.5.4.23. Power Spectral Density, 802.11n, BPSK 1/2 MCS 0, 6.5 Mbps, 2437 MHz, Power Setting 0

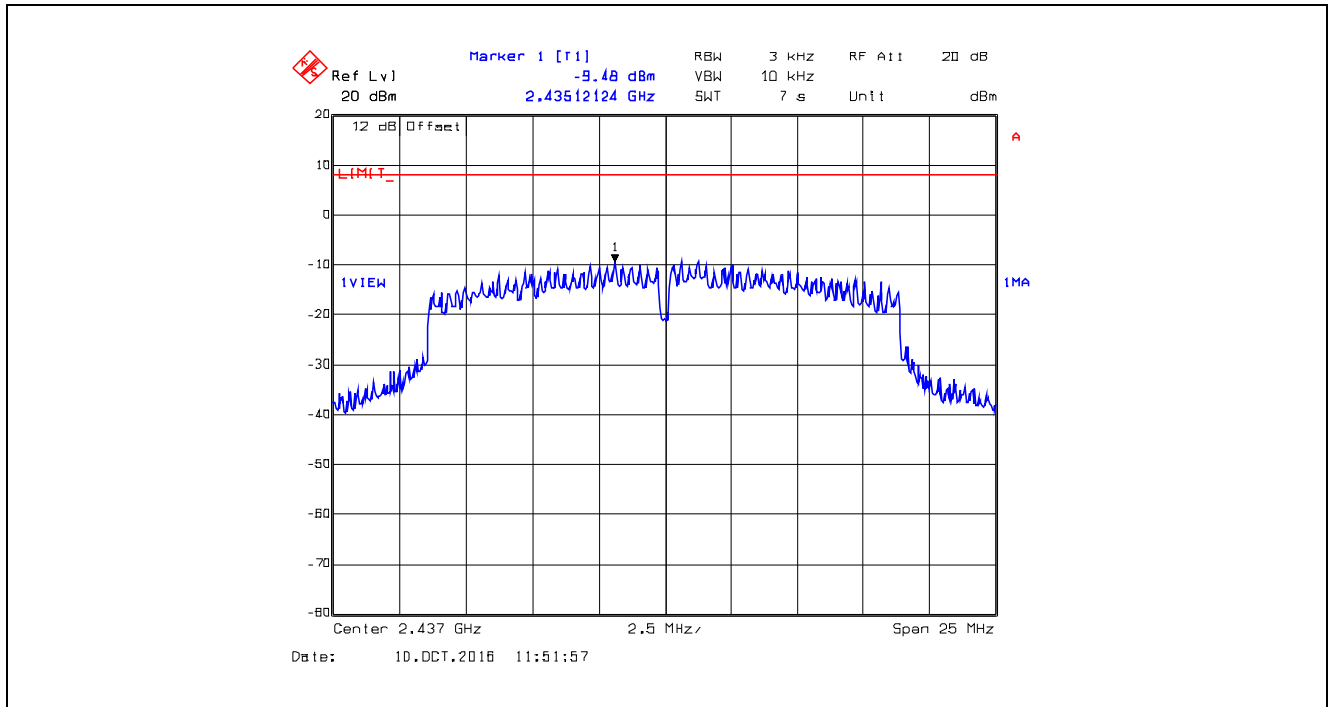

Plot 5.5.4.24. Power Spectral Density, 802.11n, BPSK 1/2 MCS 0, 6.5 Mbps, 2472 MHz, Power Setting 10

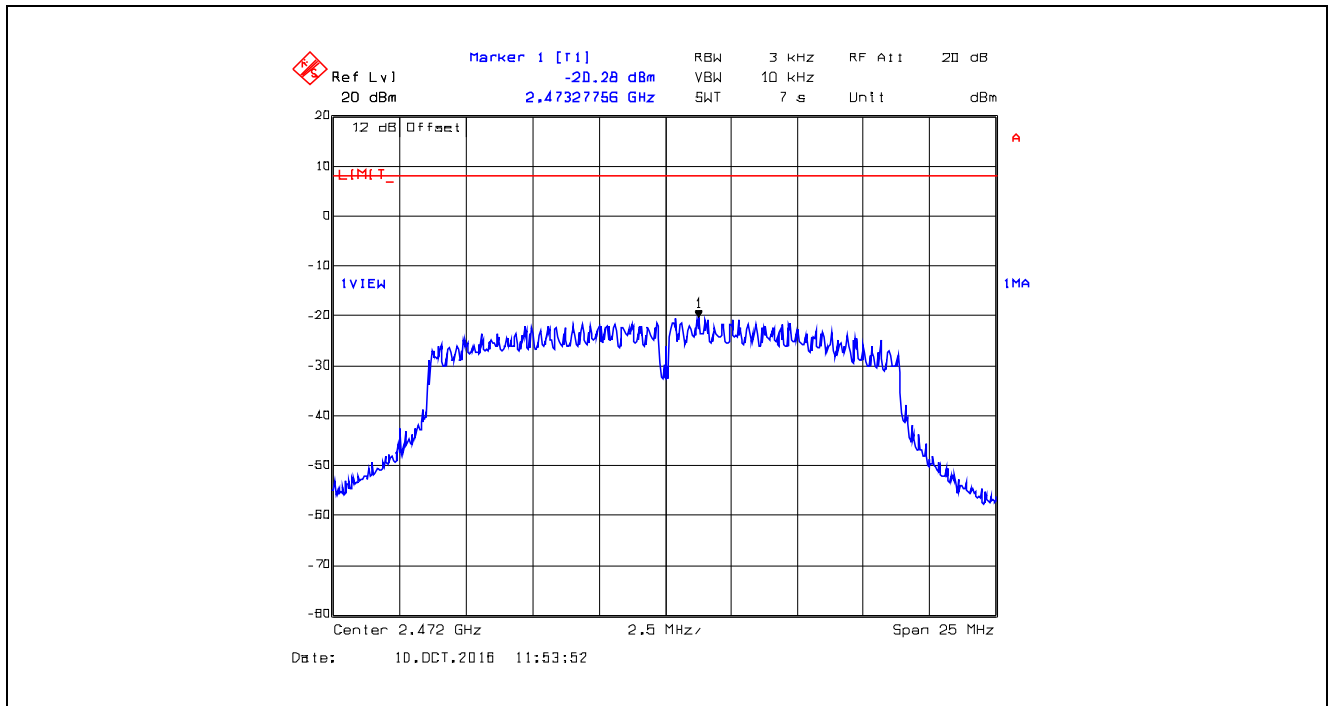

Plot 5.5.4.25. Power Spectral Density, 802.11n, QPSK 1/2 MCS 1, 13 Mbps, 2412 MHz, Power Setting 0

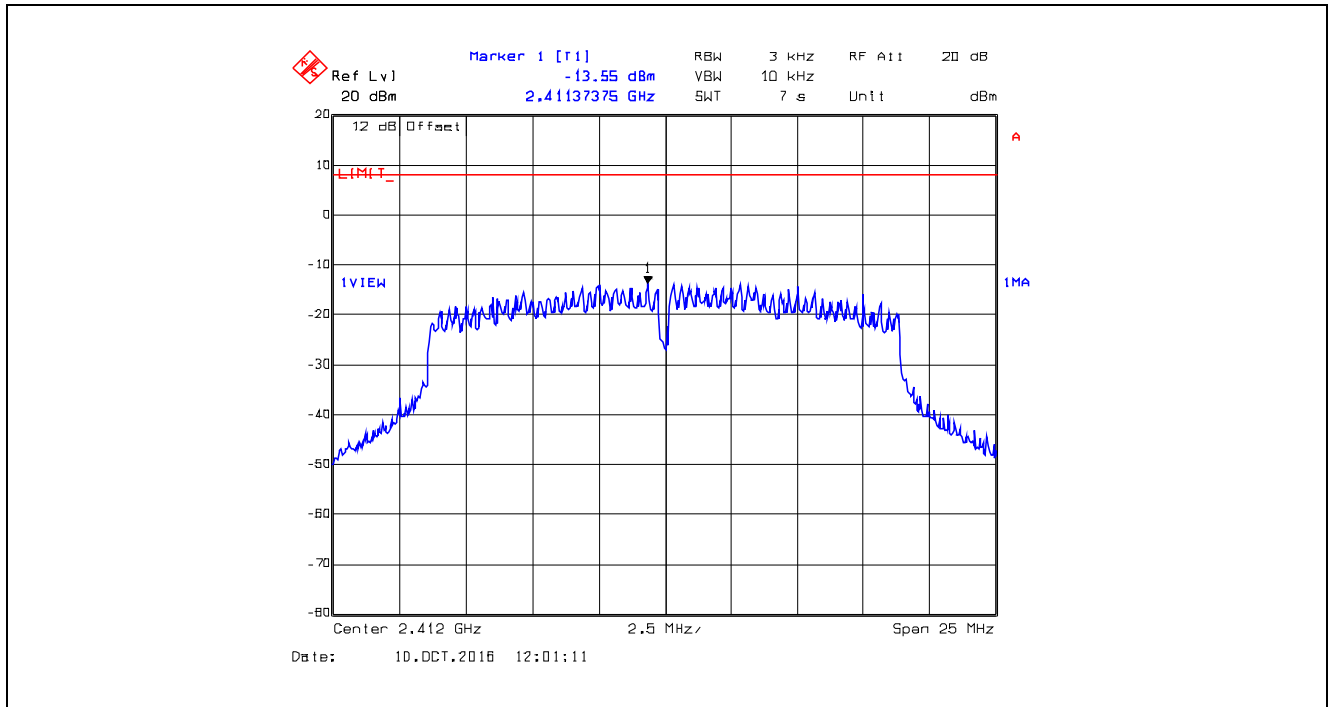

Plot 5.5.4.26. Power Spectral Density, 802.11n, QPSK 1/2 MCS 1, 13 Mbps, 2437 MHz, Power Setting 0

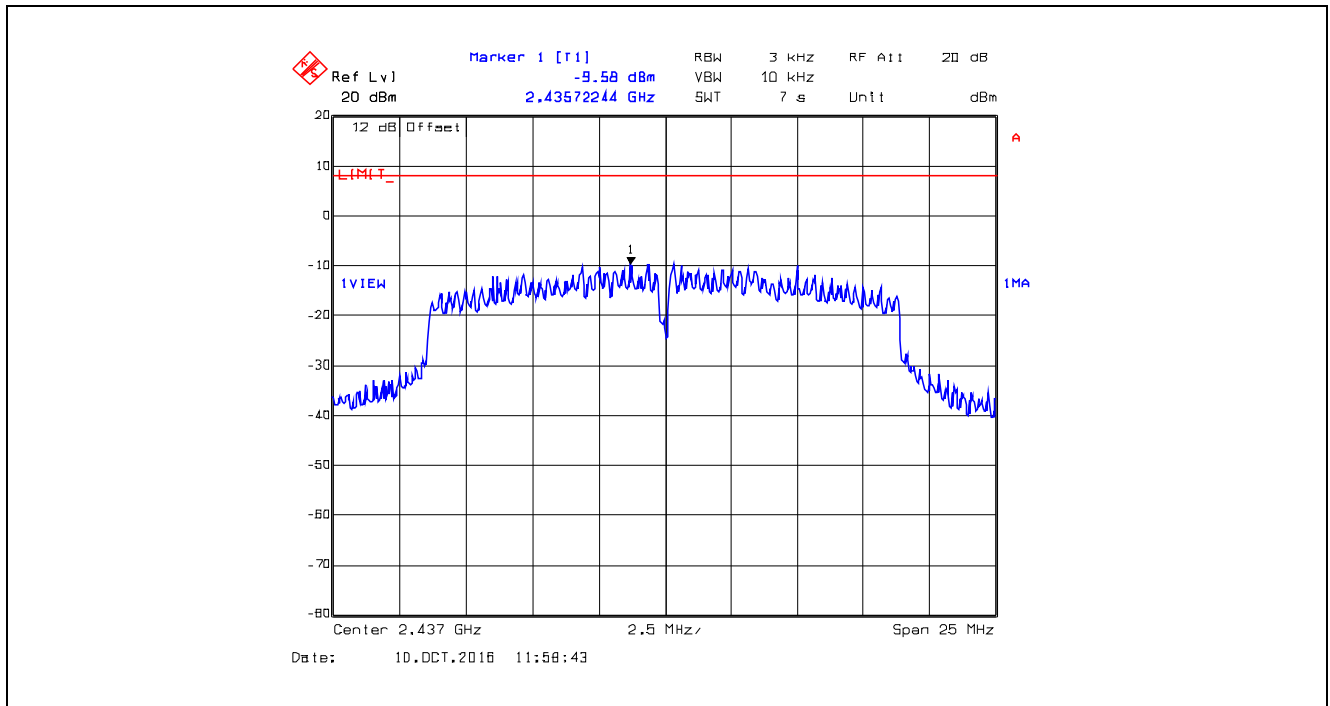

Plot 5.5.4.27. Power Spectral Density, 802.11n, QPSK 1/2 MCS 1, 13 Mbps, 2472 MHz, Power Setting 10

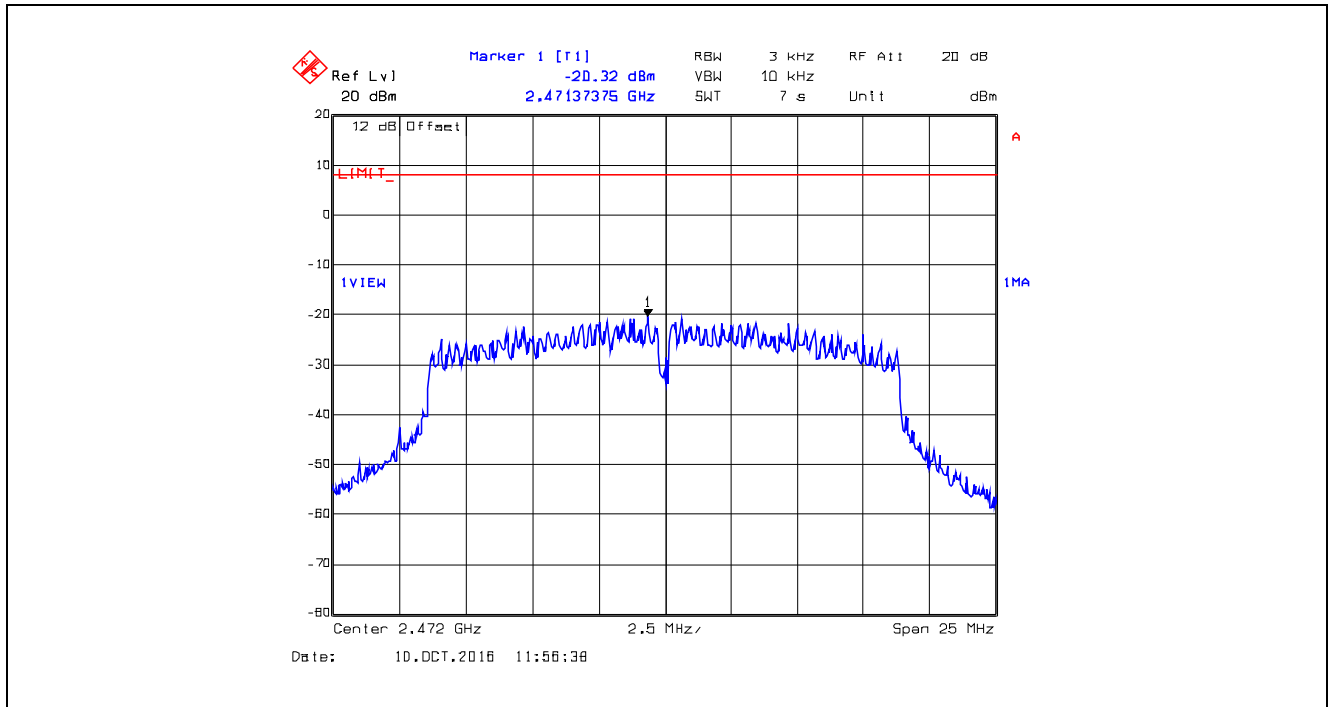

Plot 5.5.4.28. Power Spectral Density, 802.11n, 16-QAM 1/2 MCS 3, 26 Mbps, 2412 MHz, Power Setting 0

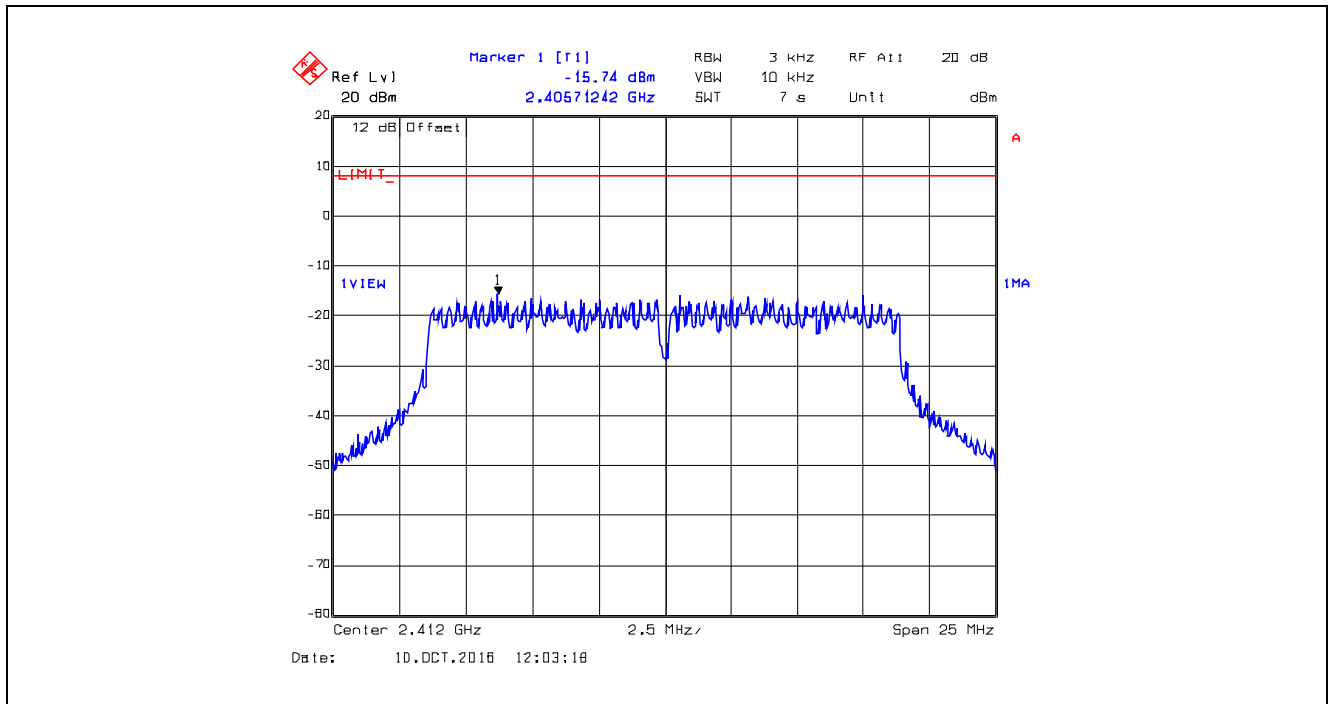

Plot 5.5.4.29. Power Spectral Density, 802.11n, 16-QAM 1/2 MCS 3, 26 Mbps, 2437 MHz, Power Setting 0

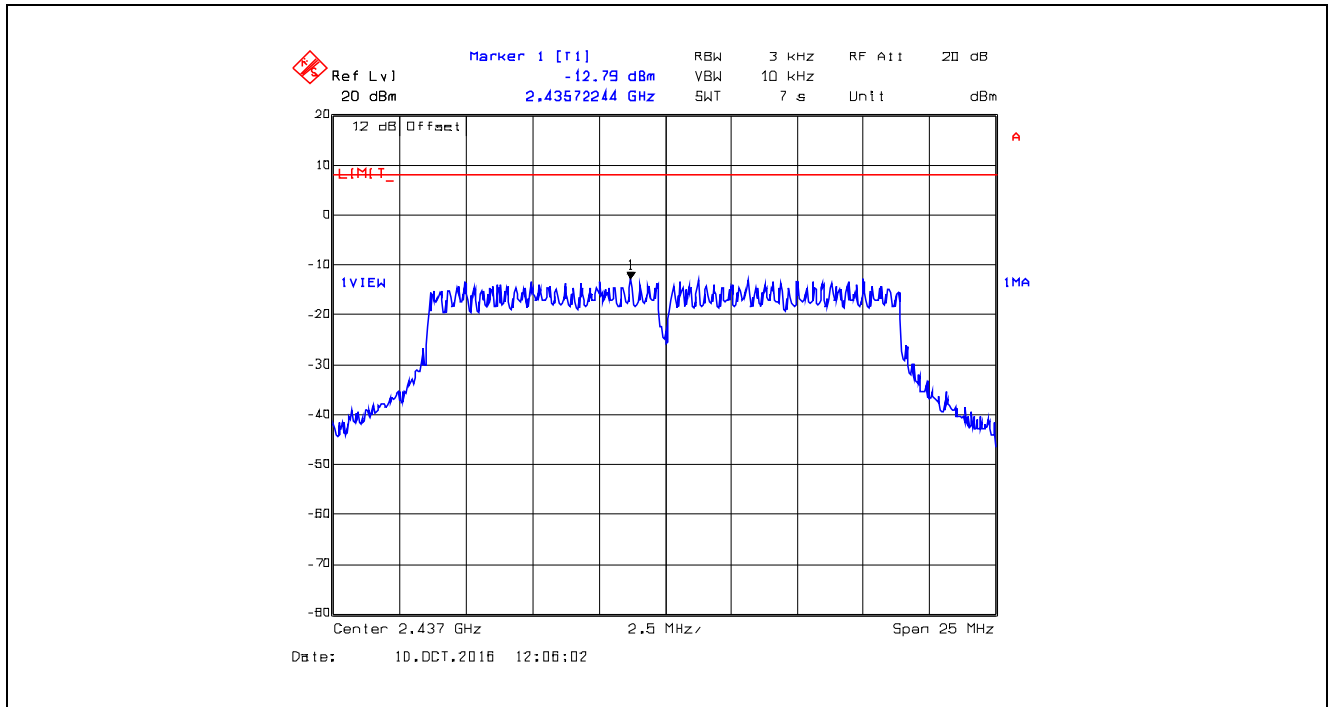

Plot 5.5.4.30. Power Spectral Density, 802.11n, 16-QAM 1/2 MCS 3, 26 Mbps, 2472 MHz, Power Setting 10

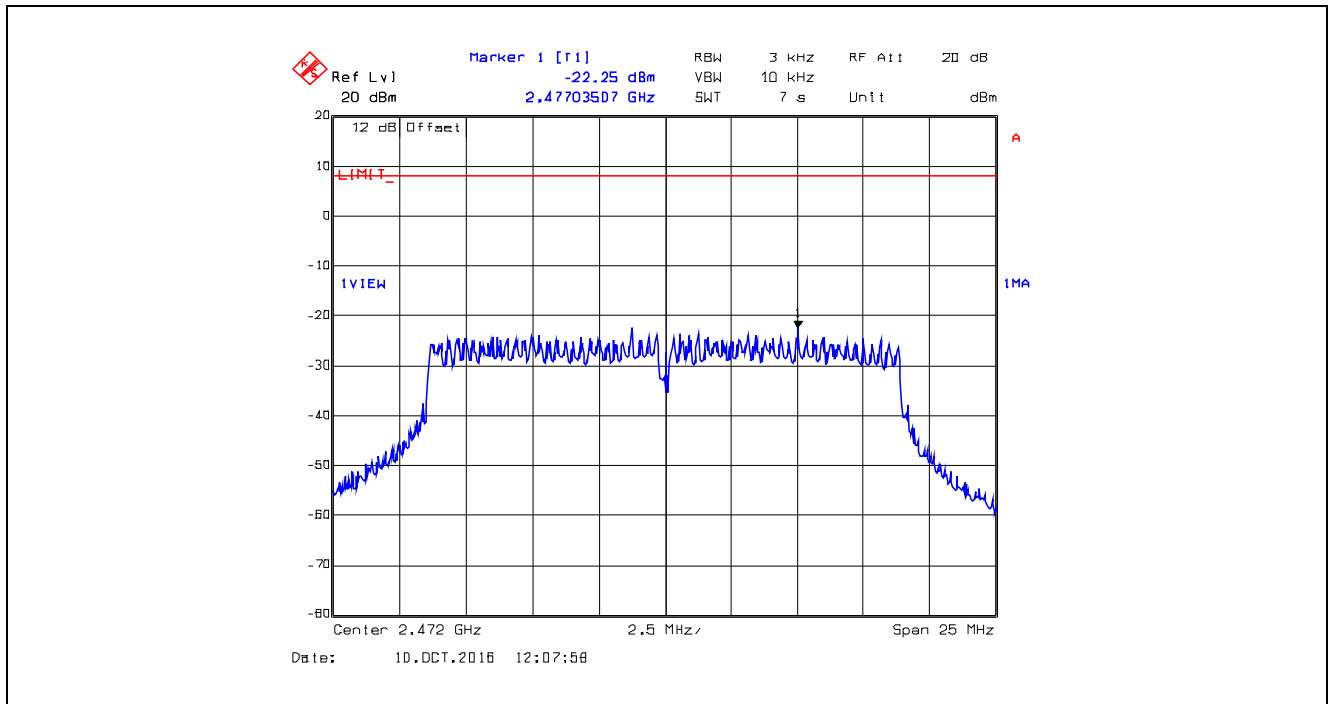

Plot 5.5.4.31. Power Spectral Density, 802.11n, 64-QAM 2/3 MCS 5, 52 Mbps, 2412 MHz, Power Setting 0

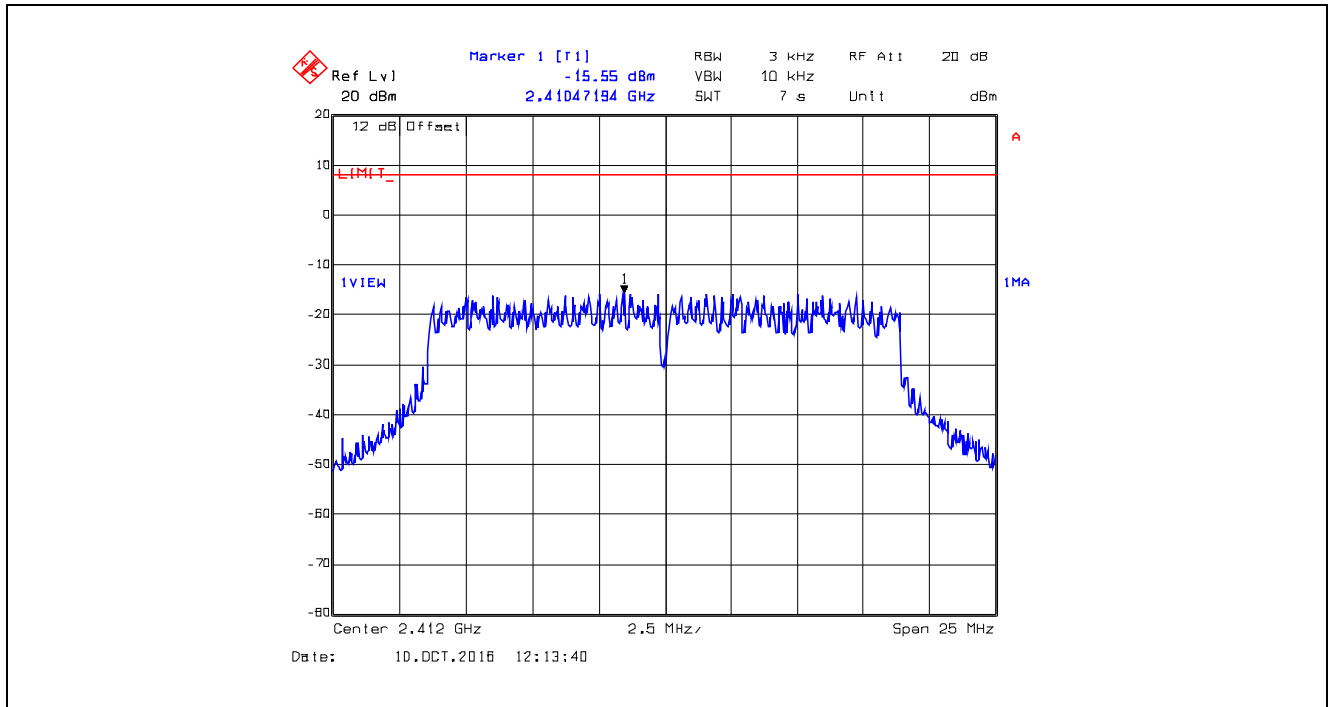

Plot 5.5.4.32. Power Spectral Density, 802.11n, 64-QAM 2/3 MCS 5, 52 Mbps, 2437 MHz, Power Setting 0

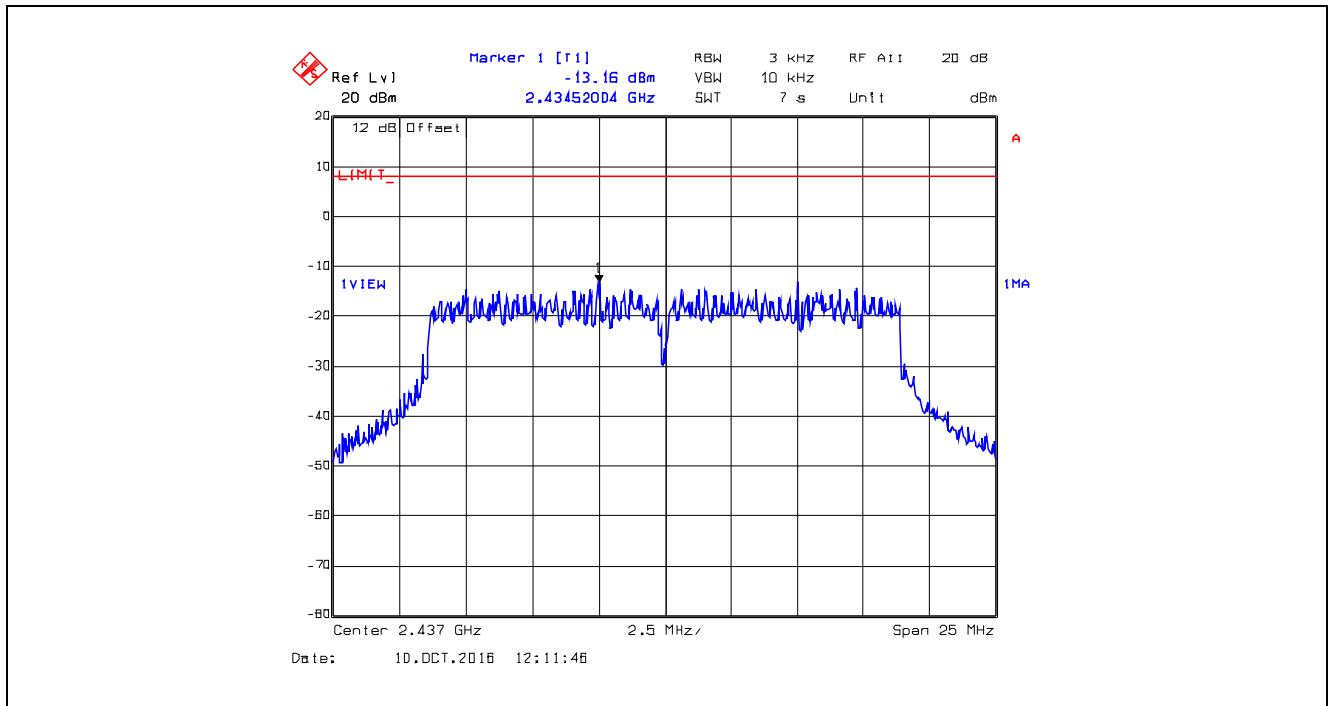

Plot 5.5.4.33. Power Spectral Density, 802.11n, 64-QAM 2/3 MCS 5, 52 Mbps, 2472 MHz, Power Setting 10

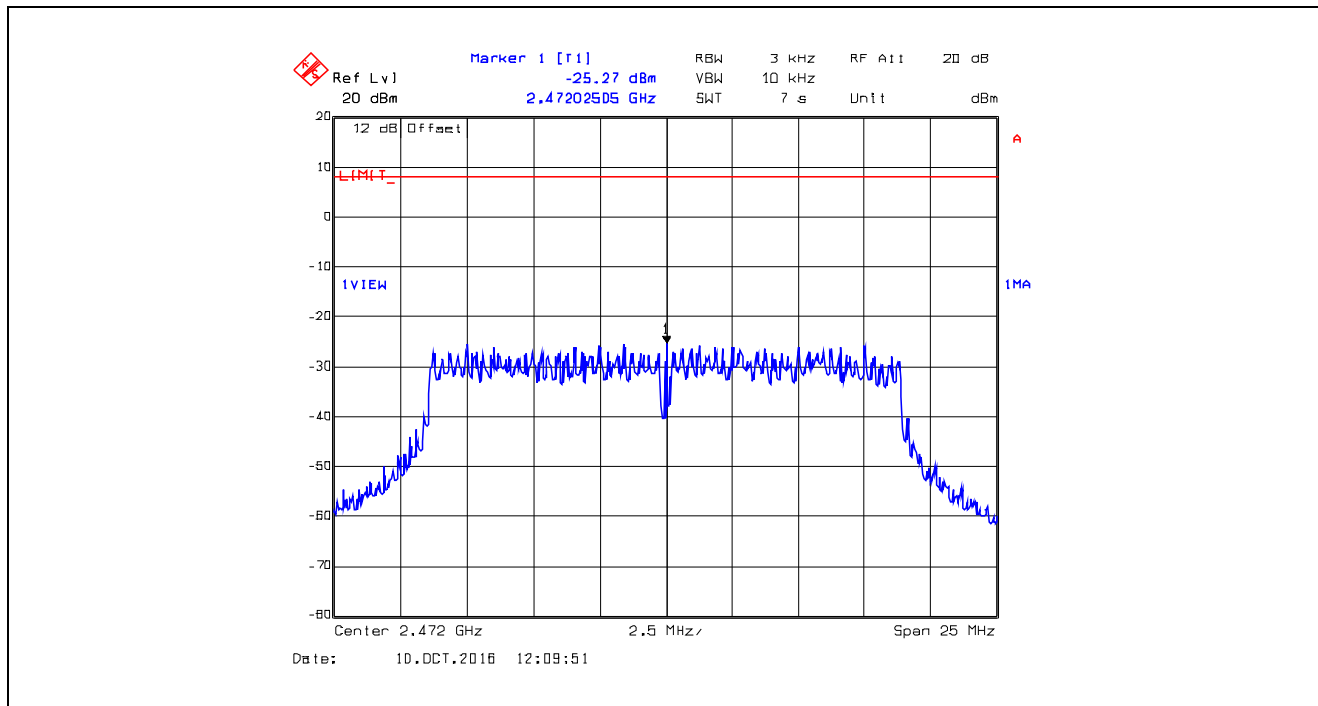

5.6. RF EXPOSURE REQUIRMENTS [§§ 15.247(i), 1.1310 & 2.1091]

5.6.1. Limits

§ 1.1310: The criteria listed in the following table shall be used to evaluate the environmental impact of human exposure to radio-frequency (RF) radiation as specified in 1.1307(b).

Limits for Maximum Permissible Exposure (MPE)

Frequency range (MHz)	Electric field strength (V/m)	Magnetic field strength (A/m)	Power density (mW/cm ²)	Averaging time (minutes)
(A) Limits for Occupational/Controlled Exposures				
0.3-3.0	614	1.63	*(100)	6
3.0-30	1842/f	4.89/f	*(900/f ²)	6
30-300	61.4	0.163	1.0	6
300-1500			f/300	6
1500-100,000			5	6
(B) Limits for General Population/Uncontrolled Exposure				
0.3-1.34	614	1.63	*(100)	30
1.34-30	824/f	2.19/f	*(180/f ²)	30
30-300	27.5	0.073	0.2	30
300-1500			f/1500	30
1500-100,000			1.0	30

f = frequency in MHz

* = Plane-wave equivalent power density

Note 1: Occupational/controlled limits apply in situations in which persons are exposed as a consequence of their employment provided those persons are fully aware of the potential for exposure and can exercise control over their exposure. Limits for occupational/controlled exposure also apply in situations when an individual is transient through a location where occupational/controlled limits apply provided he or she is made aware of the potential for exposure.

Note 2: General population/uncontrolled exposures apply in situations in which the general public may be exposed, or in which persons that are exposed as a consequence of their employment may not be fully aware of the potential for exposure or can not exercise control over their exposure.

5.6.2. Method of Measurements

Calculation Method of Power Density/RF Safety Distance:

$$S = \frac{PG}{4\pi \cdot r^2} = \frac{EIRP}{4\pi \cdot r^2}$$

Where, P: power input to the antenna in mW
EIRP: Equivalent (effective) isotropic radiated power.
S: power density mW/cm²
G: numeric gain of antenna relative to isotropic radiator
r: distance to centre of radiation in cm

5.6.3. RF Evaluation

Frequency (MHz)	EIRP (dBm)	EIRP (mW)	Evaluation Distance, r (cm)	Power Density, S (mW/cm ²)	MPE Limit (mW/cm ²)	Margin (mW/cm ²)
2412	22.28	169	20	0.034	1.0	-0.966

EXHIBIT 6. TEST EQUIPMENT LIST

Test Instruments	Manufacturer	Model No.	Serial No.	Frequency Range	Cal. Due Date
Spectrum Analyzer	Agilent	E7401A	US40240432	9 kHz–1.5 GHz	14 Apr 2017
Attenuator	Pasternack	PE7010-20	7	DC–2 GHz	26 Mar 2017
L.I.S.N	Schwarzbeck	NSLK8127	8127276	0.10 -30 MHz	24 Jun 2017
Spectrum Analyzer	Rohde & Schwarz	FSEK30	100077	20 Hz - 40 GHz	21 Nov 2016
DC Block	Hewlett Packard	11742A	12460	0.045 – 26.5 GHz	Cal on use
Attenuator	Pasternack	7024-10	4	DC–26.5 GHz	Cal on use
Peak Power Analyzer	Hewlett Packard	8991A	3342A00657	0.5 - 40 GHz	09 Aug 2017
Peak Power Sensor	Hewlett Packard	84814A	3205A00175	0.5 - 40 GHz	09 Aug 2017
EMI Receiver	Rohde & Schwarz	ESU40	100037	20Hz–40 GHz	08 May 2017
RF Amplifier	Com-Power	PAM-0118A	551016	0.5 – 18 GHz	17 Jul 2017
RF Amplifier	Hewlett Packard	84498	3008A00769	1 – 26.5 GHz	05 May 2017
Biconilog	EMCO	3142	9601-1005	26-1000 MHz	12 May 2017
Horn Antenna	EMCO	3155	5955	1 – 18 GHz	21 Apr 2017
Horn Antenna	EMCO	3160-09	118385	18 – 26.5 GHz	11 Oct 2018
High Pass Filter	K & L	11SH10-4000/T12000	4	Cut off 2400 MHz	Cal on use
Band Reject Filter	Micro-Tronics	BRM50701	105	Cut off 2.4-2.483 GHz	Cal on use
Spectrum Analyzer	Rohde & Schwarz	FSU26	200946	20Hz–26.5 GHz	21 Jul 2018
Attenuator	Pasternack	PE7024-10	3	DC–26.5 GHz	Cal on use

ULTRATECH GROUP OF LABS

3000 Bristol Circle, Oakville, Ontario, Canada L6H 6G4
 Tel. #: 905-829-1570, Fax. #: 905-829-8050, Email: vic@ultratech-labs.com, Website: <http://www.ultratech-labs.com>

File #: 16SWIF019_FCC15C247DTS
 November 16, 2016

All test results contained in this engineering test report are traceable to National Institute of Standards and Technology (NIST)

EXHIBIT 7. MEASUREMENT UNCERTAINTY

The measurement uncertainties stated were calculated in accordance with the requirements of CISPR 16-4-2 @ IEC:2003 and JCGM 100:2008 (GUM 1995) – Guide to the Expression of Uncertainty in Measurement.

7.1. LINE CONDUCTED EMISSION MEASUREMENT UNCERTAINTY

	Line Conducted Emission Measurement Uncertainty (9 kHz – 30 MHz):	Measured	Limit
u_c	Combined standard uncertainty: $u_c(y) = \sqrt{\sum_{i=1}^m u_i^2(y)}$	± 1.44	± 1.8
U	Expanded uncertainty U: $U = 2u_c(y)$	± 2.89	± 3.6

7.2. RADIATED EMISSION MEASUREMENT UNCERTAINTY

	Radiated Emission Measurement Uncertainty @ 3m, Horizontal (30-1000 MHz):	Measured (dB)	Limit (dB)
u_c	Combined standard uncertainty: $u_c(y) = \sqrt{\sum_{i=1}^m u_i^2(y)}$	± 2.39	± 2.6
U	Expanded uncertainty U: $U = 2u_c(y)$	± 4.79	± 5.2

	Radiated Emission Measurement Uncertainty @ 3m, Vertical (30-1000 MHz):	Measured (dB)	Limit (dB)
u_c	Combined standard uncertainty: $u_c(y) = \sqrt{\sum_{i=1}^m u_i^2(y)}$	± 2.39	± 2.6
U	Expanded uncertainty U: $U = 2u_c(y)$	± 4.78	± 5.2

	Radiated Emission Measurement Uncertainty @ 3 m, Horizontal & Vertical (1 – 18 GHz):	Measured (dB)	Limit (dB)
u_c	Combined standard uncertainty: $u_c(y) = \sqrt{\sum_{i=1}^m u_i^2(y)}$	± 1.87	Under consideration
U	Expanded uncertainty U: $U = 2u_c(y)$	± 3.75	Under consideration