

## TEST REPORT

Test report no.: 1-5045/17-01-05



BNetzA-CAB-02/21-102

### Testing laboratory

**CTC advanced GmbH**

Untertuerkheimer Strasse 6 – 10  
66117 Saarbruecken / Germany  
Phone: + 49 681 5 98 - 0  
Fax: + 49 681 5 98 - 9075  
Internet: <http://www.ctcadvanced.com>  
e-mail: [mail@ctcadvanced.com](mailto:mail@ctcadvanced.com)

**Accredited Testing Laboratory:**

The testing laboratory (area of testing) is accredited according to DIN EN ISO/IEC 17025 (2005) by the Deutsche Akkreditierungsstelle GmbH (DAkkS). The accreditation is valid for the scope of testing procedures as stated in the accreditation certificate with the registration number: D-PL-12076-01-03

### Applicant

**Continental Automotive GmbH**

Heinrich-Hertz-Str. 45  
78052 Villingen-Schwenningen / GERMANY  
Phone: +49 7721 94 72-0  
Fax: +49 772 167-792802  
Contact: Marion Grüner  
e-mail: [Marion.Gruener@continental-corporation.com](mailto:Marion.Gruener@continental-corporation.com)  
Phone: +49 772 167-2802

### Manufacturer

**Continental Automotiva Guadalajara Mexico, S.A. de C.V.**  
Periferico Sur #7999-D. Santa Maria Tequepexpan  
45601 Jalisco, Tlaquepaque / MEXICO

### Test standard/s

47 CFR Part 15 Title 47 of the Code of Federal Regulations; Chapter I; Part 15 - Radio frequency devices

RSS - 247 Issue 2 Digital Transmission Systems (DTSs), Frequency Hopping Systems (FHSs) and Licence - Exempt Local Area Network (LE-LAN) Devices

RSS - Gen Issue 4 Spectrum Management and Telecommunications Radio Standards Specifications - General Requirements and Information for the Certification of Radio Apparatus

For further applied test standards please refer to section 3 of this test report.

### Test Item

**Kind of test item:** Display Controller Subsystem  
**Model name:** Multiview Media Display  
**FCC ID:** 2AJW5MVMDISPLAY  
**IC:** 21979-MVMDISPLAY  
**Frequency:** DTS band 2400 MHz to 2483.5 MHz  
**Technology tested:** Bluetooth® LE  
**Antenna:** Integrated antenna  
**Power supply:** 12.0 V DC by external power supply  
**Temperature:** +22°C



This test report is electronically signed and valid without handwritten signature. For verification of the electronic signatures, the public keys can be requested at the testing laboratory.

### Test report authorized:

p.o.

Andreas Luckenbill  
Lab Manager  
Radio Communications & EMC

### Test performed:

Mihail Dorongovskij  
Lab Manager  
Radio Communications & EMC

## 1 Table of contents

1	Table of contents.....	2
2	General information .....	3
2.1	Notes and disclaimer .....	3
2.2	Application details .....	3
2.3	Test laboratories sub-contracted .....	3
3	Test standard/s and references.....	4
4	Test environment .....	5
5	Test item .....	5
5.1	General description.....	5
5.2	Additional information .....	5
6	Description of the test setup .....	6
6.1	Shielded semi anechoic chamber .....	7
6.2	Shielded fully anechoic chamber .....	8
6.3	Radiated measurements > 18 GHz .....	9
6.4	Conducted measurements Bluetooth system .....	10
7	Sequence of testing .....	11
7.1	Sequence of testing radiated spurious 9 kHz to 30 MHz .....	11
7.2	Sequence of testing radiated spurious 30 MHz to 1 GHz .....	12
7.3	Sequence of testing radiated spurious 1 GHz to 18 GHz .....	13
7.4	Sequence of testing radiated spurious above 18 GHz .....	14
8	Measurement uncertainty.....	15
9	Summary of measurement results .....	16
10	Additional comments.....	17
11	Measurement results .....	18
11.1	Antenna gain.....	18
11.2	Maximum conducted output power .....	19
11.3	Band edge compliance radiated .....	23
11.4	Spurious emissions radiated below 30 MHz .....	25
11.5	Spurious emissions radiated 30 MHz to 1 GHz .....	28
11.6	Spurious emissions radiated above 1 GHz .....	33
12	Observations .....	39
Annex A	Glossary .....	40
Annex B	Document history .....	41
Annex C	Accreditation Certificate .....	41

## 2 General information

### 2.1 Notes and disclaimer

The test results of this test report relate exclusively to the test item specified in this test report. CTC advanced GmbH does not assume responsibility for any conclusions and generalizations drawn from the test results with regard to other specimens or samples of the type of the equipment represented by the test item.

The test report may only be reproduced or published in full. Reproduction or publication of extracts from the report requires the prior written approval of CTC advanced GmbH.

The testing service provided by CTC advanced GmbH has been rendered under the current "General Terms and Conditions for CTC advanced GmbH".

CTC advanced GmbH will not be liable for any loss or damage resulting from false, inaccurate, inappropriate or incomplete product information provided by the customer.

Under no circumstances does the CTC advanced GmbH test report include any endorsement or warranty regarding the functionality, quality or performance of any other product or service provided.

Under no circumstances does the CTC advanced GmbH test report include or imply any product or service warranties from CTC advanced GmbH, including, without limitation, any implied warranties of merchantability, fitness for purpose, or non-infringement, all of which are expressly disclaimed by CTC advanced GmbH.

All rights and remedies regarding vendor's products and services for which CTC advanced GmbH has prepared this test report shall be provided by the party offering such products or services and not by CTC advanced GmbH. In no case this test report can be considered as a Letter of Approval.

This test report is electronically signed and valid without handwritten signature. For verification of the electronic signatures, the public keys can be requested at the testing laboratory.

### 2.2 Application details

Date of receipt of order:	2018-03-06
Date of receipt of test item:	2018-03-06
Start of test:	2018-03-07
End of test:	2018-04-04
Person(s) present during the test:	Mr. Tom Gollasch

### 2.3 Test laboratories sub-contracted

None

### 3 Test standard/s and references

Test standard	Date	Description
47 CFR Part 15	-/-	Title 47 of the Code of Federal Regulations; Chapter I; Part 15 - Radio frequency devices
RSS - 247 Issue 2	February 2017	Digital Transmission Systems (DTSs), Frequency Hopping Systems (FHSs) and Licence - Exempt Local Area Network (LE-LAN) Devices
RSS - Gen Issue 4	November 2014	Spectrum Management and Telecommunications Radio Standards Specifications - General Requirements and Information for the Certification of Radio Apparatus

Guidance	Version	Description
DTS: KDB 558074 D01	v04	Guidance for Performing Compliance Measurements on Digital Transmission Systems (DTS) Operating Under §15.247
ANSI C63.4-2014	-/-	American national standard for methods of measurement of radio-noise emissions from low-voltage electrical and electronic equipment in the range of 9 kHz to 40 GHz
ANSI C63.10-2013	-/-	American national standard of procedures for compliance testing of unlicensed wireless devices

## 4 Test environment

Temperature	:	T <sub>nom</sub> T <sub>max</sub> T <sub>min</sub>	+22 °C during room temperature tests No tests under extreme temperature conditions required. No tests under extreme temperature conditions required.
Relative humidity content	:		35 %
Barometric pressure	:		1002 hpa
Power supply	:	V <sub>nom</sub> V <sub>max</sub> V <sub>min</sub>	12.0 V DC by external power supply No tests under extreme voltage conditions required. No tests under extreme voltage conditions required.

## 5 Test item

### 5.1 General description

Kind of test item	:	Display Controller Subsystem	
Type identification	:	Multiview Media Display	
HMN	:	-/-	
PMN	:	Multiview Media	
HVIN	:	A2C100372	
FVIN	:	-/-	
S/N serial number	:	Radiated units:	BCT-7276512-18113015
		Conducted unit:	mac 00:05:C9:00:0E:AC
HW hardware status	:	TBD	
SW software status	:	RF test software	
Frequency band	:	DTS band 2400 MHz to 2483.5 MHz	
Type of radio transmission	:	DSSS	
Use of frequency spectrum	:		
Type of modulation	:	GFSK	
Number of channels	:	40	
Antenna	:	Integrated antenna	
Power supply	:	12.0 V DC by external power supply	
Temperature	:	+22°C	

### 5.2 Additional information

The content of the following annexes is defined in the QA. It may be that not all of the listed annexes are necessary for this report, thus some values in between may be missing.

Test setup- and EUT-photos are included in test report:

- 1-5045/17-01-01\_AnnexA
- 1-5045/17-01-01\_AnnexB
- 1-5045/17-01-01\_AnnexD

## 6 Description of the test setup

Typically, the calibrations of the test apparatus are commissioned to and performed by an accredited calibration laboratory. The calibration intervals are determined in accordance with the DIN EN ISO/IEC 17025. In addition to the external calibrations, the laboratory executes comparison measurements with other calibrated test systems or effective verifications. Weekly chamber inspections and range calibrations are performed. Where possible, RF generating and signaling equipment as well as measuring receivers and analyzers are connected to an external high-precision 10 MHz reference (GPS-based or rubidium frequency standard).

In order to simplify the identification of the equipment used at some special tests, some items of test equipment and ancillaries can be provided with an identifier or number in the equipment list below (Lab/Item).

### **Agenda:** Kind of Calibration

k	calibration / calibrated	EK	limited calibration
ne	not required (k, ev, izw, zw not required)	zw	cyclical maintenance (external cyclical maintenance)
ev	periodic self verification	izw	internal cyclical maintenance
Ve	long-term stability recognized	g	blocked for accredited testing
vkl!	Attention: extended calibration interval		
NK!	Attention: not calibrated	*)	next calibration ordered / currently in progress

## 6.1 Shielded semi anechoic chamber

The radiated measurements are performed in vertical and horizontal plane in the frequency range from 30 MHz to 1 GHz in semi-anechoic chambers. The EUT is positioned on a non-conductive support with a height of 0.80 m above a conductive ground plane that covers the whole chamber. The receiving antennas are conform to specifications ANSI C63. These antennas can be moved over the height range between 1.0 m and 4.0 m in order to search for maximum field strength emitted from EUT. The measurement distances between EUT and receiving antennas are indicated in the test setups for the various frequency ranges. For each measurement, the EUT is rotated in all three axes until the maximum field strength is received. The wanted and unwanted emissions are received by spectrum analyzers where the detector modes and resolution bandwidths over various frequency ranges are set according to requirement ANSI C63.

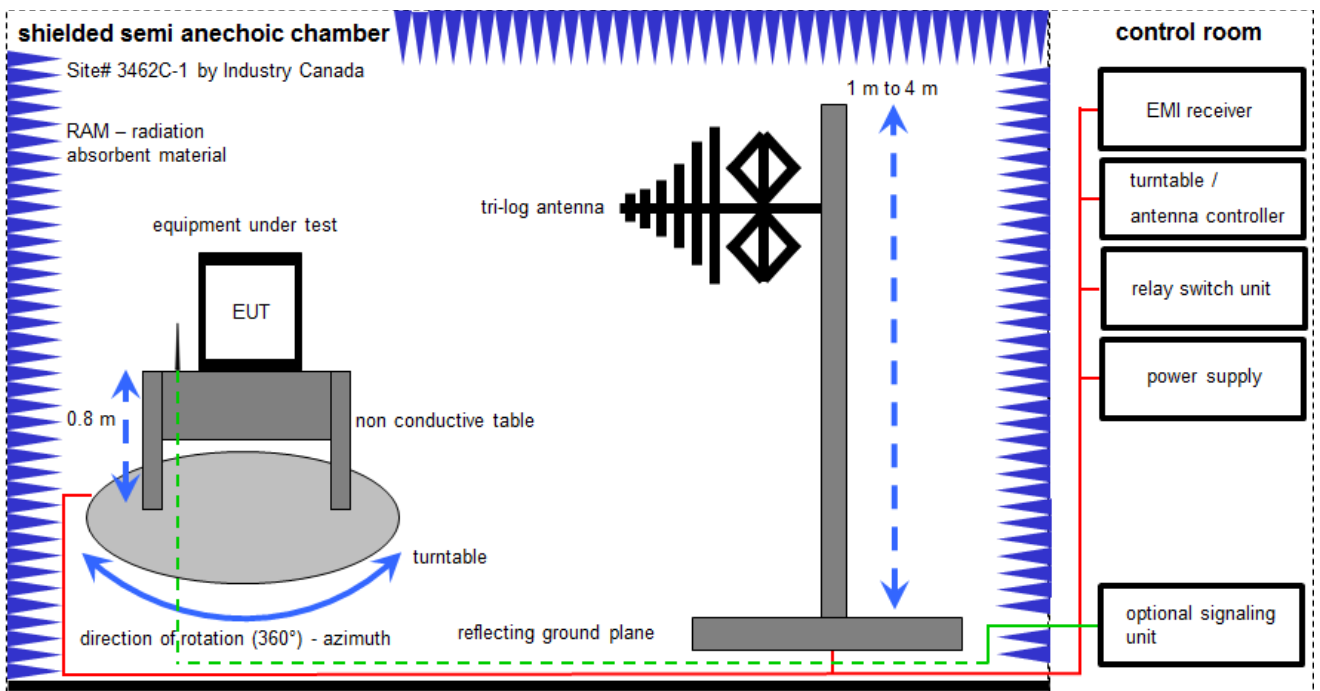

Measurement distance: tri-log antenna 10 meter

$$FS = UR + CL + AF$$

(FS-field strength; UR-voltage at the receiver; CL-loss of the cable; AF-antenna factor)

Example calculation:

$$FS [dB\mu V/m] = 12.35 [dB\mu V/m] + 1.90 [dB] + 16.80 [dB/m] = 31.05 [dB\mu V/m] (35.69 \mu V/m)$$

### Equipment table:

No.	Lab / Item	Equipment	Type	Manufacturer	Serial No.	INV. No.	Kind of Calibration	Last Calibration	Next Calibration
1	A	Switch-Unit	3488A	HP	2719A14505	300000368	ev	-/-	-/-
2	A	DC power supply, 60Vdc, 50A, 1200 W	6032A	HP	2920A04466	300000580	ne	-/-	-/-
3	A	Meßkabine 1	HF-Absorberhalle	MWB AG 300023	-/-	300000551	ne	-/-	-/-
4	A	EMI Test Receiver	ESCI 3	R&S	100083	300003312	k	15.12.2017	14.12.2018
5	A	Antenna Tower	Model 2175	ETS-Lindgren	64762	300003745	izw	-/-	-/-
6	A	Positioning Controller	Model 2090	ETS-Lindgren	64672	300003746	izw	-/-	-/-
7	A	Turntable Interface-Box	Model 105637	ETS-Lindgren	44583	300003747	izw	-/-	-/-
8	A	IRILOG Broadband Test-Antenna 30 MHz - 3 GHz	VULB9163	Schwarzbeck	295	300003787	k	25.04.2016	25.04.2018

## 6.2 Shielded fully anechoic chamber

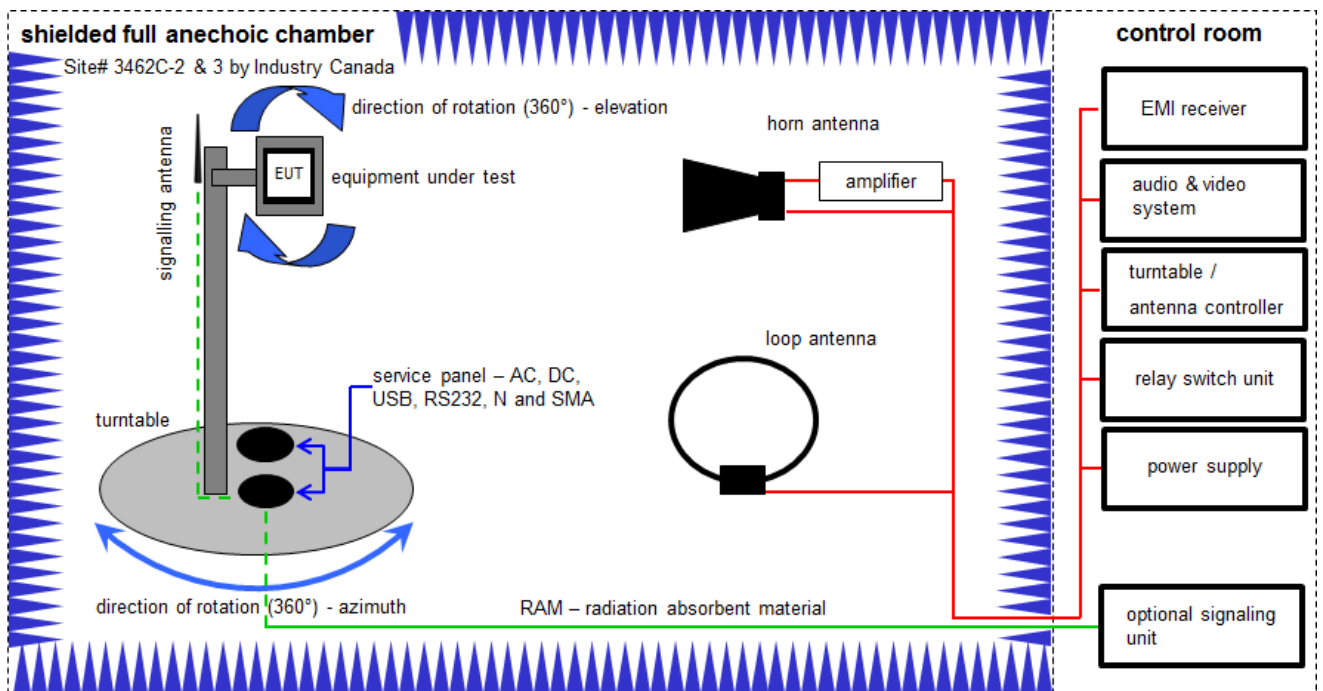

Measurement distance: horn antenna 3 meter; loop antenna 3 meter

$$FS = UR + CA + AF$$

(FS-field strength; UR-voltage at the receiver; CA-loss of the signal path; AF-antenna factor)

Example calculation:

$$FS [dB\mu V/m] = 40.0 [dB\mu V/m] + (-35.8) [dB] + 32.9 [dB/m] = 37.1 [dB\mu V/m] (71.61 \mu V/m)$$

### Equipment table:

No.	Lab / Item	Equipment	Type	Manufacturer	Serial No.	INV. No.	Kind of Calibration	Last Calibration	Next Calibration
1	A, B, C	DC power supply, 60Vdc, 50A, 1200 W	6032A	HP	2818A03450	300001040	v IKI!	12.12.2017	11.12.2020
2	C	Active Loop Antenna 9 kHz to 30 MHz	6502	EMCO	2210	300001015	k	07.07.2017	06.07.2019
3	A, B, C	Anechoic chamber	FAC 3/5m	MWB / TDK	87400/02	300000996	ev	-/-	-/-
4	A, B	Double-Ridged Wav eguide Horn Antenna 1-18.0GHz	3115	EMCO	9107-3697	300001605	v IKI!	14.02.2017	13.02.2019
5	A, B, C	Switch / Control Unit	3488A	HP	*	300000199	ne	-/-	-/-
6	B	Band Reject filter	WRCG2400/2483-2375/2505-50/10SS	Wainwright	11	300003351	ev	-/-	-/-
7	A, B, C	EMI Test Receiver 20Hz- 26,5GHz	ESU26	R&S	100037	300003555	k	20.12.2017	19.12.2018
8	B	Highpass Filter	WHK1.1/15G-10SS	Wainwright	3	300003255	ev	-/-	-/-
9	B	Highpass Filter	WHKX7.0/18G-8SS	Wainwright	19	300003790	ne	-/-	-/-
10	A, B	Broadband Amplifier 0.5-18 GHz	CBLU5184540	CERNEK	22049	300004481	ev	-/-	-/-
11	B	Broadband Amplifier 5-13 GHz	CBLU5135235	CERNEK	22010	300004491	ev	-/-	-/-
12	A, B, C	4U RF Switch Platform	L4491A	Agilent Technologies	MY 50000037	300004509	ne	-/-	-/-
13	A, B, C	NEXIO EMV-Software	BAT EMC V3.16.0.49	EMCO	-/-	300004682	ne	-/-	-/-
14	A, B, C	PC	EXOne	F+W	-/-	300004703	ne	-/-	-/-



### 6.3 Radiated measurements > 18 GHz

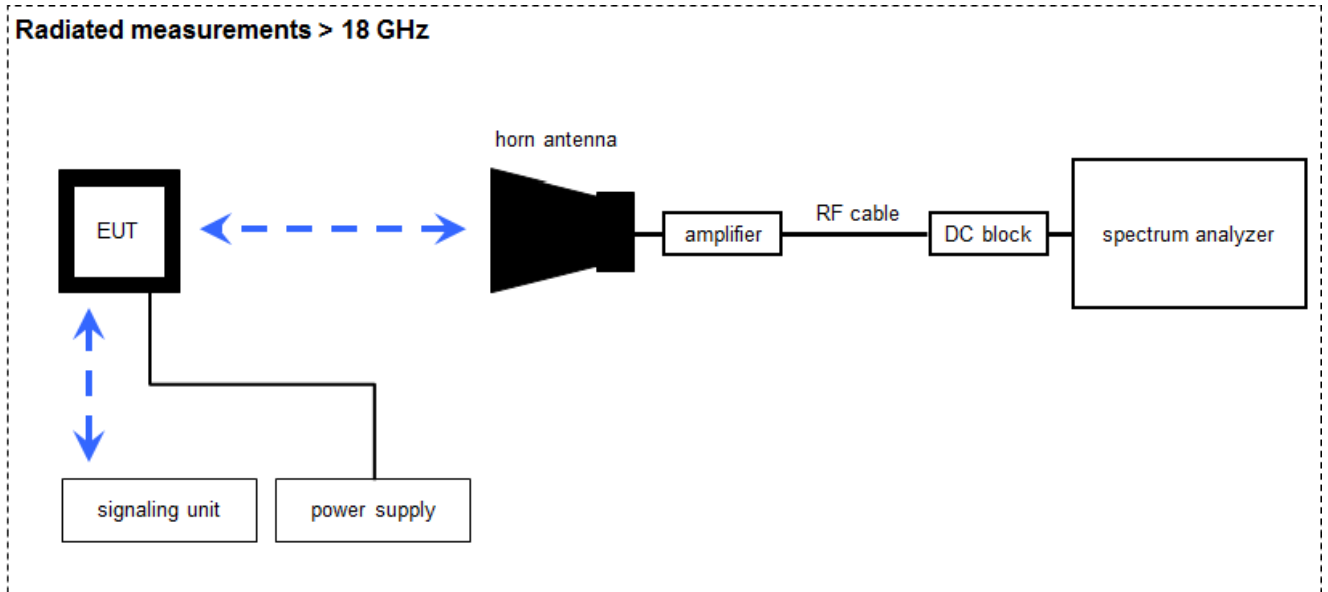

Measurement distance: horn antenna 50 cm

$$FS = UR + CA + AF$$

(FS-field strength; UR-voltage at the receiver; CA-loss signal path & distance correction; AF-antenna factor)

Example calculation:

$$FS \text{ [dB}\mu\text{V/m]} = 40.0 \text{ [dB}\mu\text{V/m]} + (-60.1) \text{ [dB]} + 36.74 \text{ [dB/m]} = 16.64 \text{ [dB}\mu\text{V/m]} \text{ (6.79 } \mu\text{V/m)}$$

#### **Equipment table:**

No.	Lab / Item	Equipment	Type	Manufacturer	Serial No.	INV. No.	Kind of Calibration	Last Calibration	Next Calibration
1	A	Microwave System Amplifier, 0.5-26.5 GHz	83017A	HP	00419	300002268	ev	-/-	-/-
2	A	Std. Gain Horn Antenna 18.0-26.5 GHz	638	Narda	-/-	300000486	k	13.12.2017	12.12.2019
3	A	Signal Analyzer 40 GHz	FSV40	R&S	101042	300004517	k	16.01.2018	15.01.2019
4	A	RF-Cable	ST18/SMAm/SMAm/48	Huber & Suhner	Batch no. 127377	400001183	ev	-/-	-/-
5	A	DC-Blocker 0.1-40 GHz	8141A	Inmet	-/-	400001185	ev	-/-	-/-

## 6.4 Conducted measurements Bluetooth system

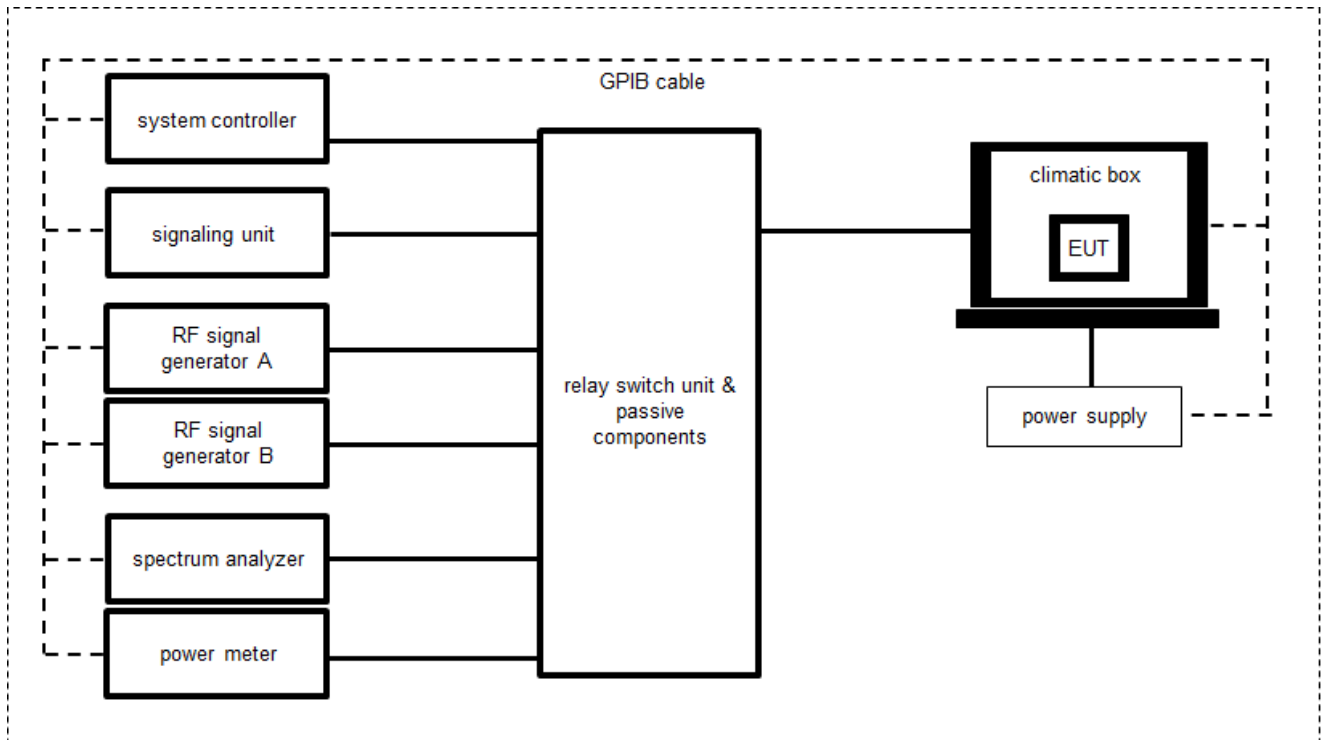

OP = AV + CA  
(OP-output power; AV-analyzer value; CA-loss signal path)

Example calculation:

OP [dBm] = 6.0 [dBm] + 11.7 [dB] = 17.7 [dBm] (58.88 mW)

### Equipment table:

No.	Lab / Item	Equipment	Type	Manufacturer	Serial No.	INV. No.	Kind of Calibration	Last Calibration	Next Calibration
1	A	Relay Switch Matrix	RSM-1	CTC	1	400001355	ev	07.02.2018	06.02.2019
2	A	Spectrum Analyzer	FSV30	Rohde & Schwarz	103809	300005359	k	04.04.2017	03.04.2019
3	A	PC	Exone	F+W		300004179	ne	-/-	-/-
4	A	USB/GPIB interface	82357B	Agilent Technologies	MY52103346	300004390	ne	-/-	-/-

## 7 Sequence of testing

### 7.1 Sequence of testing radiated spurious 9 kHz to 30 MHz

#### Setup

- The equipment is set up to simulate normal operation mode as described in the user manual or defined by the manufacturer.
- If the EUT is a tabletop system, it is placed on a table with 0.8 m height.
- If the EUT is a floor standing device, it is placed directly on the turn table.
- Auxiliary equipment and cables are positioned to simulate normal operation conditions as described in ANSI C 63.4.
- The AC power port of the EUT (if available) is connected to a power outlet below the turntable.
- Measurement distance is 3 m (see ANSI C 63.4) – see test details.
- EUT is set into operation.

#### Premeasurement\*

- The turntable rotates from 0° to 315° using 45° steps.
- The antenna height is 1 m.
- At each turntable position the analyzer sweeps with positive-peak detector to find the maximum of all emissions.

#### Final measurement

- Identified emissions during the pre-measurement are maximized by the software by rotating the turntable from 0° to 360°.
- Loop antenna is rotated about its vertical axis for maximum response at each azimuth about the EUT. (For certain applications, the loop antenna plane may also need to be positioned horizontally at the specified distance from the EUT)
- The final measurement is done in the position (turntable and elevation) causing the highest emissions with quasi-peak (as described in ANSI C 63.4).
- Final levels, frequency, measuring time, bandwidth, turntable position, correction factor, margin to the limit and limit will be recorded. A plot with the graph of the premeasurement and the limit is stored.

\*)Note: The sequence will be repeated three times with different EUT orientations.

## 7.2 Sequence of testing radiated spurious 30 MHz to 1 GHz

### Setup

- The equipment is set up to simulate normal operation mode as described in the user manual or defined by the manufacturer.
- If the EUT is a tabletop system, a table with 0.8 m height is used, which is placed on the ground plane.
- If the EUT is a floor standing device, it is placed on the ground plane with insulation between both.
- Auxiliary equipment and cables are positioned to simulate normal operation conditions as described in ANSI C 63.4.
- The AC power port of the EUT (if available) is connected to a power outlet below the turntable.
- Measurement distance is 10 m or 3 m (see ANSI C 63.4) – see test details.
- EUT is set into operation.

### Premeasurement

- The turntable rotates from 0° to 315° using 45° steps.
- The antenna is polarized vertical and horizontal.
- The antenna height changes from 1 m to 3 m.
- At each turntable position, antenna polarization and height the analyzer sweeps three times in peak to find the maximum of all emissions.

### Final measurement

- The final measurement is performed for at least six highest peaks according to the requirements of the ANSI C63.4.
- Based on antenna and turntable positions at which the peak values are measured the software maximize the peaks by changing turntable position  $\pm 45^\circ$  and antenna height between 1 and 4 m.
- The final measurement is done with quasi-peak detector (as described in ANSI C 63.4).
- Final levels, frequency, measuring time, bandwidth, antenna height, antenna polarization, turntable angle, correction factor, margin to the limit and limit are recorded. A plot with the graph of the premeasurement with marked maximum final results and the limit is stored.

### 7.3 Sequence of testing radiated spurious 1 GHz to 18 GHz

#### Setup

- The equipment is set up to simulate normal operation mode as described in the user manual or defined by the manufacturer.
- If the EUT is a tabletop system, a 2-axis positioner with 1.5 m height is used.
- If the EUT is a floor standing device, it is placed directly on the turn table.
- Auxiliary equipment and cables are positioned to simulate normal operation conditions as described in ANSI C 63.4.
- The AC power port of the EUT (if available) is connected to a power outlet below the turntable.
- Measurement distance is 3 m (see ANSI C 63.4) – see test details.
- EUT is set into operation.

#### Premeasurement

- The turntable rotates from 0° to 315° using 45° steps.
- The antenna is polarized vertical and horizontal.
- The antenna height is 1.5 m.
- At each turntable position and antenna polarization the analyzer sweeps with positive peak detector to find the maximum of all emissions.

#### Final measurement

- The final measurement is performed for at least six highest peaks according to the requirements of the ANSI C63.4.
- Based on antenna and turntable positions at which the peak values are measured the software maximizes the peaks by rotating the turntable from 0° to 360°. This measurement is repeated for different EUT-table positions (0° to 150° in 30°-steps) and for both antenna polarizations.
- The final measurement is done in the position (turntable, EUT-table and antenna polarization) causing the highest emissions with Peak and RMS detector (as described in ANSI C 63.4).
- Final levels, frequency, measuring time, bandwidth, turntable position, EUT-table position, antenna polarization, correction factor, margin to the limit and limit are recorded. A plot with the graph of the premeasurement with marked maximum final results and the limit is stored.

## 7.4 Sequence of testing radiated spurious above 18 GHz

### Setup

- The equipment is set up to simulate normal operation mode as described in the user manual or defined by the manufacturer.
- Auxiliary equipment and cables are positioned to simulate normal operation conditions as described in ANSI C 63.4.
- The AC power port of the EUT (if available) is connected to a power outlet.
- The measurement distance is as appropriate (e.g. 0.5 m).
- The EUT is set into operation.

### Premeasurement

- The test antenna is handheld and moved carefully over the EUT to cover the EUT's whole sphere and different polarizations of the antenna.

### Final measurement

- The final measurement is performed at the position and antenna orientation causing the highest emissions with Peak and RMS detector (as described in ANSI C 63.4).
- Final levels, frequency, measuring time, bandwidth, correction factor, margin to the limit and limit are recorded. A plot with the graph of the premeasurement and the limit is stored.

## 8 Measurement uncertainty

Measurement uncertainty	
Test case	Uncertainty
Antenna gain	± 3 dB
Spectrum bandwidth	± 21.5 kHz absolute; ± 15.0 kHz relative
Maximum output power	± 1 dB
Detailed conducted spurious emissions @ the band edge	± 1 dB
Band edge compliance radiated	± 3 dB
Spurious emissions conducted	± 3 dB
Spurious emissions radiated below 30 MHz	± 3 dB
Spurious emissions radiated 30 MHz to 1 GHz	± 3 dB
Spurious emissions radiated 1 GHz to 12.75 GHz	± 3.7 dB
Spurious emissions radiated above 12.75 GHz	± 4.5 dB
Spurious emissions conducted below 30 MHz (AC conducted)	± 2.6 dB

## 9 Summary of measurement results

<input type="checkbox"/>	No deviations from the technical specifications were ascertained
<input type="checkbox"/>	There were deviations from the technical specifications ascertained
<input checked="" type="checkbox"/>	This test report is only a partial test report. The content and verdict of the performed test cases are listed below.

TC Identifier	Description	Verdict	Date	Remark
RF-Testing	CFR Part 15 RSS - 247, Issue 2	See table!	2018-05-02	Delta tests according customer demand.

Test specification clause	Test case	Guideline	Temperature conditions	Power source voltages	Mode	C	NC	NA	NP	Remark
§15.247(b)(4) RSS - 247 / 5.4 (4)	System gain	-/-	Nominal	Nominal	GFSK	<input checked="" type="checkbox"/>	<input type="checkbox"/>	<input type="checkbox"/>	<input type="checkbox"/>	-/-
§15.247(e) RSS - 247 / 5.2 (b)	Power spectral density	KDB 558074 DTS clause: 10.6	Nominal	Nominal	GFSK	<input type="checkbox"/>	<input type="checkbox"/>	<input type="checkbox"/>	<input checked="" type="checkbox"/>	-/-
§15.247(a)(2) RSS - 247 / 5.2 (a)	DTS bandwidth – 6 dB bandwidth	KDB 558074 DTS clause: 8.1	Nominal	Nominal	GFSK	<input type="checkbox"/>	<input type="checkbox"/>	<input type="checkbox"/>	<input checked="" type="checkbox"/>	-/-
RSS Gen clause 4.6.1	Occupied bandwidth	-/-	Nominal	Nominal	GFSK	<input type="checkbox"/>	<input type="checkbox"/>	<input type="checkbox"/>	<input checked="" type="checkbox"/>	-/-
§15.247(b)(3) RSS - 247 / 5.4 (4)	Maximum output power	KDB 558074 DTS clause: 9.1.1	Nominal	Nominal	GFSK	<input checked="" type="checkbox"/>	<input type="checkbox"/>	<input type="checkbox"/>	<input type="checkbox"/>	-/-
§15.247(d) RSS - 247 / 5.5	Detailed spurious emissions @ the band edge - conducted	-/-	Nominal	Nominal	GFSK	<input type="checkbox"/>	<input type="checkbox"/>	<input type="checkbox"/>	<input checked="" type="checkbox"/>	-/-
§15.205 RSS - 247 / 5.5 RSS - Gen	Band edge compliance radiated	KDB 558074 DTS clause: 13.3.2	Nominal	Nominal	GFSK	<input checked="" type="checkbox"/>	<input type="checkbox"/>	<input type="checkbox"/>	<input type="checkbox"/>	-/-
§15.247(d) RSS - 247 / 5.5	TX spurious emissions conducted	KDB 558074 DTS clause: 11.1 & 11.2 11.3	Nominal	Nominal	GFSK	<input type="checkbox"/>	<input type="checkbox"/>	<input type="checkbox"/>	<input checked="" type="checkbox"/>	-/-
§15.209(a) RSS - Gen	Spurious emissions radiated below 30 MHz	-/-	Nominal	Nominal	GFSK	<input checked="" type="checkbox"/>	<input type="checkbox"/>	<input type="checkbox"/>	<input type="checkbox"/>	-/-
§15.247(d) RSS - 247 / 5.5 §15.109 RSS - Gen	Spurious emissions radiated 30 MHz to 1 GHz	-/-	Nominal	Nominal	-/-	<input checked="" type="checkbox"/>	<input type="checkbox"/>	<input type="checkbox"/>	<input type="checkbox"/>	-/-
§15.247(d) RSS - 247 / 5.5 §15.109 RSS - Gen	Spurious emissions radiated above 1 GHz	-/-	Nominal	Nominal	GFSK	<input checked="" type="checkbox"/>	<input type="checkbox"/>	<input type="checkbox"/>	<input type="checkbox"/>	-/-
§15.107(a) §15.207	Conducted emissions below 30 MHz (AC conducted)	-/-	Nominal	Nominal	GFSK	<input type="checkbox"/>	<input type="checkbox"/>	<input checked="" type="checkbox"/>	<input type="checkbox"/>	-/-

### Notes:

<b>C</b>	Compliant	<b>NC</b>	Not compliant	<b>NA</b>	Not applicable	<b>NP</b>	Not performed
----------	-----------	-----------	---------------	-----------	----------------	-----------	---------------



## 10 Additional comments

The Bluetooth® word mark and logos are owned by the Bluetooth SIG Inc. and any use of such marks by CTC advanced GmbH is under license.

Reference documents: None

Special test descriptions: None

Configuration descriptions: TX tests: were performed with LE packets (37 byte payload) and static PRBS pattern.  
RX/Standby tests: BT enabled, TX Idle  
Tested frequencies: lowest: 2402 MHz  
middle: 2440 MHz  
- highest: 2480 MHz

Test mode:  Bluetooth LE Test mode enabled (EUT is controlled over CBT)  
 Special software is used.  
EUT is transmitting pseudo random data by itself

Antennas and transmit operating modes:  Operating mode 1 (single antenna)  
- *Equipment with 1 antenna,*  
- *Equipment with 2 diversity antennas operating in switched diversity mode by which at any moment in time only 1 antenna is used,*  
- *Smart antenna system with 2 or more transmit/receive chains, but operating in a mode where only 1 transmit/receive chain is used)*  
 Operating mode 2 (multiple antennas, no beamforming)  
- *Equipment operating in this mode contains a smart antenna system using two or more transmit/receive chains simultaneously but without beamforming.*  
 Operating mode 3 (multiple antennas, with beamforming)  
- *Equipment operating in this mode contains a smart antenna system using two or more transmit/receive chains simultaneously with beamforming. In addition to the antenna assembly gain (G), the beamforming gain (Y) may have to be taken into account when performing the measurements.*

## 11 Measurement results

### 11.1 Antenna gain

**Measurement:**

The antenna gain of the system is calculated by the difference of radiated power in EIRP and the conducted power of the module.

Measurement parameters	
Detector	Peak
Sweep time	Auto
Resolution bandwidth	3 MHz
Video bandwidth	3 MHz
Trace mode	Max hold
Test setup	See sub clause 6.4 A (conducted) See sub clause 6.2 A (radiated)
Measurement uncertainty	See sub clause 11

**Limits:**

< 6 dBi
---------

**Results:**

T <sub>nom</sub>	V <sub>nom</sub>	lowest channel	middle channel	highest channel
Conducted peak power [dBm] Measured with GFSK modulation		-1.1	-0.7	-1.2
Radiated peak power [dBm] Measured with GFSK modulation		1.8	0.3	-2.8
Gain [dBi] Calculated		2.7	1.0	-1.6

## 11.2 Maximum conducted output power

### Description:

Measurement of the maximum radiated output power. EUT in single channel mode.

### Limits:

FCC	IC
Maximum output power	
Conducted: 1.0 W – antenna gain max. 6 dBi	

### Results:

	Frequency		
	2402 MHz	2440 MHz	2480 MHz
Maximum output power conducted [dBm]	-1.1	-0.7	-1.2

**Plots:**

**Plot 1:** low channel

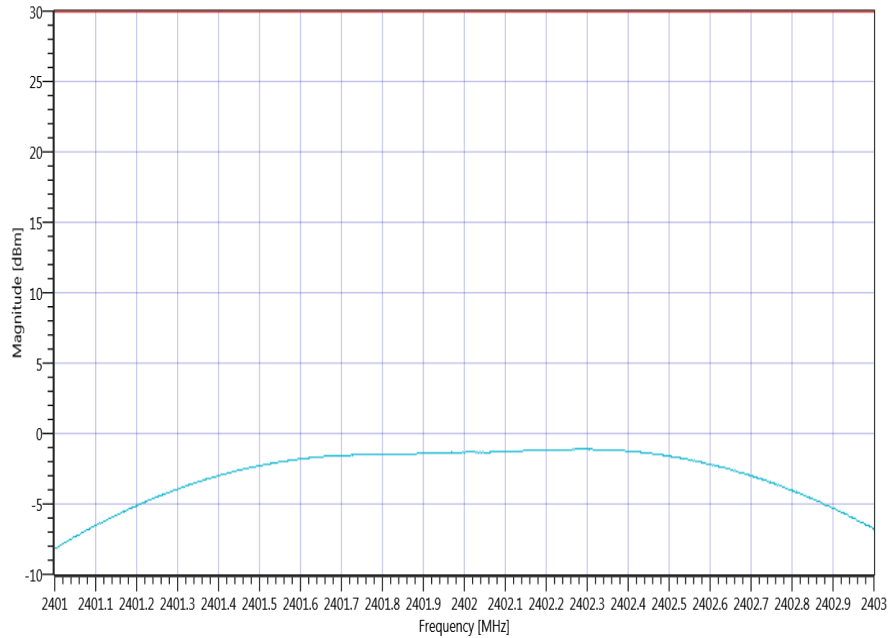

READ SA SETTINGS:	
Ref. Level [dBm]	9.02
Ref. Lev. offs [dB]	9.54
Input Attenuation [dB]	15
Freq. Start [MHz]	2401.000
Freq. Stop [MHz]	2403.000
Resolution BW. [MHz]	1.000000
Video BW. [MHz]	5.000000
Detector	POS
Sweep Time [ms]	1000
Sweep Count	10
Sweep Mode	MAXH
Used Sweep Type	SWE

**Plot 2:** mid channel

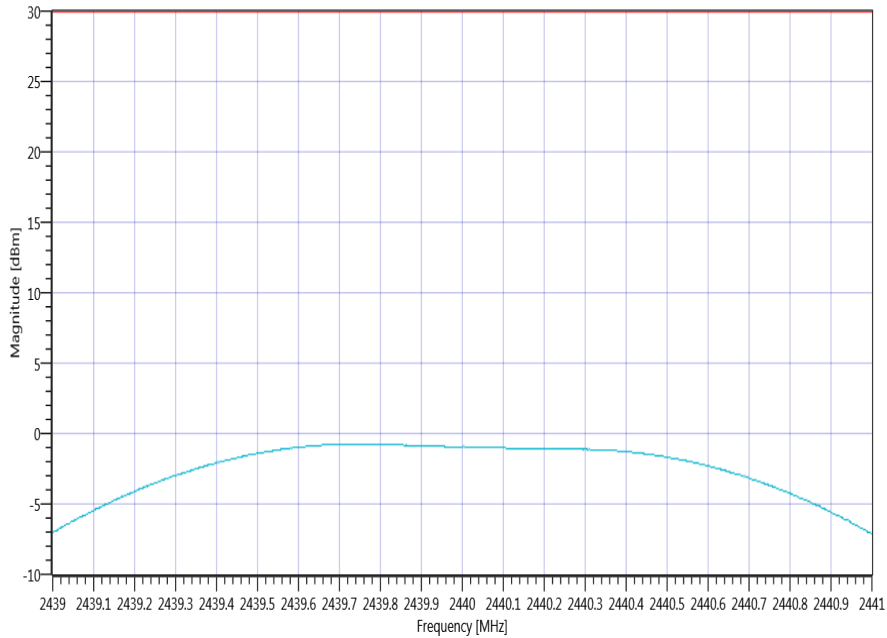

READ SA SETTINGS:	
Ref. Level [dBm]	9.39
Ref. Lev. offs [dB]	9.53
Input Attenuation [dB]	15
Freq. Start [MHz]	2439.000
Freq. Stop [MHz]	2441.000
Resolution BW. [MHz]	1.000000
Video BW. [MHz]	5.000000
Detector	POS
Sweep Time [ms]	1000
Sweep Count	10
Sweep Mode	MAXH
Used Sweep Type	SWE

**Plot 3:** high channel

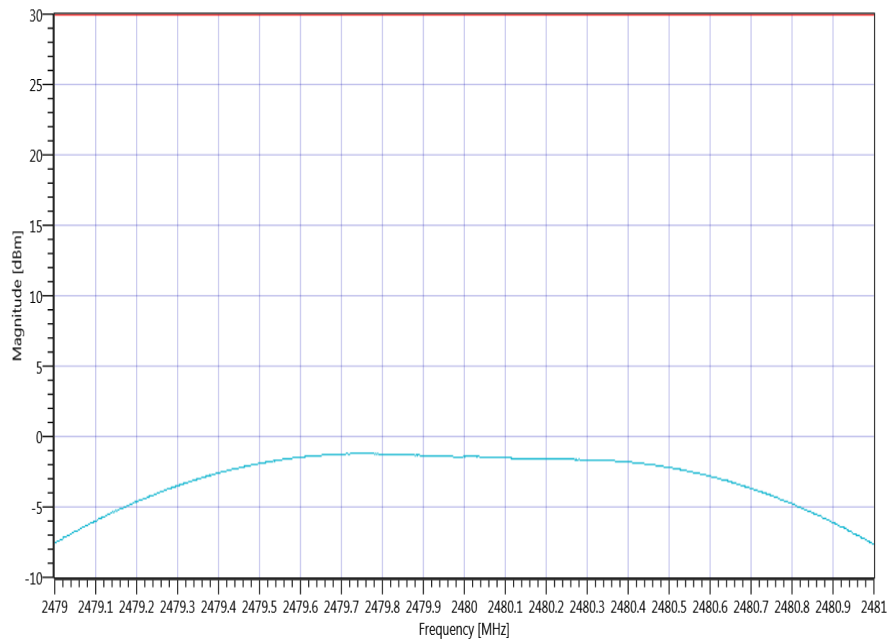

READ SA SETTINGS:	
Ref. Level [dBm]	8.85
Ref. Lev. offs [dB]	9.54
Input Attenuation [dB]	15
Freq. Start [MHz]	2479.000
Freq. Stop [MHz]	2481.000
Resolution BW. [MHz]	1.000000
Video BW. [MHz]	5.000000
Detector	POS
Sweep Time [ms]	1000
Sweep Count	10
Sweep Mode	MAXH
Used Sweep Type	SWE

### 11.3 Band edge compliance radiated

**Description:**

Measurement of the radiated band edge compliance. The EUT is turned in the position that results in the maximum level at the band edge. Then a sweep over the corresponding restricted band is performed. The EUT is set to single channel mode and the transmit frequency 2402 MHz for the lower restricted band and 2480 MHz for the upper restricted band. Measurement distance is 3m.

Measurement parameters	
Detector	Peak / RMS
Sweep time	Auto
Resolution bandwidth	1 MHz
Video bandwidth	3 MHz
Span	Lower Band: 2300 – 2400 MHz higher Band: 2480 – 2500 MHz
Trace mode	Max hold
Test setup	See sub clause 6.2 A
Measurement uncertainty	See sub clause 8

**Limits:**

FCC	IC
Band edge compliance radiated	
<p>In any 100 kHz bandwidth outside the frequency band in which the spread spectrum or digitally modulated intentional radiator is operating, the radio frequency power that is produced by the intentional radiator shall be at least 20 dB below that in the 100 kHz bandwidth within the band that contains the highest level of the desired power, based on either an RF conducted or a radiated measurement. Attenuation below the general limits specified in Section 15.209(a) is not required. In addition, radiated emissions which fall in the restricted bands, as defined in Section 15.205(a), must also comply with the radiated emission limits specified in Section 15.209(a) (see Section 5.205(c)).</p>	
54 dBµV/m AVG 74 dBµV/m Peak	

**Result:**

Scenario	Band edge compliance radiated [dBµV/m]
Modulation	GFSK
Lower restricted band	< 54 AVG / < 74 PP
Upper restricted band	< 54 AVG / < 74 PP

**Plots:**

**Plot 1: Lower restricted band**

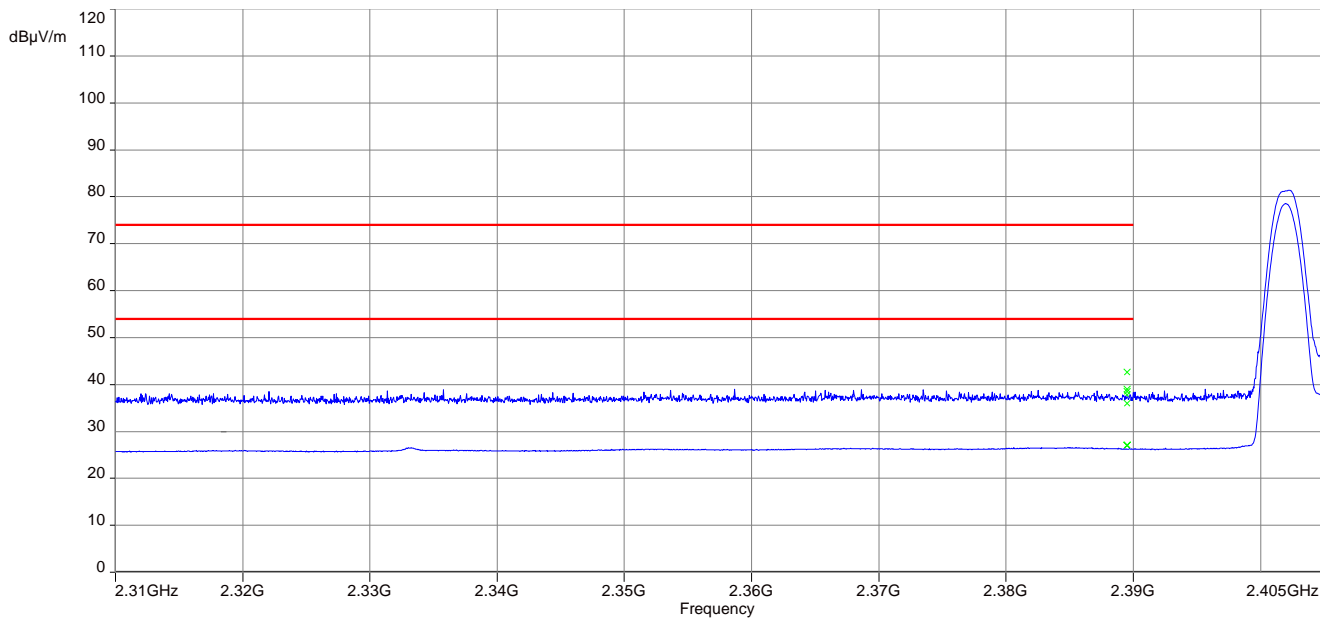

**Plot 2: Upper restricted band**

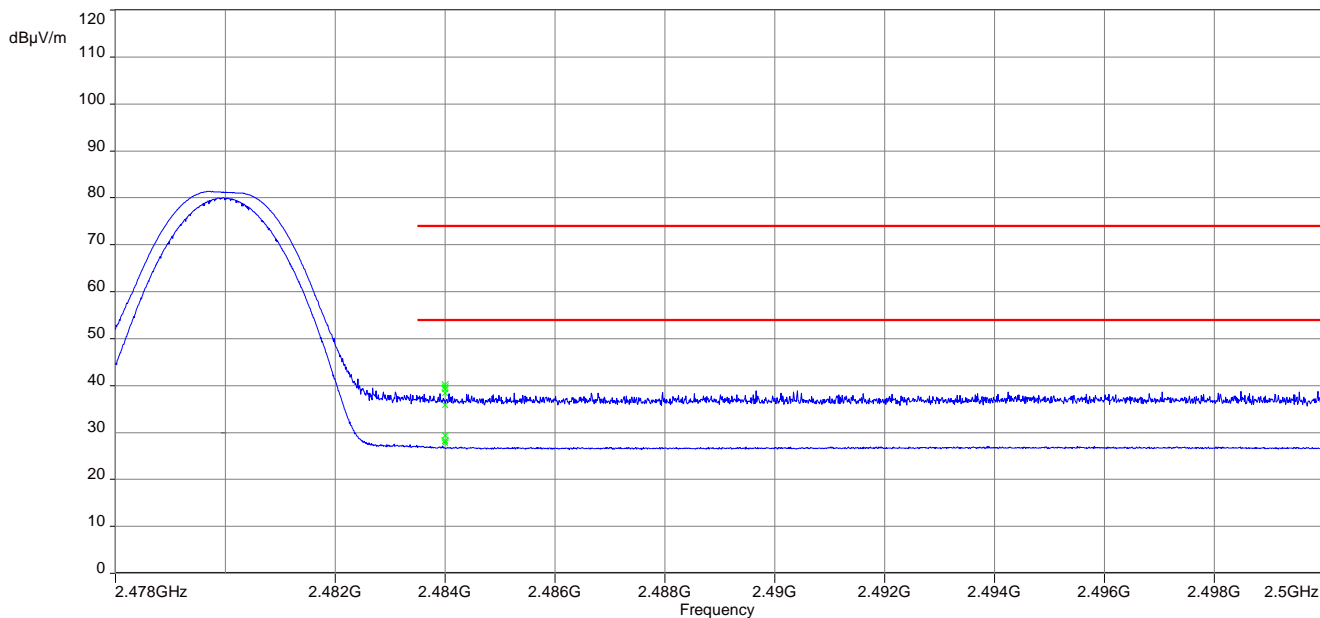



## 11.4 Spurious emissions radiated below 30 MHz

### Description:

Measurement of the radiated spurious emissions in transmit mode below 30 MHz. The EUT is set to single channel mode and the transmit frequencies are 2402 MHz, 2440 MHz and 2480 MHz. The measurement is performed in the mode with the highest output power. The limits are recalculated to a measurement distance of 3 m according to the ANSI C63.10.

Measurement parameters	
Detector	Peak / Quasi peak
Sweep time	Auto
Resolution bandwidth	F < 150 kHz: 200 Hz F > 150 kHz: 9 kHz
Video bandwidth	F < 150 kHz: 1 kHz F > 150 kHz: 30 kHz
Span	9 kHz to 30 MHz
Trace mode	Max hold
Test setup	See sub clause 6.2 C
Measurement uncertainty	See sub clause 8

### Limits:

FCC		IC
TX spurious emissions radiated below 30 MHz		
Frequency (MHz)	Field strength (dB $\mu$ V/m)	Measurement distance
0.009 – 0.490	2400/F(kHz)	300
0.490 – 1.705	24000/F(kHz)	30
1.705 – 30.0	30	30

### Results:

TX spurious emissions radiated below 30 MHz [dB $\mu$ V/m]		
F [MHz]	Detector	Level [dB $\mu$ V/m]
All detected emissions are more than 20 dB below the limit.		

**Plots:**

**Plot 1:** 9 kHz to 30 MHz, 2402 MHz, transmit mode

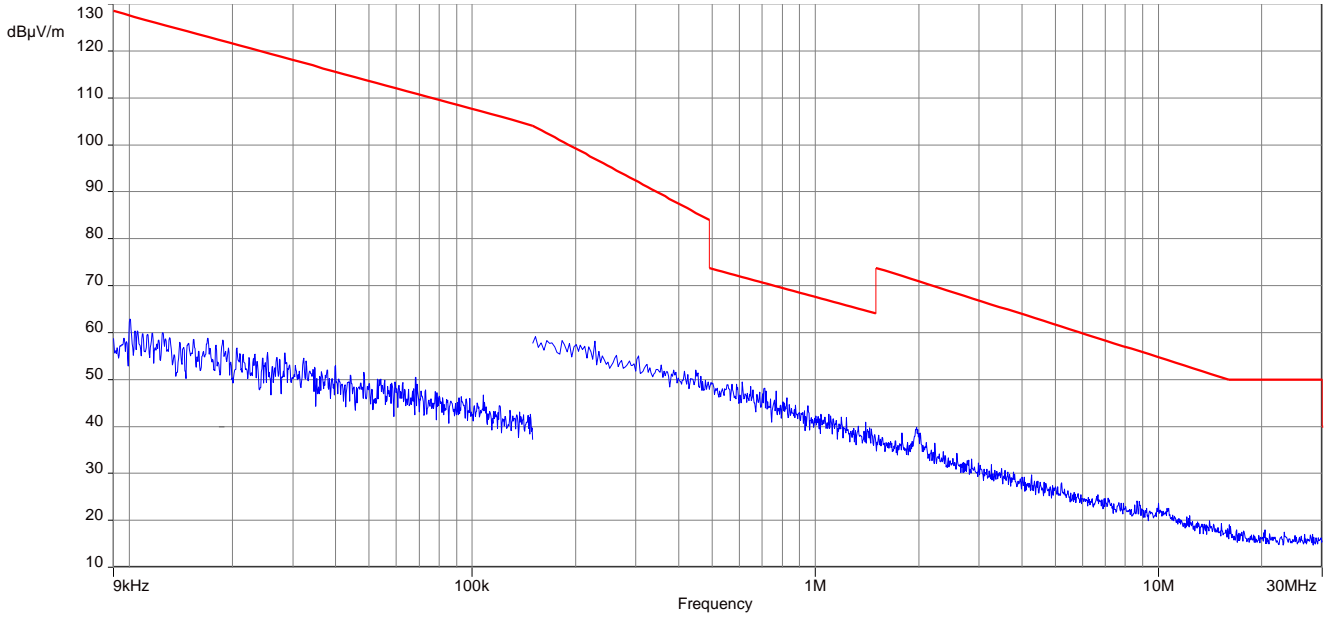

**Plot 2:** 9 kHz to 30 MHz, 2440 MHz, transmit mode

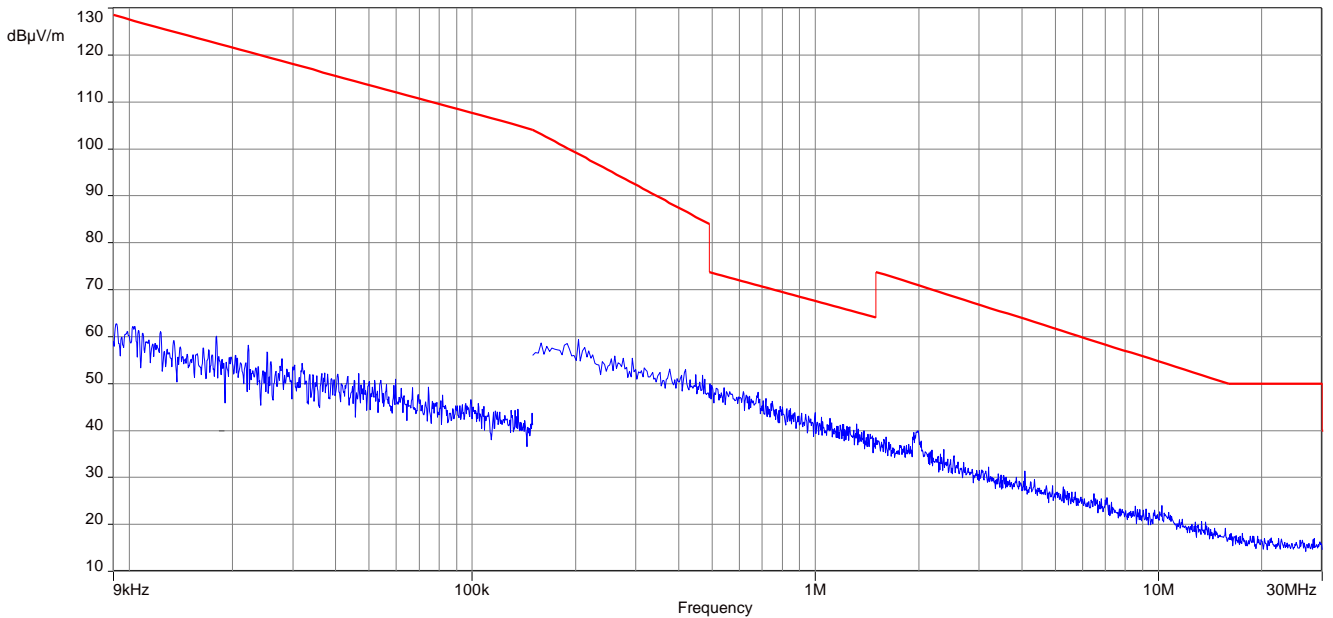

**Plot 3:** 9 kHz to 30 MHz, 2480 MHz, transmit mode

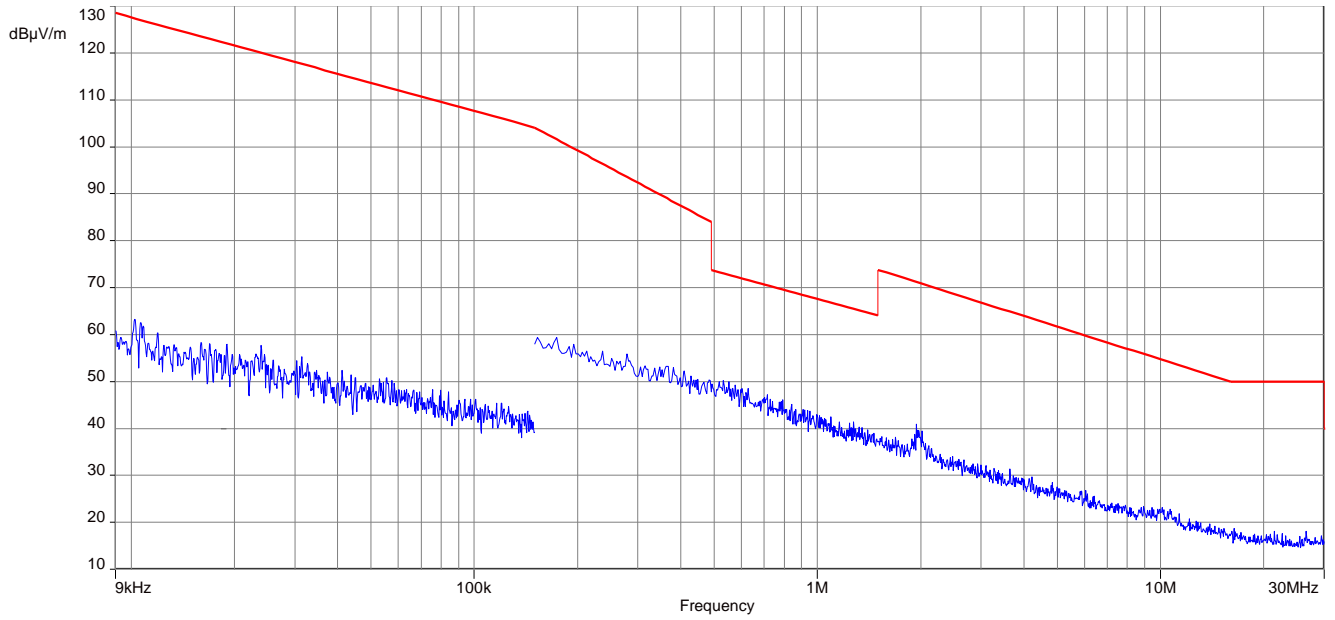

## 11.5 Spurious emissions radiated 30 MHz to 1 GHz

### Description:

Measurement of the radiated spurious emissions in transmit mode. The EUT is set to single channel mode and the transmit frequencies are 2402 MHz, 2440 MHz and 2480 MHz. The measurement is performed in the mode with the highest output power.

Measurement parameters	
Detector	Peak / Quasi Peak
Sweep time	Auto
Resolution bandwidth	120 kHz
Video bandwidth	3 x RBW
Span	30 MHz to 1 GHz
Trace mode	Max hold
Measured modulation	GFSK
Test setup	See sub clause 6.1 A
Measurement uncertainty	See sub clause 8

The modulation with the highest output power was used to perform the transmitter spurious emissions. If spurious were detected a re-measurement was performed on the detected frequency with each modulation.

### Limits:

FCC		IC	
TX spurious emissions radiated			
In any 100 kHz bandwidth outside the frequency band in which the spread spectrum or digitally modulated intentional radiator is operating, the radio frequency power that is produced by the intentional radiator shall be at least 20 dB below that in the 100 kHz bandwidth within the band that contains the highest level of the desired power, based on either an RF conducted or a radiated measurement. Attenuation below the general limits specified in Section 15.209(a) is not required. In addition, radiated emissions which fall in the restricted bands, as defined in §15.205(a), must also comply with the radiated emission limits specified in §15.209(a) (see §15.205(c)).			
§15.209			
Frequency (MHz)	Field strength (dBµV/m)	Measurement distance	
30 - 88	30.0	10	
88 – 216	33.5	10	
216 – 960	36.0	10	
Above 960	54.0	3	

**Plots:** Transmit mode

**Plot 1:** 30 MHz to 1 GHz, TX mode, 2402 MHz, vertical & horizontal polarization

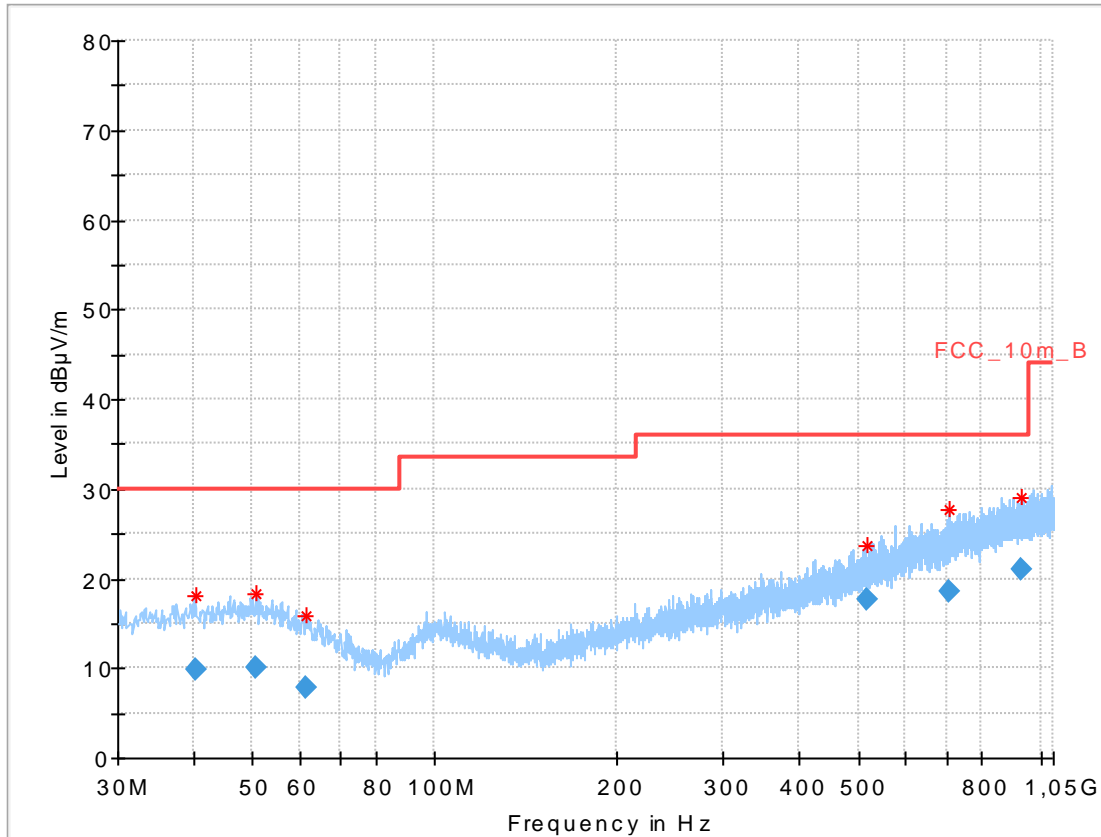

**Final results:**

Frequency (MHz)	QuasiPeak (dBµV/m)	Limit (dBµV/m)	Margin (dB)	Meas. Time (ms)	Bandwidth (kHz)	Height (cm)	Pol	Azimuth (deg)	Corr. (dB)
40.280	9.91	30.0	20.09	1000	120	101.0	V	180.0	13.2
50.644	9.99	30.0	20.01	1000	120	170.0	V	270.0	13.6
61.523	7.85	30.0	22.15	1000	120	101.0	H	180.0	11.5
515.424	17.55	36.0	18.45	1000	120	170.0	V	270.0	18.9
707.067	18.61	36.0	17.39	1000	120	101.0	V	180.0	21.7
926.857	21.01	36.0	14.99	1000	120	170.0	H	90.0	24.3

**Plot 2:** 30 MHz to 1 GHz, TX mode, 2440 MHz, vertical & horizontal polarization

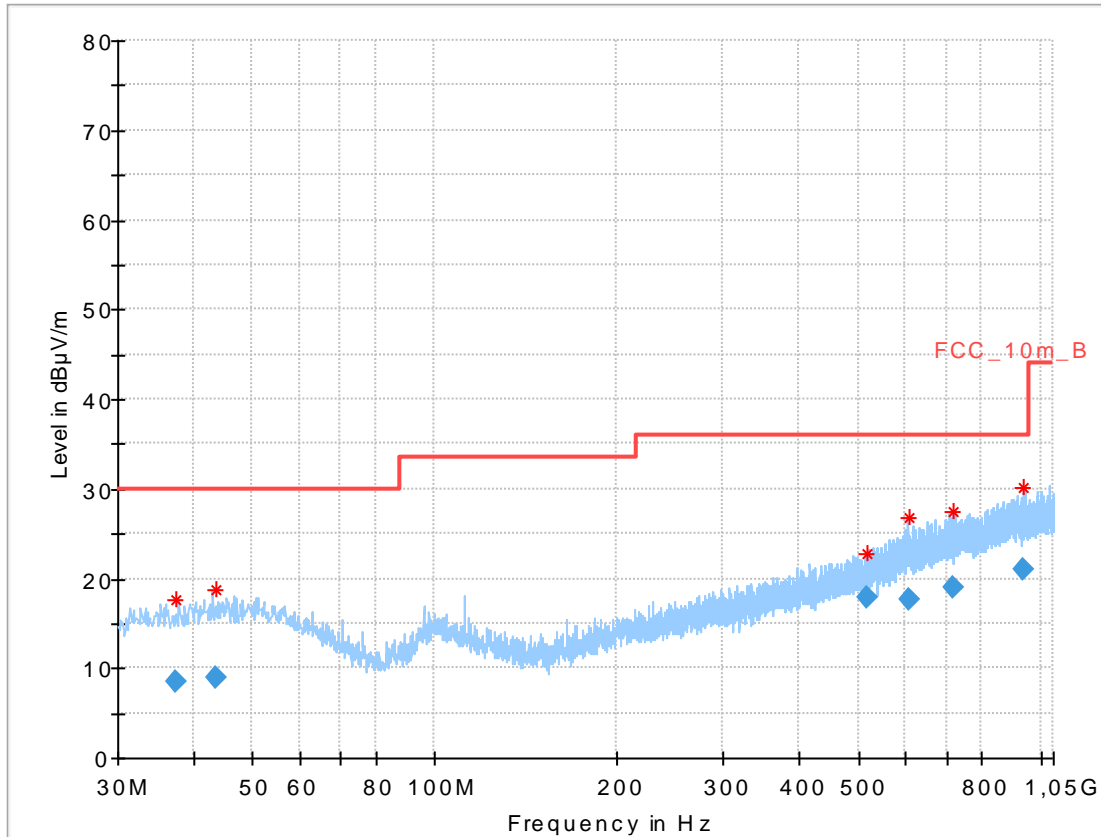

**Final results:**

Frequency (MHz)	QuasiPeak (dBµV/m)	Limit (dBµV/m)	Margin (dB)	Meas. Time (ms)	Bandwidth (kHz)	Height (cm)	Pol	Azimuth (deg)	Corr. (dB)
37.382	8.51	30.0	21.49	1000	120	101.0	H	90.0	12.9
43.425	8.88	30.0	21.12	1000	120	98.0	V	90.0	13.5
515.384	17.82	36.0	18.18	1000	120	170.0	V	180.0	18.9
604.838	17.59	36.0	18.41	1000	120	101.0	V	180.0	20.8
719.759	18.93	36.0	17.07	1000	120	170.0	H	180.0	22.0
935.893	20.96	36.0	15.04	1000	120	98.0	H	0.0	24.3

**Plot 3:** 30 MHz to 1 GHz, TX mode, 2480 MHz, vertical & horizontal polarization

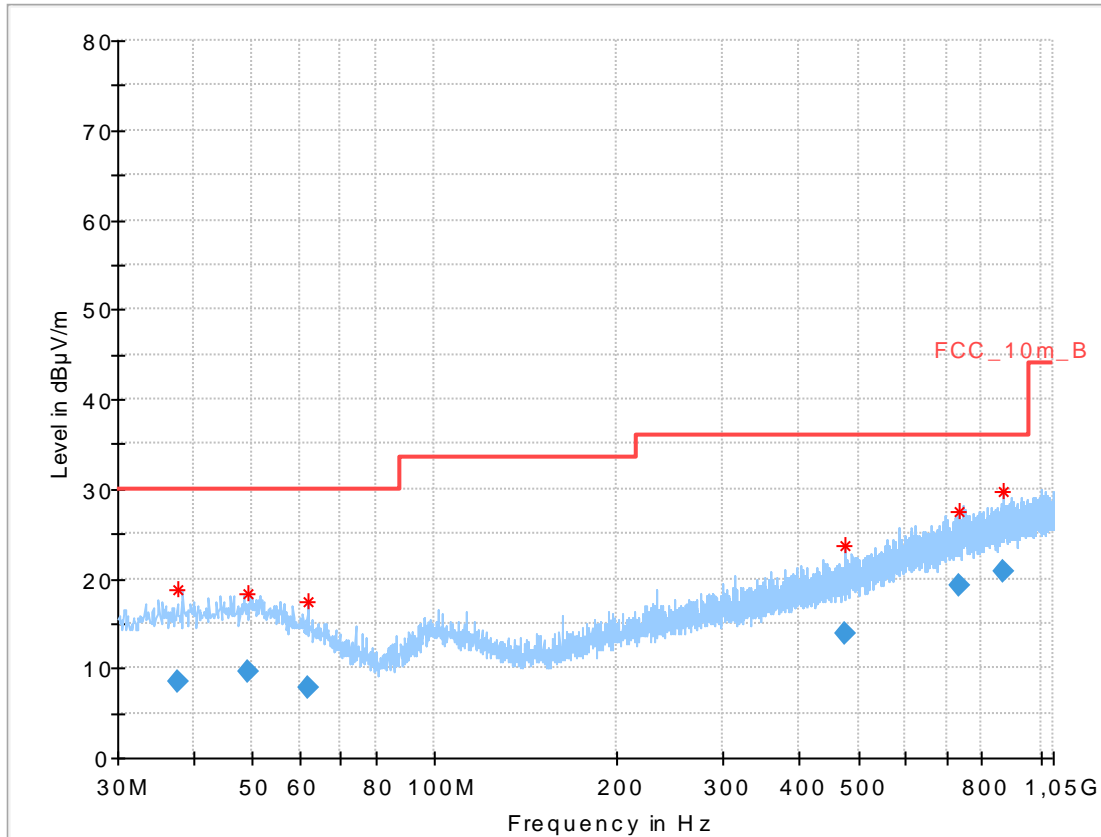

**Final results:**

Frequency (MHz)	QuasiPeak (dBµV/m)	Limit (dBµV/m)	Margin (dB)	Meas. Time (ms)	Bandwidth (kHz)	Height (cm)	Pol	Azimuth (deg)	Corr. (dB)
37.818	8.38	30.0	21.62	1000	120	101.0	V	180.0	13.0
49.344	9.62	30.0	20.38	1000	120	101.0	V	0.0	13.7
61.737	7.80	30.0	22.20	1000	120	170.0	H	270.0	11.5
474.900	13.88	36.0	22.12	1000	120	170.0	V	180.0	18.2
732.839	19.15	36.0	16.85	1000	120	98.0	H	0.0	22.3
866.937	20.78	36.0	15.22	1000	120	170.0	V	90.0	23.8

**Plots:** Receiver mode

**Plot 1:** 30 MHz to 1 GHz, RX / idle – mode, vertical & horizontal polarization

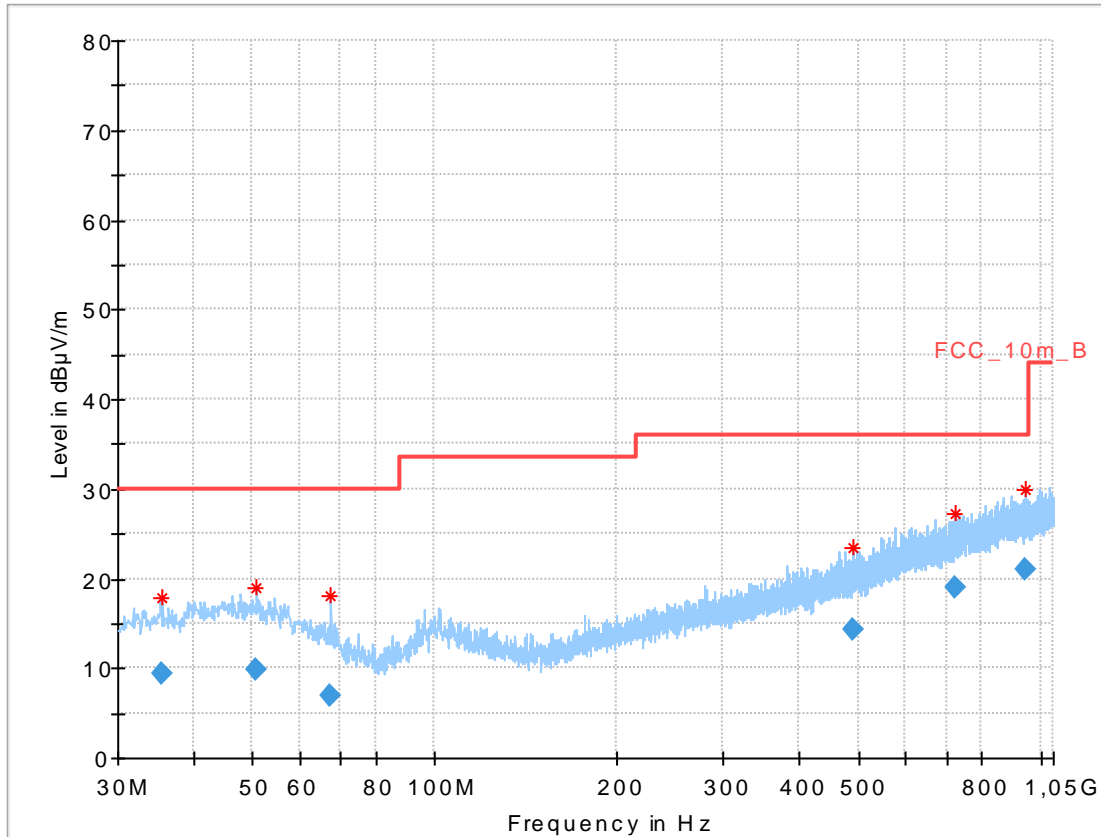

**Final results:**

Frequency (MHz)	QuasiPeak (dBµV/m)	Limit (dBµV/m)	Margin (dB)	Meas. Time (ms)	Bandwidth (kHz)	Height (cm)	Pol	Azimuth (deg)	Corr. (dB)
35.384	9.33	30.0	20.67	1000	120	101.0	V	270.0	12.7
50.833	9.90	30.0	20.10	1000	120	170.0	H	0.0	13.6
67.278	6.88	30.0	23.12	1000	120	98.0	H	0.0	10.3
490.257	14.20	36.0	21.80	1000	120	170.0	V	0.0	18.5
721.287	18.91	36.0	17.09	1000	120	101.0	V	180.0	22.1
945.916	20.99	36.0	15.01	1000	120	101.0	V	270.0	24.3



## 11.6 Spurious emissions radiated above 1 GHz

### Description:

Measurement of the radiated spurious emissions in transmit mode. The EUT is set to single channel mode and the transmit frequencies are 2402 MHz, 2440 MHz and 2480 MHz. The measurement is performed in the mode with the highest output power.

Measurement parameters	
Detector	Peak / RMS
Sweep time	Auto
Resolution bandwidth	1 MHz
Video bandwidth	3 x RBW
Span	1 GHz to 26 GHz
Trace mode	Max hold
Measured modulation	GFSK
Test setup	See sub clause 6.2 B (1 GHz - 18 GHz) See sub clause 6.3 A (18 GHz - 26 GHz)
Measurement uncertainty	See sub clause 8

The modulation with the highest output power was used to perform the transmitter spurious emissions. If spurious were detected a re-measurement was performed on the detected frequency with each modulation.

### Limits:

FCC		IC	
TX spurious emissions radiated			
In any 100 kHz bandwidth outside the frequency band in which the spread spectrum or digitally modulated intentional radiator is operating, the radio frequency power that is produced by the intentional radiator shall be at least 20 dB below that in the 100 kHz bandwidth within the band that contains the highest level of the desired power, based on either an RF conducted or a radiated measurement. Attenuation below the general limits specified in Section 15.209(a) is not required. In addition, radiated emissions which fall in the restricted bands, as defined in §15.205(a), must also comply with the radiated emission limits specified in §15.209(a) (see §15.205(c)).			
§15.209			
Frequency (MHz)	Field strength (dBµV/m)	Measurement distance	
Above 960	54.0 (Average)	3	
Above 960	74.0 (Peak)	3	

**Results:** Transmitter mode

TX spurious emissions radiated [dBµV/m]								
2402 MHz			2440 MHz			2480 MHz		
F [MHz]	Detector	Level [dBµV/m]	F [MHz]	Detector	Level [dBµV/m]	F [MHz]	Detector	Level [dBµV/m]
1056	Peak	37.6	1056	Peak	37.6	1056	Peak	37.6
	AVG	-/-		AVG	-/-		AVG	-/-
4804	Peak	49.5	7319	Peak	44.3	-/-	-/-	-/-
	AVG	-/-		AVG	-/-		-/-	-/-
For emissions above 18 GHz, see plots.			For emissions above 18 GHz, see plots.			For emissions above 18 GHz, see plots.		

**Results:** Receiver mode

RX spurious emissions radiated [dBµV/m]		
F [MHz]	Detector	Level [dBµV/m]
2333	Peak	38.6
	AVG	29.7
For emissions above 18 GHz, see plots.		

**Note:** The limit was recalculated with 20 dB / decade (Part 15.31) for all radiated spurious emissions 30 MHz to 1 GHz from 3 meter limit to a 10 meter distance. (40dB/decade for emissions < 30MHz)

**Plots:** Transmitter mode

**Plot 1:** 1 GHz to 18 GHz, TX mode, 2402 MHz, vertical & horizontal polarization

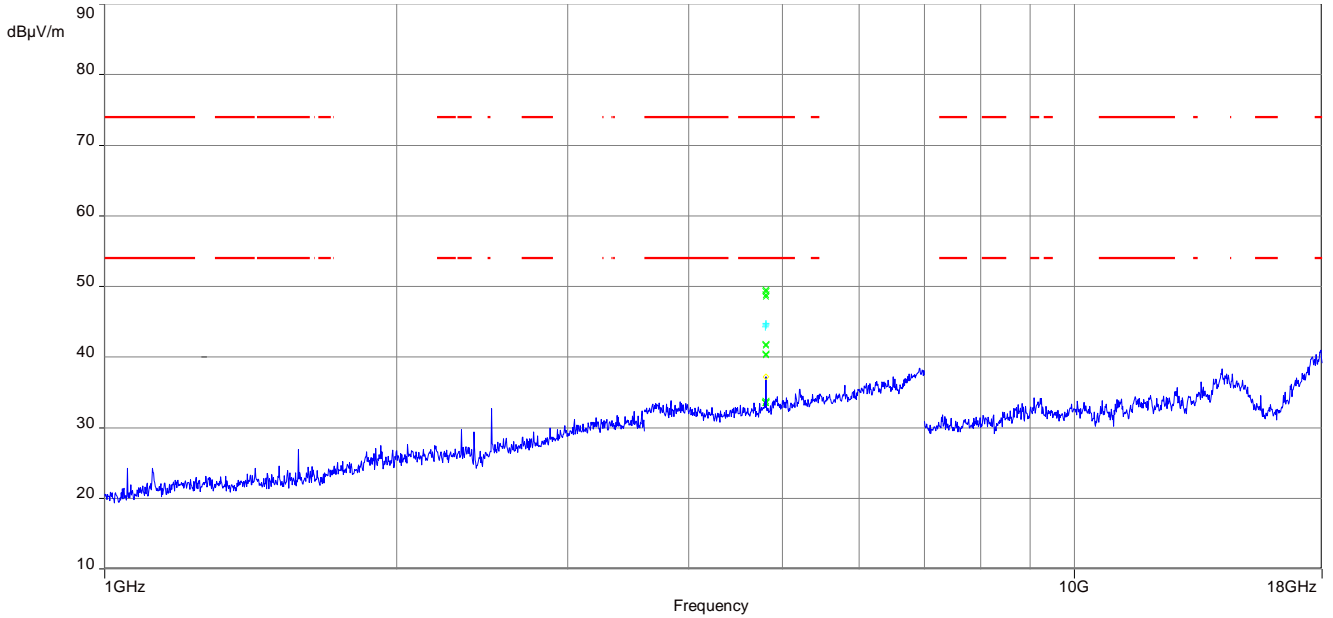

The carrier signal is notched with a 2.4 GHz band rejection filter.

**Plot 2:** 18 GHz to 26 GHz, TX mode, 2402 MHz, vertical & horizontal polarization

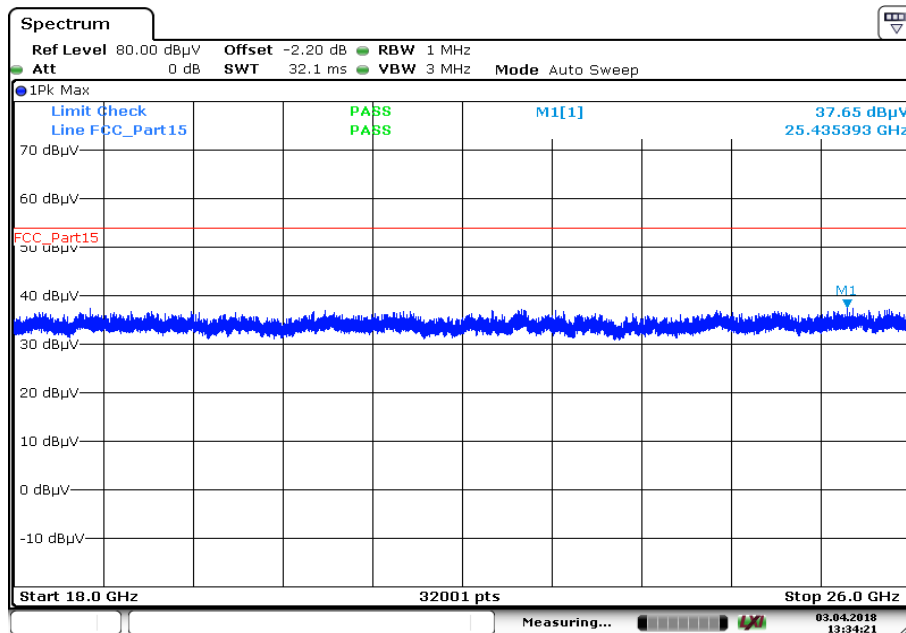

Date: 3.APR.2018 13:34:20

**Plot 3:** 1 GHz to 18 GHz, TX mode, 2440 MHz, vertical & horizontal polarization

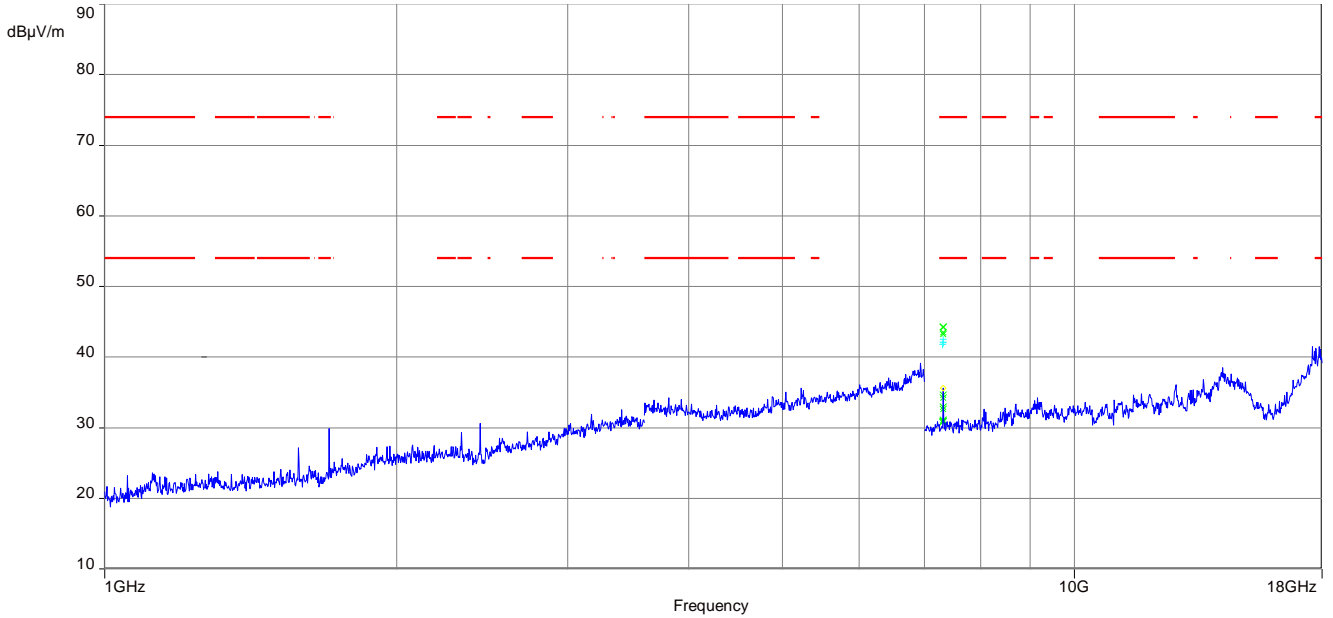

The carrier signal is notched with a 2.4 GHz band rejection filter.

**Plot 4:** 18 GHz to 26 GHz, TX mode, 2440 MHz, vertical & horizontal polarization

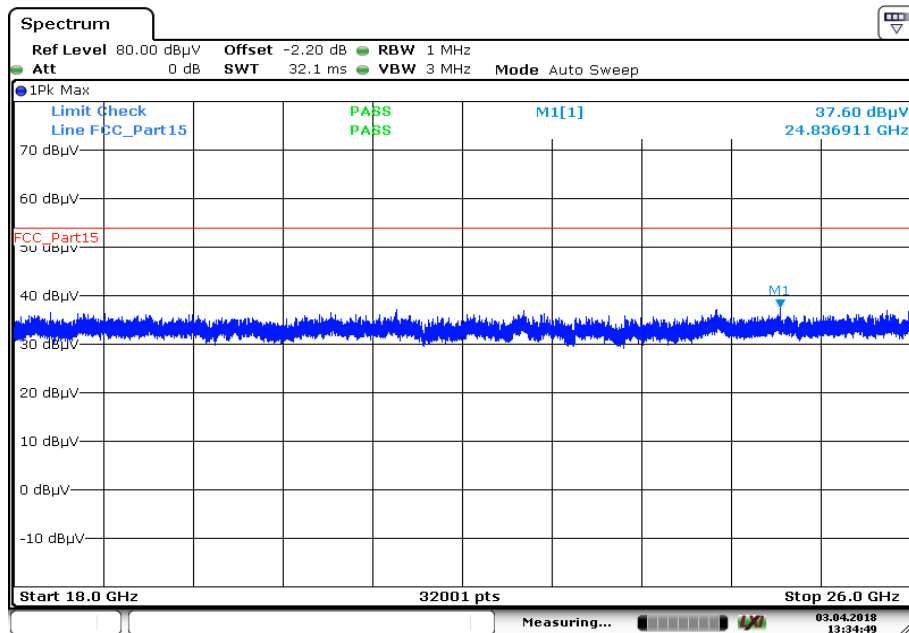

Date: 3.APR.2018 13:34:48

**Plot 5:** 1 GHz to 18 GHz, TX mode, 2480 MHz, vertical & horizontal polarization

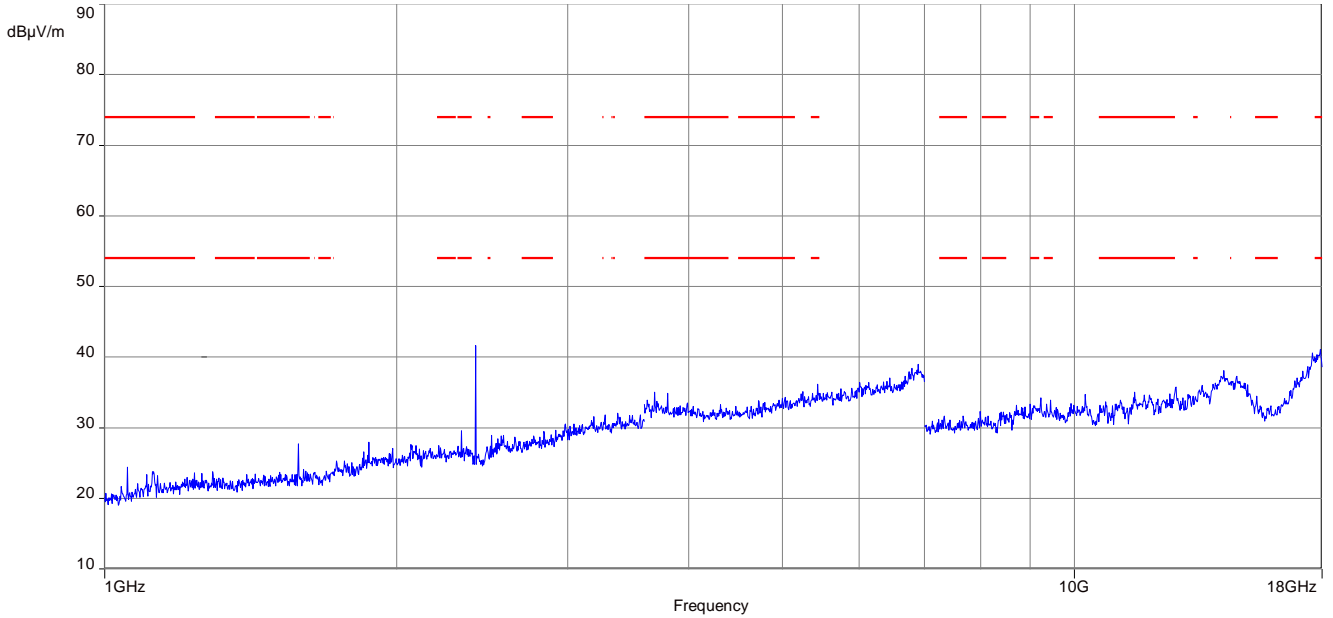

The carrier signal is notched with a 2.4 GHz band rejection filter.

**Plot 6:** 18 GHz to 26 GHz, TX mode, 2480 MHz, vertical & horizontal polarization

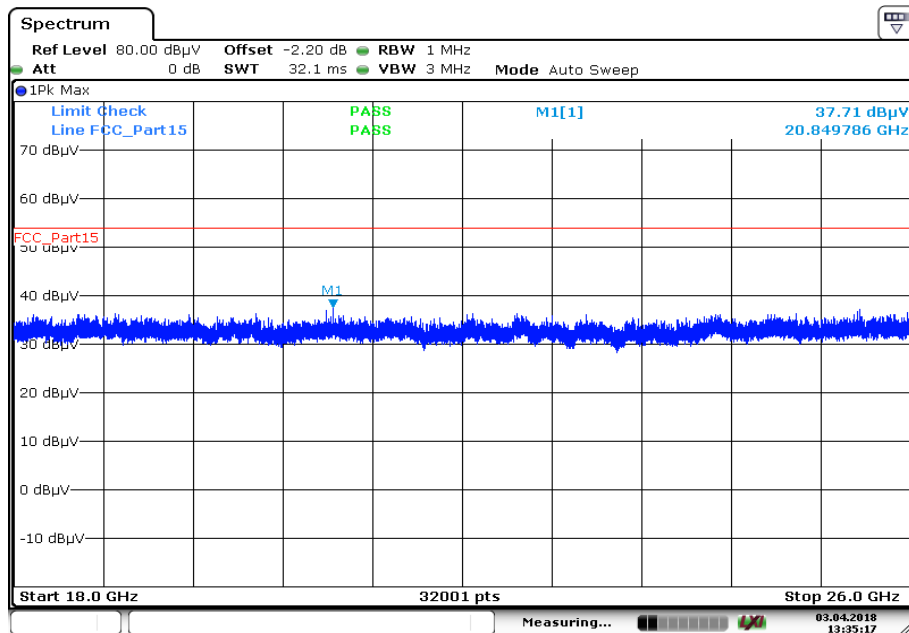

Date: 3.APR.2018 13:35:16

**Plots:** Receiver mode

**Plot 1:** 1 GHz to 18 GHz, RX / idle – mode, vertical & horizontal polarization

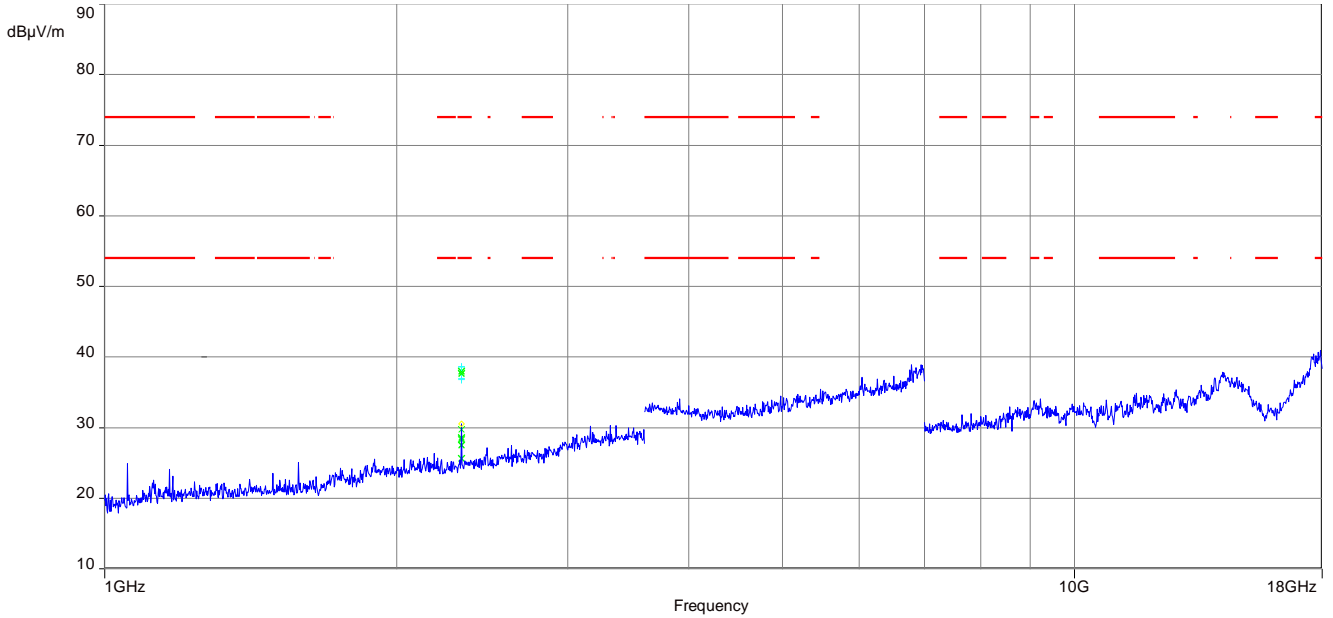

**Plot 2:** 18 GHz to 26 GHz, RX / idle – mode, vertical & horizontal polarization

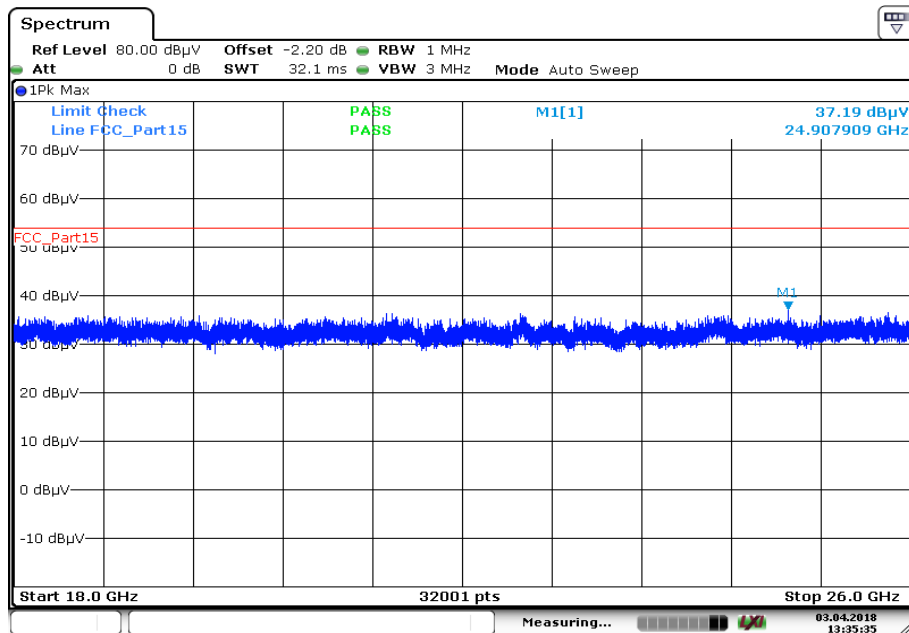

Date: 3.APR.2018 13:35:35

## 12 Observations

No observations except those reported with the single test cases have been made.

## Annex A Glossary

<b>EUT</b>	Equipment under test
<b>DUT</b>	Device under test
<b>UUT</b>	Unit under test
<b>GUE</b>	GNSS User Equipment
<b>ETSI</b>	European Telecommunications Standards Institute
<b>EN</b>	European Standard
<b>FCC</b>	Federal Communications Commission
<b>FCC ID</b>	Company Identifier at FCC
<b>IC</b>	Industry Canada
<b>PMN</b>	Product marketing name
<b>HMN</b>	Host marketing name
<b>HVIN</b>	Hardware version identification number
<b>FVIN</b>	Firmware version identification number
<b>EMC</b>	Electromagnetic Compatibility
<b>HW</b>	Hardware
<b>SW</b>	Software
<b>Inv. No.</b>	Inventory number
<b>S/N or SN</b>	Serial number
<b>C</b>	Compliant
<b>NC</b>	Not compliant
<b>NA</b>	Not applicable
<b>NP</b>	Not performed
<b>PP</b>	Positive peak
<b>QP</b>	Quasi peak
<b>AVG</b>	Average
<b>OC</b>	Operating channel
<b>OCW</b>	Operating channel bandwidth
<b>OBW</b>	Occupied bandwidth
<b>OOB</b>	Out of band
<b>DFS</b>	Dynamic frequency selection
<b>CAC</b>	Channel availability check
<b>OP</b>	Occupancy period
<b>NOP</b>	Non occupancy period
<b>DC</b>	Duty cycle
<b>PER</b>	Packet error rate
<b>CW</b>	Clean wave
<b>MC</b>	Modulated carrier
<b>WLAN</b>	Wireless local area network
<b>RLAN</b>	Radio local area network
<b>DSSS</b>	Dynamic sequence spread spectrum
<b>OFDM</b>	Orthogonal frequency division multiplexing
<b>FHSS</b>	Frequency hopping spread spectrum
<b>GNSS</b>	Global Navigation Satellite System
<b>C/N<sub>0</sub></b>	Carrier to noise-density ratio, expressed in dB-Hz



**Annex B Document history**

Version	Applied changes	Date of release
-/-	Initial release	2018-05-02

**Annex C Accreditation Certificate**

first page	last page
 <p>Deutsche Akkreditierungsstelle GmbH</p> <p>Entrusted according to Section 8 subsection 1 AkkStelleG in connection with Section 1 subsection 1 AkkStelleGBV Signatory to the Multilateral Agreements of EA, ILAC and IAF for Mutual Recognition</p> <p><b>Accreditation</b> </p> <p>The Deutsche Akkreditierungsstelle GmbH attests that the testing laboratory <b>CTC advanced GmbH</b> Untertürkheimer Straße 6-10, 66117 Saarbrücken</p> <p>is competent under the terms of DIN EN ISO/IEC 17025:2005 to carry out tests in the following fields: <b>Telecommunication</b></p> <p>The accreditation certificate shall only apply in connection with the notice of accreditation of 02.06.2017 with the accreditation number D-PL-12076-01 and is valid until 21.04.2021. It comprises the cover sheet, the reverse side of the cover sheet and the following annex with a total of 43 pages.</p> <p>Registration number of the certificate: D-PL-12076-01-03</p> <p>Frankfurt, 02.06.2017</p> <p> Dipl.-Ing. (FH) Ralf Böker Head of Division</p> <p>See notes enclosed.</p>	<p>Deutsche Akkreditierungsstelle GmbH</p> <p>Office Berlin Spittelmarkt 10 10117 Berlin</p> <p>Office Frankfurt am Main Europa-Allee 52 60327 Frankfurt am Main</p> <p>Office Braunschweig Bundesallee 100 38116 Braunschweig</p> <p>The publication of extracts of the accreditation certificate is subject to the prior written approval by Deutsche Akkreditierungsstelle GmbH (DAkks). Exempted is the unchanged form of separate disseminations of the cover sheet by the conformity assessment body mentioned overleaf.</p> <p>No impression shall be made that the accreditation also extends to fields beyond the scope of accreditation attested by DAkks.</p> <p>The accreditation was granted pursuant to the Act on the Accreditation Body (AkkStelleG) of 31 July 2009 (Federal Law Gazette I p. 2625) and the Regulation (EC) No 765/2008 of the European Parliament and of the Council of 9 July 2008 setting out the requirements for accreditation and market surveillance relating to the marketing of products (Official Journal of the European Union L 218 of 9 July 2008, p. 30). DAkks is a signatory to the Multilateral Agreements for Mutual Recognition of the European co-operation for Accreditation (EA), International Accreditation Forum (IAF) and International Laboratory Accreditation Cooperation (ILAC). The signatories to these agreements recognise each other's accreditations.</p> <p>The up-to-date state of membership can be retrieved from the following websites: EA: <a href="http://www.european-accreditation.org">www.european-accreditation.org</a> ILAC: <a href="http://www.ilac.org">www.ilac.org</a> IAF: <a href="http://www.iaf.nu">www.iaf.nu</a></p>

**Note: The current certificate annex is published on the website (link see below) of the Accreditation Body DAkks or may be received by CTC advanced GmbH on request**

<http://www.dakks.de/as/ast/d/D-PL-12076-01-03.pdf>