



TEST REPORT

BNetzA-CAB-02/21-102

Test report no.: 1-5003_22-01-11-A

Testing laboratory

cetecom advanced GmbH
Untertuerkheimer Strasse 6 – 10
66117 Saarbruecken / Germany
Phone: + 49 681 5 98 - 0
Fax: + 49 681 5 98 - 9075
Internet: <https://cetecomadvanced.com>
e-mail: mail@cetecomadvanced.com

Accredited Testing Laboratory:

The testing laboratory (area of testing) is accredited according to DIN EN ISO/IEC 17025 (2018-03) by the Deutsche Akkreditierungsstelle GmbH (DAkkS).

The accreditation is valid for the scope of testing procedures as stated in the accreditation certificate with the registration number: D-PL-12047-01-00.

ISED Testing Laboratory Recognized Listing Number: DE0001
FCC designation number: DE0002

Applicant

Continental Automotive Technologies GmbH
Heinrich-Hertz-Str. 45
78052 Villingen-Schwenningen / GERMANY
Phone: +49 7721 67-0
Contact: Marion Grüner
e-mail: Marion.Gruener@continental-corporation.com

Manufacturer

Continental Automotive Technologies GmbH
Heinrich-Hertz-Str. 45
78052 Villingen-Schwenningen / GERMANY

Test standard/s

FCC - Title 47 CFR Part 22 FCC - Title 47 of the Code of Federal Regulations; Chapter I; Part 22 - Public mobile services

FCC - Title 47 CFR Part 24 FCC - Title 47 of the Code of Federal Regulations; Chapter I; Part 24 - Personal communications services

For further applied test standards please refer to section 3 of this test report.

Test Item

Kind of test item: **Access and Connected Car Module**

Model name: **ACCM6.1**

FCC ID: **2AJW5ACCM1**

ISED certification number: **21979-ACCM1**

Frequency: GSM850; PCS1900; WCDMA band 2 and 5; LTE band 2, 4, 5, 12, 13 and 26

Technology tested: GSM, UMTS, LTE

Antenna: Internal antenna

Power supply: 12 V DC by external power supply

Temperature range: -40°C to +80°C

This test report is electronically signed and valid without handwritten signature. For verification of the electronic signatures, the public keys can be requested at the testing laboratory.

Test report authorized:

Marco Bertolino
Supervisor Radio Services
Radio Labs

Test performed:

Rene Oelmann
Lab Manager
Radio Labs

1 Table of contents

1	Table of contents.....	2
2	General information.....	4
2.1	Notes and disclaimer	4
2.2	Application details	4
2.3	Test laboratories sub-contracted	4
3	Test standard/s, references and accreditations	5
4	Reporting statements of conformity – decision rule	6
5	Test environment.....	7
6	Test item	7
6.1	General description	7
6.2	Additional information	7
7	Description of the test setup.....	8
7.1	Shielded semi anechoic chamber	9
7.2	Shielded fully anechoic chamber.....	10
7.3	Radiated measurements > 18 GHz	11
8	Sequence of testing.....	12
8.1	Sequence of testing radiated spurious 9 kHz to 30 MHz	12
8.2	Sequence of testing radiated spurious 30 MHz to 1 GHz.....	13
8.3	Sequence of testing radiated spurious 1 GHz to 18 GHz.....	14
8.4	Sequence of testing radiated spurious above 18 GHz.....	15
9	Measurement uncertainty.....	16
10	Summary of measurement results	17
10.1	GSM 850.....	17
10.2	PCS 1900.....	17
10.3	UMTS band II.....	18
10.4	UMTS band V.....	18
11	Results GSM 850	19
11.1	RF output power	19
11.2	Spurious emissions radiated	21
12	Results PCS 1900	27
12.1	RF output power	27
12.2	Spurious emissions radiated	29
13	Results UMTS band II.....	35
13.1	Spurious emissions radiated	35
14	Results UMTS band V	40
14.1	Spurious emissions radiated	40
15	Summary of measurement results LTE band 2	44

15.1	LTE – Band 2	44
16	RF measurements LTE band 2	45
16.1	Description of test setup.....	45
16.2	Results	45
16.2.1	Spurious emissions radiated.....	45
17	Summary of measurement results LTE band 5; LTE band 26a	49
17.1	LTE – Band 5	49
17.2	LTE – Band 26a	50
18	RF measurements LTE band 5	51
18.1	Description of test setup.....	51
18.2	Results	51
18.2.1	Spurious emissions radiated.....	51
19	RF measurements LTE band 26a	55
19.1	Description of test setup.....	55
19.2	Results	55
19.2.1	Spurious emissions radiated.....	55
20	Summary of measurement results LTE band 4; 12; 13.....	59
20.1	LTE – Band 4	59
20.2	LTE – Band 12	60
20.3	LTE – Band 13	60
21	RF measurements	61
21.1	Description of test setup.....	61
21.2	Results LTE – Band 4	61
21.2.1	Spurious emissions radiated.....	61
21.3	Results LTE – Band 12	65
21.3.1	Spurious emissions radiated.....	65
21.4	Results LTE – Band 13	69
21.4.1	Spurious emissions radiated.....	69
22	Glossary	73
23	Document history.....	74

2 General information

2.1 Notes and disclaimer

The test results of this test report relate exclusively to the test item specified in this test report. cetecom advanced GmbH does not assume responsibility for any conclusions and generalizations drawn from the test results with regard to other specimens or samples of the type of the equipment represented by the test item.

The test report may only be reproduced or published in full. Reproduction or publication of extracts from the report requires the prior written approval of cetecom advanced GmbH.

The testing service provided by cetecom advanced GmbH has been rendered under the current "General Terms and Conditions for cetecom advanced GmbH".

cetecom advanced GmbH will not be liable for any loss or damage resulting from false, inaccurate, inappropriate or incomplete product information provided by the customer.

Under no circumstances does the cetecom advanced GmbH test report include any endorsement or warranty regarding the functionality, quality or performance of any other product or service provided.

Under no circumstances does the cetecom advanced GmbH test report include or imply any product or service warranties from cetecom advanced GmbH, including, without limitation, any implied warranties of merchantability, fitness for purpose, or non-infringement, all of which are expressly disclaimed by cetecom advanced GmbH.

All rights and remedies regarding vendor's products and services for which cetecom advanced GmbH has prepared this test report shall be provided by the party offering such products or services and not by cetecom advanced GmbH.

In no case this test report can be considered as a Letter of Approval.

This test report is electronically signed and valid without handwritten signature. For verification of the electronic signatures, the public keys can be requested at the testing laboratory.

This test report replaces the test report with the number 1-5003_22-01-11 and dated 2024-01-08.

2.2 Application details

Date of receipt of order:	2022-12-06
Date of receipt of test item:	2023-07-04
Start of test:*	2023-07-04
End of test:*	2023-07-20
Person(s) present during the test:	-/-

*Date of each measurement, if not shown in the plot, can be requested. Dates are stored in the measurement software.

2.3 Test laboratories sub-contracted

None

3 Test standard/s, references and accreditations

Test standard	Date	Description
FCC - Title 47 CFR Part 22	-/-	FCC - Title 47 of the Code of Federal Regulations; Chapter I; Part 22 - Public mobile services
FCC - Title 47 CFR Part 24	-/-	FCC - Title 47 of the Code of Federal Regulations; Chapter I; Part 24 - Personal communications services
FCC - Title 47 CFR Part 27	-/-	FCC - Title 47 of the Code of Federal Regulations; Chapter I; Part 27 - Miscellaneous wireless communications services
RSS - 132 Issue 3	January 2013	Spectrum Management and Telecommunications Radio Standards Specification - Cellular Telephone Systems Operating in the Bands 824-849 MHz and 869-894 MHz
RSS - 133 Issue 6	January 2018	Spectrum Management and Telecommunications Policy - Radio Standards Specifications, 2 GHz Personal Communication Services
RSS – 139 Issue 3	July 2015	Spectrum Management and Telecommunications Radio Standards Specification – Advanced Wireless Services (AWS) Equipment Operating in the Bands 1710-1755 MHz and 2110-2180 MHz
Guidance	Version	Description
ANSI C63.4-2014	-/-	American National Standard for Methods of Measurement of Radio-Noise Emissions from Low-Voltage Electrical and Electronic Equipment in the Range of 9 kHz to 40 GHz
ANSI C63.26-2015	-/-	American National Standard for Compliance Testing of Transmitters Used in Licensed Radio Services
Power Meas. License Systems: KDB 971168 D01	v03r01	Measurement Guidance for Certification of Licensed Digital Transmitters

4 Reporting statements of conformity – decision rule

Only the measured values related to their corresponding limits will be used to decide whether the equipment under test meets the requirements of the test standards listed in chapter 3. The measurement uncertainty is mentioned in this test report, see chapter 9, but is not taken into account - neither to the limits nor to the measurement results. Measurement results with a smaller margin to the corresponding limits than the measurement uncertainty have a potential risk of more than 5% that the decision might be wrong."

measured value, measurement uncertainty, verdict

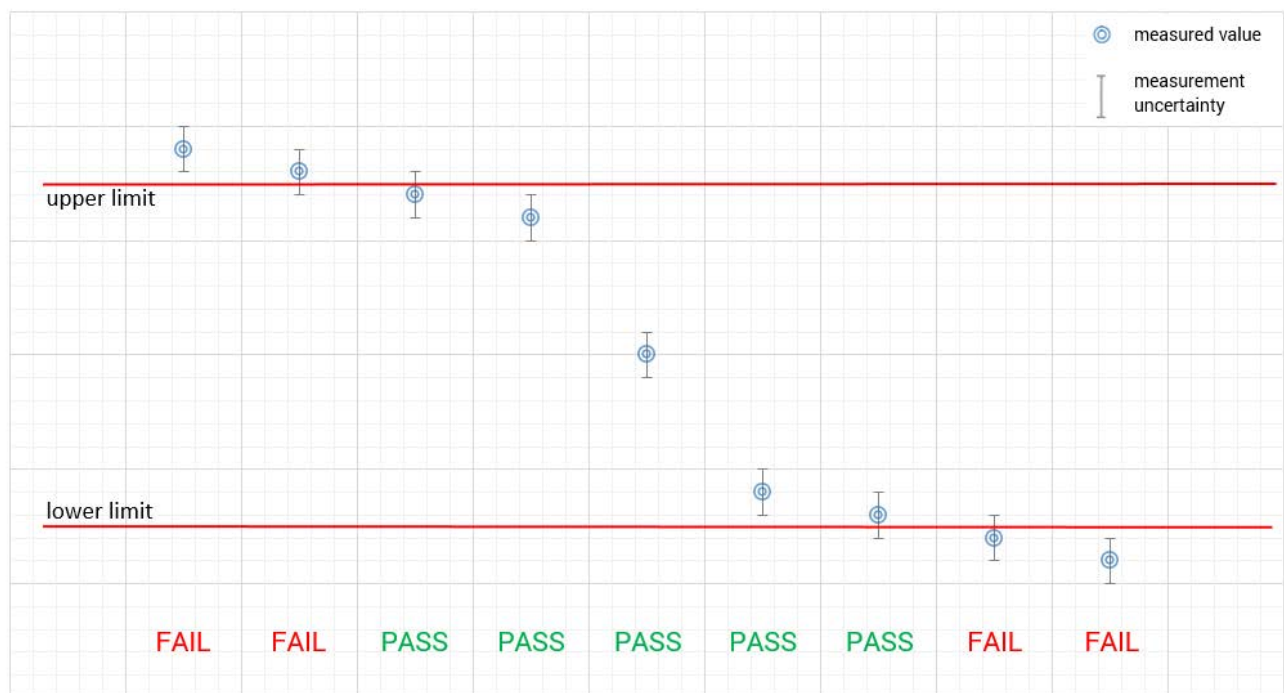

5 Test environment

Temperature	:	T_{nom} 25 °C during room temperature tests T_{max} No test under extreme temperature conditions performed. T_{min} No test under extreme temperature conditions performed.
Relative humidity content	:	42%
Barometric pressure	:	1016 hpa
Power supply	:	V_{nom} 12 V DC by external power supply V_{max} No test under extreme voltage conditions performed. V_{min} No test under extreme voltage conditions performed.

6 Test item

6.1 General description

Kind of test item	:	Access and Connected Car Module
Model name	:	ACCM6.1
Module / Chip-Set	:	U-blox LARA-R6001D-00B
HMN	:	-/-
PMN	:	ACCM
HVIN	:	ACCM6.1
FVIN	:	-/-
S/N serial number	:	Radiated unit: No S/N available IMEI: 35350072340365701
Hardware status	:	1
Software status	:	2
Firmware status	:	-/-
Frequency band	:	GSM850; PCS1900; WCDMA band 2 and 5; LTE band 2, 4, 5, 12, 13 and 26
Type of radio transmission	:	modulated carrier
Use of frequency spectrum	:	
Type of modulation	:	GMSK; QPSK
Antenna	:	Internal antenna
Power supply	:	12 V DC by external power supply
Temperature range	:	-40°C to +80°C

6.2 Additional information

The content of the following annexes is defined in the QA. It may be that not all of the listed annexes are necessary for this report, thus some values in between may be missing.

Test setup and EUT photos are included in test report:

- 1-5003_22-01-01_AnnexA
- 1-5003_22-01-01_AnnexB
- 1-5003_22-01-01_AnnexC

7 Description of the test setup

Typically, the calibrations of the test apparatus are commissioned to and performed by an accredited calibration laboratory. The calibration intervals are determined in accordance with the DIN EN ISO/IEC 17025. In addition to the external calibrations, the laboratory executes comparison measurements with other calibrated test systems or effective verifications. Weekly chamber inspections and range calibrations are performed. Where possible, RF generating and signaling equipment as well as measuring receivers and analyzers are connected to an external high-precision 10 MHz reference (GPS-based or rubidium frequency standard).

In order to simplify the identification of the equipment used at some special tests, some items of test equipment and ancillaries can be provided with an identifier or number in the equipment list below (Lab/Item).

Each block diagram listed can contain several test setup configurations. All devices belonging to a test setup are identified with the same letter syntax. For example: Column Setup and all devices with an A.

Agenda: Kind of Calibration

k	calibration / calibrated	EK	limited calibration
ne	not required (k, ev, izw, zw not required)	zw	cyclical maintenance (external cyclical maintenance)
ev	periodic self verification	izw	internal cyclical maintenance
Ve	long-term stability recognized	g	blocked for accredited testing
vlk!	Attention: extended calibration interval		
NK!	Attention: not calibrated	*)	next calibration ordered / currently in progress

7.1 Shielded semi anechoic chamber

The radiated measurements are performed in vertical and horizontal plane in the frequency range from 30 MHz to 1 GHz in semi-anechoic chambers. The EUT is positioned on a non-conductive support with a height of 0.80 m above a conductive ground plane that covers the whole chamber. The receiving antennas are conform to specifications ANSI C63. These antennas can be moved over the height range between 1.0 m and 4.0 m in order to search for maximum field strength emitted from EUT. The measurement distances between EUT and receiving antennas are indicated in the test setups for the various frequency ranges. For each measurement, the EUT is rotated in all three axes until the maximum field strength is received. The wanted and unwanted emissions are received by spectrum analyzers where the detector modes and resolution bandwidths over various frequency ranges are set according to requirement ANSI C63.

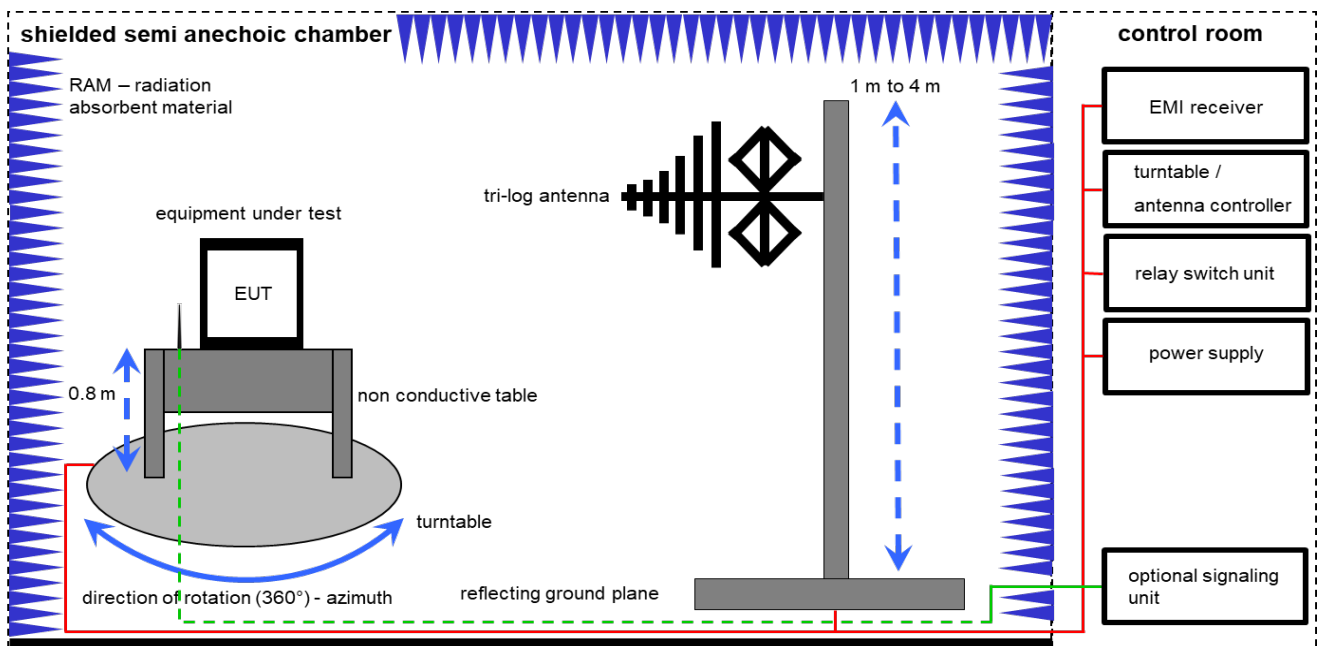

Measurement distance: tri-log antenna 10 meter; EMC32 software version: 10.59.00

FS = UR + CL + AF

(FS-field strength; UR-voltage at the receiver; CL-loss of the cable; AF-antenna factor)

Example calculation:

FS [dB μ V/m] = 12.35 [dB μ V/m] + 1.90 [dB] + 16.80 [dB/m] = 31.05 [dB μ V/m] (35.69 μ V/m)

Equipment table:

No.	Setup	Equipment	Type	Manufacturer	Serial No.	INV. No.	Kind of Calibration	Last Calibration	Next Calibration
1	A	Switch-Unit	3488A	HP	2719A14505	300000368	ev	-/-	-/-
2	A	DC power supply, 60Vdc, 50A, 1200 W	6032A	HP	2920A04466	300000580	ne	-/-	-/-
3	A	Semi anechoic chamber	3000023	MWB AG	-/-	300000551	ne	-/-	-/-
4	A	Antenna Tower	Model 2175	ETS-Lindgren	64762	300003745	izw	-/-	-/-
5	A	Positioning Controller	Model 2090	ETS-Lindgren	64672	300003746	izw	-/-	-/-
6	A	Turntable Interface-Box	Model 105637	ETS-Lindgren	44583	300003747	izw	-/-	-/-
7	A	TRILOG Broadband Test-Antenna 30 MHz - 3 GHz	VULB9163	Schwarzbeck Mess - Elektronik	318	300003696	vKII	30.09.2021	29.09.2023
8	A	Turntable	2089-4.0	EMCO	-/-	300004394	ne	-/-	-/-
9	A	PC	TecLine	F+W	-/-	300004388	ne	-/-	-/-
10	A	EMI Test Receiver	ESR3	Rohde & Schwarz	102587	300005771	k	09.12.2022	31.12.2023
11	A	Universal Radio Communication Tester	CMU200	R&S	106826	300003346	NK!	-/-	-/-
12	A	Wideband Radio Communication Tester	CMW500	Rohde & Schwarz	170616	300006251	k	16.09.2021	30.09.2023

7.2 Shielded fully anechoic chamber

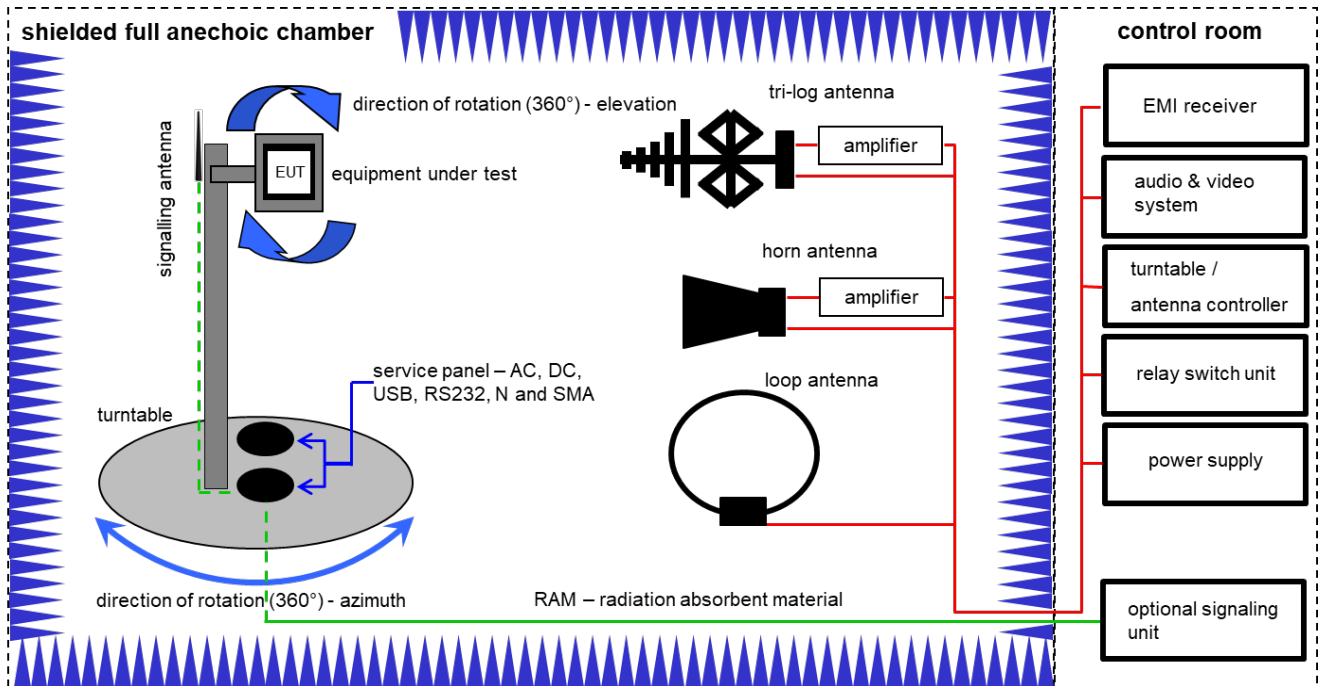

Measurement distance: tri-log antenna and horn antenna 3 meter; loop antenna 3 meter

$$OP = AV + D - G + CA$$

(OP-radiated output power; AV-analyzer value; D-free field attenuation of measurement distance; G-antenna gain+amplifier gain; CA-loss signal path)

Example calculation:

$$OP [dBm] = -65.0 [dBm] + 50 [dB] - 20 [dBi] + 5 [dB] = -30 [dBm] (1 \mu W)$$

Equipment table:

No.	Setup	Equipment	Type	Manufacturer	Serial No.	INV. No.	Kind of Calibration	Last Calibration	Next Calibration
1	A	Anechoic chamber	FAC 3/5m	MWB / TDK	87400/02	300000996	ev	-/-	-/-
2	A	Switch / Control Unit	3488A	HP	*	300000199	ne	-/-	-/-
3	A	Double-Ridged Waveguide Horn Antenna 1-18.0GHz	3115	EMCO	8812-3089	300000307	vKI!	11.02.2022	29.02.2024
4	A	Active Loop Antenna 9 kHz to 30 MHz	6502	EMCO	2210	300001015	vKI!	01.07.2021	31.07.2023
5	A	Band Reject filter	WRCG1850/1910-1835/1925-40/8SS	Wainwright	7	300003350	ev	-/-	-/-
6	A	EMI Test Receiver 20Hz-26,5GHz	ESU26	R&S	100037	300003555	k	07.12.2022	31.12.2023
7	A	Highpass Filter	WHK1.1/15G-10SS	Wainwright	3	300003255	ev	-/-	-/-
8	A	Highpass Filter	WHKX7.0/18G-8SS	Wainwright	19	300003790	ne	-/-	-/-
9	A	TRILOG Broadband Test-Antenna 30 MHz - 3 GHz	VULB9163	Schwarzbeck Mess - Elektronik	371	300003854	vKI!	04.02.2022	29.02.2024
10	A	High Pass Filter	VHF-3500+	Mini Circuits	-/-	400000193	ne	-/-	-/-
11	A	Broadband Amplifier 0.5-18 GHz	CBLU5184540	CERNEX	22049	300004481	ev	-/-	-/-
12	A	4U RF Switch Platform	L4491A	Agilent Technologies	MY50000037	300004509	ne	-/-	-/-
13	A	NEXIO EMV-Software	BAT EMC V2022.0.22.0	Nexio	-/-	300004682	ne	-/-	-/-
14	A	Universal Radio Communication Tester	CMU200	R&S	106826	300003346	NK!	-/-	-/-
15	A	Wideband Radio Communication Tester	CMW500	Rohde & Schwarz	170616	300006251	k	16.09.2021	30.09.2023

7.3 Radiated measurements > 18 GHz

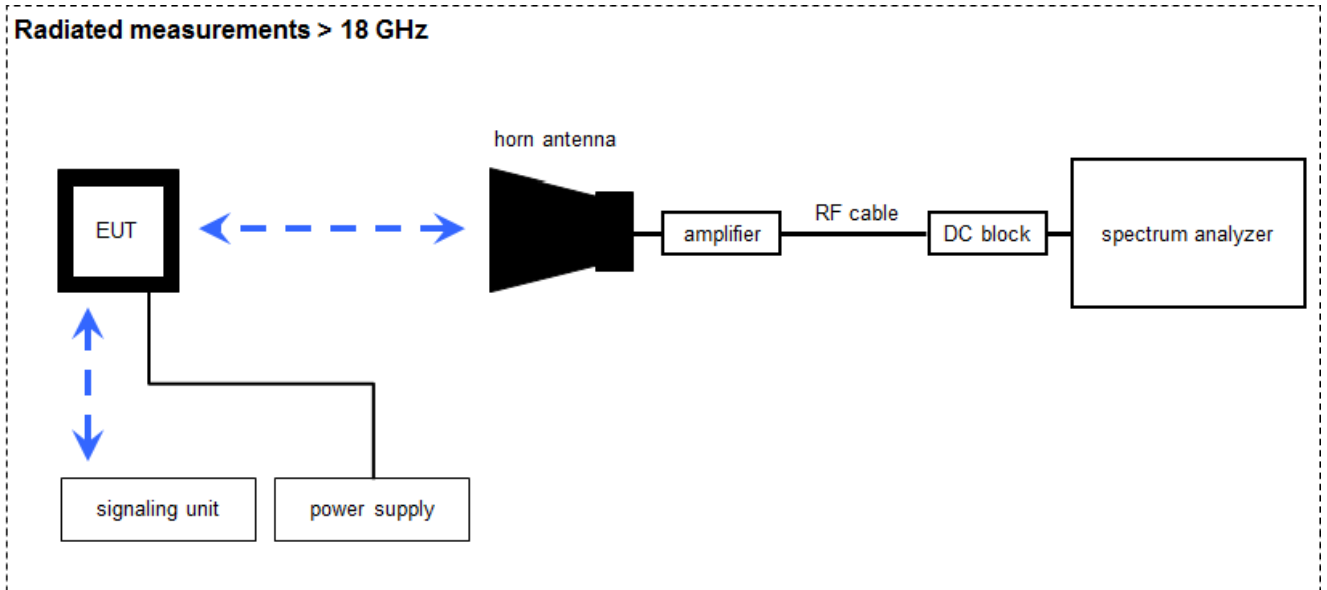

Measurement distance: horn antenna 50 cm

$$OP = AV + D - G + CA$$

(OP-radiated output power; AV-analyzer value; D-free field attenuation of measurement distance; G-antenna gain+amplifier gain; CA-loss signal path)

Example calculation:

$$OP [dBm] = -59.0 [dBm] + 44.0 [dB] - 20.0 [dBi] + 5.0 [dB] = -30 [dBm] (1 \mu W)$$

Equipment table:

No.	Setup	Equipment	Type	Manufacturer	Serial No.	INV. No.	Kind of Calibration	Last Calibration	Next Calibration
1	A	Microwave System Amplifier, 0.5-26.5 GHz	83017A	HP	00419	300002268	ev	-/-	-/-
2	A	Std. Gain Horn Antenna 18.0-26.5 GHz	638	Narda	01096	300000486	vIK!	17.01.2022	31.01.2024
3	A	RF-Cable	ST18/SMAm/SMAm/48	Huber & Suhner	Batch no. 600918	400001182	ev	-/-	-/-
4	A	Signal analyzer	FSV40	Rohde&Schwarz	101042	300004517	k	12.12.2022	31.12.2023
5	A	DC-Blocker	WA7046	Weinschel Associates	-/-	400001310	ev	-/-	-/-
6	A	Universal Radio Communication Tester	CMU200	R&S	106826	300003346	NK!	-/-	-/-
7	A	Wideband Radio Communication Tester	CMW500	Rohde & Schwarz	170616	300006251	k	16.09.2021	30.09.2023

8 Sequence of testing

8.1 Sequence of testing radiated spurious 9 kHz to 30 MHz

Setup

- The equipment is set up to simulate normal operation mode as described in the user manual or defined by the manufacturer.
- If the EUT is a tabletop system, it is placed on a table with 0.8 m height.
- If the EUT is a floor standing device, it is placed directly on the turn table.
- Auxiliary equipment and cables are positioned to simulate normal operation conditions as described in ANSI C 63.4.
- The AC power port of the EUT (if available) is connected to a power outlet below the turntable.
- Measurement distance is 3 m (see ANSI C 63.4) – see test details.
- EUT is set into operation.

Premeasurement*

- The turntable rotates from 0° to 315° using 45° steps.
- The antenna height is 1 m.
- At each turntable position the analyzer sweeps with positive-peak detector to find the maximum of all emissions.

Final measurement

- Identified emissions during the pre-measurement are maximized by the software by rotating the turntable from 0° to 360°.
- Loop antenna is rotated about its vertical axis for maximum response at each azimuth about the EUT. (For certain applications, the loop antenna plane may also need to be positioned horizontally at the specified distance from the EUT)
- The final measurement is done in the position (turntable and elevation) causing the highest emissions with quasi-peak (as described in ANSI C 63.4).
- Final levels, frequency, measuring time, bandwidth, turntable position, correction factor, margin to the limit and limit will be recorded. A plot with the graph of the premeasurement and the limit is stored.

*Note: The sequence will be repeated three times with different EUT orientations.

8.2 Sequence of testing radiated spurious 30 MHz to 1 GHz

Setup

- The equipment is set up to simulate normal operation mode as described in the user manual or defined by the manufacturer.
- If the EUT is a tabletop system, a table with 0.8 m height is used, which is placed on the ground plane.
- If the EUT is a floor standing device, it is placed on the ground plane with insulation between both.
- Auxiliary equipment and cables are positioned to simulate normal operation conditions as described in ANSI C 63.4.
- The AC power port of the EUT (if available) is connected to a power outlet below the turntable.
- Measurement distance is 10 m or 3 m (see ANSI C 63.4) – see test details.
- EUT is set into operation.

Premeasurement

- The turntable rotates from 0° to 315° using 45° steps.
- The antenna is polarized vertical and horizontal.
- The antenna height changes from 1 m to 3 m.
- At each turntable position, antenna polarization and height the analyzer sweeps three times in peak to find the maximum of all emissions.

Final measurement

- The final measurement is performed for at least six highest peaks according to the requirements of the ANSI C63.4.
- Based on antenna and turntable positions at which the peak values are measured the software maximize the peaks by changing turntable position $\pm 45^\circ$ and antenna height between 1 and 4 m.
- The final measurement is done with quasi-peak detector (as described in ANSI C 63.4).
- Final levels, frequency, measuring time, bandwidth, antenna height, antenna polarization, turntable angle, correction factor, margin to the limit and limit are recorded. A plot with the graph of the premeasurement with marked maximum final results and the limit is stored.

8.3 Sequence of testing radiated spurious 1 GHz to 18 GHz

Setup

- The equipment is set up to simulate normal operation mode as described in the user manual or defined by the manufacturer.
- If the EUT is a tabletop system, a 2-axis positioner with 1.5 m height is used.
- If the EUT is a floor standing device, it is placed directly on the turn table.
- Auxiliary equipment and cables are positioned to simulate normal operation conditions as described in ANSI C 63.4.
- The AC power port of the EUT (if available) is connected to a power outlet below the turntable.
- Measurement distance is 3 m (see ANSI C 63.4) – see test details.
- EUT is set into operation.

Premeasurement

- The turntable rotates from 0° to 315° using 45° steps.
- The antenna is polarized vertical and horizontal.
- The antenna height is 1.5 m.
- At each turntable position and antenna polarization the analyzer sweeps with positive peak detector to find the maximum of all emissions.

Final measurement

- The final measurement is performed for at least six highest peaks according to the requirements of the ANSI C63.4.
- Based on antenna and turntable positions at which the peak values are measured the software maximizes the peaks by rotating the turntable from 0° to 360°. This measurement is repeated for different EUT-table positions (0° to 150° in 30°-steps) and for both antenna polarizations.
- The final measurement is done in the position (turntable, EUT-table and antenna polarization) causing the highest emissions with Peak and RMS detector (as described in ANSI C 63.4).
- Final levels, frequency, measuring time, bandwidth, turntable position, EUT-table position, antenna polarization, correction factor, margin to the limit and limit are recorded. A plot with the graph of the premeasurement with marked maximum final results and the limit is stored.

8.4 Sequence of testing radiated spurious above 18 GHz

Setup

- The equipment is set up to simulate normal operation mode as described in the user manual or defined by the manufacturer.
- Auxiliary equipment and cables are positioned to simulate normal operation conditions as described in ANSI C 63.4.
- The AC power port of the EUT (if available) is connected to a power outlet.
- The measurement distance is as appropriate (e.g. 0.5 m).
- The EUT is set into operation.

Premeasurement

- The test antenna is handheld and moved carefully over the EUT to cover the EUT's whole sphere and different polarizations of the antenna.

Final measurement

- The final measurement is performed at the position and antenna orientation causing the highest emissions with Peak and RMS detector (as described in ANSI C 63.4).
- Final levels, frequency, measuring time, bandwidth, correction factor, margin to the limit and limit are recorded. A plot with the graph of the premeasurement and the limit is stored.

9 Measurement uncertainty

Measurement uncertainty	
Test case	Uncertainty
RF output power conducted	± 1 dB
RF output power radiated	± 3 dB
Frequency stability	± 20 Hz
Spurious emissions radiated below 30 MHz	± 3 dB
Spurious emissions radiated 30 MHz to 1 GHz	± 3 dB
Spurious emissions radiated 1 GHz to 12.75 GHz	± 3.7 dB
Spurious emissions radiated above 12.75 GHz	± 4.5 dB
Spurious emissions conducted	± 3 dB
Block edge compliance	± 3 dB
Occupied bandwidth	\pm RBW

10 Summary of measurement results

<input type="checkbox"/>	No deviations from the technical specifications were ascertained
<input type="checkbox"/>	There were deviations from the technical specifications ascertained
<input checked="" type="checkbox"/>	This test report is only a partial test report. The content and verdict of the performed test cases are listed below.

TC identifier	Description	verdict	date	Remark
RF-Testing	CFR Part 22, 24, 27 RSS 132, 133, 139	See table!	2024-02-02	Delta tests according to manufacturer demand!

10.1 GSM 850

Test Case	temperature conditions	power source voltages	C	NC	NA	NP	Remark
RF Output Power	Nominal	Nominal	<input checked="" type="checkbox"/>	<input type="checkbox"/>	<input type="checkbox"/>	<input type="checkbox"/>	Partial tests
Frequency Stability	Nominal and Extreme	Nominal and Extreme	<input type="checkbox"/>	<input type="checkbox"/>	<input type="checkbox"/>	<input checked="" type="checkbox"/>	-/-
Spurious Emissions Radiated	Nominal	Nominal	<input checked="" type="checkbox"/>	<input type="checkbox"/>	<input type="checkbox"/>	<input type="checkbox"/>	Partial tests
Spurious Emissions Conducted	Nominal	Nominal	<input type="checkbox"/>	<input type="checkbox"/>	<input type="checkbox"/>	<input checked="" type="checkbox"/>	-/-
Block Edge Compliance	Nominal	Nominal	<input type="checkbox"/>	<input type="checkbox"/>	<input type="checkbox"/>	<input checked="" type="checkbox"/>	-/-
Occupied Bandwidth	Nominal	Nominal	<input type="checkbox"/>	<input type="checkbox"/>	<input type="checkbox"/>	<input checked="" type="checkbox"/>	-/-

Note: C = Compliant; NC = Not compliant; NA = Not applicable; NP = Not performed

10.2 PCS 1900

Test Case	temperature conditions	power source voltages	C	NC	NA	NP	Remark
RF Output Power	Nominal	Nominal	<input checked="" type="checkbox"/>	<input type="checkbox"/>	<input type="checkbox"/>	<input type="checkbox"/>	Partial tests
Frequency Stability	Nominal and Extreme	Nominal and Extreme	<input type="checkbox"/>	<input type="checkbox"/>	<input type="checkbox"/>	<input checked="" type="checkbox"/>	-/-
Spurious Emissions Radiated	Nominal	Nominal	<input checked="" type="checkbox"/>	<input type="checkbox"/>	<input type="checkbox"/>	<input type="checkbox"/>	Partial tests
Spurious Emissions Conducted	Nominal	Nominal	<input type="checkbox"/>	<input type="checkbox"/>	<input type="checkbox"/>	<input checked="" type="checkbox"/>	-/-
Block Edge Compliance	Nominal	Nominal	<input type="checkbox"/>	<input type="checkbox"/>	<input type="checkbox"/>	<input checked="" type="checkbox"/>	-/-
Occupied Bandwidth	Nominal	Nominal	<input type="checkbox"/>	<input type="checkbox"/>	<input type="checkbox"/>	<input checked="" type="checkbox"/>	-/-

Note: C = Compliant; NC = Not compliant; NA = Not applicable; NP = Not performed

10.3 UMTS band II

Test Case	temperature conditions	power source voltages	C	NC	NA	NP	Remark
RF Output Power	Nominal	Nominal	<input type="checkbox"/>	<input type="checkbox"/>	<input type="checkbox"/>	<input checked="" type="checkbox"/>	-/-
Frequency Stability	Nominal	Nominal	<input type="checkbox"/>	<input type="checkbox"/>	<input type="checkbox"/>	<input checked="" type="checkbox"/>	-/-
Spurious Emissions Radiated	Nominal	Nominal	<input checked="" type="checkbox"/>	<input type="checkbox"/>	<input type="checkbox"/>	<input type="checkbox"/>	Partial tests
Spurious Emissions Conducted	Nominal	Nominal	<input type="checkbox"/>	<input type="checkbox"/>	<input type="checkbox"/>	<input checked="" type="checkbox"/>	-/-
Block Edge Compliance	Nominal	Nominal	<input type="checkbox"/>	<input type="checkbox"/>	<input type="checkbox"/>	<input checked="" type="checkbox"/>	-/-
Occupied Bandwidth	Nominal	Nominal	<input type="checkbox"/>	<input type="checkbox"/>	<input type="checkbox"/>	<input checked="" type="checkbox"/>	-/-

Note: C = Compliant; NC = Not compliant; NA = Not applicable; NP = Not performed

10.4 UMTS band V

Test Case	temperature conditions	power source voltages	C	NC	NA	NP	Remark
RF Output Power	Nominal	Nominal	<input type="checkbox"/>	<input type="checkbox"/>	<input type="checkbox"/>	<input checked="" type="checkbox"/>	-/-
Frequency Stability	Nominal	Nominal	<input type="checkbox"/>	<input type="checkbox"/>	<input type="checkbox"/>	<input checked="" type="checkbox"/>	-/-
Spurious Emissions Radiated	Nominal	Nominal	<input checked="" type="checkbox"/>	<input type="checkbox"/>	<input type="checkbox"/>	<input type="checkbox"/>	Partial tests
Spurious Emissions Conducted	Nominal	Nominal	<input type="checkbox"/>	<input type="checkbox"/>	<input type="checkbox"/>	<input checked="" type="checkbox"/>	-/-
Block Edge Compliance	Nominal	Nominal	<input type="checkbox"/>	<input type="checkbox"/>	<input type="checkbox"/>	<input checked="" type="checkbox"/>	-/-
Occupied Bandwidth	Nominal	Nominal	<input type="checkbox"/>	<input type="checkbox"/>	<input type="checkbox"/>	<input checked="" type="checkbox"/>	-/-

Note: C = Compliant; NC = Not compliant; NA = Not applicable; NP = Not performed

11 Results GSM 850

All GSM-band measurements are done in GSM mode only (circuit switched). All relevant tests have been repeated using 8-PSK modulation if EDGE mode is supported. All tests were performed with one timeslot in uplink activated and one timeslot in downlink activated. For each mode the highest output power was determined and used.

11.1 RF output power

Description:

This paragraph contains average power, peak output power, PAPR and ERP measurements for the mobile station.

The plots in this test report represents only an example of the measurements. All plots of this chapter are available on request.

The red line in the measurements indicates the ideal Gaussian distribution for the measured amplitude range.

Measurement:

The mobile was set up for the maximum output power with pseudo random data modulation.

To determine the Peak-To-Average Power Ratio (PAPR) the measurement was performed with the Power Complementary Cumulative Distribution Function (CCDF).

Measurement parameters	
Detector:	Sample
AQT:	See plot
Resolution bandwidth:	1 MHz
Used equipment:	See chapter 7.2 – A
Measurement uncertainty:	see chapter 9

Limits:

FCC	ISED
+38.45 dBm	
In measuring transmissions in this band using an average power technique, the peak-to-average ratio (PAR) of the transmission may not exceed 13 dB.	

Results:

Output Power (radiated) 8-PSK mode	
Frequency (MHz)	Average Output Power (dBm) - ERP
836.4	32.7

11.2 Spurious emissions radiated

Description:

The following steps outline the procedure used to measure the radiated emissions from the mobile station. The site is constructed in accordance with ANSI C63.4:2014 requirements and is recognized by the FCC to be in compliance for a 3 and a 10 meter site. The spectrum was scanned from 30 MHz to the 10th harmonic of the highest frequency generated within the equipment, which is the transmitted carrier that can be as high as 848.8 MHz. Measurements made up to 12.75 GHz. The resolution bandwidth is set as outlined in Part 22.917. The spectrum was scanned with the mobile station transmitting at carrier frequencies that pertain to low, mid and high channels of the GSM-850 band.

Measurement:

Measurement parameters	
Detector:	Peak
Sweep time:	2 s
Resolution bandwidth:	Below 1 GHz: 300 kHz Above 1 GHz: 3 MHz
Video bandwidth:	Below 1 GHz: 100 kHz Above 1 GHz: 1 MHz
Span:	100 MHz Steps
Trace mode:	Max Hold
Used equipment:	See chapter 7.1 – A and 7.2 – A
Measurement uncertainty:	See chapter 9

Limits:

FCC	ISED
Attenuation $\geq 43 + 10\log(P)$ (P, Power in Watts)	
-13 dBm	

Results GPRS & EGPRS:

Radiated emissions measurements were made only at the center carrier frequency of the GSM-850 band (836.4 MHz). The measurements shows the cabinet radiation in transmit mode. The antenna port can be terminated with 50 Ω .

Spurious emission level (dBm)								
Harmonic	Ch. 128 Freq. (MHz)	Level [dBm]	Harmonic	Ch. 189 Freq. (MHz)	Level [dBm]	Harmonic	Ch. 251 Freq. (MHz)	Level [dBm]
2	1648.4	-	2	1672.8	-13.9	2	1697.6	-
3	2472.6	-	3	2509.2	-30.6	3	2546.4	-
4	3296.8	-	4	3345.6	-35.2	4	3395.2	-
5	4121.0	-	5	4182.0	-	5	4244.0	-
6	4945.2	-	6	5018.4	-	6	5092.8	-
7	5769.4	-	7	5854.8	-	7	5941.6	-
8	6593.6	-	8	6691.2	-	8	6790.4	-
9	7417.8	-	9	7527.6	-	9	7639.2	-
10	8242.0	-	10	8364.0	-	10	8488.0	-

Plots: GMSK

Plot 1: Channel 189 (Traffic mode up to 30 MHz)

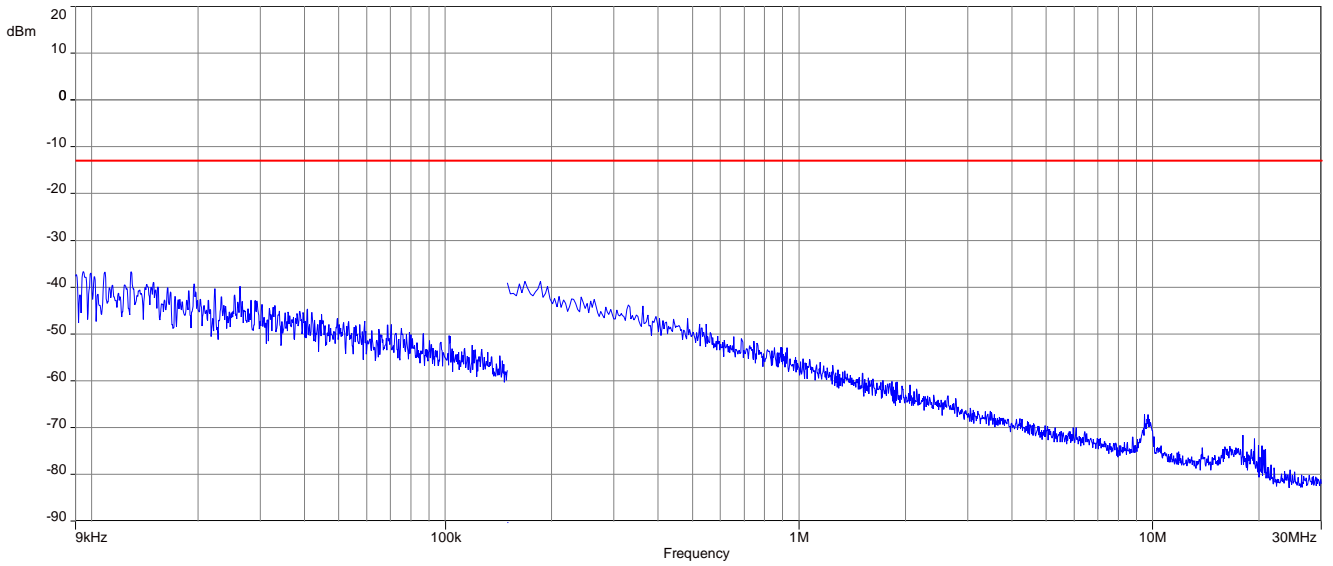

Plot 2: Channel 189 (30 MHz – 1 GHz)

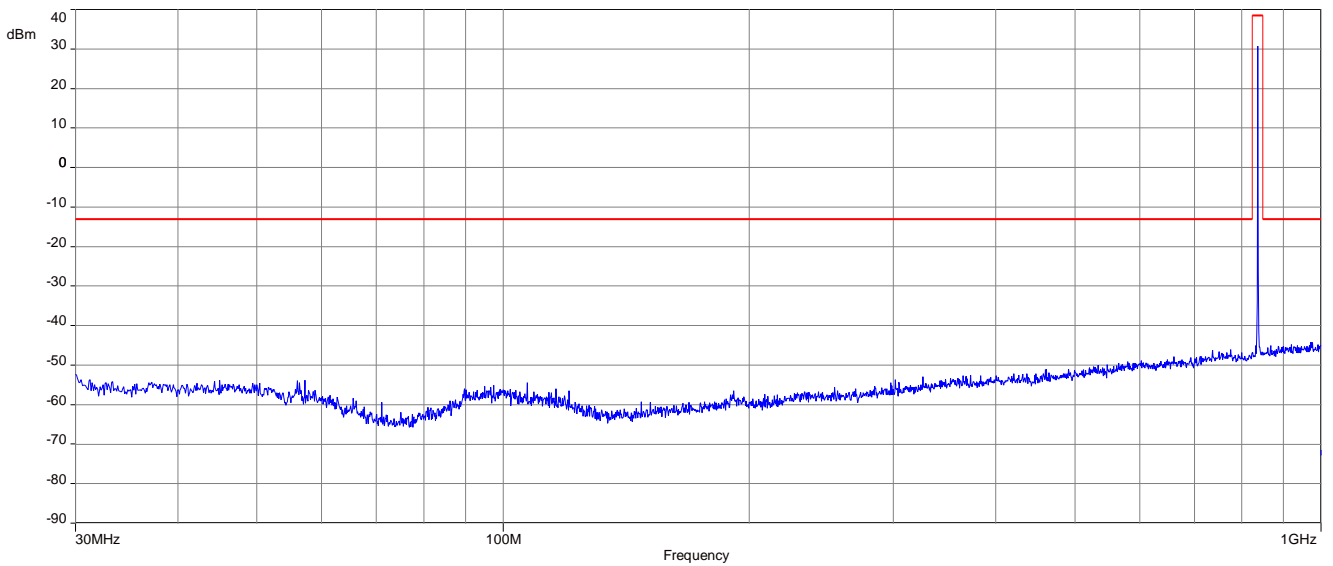

Plot 3: Channel 189 (1 GHz – 9 GHz)

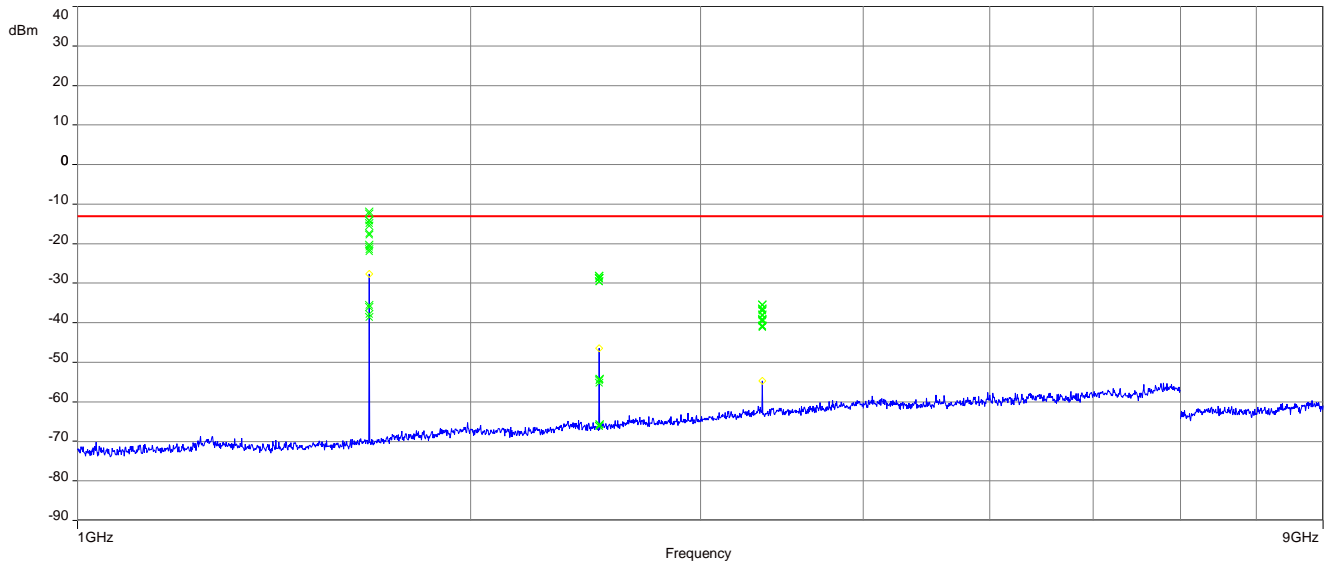

Plots: 8 PSK

Plot 1: Channel 189 (Traffic mode up to 30 MHz)

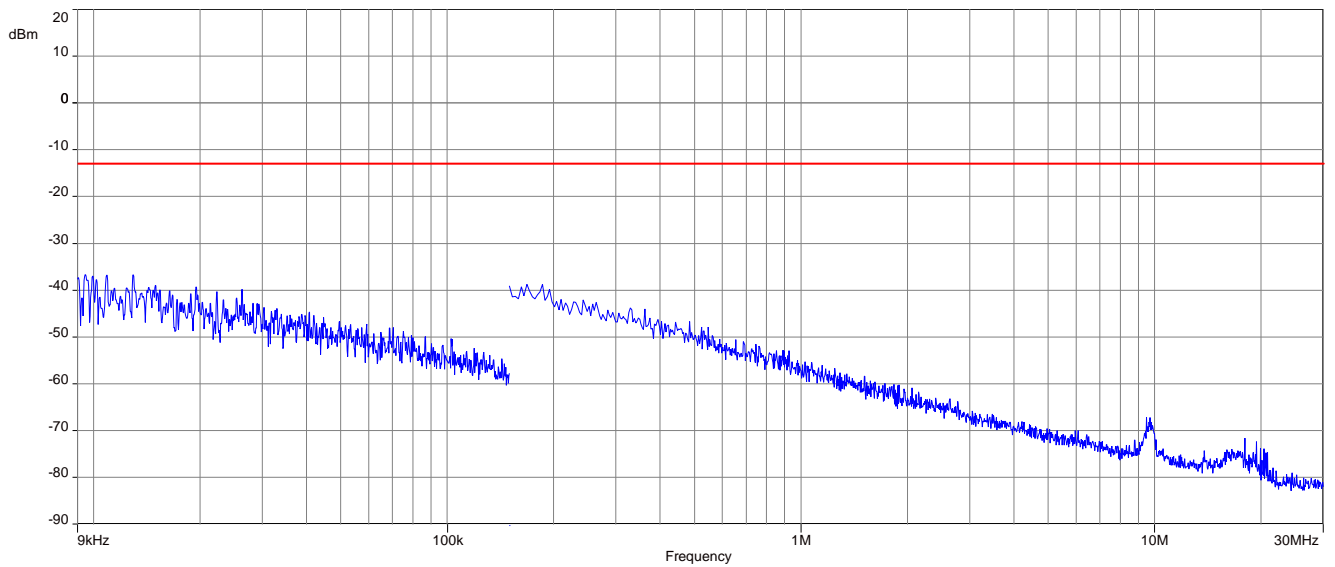

Plot 2: Channel 189 (30 MHz – 1 GHz)

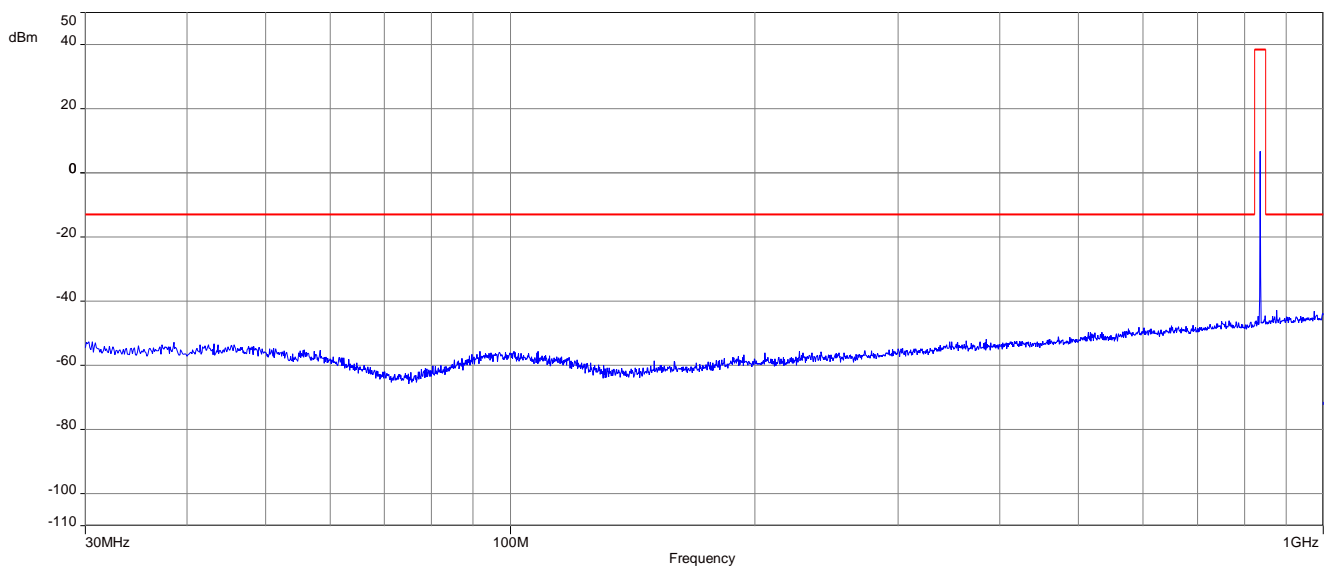

Plot 3: Channel 189 (1 GHz – 9 GHz)

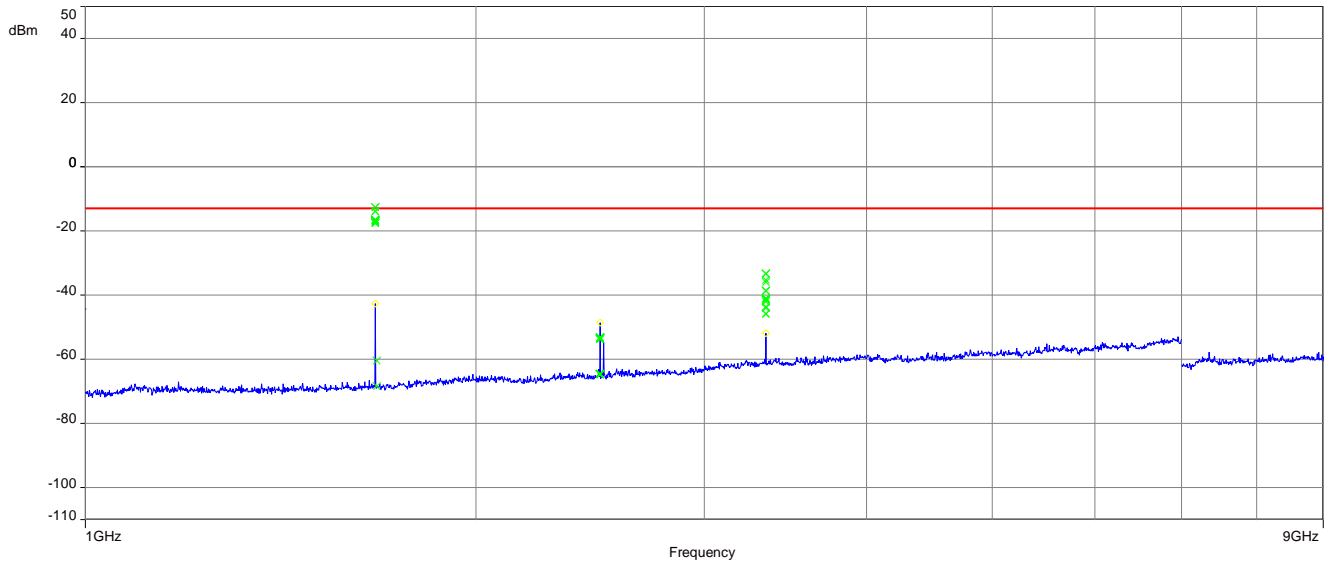

12 Results PCS 1900

All GSM-band measurements are done in GSM mode only (circuit switched). All relevant tests have been repeated using 8-PSK modulation if EDGE mode is supported. All tests were performed with one timeslot in uplink activated and one timeslot in downlink activated. For each mode the highest output power was determined and used.

12.1 RF output power

Description:

This paragraph contains average power, peak output power, PAPR and ERP measurements for the mobile station.

The plots in this test report represents only an example of the measurements. All plots of this chapter are available on request.

The red line in the measurements indicates the ideal Gaussian distribution for the measured amplitude range.

Measurement:

The mobile was set up for the maximum output power with pseudo random data modulation.

To determine the Peak-To-Average Power Ratio (PAPR) the measurement was performed with the Power Complementary Cumulative Distribution Function (CCDF).

Measurement parameters	
Detector:	Sample
AQT:	See plot
Resolution bandwidth:	1 MHz
Used equipment:	See chapter 7.4 – A
Measurement uncertainty:	See chapter 9

Limits:

FCC	ISED
+33.00 dBm	
In measuring transmissions in this band using an average power technique, the peak-to-average ratio (PAR) of the transmission may not exceed 13 dB.	

Results:

Output Power (radiated) 8-PSK mode	
Frequency (MHz)	Average Output Power (dBm) - EIRP
1880.0	32.9

12.2 Spurious emissions radiated

Description:

The following steps outline the procedure used to measure the radiated emissions from the mobile station. The site is constructed in accordance with ANSI C63.4:2014 requirements and is recognized by the FCC to be in compliance for a 3 and a 10 meter site. The spectrum was scanned from 30 MHz to the 10th harmonic of the highest frequency generated within the equipment, which is the transmitted carrier that can be as high as 1910 MHz. Measurement made up to 25 GHz. The resolution bandwidth is set as outlined in Part 24.238. The spectrum was scanned with the mobile station transmitting at carrier frequencies that pertain to low, mid and high channels of the PCS1900 band.

Measurement:

Measurement parameters	
Detector:	Peak
Sweep time:	2 sec.
Resolution bandwidth:	Below 1 GHz: 300 kHz Above 1 GHz: 3 MHz
Video bandwidth:	Below 1 GHz: 100 kHz Above 1 GHz: 1 MHz
Span:	100 MHz Steps
Trace mode:	Max Hold
Used equipment:	See chapter 7.1 – A; 7.2 – A & 7.3 – A
Measurement uncertainty:	See chapter 9

Limits:

FCC	ISED
Attenuation $\geq 43 + 10\log(P)$ (P, Power in Watts)	
-13 dBm	

Results GPRS & EGPRS:

Radiated emissions measurements were made only at the center carrier frequencies of the PCS1900 band (1880.0 MHz) to show the compliance with cabinet radiation limits.

Results:

Spurious emission level (dBm)								
Harmonic	Ch. 512 Freq. (MHz)	Level [dBm]	Harmonic	Ch. 661 Freq. (MHz)	Level [dBm]	Harmonic	Ch. 810 Freq. (MHz)	Level [dBm]
2	3700.4	-	2	3760.0	-	2	3819.6	-
3	5550.6	-	3	5640.0	-	3	5729.4	-
4	7400.8	-	4	7520.0	-	4	7639.2	-
5	9251.0	-	5	9400.0	-	5	9549.0	-
6	11101.2	-	6	11280.0	-	6	11458.8	-
7	12951.4	-	7	13160.0	-	7	13368.6	-
8	14801.6	-	8	15040.0	-	8	15278.4	-
9	16651.8	-	9	16920.0	-	9	17188.2	-
10	18502.0	-	10	18800.0	-	10	19098.0	-

Plots: GMSK

Plot 1: Channel 661 (Traffic mode up to 30 MHz)

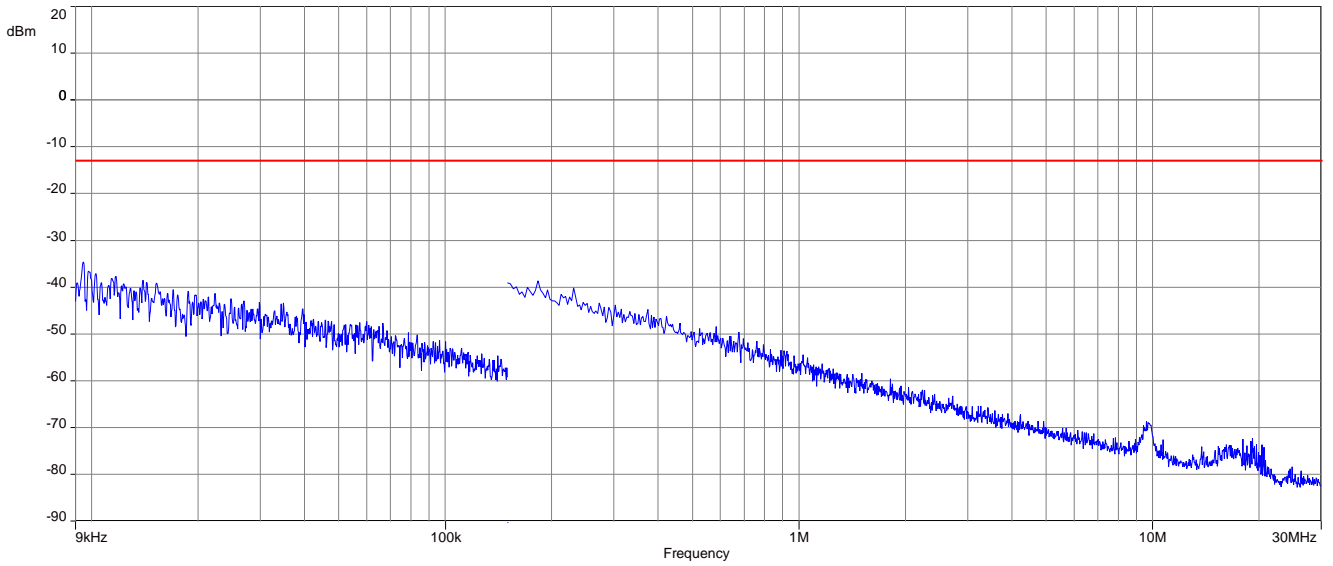

Plot 2: Channel 661 (30 MHz – 1 GHz)

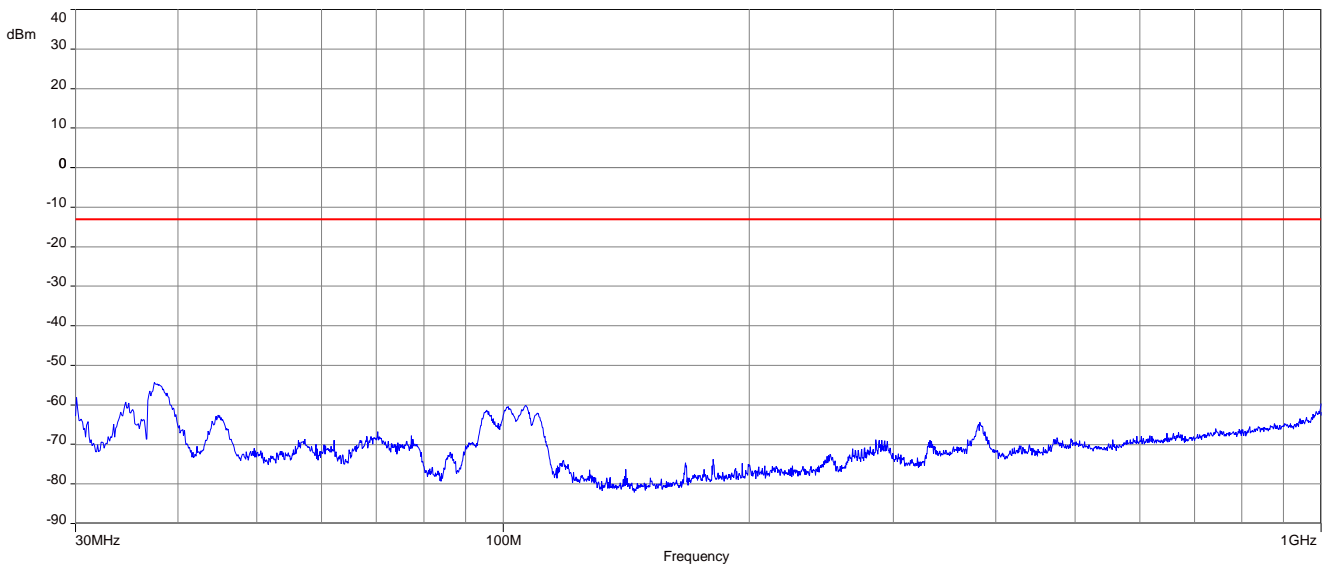

Plot 3: Channel 661 (30 MHz – 18 GHz)

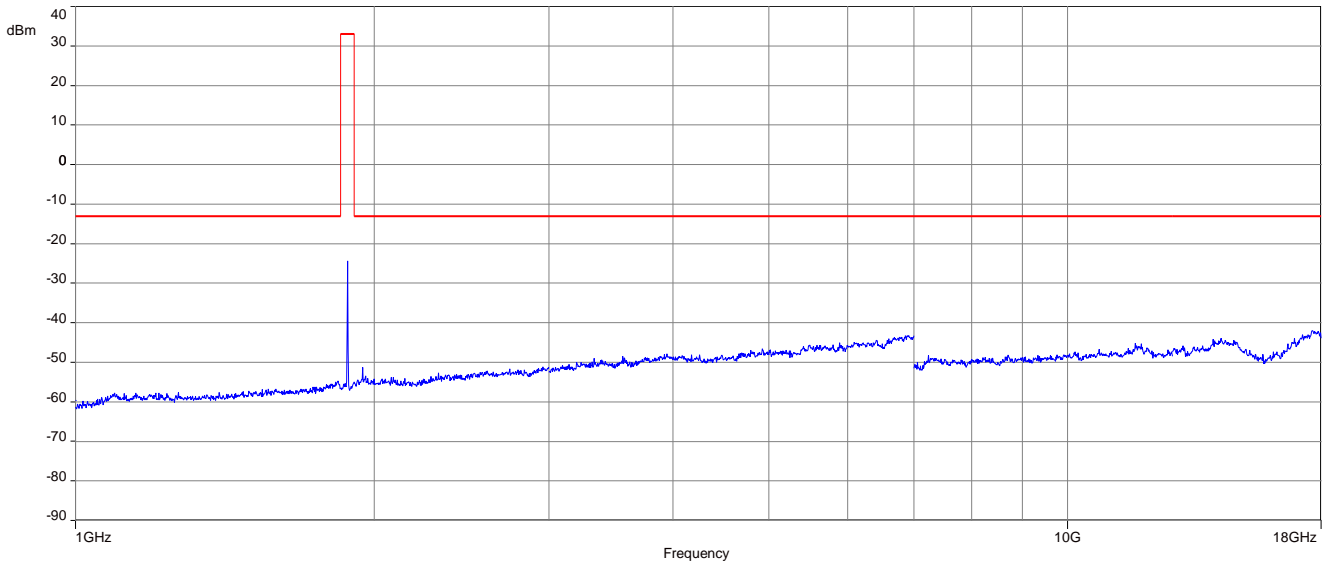

Carrier notched with 1.9 GHz rejection filter

Plot 4: Channel 661 (18 GHz - 20 GHz)

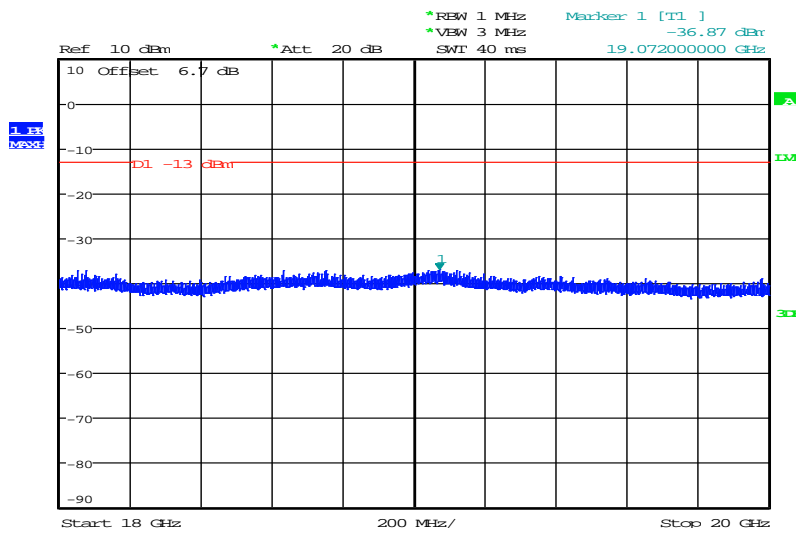

NOP
Date: 20.JUL.2023 08:33:53

Plots: 8 PSK

Plot 1: Channel 661 (Traffic mode up to 30 MHz)

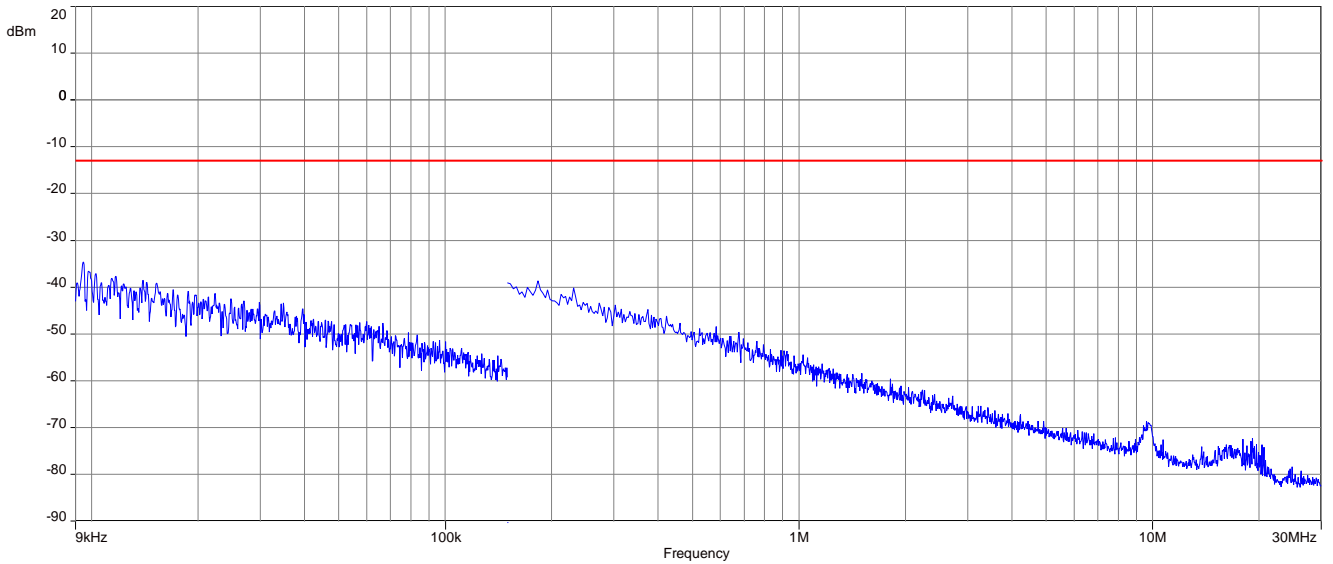

Plot 2: Channel 661 (30 MHz – 1 GHz)

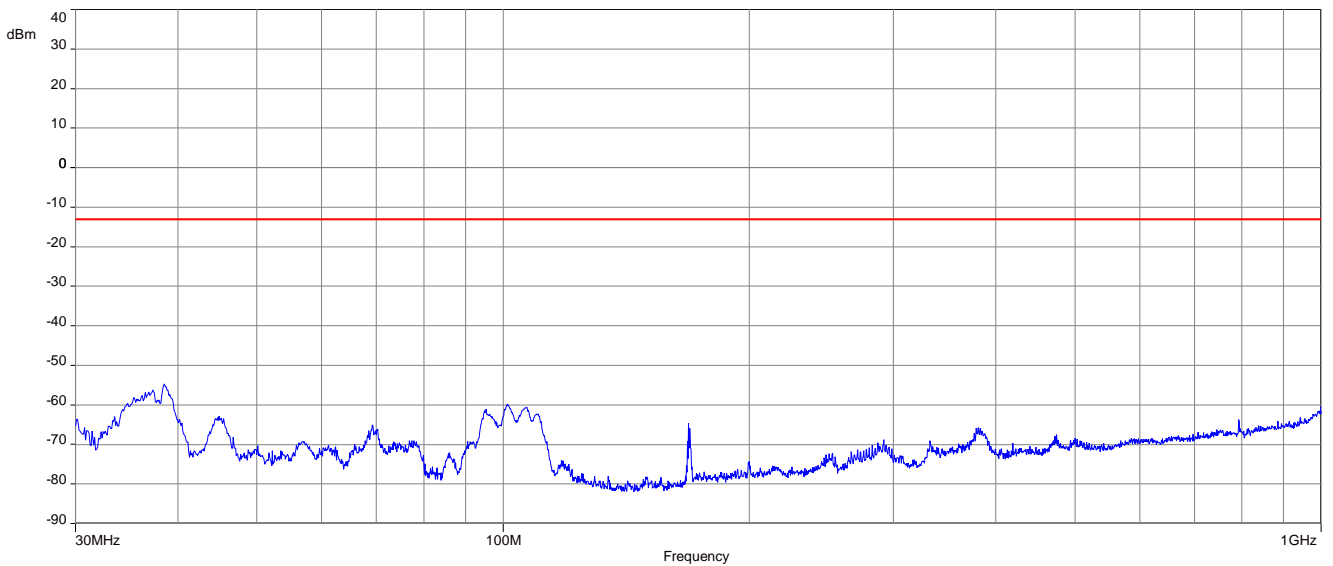

Plot 3: Channel 661 (30 MHz – 18 GHz)

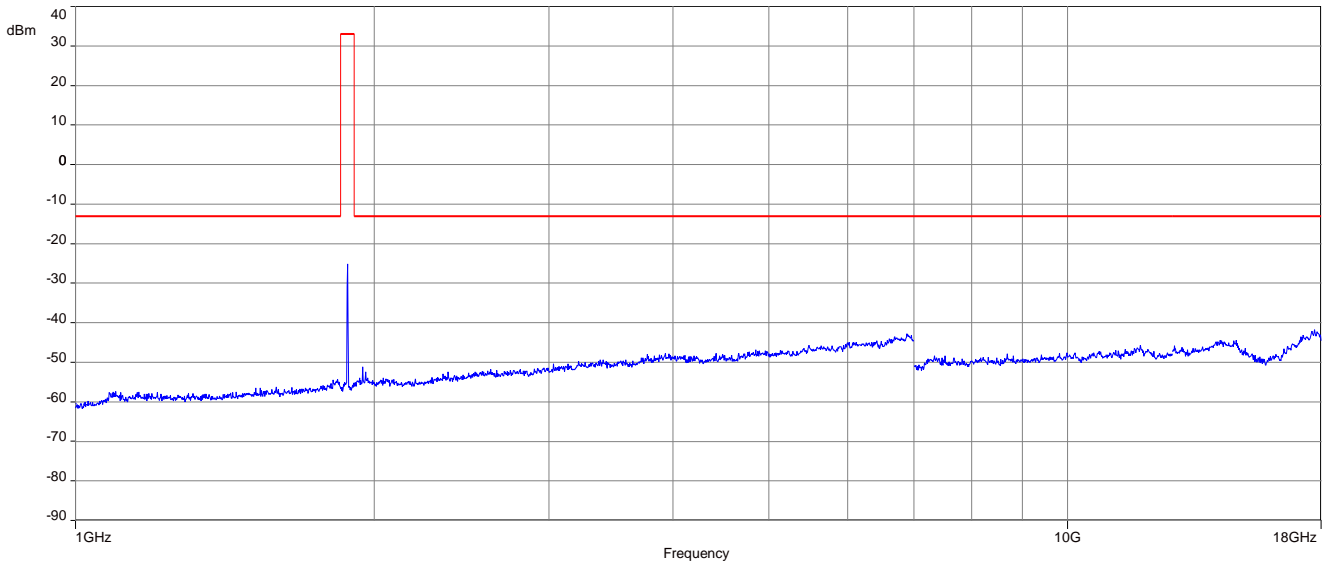

Carrier notched with 1.9 GHz rejection filter

Plot 4: Channel 661 (18 GHz - 20 GHz)

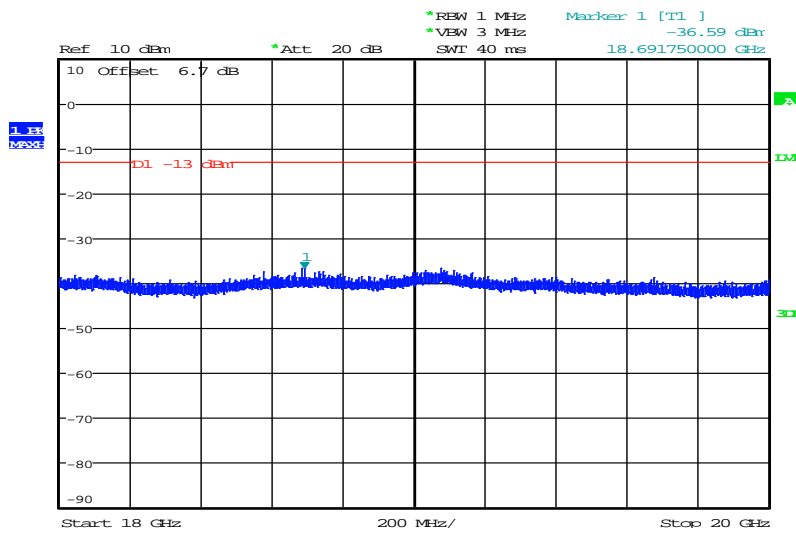

NOP
Date: 20.JUL.2023 08:35:18

13 Results UMTS band II

All UMTS-band measurements are done in WCDMA mode only.

The connection was established with the following setup: WCDMA CS-RMC, Max Power (All Bit up)

13.1 Spurious emissions radiated

Description:

The following steps outline the procedure used to measure the radiated emissions from the mobile station. The site is constructed in accordance with ANSI C63.4:2014 requirements and is recognized by the FCC to be in compliance for a 3 and a 10 meter site. The spectrum was scanned from 30 MHz to the 10th harmonic of the highest frequency generated within the equipment, which is the transmitted carrier that can be as high as 1910 MHz. Measurement made up to 25 GHz. The resolution bandwidth is set as outlined in Part 24.238. The spectrum was scanned with the mobile station transmitting at carrier frequencies that pertain to low, mid and high channels of the UMTS band II.

Measurement:

Measurement parameters	
Detector:	Peak
Sweep time:	2 sec.
Resolution bandwidth:	Below 1 GHz: 300 kHz Above 1 GHz: 3 MHz
Video bandwidth:	Below 1 GHz: 100 kHz Above 1 GHz: 1 MHz
Span:	100 MHz Steps
Trace mode:	Max Hold
Used equipment:	See chapter 7.1 – A & 7.2 – A
Measurement uncertainty:	See chapter 9

Limits:

FCC	ISED
Attenuation $\geq 43 + 10\log(P)$ (P, Power in Watts)	
-13 dBm	

Results UMTS band II:

Radiated emissions measurements were made only at the center carrier frequencies of the band II (1880.0 MHz) to show the compliance with cabinet radiation limits.

Results:

Spurious Emission Level (dBm)								
Harmonic	Ch. 9262 Freq. (MHz)	Level [dBm]	Harmonic	Ch. 9400 Freq. (MHz)	Level [dBm]	Harmonic	Ch. 9538 Freq. (MHz)	Level [dBm]
2	3704.8	-	2	3760.0	-	2	3815.2	-
3	5557.2	-	3	5640.0	-	3	5722.8	-
4	7409.6	-	4	7520.0	-	4	7630.4	-
5	9262.0	-	5	9400.0	-	5	9538.0	-
6	11114.4	-	6	11280.0	-	6	11445.6	-
7	12966.8	-	7	13160.0	-	7	13353.2	-
8	14819.2	-	8	15040.0	-	8	15260.8	-
9	16671.6	-	9	16920.0	-	9	17168.4	-
10	18524.0	-	10	18800.0	-	10	19076.0	-

Plots:

Plot 1: Channel 9400 (Traffic mode up to 30 MHz)

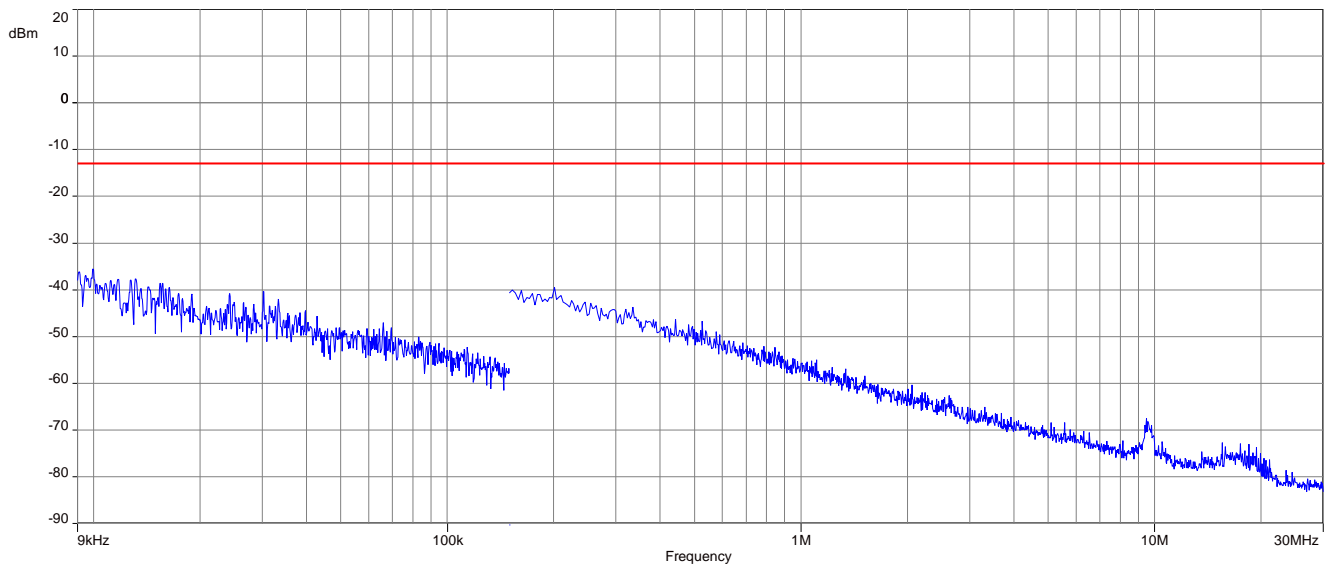

Plot 2: Channel 9400 (30 MHz – 1 GHz)

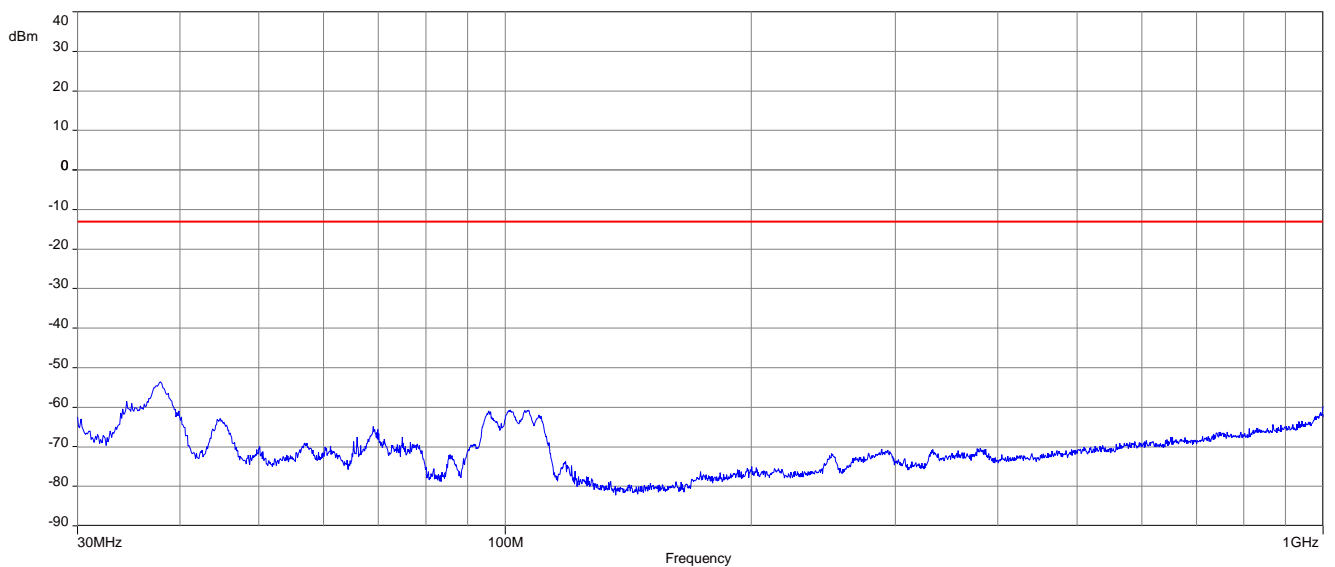

Plot 3: Channel 9400 (1 GHz – 18 GHz)

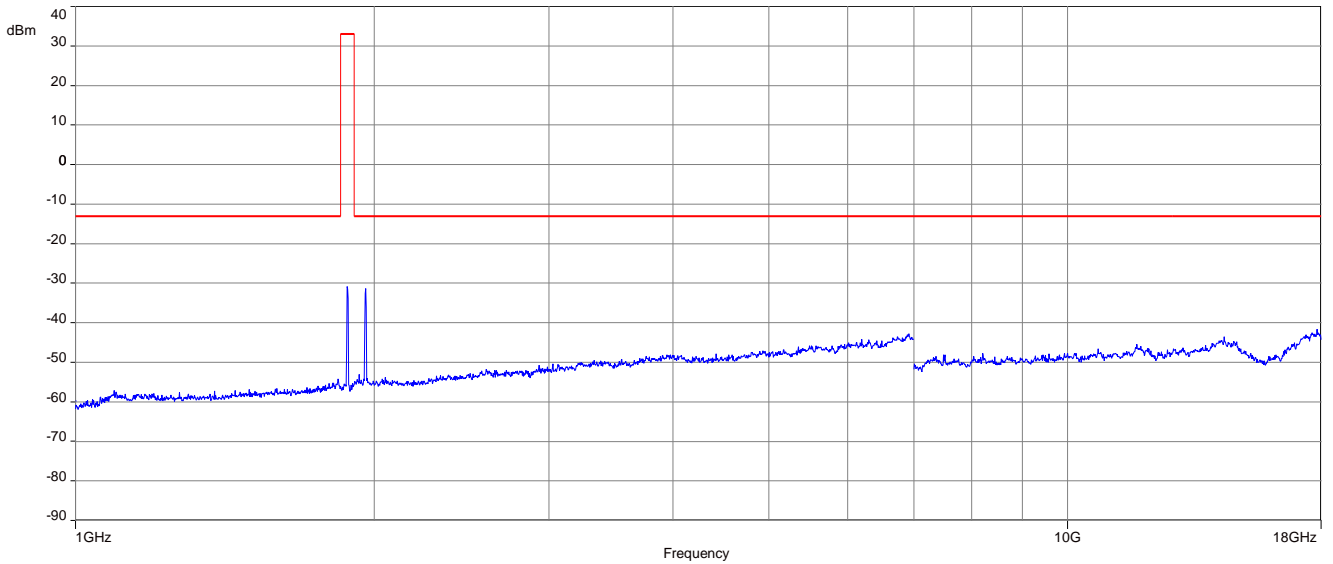

Carrier notched with 1.9 GHz rejection filter

Plot 4: Channel 9400 (18 GHz - 20 GHz)

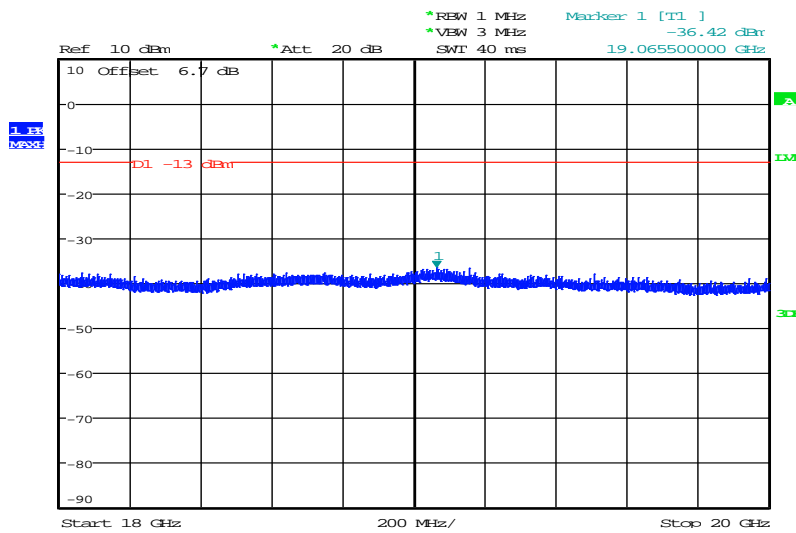

NOP
Date: 20.JUL.2023 08:42:29

14 Results UMTS band V

All UMTS-band measurements are done in WCDMA mode only.

The connection was established with the following setup: WCDMA CS-RMC, Max Power (All Bit up)

14.1 Spurious emissions radiated

Description:

The following steps outline the procedure used to measure the radiated emissions from the mobile station. The site is constructed in accordance with ANSI C63.4:2009 requirements and is recognized by the FCC to be in compliance for a 3 and a 10 meter site. The spectrum was scanned from 30 MHz to the 10th harmonic of the highest frequency generated within the equipment, which is the transmitted carrier that can be as high as 846.6 MHz. This was rounded up to 12 GHz. The resolution bandwidth is set as outlined in Part 22.917. The spectrum was scanned with the mobile station transmitting at carrier frequencies that pertain to low, mid and high channels of the UMTS band V.

Measurement:

Measurement parameters	
Detector:	Peak
Sweep time:	2 sec.
Video bandwidth:	Below 1 GHz: 300 kHz Above 1 GHz: 3 MHz
Resolution bandwidth:	Below 1 GHz: 100 kHz Above 1 GHz: 1 MHz
Span:	100 MHz Steps
Trace-Mode:	Max Hold

Limits:

FCC	ISED
CFR Part 22.917 CFR Part 2.1053	RSS 132
Spurious Emissions Radiated	
Attenuation $\geq 43 + 10\log(P)$ (P, Power in Watts)	
-13 dBm	

Results:

Spurious Emission Level (dBm)								
Harmonic	Ch. 4132 Freq. (MHz)	Level [dBm]	Harmonic	Ch. 4180 Freq. (MHz)	Level [dBm]	Harmonic	Ch. 4233 Freq. (MHz)	Level [dBm]
2	1652.8	-	2	1672.0	-43.7	2	1693.2	-
3	2479.2	-	3	2508.0	-50.3	3	2539.8	-
4	3305.6	-	4	3344.0	-	4	3386.4	-
5	4132.0	-	5	4180.0	-	5	4233.0	-
6	4958.4	-	6	5016.0	-	6	5079.6	-
7	5784.8	-	7	5852.0	-	7	5926.2	-
8	6611.2	-	8	6688.0	-	8	6772.8	-
9	7437.6	-	9	7524.0	-	9	7619.4	-
10	8264.0	-	10	8360.0	-	10	8466.0	-

Plots:

Plot 1: Channel 4180 (Traffic mode up to 30 MHz)

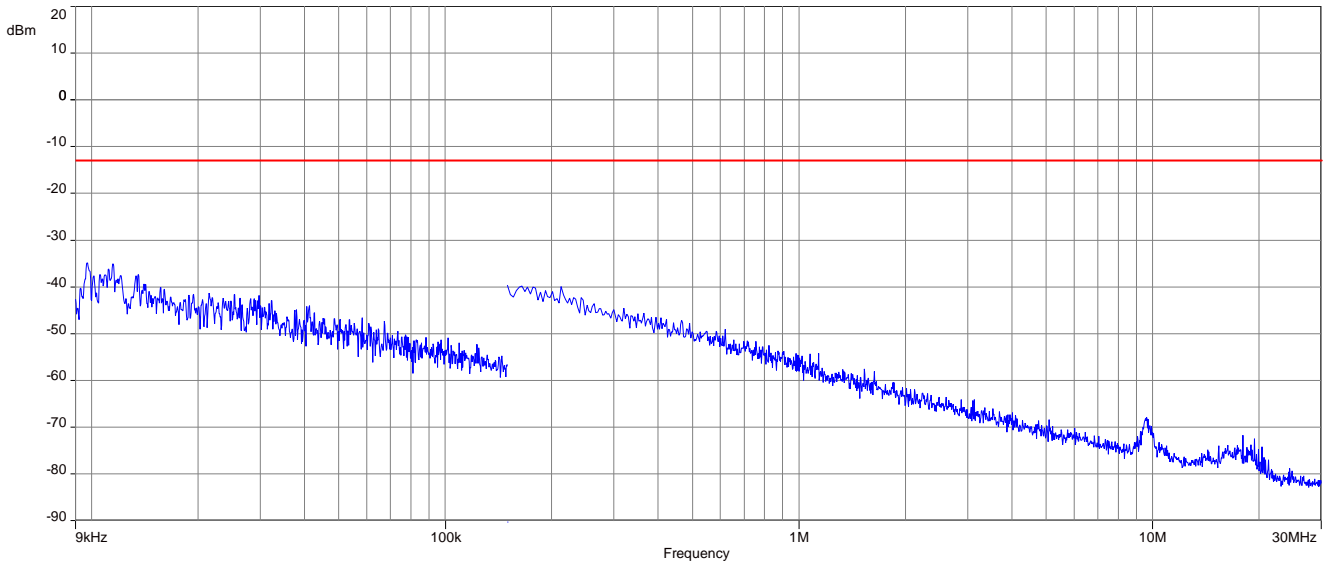

Plot 2: Channel 4180 (30 MHz – 1 GHz)

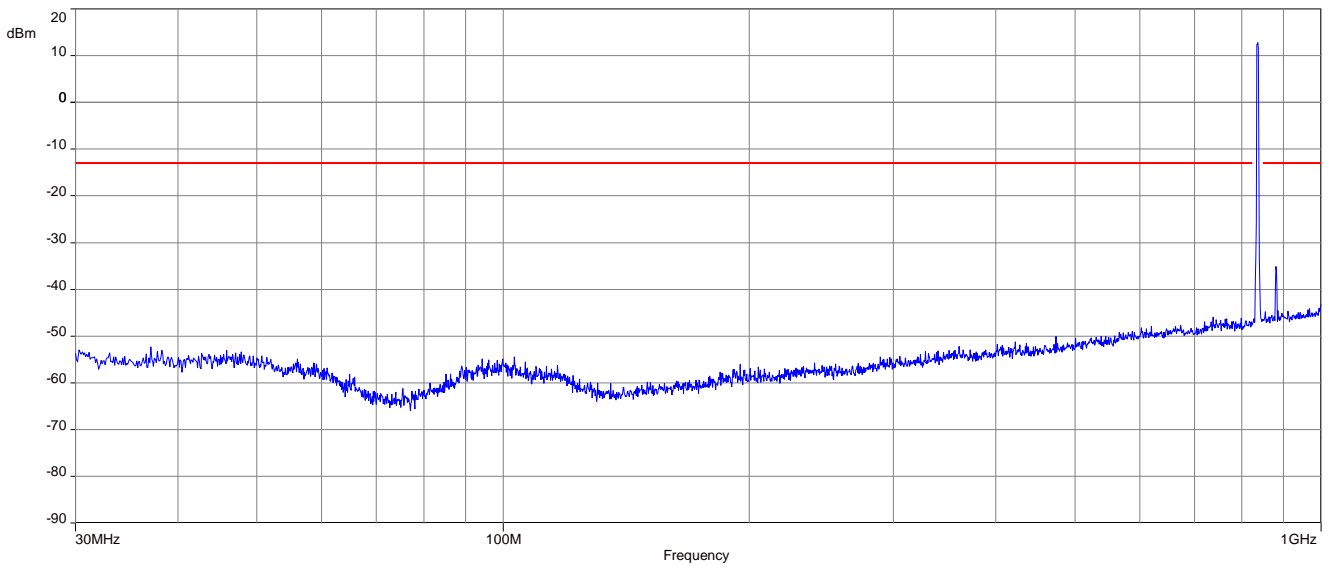

Plot 3: Channel 4180 (1 GHz – 9 GHz)

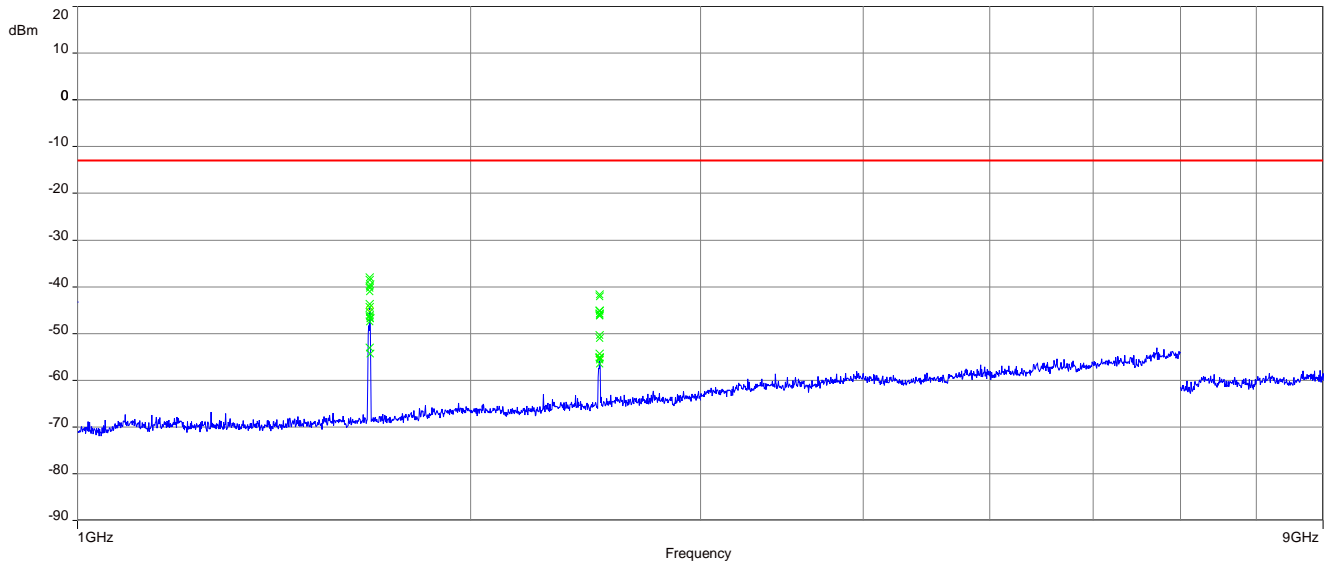

15 Summary of measurement results LTE band 2

<input type="checkbox"/>	No deviations from the technical specifications were ascertained
<input type="checkbox"/>	There were deviations from the technical specifications ascertained
<input checked="" type="checkbox"/>	This test report is only a partial test report. The content and verdict of the performed test cases are listed below.

15.1 LTE – Band 2

TC identifier	Description	verdict	date	Remark
RF-Testing	CFR Part 24 RSS 133	See table	2024-02-02	Delta tests according to manufacturer demand!

Test Case	temperature conditions	power source voltages	C	NC	NA	NP	Remark
RF Output Power	Nominal	Nominal	<input type="checkbox"/>	<input type="checkbox"/>	<input type="checkbox"/>	<input checked="" type="checkbox"/>	-/-
Frequency Stability	Extreme	Extreme	<input type="checkbox"/>	<input type="checkbox"/>	<input type="checkbox"/>	<input checked="" type="checkbox"/>	-/-
Spurious Emissions Radiated	Nominal	Nominal	<input checked="" type="checkbox"/>	<input type="checkbox"/>	<input type="checkbox"/>	<input type="checkbox"/>	Partial tests
Spurious Emissions Conducted	Nominal	Nominal	<input type="checkbox"/>	<input type="checkbox"/>	<input type="checkbox"/>	<input checked="" type="checkbox"/>	-/-
Block Edge Compliance	Nominal	Nominal	<input type="checkbox"/>	<input type="checkbox"/>	<input type="checkbox"/>	<input checked="" type="checkbox"/>	-/-
Occupied Bandwidth	Nominal	Nominal	<input type="checkbox"/>	<input type="checkbox"/>	<input type="checkbox"/>	<input checked="" type="checkbox"/>	-/-

Notes:

C	Compliant	NC	Not compliant	NA	Not applicable	NP	Not performed
----------	-----------	-----------	---------------	-----------	----------------	-----------	---------------

16 RF measurements LTE band 2

16.1 Description of test setup

For the spurious measurements we use the substitution method according TIA/EIA 603.

16.2 Results

16.2.1 Spurious emissions radiated

Description:

The following steps outline the procedure used to measure the radiated emissions from the mobile station. The site is constructed in accordance with ANSI C63.4:2014 requirements and is recognized by the FCC to be in compliance for a 3 and a 10 meter site. The spectrum was scanned from 30 MHz to the 10th harmonic of the highest frequency generated within the equipment, which is the transmitted carrier that can be as high as 1910 MHz. Measurement made up to 25 GHz. The resolution bandwidth is set as outlined in Part 24.238. The spectrum was scanned with the mobile station transmitting at carrier frequencies that pertain to low, mid and high channels of the LTE band II.

Measurement:

Measurement parameters	
Detector	Peak
Sweep time	2 sec.
Video bandwidth	Below 1 GHz: 300 kHz Above 1 GHz: 3 MHz
Resolution bandwidth	Below 1 GHz: 100 kHz Above 1 GHz: 1 MHz
Span	100 MHz Steps
Trace mode	Max Hold
Setup	See chapter 7.1 - A; 7.2 - A ; 7.3 - A
Measurement uncertainty	See chapter 9

Limits:

FCC	ISED
Spurious Emissions Radiated	
Attenuation $\geq 43 + 10\log(P) / (P, \text{Power in Watts})$	
-13 dBm	

QPSK:

Spurious Emission Level (dBm)								
Harmonic	Lowest channel Freq. (MHz)	Level [dBm]	Harmonic	Middle channel Freq. (MHz)	Level [dBm]	Harmonic	Highest channel Freq. (MHz)	Level [dBm]
2	3710.0	All detected emissions are more than 20dB below the limit!	2	3760.0	All detected emissions are more than 20dB below the limit!	2	3810.0	All detected emissions are more than 20dB below the limit!
3	5565.0		3	5640.0		3	5715.0	
4	7420.0		4	7520.0		4	7620.0	
5	9275.0		5	9400.0		5	9525.0	
6	11130.0		6	11280.0		6	11430.0	
7	12985.0		7	13160.0		7	13335.0	
8	14840.0		8	15040.0		8	15240.0	
9	16695.0		9	16920.0		9	17145.0	
10	18550.0		10	18800.0		10	19050.0	

Results: QPSK with 10 MHz channel bandwidth

Plot 1: Channel 18900 (Traffic mode up to 30 MHz)

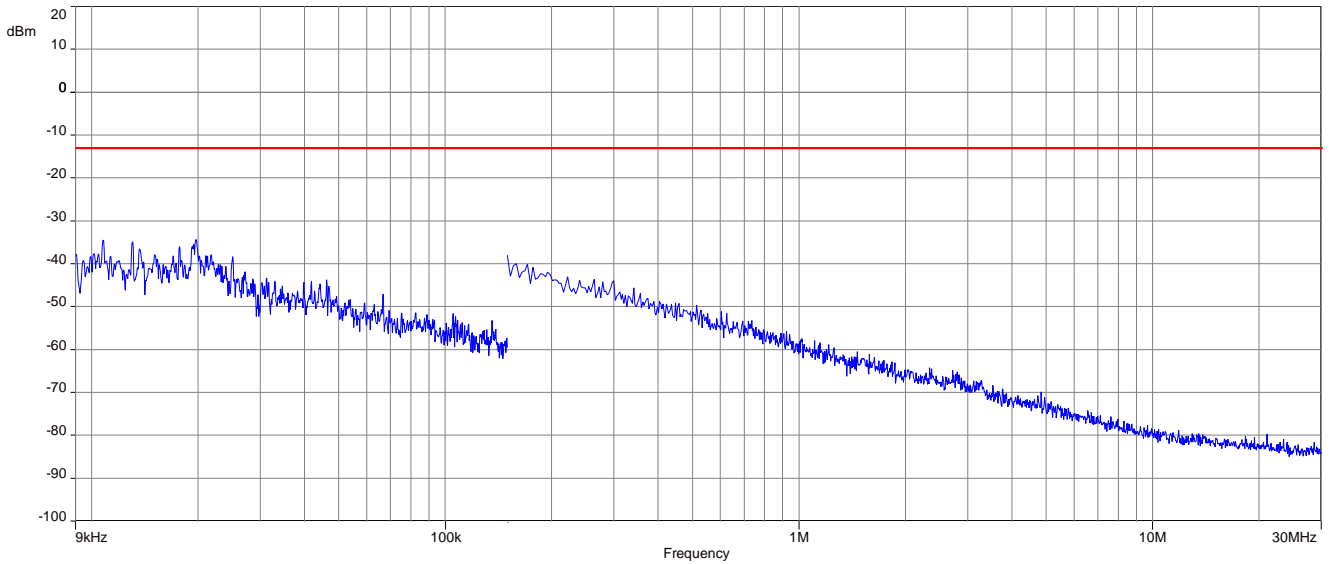

Plot 2: Channel 18900 (30 MHz – 1 GHz)

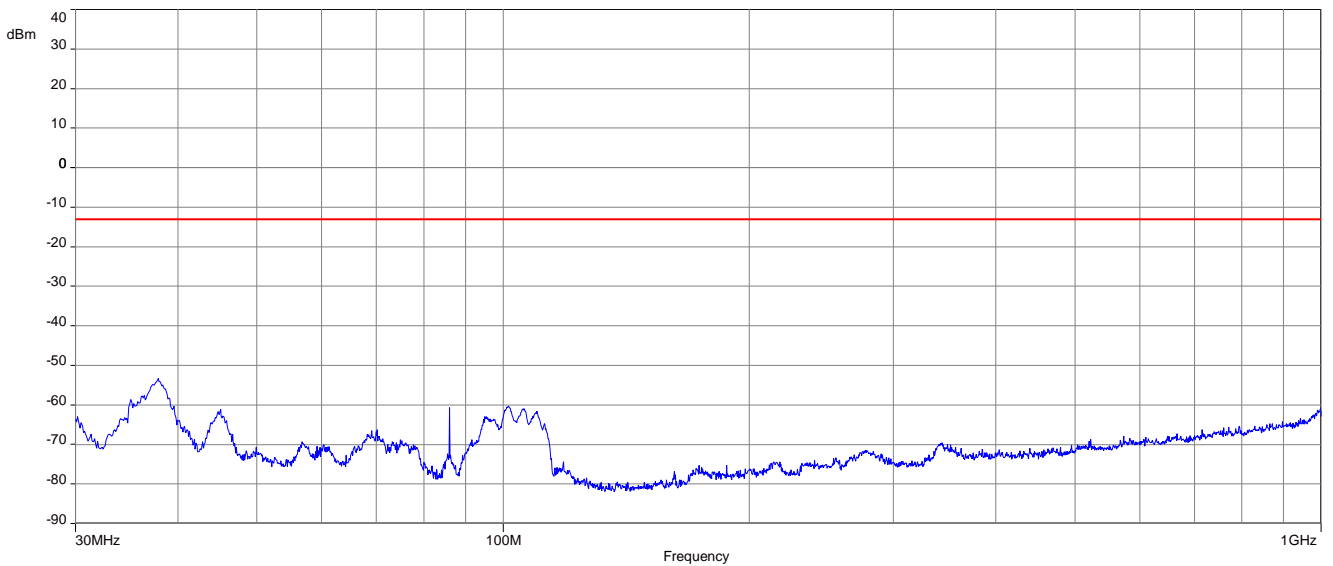

Plot 3: Channel 18900 (1 GHz – 18 GHz)

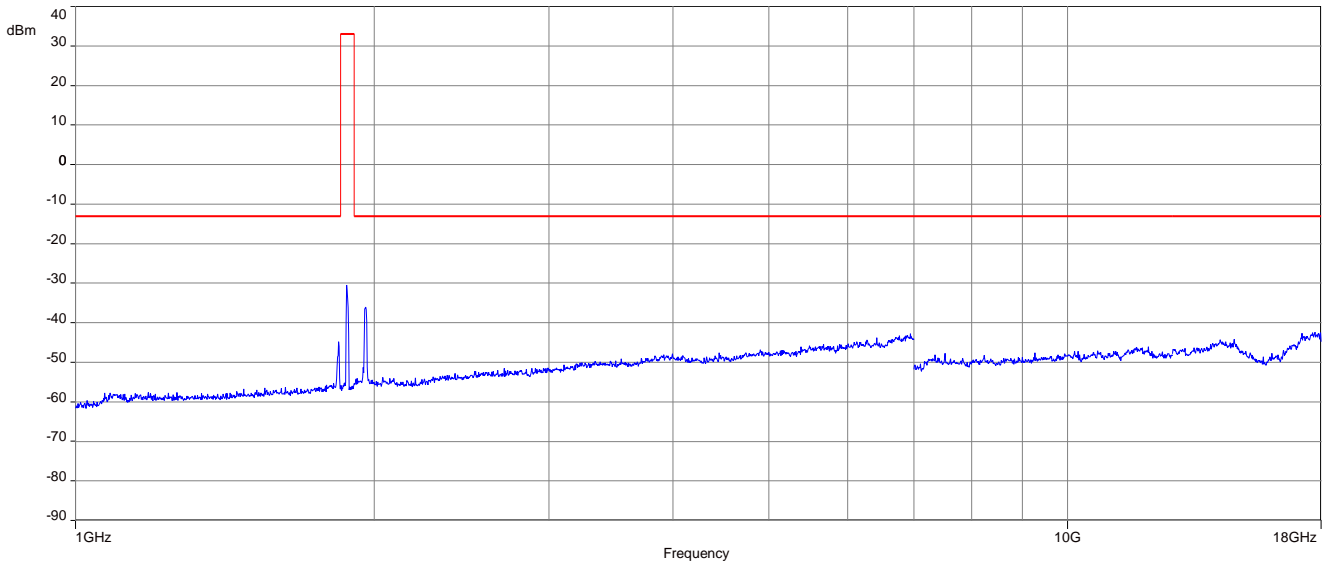

Carrier notched with 1.9 GHz rejection filter

Plot 4: Channel 18900 (18 GHz – 20 GHz)

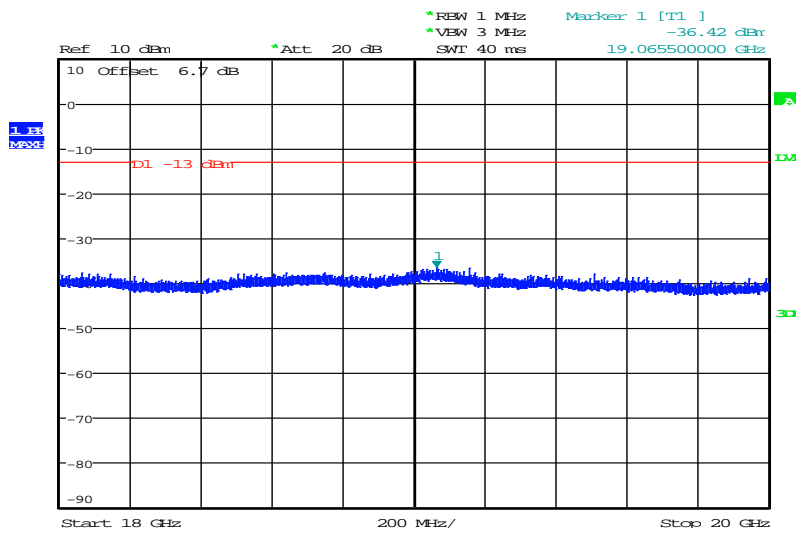

NOP
Date: 20.JUL.2023 08:42:29

17 Summary of measurement results LTE band 5; LTE band 26a

<input type="checkbox"/>	No deviations from the technical specifications were ascertained
<input type="checkbox"/>	There were deviations from the technical specifications ascertained
<input checked="" type="checkbox"/>	This test report is only a partial test report. The content and verdict of the performed test cases are listed below.

17.1 LTE – Band 5

TC identifier	Description	verdict	date	Remark
RF-Testing	CFR Part 22 RSS 132	See table	2024-02-02	Delta tests according to manufacturer demand!

Test Case	temperature conditions	power source voltages	C	NC	NA	NP	Remark
RF Output Power	Nominal	Nominal	<input type="checkbox"/>	<input type="checkbox"/>	<input type="checkbox"/>	<input checked="" type="checkbox"/>	-/-
Frequency Stability	Extreme	Extreme	<input type="checkbox"/>	<input type="checkbox"/>	<input type="checkbox"/>	<input checked="" type="checkbox"/>	-/-
Spurious Emissions Radiated	Nominal	Nominal	<input checked="" type="checkbox"/>	<input type="checkbox"/>	<input type="checkbox"/>	<input type="checkbox"/>	Partial tests
Spurious Emissions Conducted	Nominal	Nominal	<input type="checkbox"/>	<input type="checkbox"/>	<input type="checkbox"/>	<input checked="" type="checkbox"/>	-/-
Block Edge Compliance	Nominal	Nominal	<input type="checkbox"/>	<input type="checkbox"/>	<input type="checkbox"/>	<input checked="" type="checkbox"/>	-/-
Occupied Bandwidth	Nominal	Nominal	<input type="checkbox"/>	<input type="checkbox"/>	<input type="checkbox"/>	<input checked="" type="checkbox"/>	-/-

Notes:

C	Compliant	NC	Not compliant	NA	Not applicable	NP	Not performed
----------	-----------	-----------	---------------	-----------	----------------	-----------	---------------

17.2 LTE – Band 26a

TC identifier	Description	verdict	date	Remark
RF-Testing	CFR Part 22; Part 90	See table	2024-02-02	Delta tests according to manufacturer demand!

Test Case	temperature conditions	power source voltages	C	NC	NA	NP	Remark
RF Output Power	Nominal	Nominal	<input type="checkbox"/>	<input type="checkbox"/>	<input type="checkbox"/>	<input checked="" type="checkbox"/>	-/-
Frequency Stability	Extreme	Extreme	<input type="checkbox"/>	<input type="checkbox"/>	<input type="checkbox"/>	<input checked="" type="checkbox"/>	-/-
Spurious Emissions Radiated	Nominal	Nominal	<input checked="" type="checkbox"/>	<input type="checkbox"/>	<input type="checkbox"/>	<input type="checkbox"/>	Partial tests
Spurious Emissions Conducted	Nominal	Nominal	<input type="checkbox"/>	<input type="checkbox"/>	<input type="checkbox"/>	<input checked="" type="checkbox"/>	-/-
Block Edge Compliance	Nominal	Nominal	<input type="checkbox"/>	<input type="checkbox"/>	<input type="checkbox"/>	<input checked="" type="checkbox"/>	-/-
Occupied Bandwidth	Nominal	Nominal	<input type="checkbox"/>	<input type="checkbox"/>	<input type="checkbox"/>	<input checked="" type="checkbox"/>	-/-

Notes:

C	Compliant	NC	Not compliant	NA	Not applicable	NP	Not performed
----------	-----------	-----------	---------------	-----------	----------------	-----------	---------------

18 RF measurements LTE band 5

18.1 Description of test setup

For the spurious measurements we use the substitution method according TIA/EIA 603.

18.2 Results

The EUT was set to transmit the maximum power.

18.2.1 Spurious emissions radiated

Description:

The following steps outline the procedure used to measure the radiated emissions from the mobile station. The site is constructed in accordance with ANSI C63.4:2014 requirements and is recognized by the FCC to be in compliance for a 3 and a 10 meter site. The spectrum was scanned from 30 MHz to the 10th harmonic of the highest frequency generated within the equipment, which is the transmitted carrier that can be as high as 846.6 MHz. Measurement made up to 12.75 GHz. The resolution bandwidth is set as outlined in Part 22.917. The spectrum was scanned with the mobile station transmitting at carrier frequencies that pertain to low, mid and high channels of the LTE band V.

Measurement:

Measurement parameters	
Detector	Peak
Sweep time	2 sec.
Video bandwidth	Below 1 GHz: 300 kHz Above 1 GHz: 3 MHz
Resolution bandwidth	Below 1 GHz: 100 kHz Above 1 GHz: 1 MHz
Span	100 MHz Steps
Trace mode	Max Hold
Setup	See chapter 7.1 - A; 7.2 - A
Measurement uncertainty	See chapter 9

Limits:

FCC	IC
Spurious Emissions Radiated	
Attenuation $\geq 43 + 10\log(P) / (P, \text{Power in Watts})$	
-13 dBm	

QPSK:

Spurious Emission Level (dBm)								
Harmonic	Lowest channel Freq. (MHz)	Level [dBm]	Harmonic	Middle channel Freq. (MHz)	Level [dBm]	Harmonic	Highest channel Freq. (MHz)	Level [dBm]
2	1658.0	All detected emissions are more than 20dB below the limit!	2	1673.0	All detected emissions are more than 20dB below the limit!	2	1688.0	All detected emissions are more than 20dB below the limit!
3	2487.0		3	2509.5		3	2532.0	
4	3316.0		4	3346.0		4	3376.0	
5	4145.0		5	4182.5		5	4220.0	
6	4974.0		6	5019.0		6	5064.0	
7	5803.0		7	5855.5		7	5908.0	
8	6632.0		8	6692.0		8	6752.0	
9	7461.0		9	7528.5		9	7596.0	
10	8290.0		10	8365.0		10	8440.0	

Results: QPSK with 10 MHz channel bandwidth

Plot 1: Channel 20525 (Traffic mode up to 30 MHz)

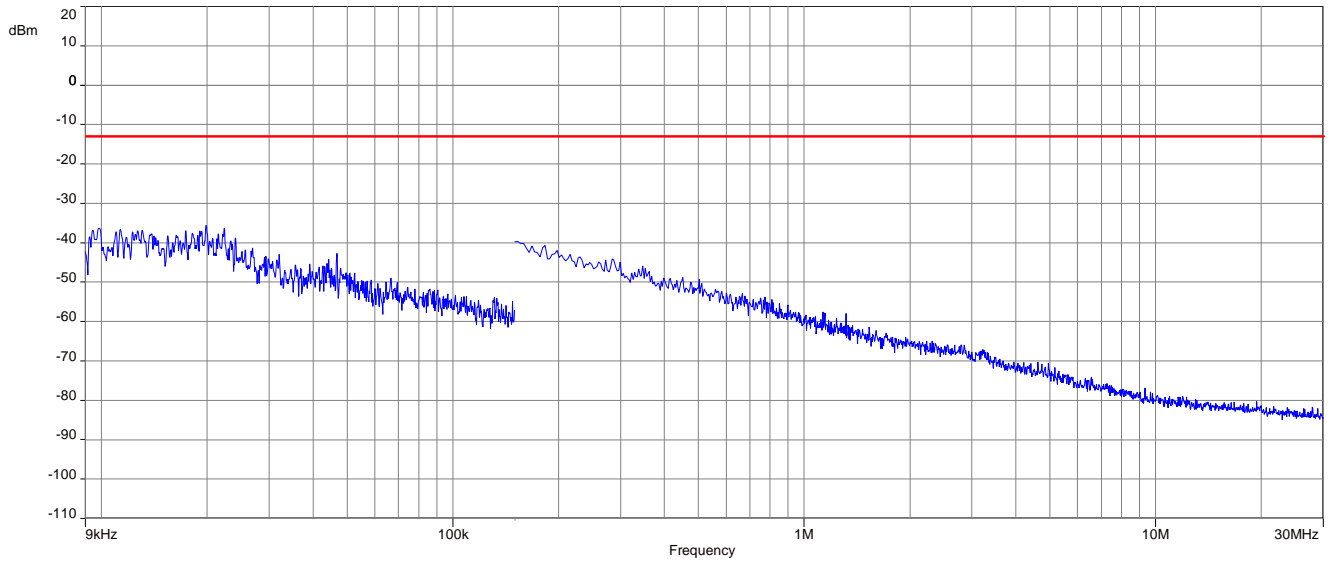

Plot 2: Channel 20525 (30 MHz – 1 GHz)

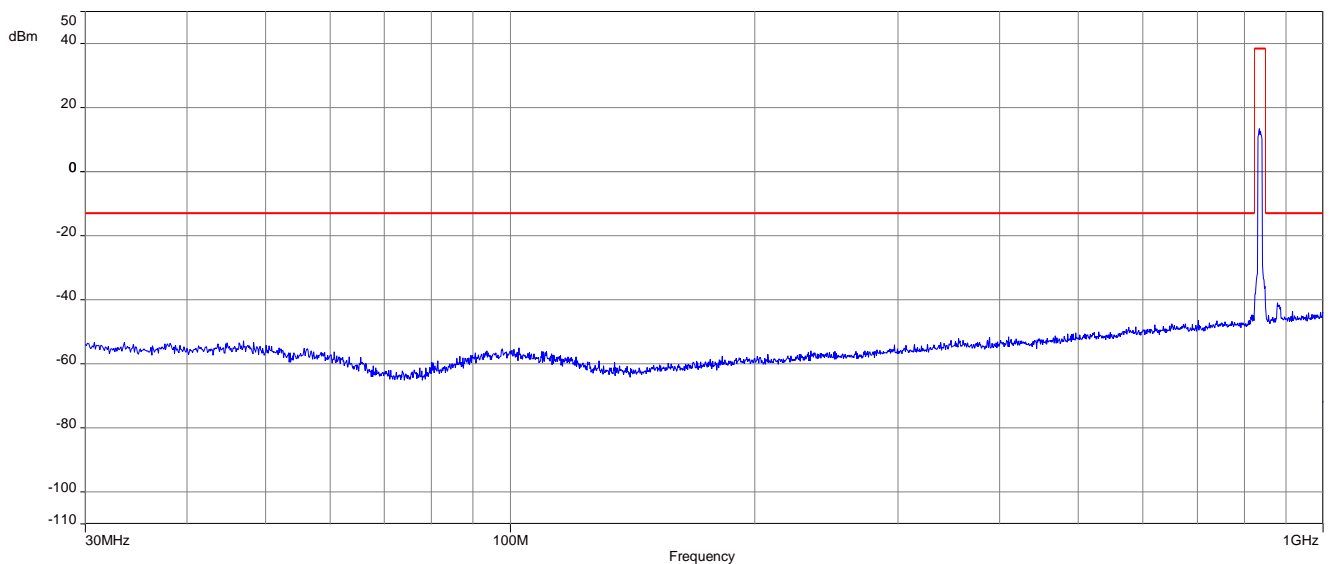

Plot 3: Channel 20525 (1 GHz – 9 GHz)

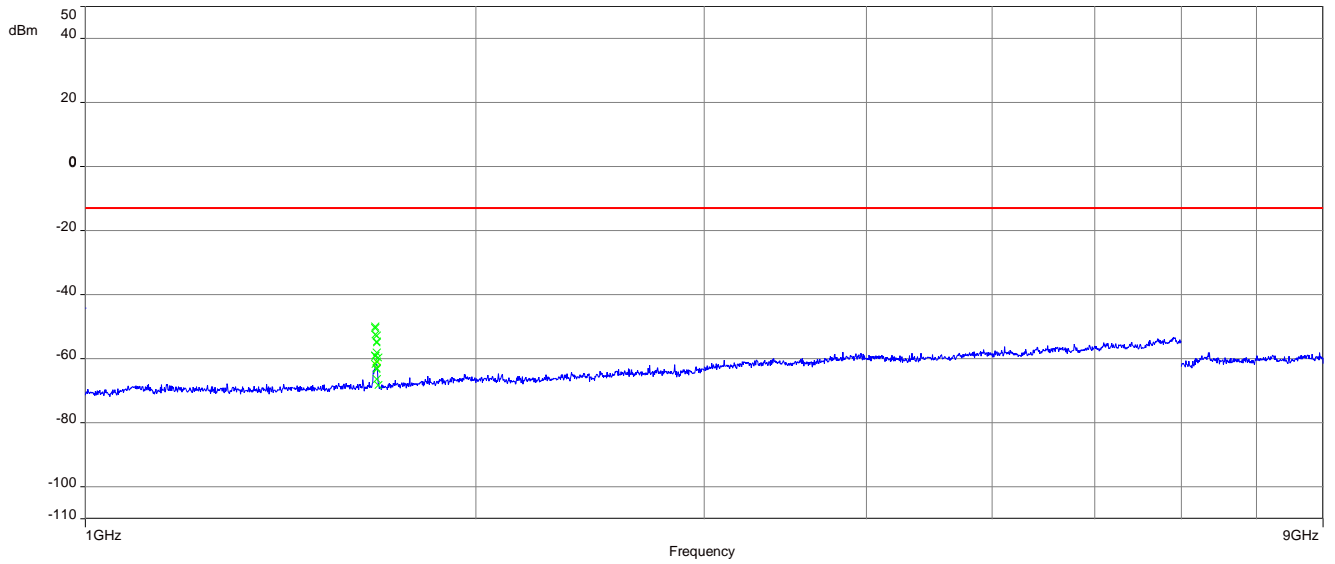

19 RF measurements LTE band 26a

19.1 Description of test setup

For the spurious measurements we use the substitution method according TIA/EIA 603.

19.2 Results

The EUT was set to transmit the maximum power.

19.2.1 Spurious emissions radiated

Description:

The following steps outline the procedure used to measure the radiated emissions from the mobile station. The site is constructed in accordance with ANSI C63.4:2014 requirements and is recognized by the FCC to be in compliance for a 3 and a 10 meter site. The spectrum was scanned from 30 MHz to the 10th harmonic of the highest frequency generated within the equipment, which is the transmitted carrier that can be as high as 848,3 MHz. Measurement made up to 12.75 GHz. The resolution bandwidth is set as outlined in Part 22.917. The spectrum was scanned with the mobile station transmitting at carrier frequencies that pertain to low, mid and high channels of the LTE band V.

Measurement:

Measurement parameters	
Detector	Peak
Sweep time	2 sec.
Video bandwidth	Below 1 GHz: 300 kHz Above 1 GHz: 3 MHz
Resolution bandwidth	Below 1 GHz: 100 kHz Above 1 GHz: 1 MHz
Span	100 MHz Steps
Trace mode	Max Hold
Setup	See chapter 7.1 - A; 7.2 - A
Measurement uncertainty	See chapter 9

Limits:

FCC
Spurious Emissions Radiated
Attenuation $\geq 43 + 10\log(P) / (P, \text{Power in Watts})$
-13 dBm

QPSK:

Spurious Emission Level (dBm)								
Harmonic	Lowest channel Freq. (MHz)	Level [dBm]	Harmonic	Middle channel Freq. (MHz)	Level [dBm]	Harmonic	Highest channel Freq. (MHz)	Level [dBm]
2	1658.0	All detected emissions are more than 20dB below the limit!	2	1673.0	All detected emissions are more than 20dB below the limit!	2	1688.0	All detected emissions are more than 20dB below the limit!
3	2487.0		3	2509.5		3	2532.0	
4	3316.0		4	3346.0		4	3376.0	
5	4145.0		5	4182.5		5	4220.0	
6	4974.0		6	5019.0		6	5064.0	
7	5803.0		7	5855.5		7	5908.0	
8	6632.0		8	6692.0		8	6752.0	
9	7461.0		9	7528.5		9	7596.0	
10	8290.0		10	8365.0		10	8440.0	

Results: QPSK with 10 MHz channel bandwidth

Plot 1: Channel 20525 (Traffic mode up to 30 MHz)

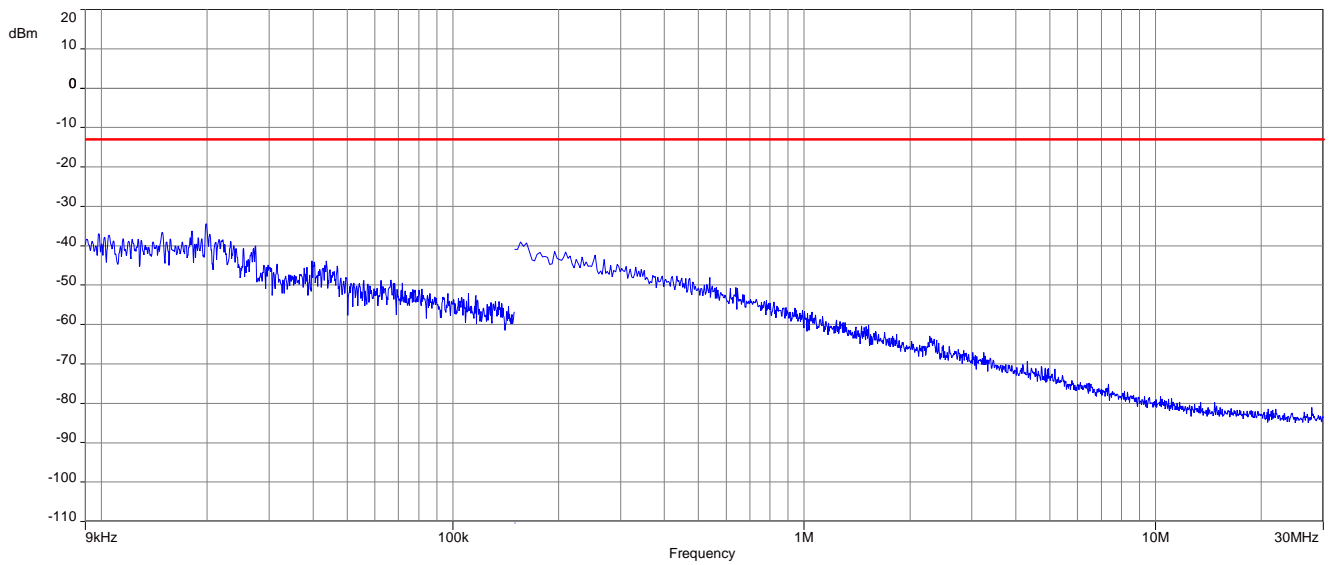

Plot 2: Channel 20525 (30 MHz – 1 GHz)

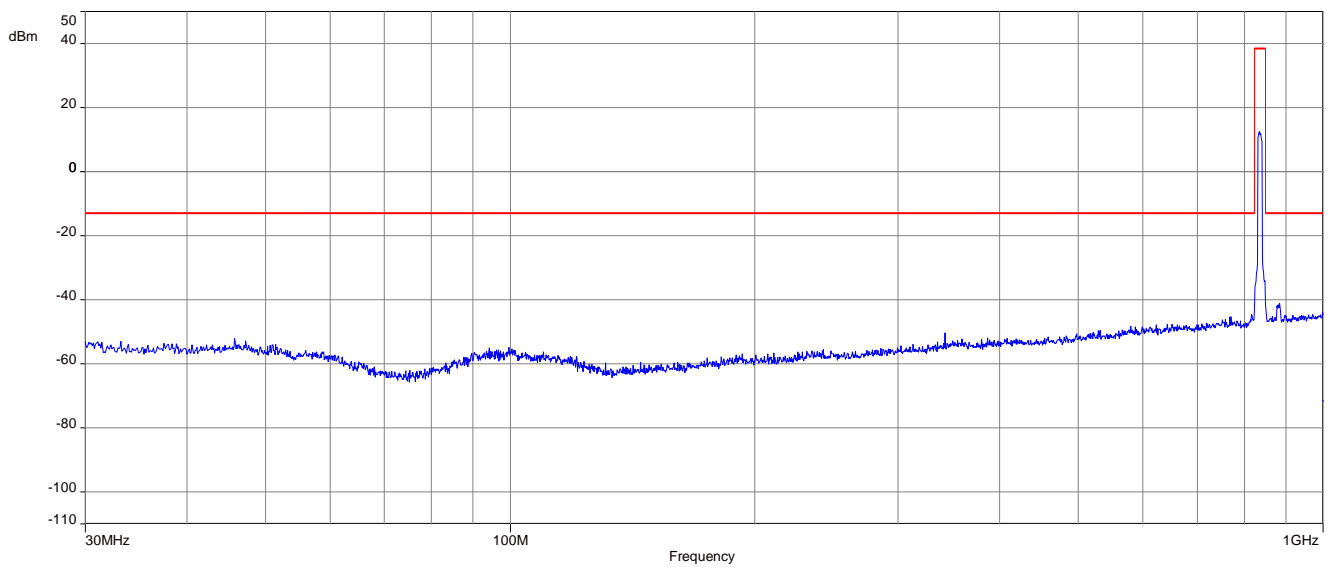

Plot 3: Channel 20525 (1 GHz – 9 GHz)

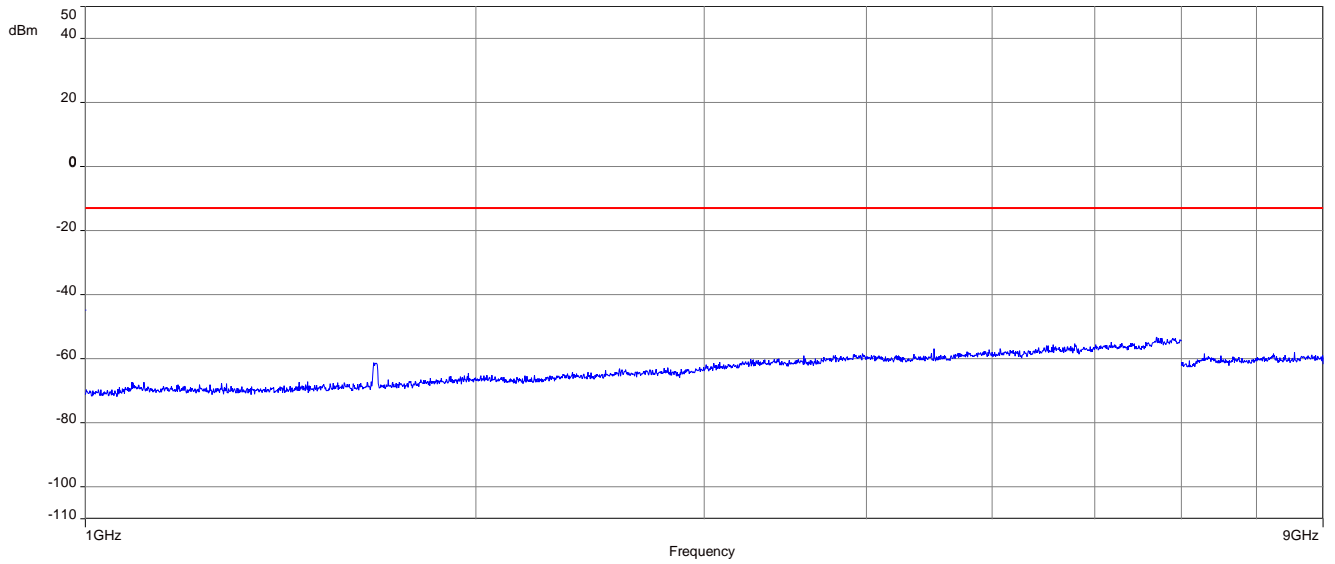

20 Summary of measurement results LTE band 4; 12; 13

<input type="checkbox"/>	No deviations from the technical specifications were ascertained
<input type="checkbox"/>	There were deviations from the technical specifications ascertained
<input checked="" type="checkbox"/>	This test report is only a partial test report. The content and verdict of the performed test cases are listed below.

TC identifier	Description	verdict	date	Remark
RF-Testing	CFR Part 27 RSS-130, RSS 139, RSS-199	See table!	2024-02-02	Delta tests according to manufacturer demand!

20.1 LTE – Band 4

Test Case	temperature conditions	power source voltages	C	NC	NA	NP	Remark
RF Output Power	Nominal	Nominal	<input type="checkbox"/>	<input type="checkbox"/>	<input type="checkbox"/>	<input checked="" type="checkbox"/>	-/-
Frequency Stability	Extreme	Extreme	<input type="checkbox"/>	<input type="checkbox"/>	<input type="checkbox"/>	<input checked="" type="checkbox"/>	-/-
Spurious Emissions Radiated	Nominal	Nominal	<input checked="" type="checkbox"/>	<input type="checkbox"/>	<input type="checkbox"/>	<input type="checkbox"/>	Partial tests
Spurious Emissions Conducted	Nominal	Nominal	<input type="checkbox"/>	<input type="checkbox"/>	<input type="checkbox"/>	<input checked="" type="checkbox"/>	-/-
Block Edge Compliance	Nominal	Nominal	<input type="checkbox"/>	<input type="checkbox"/>	<input type="checkbox"/>	<input checked="" type="checkbox"/>	-/-
Occupied Bandwidth	Nominal	Nominal	<input type="checkbox"/>	<input type="checkbox"/>	<input type="checkbox"/>	<input checked="" type="checkbox"/>	-/-

Notes:

C	Compliant	NC	Not compliant	NA	Not applicable	NP	Not performed
----------	-----------	-----------	---------------	-----------	----------------	-----------	---------------

20.2 LTE – Band 12

Test Case	temperature conditions	power source voltages	C	NC	NA	NP	Remark
RF Output Power	Nominal	Nominal	<input type="checkbox"/>	<input type="checkbox"/>	<input type="checkbox"/>	<input checked="" type="checkbox"/>	-/-
Frequency Stability	Extreme	Extreme	<input type="checkbox"/>	<input type="checkbox"/>	<input type="checkbox"/>	<input checked="" type="checkbox"/>	-/-
Spurious Emissions Radiated	Nominal	Nominal	<input checked="" type="checkbox"/>	<input type="checkbox"/>	<input type="checkbox"/>	<input type="checkbox"/>	Partial tests
Spurious Emissions Conducted	Nominal	Nominal	<input type="checkbox"/>	<input type="checkbox"/>	<input type="checkbox"/>	<input checked="" type="checkbox"/>	-/-
Block Edge Compliance	Nominal	Nominal	<input type="checkbox"/>	<input type="checkbox"/>	<input type="checkbox"/>	<input checked="" type="checkbox"/>	-/-
Occupied Bandwidth	Nominal	Nominal	<input type="checkbox"/>	<input type="checkbox"/>	<input type="checkbox"/>	<input checked="" type="checkbox"/>	-/-

Notes:

C	Compliant	NC	Not compliant	NA	Not applicable	NP	Not performed
----------	-----------	-----------	---------------	-----------	----------------	-----------	---------------

20.3 LTE – Band 13

Test Case	temperature conditions	power source voltages	C	NC	NA	NP	Remark
RF Output Power	Nominal	Nominal	<input type="checkbox"/>	<input type="checkbox"/>	<input type="checkbox"/>	<input checked="" type="checkbox"/>	-/-
Frequency Stability	Extreme	Extreme	<input type="checkbox"/>	<input type="checkbox"/>	<input type="checkbox"/>	<input checked="" type="checkbox"/>	-/-
Spurious Emissions Radiated	Nominal	Nominal	<input checked="" type="checkbox"/>	<input type="checkbox"/>	<input type="checkbox"/>	<input type="checkbox"/>	Partial tests
Spurious Emissions Conducted	Nominal	Nominal	<input type="checkbox"/>	<input type="checkbox"/>	<input type="checkbox"/>	<input checked="" type="checkbox"/>	-/-
Block Edge Compliance	Nominal	Nominal	<input type="checkbox"/>	<input type="checkbox"/>	<input type="checkbox"/>	<input checked="" type="checkbox"/>	-/-
Occupied Bandwidth	Nominal	Nominal	<input type="checkbox"/>	<input type="checkbox"/>	<input type="checkbox"/>	<input checked="" type="checkbox"/>	-/-

Notes:

C	Compliant	NC	Not compliant	NA	Not applicable	NP	Not performed
----------	-----------	-----------	---------------	-----------	----------------	-----------	---------------

21 RF measurements

21.1 Description of test setup

For the spurious measurements we use the substitution method according TIA/EIA 603.

21.2 Results LTE – Band 4

The EUT was set to transmit the maximum power.

21.2.1 Spurious emissions radiated

Description:

The following steps outline the procedure used to measure the radiated emissions from the mobile station. The site is constructed in accordance with ANSI C63.4:2014 requirements and is recognized by the FCC to be in compliance for a 3 and a 10 meter site. The spectrum was scanned from 30 MHz to the 10th harmonic of the highest frequency generated within the equipment, which is the transmitted carrier that can be as high as 1755 MHz. Measurement made up to 26 GHz. The resolution bandwidth is set as outlined in Part 27.53. The spectrum was scanned with the mobile station transmitting at carrier frequencies that pertain to low, mid and high channels of the LTE band 4.

Measurement:

Measurement parameters	
Detector	Peak
Sweep time	2 sec.
Video bandwidth	Below 1 GHz: 300 kHz Above 1 GHz: 3 MHz
Resolution bandwidth	Below 1 GHz: 100 kHz Above 1 GHz: 1 MHz
Span	100 MHz Steps
Trace mode	Max Hold
Setup	See chapter 7.1 - A; 7.2 - A; 7.3 - A
Measurement uncertainty	See chapter 9

Limits:

FCC	ISED
Spurious Emissions Radiated	
Attenuation $\geq 43 + 10\log(P) / (P, \text{Power in Watts})$	
-13 dBm	

QPSK

Spurious Emission Level (dBm)					
Lowest channel		Middle channel		Highest channel	
Spurious emissions	Level [dBm]	Spurious emissions	Level [dBm]	Spurious emissions	Level [dBm]
All detected emissions are more than 20dB below the limit!					
-	-	-	-	-	-
-	-	-	-	-	-
-	-	-	-	-	-
-	-	-	-	-	-
-	-	-	-	-	-
-	-	-	-	-	-
-	-	-	-	-	-

Results: QPSK with 10 MHz channel bandwidth

Plot 1: Middle channel, up to 30 MHz

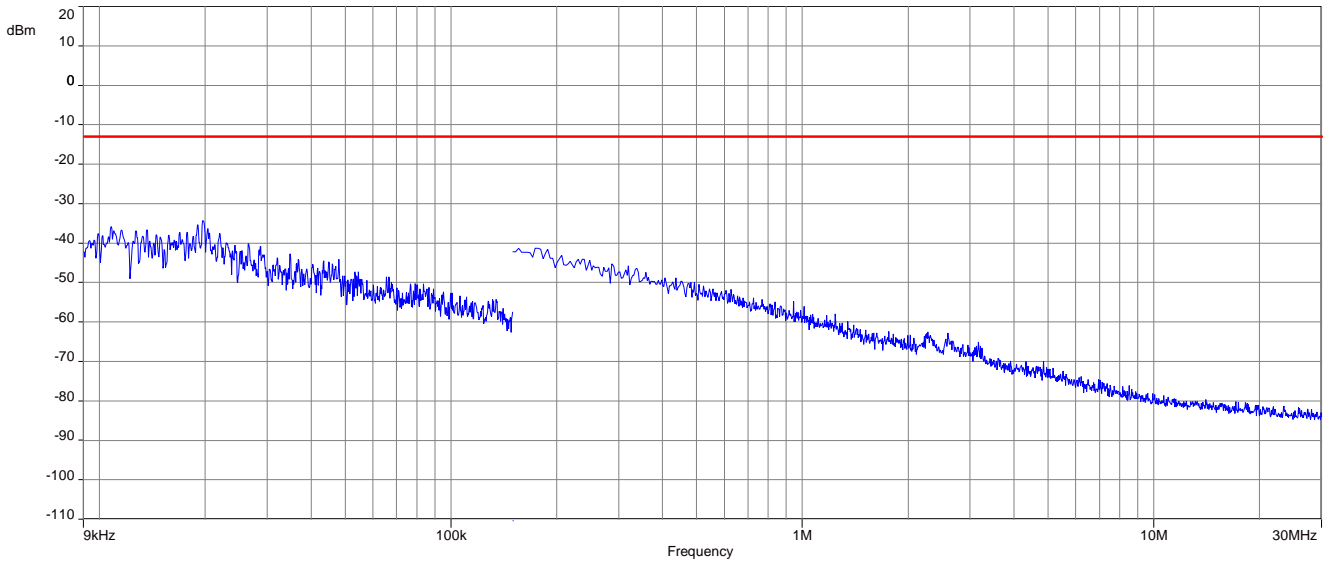

Plot 2: Middle channel, 30 MHz to 1 GHz

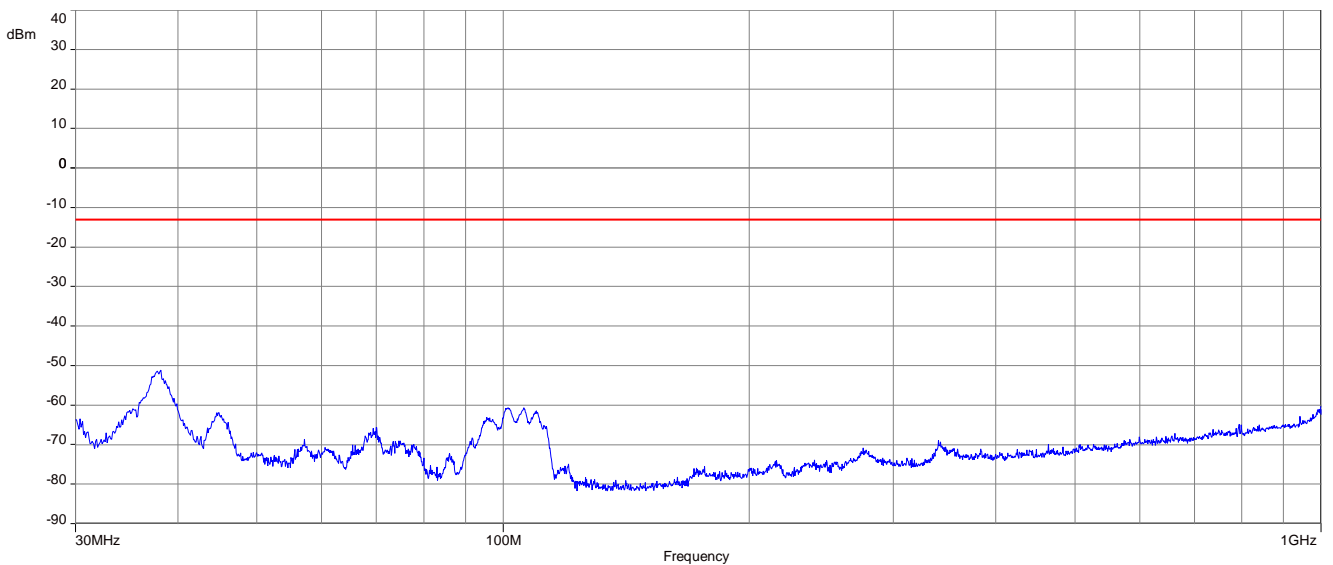

Plot 3: Middle channel, 1 GHz to 18 GHz

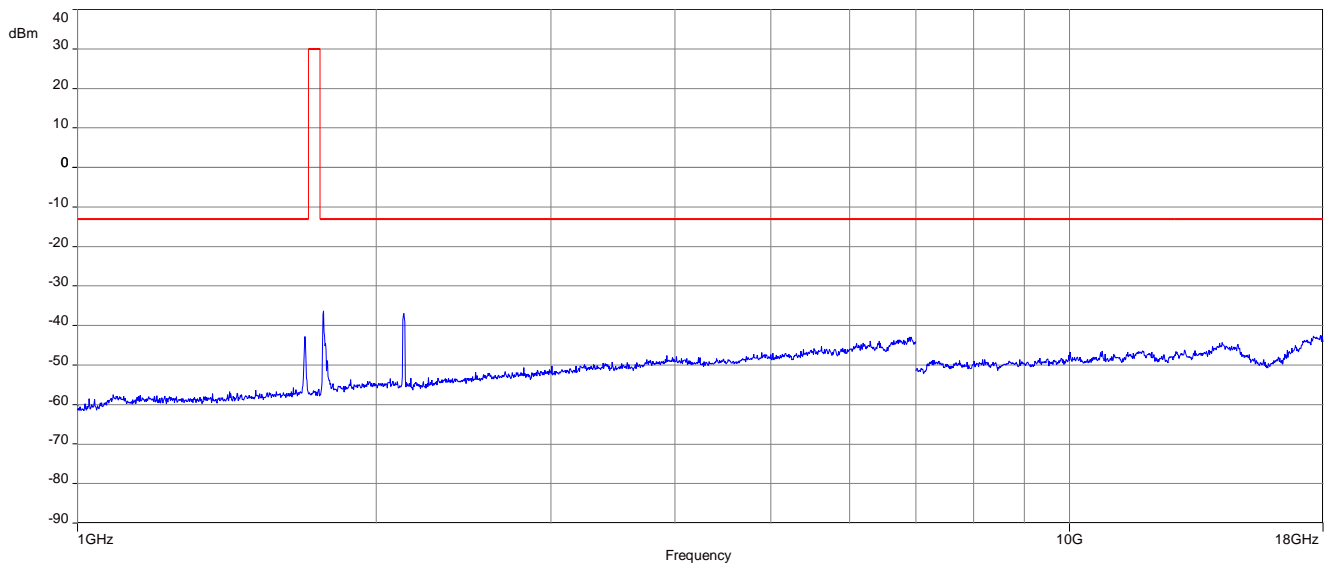

Carrier notched with 1.7 GHz rejection filter, the shown peak around 2.1 GHz is caused by the downlink signal

21.3 Results LTE – Band 12

The EUT was set to transmit the maximum power.

21.3.1 Spurious emissions radiated

Description:

The following steps outline the procedure used to measure the radiated emissions from the mobile station. The site is constructed in accordance with ANSI C63.4:2014 requirements and is recognized by the FCC to be in compliance for a 3 and a 10 meter site. The spectrum was scanned from 30 MHz to the 10th harmonic of the highest frequency generated within the equipment, which is the transmitted carrier that can be as high as 715.3 MHz. This was rounded up to 8 GHz. The resolution bandwidth is set as outlined in Part 27.53. The spectrum was scanned with the mobile station transmitting at carrier frequencies that pertain to low, mid and high channels of the LTE band 12.

Measurement:

Measurement parameters	
Detector	Peak
Sweep time	2 sec.
Video bandwidth	Below 1 GHz: 300 kHz Above 1 GHz: 3 MHz
Resolution bandwidth	Below 1 GHz: 100 kHz Above 1 GHz: 1 MHz
Span	100 MHz Steps
Trace mode	Max Hold
Setup	See chapter 7.1 - A; 7.2 - A
Measurement uncertainty	See chapter 9

Limits:

FCC	ISED
Spurious Emissions Radiated	
Attenuation $\geq 43 + 10\log(P)$ (P, Power in Watts)	
-13 dBm and 1559 MHz to 1610 MHz with -40 dBm	

QPSK

Spurious Emission Level (dBm)					
Lowest channel		Middle channel		Highest channel	
Spurious emissions	Level [dBm]	Spurious emissions	Level [dBm]	Spurious emissions	Level [dBm]
All detected emissions are more than 20dB below the limit!					
-	-	-	-	-	-
-	-	-	-	-	-
-	-	-	-	-	-
-	-	-	-	-	-
-	-	-	-	-	-
-	-	-	-	-	-
-	-	-	-	-	-

Results: QPSK with 10 MHz channel bandwidth

Plot 1: Middle channel, up to 30 MHz

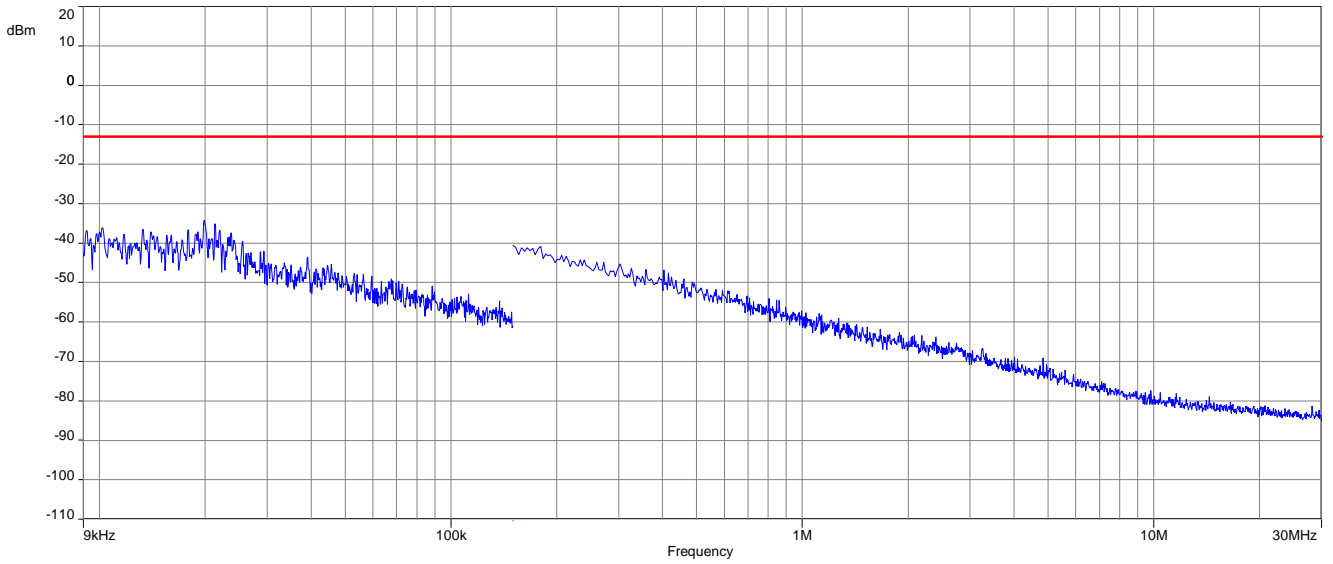

Plot 2: Middle channel, 30 MHz to 1 GHz

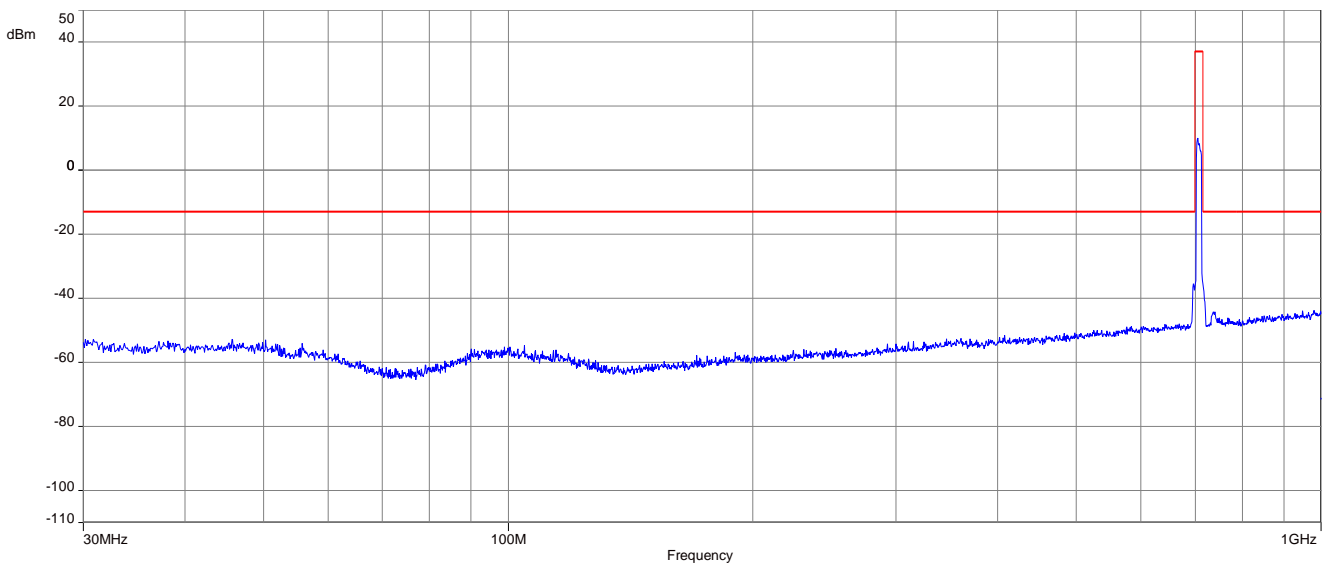

Plot 3: Middle channel, 1 GHz to 8 GHz

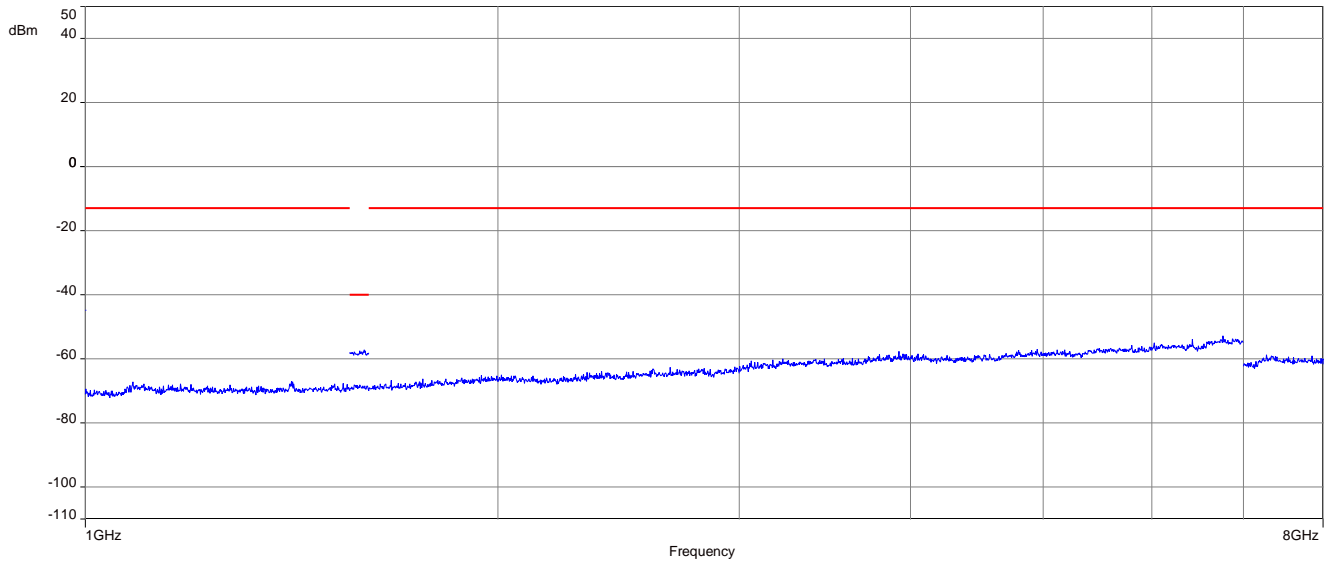

21.4 Results LTE – Band 13

The EUT was set to transmit the maximum power.

21.4.1 Spurious emissions radiated

Description:

The following steps outline the procedure used to measure the radiated emissions from the mobile station. The site is constructed in accordance with ANSI C63.4:2014 requirements and is recognized by the FCC to be in compliance for a 3 and a 10 meter site. The spectrum was scanned from 30 MHz to the 10th harmonic of the highest frequency generated within the equipment, which is the transmitted carrier that can be as high as 784.5 MHz. Measured up to 12.75 GHz. The resolution bandwidth is set as outlined in Part 27.53. The spectrum was scanned with the mobile station transmitting at carrier frequencies that pertain to low, mid and high channels of the LTE band 13.

Measurement:

Measurement parameters	
Detector	Peak
Sweep time	2 sec.
Video bandwidth	Below 1 GHz: 300 kHz Above 1 GHz: 3 MHz
Resolution bandwidth	Below 1 GHz: 100 kHz Above 1 GHz: 1 MHz
Span	100 MHz Steps
Trace mode	Max Hold
Setup	See chapter 7.1 - A; 7.2 - A
Measurement uncertainty	See chapter 9

Limits:

FCC	ISED
Spurious Emissions Radiated	
Attenuation $\geq 43 + 10\log(P)$ (P, Power in Watts)	
-13 dBm	

QPSK

Spurious Emission Level (dBm)					
Lowest channel		Middle channel		Highest channel	
Spurious emissions	Level [dBm]	Spurious emissions	Level [dBm]	Spurious emissions	Level [dBm]
-	-	1564	-60.9	-	-
-	-	-	-	-	-
-	-	-	-	-	-
-	-	-	-	-	-
-	-	-	-	-	-
-	-	-	-	-	-
-	-	-	-	-	-
-	-	-	-	-	-
-	-	-	-	-	-

Results: QPSK with 10 MHz channel bandwidth

Plot 1: Middle channel, up to 30 MHz

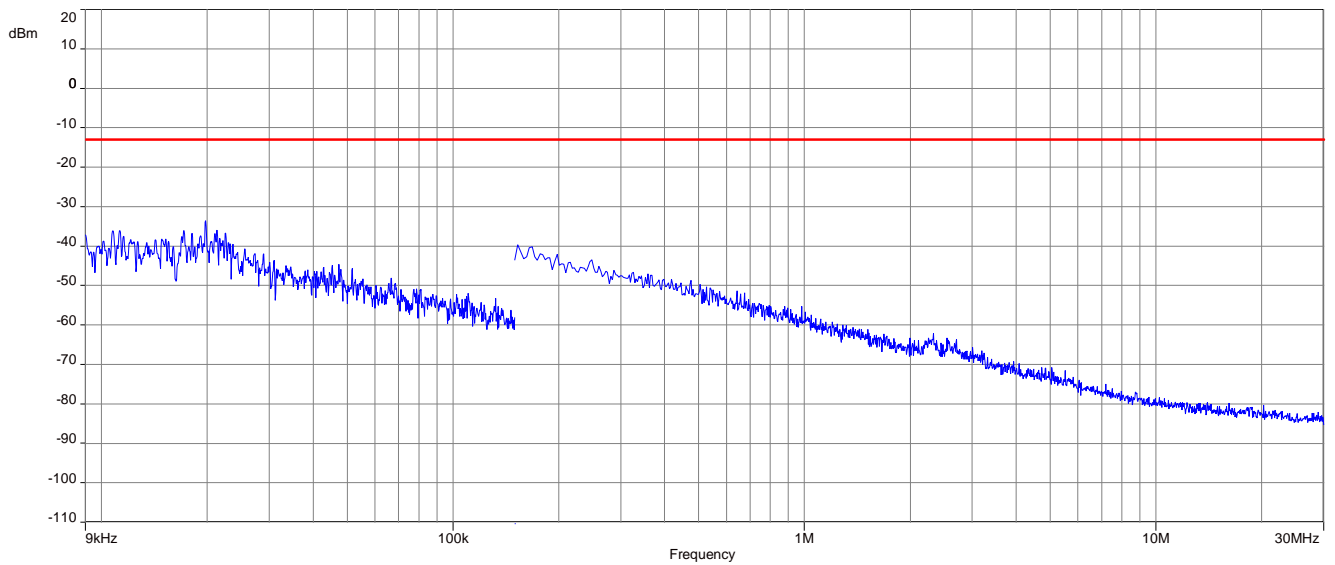

Plot 2: Middle channel, 30 MHz to 1 GHz

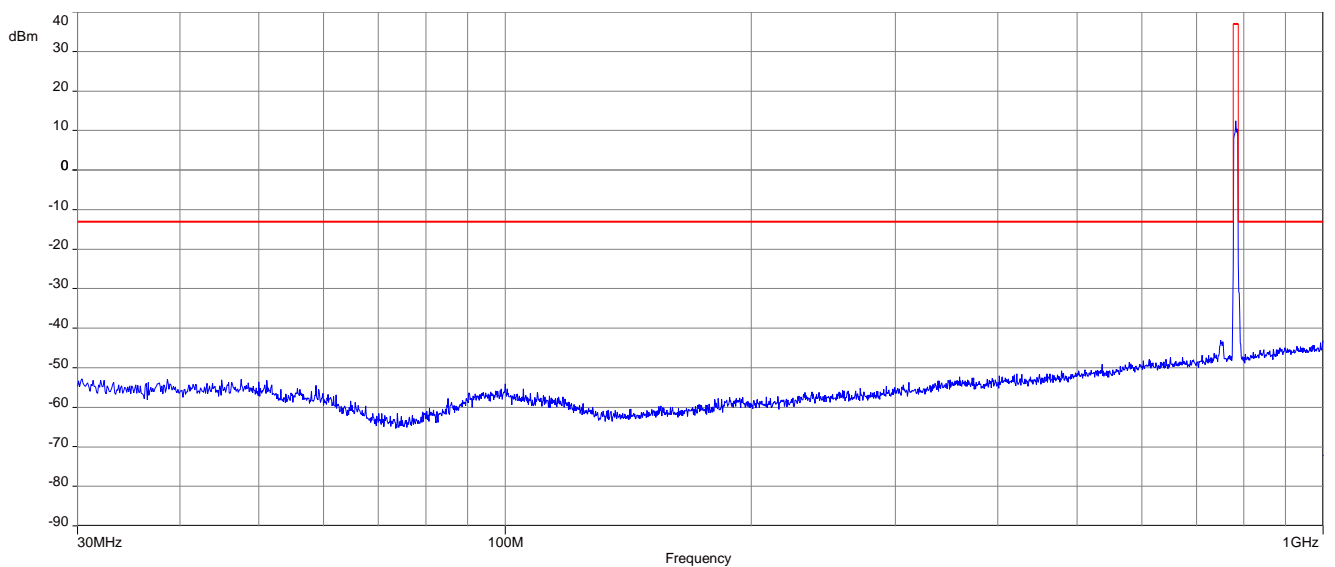

Plot 3: Middle channel, 1 GHz to 8 GHz

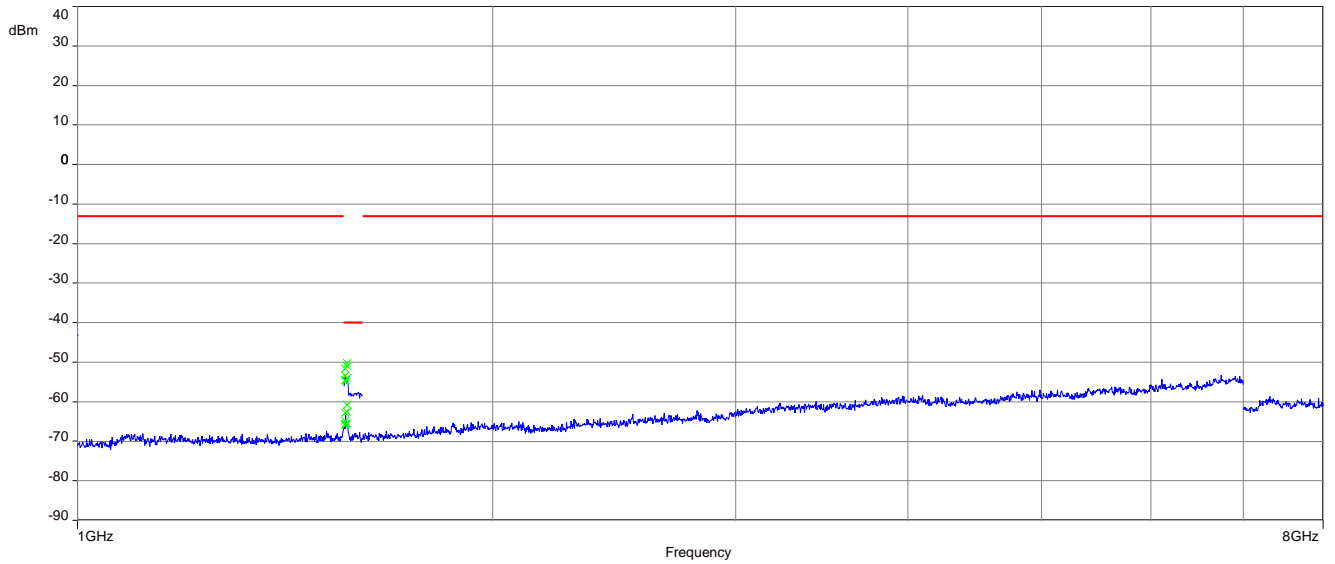

22 Glossary

EUT	Equipment under test
DUT	Device under test
UUT	Unit under test
GUE	GNSS User Equipment
ETSI	European Telecommunications Standards Institute
EN	European Standard
FCC	Federal Communications Commission
FCC ID	Company Identifier at FCC
IC	Industry Canada
PMN	Product marketing name
HMN	Host marketing name
HVIN	Hardware version identification number
FVIN	Firmware version identification number
EMC	Electromagnetic Compatibility
HW	Hardware
SW	Software
Inv. No.	Inventory number
S/N or SN	Serial number
C	Compliant
NC	Not compliant
NA	Not applicable
NP	Not performed
PP	Positive peak
QP	Quasi peak
AVG	Average
OC	Operating channel
OCW	Operating channel bandwidth
OBW	Occupied bandwidth
OOB	Out of band
DFS	Dynamic frequency selection
CAC	Channel availability check
OP	Occupancy period
NOP	Non occupancy period
DC	Duty cycle
PER	Packet error rate
CW	Clean wave
MC	Modulated carrier
WLAN	Wireless local area network
RLAN	Radio local area network
DSSS	Dynamic sequence spread spectrum
OFDM	Orthogonal frequency division multiplexing
FHSS	Frequency hopping spread spectrum
GNSS	Global Navigation Satellite System
C/N₀	Carrier to noise-density ratio, expressed in dB-Hz

23 Document history

Version	Applied changes	Date of release
-/-	Initial release	2024-01-08
A	Update HVIN	2024-02-02

END OF TEST REPORT