

re-measurement at carrier

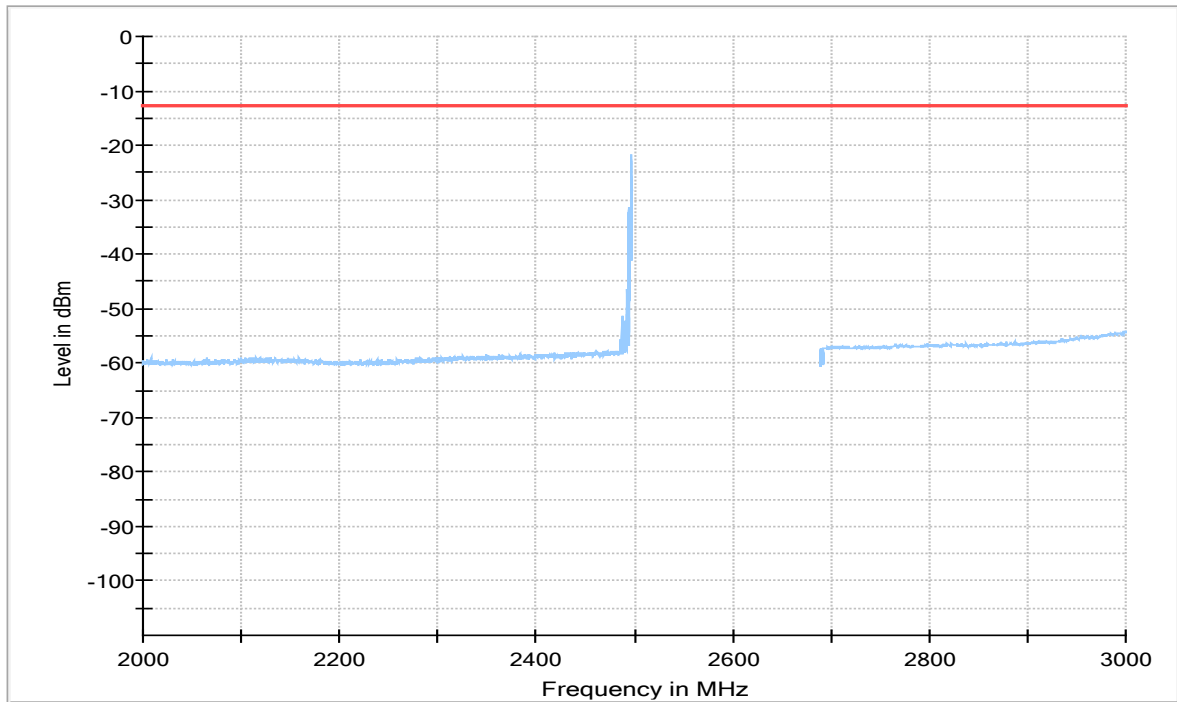

5.18.5 TEST EQUIPMENT USED

- Radiated Emissions

5.19 EMISSION AND OCCUPIED BANDWIDTH

Standard **FCC PART 27 Subpart C**

The test was performed according to:
ANSI C63.26: 2015

5.19.1 TEST DESCRIPTION

This test case is intended to demonstrate compliance to the applicable conducted spurious emission test case per FCC §2.1049 and RSS-GEN 6.7. The limit and the requirements come from the applicable rule part and ISED RSS-Standard for the operating band of the cellular device.

The EUT was connected to the test setups according to the following diagram:

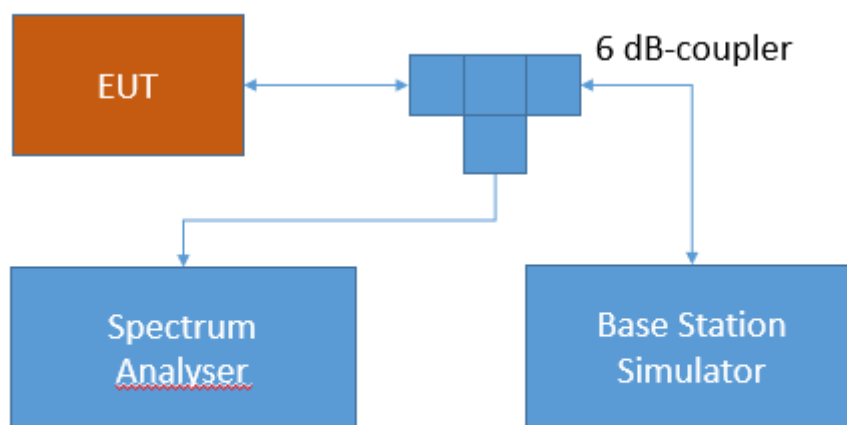

Test Setup FCC Part 22/24/27/90 Cellular;
Spurious Emissions at antenna terminal

The attenuation of the measuring and stimulus path are known for each measured frequency and are considered.

The Spectrum Analyzer settings can be directly found in the measurement diagrams.

5.19.2 TEST REQUIREMENTS / LIMITS

FCC Part 2.1049; Occupied Bandwidth:

The occupied bandwidth, that is the frequency bandwidth such that, below its lower and above its upper frequency limits, the mean powers radiated are each equal to 0.5 percent of the total mean power radiated by a given emission shall be measured under the following conditions as applicable:

(h) Transmitters employing digital modulation techniques—when modulated by an input signal such that its amplitude and symbol rate represent the maximum rated conditions under which the equipment will be operated. The signal shall be applied through any filter networks, pseudo-random generators or other devices required in normal service. Additionally, the occupied bandwidth shall be shown for operation with any devices used for modifying the spectrum when such devices are optional at the discretion of the user.

(i) Transmitters designed for other types of modulation—when modulated by an appropriate signal of sufficient amplitude to be representative of the type of service in which used. A description of the input signal should be supplied.

RSS-GEN; 6.7 Occupied Bandwidth

The emission bandwidth (\times dB) is defined as the frequency range between two points, one above and one below the carrier frequency, at which the spectral density of the emission is attenuated \times dB below the maximum in-band spectral density of the modulated signal. Spectral density (power per unit bandwidth) is to be measured with a detector of resolution bandwidth in the range of 1% to 5% of the anticipated emission bandwidth, and a video bandwidth at least $3\times$ the resolution bandwidth.

When the occupied bandwidth limit is not stated in the applicable RSS or reference measurement method, the transmitted signal bandwidth shall be reported as the 99% emission bandwidth, as calculated or measured.

The transmitter shall be operated at its maximum carrier power measured under normal test conditions.

The span of the analyzer shall be set to capture all products of the modulation process, including the emission skirts.

The resolution bandwidth (RBW) shall be in the range of 1% to 5% of the occupied bandwidth (OBW) and video bandwidth (VBW) shall be approximately $3\times$ RBW.

Note: Video averaging is not permitted.

A peak, or peak hold, may be used in place of the sampling detector as this may produce a wider bandwidth than the actual bandwidth (worst-case measurement). Use of a peak hold may be necessary to determine the occupied bandwidth if the device is not transmitting continuously.

The trace data points are recovered and are directly summed in linear power level terms. The recovered amplitude data points, beginning at the lowest frequency, are placed in a running sum until 0.5% of the total is reached and that frequency recorded. The process is repeated for the highest frequency data points (starting at the highest frequency, at the right side of the span, and going down in frequency). This frequency is then recorded. The difference between the two recorded frequencies is the 99% occupied bandwidth.

5.19.3 TEST PROTOCOL

Ambient temperature: 20 - 28 °C
 Relative humidity: 30 - 45 %

Radio Technology	Channel	Ressource Blocks / Subcarrier	Bandwidth [MHz]	Nominal BW [MHz]	99 % BW [kHz]
LTE eFDD 4 QPSK	low	6	1.4	1.4	1118.24
LTE eFDD 4 QPSK	mid	6	1.4	1.4	1112.22
LTE eFDD 4 QPSK	high	6	1.4	1.4	1100.2
LTE eFDD 4 16QAM	low	6	1.4	1.4	1100.20
LTE eFDD 4 16QAM	mid	6	1.4	1.4	1112.22
LTE eFDD 4 16QAM	high	6	1.4	1.4	1100.20
LTE eFDD 4 QPSK	low	15	3	3	2765.53
LTE eFDD 4 QPSK	mid	15	3	3	2765.53
LTE eFDD 4 QPSK	high	15	3	3	2765.53
LTE eFDD 4 16QAM	low	15	3	3	2777.56
LTE eFDD 4 16QAM	mid	15	3	3	2741.48
LTE eFDD 4 16QAM	high	15	3	3	2753.51
LTE eFDD 4 QPSK	low	25	5	5	4549.1
LTE eFDD 4 QPSK	mid	25	5	5	4529.06
LTE eFDD 4 QPSK	high	25	5	5	4549.1
LTE eFDD 4 16QAM	low	25	5	5	4529.06
LTE eFDD 4 16QAM	mid	25	5	5	4549.10
LTE eFDD 4 16QAM	high	25	5	5	4549.10
LTE eFDD 4 QPSK	low	50	10	10	8977.96
LTE eFDD 4 QPSK	mid	50	10	10	9018.04
LTE eFDD 4 QPSK	high	50	10	10	9018.04
LTE eFDD 4 16QAM	low	12	10	10	2484.97
LTE eFDD 4 16QAM	mid	12	10	10	2525.05
LTE eFDD 4 16QAM	high	12	10	10	2484.97
LTE eFDD 4 QPSK	low	75	15	15	13587.17
LTE eFDD 4 QPSK	mid	75	15	15	13527.05
LTE eFDD 4 QPSK	high	75	15	15	13466.93
LTE eFDD 4 16QAM	low	18	15	15	3727.45
LTE eFDD 4 16QAM	mid	18	15	15	3727.45
LTE eFDD 4 16QAM	high	18	15	15	3727.45
LTE eFDD 4 QPSK	low	100	20	20	17955.91
LTE eFDD 4 QPSK	mid	100	20	20	18036.07
LTE eFDD 4 QPSK	high	100	20	20	18036.07
LTE eFDD 4 16QAM	low	18	20	20	4168.34
LTE eFDD 4 16QAM	mid	18	20	20	4088.18
LTE eFDD 4 16QAM	high	18	20	20	4248.5
LTE eFDD 12 QPSK	low	6	1.4	1.4	1106.21
LTE eFDD 12 QPSK	mid	6	1.4	1.4	1100.2

LTE eFDD 12 QPSK	high	6	1.4	1.4	1106.21
LTE eFDD 12 16QAM	low	6	1.4	1.4	1100.20
LTE eFDD 12 16QAM	mid	6	1.4	1.4	1112.22
LTE eFDD 12 16QAM	high	6	1.4	1.4	1100.20
LTE eFDD 12 QPSK	low	15	3	3	2753.51
LTE eFDD 12 QPSK	mid	15	3	3	2765.53
LTE eFDD 12 QPSK	high	15	3	3	2753.51
LTE eFDD 12 16QAM	low	15	3	3	2777.56
LTE eFDD 12 16QAM	mid	15	3	3	2729.46
LTE eFDD 12 16QAM	high	15	3	3	2741.48
LTE eFDD 12 QPSK	low	25	5	5	4529.06
LTE eFDD 12 QPSK	mid	25	5	5	4509.02
LTE eFDD 12 QPSK	high	25	5	5	4509.02
LTE eFDD 12 16QAM	low	25	5	5	4509.02
LTE eFDD 12 16QAM	mid	25	5	5	4549.10
LTE eFDD 12 16QAM	high	25	5	5	4529.06
LTE eFDD 12 QPSK	low	50	10	10	8977.96
LTE eFDD 12 QPSK	mid	50	10	10	9018.04
LTE eFDD 12 QPSK	high	50	10	10	8977.96
LTE eFDD 12 16QAM	low	12	10	10	2484.97
LTE eFDD 12 16QAM	mid	12	10	10	2525.05
LTE eFDD 12 16QAM	high	12	10	10	2484.97
LTE eFDD 7 QPSK	low	25	5	5	4529.06
LTE eFDD 7 QPSK	mid	25	5	5	4529.06
LTE eFDD 7 QPSK	high	25	5	5	4529.06
LTE eFDD 7 16QAM	low	25	5	5	4529.06
LTE eFDD 7 16QAM	mid	25	5	5	4509.02
LTE eFDD 7 16QAM	high	25	5	5	4529.06
LTE eFDD 7 QPSK	low	50	10	10	8977.96
LTE eFDD 7 QPSK	mid	50	10	10	8977.96
LTE eFDD 7 QPSK	high	50	10	10	9018.04
LTE eFDD 7 16QAM	low	12	10	10	2484.96
LTE eFDD 7 16QAM	mid	12	10	10	2525.05
LTE eFDD 7 16QAM	high	12	10	10	2484.96
LTE eFDD 7 QPSK	low	75	15	15	13527.05
LTE eFDD 7 QPSK	mid	75	15	15	13466.93
LTE eFDD 7 QPSK	high	75	15	15	13527.05
LTE eFDD 7 16QAM	low	18	15	15	3727.45
LTE eFDD 7 16QAM	mid	18	15	15	3727.45
LTE eFDD 7 16QAM	high	18	15	15	3727.45
LTE eFDD 7 QPSK	low	100	20	20	18036.07
LTE eFDD 7 QPSK	mid	100	20	20	18036.07
LTE eFDD 7 QPSK	high	100	20	20	18036.07
LTE eFDD 7 16QAM	low	18	20	20	4088.18
LTE eFDD 7 16QAM	mid	18	20	20	4168.30
LTE eFDD 7 16QAM	high	18	20	20	4168.34
LTE eFDD 13 QPSK	low	25	5	5	4509.02

LTE eFDD 13 QPSK	mid	25	5	5	4509.02
LTE eFDD 13 QPSK	high	25	5	5	4529.06
LTE eFDD 13 16QAM	low	25	5	5	4529.06
LTE eFDD 13 16QAM	mid	25	5	5	4509.02
LTE eFDD 13 16QAM	high	25	5	5	4549.10
LTE eFDD 13 QPSK	mid	50	10	10	8977.96
LTE eFDD 13 16QAM	mid	12	10	10	2484.97
LTE eTDD 38 QPSK	low	25	5	5	4529.06
LTE eTDD 38 QPSK	mid	25	5	5	4509.02
LTE eTDD 38 QPSK	high	25	5	5	4529.06
LTE eTDD 38 16QAM	low	25	5	5	4529.06
LTE eTDD 38 16QAM	mid	25	5	5	4509.02
LTE eTDD 38 16QAM	high	25	5	5	4509.02
LTE eTDD 38 QPSK	low	50	10	10	9138.28
LTE eTDD 38 QPSK	mid	50	10	10	9058.12
LTE eTDD 38 QPSK	high	50	10	10	9058.12
LTE eTDD 38 16QAM	low	12	10	10	2565.13
LTE eTDD 38 16QAM	mid	12	10	10	2525.05
LTE eTDD 38 16QAM	high	12	10	10	2565.13
LTE eTDD 38 QPSK	low	75	15	15	13587.17
LTE eTDD 38 QPSK	mid	75	15	15	13587.17
LTE eTDD 38 QPSK	high	75	15	15	13587.17
LTE eTDD 38 16QAM	low	18	15	15	3907.82
LTE eTDD 38 16QAM	mid	18	15	15	4268.54
LTE eTDD 38 16QAM	high	18	15	15	4208.42
LTE eTDD 38 QPSK	low	100	20	20	18116.23
LTE eTDD 38 QPSK	mid	100	20	20	18116.23
LTE eTDD 38 QPSK	high	100	20	20	18116.23
LTE eTDD 38 16QAM	low	18	20	20	4408.82
LTE eTDD 38 16QAM	mid	18	20	20	4168.34
LTE eTDD 38 16QAM	high	18	20	20	4408.82
eTDD 41 QPSK	low	25	5	5	4539.08
eTDD 41 QPSK	mid	25	5	5	4529.06
eTDD 41 QPSK	high	25	5	5	4509.02
eTDD 41 16QAM	low	25	5	5	4539.08
eTDD 41 16QAM	mid	25	5	5	4529.06
eTDD 41 16QAM	high	25	5	5	4529.06
eTDD 41 QPSK	low	50	10	10	9018.04
eTDD 41 QPSK	mid	50	10	10	9018.04
eTDD 41 QPSK	high	50	10	10	9058.12
eTDD 41 16QAM	low	12	10	10	2525.05
eTDD 41 16QAM	mid	12	10	10	2525.05
eTDD 41 16QAM	high	12	10	10	2525.05
eTDD 41 QPSK	low	75	15	15	13587.17
eTDD 41 QPSK	mid	75	15	15	13527.05
eTDD 41 QPSK	high	75	15	15	13527.05
eTDD 41 16QAM	low	18	15	15	3787.58

eTDD 41 16QAM	mid	18	15	15	3727.45
eTDD 41 16QAM	high	18	15	15	3787.58
eTDD 41 QPSK	low	100	20	20	18116.23
eTDD 41 QPSK	mid	100	20	20	18036.07
eTDD 41 QPSK	high	100	20	20	18116.23
eTDD 41 16QAM	low	18	20	20	4488.98
eTDD 41 16QAM	mid	18	20	20	4148.29
eTDD 41 16QAM	high	18	20	20	4408.82

Remark: Please see next sub-clause for the measurement plot.

5.19.4 MEASUREMENT PLOT (EXAMPLE PLOT, SHOWING WORST CASE, IF APPLICABLE)

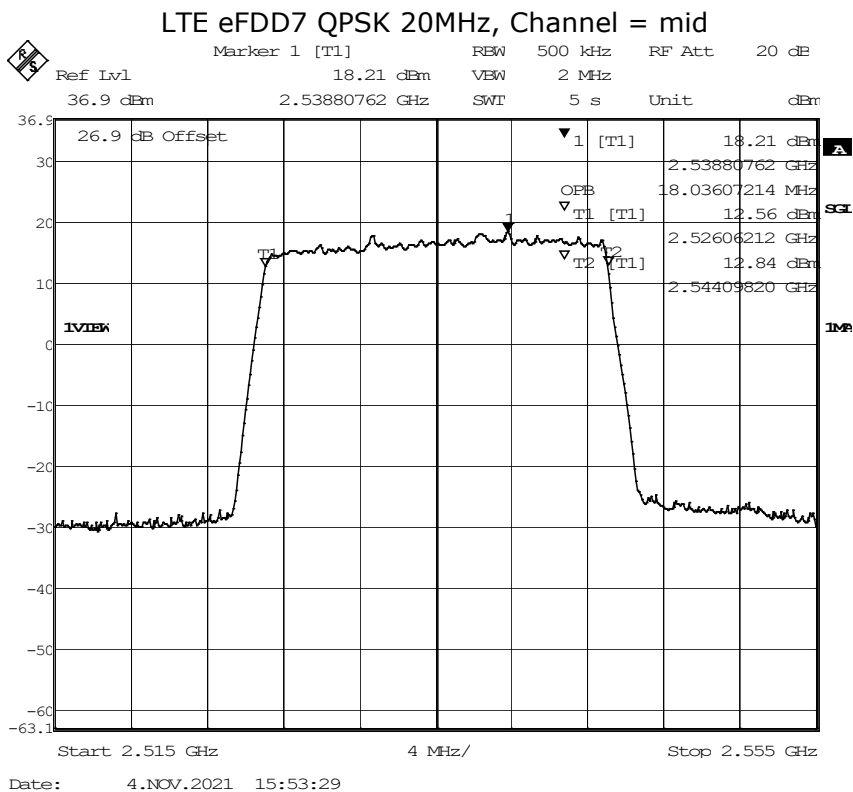
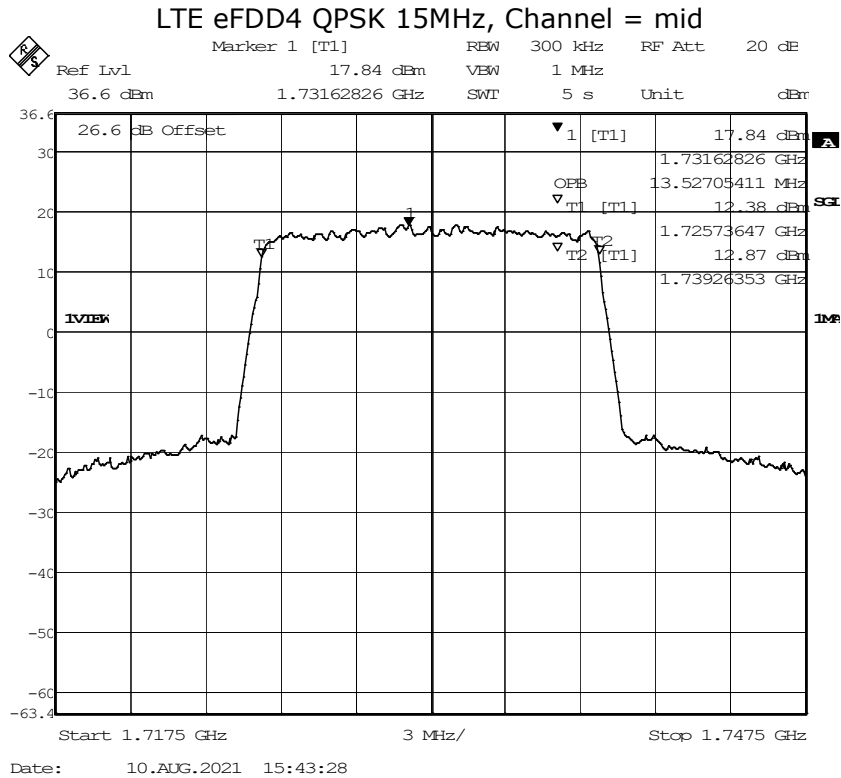

LTE eFDD12 QPSK 10MHz, Channel = mid

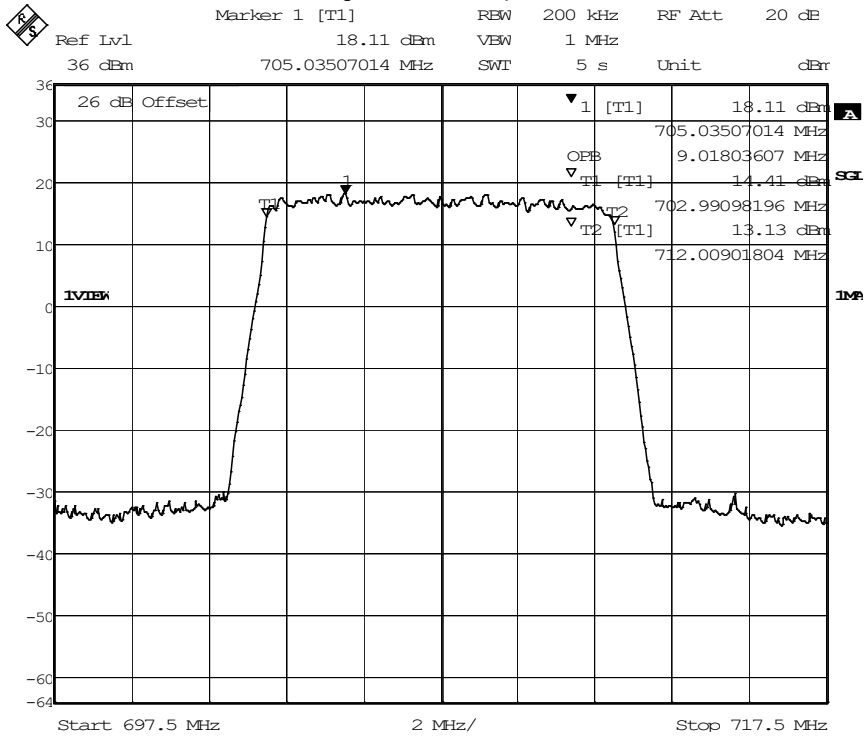

LTE eFDD13 QPSK 10MHz, Channel = mid

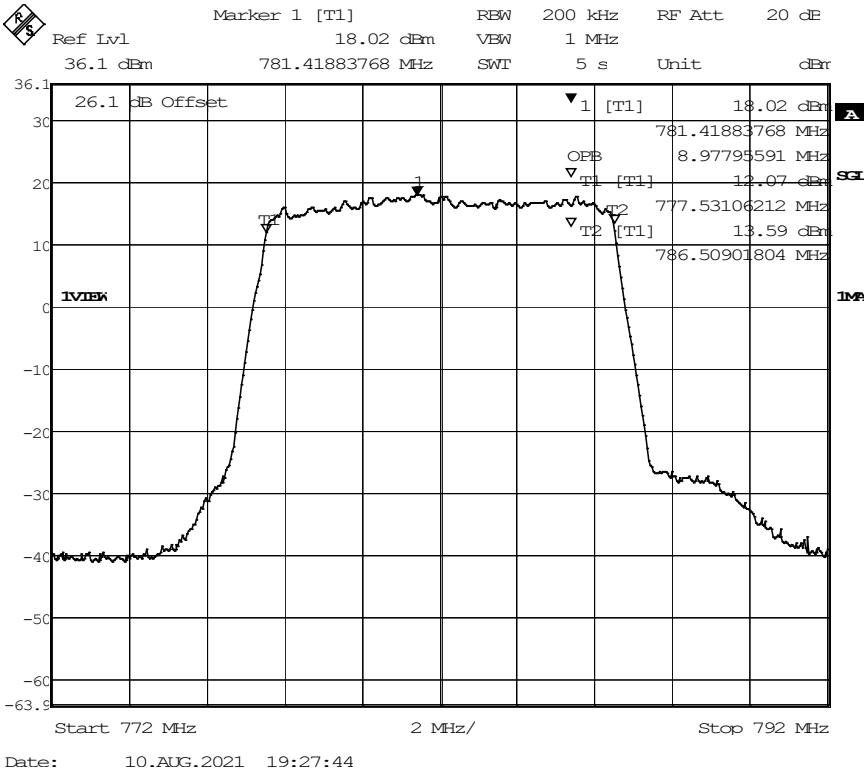

LTE eTDD38 QPSK 10MHz, Channel = mid

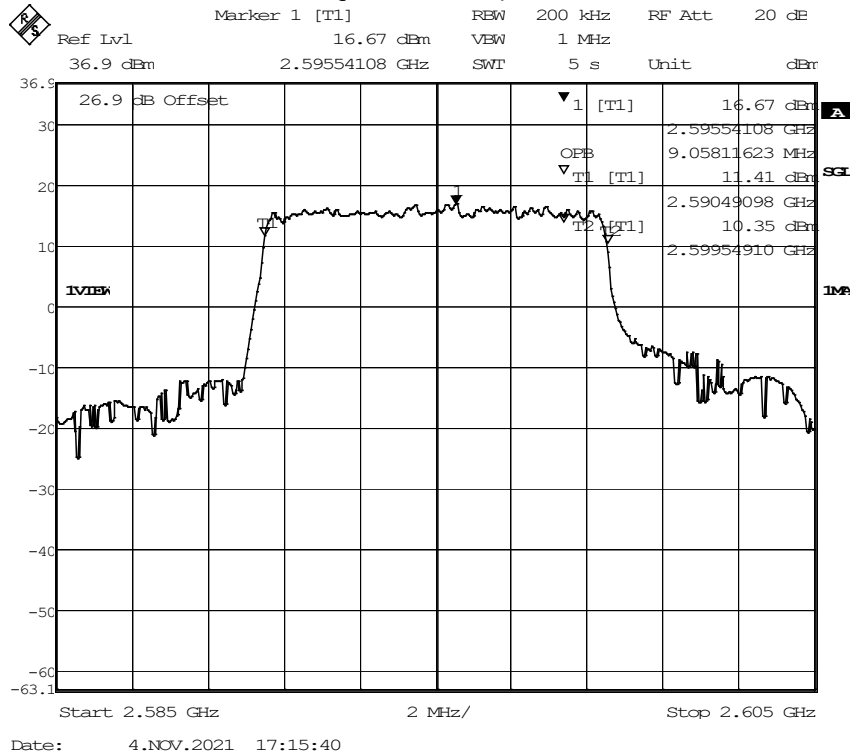

LTE eTDD41 QPSK 10MHz, Channel = mid

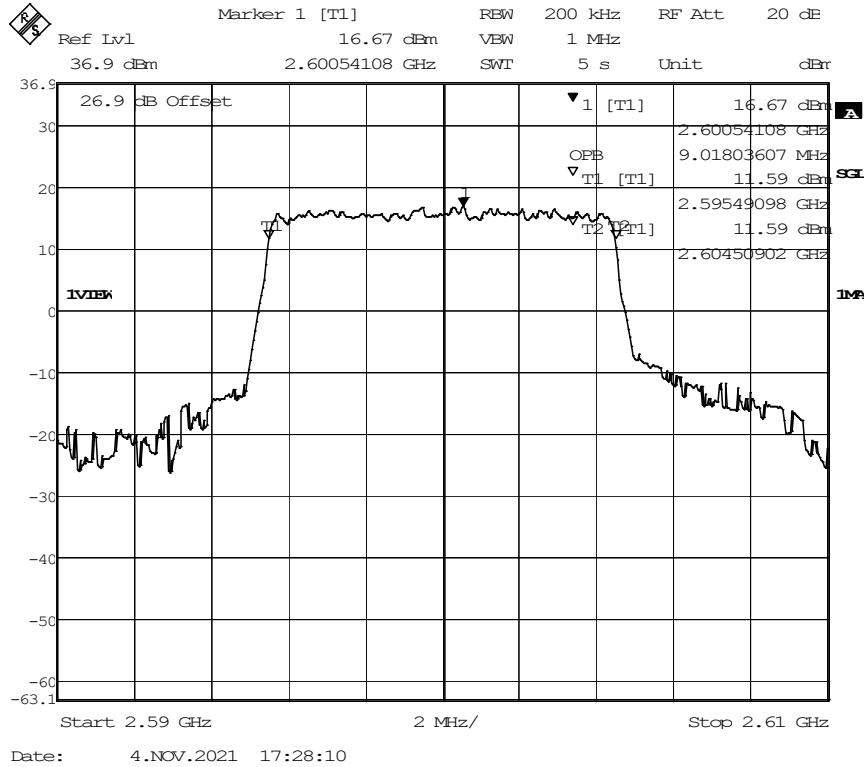

5.19.5 TEST EQUIPMENT USED

- Radio Lab

5.20 BAND EDGE COMPLIANCE

Standard **FCC PART 27 Subpart C**

The test was performed according to:
ANSI C63.26: 2015

5.20.1 TEST DESCRIPTION

This test case is intended to demonstrate compliance to the applicable conducted spurious emission test case per § 2.1051 and RSS-GEN 6.13. The limit comes from the applicable rule part and ISSED RSS-Standard for the operating band of the cellular device.

The EUT was connected to the test setup according to the following diagram:

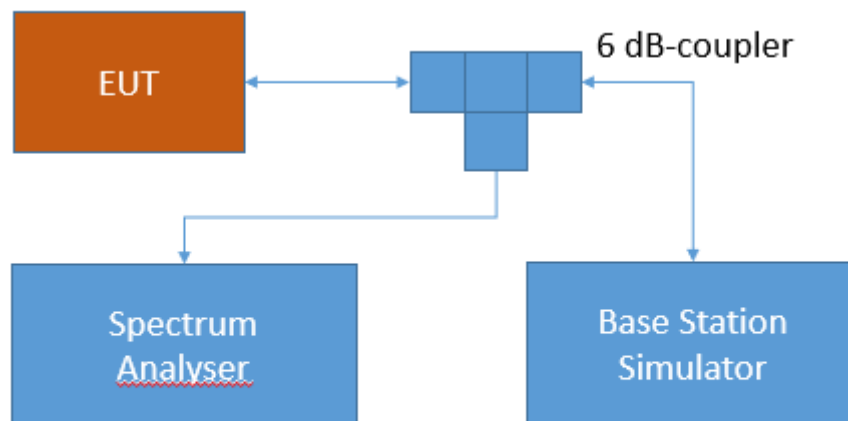

Test Setup FCC Part 22/24/27/90 Cellular;
Band edge compliance

The attenuation of the measuring and stimulus path are known for each measured frequency and are considered.

The Spectrum Analyzer settings can be directly found in the measurement diagrams.

5.20.2 TEST REQUIREMENTS / LIMITS

FCC Part 2.1051; Measurement required: Spurious emissions at antenna terminal:

The radio frequency voltage or powers generated within the equipment and appearing on a spurious frequency shall be checked at the equipment output terminals when properly loaded with a suitable artificial antenna. Curves or equivalent data shall show the magnitude of each harmonic and other spurious emission that can be detected when the equipment is operated under the conditions specified in §2.1049 as appropriate. The magnitude of spurious emissions which are attenuated more than 20 dB below the permissible value need not be specified.

FCC Part 27; Miscellaneous Wireless Communication Services

Subpart C – Technical standards

§27.53 - Emission limits

Band 13

(c) For operations in the 746-758 MHz band and the 776-788 MHz band, the power of any emission outside the licensee's frequency band(s) of operation shall be attenuated below the transmitter power (P) within the licensed band(s) of operation, measured in watts, in accordance with the following:

(1) On any frequency outside the 746-758 MHz band, the power of any emission shall be attenuated outside the band below the transmitter power (P) by at least $43 + 10 \log (P)$ dB;

(2) On any frequency outside the 776-788 MHz band, the power of any emission shall be attenuated outside the band below the transmitter power (P) by at least $43 + 10 \log (P)$ dB;

(3) On all frequencies between 763-775 MHz and 793-805 MHz, by a factor not less than $76 + 10 \log (P)$ dB in a 6.25 kHz band segment, for base and fixed stations;

(4) On all frequencies between 763-775 MHz and 793-805 MHz, by a factor not less than $65 + 10 \log (P)$ dB in a 6.25 kHz band segment, for mobile and portable stations;

(5) Compliance with the provisions of paragraphs (c)(1) and (c)(2) of this section is based on the use of measurement instrumentation employing a resolution bandwidth of 100 kHz or greater. However, in the 100 kHz bands immediately outside and adjacent to the frequency block, a resolution bandwidth of at least 30 kHz may be employed;

(f) For operations in the 746-758 MHz, 775-788 MHz, and 805-806 MHz bands, emissions in the band 1559-1610 MHz shall be limited to -70 dBW/MHz equivalent isotropically radiated power (EIRP) for wideband signals, and -80 dBW EIRP for discrete emissions of less than 700 Hz bandwidth. For the purpose of equipment authorization, a transmitter shall be tested with an antenna that is representative of the type that will be used with the equipment in normal operation.

(6) Compliance with the provisions of paragraphs (c)(3) and (c)(4) of this section is based on the use of measurement instrumentation such that the reading taken with any resolution bandwidth setting should be adjusted to indicate spectral energy in a 6.25 kHz segment.

RSS-130; 4.7.1 General unwanted emissions limits

The unwanted emissions in any 100 kHz bandwidth on any frequency outside the low frequency edge and the high frequency edge of each frequency block range(s), shall be attenuated below the transmitter power, P (dBW), by at least $43 + 10 \log_{10} p$ (watts), dB. However, in the 100 kHz band immediately outside of the equipment's frequency block range, a resolution bandwidth of 30 kHz may be employed.

RSS-130; 4.7.2 Additional unwanted emissions limits

In addition to the limit outlined in section 4.7.1 above, equipment operating in the frequency bands 746-756 MHz and 777-787 MHz shall also comply with the following restrictions:

- a. the power of any unwanted emissions in any 6.25 kHz bandwidth for all frequencies between 763-775 MHz and 793-806 MHz shall be attenuated below the transmitter power, P (dBW), by at least:
 - i. $76 + 10 \log_{10} p$ (watts), dB, for base and fixed equipment and
 - ii. $65 + 10 \log_{10} p$ (watts), dB, for mobile and portable equipment
- b. the e.i.r.p. in the band 1559-1610 MHz shall not exceed -70 dBW/MHz for wideband signal and -80 dBW for discrete emission with bandwidth less than 700 Hz.

Band 12:

(g) For operations in the 600 MHz band and the 698-746 MHz band, the power of any emission outside a licensee's frequency band(s) of operation shall be attenuated below the transmitter power (P) within the licensed band(s) of operation, measured in watts, by at least $43 + 10 \log(P)$ dB. Compliance with this provision is based on the use of measurement instrumentation employing a resolution bandwidth of 100 kilohertz or greater. However, in the 100 kilohertz bands immediately outside and adjacent to a licensee's frequency block, a resolution bandwidth of at least 30 kHz may be employed.

RSS-130; 4.7.1 General unwanted emissions limits

The unwanted emissions in any 100 kHz bandwidth on any frequency outside the low frequency edge and the high frequency edge of each frequency block range(s), shall be attenuated below the transmitter power, P (dBW), by at least $43 + 10 \log_{10} p$ (watts), dB. However, in the 100 kHz band immediately outside of the equipment's frequency block range, a resolution bandwidth of 30 kHz may be employed.

RSS-130; 4.7.2 Additional unwanted emissions limits

In addition to the limit outlined in section 4.7.1 above, equipment operating in the frequency bands 746-756 MHz and 777-787 MHz shall also comply with the following restrictions:

- a. the power of any unwanted emissions in any 6.25 kHz bandwidth for all frequencies between 763-775 MHz and 793-806 MHz shall be attenuated below the transmitter power, P (dBW), by at least:
 - i. $76 + 10 \log_{10} p$ (watts), dB, for base and fixed equipment and
 - ii. $65 + 10 \log_{10} p$ (watts), dB, for mobile and portable equipment
- b. the e.i.r.p. in the band 1559-1610 MHz shall not exceed -70 dBW/MHz for wideband signal and -80 dBW for discrete emission with bandwidth less than 700 Hz.

Band 4/10/66:

(h) *AWS emission limits— (1) General protection levels.* Except as otherwise specified below, for operations in the 1695-1710 MHz, 1710-1755 MHz, 1755-1780 MHz, 1915-1920 MHz, 1995-2000 MHz, 2000-2020 MHz, 2110-2155 MHz, 2155-2180 MHz, and 2180-2200 bands, the power of any emission outside a licensee's frequency block shall be attenuated below the transmitter power (P) in watts by at least $43 + 10 \log_{10}(P)$ dB.

RSS-139; 6.6 Transmitter Unwanted Emissions

Equipment shall comply with the limits in (i) and (ii) below.

- i. In the first 1.0 MHz bands immediately outside and adjacent to the equipment's smallest operating frequency block, which can contain the equipment's occupied bandwidth, the emission power per any 1% of the emission bandwidth shall be attenuated below the transmitter output power P (in dBW) by at least $43 + 10 \log_{10} p$ (watts) dB.
- ii. After the first 1.0 MHz outside the equipment's smallest operating frequency block, which can contain the equipment's occupied bandwidth, the emission power in any 1 MHz bandwidth shall be attenuated below the transmitter output power P (in dBW) by at least $43 + 10 \log_{10} p$ (watts) dB.

Band 7:

(m) For BRS and EBS stations, the power of any emissions outside the licensee's frequency bands of operation shall be attenuated below the transmitter power (P) measured in watts in accordance with the standards below. If a licensee has multiple contiguous channels, out-of-band emissions shall be measured from the upper and lower edges of the contiguous channels.

(4) For mobile digital stations, the attenuation factor shall be not less than $40 + 10 \log (P)$ dB on all frequencies between the channel edge and 5 megahertz from the channel edge, $43 + 10 \log (P)$ dB on all frequencies between 5 megahertz and X megahertz from the channel edge, and $55 + 10 \log (P)$ dB on all frequencies more than X megahertz from the channel edge, where X is the greater of 6 megahertz or the actual emission bandwidth as defined in paragraph (m)(6) of this section. In addition, the attenuation factor shall not be less than $43 + 10 \log (P)$ dB on all frequencies between 2490.5 MHz and 2496 MHz and $55 + 10 \log (P)$ dB at or below 2490.5 MHz. Mobile Satellite Service licensees operating on frequencies below 2495 MHz may also submit a documented interference complaint against BRS licensees operating on channel BRS Channel 1 on the same terms and conditions as adjacent channel BRS or EBS licensees.

RSS-199; 4.5 Transmitter unwanted emissions

In the 1 MHz band immediately outside and adjacent to the channel edge, the unwanted emission power shall be measured with a resolution bandwidth of at least 1% of the occupied bandwidth for base station and fixed subscriber equipment, and 2% for mobile subscriber equipment. Beyond the 1 MHz band, a resolution bandwidth of 1 MHz shall be used. A narrower resolution bandwidth can be used, provided that the measured power is integrated over the full required measurement bandwidth of 1 MHz, or 1% or 2% of the occupied bandwidth, as applicable.

Equipment shall comply with the following unwanted emission limits:

b. for mobile subscriber equipment, the power of any unwanted emissions measured as above shall be attenuated (in dB) below the transmitter power, P (dBW), by at least:

$40 + 10 \log_{10} p$ from the channel edges to 5 MHz away

$43 + 10 \log_{10} p$ between 5 MHz and X MHz from the channel edges, and

$55 + 10 \log_{10} p$ at X MHz and beyond from the channel edges

In addition, the attenuation shall not be less than $43 + 10 \log_{10} p$ on all frequencies between 2490.5 MHz and 2496 MHz, and $55 + 10 \log_{10} p$ at or below 2490.5 MHz.

In (b), p is the transmitter power measured in watts and X is 6 MHz or the equipment occupied bandwidth, whichever is greater.

Band 17:

(g) For operations in the 600 MHz band and the 698-746 MHz band, the power of any emission outside a licensee's frequency band(s) of operation shall be attenuated below the transmitter power (P) within the licensed band(s) of operation, measured in watts, by at least $43 + 10 \log(P)$ dB. Compliance with this provision is based on the use of measurement instrumentation employing a resolution bandwidth of 100 kilohertz or greater. However, in the 100 kilohertz bands immediately outside and adjacent to a licensee's frequency block, a resolution bandwidth of at least 30 kHz may be employed.

RSS-130; 4.7.1 General unwanted emissions limits

The unwanted emissions in any 100 kHz bandwidth on any frequency outside the low frequency edge and the high frequency edge of each frequency block range(s), shall be attenuated below the transmitter power, P (dBW), by at least $43 + 10 \log_{10} p$ (watts), dB. However, in the 100 kHz band immediately outside of the equipment's frequency block range, a resolution bandwidth of 30 kHz may be employed.

RSS-130; 4.7.2 Additional unwanted emissions limits

In addition to the limit outlined in section 4.7.1 above, equipment operating in the frequency bands 746-756 MHz and 777-787 MHz shall also comply with the following restrictions:

- a. the power of any unwanted emissions in any 6.25 kHz bandwidth for all frequencies between 763-775 MHz and 793-806 MHz shall be attenuated below the transmitter power, P (dBW), by at least:
 - i. $76 + 10 \log_{10} p$ (watts), dB, for base and fixed equipment and
 - ii. $65 + 10 \log_{10} p$ (watts), dB, for mobile and portable equipment
- b. the e.i.r.p. in the band 1559-1610 MHz shall not exceed -70 dBW/MHz for wideband signal and -80 dBW for discrete emission with bandwidth less than 700 Hz.

5.20.3 TEST PROTOCOL

Ambient temperature: 20 - 28 °C
 Relative humidity: 30 - 45 %

Radio Technology	Channel	Ressource Blocks	Bandwidth [MHz]	Peak [dBm]	Average [dBm]	RMS [dBm]	Limit /dBm	Margin to Limit /dB
eFDD 4 QPSK	low	6	1.4	-18.54	-26.60	-25.62	-13	12.62
eFDD 4 QPSK	high	6	1.4	-18.60	-28.86	-27.84	-13	14.84
eFDD 4 16QAM	low	6	1.4	-18.73	-28.70	-27.70	-13	14.70
eFDD 4 16QAM	high	6	1.4	-19.32	-30.34	-29.42	-13	16.42
eFDD 4 QPSK	low	15	3	-14.53	-26.60	-25.26	-13	12.26
eFDD 4 QPSK	high	15	3	-16.18	-28.60	-27.14	-13	14.14
eFDD 4 16QAM	low	15	3	-17.61	-29.52	-28.18	-13	15.18
eFDD 4 16QAM	high	15	3	-16.57	-31.36	-29.42	-13	16.42
eFDD 4 QPSK	low	25	5	-15.34	-28.44	-26.81	-13	13.81
eFDD 4 QPSK	high	25	5	-15.53	-29.72	-27.84	-13	14.84
eFDD 4 16QAM	low	25	5	-15.49	-30.44	-28.18	-13	15.18
eFDD 4 16QAM	high	25	5	-16.27	-32.12	-30.02	-13	17.02
eFDD 4 QPSK	low	50	10	-17.15	-29.52	-28.44	-13	15.44
eFDD 4 QPSK	high	50	10	-17.80	-31.73	-30.34	-13	17.34
eFDD 4 16QAM	low	12	10	-11.58	-24.42	-23.36	-13	10.36
eFDD 4 16QAM	high	12	10	-13.51	-27.60	-26.10	-13	13.10
eFDD 4 QPSK	low	75	15	-16.36	-29.24	-28.44	-13	15.44
eFDD 4 QPSK	high	75	15	-16.09	-31.73	-30.34	-13	17.34
eFDD 4 16QAM	low	18	15	-14.37	-26.81	-25.62	-13	12.62
eFDD 4 16QAM	high	18	15	-15.31	-29.14	-28.08	-13	15.08
eFDD 4 QPSK	low	100	20	-20.63	-30.77	-29.82	-13	16.82
eFDD 4 QPSK	high	100	20	-18.01	-32.12	-31.01	-13	18.01
eFDD 4 16QAM	low	18	20	-14.71	-25.26	-24.26	-13	11.26
eFDD 4 16QAM	high	18	20	-14.57	-28.08	-26.50	-13	13.50
eFDD 7 QPSK	low	25	5	-11.37	-30.71	-27.07	-13	14.07
eFDD 7 QPSK	high	25	5	-28.78	-39.58	-26.41	-13	13.41
eFDD 7 16QAM	low	25	5	-12.66	-31.43	-27.78	-13	14.78
eFDD 7 16QAM	high	25	5	-10.39	-30.37	-26.84	-13	13.84
eFDD 7 QPSK	low	50	10	-12.11	-32.22	-30.37	-13	17.37
eFDD 7 QPSK	high	50	10	-11.20	-31.82	-30.04	-13	17.04
eFDD 7 16QAM	low	50	10	-8.13	-27.07	-24.86	-13	11.86
eFDD 7 16QAM	high	50	10	-5.85	-26.00	-24.02	-13	11.02
eFDD 7 QPSK	low	75	15	-12.46	-32.64	-31.43	-13	18.43
eFDD 7 QPSK	high	75	15	-13.84	-31.82	-30.71	-13	17.71
eFDD 7 16QAM	low	75	15	-9.58	-28.04	-26.62	-13	13.62
eFDD 7 16QAM	high	75	15	-9.35	-26.84	-25.80	-13	12.8
eFDD 7 QPSK	low	100	20	-10.91	-27.54	-26.41	-13	13.41
eFDD 7 QPSK	high	100	20	-10.35	-27.30	-26.20	-13	13.2
eFDD 7 16QAM	low	100	20	-5.96	-19.78	-18.84	-13	5.84
eFDD 7 16QAM	high	100	20	-3.18	-18.58	-17.68	-13	4.68

eFDD 12 QPSK	low	6	1.4	-17.45	-29.74	-27.52	-13	14.52
eFDD 12 QPSK	high	6	1.4	-15.17	-31.27	-28.94	-13	15.94
eFDD 12 16QAM	low	6	1.4	-17.97	-31.96	-29.46	-13	16.46
eFDD 12 16QAM	high	6	1.4	-18.74	-33.54	-30.94	-13	17.94
eFDD 12 QPSK	low	15	3	-16.04	-30.32	-27.52	-13	14.52
eFDD 12 QPSK	high	15	3	-18.20	-32.33	-29.74	-13	16.74
eFDD 12 16QAM	low	15	3	-18.75	-33.54	-30.32	-13	17.32
eFDD 12 16QAM	high	15	3	-19.16	-34.96	-31.61	-13	18.61
eFDD 12 QPSK	low	25	5	-16.28	-33.54	-30.02	-13	17.02
eFDD 12 QPSK	high	25	5	-14.86	-33.54	-30.02	-13	17.02
eFDD 12 16QAM	low	25	5	-15.97	-34.96	-31.27	-13	18.27
eFDD 12 16QAM	high	25	5	-17.18	-36.04	-31.96	-13	18.96
eFDD 12 QPSK	low	50	10	-10.27	-31.61	-28.68	-13	15.68
eFDD 12 QPSK	high	50	10	-11.04	-31.27	-28.94	-13	15.94
eFDD 12 16QAM	low	12	10	-7.54	-26.50	-24.00	-13	11.00
eFDD 12 16QAM	high	12	10	-6.46	-26.70	-24.30	-13	11.30
eFDD 13 QPSK	low	6	5	-21.93	-34.36	-32.23	-13	19.23
eFDD 13 QPSK	high	6	5	-20.23	-34.86	-32.62	-13	19.62
eFDD 13 16QAM	low	6	5	-22.19	-37.19	-34.36	-13	21.36
eFDD 13 16QAM	high	6	5	-21.86	-36.54	-33.89	-13	20.89
eFDD 13 QPSK	low	15	10	-27.11	-39.47	-37.88	-13	24.88
eFDD 13 QPSK	high	15	10	-26.91	-40.38	-38.64	-13	25.64
eFDD 13 16QAM	low	15	10	-24.22	-35.94	-34.36	-13	21.36
eFDD 13 16QAM	high	15	10	-23.66	-37.19	-35.38	-13	22.38
eTDD 38 QPSK	low	25	5	-13.07	-35.14	-30.04	-13	17.04
eTDD 38 QPSK	high	25	5	-8.44	-36.39	-30.04	-13	17.04
eTDD 38 16QAM	low	25	5	-11.81	-35.74	-30.04	-13	17.04
eTDD 38 16QAM	high	25	5	-10.71	-37.08	-30.71	-13	17.71
eTDD 38 QPSK	low	50	10	-11.54	-36.39	-31.82	-13	18.82
eTDD 38 QPSK	high	50	10	-7.06	-37.84	-32.64	-13	19.64
eTDD 38 16QAM	low	12	10	-5.20	-31.43	-26.41	-13	13.41
eTDD 38 16QAM	high	12	10	-3.82	-31.43	-26.00	-13	13.00
eTDD 38 QPSK	low	75	15	-14.03	-36.39	-31.82	-13	18.82
eTDD 38 QPSK	high	75	15	-4.96	-37.84	-33.56	-13	20.56
eTDD 38 16QAM	low	18	15	-4.03	-33.56	-28.84	-13	15.84
eTDD 38 16QAM	high	18	15	-2.03	-33.56	-29.12	-13	16.12
eTDD 38 QPSK	low	100	20	-9.56	-33.09	-29.72	-13	16.72
eTDD 38 QPSK	high	100	20	-10.12	-33.09	-29.12	-13	16.12
eTDD 38 16QAM	low	100	20	-1.83	-26.20	-21.89	-13	8.89
eTDD 38 16QAM	high	100	20	-0.75	-26.00	-21.52	-13	8.52
eTDD 41 QPSK	low	25	5	-12.90	-35.14	-30.04	-13	17.04
eTDD 41 QPSK	high	25	5	-9.50	-34.06	-28.84	-13	15.84
eTDD 41 16QAM	low	25	5	-11.23	-35.74	-29.72	-13	16.72
eTDD 41 16QAM	high	25	5	-9.16	-35.74	-29.72	-13	16.72
eTDD 41 QPSK	low	50	10	-10.29	-35.74	-31.06	-13	18.06
eTDD 41 QPSK	high	50	10	-10.18	-35.14	-30.37	-13	17.37
eTDD 41 16QAM	low	50	10	-5.43	-31.82	-26.00	-13	13.00

eTDD 41 16QAM	high	50	10	-5.44	-30.04	-25.04	-13	12.04
eTDD 41 QPSK	low	75	15	-7.10	-36.39	-32.22	-13	19.22
eTDD 41 QPSK	high	75	15	-7.77	-34.58	-30.71	-13	17.71
eTDD 41 16QAM	low	75	15	-5.14	-33.56	-28.84	-13	15.84
eTDD 41 16QAM	high	75	15	-6.83	-32.22	-28.04	-13	15.04
eTDD 41 QPSK	low	100	20	-8.47	-32.64	-28.56	-13	15.56
eTDD 41 QPSK	high	100	20	-5.76	-31.43	-27.78	-13	14.78
eTDD 41 16QAM	low	100	20	-0.16	-26.00	-21.40	-13	8.40
eTDD 41 16QAM	high	100	20	-2.55	-25.04	-20.50	-13	7.50

Remark: Please see next sub-clause for the measurement plot.

5.20.4 MEASUREMENT PLOT (EXAMPLE PLOT, SHOWING WORST CASE, IF APPLICABLE)

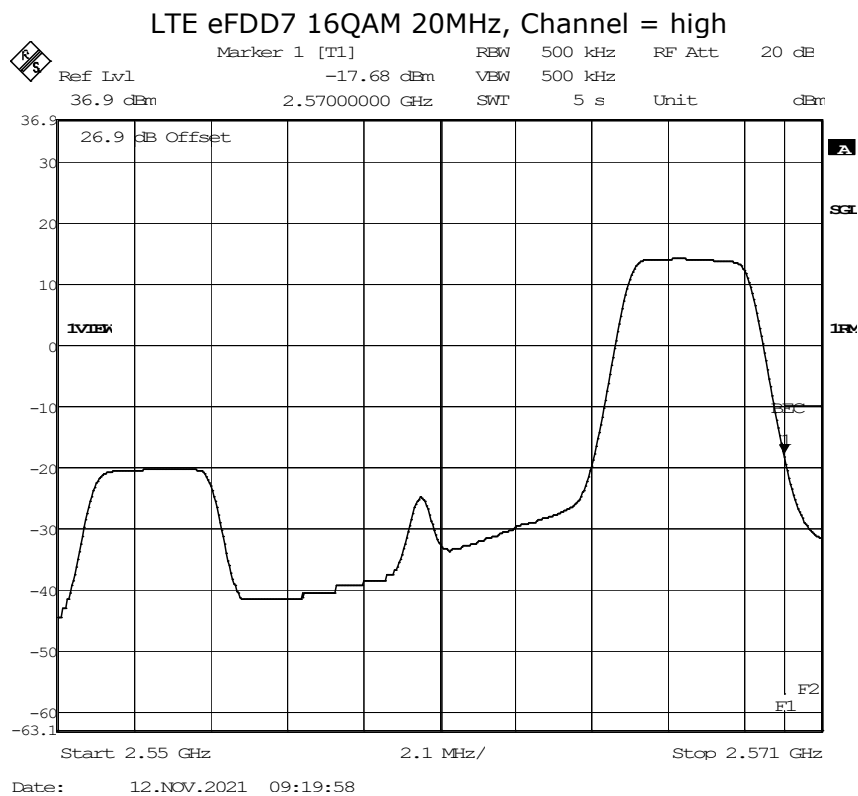
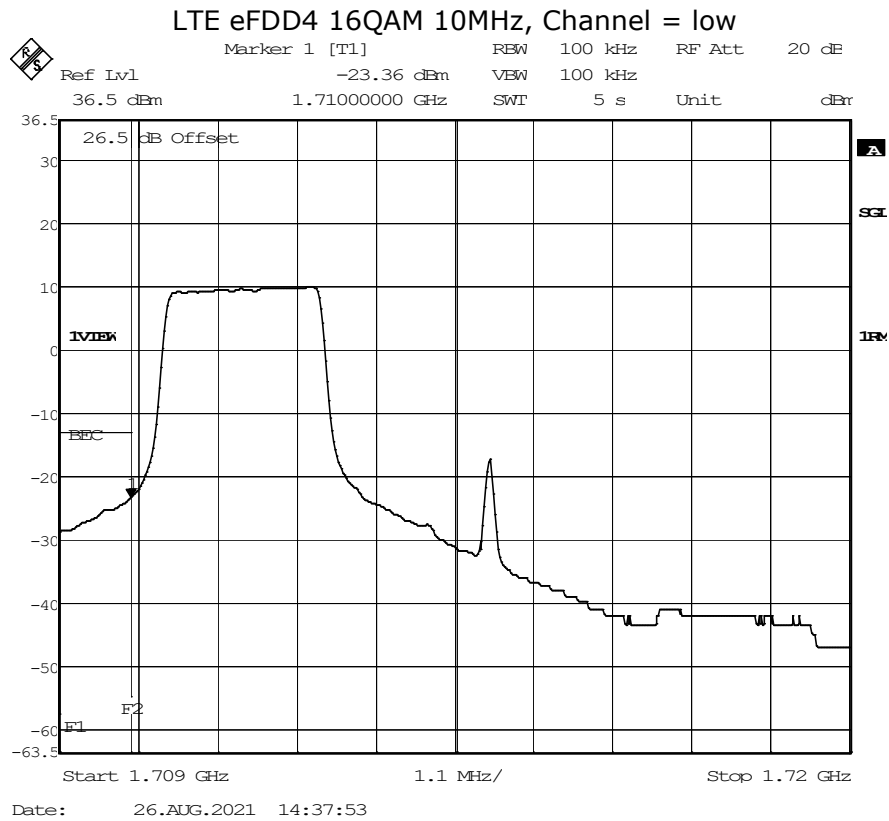

LTE eFDD12 16QAM 10MHz, Channel = low

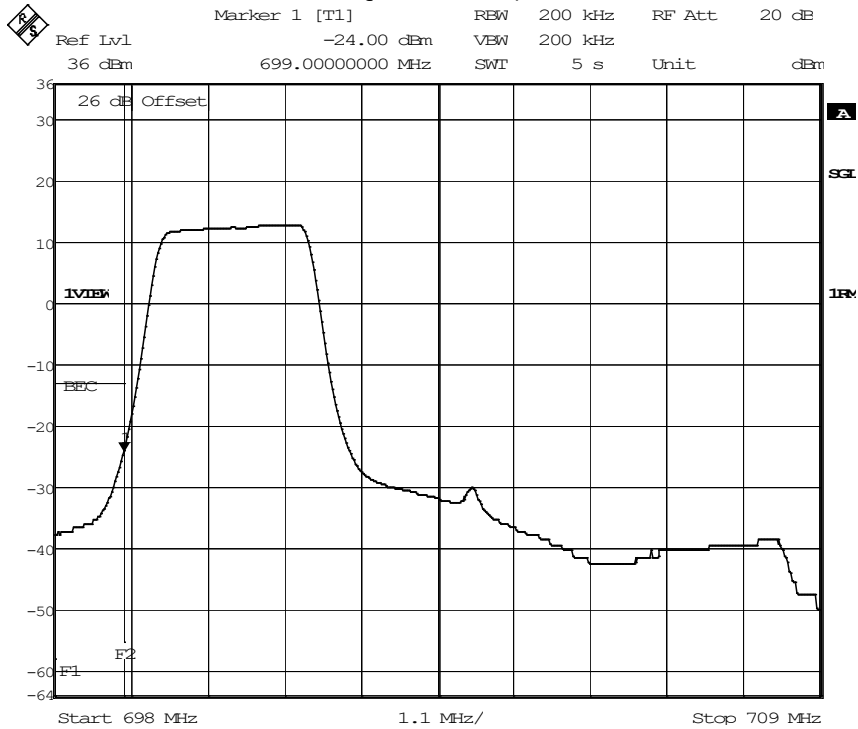

Date: 26.AUG.2021 15:10:58

LTE eFDD13 QPSK 5MHz, Channel = low

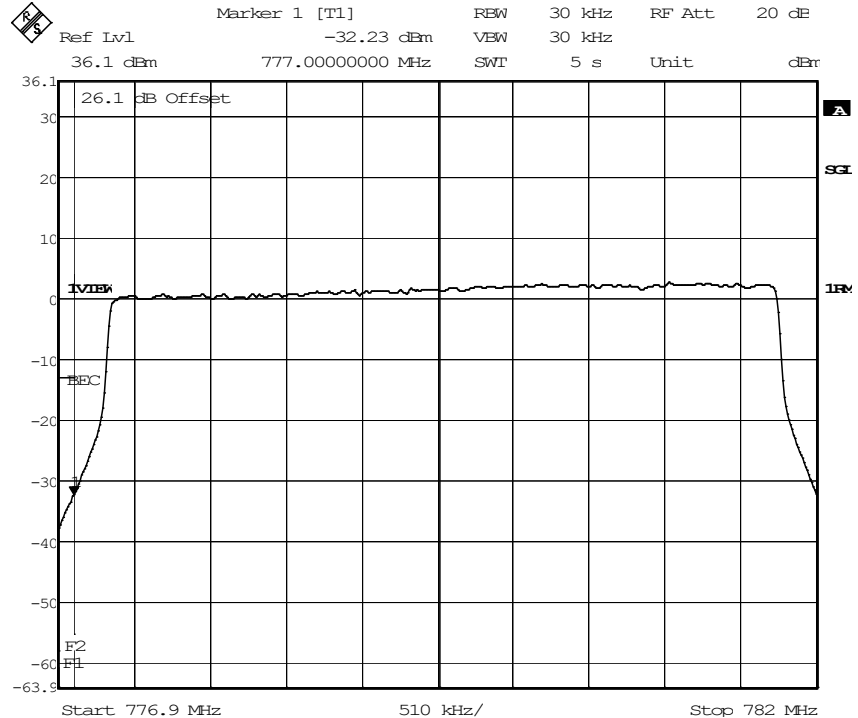

Date: 11.AUG.2021 14:14:04

LTE eTDD38 16QAM 20MHz, Channel = high

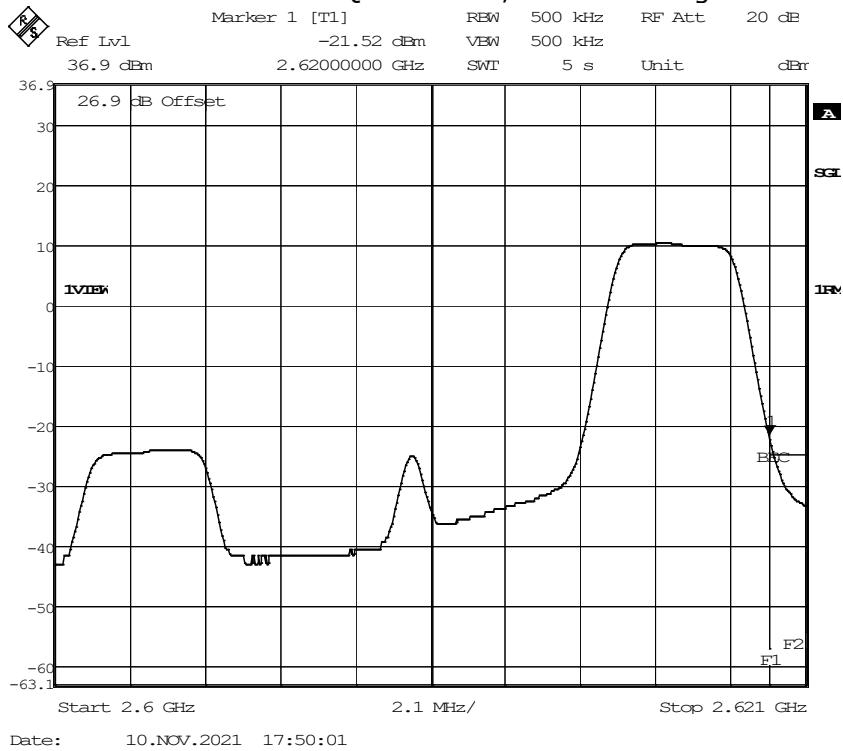

LTE eTDD41 16QAM 20MHz, Channel = high

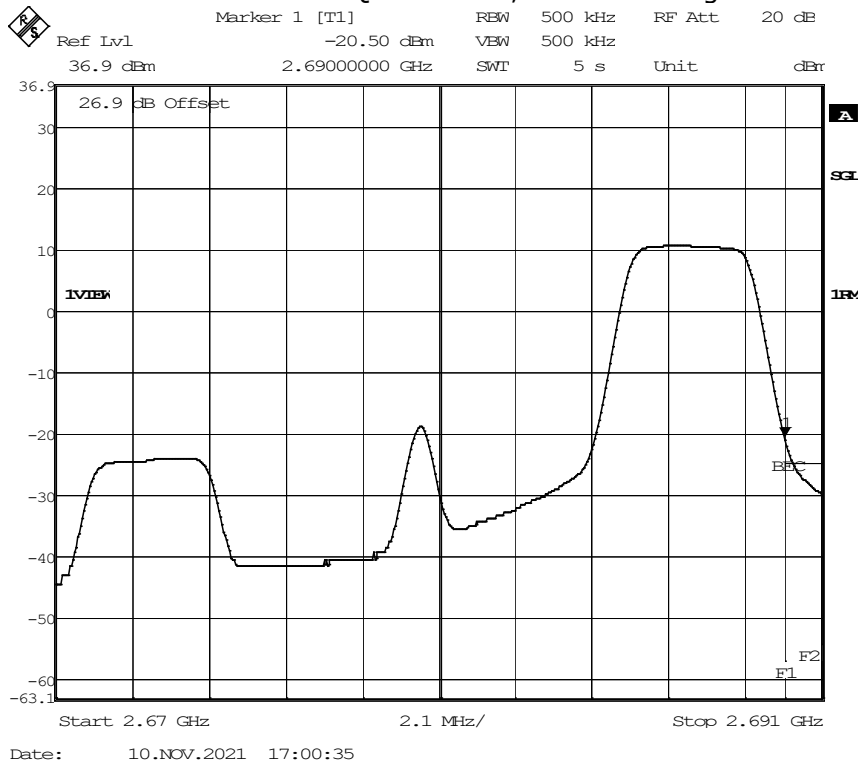

5.20.5 TEST EQUIPMENT USED

- Radio Lab

5.21 PEAK TO AVERAGE RATIO

Standard **FCC PART 27 Subpart C**

The test was performed according to:
ANSI C63.26: 2015

5.21.1 TEST DESCRIPTION

This test case is intended to demonstrate compliance of the EUT to the peak-to-average limits and requirements of the applicable rule part and ISSED RSS-Standard for the operating band of the cellular device.

The EUT was connected to the test setup according to the following diagram:

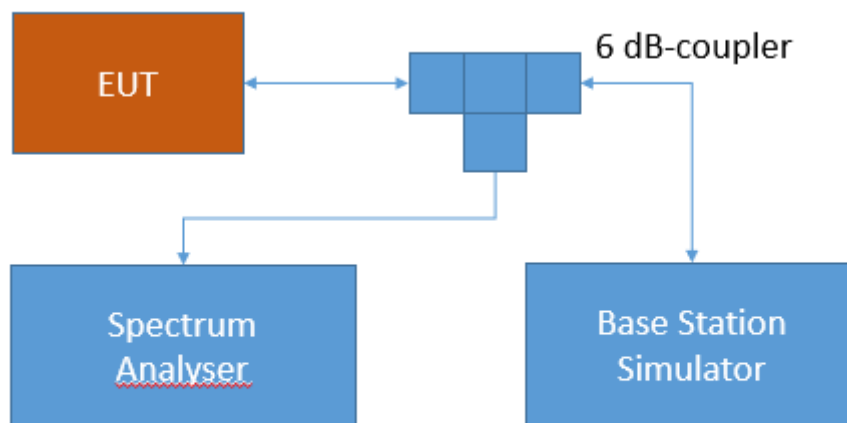

Test Setup FCC Part 22/24/27/90 Cellular;
Peak-average ratio

The attenuation of the measuring and stimulus path are known for each measured frequency and are considered.

The Spectrum Analyser settings can be directly found in the measurement diagrams. The internal CCDF (complementary cumulative distribution function) of the spectrum analyser is used for this measurement

5.21.2 TEST REQUIREMENTS / LIMITS

FCC Part 27; Miscellaneous Wireless Communication Services

Subpart C – Technical standards

§ 27.50 - Power limits and duty cycle

Band 13:

No applicable PAPR limit.

RSS-130; 4.6.1 General

The transmitter output power shall be measured in terms of average power. In addition, the peak-to-average power ratio (PAPR) of the transmitter shall not exceed 13 dB for more than 0.1% of the time and shall use a signal corresponding to the highest PAPR during periods of continuous transmission.

Band 12:

No applicable PAPR limit.

RSS-130; 4.6.1 General

The transmitter output power shall be measured in terms of average power. In addition, the peak-to-average power ratio (PAPR) of the transmitter shall not exceed 13 dB for more than 0.1% of the time and shall use a signal corresponding to the highest PAPR during periods of continuous transmission.

Band 4/10/66:

d) The following power and antenna height requirements apply to stations transmitting in the 1695-1710 MHz, 1710-1755 MHz, 1755-1780 MHz, 1915-1920 MHz, 1995-2000 MHz, 2000-2020 MHz, 2110-2155 MHz, 2155-2180 MHz and 2180-2200 MHz bands:

(5) Equipment employed must be authorized in accordance with the provisions of §24.51. Power measurements for transmissions by stations authorized under this section may be made either in accordance with a Commission-approved average power technique or in compliance with paragraph (d)(6) of this section. In measuring transmissions in this band using an average power technique, the peak-to-average ratio (PAR) of the transmission may not exceed 13 dB.

RSS-139; 6.5 Transmitter Output Power

In addition, the peak to average power ratio (PAPR) of the equipment shall not exceed 13 dB for more than 0.1% of the time, using a signal that corresponds to the highest PAPR during periods of continuous transmission.

Band 17:

No applicable PAPR limit.

RSS-130; 4.6.1 General

The transmitter output power shall be measured in terms of average power. In addition, the peak-to-average power ratio (PAPR) of the transmitter shall not exceed 13 dB for more than 0.1% of the time and shall use a signal corresponding to the highest PAPR during periods of continuous transmission.

Band 7:

No applicable PAPR limit.

RSS-199; 4.4 Transmitter output power and equivalent isotropically power (e.i.r.p.)

In addition, the peak-to-average power ratio (PAPR) of the transmitter shall not exceed 13 dB for more than 0.1% of the time and shall use a signal corresponding to the highest PAPR during periods of continuous transmission.

For equipment with multiple antennas, the transmitter output power and e.i.r.p shall be measured according to ANSI C63.26-2015.

5.21.3 TEST PROTOCOL

Ambient temperature: 20 - 28 °C
Relative humidity: 30 - 45 %

Radio Technology	Channel	Resource Blocks	Bandwidth [MHz]	Peak to Average Ratio	Limit (IC) [dB]
LTE eFDD 4 QPSK	low	6	1.4	5.80	13
LTE eFDD 4 QPSK	mid	6	1.4	5.68	13
LTE eFDD 4 QPSK	high	6	1.4	5.57	13
LTE eFDD 4 16QAM	low	6	1.4	6.72	13
LTE eFDD 4 16QAM	mid	6	1.4	6.58	13
LTE eFDD 4 16QAM	high	6	1.4	6.52	13
LTE eFDD 7 QPSK	low	25	5	5.19	13
LTE eFDD 7 QPSK	mid	25	5	5.25	13
LTE eFDD 7 QPSK	high	25	5	5.30	13
LTE eFDD 7 16QAM	low	25	5	6.03	13
LTE eFDD 7 16QAM	mid	25	5	6.06	13
LTE eFDD 7 16QAM	high	25	5	6.14	13
LTE eFDD 12 QPSK	low	6	1.4	5.22	13
LTE eFDD 12 QPSK	mid	6	1.4	5.25	13
LTE eFDD 12 QPSK	high	6	1.4	5.13	13
LTE eFDD 12 16QAM	low	6	1.4	6.12	13
LTE eFDD 12 16QAM	mid	6	1.4	6.09	13
LTE eFDD 12 16QAM	high	6	1.4	5.94	13
LTE eFDD 13 QPSK	low	25	5	5.01	13
LTE eFDD 13 QPSK	mid	25	5	5.07	13
LTE eFDD 13 QPSK	high	25	5	5.07	13
LTE eFDD 13 16QAM	low	25	5	5.88	13
LTE eFDD 13 16QAM	mid	25	5	5.86	13
LTE eFDD 13 16QAM	high	25	5	5.88	13
LTE eTDD 38 QPSK	low	25	5	7.94	13
LTE eTDD 38 QPSK	mid	25	5	7.91	13
LTE eTDD 38 QPSK	high	25	5	7.88	13
LTE eTDD 38 16QAM	low	25	5	9.74	13
LTE eTDD 38 16QAM	mid	25	5	9.65	13

LTE eTDD 38 16QAM	high	25	5	9.86	13
LTE eTDD 41 QPSK	low	25	5	7.88	13
LTE eTDD 41 QPSK	mid	25	5	7.83	13
LTE eTDD 41 QPSK	high	25	5	7.91	13
LTE eTDD 41 16QAM	low	25	5	9.71	13
LTE eTDD 41 16QAM	mid	25	5	9.59	13
LTE eTDD 41 16QAM	high	25	5	9.88	13

Remark: Please see next sub-clause for the measurement plot.

5.21.4 MEASUREMENT PLOT (EXAMPLE PLOT, SHOWING WORST CASE, IF APPLICABLE)

LTE eFDD4 16QAM, Channel = low



Date: 26.AUG.2021 19:42:44

LTE eFDD7 16QAM, Channel = mid

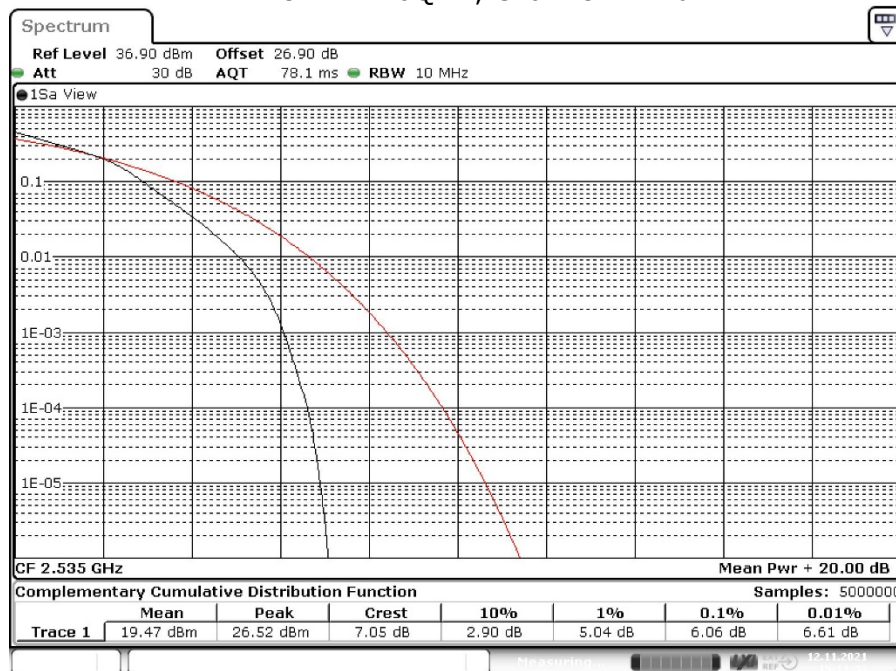

Date: 12.NOV.2021 15:11:43

LTE eFDD12 16QAM, Channel = low

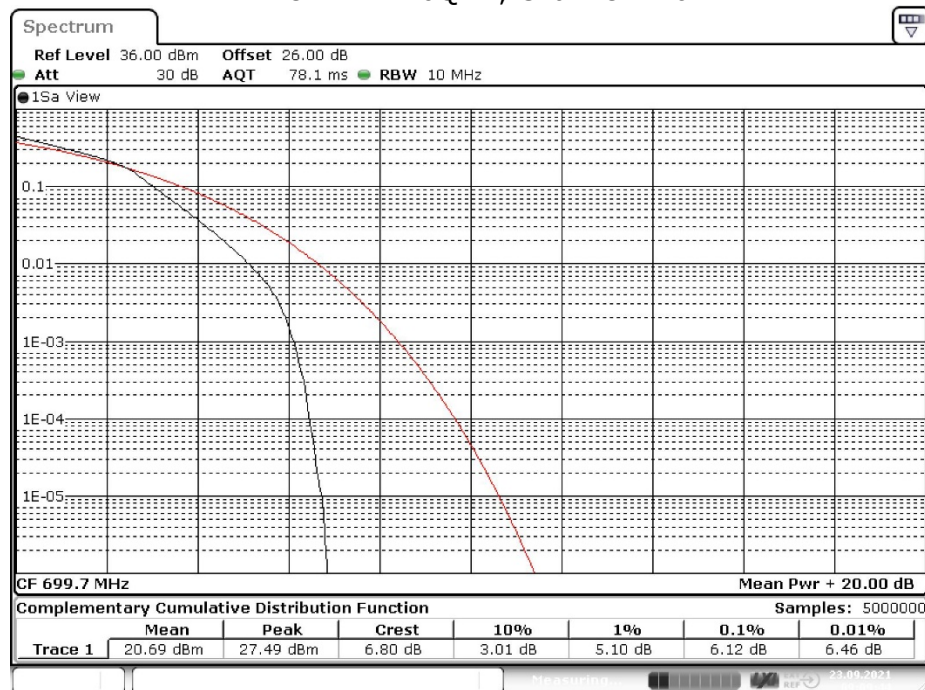

Date: 23.SEP.2021 09:09:45

LTE eFDD13 16QAM, Channel = low

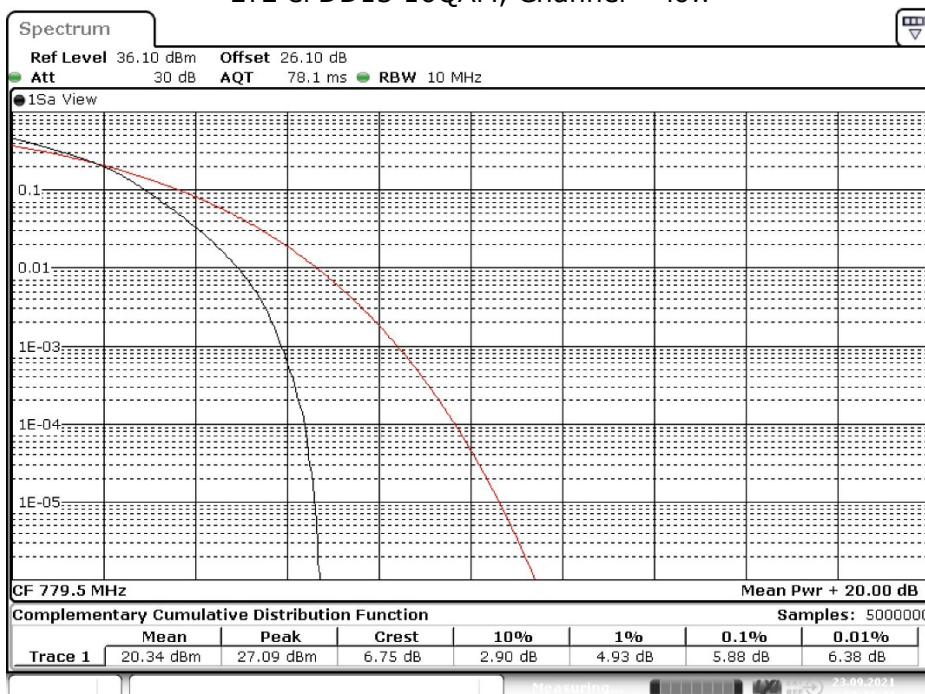

Date: 23.SEP.2021 09:11:44

LTE eTDD38 16QAM, Channel = mid

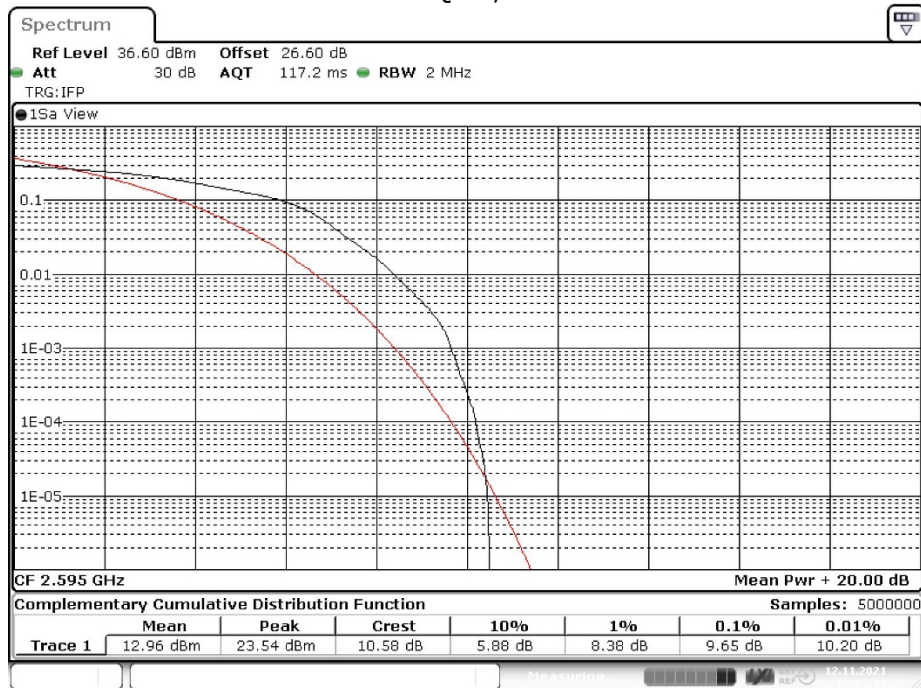

Date: 12.NOV.2021 16:03:18

LTE eTDD41 16QAM, Channel = mid

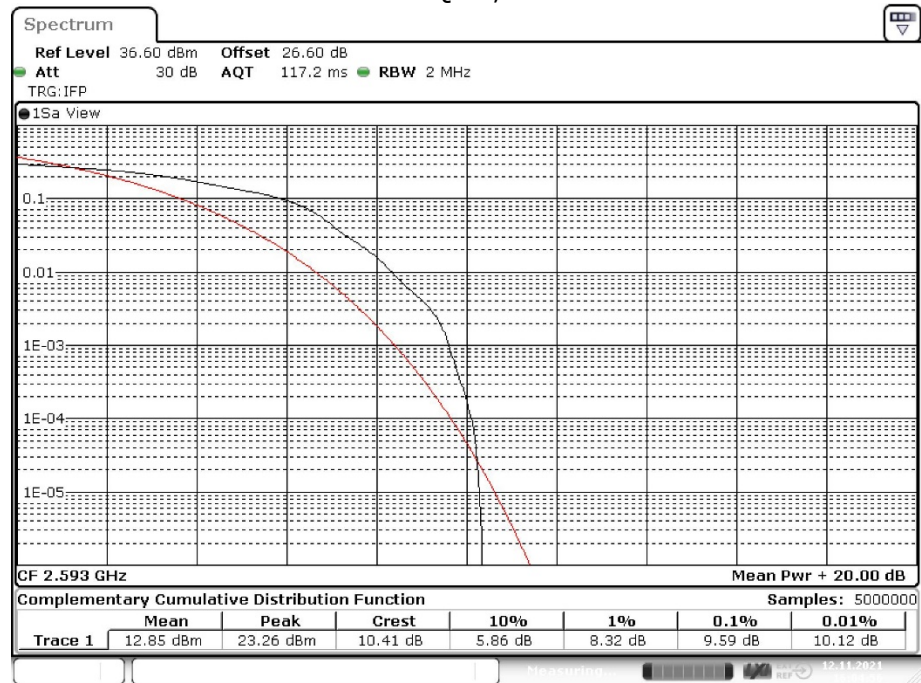

Date: 12.NOV.2021 16:04:56

5.21.5 TEST EQUIPMENT USED

- Radio Lab

5.22 RF OUTPUT POWER

Standard **FCC PART 27 Subpart P**

The test was performed according to:
ANSI C63.26: 2015

5.22.1 TEST DESCRIPTION

This test case is intended to demonstrate compliance to the applicable RF Output power test case per § 2.1046 and RSS-GEN 6.12. The limit and the requirements come from the applicable rule part and ISED RSS-Standard for the operating band of the cellular device.

The EUT was connected to the test setup according to the following diagram:

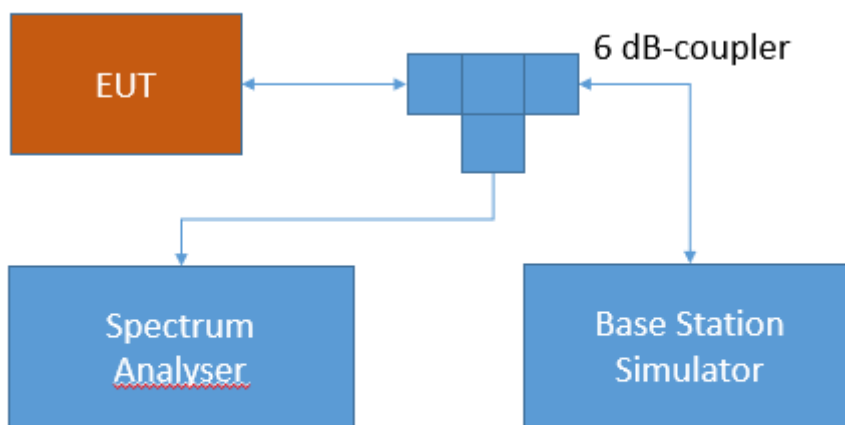

Test Setup FCC Part 22/24/27/90 Cellular;
RF Output power

The attenuation of the measuring and stimulus path are known for each measured frequency and are considered.

The Spectrum Analyser settings can be directly found in the measurement diagrams.

5.22.2 TEST REQUIREMENTS / LIMITS

FCC Part 27; Miscellaneous Wireless Communication Services

Subpart P – Technical standards

§ 27.1507 - Effective radiated power limits for 900 MHz broadband systems.

(4) Portable stations. Portable stations must not exceed 3 watts ERP.

5.22.3 TEST PROTOCOL

Ambient temperature: 20 - 28 °C
 Relative humidity: 30 - 45 %

Radio Technology	Channel	Ressource Blocks	Bandwidth [MHz]	RMS Conducted Power (dBm)	FCC ERP Limit (W)	IC ERP Limit (W)	Maximum Antenna Gain FCC (dBi)	Maximum Antenna Gain IC (dBi)
LTE eFDD 8 QPSK	low	1	1.4	22.20	3	-	12.57	-
LTE eFDD 8 QPSK	low	3	1.4	22.30	3	-	12.47	-
LTE eFDD 8 QPSK	low	6	1.4	21.25	3	-	13.52	-
LTE eFDD 8 QPSK	mid	1	1.4	22.40	3	-	12.37	-
LTE eFDD 8 QPSK	mid	3	1.4	22.27	3	-	12.50	-
LTE eFDD 8 QPSK	mid	6	1.4	21.28	3	-	13.49	-
LTE eFDD 8 QPSK	high	1	1.4	22.56	3	-	12.21	-
LTE eFDD 8 QPSK	high	3	1.4	22.30	3	-	12.47	-
LTE eFDD 8 QPSK	high	6	1.4	21.25	3	-	13.52	-
LTE eFDD 8 16QAM	low	1	1.4	21.94	3	-	12.83	-
LTE eFDD 8 16QAM	low	6	1.4	20.37	3	-	14.40	-
LTE eFDD 8 16QAM	mid	1	1.4	22.09	3	-	12.68	-
LTE eFDD 8 16QAM	mid	6	1.4	20.23	3	-	14.54	-
LTE eFDD 8 16QAM	high	1	1.4	21.52	3	-	13.25	-
LTE eFDD 8 16QAM	high	6	1.4	20.19	3	-	14.58	-
LTE eFDD 8 QPSK	mid	1	3	22.81	3	-	11.96	-
LTE eFDD 8 QPSK	mid	15	3	21.51	3	-	13.26	-
LTE eFDD 8 16QAM	mid	1	3	21.81	3	-	12.96	-
LTE eFDD 8 16QAM	mid	15	3	20.52	3	-	14.25	-

Remark: Please see next sub-clause for the measurement plot.

5.22.4 MEASUREMENT PLOT (EXAMPLE PLOT, SHOWING WORST CASE, IF APPLICABLE)

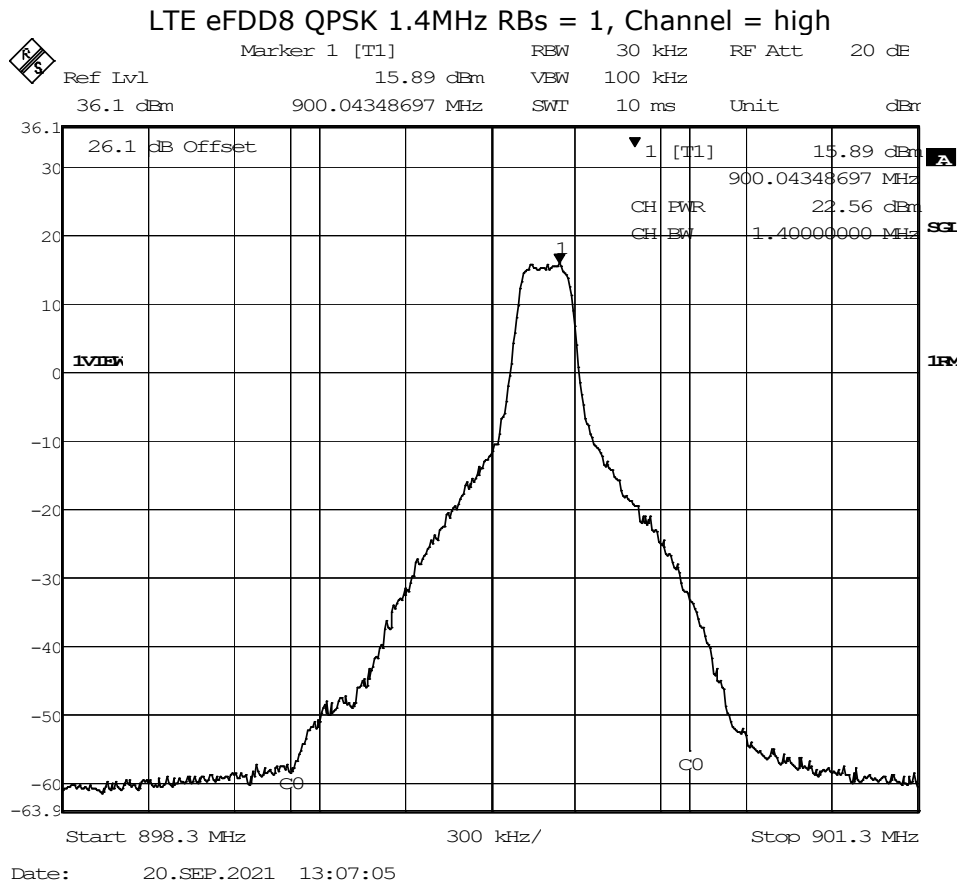

5.22.5 TEST EQUIPMENT USED

- Radio Lab

5.23 FREQUENCY STABILITY

Standard **FCC PART 27 Subpart P**

The test was performed according to:
ANSI C63.26: 2015

5.23.1 TEST DESCRIPTION

This test case is intended to demonstrate compliance to the applicable frequency stability test case per § 2.1055 and RSS-GEN 6.11. The limit and the requirements come from the applicable rule part and ISED RSS-Standard for the operating band of the cellular device.

The EUT was connected to the test setup according to the following diagram:



Test Setup FCC Part 22/24/27/90 Cellular;
Frequency stability

The attenuation of the measuring / stimulus path is known for each measured frequency and are considered.

5.23.2 TEST REQUIREMENTS / LIMITS

FCC Part 27; Miscellaneous Wireless Communication Services

Subpart C – Technical standards

§ 27.54 - Frequency stability

All Bands

The frequency stability shall be sufficient to ensure that the fundamental emissions stay within the authorized bands of operation.

5.23.3 TEST PROTOCOL

LTE eFDD 8

Temp. °C	Duration min	Voltage	Limit Hz	Freq. error Average (Hz)	Freq. error Max. (Hz)	Verdict
-30	0	normal	2091.25	6	12	passed
-30	5			3	18	passed
-30	10			11	16	passed
-20	0	normal	2091.25	4	17	passed
-20	5			2	19	passed
-20	10			8	12	passed
-10	0	normal	2091.25	9	11	passed
-10	5			10	14	passed
-10	10			5	13	passed
0	0	normal	2091.25	4	19	passed
0	5			8	17	passed
0	10			3	18	passed
10	0	normal	2091.25	2	15	passed
10	5			7	13	passed
10	10			9	16	passed
20	0	low	2091.25	4	17	passed
20	5			6	15	passed
20	10			1	12	passed
20	0	normal	2091.25	9	18	passed
20	5			4	16	passed
20	10			8	17	passed
20	0	high	2091.25	6	13	passed
20	5			7	19	passed
20	10			3	11	passed
30	0	normal	2091.25	4	10	passed
30	5			8	18	passed
30	10			6	16	passed
40	0	normal	2091.25	4	13	passed
40	5			4	19	passed
40	10			9	14	passed
50	0	normal	2091.25	7	18	passed
50	5			3	15	passed
50	10			8	16	passed

Remark: Please see next sub-clause for the measurement plot.

5.23.4 TEST EQUIPMENT USED

- Radio Lab

5.24 SPURIOUS EMISSIONS AT ANTENNA TERMINALS

Standard **FCC PART 27 Subpart P**

The test was performed according to:
ANSI C63.26: 2015

5.24.1 TEST DESCRIPTION

This test case is intended to demonstrate compliance to the applicable conducted spurious emission test case per § 2.1051 and RSS-GEN 6.13. The limit comes from the applicable rule part and ISSED RSS-Standard for the operating band of the cellular device.

The EUT was connected to the test setup according to the following diagram:

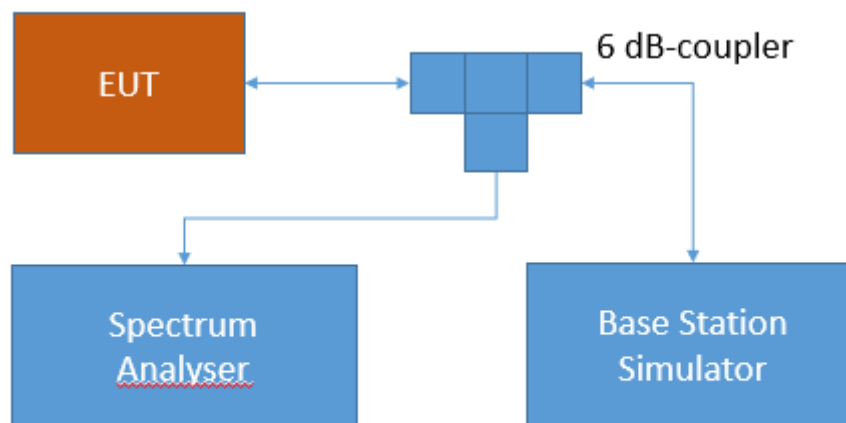

Test Setup FCC Part 22/24/27/90 Cellular;
Spurious Emissions at antenna terminal

The attenuation of the measuring and stimulus path are known for each measured frequency and are considered.

The Spectrum Analyzer settings can be directly found in the measurement diagrams.

5.24.2 TEST REQUIREMENTS / LIMITS

FCC Part 2.1051; Measurement required: Spurious emissions at antenna terminal:

The radio frequency voltage or powers generated within the equipment and appearing on a spurious frequency shall be checked at the equipment output terminals when properly loaded with a suitable artificial antenna. Curves or equivalent data shall show the magnitude of each harmonic and other spurious emission that can be detected when the equipment is operated under the conditions specified in §2.1049 as appropriate. The magnitude of spurious emissions which are attenuated more than 20 dB below the permissible value need not be specified.

FCC Part 27; Miscellaneous Wireless Communication Services

Subpart P – Technical standards

§27.1509 – Emission limits

The power of any emission outside a licensee's frequency band(s) of operation shall be attenuated below the transmitter power (P) in watts by at least the following amounts:

- (a) For 900 MHz broadband operations in 897.5-900.5 MHz band by at least $43 + 10 \log (P)$ dB.
- (b) For 900 MHz broadband operations in the 936.5-939.5 MHz band, by at least $50 + 10 \log (P)$ dB.
- (c) Compliance with the provisions of paragraphs (a) and (b) of this section is based on the use of measurement instrumentation employing a resolution bandwidth of 100 kHz or greater. However, in the 100 kHz bands immediately outside and adjacent to the licensee's band, a resolution bandwidth of at least 1 percent of the emission bandwidth of the fundamental emission of the transmitter may be employed. The emission bandwidth is defined as the width of the signal between two points, one below the carrier center frequency and one above the carrier center frequency, outside of which all emissions are attenuated at least 26 dB below the transmitter power.

5.24.3 TEST PROTOCOL

Ambient temperature: 20 - 28 °C
 Relative humidity: 30 - 45 %

Radio Technology	Channel	Detector	Trace	Resolution Bandwidth /kHz	Frequency /MHz	Peak Value /dBm	Limit /dBm	Margin to Limit /dB
LTE eFDD8	low	rms	maxhold	-	-	-	-13	> 20
LTE eFDD8	mid	rms	maxhold	-	-	-	-13	> 20
LTE eFDD8	hgh	rms	maxhold	3	900.5	-25.89	-20	5.89

Remark: Please see next sub-clause for the measurement plot.

5.24.4 MEASUREMENT PLOT (EXAMPLE PLOT, SHOWING WORST CASE, IF APPLICABLE)

LTE eFDD8 QPSK 1.4MHz, Channel = high

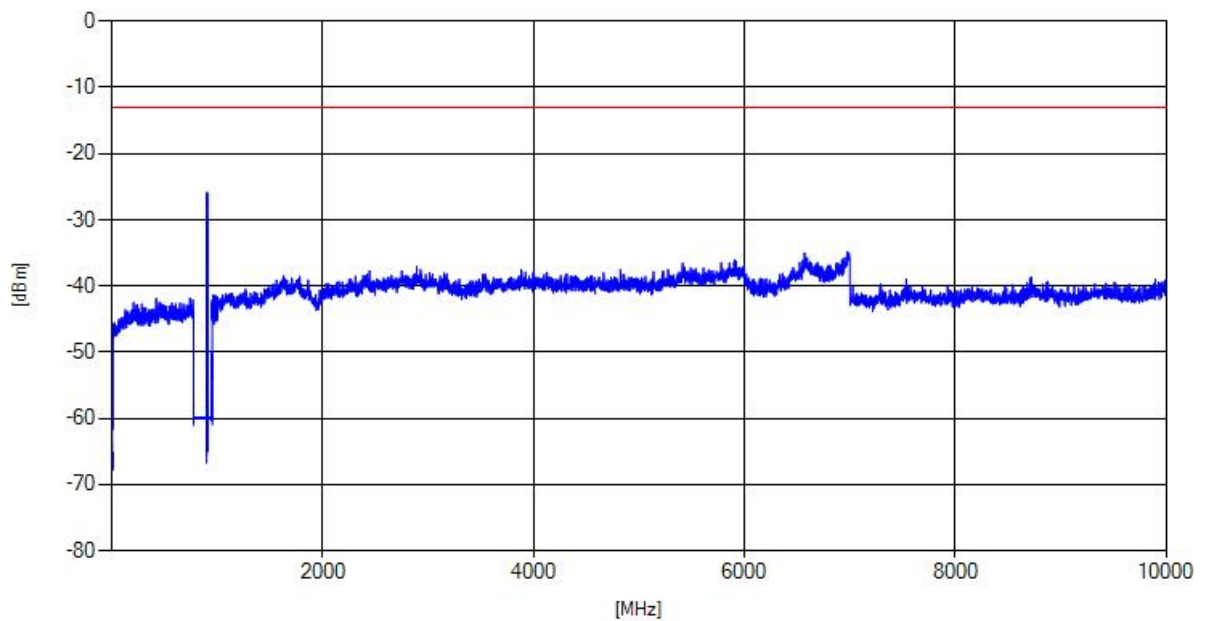

5.24.5 TEST EQUIPMENT USED

- Radio Lab

5.25 FIELD STRENGTH OF SPURIOUS RADIATION

Standard **FCC PART 27 Subpart P**

The test was performed according to:
ANSI C63.26: 2015

5.25.1 TEST DESCRIPTION

This test case is intended to demonstrate compliance to the applicable radiated spurious emission measurements per § 2.1053 and RSS-GEN 6.13. The limit and requirements come from the applicable rule part and ISED RSS-Standard for the operating band of the cellular device.

The EUT was connected to the test setup according to the following diagram:

Frequency Range: 30 MHz – 1 GHz:

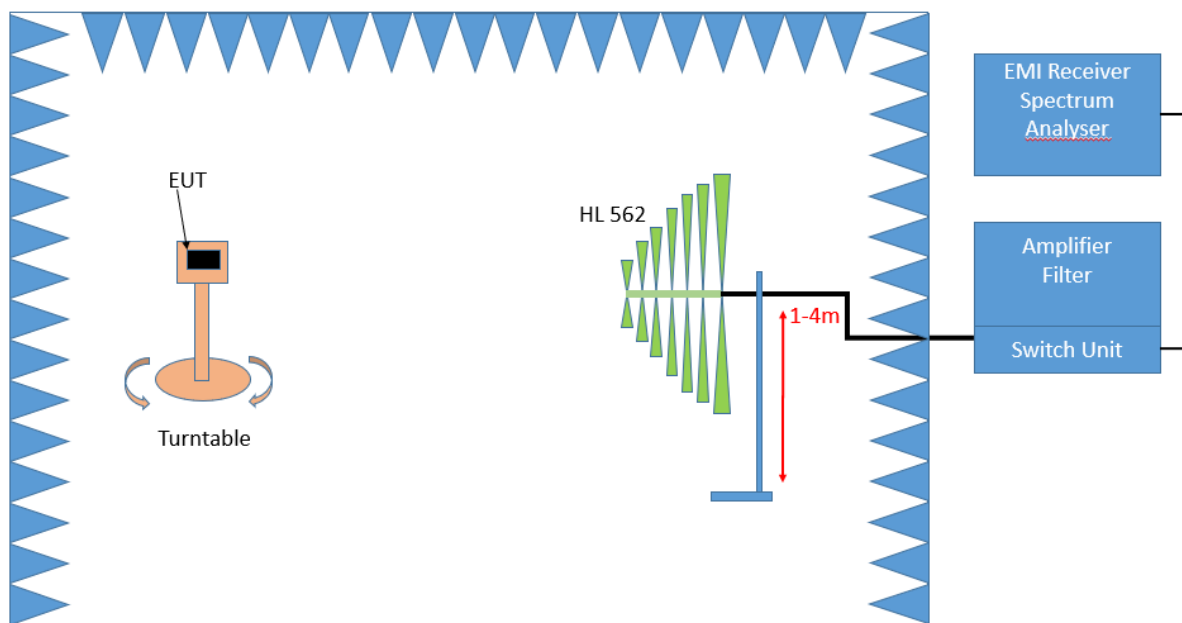

Test Setup; Spurious Emission Radiated (SAC), 30 MHz- 1GHz

Frequency Range: 1 GHz – 26.5 GHz

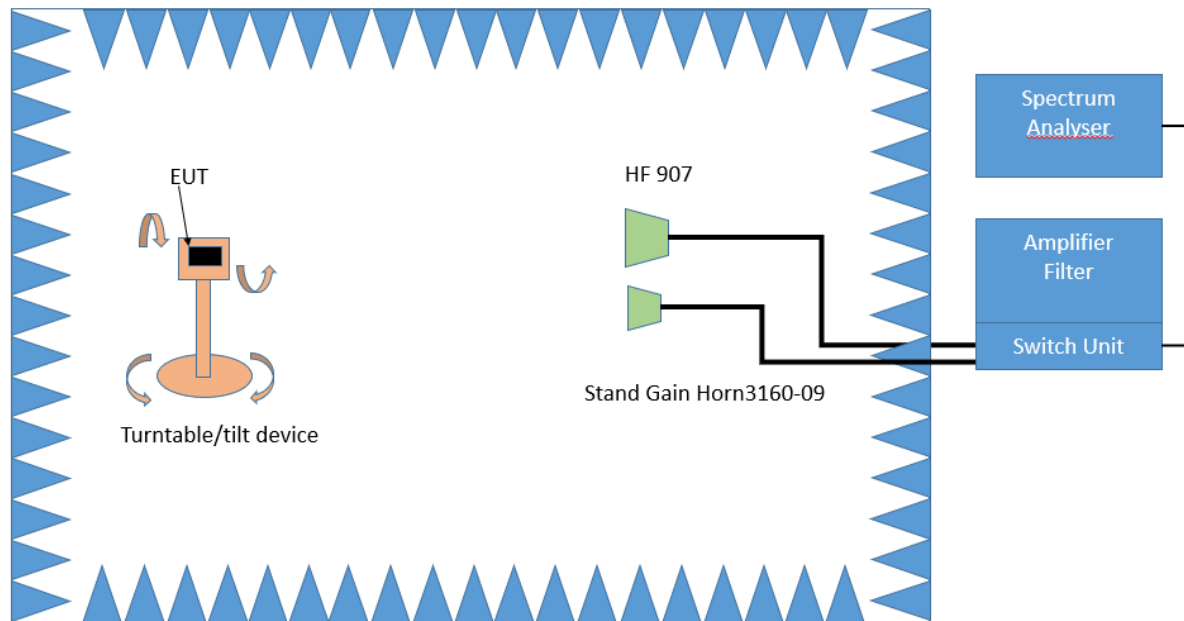

Test Setup; Spurious Emission Radiated (FAC), 1 GHz-26.5 GHz

The test set-up was made in accordance to the general provisions of ANSI C63.26 in a typical installation configuration. The Equipment Under Test (EUT) was set up on a non-conductive table 1.0 x 2.0 m² in the semi-anechoic chamber. The influence of the EUT support table that is used between 30–1000 MHz was evaluated.

The measurement procedure is implemented into the EMI test software EMC32 from R&S. Exploratory tests are performed at 3 orthogonal axes to determine the worst-case orientation of a body-worn or handheld EUT. The final test on all kind of EUTs is also performed at 3 axes. A pre-check is performed while the EUT is powered from a DC power source.

1. Measurement above 30 MHz and up to 1 GHz

Step 1: Preliminary scan

This is a preliminary test to identify the highest amplitudes relative to the limit.

Settings for step 1:

- Antenna distance: 3 m
- Detector: Peak
- RBW: 100 kHz
- VBW: 300 kHz
- Sweep time: coupled
- Turntable angle range: -180° to 90°
- Turntable step size: 90°
- Height variation range: 1 – 4 m
- Height variation step size: 1.5 m
- Polarisation: Horizontal + Vertical

Intention of this step is, to determine the radiated EMI-profile of the EUT. Afterwards the relevant emissions for the final measurement are identified.

Step 2: Adjustment measurement

In this step the accuracy of the turntable azimuth and antenna height will be improved. This is necessary to find out the maximum value of every frequency.

For each frequency, which was determined the turntable azimuth and antenna height will be adjusted. The turntable azimuth will slowly vary by 360°. During this action, the value of emission is continuously measured. The turntable azimuth at the highest emission will be

recorded and adjusted. In this position, the antenna height will also slowly vary from 1 – 4 m. During this action, the value of emission is also continuously measured. The antenna height of the highest emission will also be recorded and adjusted.

- Detector: Peak
- Measured frequencies: in step 1 determined frequencies
- RBW: 100 kHz
- VBW: 300 kHz
- Sweep time: coupled
- Turntable angle range: 360°
- Height variation range: 1 – 4 m
- Antenna Polarisation: max. value determined in step 1

Step 3: Final measurement with RMS detector

With the settings determined in step 3, the final measurement will be performed:

EMI receiver settings for step 4:

- Detector: RMQ
- Measured frequencies: in step 1 determined frequencies
- RBW: 100 kHz
- VBW: 300 kHz
- Sweep time: 1 s

After the measurement a plot will be generated which contains a diagram with the results of the preliminary scan and a chart with the frequencies and values of the results of the final measurement.

3. Measurement above 1 GHz

The following modifications apply to the measurement procedure for the frequency range above 1 GHz:

Step 1:

The Equipment Under Test (EUT) was set up on a non-conductive support (tilt device) at 1.5 m height in the fully-anechoic chamber.

All steps were performed with one height (1.5 m) of the receiving antenna only.

The EUT is turned during the preliminary measurement across the elevation axis, with a step size of 90 °.

The turn table step size (azimuth angle) for the preliminary measurement is 45 °.

- Antenna distance: 3 m
- Detector: Peak
- RBW: 1 MHz
- VBW: 3 MHz
- Sweep time: coupled
- Turntable angle range: -180° to 90°
- Turntable step size: 90°
- Polarisation: Horizontal + Vertical

Step 2:

Due to the fact, that in this frequency range the test is performed in a fully anechoic room, the height scan of the receiving antenna instep 2 is omitted. Instead of this, a maximum search with a step size $\pm 45^\circ$ for the elevation axis is performed.

The turn table azimuth will slowly vary by $\pm 22.5^\circ$.

The elevation angle will slowly vary by $\pm 45^\circ$

EMI receiver settings (for all steps):

- Detector: Peak,
- RBW: 1 MHz
- VBW: 3 MHz
- Sweep time: coupled

Step 3:

Spectrum analyser settings for step 3:

- Detector: RMS
- Measured frequencies: in step 1 determined frequencies
- RBW: 1 MHz
- VBW: 3 MHz
- Sweep Time: 1 s

5.25.2 TEST REQUIREMENTS / LIMITS

FCC Part 2.1053; Measurement required: Field strength of spurious radiation:

Measurements shall be made to detect spurious emissions that may be radiated directly from the cabinet, control circuits, power leads, or intermediate circuit elements under normal conditions of installation and operation. Curves or equivalent data shall be supplied showing the magnitude of each harmonic and other spurious emission. For this test, single sideband, independent sideband, and controlled carrier transmitters shall be modulated under the conditions specified in paragraph (c) of §2.1049, as appropriate.

FCC Part 27; Miscellaneous Wireless Communication Services**§27.1509 – Emission limits**

The power of any emission outside a licensee's frequency band(s) of operation shall be attenuated below the transmitter power (P) in watts by at least the following amounts:

- (a) For 900 MHz broadband operations in 897.5-900.5 MHz band by at least $43 + 10 \log (P)$ dB.
- (b) For 900 MHz broadband operations in the 936.5-939.5 MHz band, by at least $50 + 10 \log (P)$ dB.
- (c) Compliance with the provisions of paragraphs (a) and (b) of this section is based on the use of measurement instrumentation employing a resolution bandwidth of 100 kHz or greater. However, in the 100 kHz bands immediately outside and adjacent to the licensee's band, a resolution bandwidth of at least 1 percent of the emission bandwidth of the fundamental emission of the transmitter may be employed. The emission bandwidth is defined as the width of the signal between two points, one below the carrier center frequency and one above the carrier center frequency, outside of which all emissions are attenuated at least 26 dB below the transmitter power.

5.25.3 TEST PROTOCOL

Ambient temperature: 20 - 28 °C
 Relative humidity: 30 - 45 %

Radio Technology	Channel	Detector	Trace	Resolution Bandwidth /kHz	Frequency /MHz	Peak Value /dBm	Limit /dBm	Margin to Limit /dB
LTE eFDD8	low	rms	maxhold	20	897.5	-25.86	-13	12.86
LTE eFDD8	mid	rms	maxhold	-	-	-	-13	> 20
LTE eFDD8	hgh	rms	maxhold	100	900.6	-13.69	-13	0.69

Remark: Please see next sub-clause for the measurement plot.

5.25.4 MEASUREMENT PLOT (EXAMPLE PLOT, SHOWING WORST CASE, IF APPLICABLE)

LTE eFDD8 QPSK 1.4MHz, Channel = high
30 MHz – 1 GHz

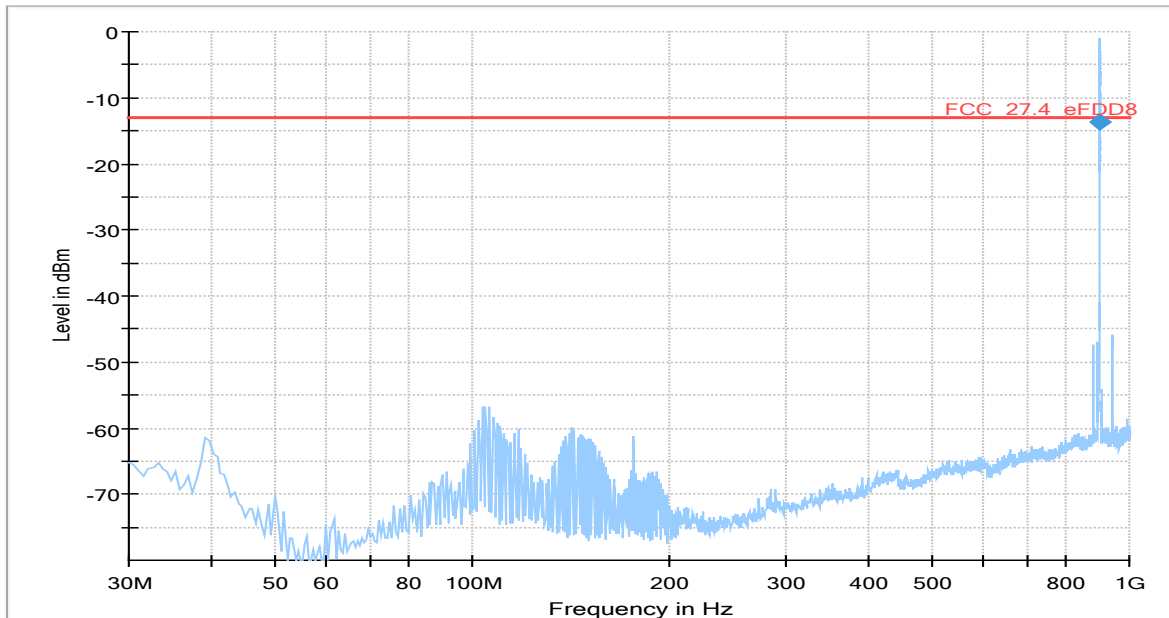

Frequency (MHz)	RMS (dBm)	Limit (dBm)	Margin (dB)	Meas. Time (ms)	Bandwidth (kHz)	Height (cm)	Pol	Azimuth (deg)	Corr. (dB)
900.600000	-13.69	-13.00	0.69	1000.0	100.000	110.0	H	101.0	-72.5

1 GHz – 10 GHz

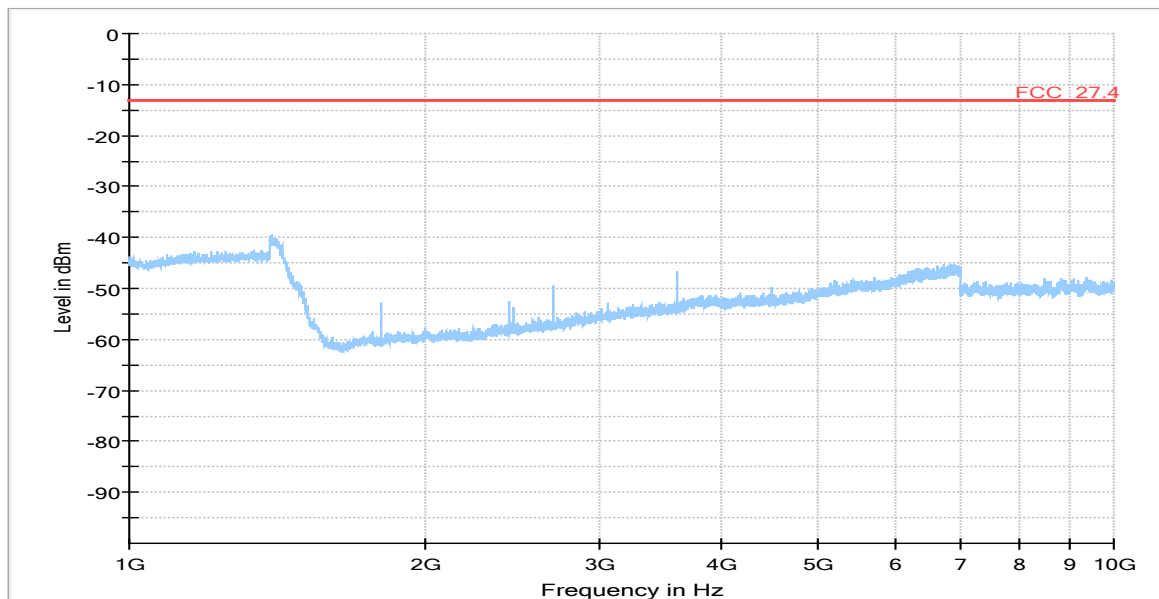

5.25.5 TEST EQUIPMENT USED

- Radiated Emissions

5.26 EMISSION AND OCCUPIED BANDWIDTH

Standard **FCC PART 27 Subpart P**

The test was performed according to:
ANSI C63.26: 2015

5.26.1 TEST DESCRIPTION

This test case is intended to demonstrate compliance to the applicable conducted spurious emission test case per FCC §2.1049 and RSS-GEN 6.7. The limit and the requirements come from the applicable rule part and ISED RSS-Standard for the operating band of the cellular device.

The EUT was connected to the test setups according to the following diagram:

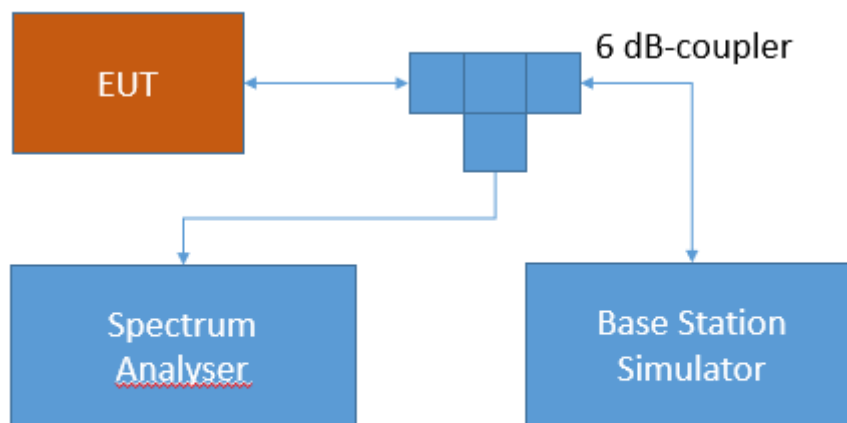

Test Setup FCC Part 22/24/27/90 Cellular;
Spurious Emissions at antenna terminal

The attenuation of the measuring and stimulus path are known for each measured frequency and are considered.

The Spectrum Analyzer settings can be directly found in the measurement diagrams.

5.26.2 TEST REQUIREMENTS / LIMITS

FCC Part 2.1049; Occupied Bandwidth:

The occupied bandwidth, that is the frequency bandwidth such that, below its lower and above its upper frequency limits, the mean powers radiated are each equal to 0.5 percent of the total mean power radiated by a given emission shall be measured under the following conditions as applicable:

(h) Transmitters employing digital modulation techniques—when modulated by an input signal such that its amplitude and symbol rate represent the maximum rated conditions under

which the equipment will be operated. The signal shall be applied through any filter networks, pseudo-random generators or other devices required in normal service. Additionally, the occupied bandwidth shall be shown for operation with any devices used for modifying the spectrum when such devices are optional at the discretion of the user.

(i) Transmitters designed for other types of modulation—when modulated by an appropriate signal of sufficient amplitude to be representative of the type of service in which used. A description of the input signal should be supplied.

5.26.3 TEST PROTOCOL

Ambient temperature: 20 - 28 °C
Relative humidity: 30 - 45 %

Radio Technology	Channel	Ressource Blocks / Subcarrier	Bandwidth [MHz]	Nominal BW [MHz]	99 % BW [kHz]
LTE eFDD 8 QPSK	low	6	1.4	1.4	1106.21
LTE eFDD 8 QPSK	mid	6	1.4	1.4	1106.21
LTE eFDD 8 QPSK	high	6	1.4	1.4	1112.22
LTE eFDD 8 16QAM	low	6	1.4	1.4	1112.22
LTE eFDD 8 16QAM	mid	6	1.4	1.4	1100.20
LTE eFDD 8 16QAM	high	6	1.4	1.4	1106.21
LTE eFDD 8 QPSK	mid	15	3	3	2753.51
LTE eFDD 8 16QAM	mid	15	3	3	2765.53

Remark: Please see next sub-clause for the measurement plot.

5.26.4 MEASUREMENT PLOT (EXAMPLE PLOT, SHOWING WORST CASE, IF APPLICABLE)

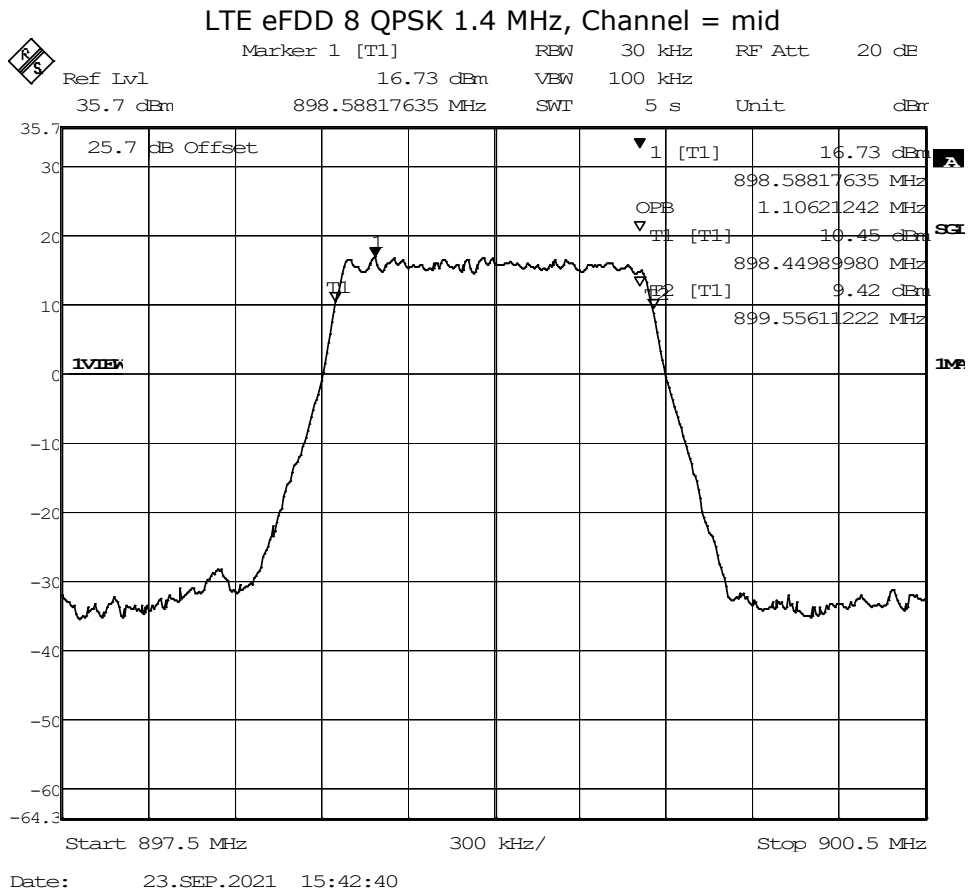

5.26.5 TEST EQUIPMENT USED

- Radio Lab

5.27 BAND EDGE COMPLIANCE

Standard **FCC PART 27 Subpart P**

The test was performed according to:
ANSI C63.26: 2015

5.27.1 TEST DESCRIPTION

This test case is intended to demonstrate compliance to the applicable conducted spurious emission test case per § 2.1051 and RSS-GEN 6.13. The limit comes from the applicable rule part and ISSED RSS-Standard for the operating band of the cellular device.

The EUT was connected to the test setup according to the following diagram:

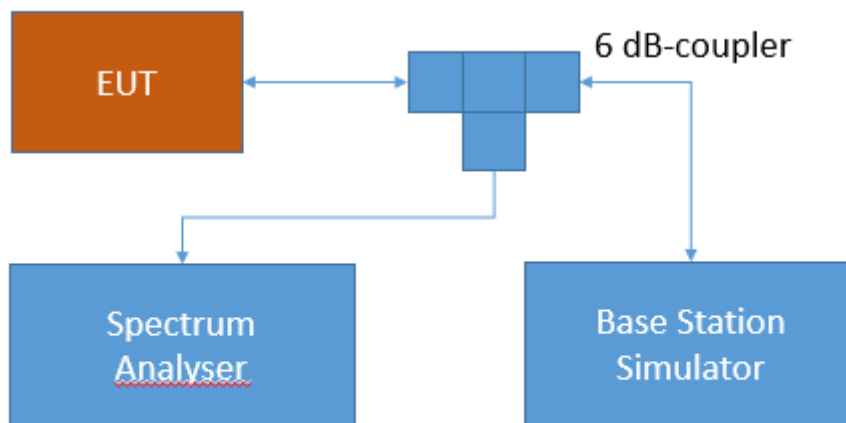

Test Setup FCC Part 22/24/27/90 Cellular;
Band edge compliance

The attenuation of the measuring and stimulus path are known for each measured frequency and are considered.

The Spectrum Analyzer settings can be directly found in the measurement diagrams.

5.27.2 TEST REQUIREMENTS / LIMITS

FCC Part 2.1051; Measurement required: Spurious emissions at antenna terminal:

The radio frequency voltage or powers generated within the equipment and appearing on a spurious frequency shall be checked at the equipment output terminals when properly loaded with a suitable artificial antenna. Curves or equivalent data shall show the magnitude of each harmonic and other spurious emission that can be detected when the equipment is operated under the conditions specified in §2.1049 as appropriate. The magnitude of spurious emissions which are attenuated more than 20 dB below the permissible value need not be specified.

FCC Part 27; Miscellaneous Wireless Communication Services

Subpart P – Technical standards

§27.1509 - Emission limits

The power of any emission outside a licensee's frequency band(s) of operation shall be attenuated below the transmitter power (P) in watts by at least the following amounts:

- (a) For 900 MHz broadband operations in 897.5-900.5 MHz band by at least $43 + 10 \log (P)$ dB.
- (b) For 900 MHz broadband operations in the 936.5-939.5 MHz band, by at least $50 + 10 \log (P)$ dB.
- (c) Compliance with the provisions of paragraphs (a) and (b) of this section is based on the use of measurement instrumentation employing a resolution bandwidth of 100 kHz or greater. However, in the 100 kHz bands immediately outside and adjacent to the licensee's band, a resolution bandwidth of at least 1 percent of the emission bandwidth of the fundamental emission of the transmitter may be employed. The emission bandwidth is defined as the width of the signal between two points, one below the carrier center frequency and one above the carrier center frequency, outside of which all emissions are attenuated at least 26 dB below the transmitter power.

5.27.3 TEST PROTOCOL

Ambient temperature: 20 - 28 °C
Relative humidity: 30 - 45 %

Radio Technology	Channel	Resource Blocks	Bandwidth [MHz]	Peak [dBm]	Average [dBm]	RMS [dBm]	Limit /dBm	Margin to Limit /dB
eFDD 8 QPSK	low	6	1.4	-18.99	-32.23	-30.84	-13	17.84
eFDD 8 QPSK	high	6	1.4	-5.71	-19.47	-17.32	-13	4.32
eFDD 8 16QAM	low	6	1.4	-21.36	-33.44	-31.86	-13	18.86
eFDD 8 16QAM	high	6	1.4	-8.15	-20.78	-18.72	-13	5.72
eFDD 8 QPSK	low	15	3	-17.17	-30.84	-28.10	-13	15.10
eFDD 8 QPSK	high	15	3	-18.66	-33.44	-30.52	-13	17.52
eFDD 8 16QAM	low	15	3	-16.54	-33.02	-29.92	-13	16.92
eFDD 8 16QAM	high	15	3	-15.52	-34.36	-31.17	-13	18.17

Remark: Please see next sub-clause for the measurement plot.

5.27.4 MEASUREMENT PLOT (EXAMPLE PLOT, SHOWING WORST CASE, IF APPLICABLE)

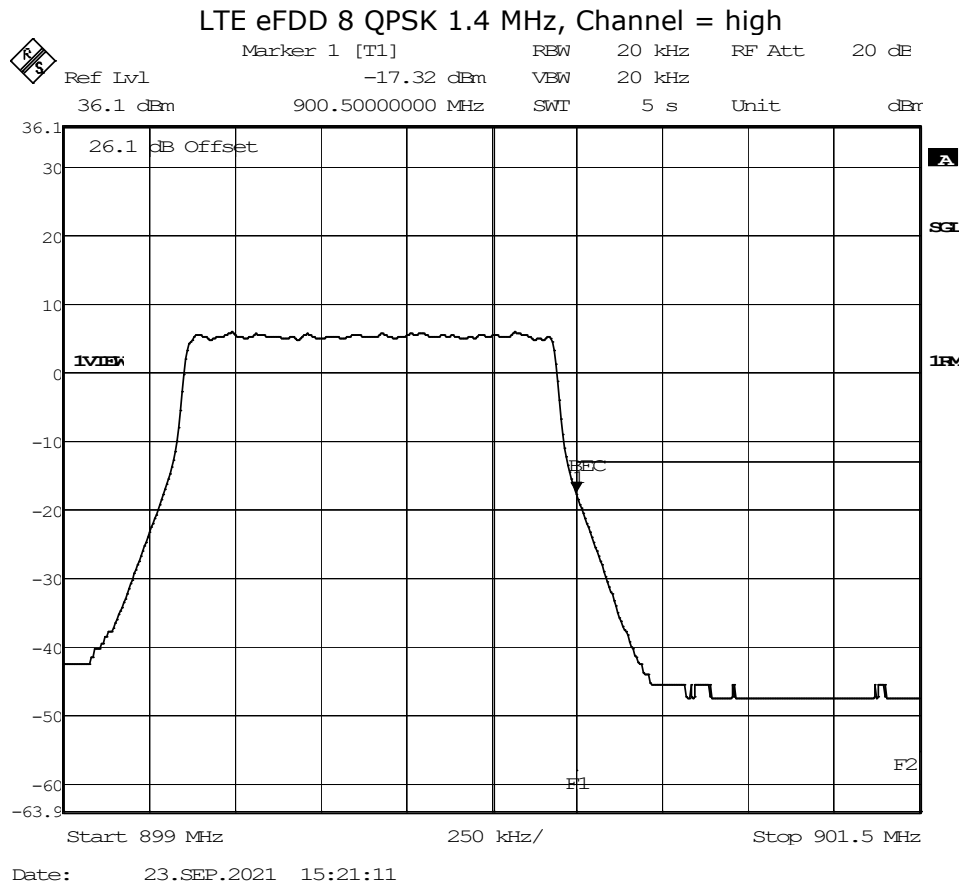

5.27.5 TEST EQUIPMENT USED

- Radio Lab

5.28 PEAK TO AVERAGE RATIO

Standard **FCC PART 27 Subpart P**

The test was performed according to:
ANSI C63.26: 2015

5.28.1 TEST DESCRIPTION

This test case is intended to demonstrate compliance of the EUT to the peak-to-average limits and requirements of the applicable rule part and ISSED RSS-Standard for the operating band of the cellular device.

The EUT was connected to the test setup according to the following diagram:

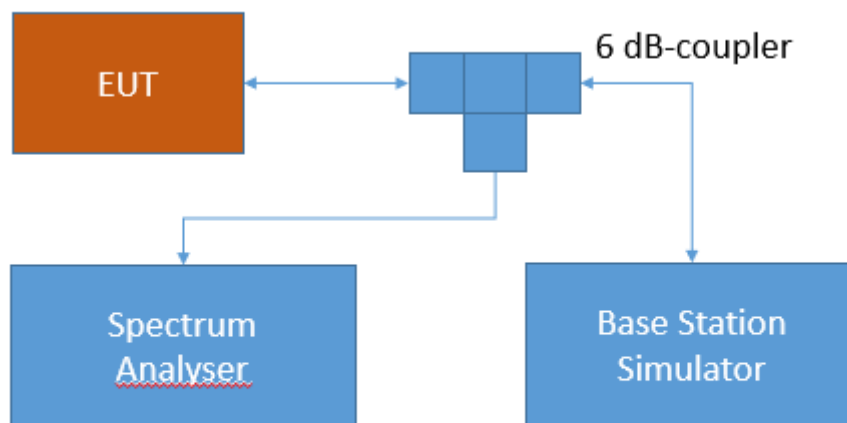

Test Setup FCC Part 22/24/27/90 Cellular;
Peak-average ratio

The attenuation of the measuring and stimulus path are known for each measured frequency and are considered.

The Spectrum Analyser settings can be directly found in the measurement diagrams. The internal CCDF (complementary cumulative distribution function) of the spectrum analyser is used for this measurement

5.28.2 TEST REQUIREMENTS / LIMITS

FCC Part 27; Miscellaneous Wireless Communication Services

Subpart P – Technical standards

§ 27.1507 - Effective radiated power limits for 900 MHz broadband systems.

(d) *PAR limit.* The peak-to-average ratio (PAR) of the transmission must not exceed 13 dB.

5.28.3 TEST PROTOCOL

Ambient temperature: 20 - 28 °C
Relative humidity: 30 - 45 %

Radio Technology	Channel	Ressource Blocks	Bandwidth [MHz]	Peak to Average Ratio	Limit (IC) [dB]
LTE eFDD 8 QPSK	low	6	1.4	5.13	13
LTE eFDD 8 QPSK	mid	6	1.4	5.13	13
LTE eFDD 8 QPSK	high	6	1.4	5.10	13
LTE eFDD 8 16QAM	low	6	1.4	5.97	13
LTE eFDD 8 16QAM	mid	6	1.4	5.94	13
LTE eFDD 8 16QAM	high	6	1.4	5.97	13

Remark: Please see next sub-clause for the measurement plot.

5.28.4 MEASUREMENT PLOT (EXAMPLE PLOT, SHOWING WORST CASE, IF APPLICABLE)

LTE eFDD8 16QAM 1.4MHz, Channel = low



Date: 27.SEP.2021 11:19:06

5.28.5 TEST EQUIPMENT USED

- Radio Lab

5.29 RF OUTPUT POWER

Standard **FCC PART 90 Subpart S**

The test was performed according to:
ANSI C63.26: 2015

5.29.1 TEST DESCRIPTION

This test case is intended to demonstrate compliance to the applicable RF Output power test case per § 2.1046 and RSS-GEN 6.12. The limit and the requirements come from the applicable rule part and ISED RSS-Standard for the operating band of the cellular device.

The EUT was connected to the test setup according to the following diagram:

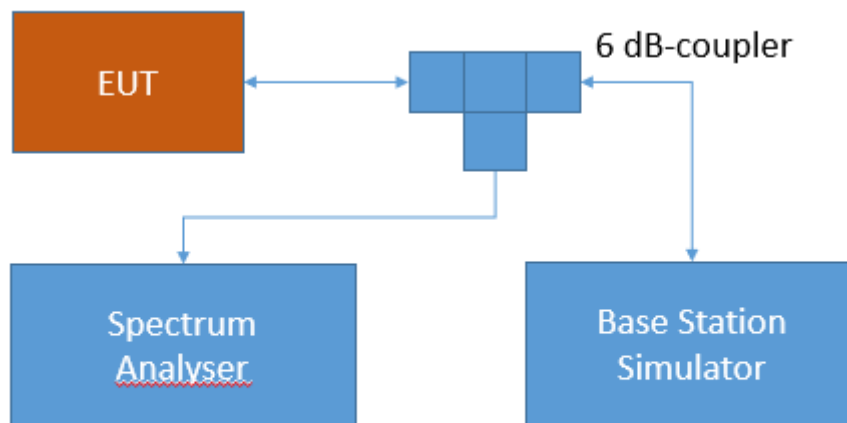

Test Setup FCC Part 22/24/27/90 Cellular;
RF Output power

The attenuation of the measuring and stimulus path are known for each measured frequency and are considered.

The Spectrum Analyzer settings can be directly found in the measurement diagrams.

5.29.2 TEST REQUIREMENTS / LIMITS

Part 90; PRIVATE LAND MOBILE RADIO SERVICES

Subpart S—Regulations Governing Licensing and Use of Frequencies in the 806-824, 851-869, 896-901, and 935-940 MHz Bands

§90.635 Limitations on power and antenna height.

(b) The maximum output power of the transmitter for mobile stations is 100 watts (20 dBw).

RSS-140; 4.3 Transmitter Output Power

The equivalent radiated power (e.r.p.) for control and mobile equipment shall not exceed 30 W. The e.r.p. for portable equipment including handheld devices shall not exceed 3 W.

5.29.3 TEST PROTOCOL

Ambient temperature: 20 - 28 °C
Relative humidity: 30 - 45 %

Radio Technology	Channel	Resource Blocks	Bandwidth [MHz]	RMS Conducted Power [dBm]	FCC EIRP Limit [W]	IC EIRP Limit [W]	Maximum Antenna Gain FCC [dBi]	Maximum Antenna Gain IC [dBi]
LTE eFDD 26 QPSK	low	1	1.4	23.62	1	1	6.38	6.38
LTE eFDD 26 QPSK	low	3	1.4	22.94	1	1	7.06	7.06
LTE eFDD 26 QPSK	low	6	1.4	21.94	1	1	8.06	8.06
LTE eFDD 26 QPSK	mid	1	1.4	23.32	1	1	6.68	6.68
LTE eFDD 26 QPSK	mid	3	1.4	22.80	1	1	7.20	7.2
LTE eFDD 26 QPSK	mid	6	1.4	21.86	1	1	8.14	8.14
LTE eFDD 26 QPSK	high	1	1.4	22.94	1	1	7.06	7.06
LTE eFDD 26 QPSK	high	3	1.4	22.38	1	1	7.62	7.62
LTE eFDD 26 QPSK	high	6	1.4	21.44	1	1	8.56	8.56
LTE eFDD 26 16QAM	low	1	1.4	21.97	1	1	8.03	8.03
LTE eFDD 26 16QAM	low	6	1.4	20.59	1	1	9.41	9.41
LTE eFDD 26 16QAM	mid	1	1.4	22.09	1	1	7.91	7.91
LTE eFDD 26 16QAM	mid	6	1.4	20.36	1	1	9.64	9.64
LTE eFDD 26 16QAM	high	1	1.4	21.99	1	1	8.01	8.01
LTE eFDD 26 16QAM	high	6	1.4	20.55	1	1	9.45	9.45
LTE eFDD 26 QPSK	low	1	3	23.56	1	1	6.44	6.44
LTE eFDD 26 QPSK	low	15	3	22.35	1	1	7.65	7.65
LTE eFDD 26 QPSK	mid	1	3	23.72	1	1	6.28	6.28
LTE eFDD 26 QPSK	mid	15	3	22.36	1	1	7.64	7.64
LTE eFDD 26 QPSK	high	1	3	22.95	1	1	7.05	7.05
LTE eFDD 26 QPSK	high	15	3	21.83	1	1	8.17	8.17
LTE eFDD 26 16QAM	low	1	3	22.42	1	1	7.58	7.58
LTE eFDD 26 16QAM	low	15	3	20.95	1	1	9.05	9.05
LTE eFDD 26 16QAM	mid	1	3	22.44	1	1	7.56	7.56
LTE eFDD 26 16QAM	mid	15	3	20.91	1	1	9.09	9.09
LTE eFDD 26 16QAM	high	1	3	22.01	1	1	7.99	7.99
LTE eFDD 26 16QAM	high	15	3	20.93	1	1	9.07	9.07
LTE eFDD 26 QPSK	low	1	5	23.50	1	1	6.50	6.5
LTE eFDD 26 QPSK	low	12	5	22.26	1	1	7.74	7.74
LTE eFDD 26 QPSK	low	25	5	22.21	1	1	7.79	7.79
LTE eFDD 26 QPSK	mid	1	5	23.01	1	1	6.99	6.99
LTE eFDD 26 QPSK	mid	12	5	21.95	1	1	8.05	8.05
LTE eFDD 26 QPSK	mid	25	5	21.96	1	1	8.04	8.04

LTE eFDD 26 QPSK	high	1	5	23.29	1	1	6.71	6.71
LTE eFDD 26 QPSK	high	12	5	22.32	1	1	7.68	7.68
LTE eFDD 26 QPSK	high	25	5	22.24	1	1	7.76	7.76
LTE eFDD 26 16QAM	low	1	5	22.18	1	1	7.82	7.82
LTE eFDD 26 16QAM	low	25	5	20.90	1	1	9.10	9.1
LTE eFDD 26 16QAM	mid	1	5	22.35	1	1	7.65	7.65
LTE eFDD 26 16QAM	mid	25	5	20.88	1	1	9.12	9.12
LTE eFDD 26 16QAM	high	1	5	21.58	1	1	8.42	8.42
LTE eFDD 26 16QAM	high	25	5	20.87	1	1	9.13	9.13
LTE eFDD 26 QPSK	mid	1	10	23.70	1	1	6.30	6.3
LTE eFDD 26 QPSK	mid	50	10	22.46	1	1	7.54	7.54
LTE eFDD 26 16QAM	mid	1	10	20.77	1	1	9.23	9.23
LTE eFDD 26 16QAM	mid	12	10	22.24	1	1	9.23	9.23

Remark: Please see next sub-clause for the measurement plot.

5.29.4 MEASUREMENT PLOT (EXAMPLE PLOT, SHOWING WORST CASE, IF APPLICABLE)

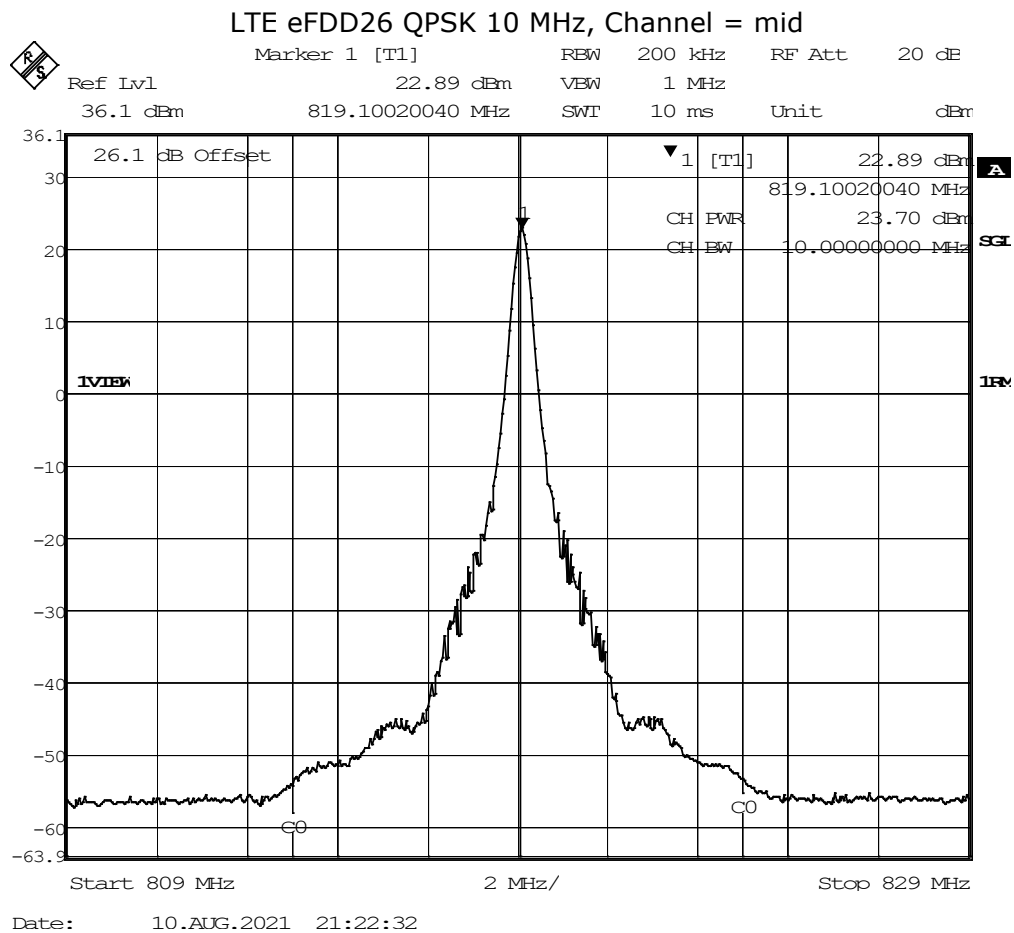

5.29.5 TEST EQUIPMENT USED

- Radio Lab

5.30 SPURIOUS EMISSIONS AT ANTENNA TERMINALS

Standard **FCC PART 90 Subpart S**

The test was performed according to:
ANSI C63.26: 2015

5.30.1 TEST DESCRIPTION

This test case is intended to demonstrate compliance to the applicable conducted spurious emission test case per § 2.1051 and RSS-GEN 6.13. The limit comes from the applicable rule part and ISED RSS-Standard for the operating band of the cellular device.

The EUT was connected to the test setup according to the following diagram:

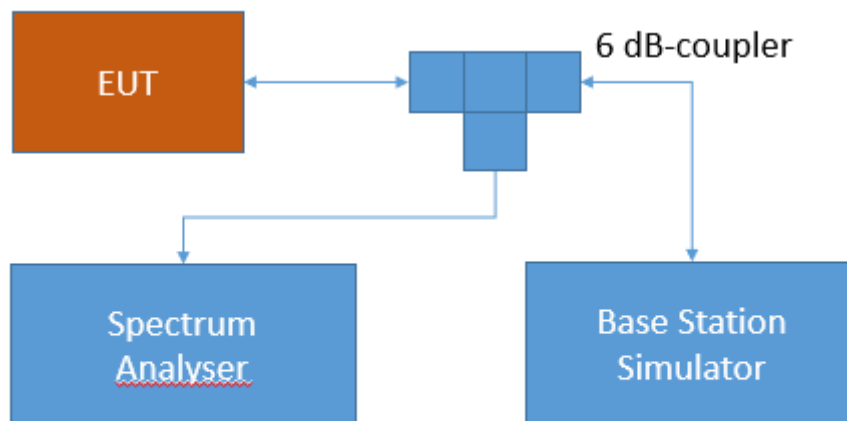

Test Setup FCC Part 22/24/27/90 Cellular;
Spurious Emissions at antenna terminal

The attenuation of the measuring and stimulus path are known for each measured frequency and are considered.

The Spectrum Analyzer settings can be directly found in the measurement diagrams.

5.30.2 TEST REQUIREMENTS / LIMITS

FCC Part 2.1051; Measurement required: Spurious emissions at antenna terminal:

The radio frequency voltage or powers generated within the equipment and appearing on a spurious frequency shall be checked at the equipment output terminals when properly loaded with a suitable artificial antenna. Curves or equivalent data shall show the magnitude of each harmonic and other spurious emission that can be detected when the equipment is operated

under the conditions specified in §2.1049 as appropriate. The magnitude of spurious emissions which are attenuated more than 20 dB below the permissible value need not be specified.

Part 90; PRIVATE LAND MOBILE RADIO SERVICES

Subpart R—Regulations Governing the Licensing and Use of Frequencies in the 763-775 and 793-805 MHz Bands

§90.543 – Emission limitations.

(a) The adjacent channel power (ACP) requirements for transmitters designed for various channel sizes are shown in the following tables. Mobile station requirements apply to handheld, car mounted and control station units. The tables specify a value for the ACP as a function of the displacement from the channel center frequency and measurement bandwidth. In the following tables, "(s)" indicates a swept measurement may be used.

RSS-140; 4.4 Transmitter unwanted emission limits

The power of any unwanted emission outside the bands 758-768 MHz and 788-798 MHz shall be attenuated below the transmitter output power P in dBW as follows, where p is the transmitter output power in watts:

For any frequency between 769-775 MHz and 799-806 MHz:

$$65 + 10 \log (p), \text{ dB in a 6.25 kHz band for mobile and portable/hand-held equipment}$$

For any frequency between 775-788 MHz, above 806 MHz, and below 758 MHz: $43 + 10 \log (p)$, dB in a bandwidth of 100 kHz or greater. However, in the 100 kHz bands immediately outside and adjacent to the frequency bands 758-768 MHz and 788-798 MHz, a resolution bandwidth of 30 kHz may be employed.

In addition, the equivalent isotropically radiated power (e.i.r.p.) of all emissions, including harmonics in the band 1559-1610 MHz, shall not exceed -70 dBW/MHz for wideband emissions, and -80 dBW/kHz for discrete emissions of less than 700 Hz bandwidth.

5.30.3 TEST PROTOCOL

Ambient temperature: 20 - 28 °C
Relative humidity: 30 - 45 %

Radio Technology	Channel	Detector	Trace	Resolution Bandwidth /kHz	Frequency /MHz	Peak Value /dBm	Limit /dBm	Margin to Limit /dB
LTE eFDD26	low	rms	maxhold	5	814.0	-34.83	-23	11.83
LTE eFDD26	mid	rms	maxhold	-	-	-	-13	> 20
LTE eFDD26	hgh	rms	maxhold	5	824.0	-32.26	-23	9.26

Remark: Please see next sub-clause for the measurement plot.

5.30.4 MEASUREMENT PLOT (EXAMPLE PLOT, SHOWING WORST CASE, IF APPLICABLE)

LTE eFDD26 QPSK, Channel = high

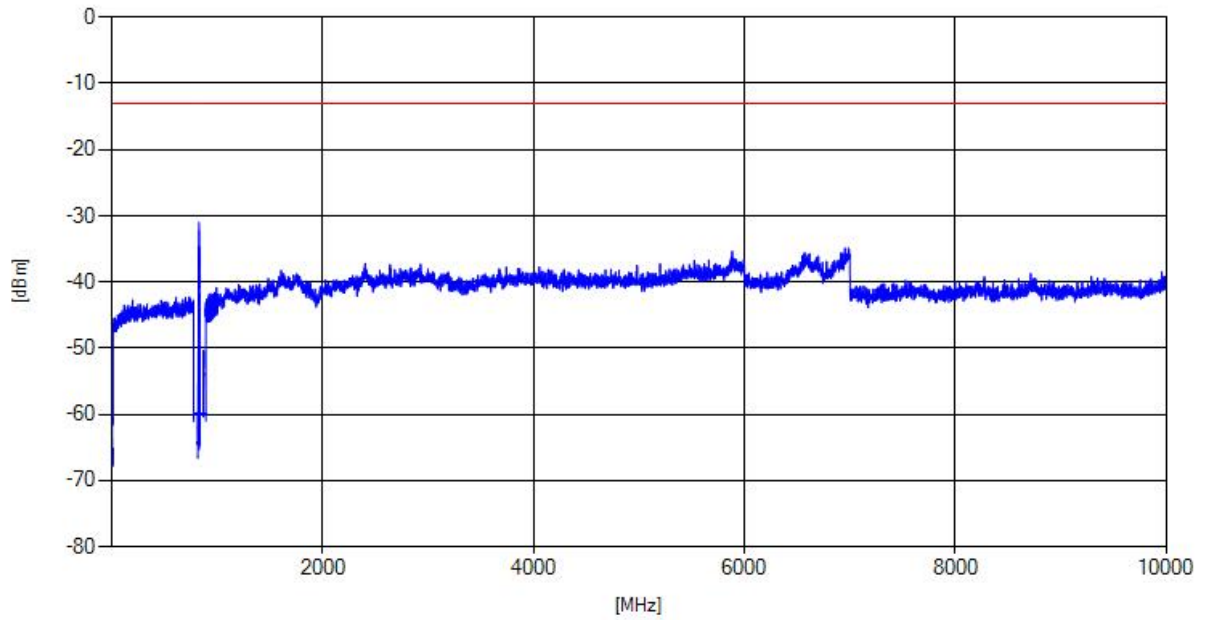

5.30.5 TEST EQUIPMENT USED

- Radio Lab

5.31 FIELD STRENGTH OF SPURIOUS RADIATION

Standard **FCC PART 90 Subpart S**

The test was performed according to:
ANSI C63.26: 2015

5.31.1 TEST DESCRIPTION

This test case is intended to demonstrate compliance to the applicable radiated spurious emission measurements per § 2.1053 and RSS-GEN 6.13. The limit and requirements come from the applicable rule part and ISED RSS-Standard for the operating band of the cellular device.

The EUT was connected to the test setup according to the following diagram:

Frequency Range: 30 MHz – 1 GHz:

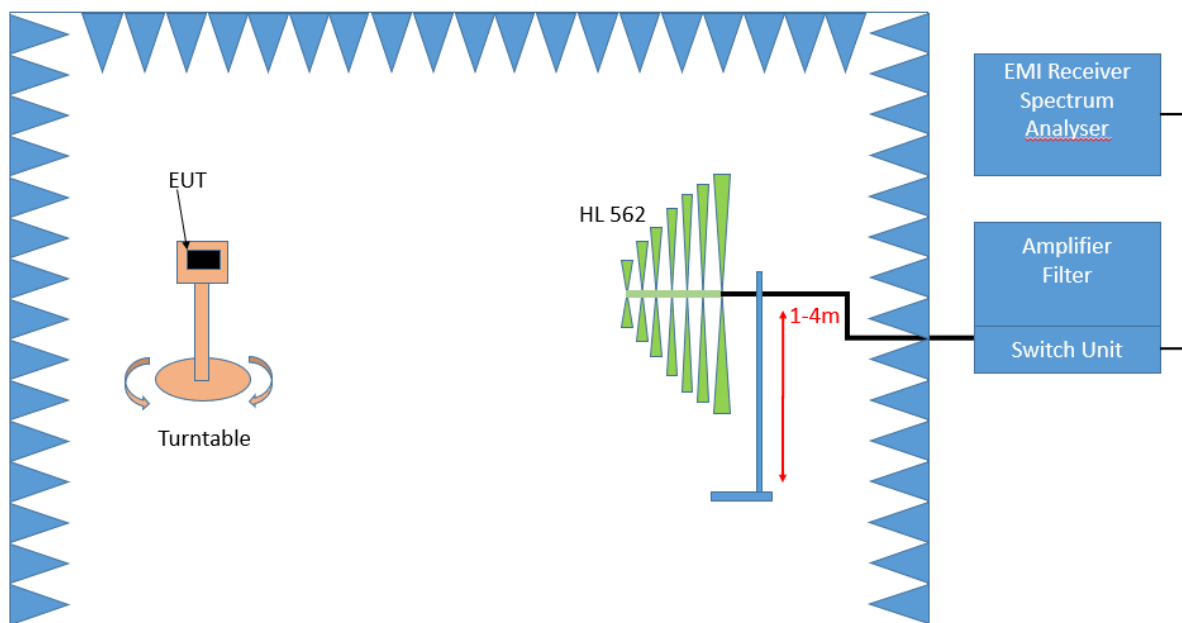

Test Setup; Spurious Emission Radiated (SAC), 30 MHz- 1GHz

Frequency Range: 1 GHz – 26.5 GHz

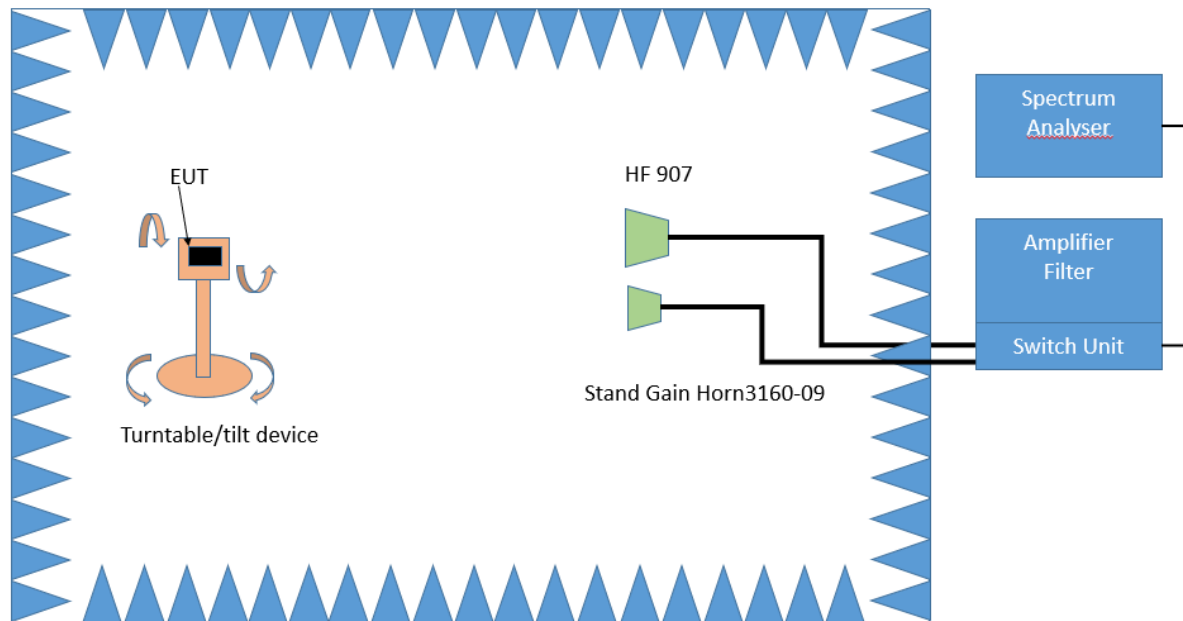

Test Setup; Spurious Emission Radiated (FAC), 1 GHz-26.5 GHz

The test set-up was made in accordance to the general provisions of ANSI C63.26 in a typical installation configuration. The Equipment Under Test (EUT) was set up on a non-conductive table 1.0 x 2.0 m² in the semi-anechoic chamber. The influence of the EUT support table that is used between 30–1000 MHz was evaluated.

The measurement procedure is implemented into the EMI test software EMC32 from R&S. Exploratory tests are performed at 3 orthogonal axes to determine the worst-case orientation of a body-worn or handheld EUT. The final test on all kind of EUTs is also performed at 3 axes. A pre-check is performed while the EUT is powered from a DC power source.

1. Measurement above 30 MHz and up to 1 GHz

Step 1: Preliminary scan

This is a preliminary test to identify the highest amplitudes relative to the limit.

Settings for step 1:

- Antenna distance: 3 m
- Detector: Peak
- RBW: 100 kHz
- VBW: 300 kHz
- Sweep time: coupled
- Turntable angle range: -180° to 90°
- Turntable step size: 90°
- Height variation range: 1 – 4 m
- Height variation step size: 1.5 m
- Polarisation: Horizontal + Vertical

Intention of this step is, to determine the radiated EMI-profile of the EUT. Afterwards the relevant emissions for the final measurement are identified.

Step 2: Adjustment measurement

In this step the accuracy of the turntable azimuth and antenna height will be improved. This is necessary to find out the maximum value of every frequency.

For each frequency, which was determined the turntable azimuth and antenna height will be adjusted. The turntable azimuth will slowly vary by 360° . During this action, the value of emission is continuously measured. The turntable azimuth at the highest emission will be

recorded and adjusted. In this position, the antenna height will also slowly vary from 1 – 4 m. During this action, the value of emission is also continuously measured. The antenna height of the highest emission will also be recorded and adjusted.

- Detector: Peak
- Measured frequencies: in step 1 determined frequencies
- RBW: 100 kHz
- VBW: 300 kHz
- Sweep time: coupled
- Turntable angle range: 360°
- Height variation range: 1 – 4 m
- Antenna Polarisation: max. value determined in step 1

Step 3: Final measurement with RMS detector

With the settings determined in step 3, the final measurement will be performed:

EMI receiver settings for step 4:

- Detector: RMQ
- Measured frequencies: in step 1 determined frequencies
- RBW: 100 kHz
- VBW: 300 kHz
- Sweep time: 1 s

After the measurement a plot will be generated which contains a diagram with the results of the preliminary scan and a chart with the frequencies and values of the results of the final measurement.

3. Measurement above 1 GHz

The following modifications apply to the measurement procedure for the frequency range above 1 GHz:

Step 1:

The Equipment Under Test (EUT) was set up on a non-conductive support (tilt device) at 1.5 m height in the fully-anechoic chamber.

All steps were performed with one height (1.5 m) of the receiving antenna only.

The EUT is turned during the preliminary measurement across the elevation axis, with a step size of 90 °.

The turn table step size (azimuth angle) for the preliminary measurement is 45 °.

- Antenna distance: 3 m
- Detector: Peak
- RBW: 1 MHz
- VBW: 3 MHz
- Sweep time: coupled
- Turntable angle range: -180° to 90°
- Turntable step size: 90°
- Polarisation: Horizontal + Vertical

Step 2:

Due to the fact, that in this frequency range the test is performed in a fully anechoic room, the height scan of the receiving antenna instep 2 is omitted. Instead of this, a maximum search with a step size $\pm 45^\circ$ for the elevation axis is performed.

The turn table azimuth will slowly vary by $\pm 22.5^\circ$.

The elevation angle will slowly vary by $\pm 45^\circ$

EMI receiver settings (for all steps):

- Detector: Peak,
- RBW: 1 MHz
- VBW: 3 MHz
- Sweep time: coupled

Step 3:

Spectrum analyser settings for step 3:

- Detector: RMS
- Measured frequencies: in step 1 determined frequencies
- RBW: 1 MHz
- VBW: 3 MHz
- Sweep Time: 1 s

5.31.2 TEST REQUIREMENTS / LIMITS

FCC Part 2.1053; Measurement required: Field strength of spurious radiation:

Measurements shall be made to detect spurious emissions that may be radiated directly from the cabinet, control circuits, power leads, or intermediate circuit elements under normal conditions of installation and operation. Curves or equivalent data shall be supplied showing the magnitude of each harmonic and other spurious emission. For this test, single sideband, independent sideband, and controlled carrier transmitters shall be modulated under the conditions specified in paragraph (c) of §2.1049, as appropriate.

Part 90; PRIVATE LAND MOBILE RADIO SERVICES

Subpart R—Regulations Governing the Licensing and Use of Frequencies in the 763-775 and 793-805 MHz Bands

§90.543 – Emission limitations.

(a) The adjacent channel power (ACP) requirements for transmitters designed for various channel sizes are shown in the following tables. Mobile station requirements apply to handheld, car mounted and control station units. The tables specify a value for the ACP as a function of the displacement from the channel center frequency and measurement bandwidth. In the following tables, "(s)" indicates a swept measurement may be used.

RSS-140; 4.4 Transmitter unwanted emission limits

The power of any unwanted emission outside the bands 758-768 MHz and 788-798 MHz shall be attenuated below the transmitter output power P in dBW as follows, where p is the transmitter output power in watts:

For any frequency between 769-775 MHz and 799-806 MHz:

$65 + 10 \log (p)$, dB in a 6.25 kHz band for mobile and portable/hand-held equipment

For any frequency between 775-788 MHz, above 806 MHz, and below 758 MHz: $43 + 10 \log (p)$, dB in a bandwidth of 100 kHz or greater. However, in the 100 kHz bands immediately outside and adjacent to the frequency bands 758-768 MHz and 788-798 MHz, a resolution bandwidth of 30 kHz may be employed.

In addition, the equivalent isotropically radiated power (e.i.r.p.) of all emissions, including harmonics in the band 1559-1610 MHz, shall not exceed -70 dBW/MHz for wideband emissions, and -80 dBW/kHz for discrete emissions of less than 700 Hz bandwidth.

5.31.3 TEST PROTOCOL

Ambient temperature: 20 - 28 °C
 Relative humidity: 30 - 45 %

Radio Technology	Channel	Detector	Trace	Resolution Bandwidth /kHz	Frequency /MHz	Peak Value /dBm	Limit /dBm	Margin to Limit /dB
LTE eFDD26	low	rms	maxhold	5	814.0	-34.83	-23	11.83
LTE eFDD26	mid	rms	maxhold	-	-	-	-13	> 20
LTE eFDD26	hgh	rms	maxhold	5	824.0	-25.00	-13	12.00

Remark: Please see next sub-clause for the measurement plot.

5.31.4 MEASUREMENT PLOT (EXAMPLE PLOT, SHOWING WORST CASE, IF APPLICABLE)

LTE eFDD26 QPSK, Channel = low
 30 MHz – 1 GHz

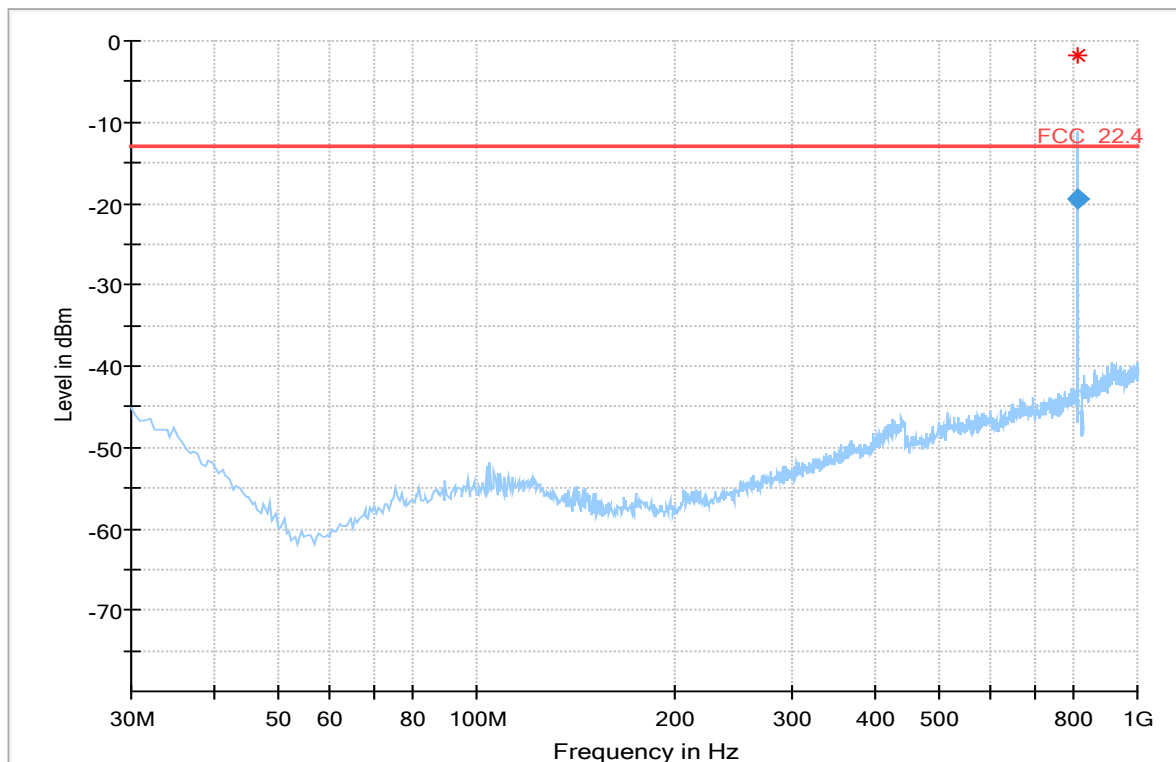

Frequency (MHz)	RMS (dBm)	Limit (dBm)	Margin (dB)	Meas. Time (ms)	Bandwidth (kHz)	Height (cm)	Pol	Azimuth (deg)	Corr. (dB)
814.000000	-19.39	-13.00	6.39	1000.0	100.000	105.0	H	-161.0	-73.5

1 GHz – 10 GHz

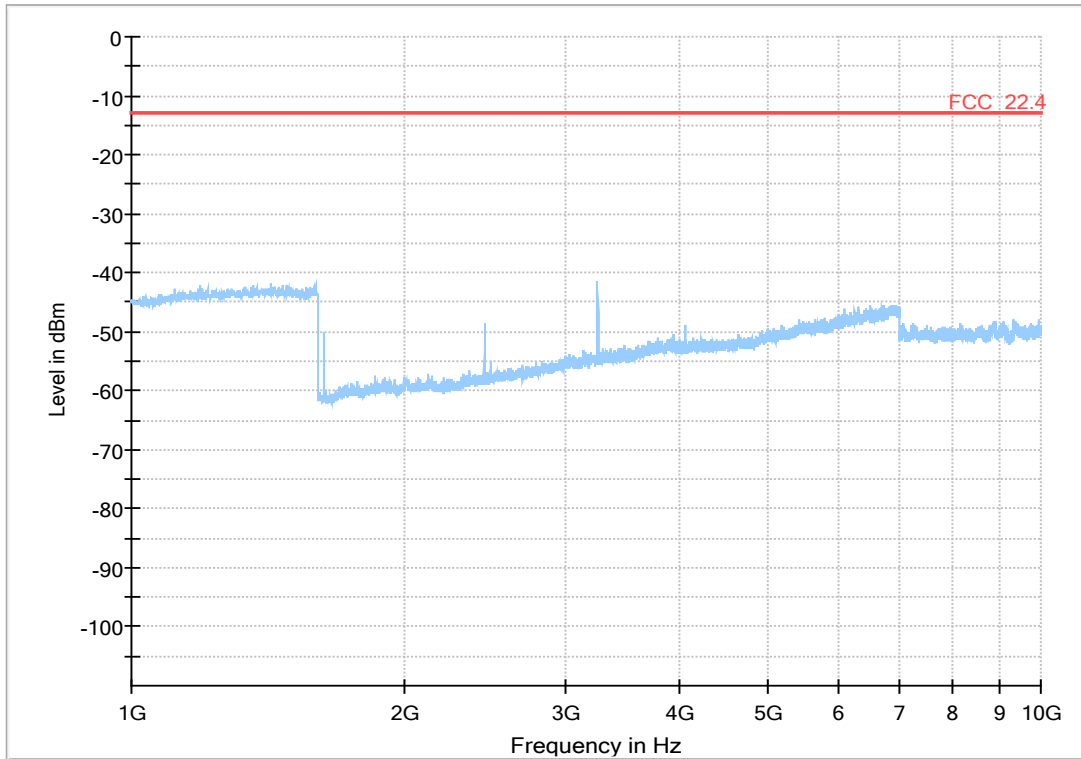

5.31.5 TEST EQUIPMENT USED

- Radiated Emissions

5.32 EMISSION AND OCCUPIED BANDWIDTH

Standard **FCC PART 90 Subpart S**

The test was performed according to:
ANSI C63.26: 2015

5.32.1 TEST DESCRIPTION

This test case is intended to demonstrate compliance to the applicable conducted spurious emission test case per FCC §2.1049 and RSS-GEN 6.7. The limit and the requirements come from the applicable rule part and ISED RSS-Standard for the operating band of the cellular device.

The EUT was connected to the test setups according to the following diagram:

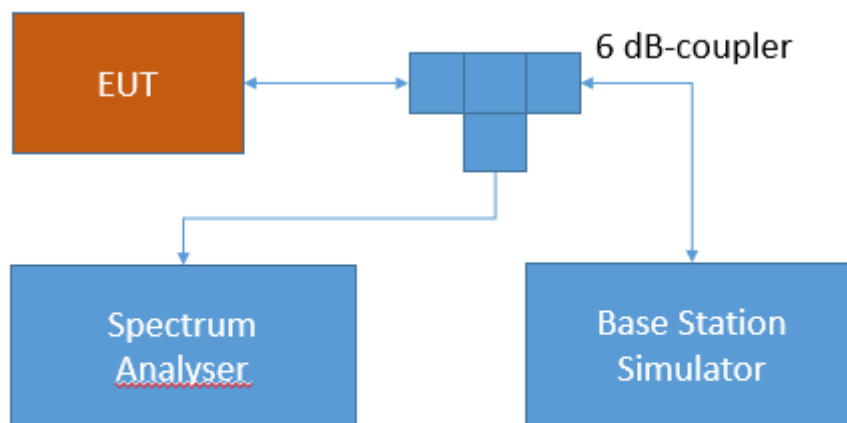

Test Setup FCC Part 22/24/27/90 Cellular;
Spurious Emissions at antenna terminal

The attenuation of the measuring and stimulus path are known for each measured frequency and are considered.

The Spectrum Analyzer settings can be directly found in the measurement diagrams.

5.32.2 TEST REQUIREMENTS / LIMITS

FCC Part 2.1049; Occupied Bandwidth:

The occupied bandwidth, that is the frequency bandwidth such that, below its lower and above its upper frequency limits, the mean powers radiated are each equal to 0.5 percent of the total mean power radiated by a given emission shall be measured under the following conditions as applicable:

(h) Transmitters employing digital modulation techniques—when modulated by an input signal such that its amplitude and symbol rate represent the maximum rated conditions under which the equipment will be operated. The signal shall be applied through any filter networks, pseudo-random generators or other devices required in normal service. Additionally, the occupied bandwidth shall be shown for operation with any devices used for modifying the spectrum when such devices are optional at the discretion of the user.

(i) Transmitters designed for other types of modulation—when modulated by an appropriate signal of sufficient amplitude to be representative of the type of service in which used. A description of the input signal should be supplied.

RSS-GEN; 6.7 Occupied Bandwidth

The emission bandwidth (\times dB) is defined as the frequency range between two points, one above and one below the carrier frequency, at which the spectral density of the emission is attenuated \times dB below the maximum in-band spectral density of the modulated signal. Spectral density (power per unit bandwidth) is to be measured with a detector of resolution bandwidth in the range of 1% to 5% of the anticipated emission bandwidth, and a video bandwidth at least $3\times$ the resolution bandwidth.

When the occupied bandwidth limit is not stated in the applicable RSS or reference measurement method, the transmitted signal bandwidth shall be reported as the 99% emission bandwidth, as calculated or measured.

The transmitter shall be operated at its maximum carrier power measured under normal test conditions.

The span of the analyzer shall be set to capture all products of the modulation process, including the emission skirts.

The resolution bandwidth (RBW) shall be in the range of 1% to 5% of the occupied bandwidth (OBW) and video bandwidth (VBW) shall be approximately $3\times$ RBW.

Note: Video averaging is not permitted.

A peak, or peak hold, may be used in place of the sampling detector as this may produce a wider bandwidth than the actual bandwidth (worst-case measurement). Use of a peak hold may be necessary to determine the occupied bandwidth if the device is not transmitting continuously.

The trace data points are recovered and are directly summed in linear power level terms. The recovered amplitude data points, beginning at the lowest frequency, are placed in a running sum until 0.5% of the total is reached and that frequency recorded. The process is repeated for the highest frequency data points (starting at the highest frequency, at the right side of the span, and going down in frequency). This frequency is then recorded. The difference between the two recorded frequencies is the 99% occupied bandwidth.

5.32.3 TEST PROTOCOL

Ambient temperature: 20 - 28 °C
 Relative humidity: 30 - 45 %

Radio Technology	Channel	Resource Blocks	Bandwidth [MHz]	Nominal BW [MHz]	99 % BW [kHz]
LTE eFDD 26 QPSK	low	6	1.4	1.4	1112.22
LTE eFDD 26 QPSK	mid	6	1.4	1.4	1106.21
LTE eFDD 26 QPSK	high	6	1.4	1.4	1106.21
LTE eFDD 26 16QAM	low	6	1.4	1.4	1100.2
LTE eFDD 26 16QAM	mid	6	1.4	1.4	1106.21
LTE eFDD 26 16QAM	high	6	1.4	1.4	1100.2
LTE eFDD 26 QPSK	low	15	3	3	2745.49
LTE eFDD 26 QPSK	mid	15	3	3	2745.49
LTE eFDD 26 QPSK	high	15	3	3	2765.53
LTE eFDD 26 16QAM	low	15	3	3	2785.57
LTE eFDD 26 16QAM	mid	15	3	3	2745.49
LTE eFDD 26 16QAM	high	15	3	3	2765.53
LTE eFDD 26 QPSK	low	25	5	5	4529.06
LTE eFDD 26 QPSK	mid	25	5	5	4529.06
LTE eFDD 26 QPSK	high	25	5	5	4509.02
LTE eFDD 26 16QAM	low	25	5	5	4529.06
LTE eFDD 26 16QAM	mid	25	5	5	4549.09
LTE eFDD 26 16QAM	high	25	5	5	4529.06
LTE eFDD 26 QPSK	mid	50	10	10	8977.96
LTE eFDD 26 16QAM	mid	12	10	10	2484.97

Remark: Please see next sub-clause for the measurement plot.

5.32.4 MEASUREMENT PLOT (EXAMPLE PLOT, SHOWING WORST CASE, IF APPLICABLE)

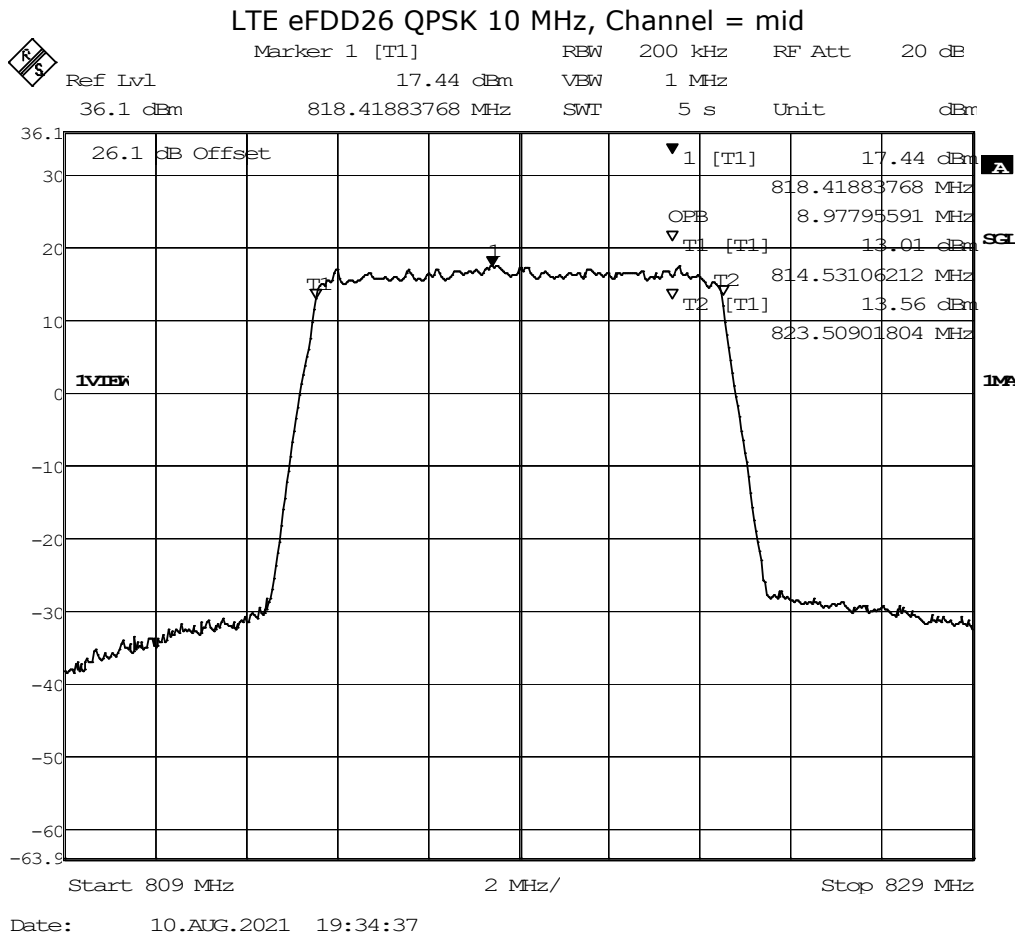

5.32.5 TEST EQUIPMENT USED

- Radio Lab

5.33 BAND EDGE

Standard **FCC PART 90 Subpart S**

The test was performed according to:
ANSI C63.26: 2015

5.33.1 TEST DESCRIPTION

This test case is intended to demonstrate compliance to the applicable conducted spurious emission test case per § 2.1051 and RSS-GEN 6.13. The limit comes from the applicable rule part and ISSED RSS-Standard for the operating band of the cellular device.

The EUT was connected to the test setup according to the following diagram:

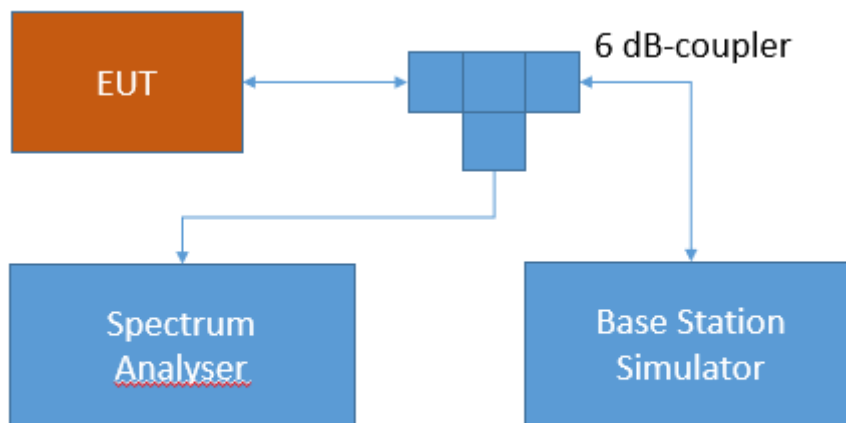

Test Setup FCC Part 22/24/27/90 Cellular;
Band edge compliance

The attenuation of the measuring and stimulus path are known for each measured frequency and are considered.

The Spectrum Analyzer settings can be directly found in the measurement diagrams.

5.33.2 TEST REQUIREMENTS / LIMITS

FCC Part 2.1051; Measurement required: Spurious emissions at antenna terminal:

The radio frequency voltage or powers generated within the equipment and appearing on a spurious frequency shall be checked at the equipment output terminals when properly loaded with a suitable artificial antenna. Curves or equivalent data shall show the magnitude of each harmonic and other spurious emission that can be detected when the equipment is operated under the conditions specified in §2.1049 as appropriate. The magnitude of spurious emissions which are attenuated more than 20 dB below the permissible value need not be specified.

Part 90; PRIVATE LAND MOBILE RADIO SERVICES

Subpart R—Regulations Governing the Licensing and Use of Frequencies in the 763-775 and 793-805 MHz Bands

§90.543 – Emission limitations.

(a) The adjacent channel power (ACP) requirements for transmitters designed for various channel sizes are shown in the following tables. Mobile station requirements apply to handheld, car mounted and control station units. The tables specify a value for the ACP as a function of the displacement from the channel center frequency and measurement bandwidth. In the following tables, "(s)" indicates a swept measurement may be used.

RSS-140; 4.4 Transmitter unwanted emission limits

The power of any unwanted emission outside the bands 758-768 MHz and 788-798 MHz shall be attenuated below the transmitter output power P in dBW as follows, where p is the transmitter output power in watts:

For any frequency between 769-775 MHz and 799-806 MHz:

$65 + 10 \log (p)$, dB in a 6.25 kHz band for mobile and portable/hand-held equipment

For any frequency between 775-788 MHz, above 806 MHz, and below 758 MHz: $43 + 10 \log (p)$, dB in a bandwidth of 100 kHz or greater. However, in the 100 kHz bands immediately outside and adjacent to the frequency bands 758-768 MHz and 788-798 MHz, a resolution bandwidth of 30 kHz may be employed.

In addition, the equivalent isotropically radiated power (e.i.r.p.) of all emissions, including harmonics in the band 1559-1610 MHz, shall not exceed -70 dBW/MHz for wideband emissions, and -80 dBW/kHz for discrete emissions of less than 700 Hz bandwidth.

5.33.3 TEST PROTOCOL

Ambient temperature: 20 - 28 °C
 Relative humidity: 30 - 45 %

Radio Technology	Channel	Ressource Blocks	Bandwidth [MHz]	Peak [dBm]	Average [dBm]	RMS [dBm]	Limit /dBm	Margin to Limit /dB
eFDD 26 QPSK	low	6	1.4	-20.51	-31.51	-29.92	-13	16.92
eFDD 26 QPSK	high	6	1.4	-19.49	-32.23	-30.84	-13	17.84
eFDD 26 QPSK	low	15	3	-14.58	-29.92	-27.42	-13	14.42
eFDD 26 QPSK	high	15	3	-16.97	-31.86	-29.10	-13	16.10
eFDD 26 QPSK	low	25	5	-16.28	-33.44	-30.22	-13	17.22
eFDD 26 QPSK	high	25	5	-15.32	-33.44	-30.22	-13	17.22
eFDD 26 QPSK	low	50	10	-16.34	-35.94	-32.62	-13	19.62
eFDD 26 QPSK	high	50	10	-15.47	-35.38	-32.62	-13	19.62
eFDD 26 16QAM	low	12	10	-13.35	-30.44	-27.06	-13	14.06
eFDD 26 16QAM	high	12	10	-13.17	-30.50	-27.28	-13	14.28

Remark: Please see next sub-clause for the measurement plot.

5.33.4 MEASUREMENT PLOT (EXAMPLE PLOT, SHOWING WORST CASE, IF APPLICABLE)

LTE eFDD26 16QAM 10MHz, Channel = low

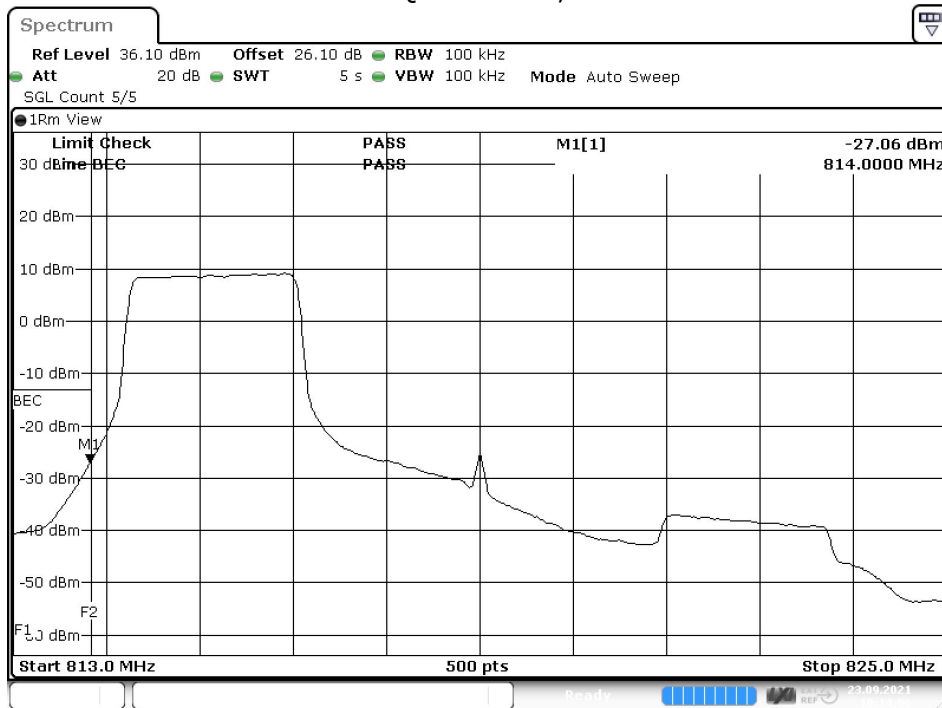

Date: 23.SEP.2021 10:14:07

5.33.5 TEST EQUIPMENT USED

- Radio Lab

5.34 PEAK TO AVERAGE RATIO

Standard **FCC PART 90 Subpart S**

The test was performed according to:
ANSI C63.26: 2015

5.34.1 TEST DESCRIPTION

This test case is intended to demonstrate compliance of the EUT to the peak-to-average limits and requirements of the applicable rule part and ISSED RSS-Standard for the operating band of the cellular device.

The EUT was connected to the test setup according to the following diagram:

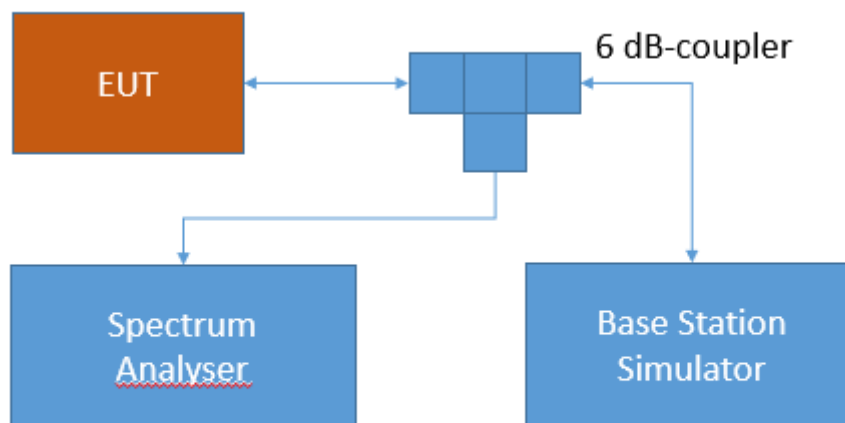

Test Setup FCC Part 22/24/27/90 Cellular;
Peak-average ratio

The attenuation of the measuring and stimulus path are known for each measured frequency and are considered.

The Spectrum Analyser settings can be directly found in the measurement diagrams. The internal CCDF (complementary cumulative distribution function) of the spectrum analyser is used for this measurement

5.34.2 TEST REQUIREMENTS / LIMITS

Part 90; PRIVATE LAND MOBILE RADIO SERVICES

Subpart S—Regulations Governing Licensing and Use of Frequencies in the 806-824, 851-869, 896-901, and 935-940 MHz Bands

§90.635 Limitations on power and antenna height.