

Qingdao Intelligent&Precise Electronics Co., Ltd

# RF TEST REPORT

**Report Type:**

FCC Part 15.247 & ISED RSS-247 RF report

**Model:**

ZDGF7638GU-T

**REPORT NUMBER:**

200401694SHA-003

**ISSUE DATE:**

May 18, 2020

**DOCUMENT CONTROL NUMBER:**

TTRF15.247-03\_V1 © 2018 Intertek



**Applicant:** Qingdao Intelligent&Precise Electronics Co., Ltd  
No.218, Qianwangang Road, Qingdao Economic&Technological  
Development Zone, Shandong, China.

**Manufacturer:** Qingdao Intelligent&Precise Electronics Co., Ltd  
No.218, Qianwangang Road, Qingdao Economic&Technological  
Development Zone, Shandong, China.

**Factory:** Qingdao Intelligent&Precise Electronics Co., Ltd  
No.218, Qianwangang Road, Qingdao Economic&Technological  
Development Zone, Shandong, China.

**FCC ID:** 2AJVQ-7638GUT

**IC:** 22470-7638GUT

**SUMMARY:**

The equipment complies with the requirements according to the following standard(s) or Specification:

**47CFR Part 15 (2019):** Radio Frequency Devices (Subpart C)

**ANSI C63.10 (2013):** American National Standard of Procedures for Compliance Testing of Unlicensed Wireless Devices

**RSS-247 Issue 2 (February 2017):** Digital Transmission Systems (DTSs), Frequency Hopping Systems (FHSs) and Licence-Exempt Local Area Network (LE-LAN) Devices

**RSS-Gen Issue 5 (March 2019) Amendment 1:** General Requirements for Compliance of Radio Apparatus

**PREPARED BY:**

**REVIEWED BY:**



Project Engineer  
Nemo Li

Reviewer  
Daniel Zhao

This report is for the exclusive use of Intertek's Client and is provided pursuant to the agreement between Intertek and its Client. Intertek's responsibility and liability are limited to the terms and conditions of the agreement. Intertek assumes no liability to any party, other than to the Client in accordance with the agreement, for any loss, expense or damage occasioned by the use of this report. Only the Client is authorized to permit copying or distribution of this report and then only in its entirety. Any use of the Intertek name or one of its marks for the sale or advertisement of the tested material, product or service must first be approved in writing by Intertek. The observations and test results in this report are relevant only to the sample tested. This report by itself does not imply that the material, product, or service is or has ever been under an Intertek certification program.

**TEST REPORT**

**Content**

**REVISION HISTORY..... 5**

**MEASUREMENT RESULT SUMMARY ..... 6**

**1 GENERAL INFORMATION ..... 7**

1.1 DESCRIPTION OF EQUIPMENT UNDER TEST (EUT) ..... 7

1.2 TECHNICAL SPECIFICATION ..... 7

1.3 ANTENNA INFORMATION..... 8

1.4 DESCRIPTION OF TEST FACILITY ..... 9

**2 TEST SPECIFICATIONS..... 10**

2.1 STANDARDS OR SPECIFICATION ..... 10

2.2 MODE OF OPERATION DURING THE TEST..... 10

2.3 TEST SOFTWARE LIST ..... 11

2.4 TEST PERIPHERALS LIST ..... 11

2.5 TEST ENVIRONMENT CONDITION:..... 11

2.6 INSTRUMENT LIST ..... 12

2.7 MEASUREMENT UNCERTAINTY ..... 14

**3 MINIMUM 6DB BANDWIDTH..... 15**

3.1 LIMIT ..... 15

3.2 MEASUREMENT PROCEDURE ..... 15

3.3 TEST CONFIGURATION ..... 15

3.4 TEST RESULTS OF MINIMUM 6DB BANDWIDTH ..... 15

**4 MAXIMUM CONDUCTED OUTPUT POWER AND E.I.R.P..... 16**

4.1 LIMIT ..... 16

4.2 MEASUREMENT PROCEDURE ..... 16

4.3 TEST CONFIGURATION ..... 17

4.4 TEST RESULTS OF MAXIMUM CONDUCTED OUTPUT POWER..... 17

**5 POWER SPECTRUM DENSITY ..... 18**

5.1 LIMIT ..... 18

5.2 MEASUREMENT PROCEDURE ..... 18

5.3 TEST CONFIGURATION ..... 19

5.4 TEST RESULTS OF POWER SPECTRUM DENSITY ..... 19

**6 EMISSION OUTSIDE THE FREQUENCY BAND ..... 20**

6.1 LIMIT ..... 20

6.2 MEASUREMENT PROCEDURE ..... 20

6.3 TEST CONFIGURATION ..... 21

6.4 THE RESULTS OF EMISSION OUTSIDE THE FREQUENCY BAND..... 21

**7 RADIATED EMISSIONS IN RESTRICTED FREQUENCY BANDS..... 22**

7.1 LIMIT ..... 22

7.2 MEASUREMENT PROCEDURE ..... 22

7.3 TEST CONFIGURATION ..... 24

7.4 TEST RESULTS OF RADIATED EMISSIONS ..... 26

**8 POWER LINE CONDUCTED EMISSION..... 29**

8.1 LIMIT ..... 29

8.2 TEST CONFIGURATION ..... 29

8.3 MEASUREMENT PROCEDURE ..... 30

Total Quality. Assured.

**TEST REPORT**

- 8.4 TEST RESULTS OF POWER LINE CONDUCTED EMISSION..... 31
- 9 OCCUPIED BANDWIDTH ..... 33**
  - 9.1 LIMIT ..... 33
  - 9.2 MEASUREMENT PROCEDURE ..... 33
  - 9.3 TEST CONFIGURATION ..... 33
  - 9.4 THE RESULTS OF OCCUPIED BANDWIDTH ..... 33
- 10 ANTENNA REQUIREMENT..... 34**
- APPENDIX A: TEST RESULTS ..... 35**

## Revision History

Report No.	Version	Description	Issued Date
200401694SHA-003	Rev. 01	Initial issue of report	May 18, 2020

### Measurement result summary

TEST ITEM	FCC REFERENCE	IC REFERENCE	RESULT
Minimum 6dB Bandwidth	15.247(a)(2)	RSS-247 Issue 2 Clause 5.2	Pass
Maximum conducted output power and e.i.r.p.	15.247(b)(3)	RSS-247 Issue 2 Clause 5.4	Pass
Power spectrum density	15.247(e)	RSS-247 Issue 2 Clause 5.2	Pass
Emission outside the frequency band	15.247(d)	RSS-247 Issue 2 Clause 5.5	Pass
Radiated Emissions in restricted frequency bands	15.247(d), 15.205&15.209	RSS-Gen Issue 5 Clause 8.9&8.10	Pass
Power line conducted emission	15.207(a)	RSS-Gen Issue 5 Clause 8.8	Pass
Occupied bandwidth	-	RSS-Gen Issue 5 Clause 6.6	Tested
Antenna requirement	15.203	-	Pass

Notes: 1: NA =Not Applicable

## 1 GENERAL INFORMATION

### 1.1 Description of Equipment Under Test (EUT)

Product name:	WLAN module
Type/Model:	ZDGF7638GU-T
Description of EUT:	EUT is a Wireless Module with WiFi function and Bluetooth function, and has only one model.
Rating:	DC 3.3V
EUT type:	<input checked="" type="checkbox"/> Table top <input type="checkbox"/> Floor standing
Software Version:	/
Hardware Version:	/
Sample received date:	April 17, 2020
Date of test:	April 17, 2020 ~ May 15, 2020

### 1.2 Technical Specification

Frequency Band:	2400MHz ~ 2483.5MHz
Support Standards:	IEEE 802.11b, IEEE 802.11g, IEEE 802.11n(HT20), IEEE 802.11n(HT40)
Type of Modulation:	IEEE 802.11b: DSSS (CCK, DQPSK, DBPSK) IEEE 802.11g: OFDM (64-QAM, 16-QAM, QPSK, BPSK) IEEE 802.11n(HT20): OFDM (64-QAM, 16-QAM, QPSK, BPSK) IEEE 802.11n(HT40): OFDM (64-QAM, 16-QAM, QPSK, BPSK)
Operating Frequency:	2412MHz to 2462MHz for IEEE 802.11b/g/n(HT20) 2422MHz to 2452MHz for IEEE 802.11n(HT40)
Channel Number:	11 Channels for 802.11b, 802.11g and 802.11n(HT20) 7 Channels for 802.11n(HT40)
Channel Separation:	5 MHz
Antenna:	PCB Antenna Antenna 0: 1.0dBi, Antenna 1: 0.7dBi

**TEST REPORT**

**1.3 Antenna information**

Mode	Tx/Rx Function	Beamforming function	CDD function	Directional gain (dBi)
802.11b	1Tx/1Rx	NO	NO	-
802.11g	1Tx/1Rx	NO	NO	-
802.11n(HT20)	2Tx/2Rx	NO	NO	0.85
802.11n(HT40)	2Tx/2Rx	NO	NO	0.85

Note: For 802.11b and 802.11g mode, it only supports 1TX.  
 For 802.11n modes, it can support 2TX, all the two transmit signals are completely uncorrelated with each other, so the directional gain =  $10 \log ((10^{G1/10} + 10^{G2/10} + \dots + 10^{Gn/10}) / N_{ANT})$



**TEST REPORT**

**1.4 Description of Test Facility**

Name:	Intertek Testing Services Shanghai
Address:	Building 86, No. 1198 Qinzhou Road(North), Shanghai 200233, P.R. China
Telephone:	86 21 61278200
Telefax:	86 21 54262353

The test facility is recognized, certified, or accredited by these organizations:	CNAS Accreditation Lab Registration No. CNAS L0139
	FCC Accredited Lab Designation Number: CN1175
	IC Registration Lab CAB identifier.: CN0051
	VCCI Registration Lab Registration No.: R-14243, G-10845, C-14723, T-12252
	A2LA Accreditation Lab Certificate Number: 3309.02

**TEST REPORT**

**2 TEST SPECIFICATIONS**

**2.1 Standards or specification**

47CFR Part 15 (2019)  
 ANSI C63.10 (2013)  
 KDB 662911 D01 (v02r01)  
 KDB 558074 (v05r02)  
 RSS-247 Issue 2 (February 2017)  
 RSS-Gen Issue 5 (March 2019) Amendment 1

**2.2 Mode of operation during the test**

While testing transmitting mode of EUT, the internal modulation and continuously transmission was applied.

Software name	Manufacturer	Version	Supplied by
QA Tool	MTK	-	Client

The lowest, middle and highest channel were tested as representatives.

Frequency Band (MHz)	Mode	Lowest (MHz)	Middle (MHz)	Highest (MHz)
2400-2483.5	802.11b	2412	2437	2462
	802.11g	2412	2437	2462
	802.11n(HT20)	2412	2437	2462
	802.11n(HT40)	2422	2437	2452

**Data rate and Power setting:**

The pre-scan for the conducted power with all rates in each modulation and bands was used, and the worst case was found and used in all test cases. After this pre-scan, we choose the following table of the data rata as the worst case.

Frequency Band (MHz)	Mode	Worst case data rate
2400-2483.5	802.11b	1Mbps
	802.11g	6Mbps
	802.11n(HT20)	MCS8
	802.11n(HT40)	MCS8

**TEST REPORT**

**2.3 Test software list**

Test Items	Software	Manufacturer	Version
Conducted emission	ESxS-K1	R&S	V2.1.0
Radiated emission	ES-K1	R&S	V1.71

**2.4 Test peripherals list**

Item No.	Name	Band and Model	Description
1	Laptop computer	DELL 5480	-

**2.5 Test environment condition:**

Test items	Temperature	Humidity
Minimum 6dB Bandwidth	22°C	54%RH
Maximum conducted output power and e.i.r.p.		
Power spectrum density		
Emission outside the frequency band		
Occupied bandwidth		
Radiated Emissions in restricted frequency bands	24°C	56%RH
Power line conducted emission	23°C	56%RH

## 2.6 Instrument list

Conducted Emission					
Used	Equipment	Manufacturer	Type	Internal no.	Due date
<input checked="" type="checkbox"/>	Test Receiver	R&S	ESCS 30	EC 2107	2020-07-14
<input checked="" type="checkbox"/>	A.M.N.	R&S	ESH2-Z5	EC 3119	2020-11-10
<input type="checkbox"/>	A.M.N.	R&S	ENV 216	EC 3393	2020-07-14
<input type="checkbox"/>	A.M.N.	R&S	ENV4200	EC 3558	2020-06-11
Radiated Emission					
Used	Equipment	Manufacturer	Type	Internal no.	Due date
<input checked="" type="checkbox"/>	Test Receiver	R&S	ESIB 26	EC 3045	2020-09-16
<input checked="" type="checkbox"/>	Bilog Antenna	TESEQ	CBL 6112D	EC 4206	2020-09-24
<input checked="" type="checkbox"/>	Pre-amplifier	R&S	AFS42-00101800-25-S-42	EC5262	2020-06-11
<input type="checkbox"/>	Horn antenna	R&S	HF 906	EC 3049	2021-01-17
<input type="checkbox"/>	Horn antenna	ETS	3117	EC 4792-1	2021-02-25
<input checked="" type="checkbox"/>	Horn antenna	TOYO	HAP18-26W	EC 4792-3	2020-07-09
<input checked="" type="checkbox"/>	Active loop antenna	Schwarzbeck	FMZB1519	EC 5345	2021-03-14
RF test					
Used	Equipment	Manufacturer	Type	Internal no.	Due date
<input checked="" type="checkbox"/>	PXA Signal Analyzer	Keysight	N9030A	EC 5338	2021-03-16
<input type="checkbox"/>	Power sensor	Agilent	U2021XA	EC 5338-1	2021-03-16
<input type="checkbox"/>	Vector Signal Generator	Agilent	N5182B	EC 5175	2021-03-16
<input type="checkbox"/>	Universal Radio Communication Tester	R&S	CMW500	EC5944	2020-12-09
<input type="checkbox"/>	MXG Analog Signal Generator	Agilent	N5181A	EC 5338-2	2021-03-16
<input type="checkbox"/>	Mobile Test System	Litepoint	lqxel	EC 5176	2021-01-16
<input type="checkbox"/>	Test Receiver	R&S	ESCI 7	EC 4501	2020-09-16
<input type="checkbox"/>	Climate chamber	GWS	MT3065	EC 6021	2020-07-04
<input checked="" type="checkbox"/>	Spectrum Analyzer	Keysight	N9030B	EC 6078	2020-06-11
Tet Site					
Used	Equipment	Manufacturer	Type	Internal no.	Due date
<input checked="" type="checkbox"/>	Shielded room	Zhongyu	-	EC 2838	2021-01-12

**TEST REPORT**

<input type="checkbox"/>	Shielded room	Zhongyu	-	EC 2839	2021-01-12
<input checked="" type="checkbox"/>	Semi-anechoic chamber	Albatross project	-	EC 3048	2020-06-31
<input type="checkbox"/>	Fully-anechoic chamber	Albatross project	-	EC 3047	2020-06-31
<b>Additional instrument</b>					
<b>Used</b>	<b>Equipment</b>	<b>Manufacturer</b>	<b>Type</b>	<b>Internal no.</b>	<b>Due date</b>
<input checked="" type="checkbox"/>	Therom-Hygrograph	ZJ1-2A	S.M.I.F.	EC 3783	2021-03-03
<input type="checkbox"/>	Therom-Hygrograph	ZJ1-2A	S.M.I.F.	EC 3481	2021-01-05
<input checked="" type="checkbox"/>	Therom-Hygrograph	ZJ1-2A	S.M.I.F.	EC 3442	2021-01-05
<input checked="" type="checkbox"/>	Therom-Hygrograph	ZJ1-2A	S.M.I.F.	EC 3324	2020-09-05
<input type="checkbox"/>	Pressure meter	YM3	Shanghai Mengde	EC 3320	2020-07-14

## 2.7 Measurement uncertainty

The measurement uncertainty represents an expanded uncertainty expressed at approximately the 95% confidence level using a coverage factor of k=2.

Test item	Measurement uncertainty
Maximum peak output power	± 0.74dB
Radiated Emissions in restricted frequency bands below 1GHz	± 4.90dB
Radiated Emissions in restricted frequency bands above 1GHz	± 5.02dB
Emission outside the frequency band	± 2.89dB
Power line conducted emission	± 3.19dB

**TEST REPORT****3 Minimum 6dB bandwidth**

Test result: Pass

**3.1 Limit**

For systems using digital modulation techniques that may operate in the 902 - 928 MHz, 2400 - 2483.5 MHz and 5725 - 5850 MHz bands, the minimum 6 dB bandwidth shall be at least 500 kHz.

**3.2 Measurement Procedure**

The EUT was tested according to Subclause 11.8 of ANSI C63.10.

- a) Set RBW = 100 kHz.
- b) Set the video bandwidth (VBW)  $\geq 3 \times$  RBW.
- c) Detector = Peak.
- d) Trace mode = max hold.
- e) Sweep = auto couple.
- f) Allow the trace to stabilize.
- g) Measure the maximum width of the emission that is constrained by the frequencies associated with the two outermost amplitude points (upper and lower frequencies) that are attenuated by 6 dB relative to the maximum level measured in the fundamental emission.

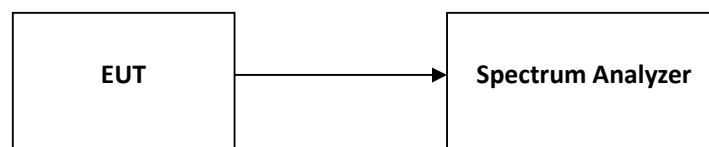
**3.3 Test Configuration****3.4 Test Results of Minimum 6dB bandwidth**

Please refer to Appendix A

## 4 Maximum conducted output power and e.i.r.p.

**Test result:** Pass

### 4.1 Limit

For systems using digital modulation in the 902-928 MHz, 2400-2483.5 MHz, and 5725-5850 MHz bands: 1 W. (The e.i.r.p. shall not exceed 4 W)

If the transmitting antenna of directional gain greater than 6dBi is used, the power shall be reduced by the amount in dB that the directional gain of the antenna exceeds 6dBi. If there have a beam forming type, the limit should be the minimum of 30dBm and 30+ (6 –antenna gain-beam forming gain).

### 4.2 Measurement Procedure

The EUT was tested according to Subclause 11.9.2.2 of ANSI C63.10.

- a) Measure the duty cycle,  $x$ , of the transmitter output signal as described in Section 6.0.
- b) Set span to at least  $1.5 \times \text{OBW}$ .
- c) Set RBW = 1 % to 5 % of the OBW, not to exceed 1 MHz.
- d) Set VBW  $\geq 3 \times \text{RBW}$ .
- e) Number of points in sweep  $\geq 2 \times \text{span} / \text{RBW}$ . (This gives bin-to-bin spacing  $\leq \text{RBW}/2$ , so that narrowband signals are not lost between frequency bins.)
- f) Sweep time = auto.
- g) Detector = RMS (i.e., power averaging), if available. Otherwise, use sample detector mode.
- h) Do not use sweep triggering. Allow the sweep to “free run”.
- i) Trace average at least 100 traces in power averaging (i.e., RMS) mode; however, the number of traces to be averaged shall be increased above 100 as needed such that the average accurately represents the true average over the on and off periods of the transmitter.
- j) Compute power by integrating the spectrum across the OBW of the signal using the instrument’s band power measurement function with band limits set equal to the OBW band edges. If the instrument does not have a band power function, sum the spectrum levels (in power units) at intervals equal to the RBW extending across the entire OBW of the spectrum.
- k) Add  $10 \log (1/x)$ , where  $x$  is the duty cycle, to the measured power in order to compute the average power during the actual transmission times (because the measurement represents an average over both the on- and off-times of the transmission). For example, add  $10 \log (1/0.25) = 6 \text{ dB}$  if the duty cycle is 25 %.



### 4.3 Test Configuration



### 4.4 Test Results of Maximum conducted output power

Please refer to Appendix A

## 5 Power spectrum density

Test result: Pass

### 5.1 Limit

For digitally modulated systems, the power spectral density conducted from the intentional radiator to the antenna shall not be greater than 8dBm in any 3 kHz band during any time interval of continuous transmission.

If the transmitting antenna of directional gain greater than 6dBi is used, the power shall be reduced by the amount in dB that the directional gain of the antenna exceeds 6dBi. If there have a beam forming type, the limit should be the minimum of 8dBm/MHz and  $8 + (6 - \text{antenna gain} - \text{beam forming gain})$ .

### 5.2 Measurement Procedure

The EUT was tested according to Subclause 11.10 of ANSI C63.10.

This procedure is applicable when the EUT cannot be configured to transmit continuously (i.e., duty cycle < 98 %), and when sweep triggering/signal gating cannot be used to measure only when the EUT is transmitting at its maximum power control level, and when the transmission duty cycle is constant (i.e., duty cycle variations are less than  $\pm 2\%$ ):

- a) Measure the duty cycle (x) of the transmitter output signal as described in Section 6.0.
- b) Set instrument center frequency to DTS channel center frequency.
- c) Set span to at least  $1.5 \times \text{OBW}$ .
- d) Set RBW to:  $3 \text{ kHz} \leq \text{RBW} \leq 100 \text{ kHz}$ .
- e) Set VBW  $\geq 3 \times \text{RBW}$ .
- f) Detector = power averaging (RMS) or sample detector (when RMS not available).
- g) Ensure that the number of measurement points in the sweep  $\geq 2 \times \text{span}/\text{RBW}$ .
- h) Sweep time = auto couple.
- i) Do not use sweep triggering. Allow sweep to "free run".
- j) Employ trace averaging (RMS) mode over a minimum of 100 traces.
- k) Use the peak marker function to determine the maximum amplitude level.
- l) Add  $10 \log(1/x)$ , where x is the duty cycle measured in step (a), to the measured PSD to compute the average PSD during the actual transmission time.
- m) If resultant value exceeds the limit, then reduce RBW (no less than 3 kHz) and repeat (note that this may require zooming in on the emission of interest and reducing the span in order to meet the minimum measurement point requirement as the RBW is reduced).

### 5.3 Test Configuration



### 5.4 Test Results of Power spectrum density

Please refer to Appendix A

## 6 Emission outside the frequency band

Test result: Pass

### 6.1 Limit

In any 100 kHz bandwidth outside the frequency band in which the spread spectrum intentional radiator is operating, the radio frequency power that is produced by the intentional radiator shall be at least 30 dB below that in the 100 kHz bandwidth within the band that contains the highest level of the desired power.

### 6.2 Measurement Procedure

The EUT was tested according to Subclause 11.11 of ANSI C63.10.

#### Reference level measurement

Establish a reference level by using the following procedure:

- a) Set instrument center frequency to DTS channel center frequency.
- b) Set the span to  $\geq 1.5$  times the DTS bandwidth.
- c) Set the RBW = 100 kHz.
- d) Set the VBW  $\geq 3 \times$  RBW.
- e) Detector = peak.
- f) Sweep time = auto couple.
- g) Trace mode = max hold.
- h) Allow trace to fully stabilize.
- i) Use the peak marker function to determine the maximum PSD level.

#### Emission level measurement

- a) Set the center frequency and span to encompass frequency range to be measured.
- b) Set the RBW = 100 kHz.
- c) Set the VBW  $\geq 3 \times$  RBW.
- d) Detector = peak.
- e) Sweep time = auto couple.
- f) Trace mode = max hold.
- g) Allow trace to fully stabilize.
- h) Use the peak marker function to determine the maximum amplitude level.

Ensure that the amplitude of all unwanted emissions outside of the authorized frequency band (excluding restricted frequency bands) are attenuated by at least the minimum requirements specified in 11.1 a) or 11.1 b). Report the three highest emissions relative to the limit.

### 6.3 Test Configuration

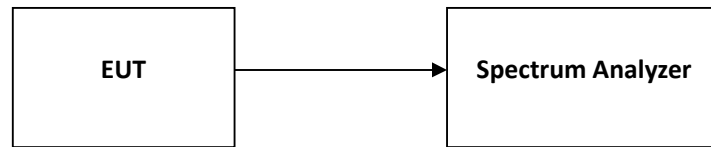

### 6.4 The results of Emission outside the frequency band

Please refer to Appendix A

## 7 Radiated Emissions in restricted frequency bands

Test result: Pass

### 7.1 Limit

The radiated emissions which fall in the restricted bands, must also comply with the radiated emission limits specified showed as below:

Frequencies (MHz)	Field Strength (microvolts/meter)	Measurement Distance (meters)
0.009 ~ 0.490	2400/F(kHz)	300
0.490 ~ 1.705	24000/F(kHz)	30
1.705 ~ 30.0	30	30
30 ~ 88	100	3
88 ~ 216	150	3
216 ~ 960	200	3
Above 960	500	3

### 7.2 Measurement Procedure

The EUT was tested according to Subclause 11.12 of ANSI C63.10.

#### For Radiated emission below 30MHz:

- a) The EUT was placed on the top of a rotating table 0.8 meters above the ground at a 3 meters chamber room. The table was rotated 360 degrees to determine the position of the highest radiation.
- b) The EUT was set 3 meters away from the interference-receiving antenna, which was mounted on the top of a variable-height antenna tower.
- c) Both X and Y axes of the antenna are set to make the measurement.
- d) For each suspected emission, the EUT was arranged to its worst case and the rotatable table was turned from 0 degrees to 360 degrees to find the maximum reading.
- e) The test-receiver system was set to Quasi-Peak Detect Function and Specified Bandwidth with Maximum Hold Mode.

#### NOTE:

1. The resolution bandwidth and video bandwidth of test receiver/spectrum analyzer is 9kHz at frequency below 30MHz.

**TEST REPORT****For Radiated emission above 30MHz:**

- a) The EUT was placed on the top of a rotating table 0.8 meters (for 30MHz ~ 1GHz) / 1.5 meters (for above 1GHz) above the ground at 3 meters chamber room for test. The table was rotated 360 degrees to determine the position of the highest radiation.
- b) The EUT was set 3 meters away from the interference-receiving antenna, which was mounted on the top of a variable-height antenna tower.
- c) The height of antenna is varied from one meter to four meters above the ground to determine the maximum value of the field strength. Both horizontal and vertical polarizations of the antenna are set to make the measurement.
- d) For each suspected emission, the EUT was arranged to its worst case and then the antenna was tuned to heights from 1 meter to 4 meters and the rotatable table was turned from 0 degrees to 360 degrees to find the maximum reading.
- e) The test-receiver system was set to quasi-peak detect function and specified bandwidth with maximum hold mode when the test frequency is below 1 GHz.
- f) The test-receiver system was set to peak and average detector function and specified bandwidth with maximum hold mode when the test frequency is above 1 GHz. If the peak reading value also meets average limit, measurement with the average detector is unnecessary.

**Note:**

- 1. The resolution bandwidth and video bandwidth of test receiver/spectrum analyzer is 120kHz for Quasi-peak detection (QP) at frequency below 1GHz.
- 2. The resolution bandwidth of test receiver/spectrum analyzer is 1 MHz and the video bandwidth is 3 MHz for Peak detection (PK) at frequency above 1GHz.
- 3. The resolution bandwidth of test receiver/spectrum analyzer is 1 MHz and the video bandwidth is  $\geq 1/T$  (Duty cycle < 98%) or  $3 \times \text{RBW}$  (Duty cycle  $\geq 98\%$ ) for Average detection (AV) at frequency above 1GHz.
- 4. All modes of operation were investigated and the worst-case emissions were reported.

### 7.3 Test Configuration

For Radiated emission below 30MHz:

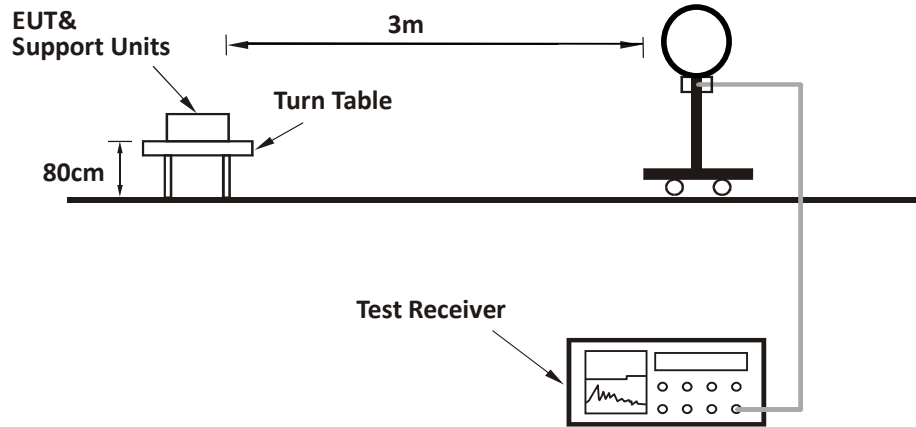

For Radiated emission 30MHz to 1GHz:

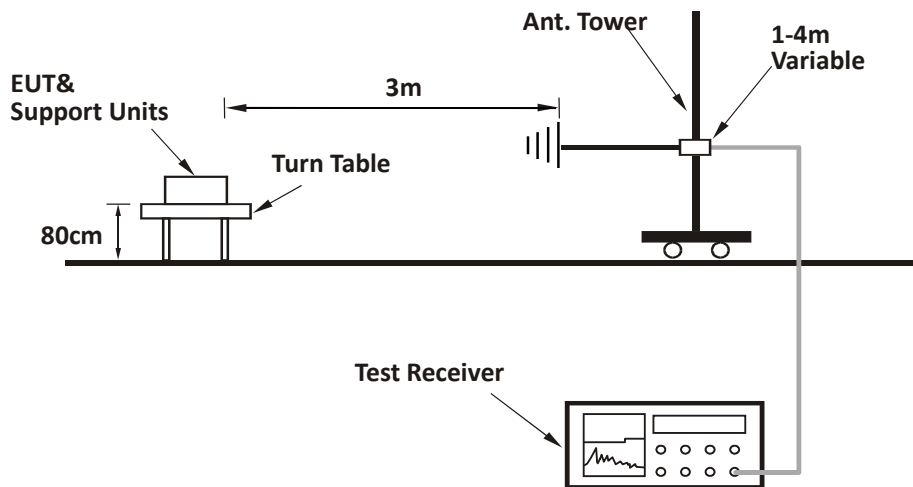



**For Radiated emission above 1GHz:**

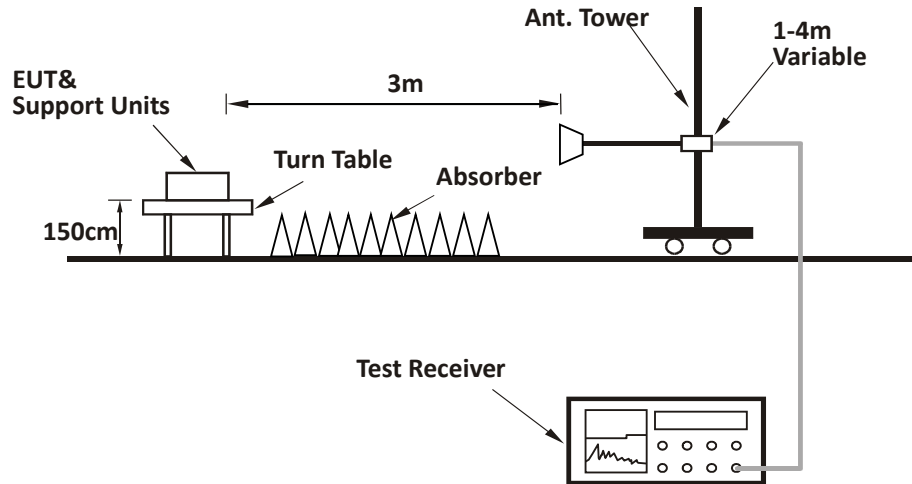

**TEST REPORT**

**7.4 Test Results of Radiated Emissions**

The low frequency, which started from 9 kHz to 30MHz, was pre-scanned and the result which was 20dB lower than the limit line per 15.31(o) was not reported.

EUT was tested with Bluetooth transmitting on and off simultaneously, and the worst data was listed in the report.

**Test data below 1GHz**

Antenna	Frequency (MHz)	Corrected Reading (dBuV/m)	Correct Factor (dB/m)	Limit (dBuV/m)	Margin (dB)	Detector
H	32.30	28.90	17.50	40	11.10	PK
H	136.47	25.80	12.60	43.5	17.20	PK
H	246.58	34.60	13.30	46	11.40	PK
H	245.34	35.60	13.80	46	10.40	PK
H	351.15	30.90	16.30	46	15.10	PK
H	958.46	31.70	24.10	46	14.30	PK
V	30.00	25.80	18.60	40	14.20	PK
V	43.28	25.80	11.50	40	14.20	PK
V	92.35	31.40	10.30	43.5	12.10	PK
V	125.28	29.40	13.00	43.5	14.10	PK
V	256.36	29.80	14.70	46	16.20	PK
V	958.38	29.80	24.10	46	16.20	PK

**Test result above 1GHz:**

The emission was conducted from 1GHz to 25GHz

802.11b

CH	Antenna	Frequency (MHz)	Corrected Reading (dBuV/m)	Correct Factor (dB/m)	Limit (dBuV/m)	Margin (dB)	Detector
L	H/V	2412	108.50	34.80	Fundamental	/	PK
	H/V	2390	52.50	34.70	74.00	21.50	PK
M	H/V	2437	109.00	34.80	Fundamental	/	PK
H	H/V	2462	109.30	34.80	Fundamental	/	PK

**TEST REPORT**

	H/V	2483.5	52.50	34.90	74.00	21.50	PK
--	-----	--------	-------	-------	-------	-------	----

## 802.11g

CH	Antenna	Frequency (MHz)	Corrected Reading (dBuV/m)	Correct Factor (dB/m)	Limit (dBuV/m)	Margin (dB)	Detector
L	H/V	2412	107.00	34.80	Fundamental	/	PK
	H/V	2390	61.00	34.70	74.00	13.00	PK
	H/V	2390	48.50	34.70	54.00	5.50	AV
M	H/V	2437	107.50	34.80	Fundamental	/	PK
H	H/V	2462	108.00	34.80	Fundamental	/	PK
	H/V	2483.5	66.50	34.90	74.00	7.50	PK
	H/V	2483.5	50.00	34.90	54.00	4.00	AV

## 802.11n(HT20)

CH	Antenna	Frequency (MHz)	Corrected Reading (dBuV/m)	Correct Factor (dB/m)	Limit (dBuV/m)	Margin (dB)	Detector
L	H/V	2412	113.20	34.80	Fundamental	/	PK
	H/V	2390	69.77	34.70	74.00	4.23	PK
	H/V	2390	51.50	34.70	54.00	2.50	AV
M	H/V	2437	113.50	34.80	Fundamental	/	PK
H	H/V	2462	113.70	34.80	Fundamental	/	PK
	H/V	2483.5	70.97	34.90	74.00	3.03	PK
	H/V	2483.5	53.65	34.90	54.00	0.35	AV

## 802.11n(HT40)

CH	Antenna	Frequency (MHz)	Corrected Reading (dBuV/m)	Correct Factor (dB/m)	Limit (dBuV/m)	Margin (dB)	Detector
L	H/V	2422	109.30	34.80	Fundamental	/	PK
	H/V	2390	72.44	34.70	74.00	1.56	PK
	H/V	2390	53.00	34.70	54.00	1.00	AV
M	H/V	2437	109.80	34.80	Fundamental	/	PK
H	H/V	2452	110.30	34.80	Fundamental	/	PK
	H/V	2483.5	73.85	34.90	74.00	0.15	PK

Total Quality. Assured.

**TEST REPORT**

	H/V	2483.5	53.80	34.90	54.00	0.20	AV
--	-----	--------	-------	-------	-------	------	----

- Remark: 1. Correct Factor = Antenna Factor + Cable Loss (+ Amplifier, for higher than 1GHz), the value was added to Original Receiver Reading by the software automatically.
2. Corrected Reading = Original Receiver Reading + Correct Factor
3. Margin = Limit - Corrected Reading
4. If the PK Corrected Reading is lower than AV limit, the AV test can be elided.

Example: Assuming Antenna Factor = 30.20dB/m, Cable Loss = 2.00dB,  
 Gain of Preamplifier = 32.00dB, Original Receiver Reading = 10.00dBuV,  
 Limit = 40.00dBuV/m.  
 Then Correct Factor = 30.20 + 2.00 – 32.00 = 0.20dB/m;  
 Corrected Reading = 10dBuV + 0.20dB/m = 10.20dBuV/m;  
 Margin = 40.00dBuV/m - 10.20dBuV/m = 29.80dB.

## 8 Power line conducted emission

Test result: Pass

### 8.1 Limit

Frequency of Emission (MHz)	Conducted Limit (dBuV)	
	QP	AV
0.15-0.5	66 to 56*	56 to 46 *
0.5-5	56	46
5-30	60	50

\* Decreases with the logarithm of the frequency.

### 8.2 Test Configuration

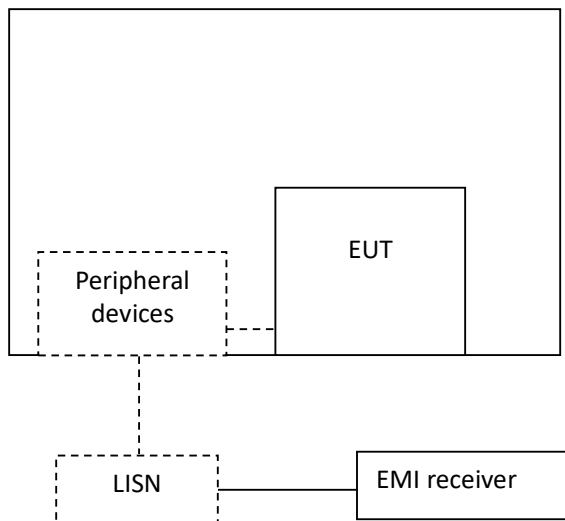

**TEST REPORT****8.3 Measurement Procedure**

Measured levels of ac power-line conducted emission shall be the emission voltages from the voltage probe, where permitted, or across the 50  $\Omega$  LISN port (to which the EUT is connected), where permitted, terminated into a 50  $\Omega$  measuring instrument. All emission voltage and current measurements shall be made on each current-carrying conductor at the plug end of the EUT power cord by the use of mating plugs and receptacles on the LISN, if used. Equipment shall be tested with power cords that are normally supplied or recommended by the manufacturer and that have electrical and shielding characteristics that are the same as those cords normally supplied or recommended by the manufacturer. For those measurements using a LISN, the 50  $\Omega$  measuring port is terminated by a measuring instrument having 50  $\Omega$  input impedance. All other ports are terminated in 50  $\Omega$  loads.

Tabletop devices shall be placed on a platform of nominal size 1 m by 1.5 m, raised 80 cm above the reference ground plane. The vertical conducting plane or wall of an RF-shielded (screened) room shall be located 40 cm to the rear of the EUT. Floor-standing devices shall be placed either directly on the reference ground-plane or on insulating material as described in ANSI C63.4. All other surfaces of tabletop or floor-standing EUTs shall be at least 80 cm from any other grounded conducting surface, including the case or cases of one or more LISNs.

The bandwidth of the test receiver is set at 9 kHz.

### 8.4 Test Results of Power line conducted emission

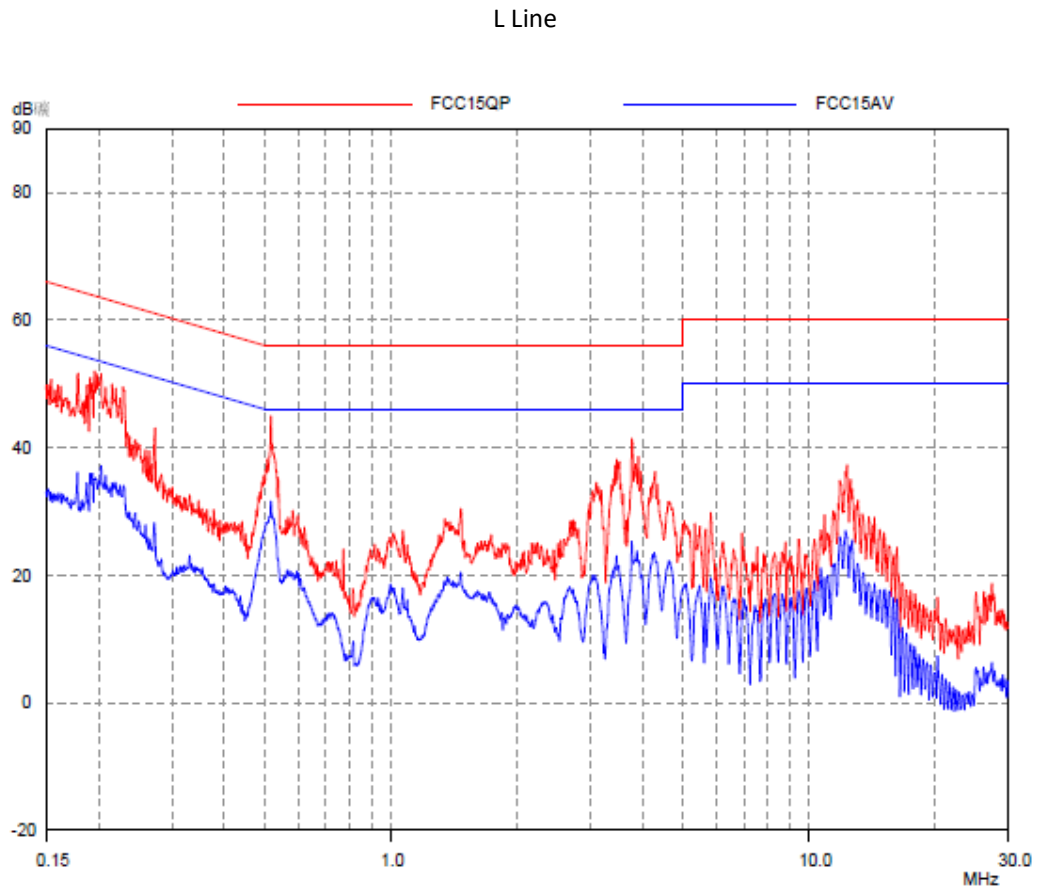

N Line

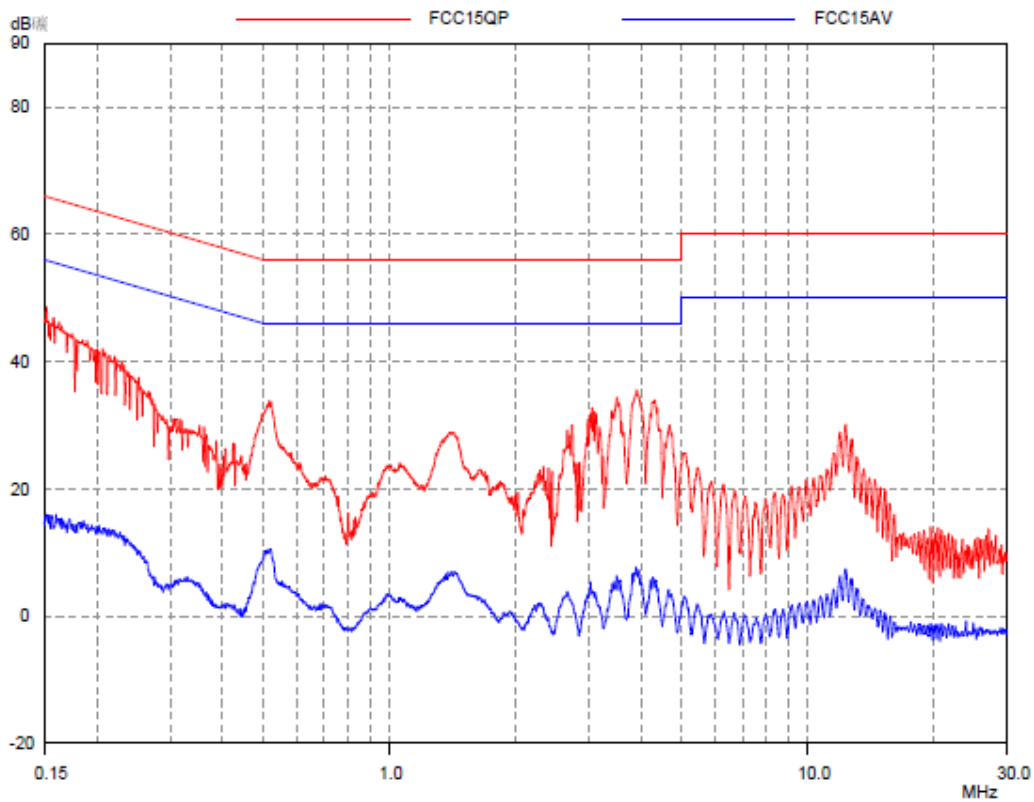

- Remark: 1. Correct Factor = LISN Factor + Cable Loss, the value was added to Original Receiver Reading by the software automatically.*
- 2. Corrected Reading = Original Receiver Reading + Correct Factor*
- 3. Margin = Limit - Corrected Reading*
- 4. If the PK Corrected Reading is lower than AV limit, the AV test can be elided.*



## 9 Occupied Bandwidth

**Test result:**      **Tested**

### 9.1 Limit

None

### 9.2 Measurement Procedure

The occupied bandwidth per RSS-Gen Issue 4 Clause 6.6 was measured using the Spectrum Analyzer.

The span of the analyzer shall be set to capture all products of the modulation process, including the emission skirts.

The resolution bandwidth (RBW) shall be in the range of 1% to 5% of the occupied bandwidth (OBW) and video bandwidth (VBW) shall be approximately 3x RBW.

### 9.3 Test Configuration

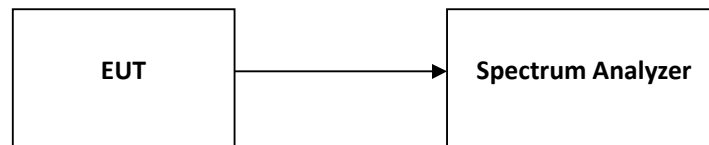

### 9.4 The results of Occupied Bandwidth

Please refer to Appendix A

## 10 Antenna requirement

**Requirement:**

An intentional radiator shall be designed to ensure that no antenna other than that furnished by the responsible party shall be used with the device. The use of a permanently attached antenna or of an antenna that uses a unique coupling to the intentional radiator shall be considered sufficient to comply with the provisions of this section.

**Result:**

EUT uses permanently attached antenna to the intentional radiator, so it can comply with the provisions of this section.

**TEST REPORT**

**Appendix A: Test results**

1. Duty Cycle

1.1 Test Data

WLAN Duty Cycle				
Mode	Test Frequency (MHz)	Ant	Duty Cycle (%)	Duty Cycle Factor (dB)
802.11b	2412	Ant0	99.68	0.00
802.11b	2412	Ant1	99.68	0.00
802.11b	2437	Ant0	99.64	0.00
802.11b	2437	Ant1	99.68	0.00
802.11b	2462	Ant0	99.64	0.00
802.11b	2462	Ant1	99.68	0.00
802.11g	2412	Ant0	97.48	0.11
802.11g	2412	Ant1	97.48	0.11
802.11g	2437	Ant0	97.48	0.11
802.11g	2437	Ant1	97.68	0.10
802.11g	2462	Ant0	97.48	0.11
802.11g	2462	Ant1	97.48	0.11
802.11n (HT20)	2412	Ant0	97.53	0.11
802.11n (HT20)	2412	Ant1	97.53	0.11
802.11n (HT20)	2437	Ant0	97.30	0.12
802.11n (HT20)	2437	Ant1	97.30	0.12
802.11n (HT20)	2462	Ant0	97.30	0.12
802.11n (HT20)	2462	Ant1	97.53	0.11
802.11n (HT40)	2422	Ant0	94.74	0.23
802.11n (HT40)	2422	Ant1	95.15	0.22
802.11n (HT40)	2437	Ant0	95.15	0.22
802.11n (HT40)	2437	Ant1	94.74	0.23
802.11n (HT40)	2452	Ant0	95.15	0.22
802.11n (HT40)	2452	Ant1	95.15	0.22

### 1.2 Test Plots

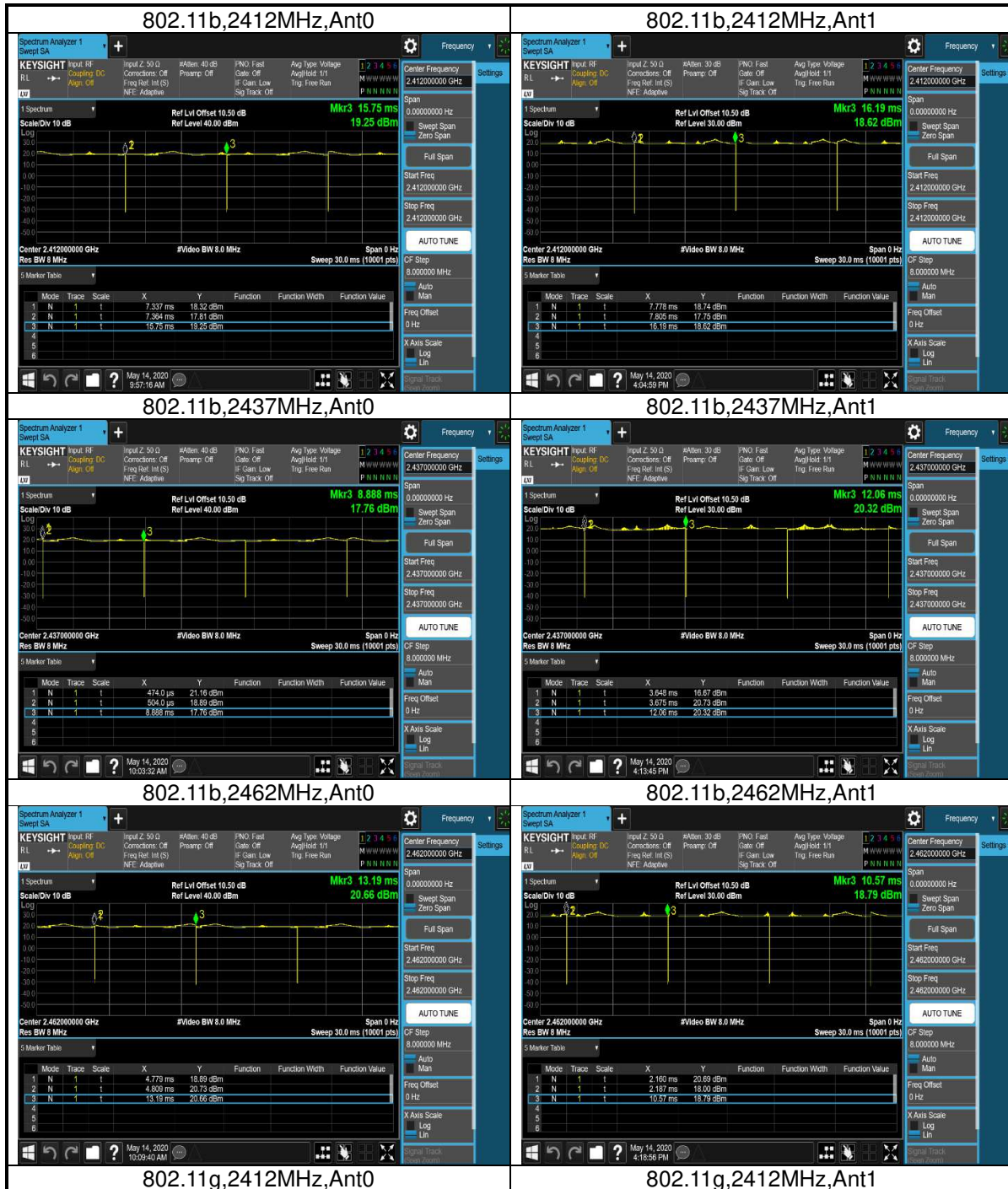

## TEST REPORT

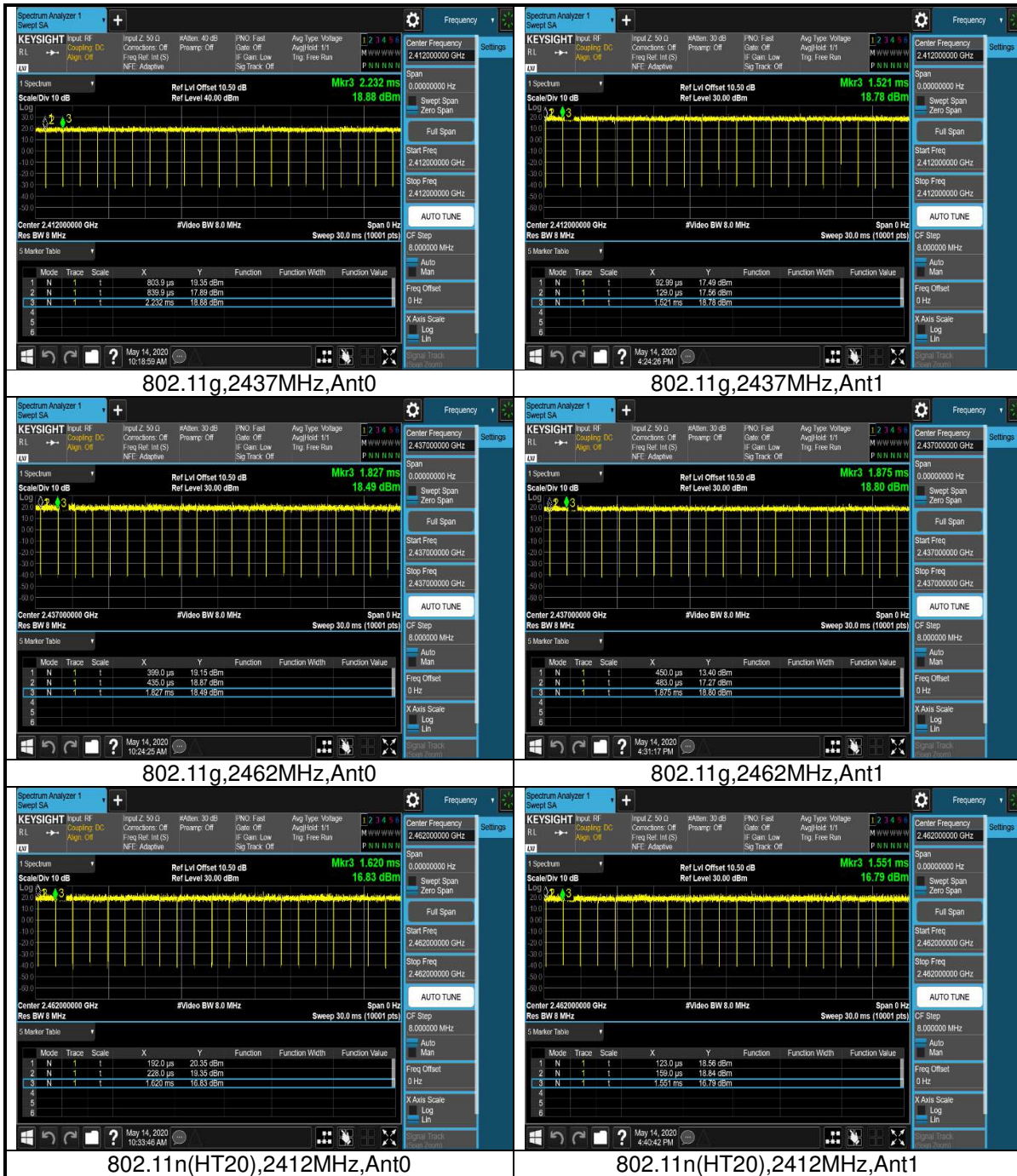

## TEST REPORT

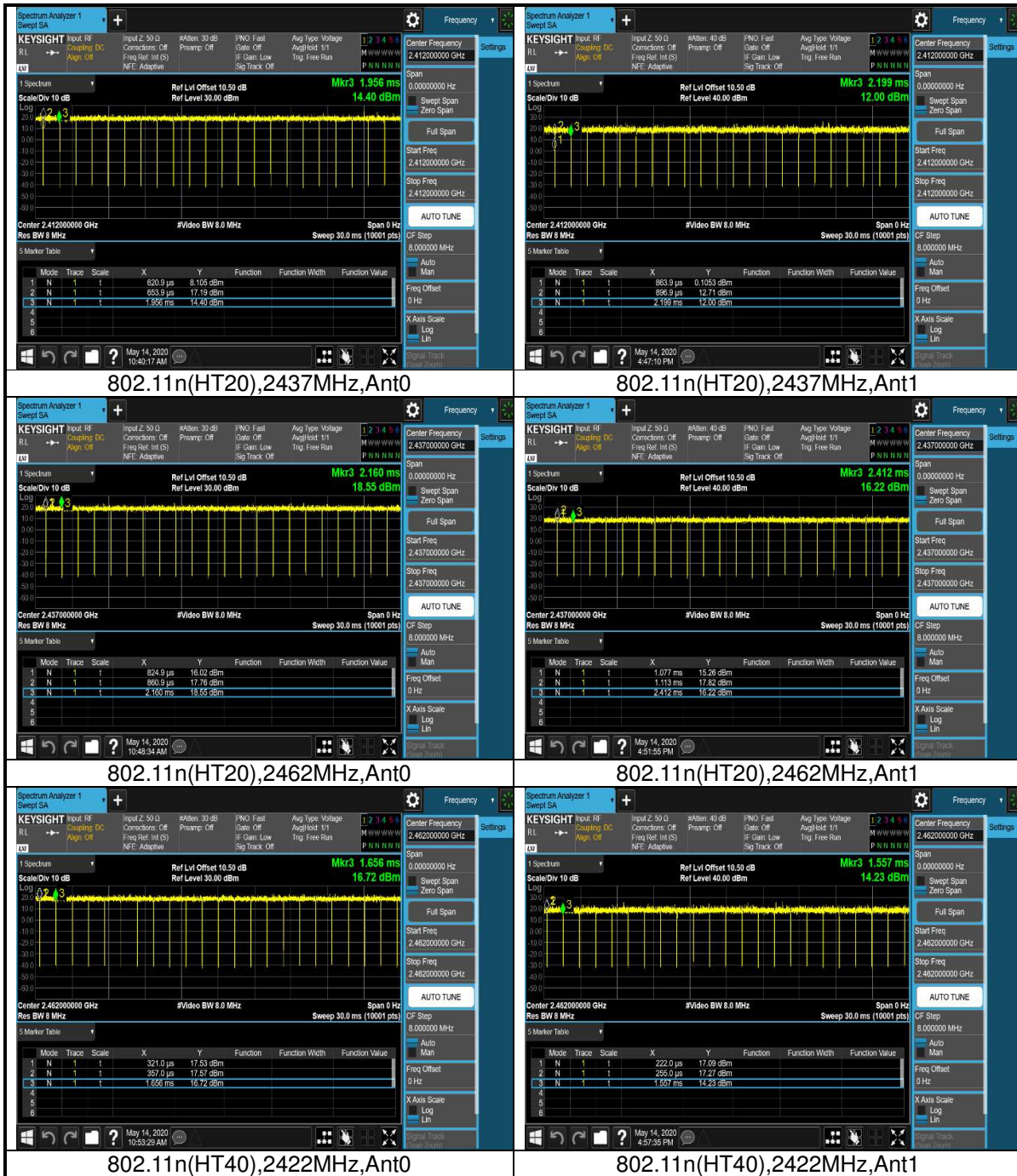



## TEST REPORT

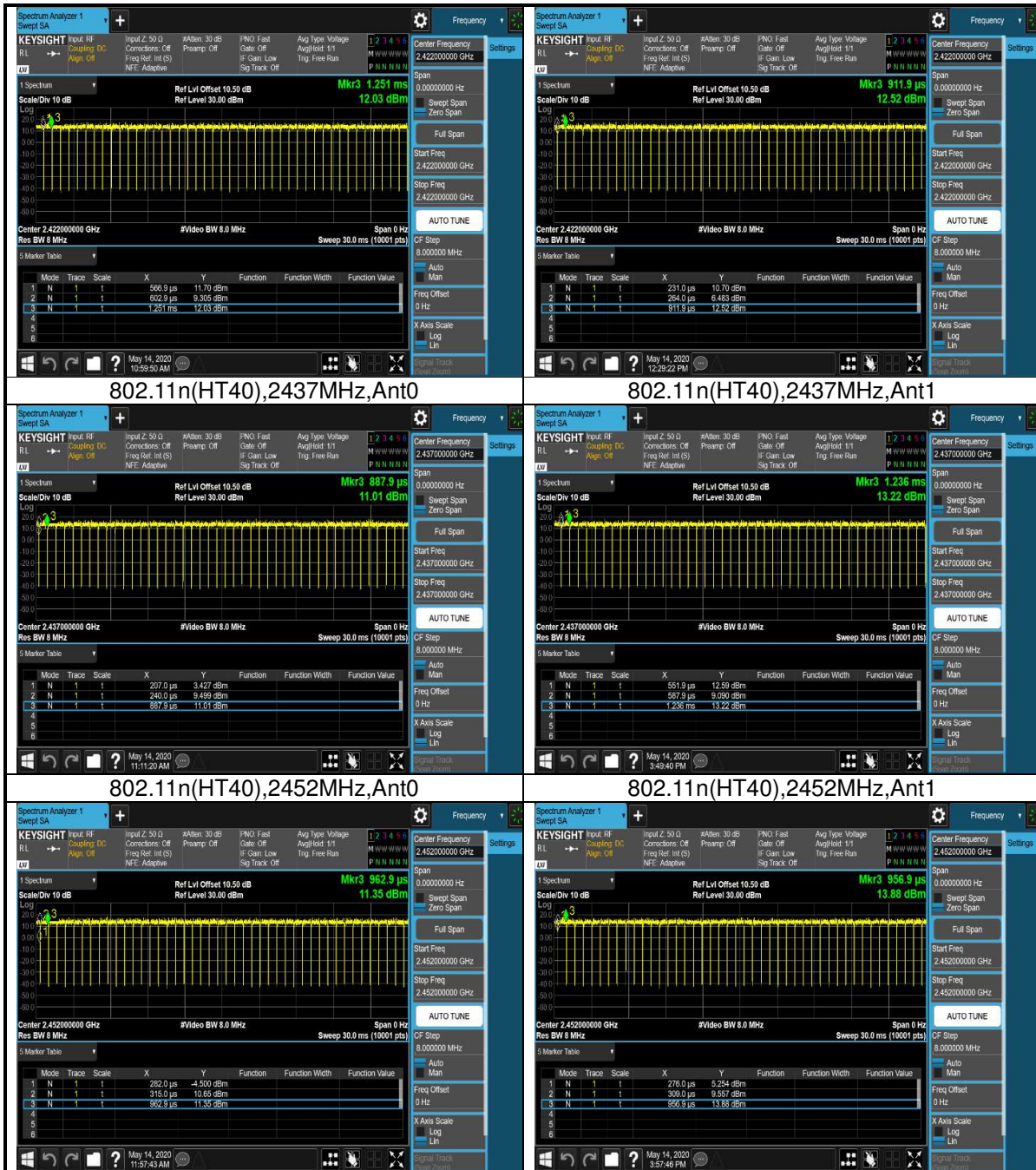

**TEST REPORT**

2. Minimum 6dB bandwidth

2.1 Test Data

WLAN Occupied 6dB Bandwidth				
Mode	Test Frequency (MHz)	Ant	Occupied Bandwidth (MHz)	Result
802.11b	2412	Ant0	9.58	Pass
802.11b	2412	Ant1	8.60	Pass
802.11b	2437	Ant0	8.12	Pass
802.11b	2437	Ant1	9.04	Pass
802.11b	2462	Ant0	9.10	Pass
802.11b	2462	Ant1	9.11	Pass
802.11g	2412	Ant0	15.16	Pass
802.11g	2412	Ant1	15.16	Pass
802.11g	2437	Ant0	15.16	Pass
802.11g	2437	Ant1	15.16	Pass
802.11g	2462	Ant0	15.15	Pass
802.11g	2462	Ant1	15.16	Pass
802.11n (HT20)	2412	Ant0	15.16	Pass
802.11n (HT20)	2412	Ant1	15.15	Pass
802.11n (HT20)	2437	Ant0	15.16	Pass
802.11n (HT20)	2437	Ant1	15.16	Pass
802.11n (HT20)	2462	Ant0	15.15	Pass
802.11n (HT20)	2462	Ant1	15.16	Pass
802.11n (HT40)	2422	Ant0	35.19	Pass
802.11n (HT40)	2422	Ant1	35.19	Pass
802.11n (HT40)	2437	Ant0	35.19	Pass
802.11n (HT40)	2437	Ant1	35.20	Pass
802.11n (HT40)	2452	Ant0	35.19	Pass
802.11n (HT40)	2452	Ant1	35.20	Pass



### 2.2 Test Plots

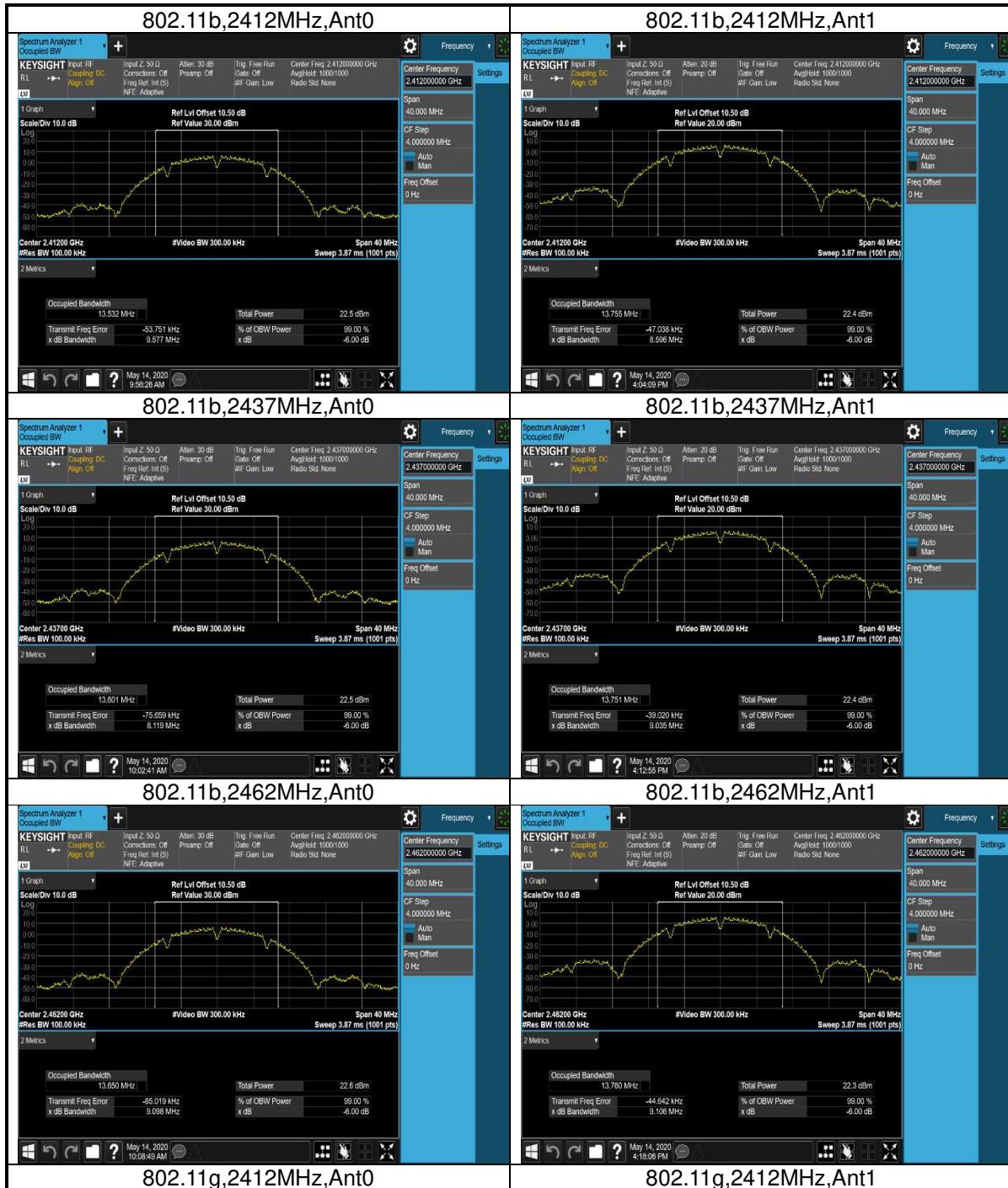

## TEST REPORT

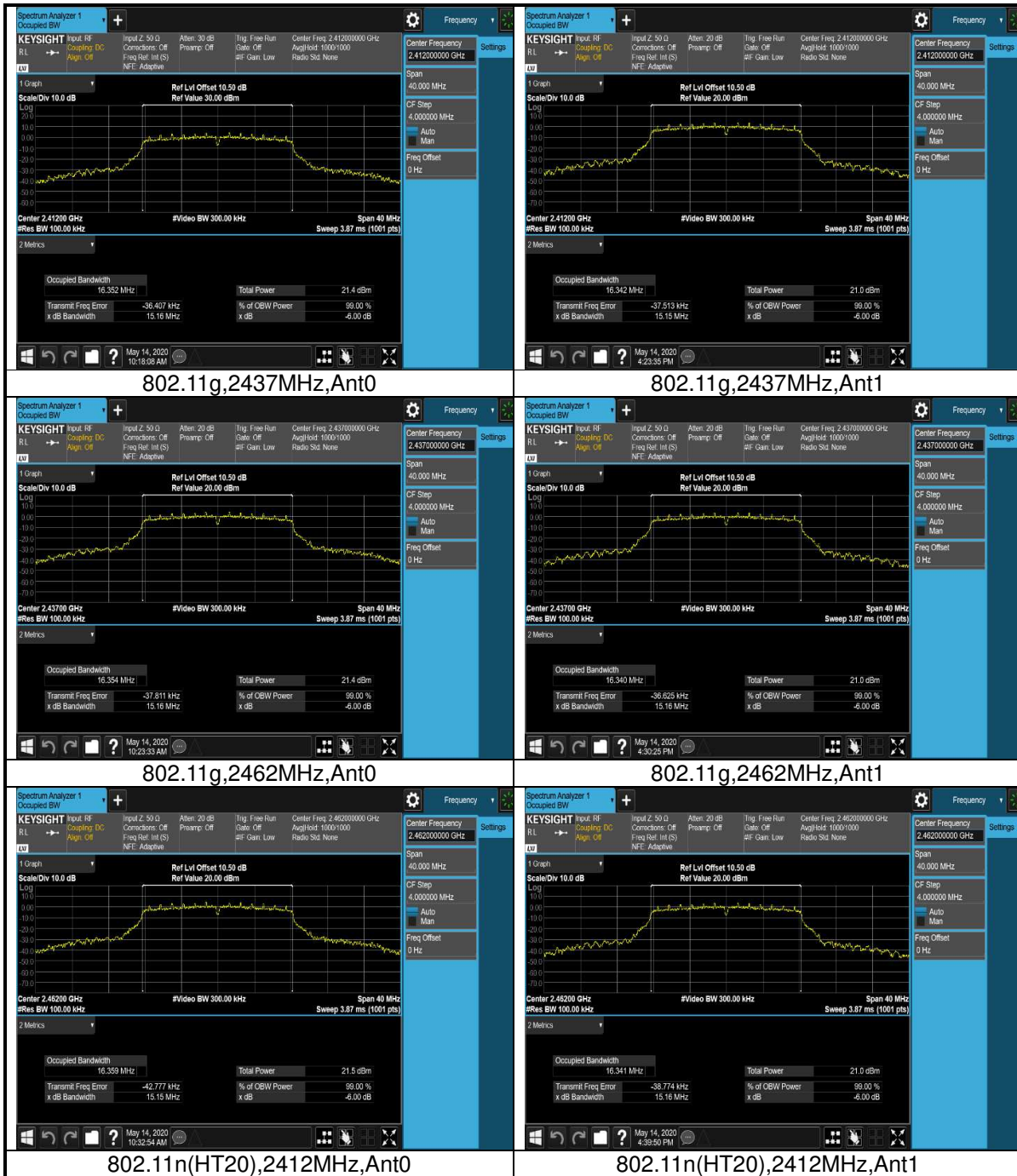

## TEST REPORT

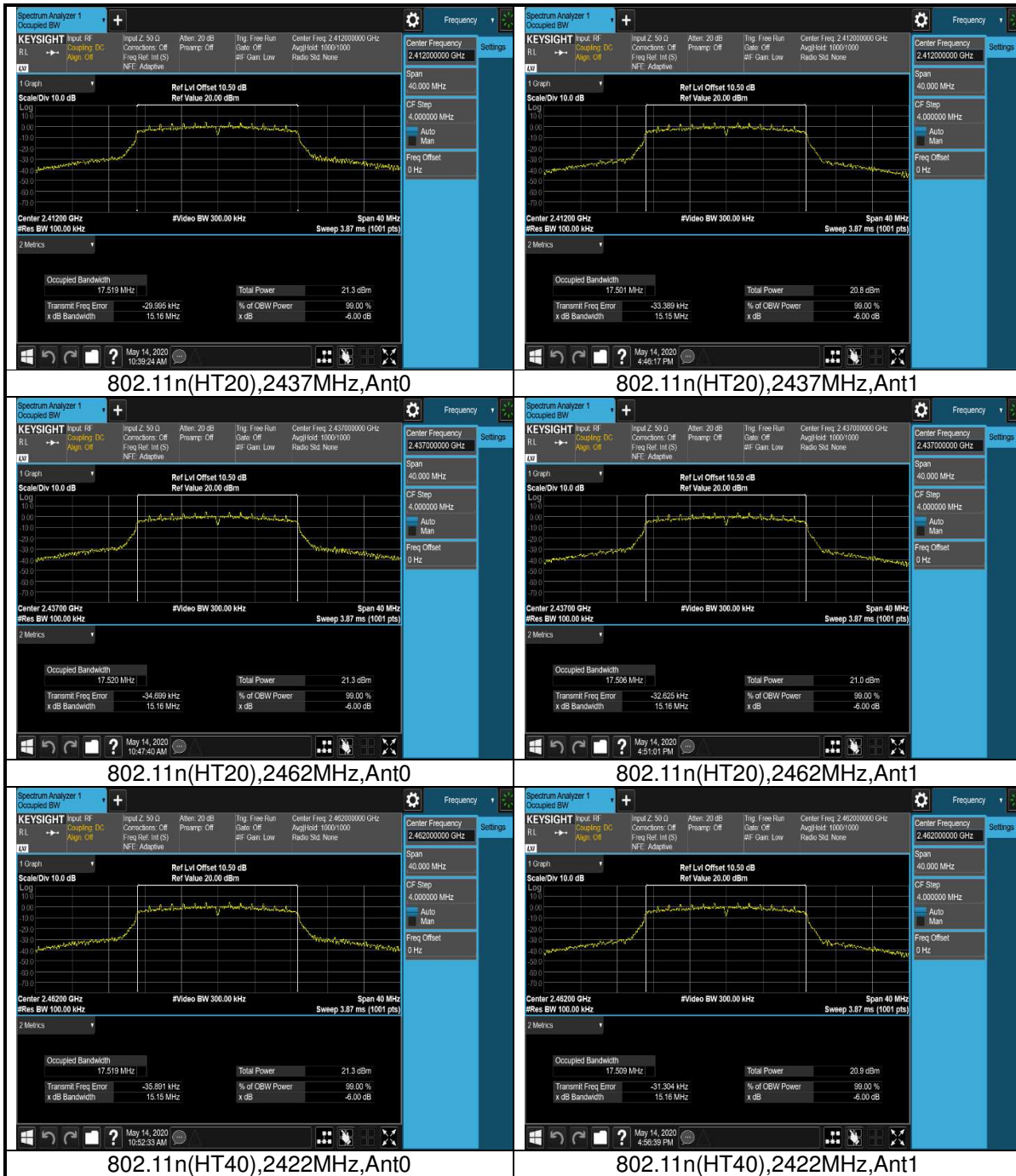

## TEST REPORT

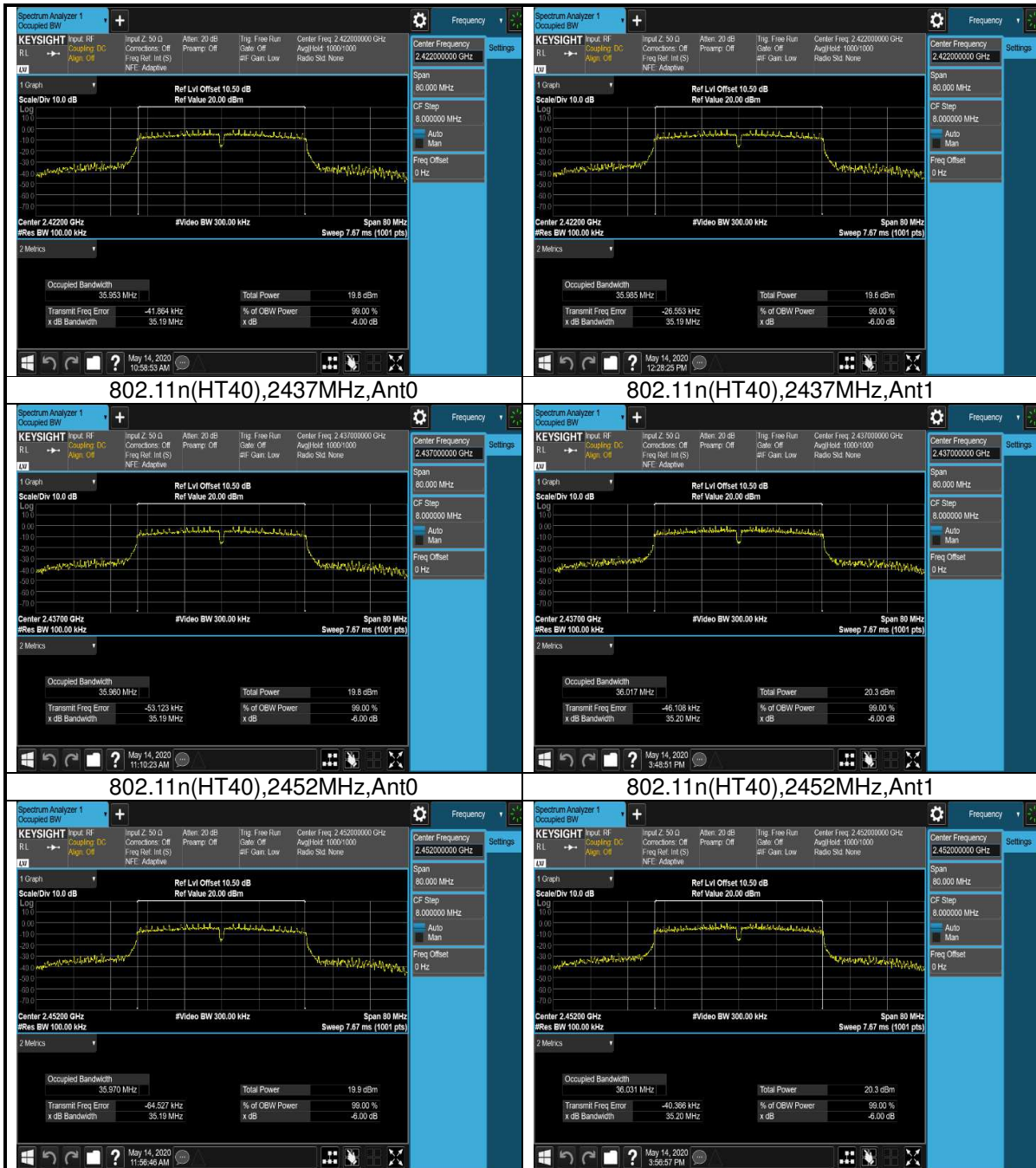

802.11n(HT40),2437MHz,Ant0

802.11n(HT40),2437MHz,Ant1

802.11n(HT40),2452MHz,Ant0

802.11n(HT40),2452MHz,Ant1

**TEST REPORT**

3. Occupied Bandwidth

3.1 Test Data

WLAN 99% Occupied Bandwidth				
Mode	Test Frequency (MHz)	Ant	99% Occupied Bandwidth (MHz)	Result
802.11b	2412	Ant0	13.539	Pass
802.11b	2412	Ant1	13.791	Pass
802.11b	2437	Ant0	13.600	Pass
802.11b	2437	Ant1	13.802	Pass
802.11b	2462	Ant0	13.666	Pass
802.11b	2462	Ant1	13.786	Pass
802.11g	2412	Ant0	16.794	Pass
802.11g	2412	Ant1	16.776	Pass
802.11g	2437	Ant0	16.817	Pass
802.11g	2437	Ant1	16.781	Pass
802.11g	2462	Ant0	16.816	Pass
802.11g	2462	Ant1	16.761	Pass
802.11n (HT20)	2412	Ant0	17.741	Pass
802.11n (HT20)	2412	Ant1	17.691	Pass
802.11n (HT20)	2437	Ant0	17.721	Pass
802.11n (HT20)	2437	Ant1	17.694	Pass
802.11n (HT20)	2462	Ant0	17.738	Pass
802.11n (HT20)	2462	Ant1	17.699	Pass
802.11n (HT40)	2422	Ant0	36.550	Pass
802.11n (HT40)	2422	Ant1	36.626	Pass
802.11n (HT40)	2437	Ant0	36.596	Pass
802.11n (HT40)	2437	Ant1	36.799	Pass
802.11n (HT40)	2452	Ant0	36.584	Pass
802.11n (HT40)	2452	Ant1	36.847	Pass