

SP5014, CBP4105

ANDROID Smart Phone

QUICK-START USER GUIDE ANDROID 6.0

# PRECAUTIONS

## **On the Road**

Using a device while driving is illegal in many countries. Please refrain from using your mobile while driving.

## **Near Sensitive Electronics or Medical Equipment**

Don't use your device near sensitive electronic equipment – particularly medical devices such as pacemakers – as it could cause them to malfunction. It can also interfere with the operation of fire detectors and other automatic-control equipment.

## **While Flying**

Your device can cause interference with aircraft equipment. So it's essential you follow airline regulations. And if airline personnel ask you to switch off your device, or disable its wireless functions, please do as they say.

## **At a Petrol Station**

Don't use your device at petrol stations. In fact, it's always best to switch off whenever you're near fuels, chemicals or explosives.

## **Making Repairs**

Never take your device apart. Please leave that to the professionals. Unauthorised repairs could break the terms of your warranty. Don't use your device if the antenna is damaged, as it could cause injury.

## **Around Children**

Keep your mobile out of children's reach. It should never be used as a toy as this is hazardous.

## **Near Explosives**

Turn off your device in or near areas where explosive materials are used. Always obey local laws and turn off your device when requested.

## **Emergency Calls**

To make an emergency call your device must be turned on and in an area where there's network coverage. Dial the national emergency number and press "Send". Explain exactly where you are and don't hang up until help has arrived.

## **Working Temperature**

The working temperature for the device is between 0 and 40 degree Celsius. Please don't use the device outside the range. Using the device under too high or too low temperature might cause problems.

At very high volume, prolonged listening to a mobile device can damage your hearing.

# 1. PARTS AND BUTTONS OF THE DEVICE



- 1 .Front camera
2. Speaker
3. Touchscreen
4. Volume button
5. Power button
6. Menu button
7. Home button
8. Back button
9. Micro USB and charging port
10. Earphone jack
11. Rear camera
12. Flash
13. Speaker
14. Microphone

## 2. TOUCH BUTTONS

The  button moves back one step to the previous menu/page.

The  button returns immediately to the main screen.

The  button displays a menu of recently opened applications.

The  button will launch the applications and settings menu.

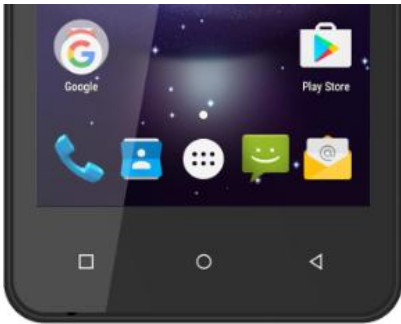

## 3. GETTING STARTED

### Installing the micro-SIM Card and Battery

Switch off your phone before installing or replacing the battery or the micro-SIM card.

Insert your fingernail into the slot at the bottom left of the back cover, and slide fingernail across bottom of back cover to lift it off.

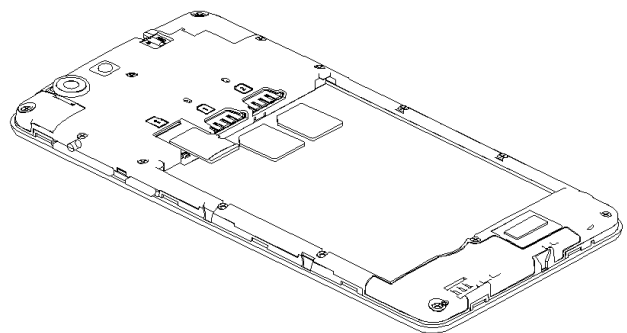
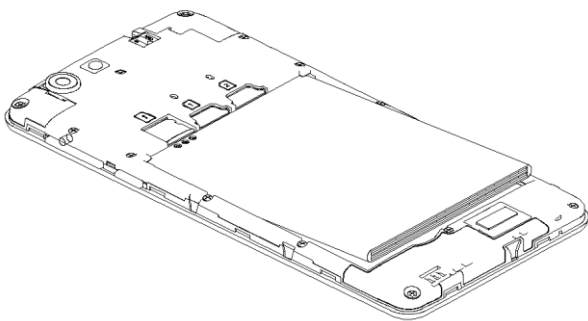

## WARNING!

To avoid damage to the phone, do not use any other kind of SIM card, or any non-standard micro-SIM card cut from a SIM card. You can get a standard micro-SIM card from your service provider.

Insert the battery by aligning the metal contacts on the battery with the metal contacts in the battery compartment. Gently push down on the battery until it clicks into place.

Align the back cover with the back of the phone and press the cover back into place. Ensure that all the tabs are secure and there are no gaps around the cover.

## 4. HOME SCREEN

The home screen will look similar to the picture below. To switch between screens, simply slide your finger left or right across the display.



The home screen contains shortcuts to your most-used applications and widgets. The status bar displays system information, such as current time, wireless connectivity and battery charge status.

# 5. QUICK NOTIFICATION PANEL

When you receive a notification you can quickly view it by following the below instructions. Slide your finger from the top of the screen down to the center to access Notification Panel to see your notifications.



Drag the notification menu down to display the second fast access menu, the menu will look similar to the below image.

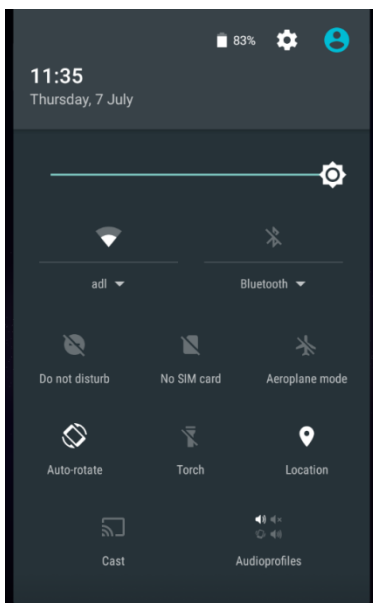

Through this menu, it is possible to modify the functions such as brightness, auto rotation, Wi-Fi, Bluetooth and more.

## 6. SETTINGS MENU

The settings menu allows you to adjust Tablet cellphone System Configuration.

### To Change Settings:

1. Touch the “Settings”  menu icon on the Application menu. The Settings menu will open.

2. Touch a category title to view further options on the right side of the screen.

- Wi-Fi – Connect to/disconnect from wireless networks, view connection status
- Data usage – Enable/disable mobile data, view current usage, set mobile data limit **(note: this function is available only on devices supplied with 3G card functionality)**
- Bluetooth – Connect or disconnect Bluetooth devices
- Display – Adjust display settings
- Smart Gesture settings – “ON” / “OFF”
- Audio Profiles – Adjust the different audio settings such as ringtones
- Prompts and notifications – Adjust different notification settings
- Storage – View your phone’s internal and external storage settings
- Battery – View the status of your battery and make adjustments to power consumption
- Apps – A list of all apps downloaded and running
- Delete applications – Select apps to delete
- Location services – Change approximate location detection, improve search results, GPS satellites
- Security – Adjust phone’s security settings
- Accounts – Add or remove email and Google accounts such as Gmail, Google
- Language and input Select language – add to the dictionary, edit on-screen keyboard settings, vocal search, etc.
- Backup and reset – Backup and restore data, perform factory reset, etc.
- Date and time – Set date, time zone, time, clock format etc.
- Accessibility – Set up large text, auto-rotate screen, speak password etc.

- About Phone – Displays information about your phone

## 7. INSERTING/REMOVING SIM CARDS

1. When phone is powered off insert a SIM card by removing the SIM cover as illustrated above, insert your finger in the indent located near the charging port and unclip the SIM cover, then insert the SIM card. Please take note of the direction of insertion following the diagram on the phone's SIM port.
2. After inserting a SIM card, turn on the phone and wait a few minutes for your phone to display Network information.

### Inserting and Removing TF Card

NB: Please ensure when inserting an SD card your phone is powered "OFF"

1. Insert the TF card into the TF card slot located under the SIM card cover as explained in the Inserting/Removing SIM card section. Gently push TF card into slot until it clicks into place.
2. A prompt will be seen on the screen saying "Preparing SD card".

### Removing TF Card

1. Close all applications and documents which have been opened from the TF card.
2. Select "Settings" and find "Storage" then click "Unmount SD card".
3. A prompt will be seen on the screen saying "SD card safe to remove".
4. Gently press the TF card to remove and pull out the TF card.

## 8. MAKING AND RECEIVING CALLS

Once your SIM cards are installed turn on your phone and wait a few minutes for your phone to find a network.

Then select the Call  icon. Here you can dial a number or select a contact from your stored contacts list to call. You can also view outgoing and incoming calls that have been made, as well as adding or removing contacts.



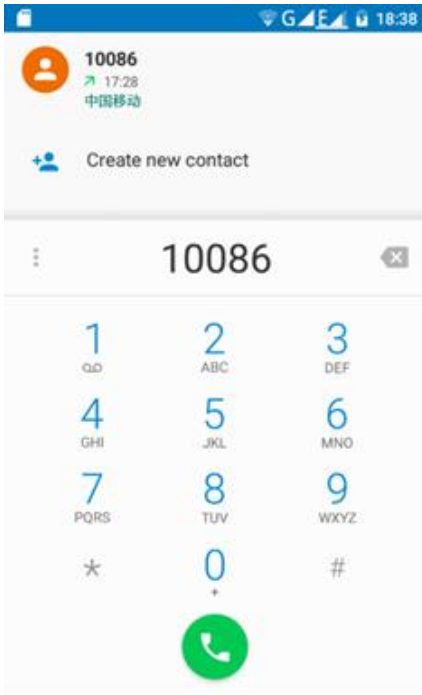

## 9. ANSWERING AND REJECTING CALLS

To answer a call – Slide your finger to the blue Call Answer key.

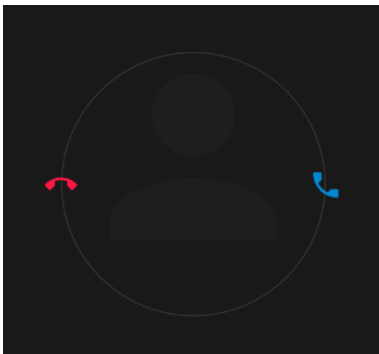

To reject a Call – Slide your finger to the Red Call End key.

## 10. SOFTWARE KEYBOARD

The phone has a software keyboard which automatically displays when you tap the place on screen where you want text or numbers to be entered, then simply start typing.

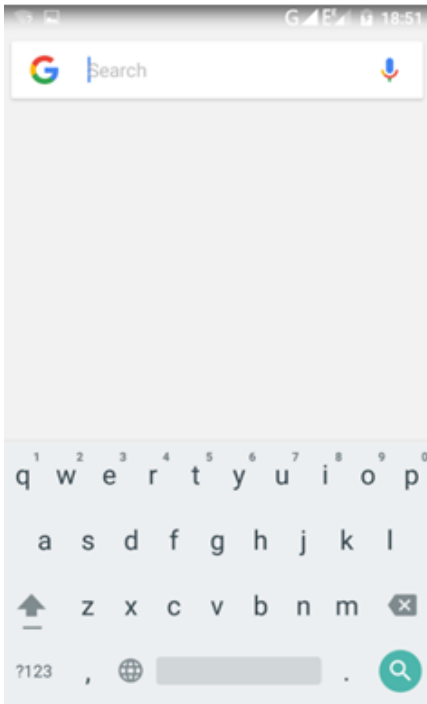

## Touchscreen

The touchscreen responds to finger touch.

### **Note:**

• Don't place any object on the touchscreen for it may damage or crush the screen.

**Single Click:** Single click one icon to choose the icon or option you want.

**Long Press:** Press and hold an icon to delete or move an icon or app.

**Drag:** Press the icon and drag it to a different screen.

# 11. HOW TO CONNECT TO A COMPUTER

### **Note:**

• Turn on your phone before connecting the phone to a PC by USB cable.

1. Use a USB cable to connect the phone with a computer. The phone will automatically detect a USB connection.

2. A notification will pop up on the screen displaying USB connected, select the desired USB operation.
3. The USB connection has been successful.

## 12. CONNECTION TO INTERNET

Wireless:

1. Select “Settings”.
2. Select “Wi-Fi” and slide OFF to ON status.
3. All detected wireless networks in the area will be listed. Click to select desired wireless connection.
4. Enter network key if necessary.
5. Once connected to a wireless network, settings will be saved.
6. Wireless icon will appear on the taskbar when connected successfully.

Note:

- When the phone detects the same wireless network in the future, the device will connect to the network automatically with the same password record.

## 13. MOBILE DATA AND INTERNET

**Please Note:** Cell Data may be turned “OFF” as a factory setting, to allow data to flow through your network provider please turn Cell Data “ON” either from your quick drop down menu or in > Settings > Cell Data, you will not be able to access the Internet when Cell Data is “OFF” and not connected to Wi-Fi.

**NB:** Mobile Data charges apply when this setting is “ON” – Data will be passed through your network provider.

## Web Browsing

Connect to the Internet and launch the browser.

Type in the desired browsing URL.



## 14. BLUETOOTH

Select “Settings”, select Bluetooth from “OFF” to “ON”.

Search for the device you would like to pair with and select “PAIR”.

You will see a message “Connected Successfully”.

## 15. CAMERA





Touch the icon

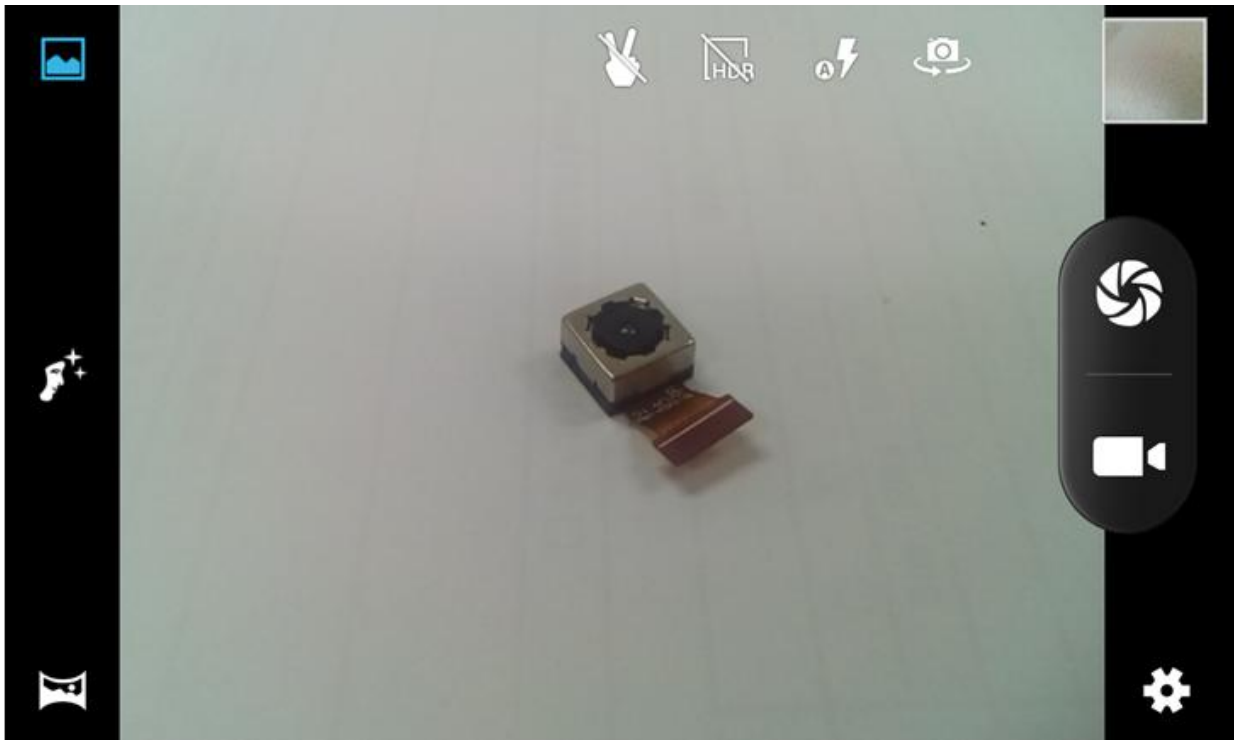

to enter camera mode and the interface is shown as

follows:



1. Touch the icon  to take a photo.
2. Touch the icon  to start camera recording.
3. Touch the icon  on the top right to see the previous picture and to delete, share or set it as a wallpaper. Click the return button to exit camera interface.
4. Touch the icon  to switch from front to back camera.

## 16.TROUBLE SHOOTING

### How to Close Applications

When an application is not responding you can manually shut the app down in “**Running Services**” menu. This will ensure the system responds as desired. Please shut down all **idle applications** to release memory and get the system speed back to

normal. To close the application, click the icon  on the shortcut bar to enter the system configuration interface. Select the **Application** → **Running** and the interface is

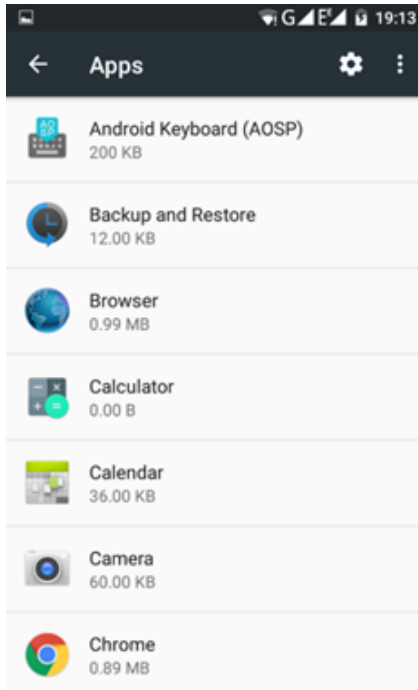

Tap the application you want to close. A pop-up window will be displayed. Tap “Stop” to close that application.

### **Power “OFF” / Restart / Reset the Phone**

1. Press and hold the power button for 5 seconds and the device will be powered down.
2. Press the reset button located under the power button with a sharp object and the device will be forced to restart.

### **Restore Default Setting**

If you want to reset the phone to factory settings and erase all materials, please press **Settings** → **Backup and reset** → **Factory data reset**.

### **WARNING:**

actory Data Reset setting will delete ALL your data and system configuration as well as any downloaded apps. Please use this function carefully.

## **Emergency call**

If any emergency arises, dial 112/911 (or other emergency call number) for emergency help.

Note:

Due to the nature of cellular networking, the success of emergency call is not guaranteed.

## **FCC Warning:**

This device complies with part 15 of the FCC Rules. Operation is subject to the following two conditions: (1) This device may not cause harmful interference, and (2) this device must accept any interference received, including interference that may cause undesired operation.

Any Changes or modifications not expressly approved by the party responsible for compliance could void the user's authority to operate the equipment.

This equipment has been tested and found to comply with the limits for a Class B digital device, pursuant to part 15 of the FCC Rules. These limits are designed to provide reasonable protection against harmful interference in a residential installation. This equipment generates uses and can radiate radio frequency energy and, if not installed and used in accordance with the instructions, may cause harmful interference to radio communications. However, there is no guarantee that interference will not occur in a particular installation. If this equipment does cause harmful interference to radio or television reception, which can be determined by turning the equipment off and on, the user is encouraged to try to correct the interference by one or more of the following measures:

- Reorient or relocate the receiving antenna.

- Increase the separation between the equipment and receiver.
- Connect the equipment into an outlet on a circuit different from that to which the receiver is connected.
- Consult the dealer or an experienced radio/TV technician for help.

The SAR limit of USA (FCC) is 1.6 W/kg averaged over one gram of tissue. Device types SP5014, CBP4105 (FCC ID: 2AJVK-SP5014) has also been tested against this SAR limit. The highest reported SAR values for head, body-worn accessory are 0.60 W/kg, 0.77 W/kg respectively. The Max simultaneous SAR is 0.97W/kg. This device was tested for typical body-worn operations with the back of the handset kept 10mm from the body. To maintain compliance with FCC RF exposure requirements, use accessories that maintain a 10mm separation distance between the user's body and the back of the handset. The use of belt clips, holsters and similar accessories should not contain metallic components in its assembly. The use of accessories that do not satisfy these requirements may not comply with FCC RF exposure requirements, and should be avoided.

The antenna(s) used for this transmitter must not be co-located or operating in conjunction with any other antenna or transmitter.