

FCC

RF

TEST REPORT

ISSUED BY
Shenzhen BALUN Technology Co., Ltd.



FOR

LoRaWAN communication node

ISSUED TO

Ruixing Hengfang Network (Shenzhen) CO., LTD.

Room 601, Building 10, Software Park, Keji Mid 2nd Road NanShan District, Shenzhen, 518057 China

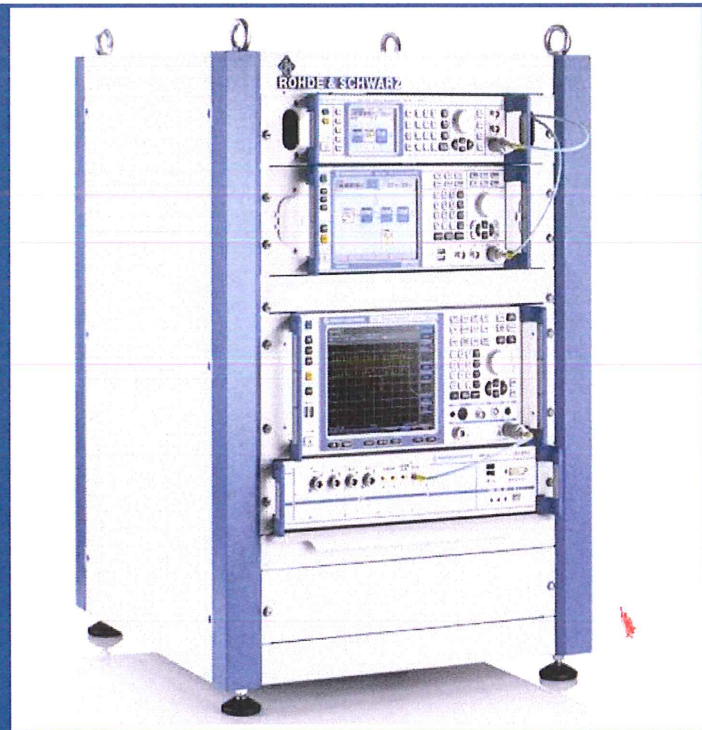

Tested by: Ye Hongji
Ye Hongji
Date Nov. 25, 2020

Approved by: [Signature]
Wei Yanguan
(Chief Engineer)
Date Nov. 25, 2020



Report No.: BL-SZ2080372-601
EUT Name: LoRaWAN communication node
Model Name: RHF0M0E5-HF22
Brand Name: RisingHF
Test Standard: 47 CFR Part 15 Subpart C
FCC ID: 2AJUZ0M0E5

Test Conclusion: Pass
Test Date: Aug. 17, 2020 ~ Nov. 25, 2020
Date of Issue: Nov. 25, 2020

NOTE: This test report of test results only related to testing samples, which can be duplicated completely for the legal use with the approval of the applicant; it shall not be reproduced except in full, without the written approval of Shenzhen BALUN Technology Co., Ltd. Any objections should be raised within thirty days from the date of issue. To validate the report, please contact us.

Revision History

<u>Version</u>	<u>Issue Date</u>	<u>Revisions Content</u>
<u>Rev. 01</u>	<u>Nov. 16, 2020</u>	<u>Initial Issue</u>
<u>Rev. 02</u>	<u>Nov. 25, 2020</u>	<u>Updated delete the hybrid modulation technology and the corresponding data</u>

TABLE OF CONTENTS

1	ADMINISTRATIVE DATA (GENERAL INFORMATION)	5
1.1	Identification of the Testing Laboratory	5
1.2	Identification of the Responsible Testing Location	5
1.3	Laboratory Condition	5
1.4	Announce	6
2	PRODUCT INFORMATION	7
2.1	Applicant Information	7
2.2	Manufacturer Information	7
2.3	Factory Information	7
2.4	General Description for Equipment under Test (EUT)	7
2.5	Technical Information	8
2.6	Additional Instructions	9
3	SUMMARY OF TEST RESULTS	10
3.1	Test Standards	10
3.2	Verdict	10
4	GENERAL TEST CONFIGURATIONS	11
4.1	Test Environments	11
4.2	Test Equipment List	11
4.3	Measurement Uncertainty	12
4.4	Description of Test Setup	12
4.4.1	For Antenna Port Test	12
4.4.2	For AC Power Supply Port Test	13
4.4.3	For Radiated Test (Below 30 MHz)	13
4.4.4	For Radiated Test (30 MHz-1 GHz)	14

4.4.5	For Radiated Test (Above 1 GHz).....	14
4.5	Measurement Results Explanation Example.....	15
4.5.1	For conducted test items:	15
4.5.2	For radiated band edges and spurious emission test:.....	15
5	TEST ITEMS.....	16
5.1	Antenna Requirements.....	16
5.1.1	Relevant Standards.....	16
5.1.2	Antenna Anti-Replacement Construction	16
5.1.3	Antenna Gain	16
5.2	Output Power	17
5.2.1	Test Limit.....	17
5.2.2	Test Setup	17
5.2.3	Test Procedure	17
5.2.4	Test Result	18
5.3	Occupied Bandwidth	19
5.3.1	Limit.....	19
5.3.2	Test Setup	19
5.3.3	Test Procedure	19
5.3.4	Test Result	19
5.4	Conducted Spurious Emission	20
5.4.1	Limit.....	20
5.4.2	Test Setup	20
5.4.3	Test Procedure	20
5.4.4	Test Result	21
5.5	Band Edge (Authorized-band band-edge).....	22
5.5.1	Limit.....	22
5.5.2	Test Setup	22
5.5.3	Test Procedure	22
5.5.4	Test Result	22
5.6	Conducted Emission	23
5.6.1	Limit.....	23

5.6.2	Test Setup	23
5.6.3	Test Procedure	23
5.6.4	Test Result	23
5.7	Radiated Spurious Emission	24
5.7.1	Limit.....	24
5.7.2	Test Setup	24
5.7.3	Test Procedure	24
5.7.4	Test Result	25
5.8	Band Edge (Restricted-band band-edge).....	26
5.8.1	Limit.....	26
5.8.2	Test Setup	26
5.8.3	Test Procedure	26
1.1.1	Test Result	26
5.9	Power Spectral density (PSD).....	27
5.9.1	Limit.....	27
5.9.2	Test Setup	27
5.9.3	Test Procedure	27
5.9.4	Test Result	27
ANNEX A	TEST RESULT	28
A.1	Output Power	28
A.2	Occupied Bandwidth	29
A.3	Conducted Spurious Emissions	31
A.4	Band Edge (Authorized-band band-edge).....	34
A.5	Conducted Emissions.....	35
A.6	Radiated Spurious Emission	37
A.7	Band Edge (Restricted-band band-edge).....	55
A.8	Power Spectral Density (PSD)	57
ANNEX B	TEST SETUP PHOTOS	58
ANNEX C	EUT EXTERNAL PHOTOS	58
ANNEX D	EUT INTERNAL PHOTOS	58

1 ADMINISTRATIVE DATA (GENERAL INFORMATION)

1.1 Identification of the Testing Laboratory

Company Name	Shenzhen BALUN Technology Co., Ltd.
Address	Block B, 1st FL, Baisha Science and Technology Park, Shahe Xi Road, Nanshan District, Shenzhen, Guangdong Province, P. R. China
Phone Number	+86 755 6685 0100

1.2 Identification of the Responsible Testing Location

Test Location	Shenzhen BALUN Technology Co., Ltd.
Address	Block B, 1st FL, Baisha Science and Technology Park, Shahe Xi Road, Nanshan District, Shenzhen, Guangdong Province, P. R. China
Accreditation Certificate	<p>The laboratory has been listed by Industry Canada to perform electromagnetic emission measurements. The recognition numbers of test site are 11524A-1.</p> <p>The laboratory is a testing organization accredited by FCC as a accredited testing laboratory. The designation number is CN1196.</p> <p>The laboratory is a testing organization accredited by American Association for Laboratory Accreditation(A2LA) according to ISO/IEC 17025.The accreditation certificate is 4344.01.</p> <p>The laboratory is a testing organization accredited by China National Accreditation Service for Conformity Assessment (CNAS) according to ISO/IEC 17025. The accreditation certificate number is L6791.</p>
Description	All measurement facilities used to collect the measurement data are located at Block B, FL 1, Baisha Science and Technology Park, Shahe Xi Road, Nanshan District, Shenzhen, Guangdong Province, P. R. China 518055

1.3 Laboratory Condition

Ambient Temperature	20°C to 25°C
Ambient Relative Humidity	45% to 55%
Ambient Pressure	100 kPa to 102 kPa

1.4 Announce

- (1) The test report reference to the report template version v2.3.
- (2) The test report is invalid if not marked with the signatures of the persons responsible for preparing and approving the test report.
- (3) The test report is invalid if there is any evidence and/or falsification.
- (4) The results documented in this report apply only to the tested sample, under the conditions and modes of operation as described herein.
- (5) This document may not be altered or revised in any way unless done so by BALUN and all revisions are duly noted in the revisions section.
- (6) Content of the test report, in part or in full, cannot be used for publicity and/or promotional purposes without prior written approval from the laboratory.
- (7) The laboratory is only responsible for the data released by the laboratory, except for the part provided by the applicant.

2 PRODUCT INFORMATION

2.1 Applicant Information

Applicant	Ruixing Hengfang Network (Shenzhen) CO., LTD.
Address	Room 601, Building 10, Software Park, Keji Mid 2nd Road NanShan District, Shenzhen, 518057 China

2.2 Manufacturer Information

Manufacturer	Ruixing Hengfang Network (Shenzhen) CO., LTD.
Address	Room 601, Building 10, Software Park, Keji Mid 2nd Road NanShan District, Shenzhen, 518057 China

2.3 Factory Information

Factory	N/A
Address	N/A

2.4 General Description for Equipment under Test (EUT)

EUT Name	LoRaWAN communication node
Model Name Under Test	RHF0M0E5-HF22
Series Model Name	N/A
Description of Model name differentiation	N/A
Hardware Version	RHF0M0E5V2.0
Software Version	4.0.10
Dimensions (Approx.)	N/A
Weight (Approx.)	N/A

2.5 Technical Information

Network and Wireless connectivity	LoRa
-----------------------------------	------

The requirement for the following technical information of the EUT was tested in this report:

Modulation Technology	DTS
Modulation Type	LoRa
Product Type	<input checked="" type="checkbox"/> Mobile <input type="checkbox"/> Portable <input type="checkbox"/> Fix Location
Frequency Range	The frequency range used is 902 MHz to 928 MHz.
Number of channel	8
Tested Channel	0 (903.0 MHz), 3 (907.8 MHz), 7 (914.2 MHz)
Antenna Type	Dipole Antenna
Antenna Gain	2 dBi (In test items related to antenna gain, the final results reflect this figure. This value is provided by the applicant.)
Antenna System(MIMO Smart Antenna)	N/A

All channel was listed on the following table:

Channel number	Freq. (MHz)	Channel number	Freq. (MHz)	Channel number	Freq. (MHz)	Channel number	Freq. (MHz)
0	903.0	2	906.2	4	909.4	6	912.6
1	904.6	3	907.8	5	911.0	7	914.2

2.6 Additional Instructions

EUT Software Settings:

Mode	<input checked="" type="checkbox"/> Special software is used. The software provided by client to enable the EUT under transmission condition continuously at specific channel frequencies individually.
------	--

During testing, Channel and Power Controlling Software provided by the customer was used to control the operating channel as well as the output power level. The RF output power selection is for the setting of RF output power expected by the customer and is going to be fixed on the firmware of the final end product.

Power level setup in software			
Test Software Version	SSCOM V5.12.2		
Support Units (Software installation media)	Description	Manufacturer	Model
	Notebook	Lenovo	X220
Mode	Channel		Soft Set
LoRa	ALL		17

Run Software

The screenshot shows the SSCOM V5.12.2 software interface. The main window displays a log of serial communication between a host and a device. The log shows AT commands being sent and received, such as AT+TEST=TXCLORA, AT+MODE=TEST, and AT+RFCFG,903,SF12,500,12,15,17,ON,OFF,OFF. The communication is successful, as indicated by the '收' (received) status and the '+TEST:' responses.

On the right side, a '多条字符串发送' (Multiple String Sending) window is open. It allows for sending multiple strings of data. The first string is '13 00 FF 88' (hex) or 'output string' (string), with a delay of 1000ms. Other strings include '欢迎您使用SSCOM!' and 'AT+MODE=TEST'. The interface includes options for '拖动加宽' (drag to expand), '循环发送' (loop send), and '多条帮助' (multiple help).

At the bottom, the '端口号' (Port) is set to 'COM6 USB Serial Port'. The '波特率' (Baud rate) is set to 9600. The '发送文件' (Send file) button is visible, along with other settings like 'HEX显示' (HEX display) and '接收数据到文件' (Receive data to file).

3 SUMMARY OF TEST RESULTS

3.1 Test Standards

No.	Identity	Document Title
1	47 CFR Part 15, Subpart C	Miscellaneous Wireless Communications Services
2	KDB Publication 558074 D01v05r02	GUIDANCE FOR COMPLIANCE MEASUREMENTS ON DIGITAL TRANSMISSION SYSTEM, FREQUENCY HOPPING SPREAD SPECTRUM SYSTEM, AND HYBRID SYSTEM DEVICES OPERATING UNDER SECTION 15.247 OF THE FCC RULES
3	KDB Publication 662911 D01v02r01	Emissions Testing of Transmitters with Multiple Outputs in the Same Band (e.g., MIMO, Smart Antenna, etc)
4	ANSI C63.10-2013	American National Standard for Testing Unlicensed Wireless Devices

3.2 Verdict

No.	Description	FCC Part No.	Test Result	Verdict
1	Antenna Requirement	15.203	--	Pass ^{Note1}
2	Output Power	15.247(b)	ANNEX A.1	Pass
3	Occupied Bandwidth	15.247(a)	ANNEX A.2	Pass
4	Conducted Spurious Emission	15.247(d)	ANNEX A.3	Pass
5	Band Edge(Authorized-band band-edge)	15.247(d)	ANNEX A.4	Pass
6	Conducted Emission	15.207	ANNEX A.5	N/A ^{Note2}
7	Radiated Spurious Emission	15.209 15.247(d)	ANNEX A.6	Pass
8	Band Edge(Restricted-band band-edge)	15.209 15.247(d)	ANNEX A.7	Pass
9	Power spectral density (PSD)	15.247(e)	ANNEX A.8	Pass

Note¹: The EUT has a permanently and irreplaceable attached antenna, which complies with the requirement FCC 15.203.

Note²: The EUT is powered by battery, so the Conducted Emission test is not applicable.

4 GENERAL TEST CONFIGURATIONS

4.1 Test Environments

During the measurement, the normal environmental conditions were within the listed ranges:

Relative Humidity	45% to 55%	
Atmospheric Pressure	100 kPa to 102 kPa	
Temperature	NT (Normal Temperature)	+22°C to +25°C
Working Voltage of the EUT	NV (Normal Voltage)	3.3 V

4.2 Test Equipment List

Description	Manufacturer	Model	Serial No.	Cal. Date	Cal. Due
Spectrum Analyzer	ROHDE&SCHWARZ	FSV-30	103118	2020.06.08	2021.06.07
Switch Unit with OSP-B157	ROHDE&SCHWARZ	OSP120	101270	2020.06.08	2021.06.07
EMI Receiver	KEYSIGHT	N9038A	MY53220118	2020.06.09	2021.06.08
EMI Receiver	ROHDE&SCHWARZ	ESRP	101036	2020.06.09	2021.06.08
LISN	SCHWARZBECK	NSLK 8127	8127-687	2020.06.09	2021.06.08
Bluetooth Tester	ROHDE&SCHWARZ	CBT	101005	2020.06.08	2021.06.07
DC Power Supply	ROHDE&SCHWARZ	HMP2020	018141664	2020.06.08	2021.06.07
Power Splitter	KMW	DCPD-LDC	1305003215	--	--
Power Sensor	ROHDE&SCHWARZ	NRP-Z21	103971	2020.06.08	2021.06.07
Attenuator (20 dB)	KMW	ZA-S1-201	110617091	--	--
Attenuator (6 dB)	KMW	ZA-S1-61	1305003189	--	--
Temperature Chamber	AHK	SP20	1412	2020.06.10	2021.06.09
Test Antenna-Loop(9 kHz-30 MHz)	SCHWARZBECK	FMZB 1519	1519-037	2019.10.29	2021.10.28
Test Antenna-Bi-Log(30 MHz-3 GHz)	SCHWARZBECK	VULB 9163	9163-624	2019.07.02	2021.07.01
Test Antenna-Horn(1-18 GHz)	SCHWARZBECK	BBHA 9120D	9120D-1917	2019.07.02	2021.07.01
Test Antenna-Horn (18-40 GHz)	A-INFO	LB-180400KF	J211060273	2019.01.06	2021.01.05
Anechoic Chamber	RAINFORD	9m*6m*6m	N/A	2017.02.21	2022.02.20
Anechoic Chamber	EMC Electronic Co., Ltd	20.10*11.60*7.35m	N/A	2018.08.08	2021.08.07
Shielded Enclosure	ChangNing	CN-130701	130703	--	--
Signal Generator	ROHDE&SCHWARZ	SMB100A	177746	2020.06.08	2021.06.07
Power Amplifier	OPHIR RF	5225F	1037	2020.02.19	2021.02.18
Power Amplifier	OPHIR RF	5273F	1016	2020.02.19	2021.02.18
Directional Coupler	Werlantone	C5982-10	109275	N/A	N/A
Directional Coupler	Werlantone	CHP-273E	S00801z-01	N/A	N/A
Sound Level Meter	B&K	NL-20	00844023	2020.10.23	2021.10.22
Ear Simulator	B&K	4192-L-001	3038758	2020.02.19	2021.02.18

Description	Manufacturer	Model	Serial No.	Cal. Date	Cal. Due
Audio analyzer	B&K	UPL 16	100129	2020.02.28	2021.02.27

4.3 Measurement Uncertainty

The following measurement uncertainty levels have been estimated for tests performed on the EUT as specified in CISPR 16-4-2.

This uncertainty represents an expanded uncertainty expressed at approximately the 95% confidence level using a coverage factor of k=2.

Measurement	Value
Occupied Channel Bandwidth	±4%
RF output power, conducted	±1.4 dB
Power Spectral Density, conducted	±2.5 dB
Unwanted Emissions, conducted	±2.8 dB
All emissions, radiated	±5.4 dB
Temperature	±1°C
Humidity	±4%

4.4 Description of Test Setup

4.4.1 For Antenna Port Test

Conducted value (dBm) = Measurement value (dBm) + cable loss (dB)

For example: the measurement value is 10 dBm and the cable 0.5dBm used, then the final result of EUT:

Conducted value (dBm) = 10 dBm + 0.5 dB = 10.5 dBm

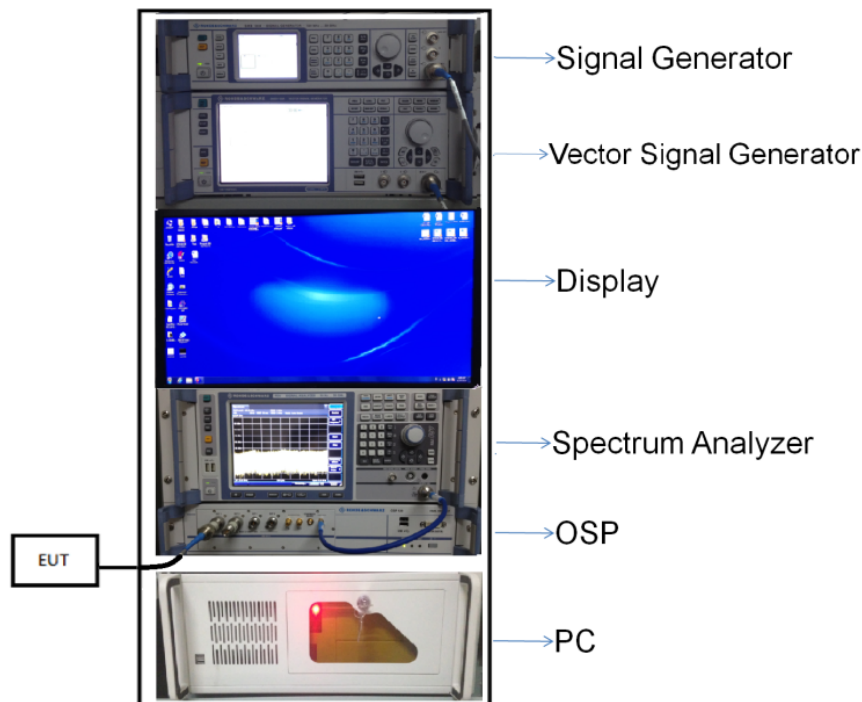

(Diagram 1)

4.4.2 For AC Power Supply Port Test

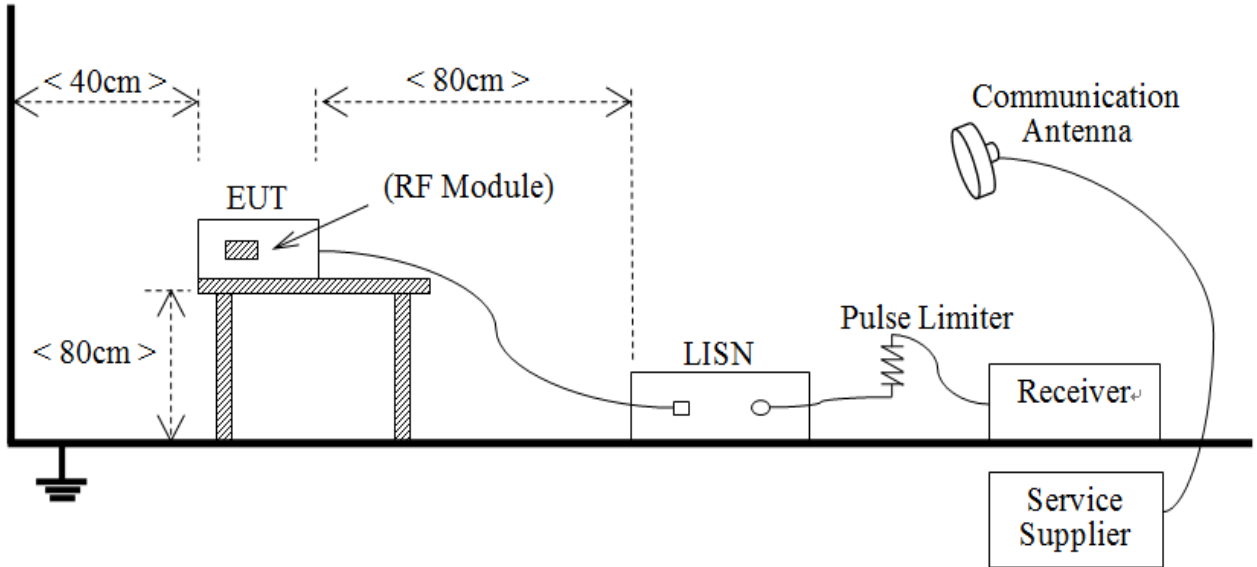

(Diagram 2)

4.4.3 For Radiated Test (Below 30 MHz)

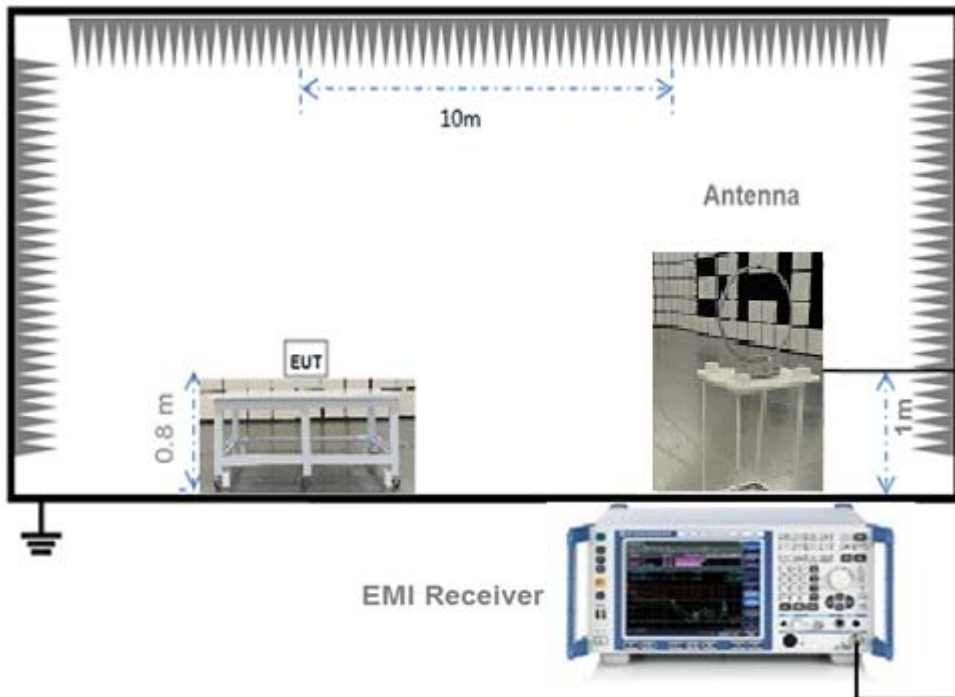

(Diagram 3)

4.4.4 For Radiated Test (30 MHz-1 GHz)

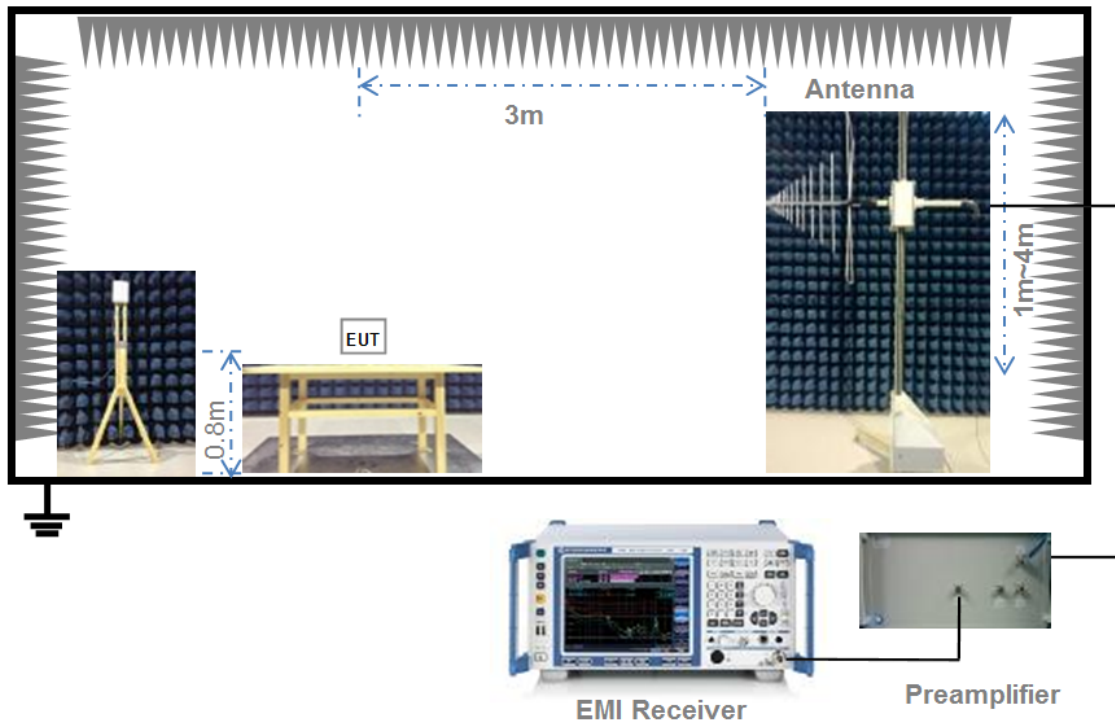

(Diagram 4)

4.4.5 For Radiated Test (Above 1 GHz)

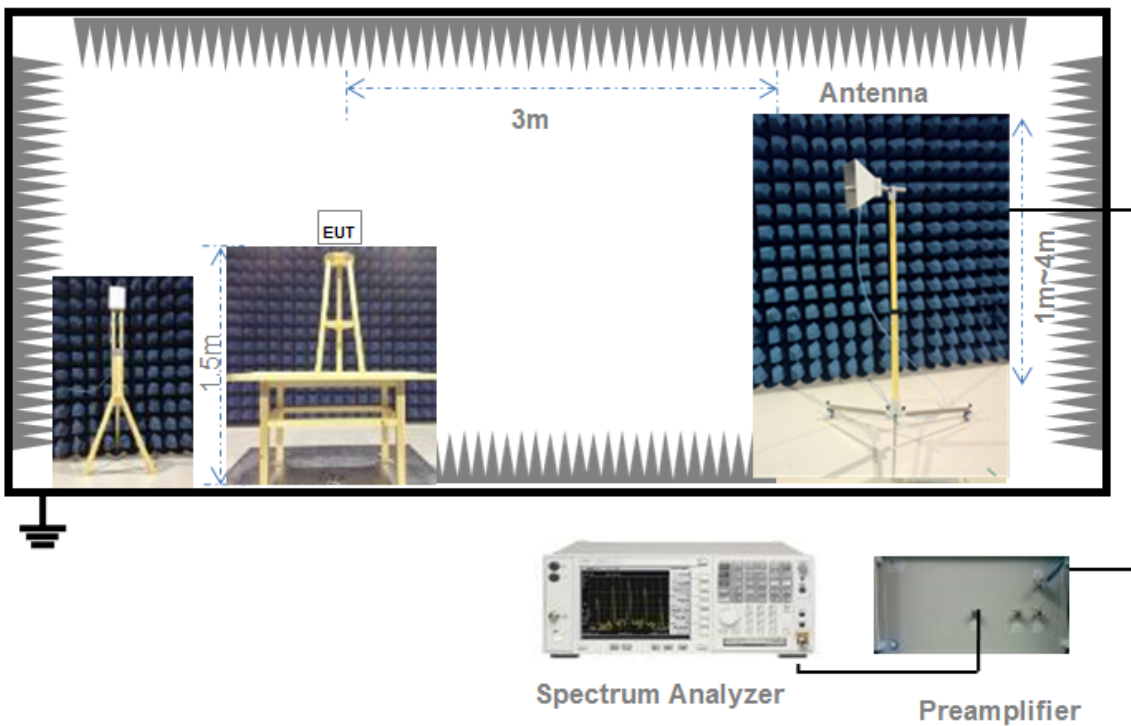

(Diagram 5)

4.5 Measurement Results Explanation Example

4.5.1 For conducted test items:

The offset level is set in the spectrum analyzer to compensate the RF cable loss and attenuator between EUT conducted output port and spectrum analyzer. With the offset compensation, the spectrum analyzer reading level is exactly the EUT RF output level.

The spectrum analyzer offset is derived from RF cable loss and attenuator factor.

Offset = RF cable loss + attenuator factor.

4.5.2 For radiated band edges and spurious emission test:

$$E = \text{EIRP} - 20\log D + 104.8$$

where:

E = electric field strength in dB μ V/m,

EIRP = equivalent isotropic radiated power in dBm

D = specified measurement distance in meters.

EIRP = Measure Conducted output power Value (dBm) + Maximum transmit antenna gain (dBi) + the appropriate maximum ground reflection factor (dB)

5 TEST ITEMS

5.1 Antenna Requirements

5.1.1 Relevant Standards

FCC §15.203 & 15.247(b); RSS-247, 5.4 (6)

An intentional radiator shall be designed to ensure that no antenna other than that furnished by the responsible party shall be used with the device. The use of a permanently attached antenna or of an antenna that uses a unique coupling to the intentional radiator shall be considered sufficient to comply with the provisions of this section. The manufacturer may design the unit so that a broken antenna can be replaced by the user, but the use of a standard antenna jack or electrical connector is prohibited. This requirement does not apply to carrier current devices or to devices operated under the provisions of § 15.211, § 15.213, § 15.217, § 15.219, or § 15.221. Further, this requirement does not apply to intentional radiators that must be professionally installed, such as perimeter protection systems and some field disturbance sensors, or to other intentional radiators which, in accordance with § 15.31(d), must be measured at the installation site. However, the installer shall be responsible for ensuring that the proper antenna is employed so that the limits in this part are not exceeded.

If directional gain of transmitting antennas is greater than 6 dBi, the power shall be reduced by the same level in dB comparing to gain minus 6 dBi. For the fixed point-to-point operation, the power shall be reduced by one dB for every 3 dB that the directional gain of the antenna exceeds 6 dBi. The use of a permanently attached antenna or of an antenna that uses a unique coupling to the intentional radiator shall be considered sufficient to comply with the FCC rule.

5.1.2 Antenna Anti-Replacement Construction

The Antenna Anti-Replacement as following method:

Protected Method	Description
The antenna is embedded in the product.	The antenna is welded on the mainboard, can't be replaced by the consumer

Reference Documents	Item
Photo	Please refer to the EUT Photo documents.

5.1.3 Antenna Gain

The antenna peak gain of EUT is less than 6 dBi. Therefore, it is not necessary to reduce maximum peak output power limit.

5.2 Output Power

5.2.1 Test Limit

FCC § 15.247(b)

For systems using digital modulation in the 902-928 MHz, 2400-2483.5 MHz, and 5725-5850 MHz bands: 1 Watt. As an alternative to a peak power measurement, compliance with the one Watt limit can be based on a measurement of the maximum conducted output power. Maximum Conducted Output Power is defined as the total transmit power delivered to all antennas and antenna elements averaged across all symbols in the signaling alphabet when the transmitter is operating at its maximum power control level. Power must be summed across all antennas and antenna elements.

RSS-247, 5.4 (4)

For DTSs employing digital modulation techniques operating in the bands 902-928 MHz and 2400-2483.5 MHz, the maximum peak conducted output power shall not exceed 1W. Except as provided in Section 5.4(5), the e.i.r.p. shall not exceed 4 W.

5.2.2 Test Setup

See section 4.4.1 for test setup description for the antenna port. The photo of test setup please refer to ANNEX B.

5.2.3 Test Procedure

a) Maximum peak conducted output power

This procedure shall be used when the measurement instrument has available a resolution bandwidth that is greater than the DTS bandwidth.

Set the RBW \geq DTS bandwidth.

Set VBW $\geq 3 \times$ RBW.

Set span $\geq 3 \times$ RBW

Sweep time = auto couple.

Detector = peak.

Trace mode = max hold.

Allow trace to fully stabilize.

Use peak marker function to determine the peak amplitude level.

b) Measurements of duty cycle

The zero-span mode on a spectrum analyzer or EMI receiver if the response time and spacing between bins on the sweep are sufficient to permit accurate measurements of the on and off times of the transmitted signal.

Set the center frequency of the instrument to the center frequency of the transmission.

Set RBW \geq OBW if possible; otherwise, set RBW to the largest available value.

Set VBW \geq RBW. Set detector = peak or average.

The zero-span measurement method shall not be used unless both RBW and VBW are $> 50/T$ and the number of

sweep points across duration T exceeds 100. (For example, if VBW and/or RBW are limited to 3 MHz, then the zero-span method of measuring duty cycle shall not be used if $T \leq 16.7$ microseconds.)

5.2.4 Test Result

Please refer to ANNEX A.1.

5.3 Occupied Bandwidth

5.3.1 Limit

FCC §15.247(a); RSS-247, 5.1 (1); RSS-GEN, 6.6

Make the measurement with the spectrum analyzer's resolution bandwidth (RBW) = 100 kHz. In order to make an accurate measurement, set the span greater than RBW. The 6 dB bandwidth must be greater than 500 kHz.

5.3.2 Test Setup

See section 4.4.1 for test setup description for the antenna port. The photo of test setup please refer to ANNEX B.

5.3.3 Test Procedure

Use the following spectrum analyzer settings:

Set RBW = 100 kHz.

Set the video bandwidth (VBW) ≥ 3 RBW.

Detector = Peak.

Trace mode = max hold.

Sweep = auto couple.

Allow the trace to stabilize.

Measure the maximum width of the emission that is constrained by the frequencies associated with the two outermost amplitude points (upper and lower frequencies) that are attenuated by 6 dB relative to the maximum level measured in the fundamental emission.

5.3.4 Test Result

Please refer to ANNEX A.2.

5.4 Conducted Spurious Emission

5.4.1 Limit

FCC §15.247(d); RSS-247, 5.5

In any 100 kHz bandwidth outside the frequency band in which the spread spectrum or digitally modulated intentional radiator is operating, the radio frequency power that is produced by the intentional radiator shall be at least 20 dB below that in the 100 kHz bandwidth within the band that contains the highest level of the desired power, based on either an RF conducted or a radiated measurement.

5.4.2 Test Setup

See section 4.4.1 for test setup description for the antenna port. The photo of test setup please refer to ANNEX B.

5.4.3 Test Procedure

The DTS rules specify that in any 100 kHz bandwidth outside of the authorized frequency band, the power shall be attenuated according to the following conditions:

- a) If the maximum peak conducted output power procedure was used to demonstrate compliance as described in 9.1, then the peak output power measured in any 100 kHz bandwidth outside of the authorized frequency band shall be attenuated by at least 20 dB relative to the maximum in-band peak PSD level in 100 kHz (i.e., 20 dBc).
- b) If maximum conducted (average) output power was used to demonstrate compliance as described in 9.2, then the peak power in any 100 kHz bandwidth outside of the authorized frequency band shall be attenuated by at least 30 dB relative to the maximum in-band peak PSD level in 100 kHz (i.e., 30 dBc).
- c) In either case, attenuation to levels below the 15.209 general radiated emissions limits is not required.

The following procedures shall be used to demonstrate compliance to these limits. Note that these procedures can be used in either an antenna-port conducted or radiated test set-up. Radiated tests must conform to the test site requirements and utilize maximization procedures defined herein.

Reference level measurement:

Establish a reference level by using the following procedure:

Set instrument center frequency to DTS channel center frequency.

Set the span to ≥ 1.5 times the DTS bandwidth.

Set the RBW = 100 kHz.

Set the VBW $\geq 3 \times$ RBW.

Detector = peak.

Sweep time = auto couple.

Trace mode = max hold.

Allow trace to fully stabilize.

Use the peak marker function to determine the maximum PSD level.

Emission level measurement:

Use the following spectrum analyzer settings:

Span = wide enough to capture the peak level of the in-band emission and all spurious emissions (e.g., harmonics) from the lowest frequency generated in the EUT up through the 10th harmonic. Typically, several plots are required to cover this entire span.

Set the RBW = 100 kHz.

Set the VBW $\geq 3 \times$ RBW.

Detector = peak.

Sweep time = auto couple.

Trace mode = max hold.

Allow trace to fully stabilize.

Use the peak marker function to determine the maximum amplitude level.

Ensure that the amplitude of all unwanted emissions outside of the authorized frequency band (excluding restricted frequency bands) are attenuated by at least the minimum requirements specified in 11.1 a) or 11.1 b). Report the three highest emissions relative to the limit.

5.4.4 Test Result

Please refer to ANNEX A.3.

5.5 Band Edge (Authorized-band band-edge)

5.5.1 Limit

FCC §15.247(d); RSS-247, 5.5

In any 100 kHz bandwidth outside the frequency band in which the spread spectrum or digitally modulated intentional radiator is operating, the radio frequency power that is produced by the intentional radiator shall be at least 20 dB below that in the 100 kHz bandwidth within the band that contains the highest level of the desired power, based on either an RF conducted or a radiated measurement.

5.5.2 Test Setup

See section 4.4.1 for test setup description for the antenna port. The photo of test setup please refer to ANNEX B.

5.5.3 Test Procedure

The following procedures may be used to determine the peak or average field strength or power of an unwanted emission that is within 2 MHz of the authorized band edge. If a peak detector is utilized, use the procedure described in 13.2.1. Use the procedure described in 13.2.2 when using an average detector and the EUT can be configured to transmit continuously (i.e., duty cycle $\geq 98\%$). Use the procedure described in 13.2.3 when using an average detector and the EUT cannot be configured to transmit continuously but the duty cycle is constant (i.e., duty cycle variations are less than ± 2 percent). Use the procedure described in 13.2.4 when using an average detector for those cases where the EUT cannot be configured to transmit continuously and the duty cycle is not constant (duty cycle variations equal or exceed 2 percent).

When using a peak detector to measure unwanted emissions at or near the band edge (within 2 MHz of the authorized band), the following integration procedure can be used.

Set instrument center frequency to the frequency of the emission to be measured (must be within 2 MHz of the authorized band edge).

Set span to 2 MHz

RBW = 100 kHz.

VBW $\geq 3 \times$ RBW.

Detector = peak.

Sweep time = auto.

Trace mode = max hold.

Allow sweep to continue until the trace stabilizes (required measurement time may increase for low duty cycle applications)

Compute the power by integrating the spectrum over 1 MHz using the analyzer's band power measurement function with band limits set equal to the emission frequency (femission) ± 0.5 MHz. If the instrument does not have a band power function, then sum the amplitude levels (in power units) at 100 kHz intervals extending across the 1 MHz spectrum defined by femission ± 0.5 MHz.

5.5.4 Test Result

Please refer to ANNEX A.4.

5.6 Conducted Emission

5.6.1 Limit

FCC §15.207; RSS-GEN, 8.8

For an intentional radiator that is designed to be connected to the public utility (AC) power line, the radio frequency voltage that is conducted back onto the AC power line on any frequency within the band 150 kHz to 30 MHz shall not exceed the limits in the following table, as measured using a 50 μ H/50 Ω line impedance stabilization network (LISN).

Frequency range (MHz)	Conducted Limit (dB μ V)	
	Quai-peak	Average
0.15 - 0.50	66 to 56	56 to 46
0.50 - 5	56	46
0.50 - 30	60	50

5.6.2 Test Setup

See section 4.4.2 for test setup description for the AC power supply port. The photo of test setup please refer to ANNEX B.

5.6.3 Test Procedure

The maximum conducted interference is searched using Peak (PK), if the emission levels more than the AV and QP limits, and that have narrow margins from the AV and QP limits will be re-measured with AV and QP detectors. Tests for both L phase and N phase lines of the power mains connected to the EUT are performed. Refer to recorded points and plots below.

Devices subject to Part 15 must be tested for all available U.S. voltages and frequencies (such as a nominal 120 VAC, 50/60 Hz and 240 VAC, 50/60 Hz) for which the device is capable of operation. A device rated for 50/60 Hz operation need not be tested at both frequencies provided the radiated and line conducted emissions are the same at both frequencies.

5.6.4 Test Result

Please refer to ANNEX A.5.

5.7 Radiated Spurious Emission

5.7.1 Limit

FCC §15.209&15.247(d); RSS-GEN, 8.9; RSS-247, 5.5

Radiated emission outside the frequency band attenuation below the general limits specified in FCC section 15.209(a) is not required. In addition, radiated emissions which fall in the restricted bands, as defined in FCC section 15.205(a), must also comply with the radiated emission limits specified in FCC section 15.209(a).

According to FCC section 15.209 (a), except as provided elsewhere in this subpart, the emissions from an intentional radiator shall not exceed the field strength levels specified in the following table:

Frequency (MHz)	Field Strength ($\mu\text{V}/\text{m}$)	Measurement Distance (m)
0.009 - 0.490	2400/F(kHz)	300
0.490 - 1.705	24000/F(kHz)	30
1.705 - 30.0	30	30
30 - 88	100	3
88 - 216	150	3
216 - 960	200	3
Above 960	500	3

Note:

1. Field Strength (dB $\mu\text{V}/\text{m}$) = 20*log[Field Strength ($\mu\text{V}/\text{m}$)].
2. In the emission tables above, the tighter limit applies at the band edges.
3. For Above 1000 MHz, the emission limit in this paragraph is based on measurement instrumentation employing an average detector, measurement using instrumentation with a peak detector function, corresponding to 20dB above the maximum permitted average limit.
4. For above 1000 MHz, limit field strength of harmonics: 54dBuV/m@3m (AV) and 74dBuV/m@3m (PK).

5.7.2 Test Setup

See section 4.4.3 to 4.4.5 for test setup description for the antenna port. The photo of test setup please refer to ANNEX B.

5.7.3 Test Procedure

The measurement frequency range is from 9 kHz to the 10th harmonic of the fundamental frequency. The Turn Table is actuated to turn from 0° to 360°, and both horizontal and vertical polarizations of the Test Antenna are used to find the maximum radiated power. Mid channels on all channel bandwidth verified. Only the worst RB size/offset presented.

The power of the EUT transmitting frequency should be ignored.

All Spurious Emission tests were performed in X, Y, Z axis direction. And only the worst axis test condition was recorded in this test report.

Use the following spectrum analyzer settings:

Span = wide enough to fully capture the emission being measured

RBW = 1 MHz for $f \geq 1$ GHz, 100 kHz for $f < 1$ GHz

VBW \geq RBW

Sweep = auto

Detector function = peak

Trace = max hold

For measurement below 1GHz, If the emission level of the EUT measured by the peak detector is 3 dB lower than the applicable limit, the peak emission level will be reported, Otherwise, the emission measurement will be repeated using the quasi-peak detector and reported.

5.7.4 Test Result

Please refer to ANNEX A.6.

5.8 Band Edge (Restricted-band band-edge)

5.8.1 Limit

FCC §15.209&15.247(d); RSS-GEN, 8.9; RSS-247, 5.5

Radiated emission outside the frequency band attenuation below the general limits specified in FCC section 15.209(a) is not required. In addition, radiated emissions which fall in the restricted bands, as defined in FCC section 15.205(a), must also comply with the radiated emission limits specified in FCC section 15.209(a).

5.8.2 Test Setup

See section 4.4.3 to 4.4.5 for test setup description for the antenna port. The photo of test setup please refer to ANNEX B.

5.8.3 Test Procedure

The measurement frequency range is from 9 kHz to the 10th harmonic of the fundamental frequency. The Turn Table is actuated to turn from 0° to 360°, and both horizontal and vertical polarizations of the Test Antenna are used to find the maximum radiated power. Mid channels on all channel bandwidth verified. Only the worst RB size/offset presented.

The power of the EUT transmitting frequency should be ignored.

All Spurious Emission tests were performed in X, Y, Z axis direction. And only the worst axis test condition was recorded in this test report.

Use the following spectrum analyzer settings:

Span = wide enough to fully capture the emission being measured

RBW = 1 MHz for $f \geq 1$ GHz, 100 kHz for $f < 1$ GHz

VBW \geq RBW

Sweep = auto

Detector function = peak

Trace = max hold

For measurement below 1GHz, If the emission level of the EUT measured by the peak detector is 3 dB lower than the applicable limit, the peak emission level will be reported, Otherwise, the emission measurement will be repeated using the quasi-peak detector and reported.

For transmitters operating above 1 GHz repeat the measurement with an average detector.

1.1.1 Test Result

Please refer to ANNEX A.7.

5.9 Power Spectral density (PSD)

5.9.1 Limit

FCC §15.247(e); RSS-247, 5.2 (2)

The same method of determining the conducted output power shall be used to determine the power spectral density. If a peak output power is measured, then a peak power spectral density measurement is required. If an average output power is measured, then an average power spectral density measurement should be used.

The transmitter power spectral density conducted from the transmitter to the antenna shall not be greater than 8 dBm in any 3 kHz band during any time interval of continuous transmission. This power spectral density shall be determined in accordance with the provisions of Section 5.4(4), (i.e. the power spectral density shall be determined using the same method as is used to determine the conducted output power).

5.9.2 Test Setup

See section 4.4.1 (Diagram 1) for test setup description for the antenna port. The photo of test setup please refer to ANNEX B.

5.9.3 Test Procedure

Set analyzer center frequency to DTS channel center frequency.

Set the span to 1.5 times the DTS bandwidth.

Set the RBW to: $3 \text{ kHz} \leq \text{RBW} \leq 100 \text{ kHz}$.

Set the VBW $\geq 3 \text{ RBW}$.

Detector = peak.

Sweep time = auto couple.

Trace mode = max hold.

Allow trace to fully stabilize.

Use the peak marker function to determine the maximum amplitude level within the RBW.

If measured value exceeds limit, reduce RBW (no less than 3 kHz) and repeat.

5.9.4 Test Result

Please refer to ANNEX A.7.

ANNEX A TEST RESULT

A.1 Output Power

Peak Power Test Data

Channel	Measured Output Peak Power		Limit		Verdict
	LoRa		dBm	mW	
	dBm	mW			
Low	15.76	37.67	30	1000	Pass
Middle	15.69	37.07			Pass
High	15.66	36.81			Pass

Test plots

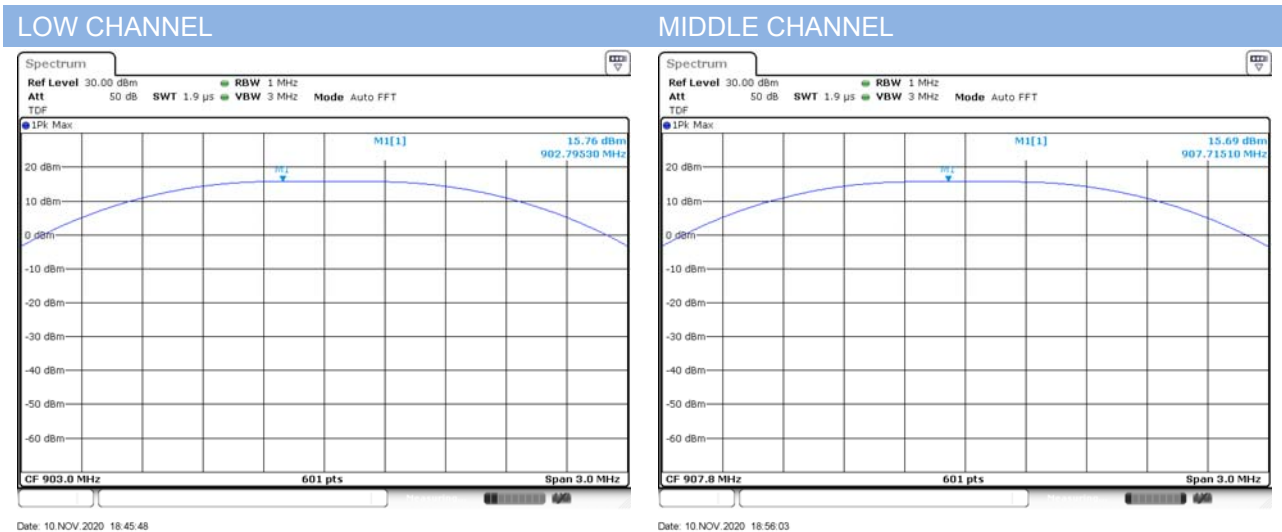

A.2 Occupied Bandwidth

Test Data

Test Mode	LoRa		
Channel	6 dB Bandwidth (kHz)	99% Bandwidth (kHz)	6 dB Bandwidth Limits (kHz)
Low Channel	0.643433	0.655500	≥500
Middle Channel	0.647827	0.654000	≥500
High Channel	0.641357	0.673500	≥500

Test plots (6 dB Bandwidth)

LOW CHANNEL

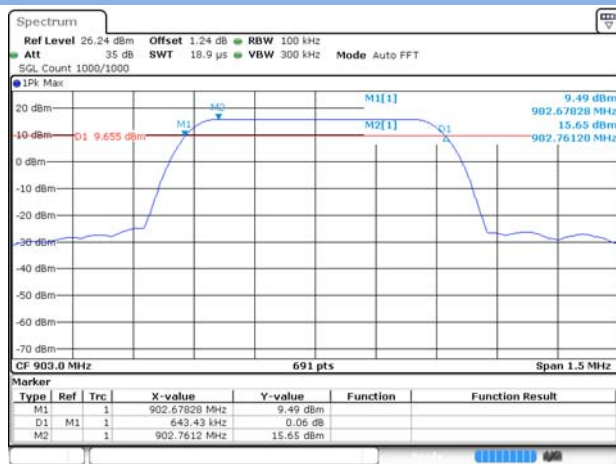

Date: 10 NOV 2020 18:54:00

MIDDLE CHANNEL

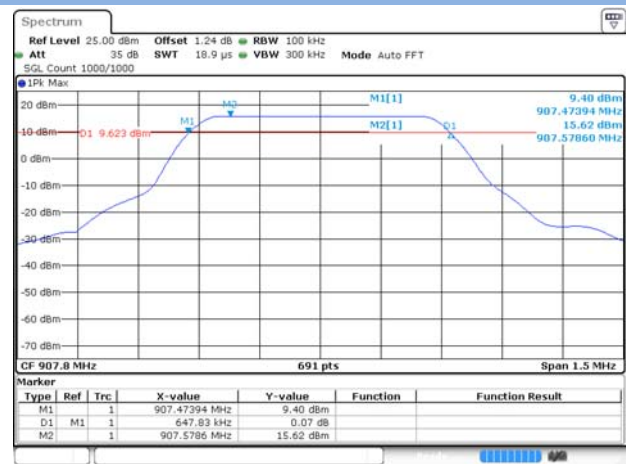

Date: 10 NOV 2020 18:56:09

HIGH CHANNEL

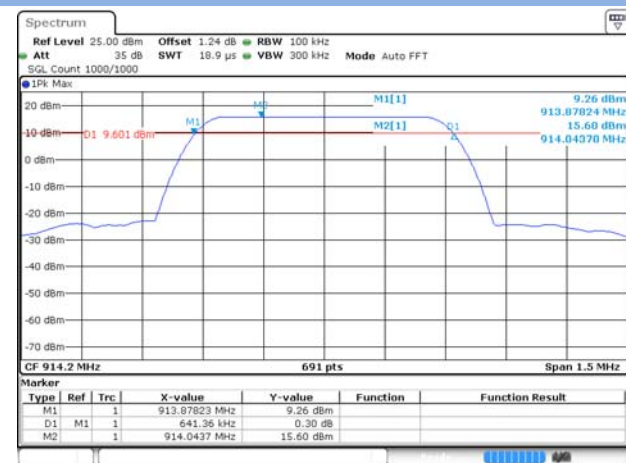

Date: 10 NOV 2020 19:04:51

Test plots (99% Bandwidth)

LOW CHANNEL

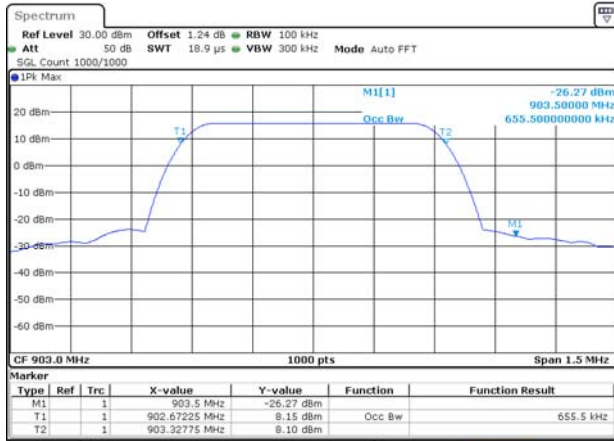

Date: 10 NOV 2020 18:55:02

MIDDLE CHANNEL

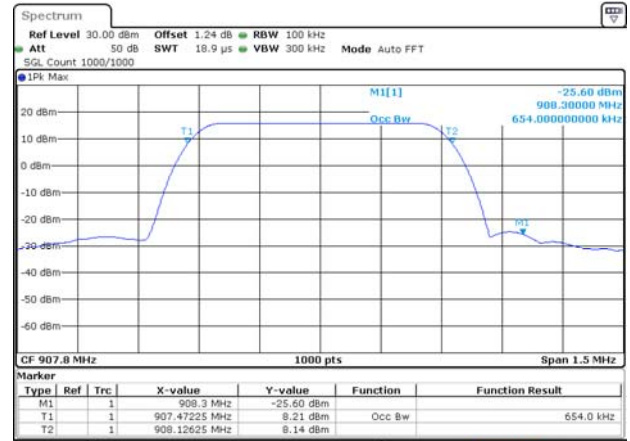

Date: 10 NOV 2020 19:10:18

HIGH CHANNEL



Date: 10 NOV 2020 19:05:28

A.3 Conducted Spurious Emissions

Test Data

LoRa				
Channel	Measured Max. Out of Band Emission (dBm)	Limit (dBm)		Verdict
		Carrier Level	Calculated 20 dBc Limit	
Low	-25.78	15.74	-4.26	Pass
Middle	-25.89	15.67	-4.33	Pass
High	-26.10	15.63	-4.37	Pass

Test Plots

LOW CHANNEL, CARRIER LEVEL

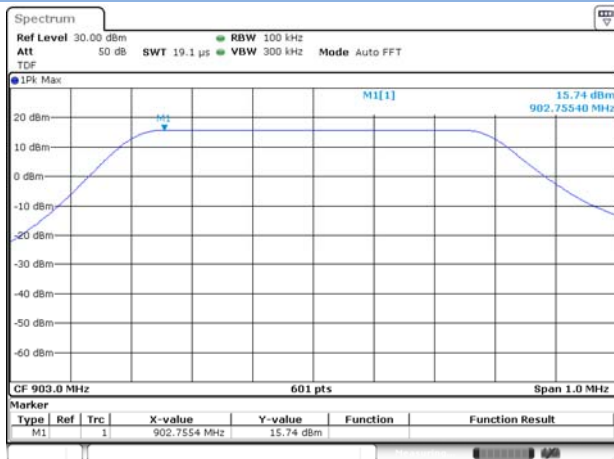

Date: 10 NOV 2020 18:46:36

LOW CHANNEL, SPURIOUS 30 MHz ~ 3 GHz

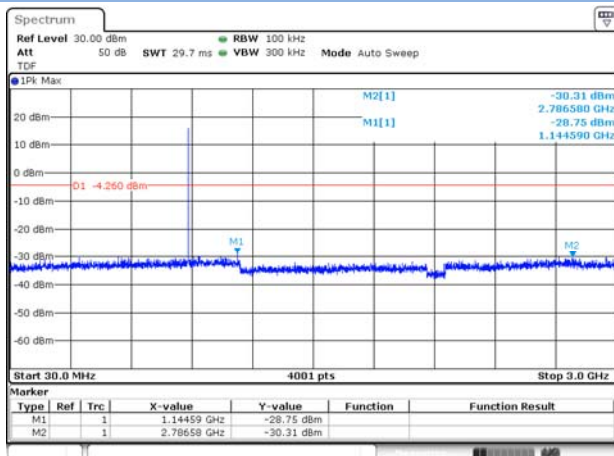

Date: 10 NOV 2020 18:47:01

LOW CHANNEL, SPURIOUS 3 GHz ~ 25 GHz

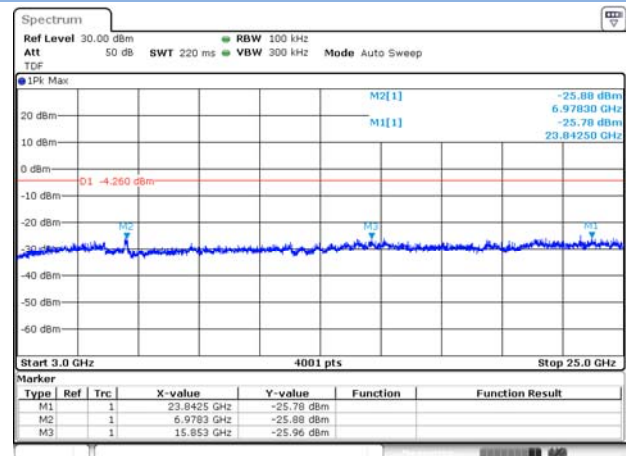

Date: 10 NOV 2020 18:47:24

MIDDLE CHANNEL, CARRIER LEVEL

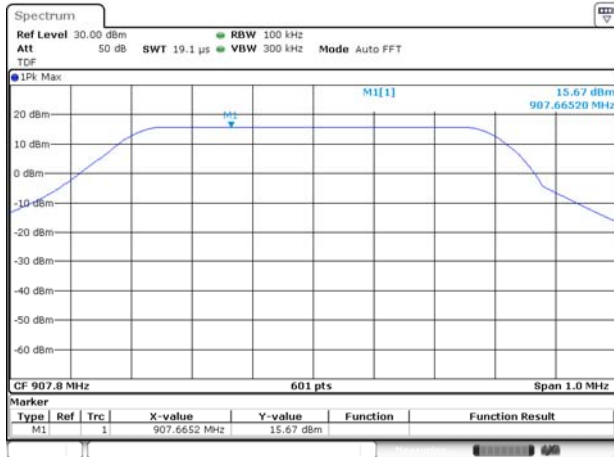

Date: 10 NOV 2020 18:57:05

MIDDLE CHANNEL, SPURIOUS 30 MHz ~ 3 GHz

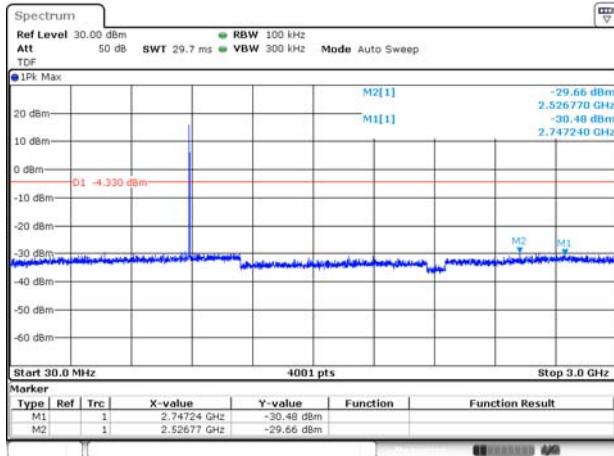

Date: 10 NOV 2020 18:58:27

MIDDLE CHANNEL, SPURIOUS 3 GHz ~ 25 GHz

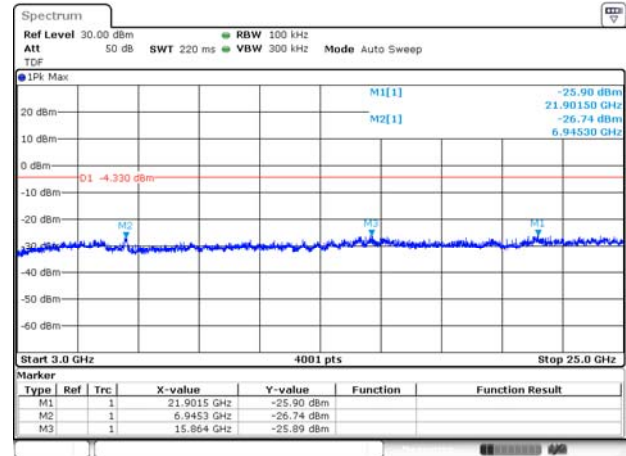

Date: 10 NOV 2020 18:58:48

High CHANNEL, CARRIER LEVEL

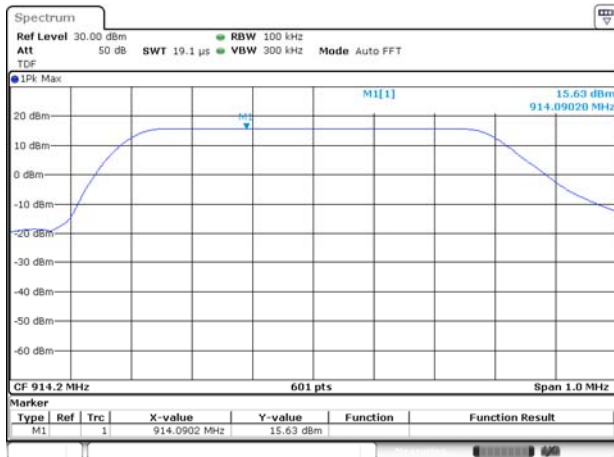

Date: 10 NOV 2020 19:05:47

HIGH CHANNEL, SPURIOUS 30 MHz ~ 3 GHz

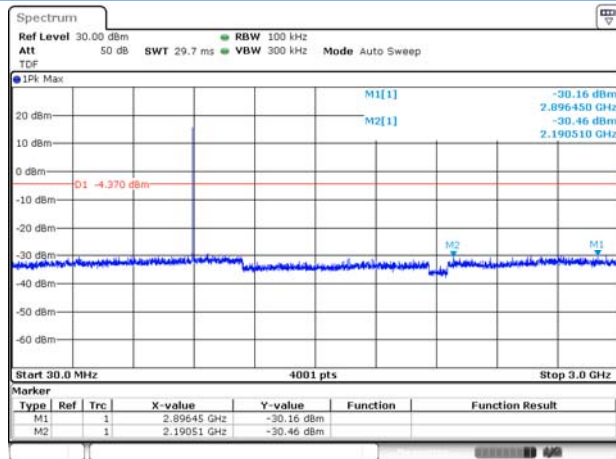

Date: 10 NOV 2020 19:06:29

HIGH CHANNEL, SPURIOUS 3 GHz ~ 25 GHz

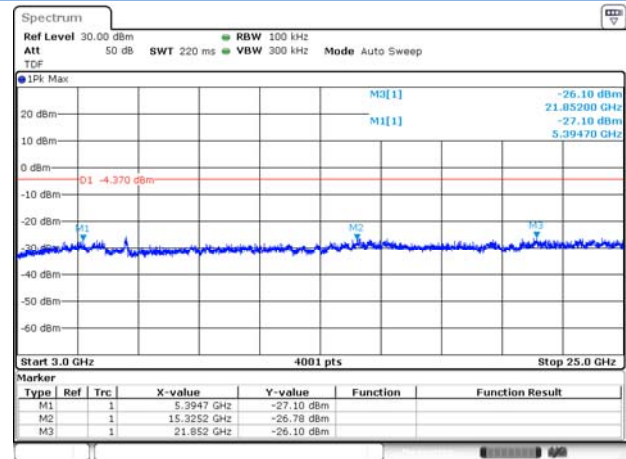

Date: 10 NOV 2020 19:06:44

A.4 Band Edge (Authorized-band band-edge)

Note: The lowest and highest channels are tested to verify the band edge emissions. Please refer to the following the plots for emissions values.

Channel	Measured Max. Band Edge Emission (dBm)	Limit (dBm)		Verdict
		Carrier Level	Calculated 20 dBc Limit	
Low Channel	-31.75	15.74	-4.26	Pass
High Channel	-56.20	15.63	-4.37	Pass

Test Plots

LOW CHANNEL, Carrier level

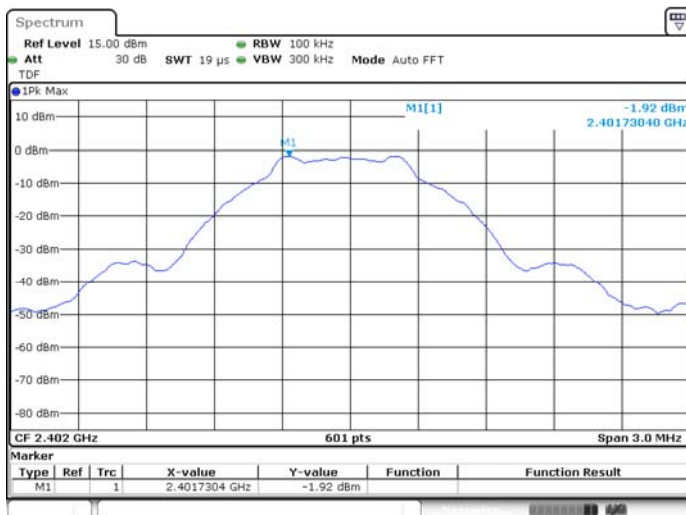

Date: 22.OCT.2020 07:49:56

LOW CHANNEL, Band Edge

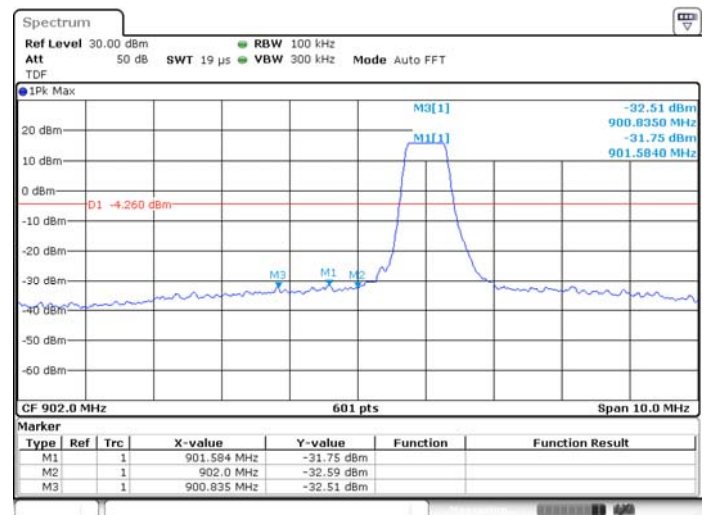

Date: 10.NOV.2020 16:47:54

High CHANNEL, Carrier level

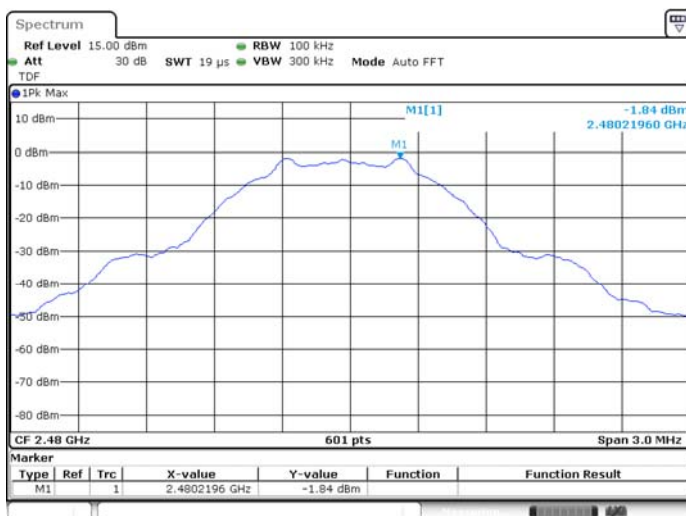

Date: 22.OCT.2020 07:56:25

High CHANNEL, Band Edge

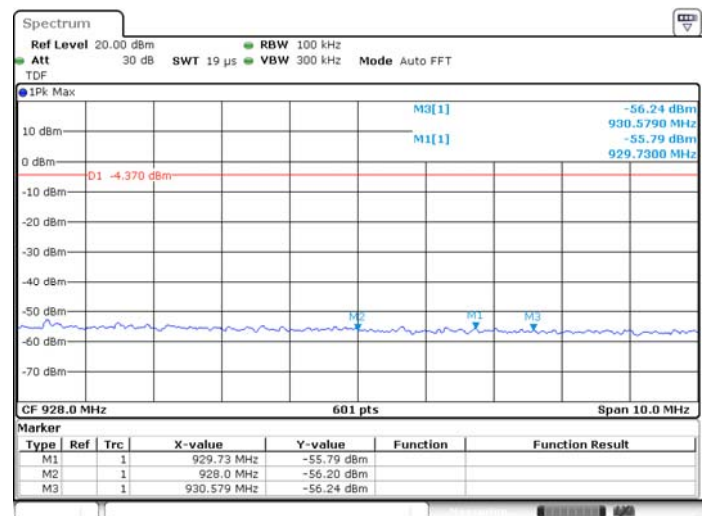

Date: 10.NOV.2020 19:07:12

A.5 Conducted Emissions

Note 1: The EUT is working in the Normal link mode. All modes have been tested and normal link mode is worst.
 Note 2: Devices subject to Part 15 must be tested for all available U.S. voltages and frequencies (such as a nominal 120 VAC, 60 Hz and 240 VAC, 50 Hz) for which the device is capable of operation. So, The configuration 120 VAC, 60 Hz and 240 VAC, 50 Hz were tested respectively, but only the worst configuration (120 VAC, 60 Hz) shown here.

Note 3: Results (dBuV) = Original reading level of Spectrum Analyzer (dBuV) + Factor (dB)

Test Data and Plots

PHASE L

CE Test case_FCC_CE_FCC PART 15B_Class B

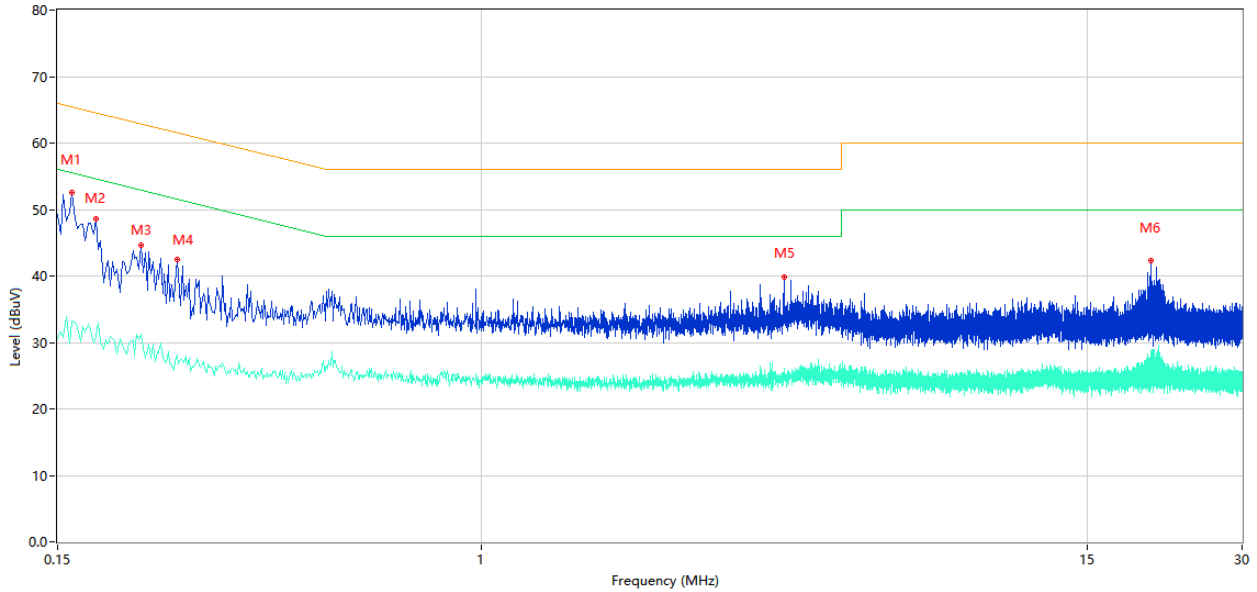

No.	Frequency (MHz)	Results (dBuV)	Factor (dB)	Limit (dBuV)	Over Limit (dB)	Detector	Line	Verdict
1	0.160	52.64	10.40	65.46	-12.82	Peak	L	Pass
1**	0.160	33.19	10.40	55.46	-22.27	AV	L	Pass
2	0.178	48.59	10.39	64.58	-15.99	Peak	L	Pass
2**	0.178	30.91	10.39	54.58	-23.67	AV	L	Pass
3	0.218	44.58	10.37	62.89	-18.31	Peak	L	Pass
3**	0.218	31.25	10.37	52.89	-21.64	AV	L	Pass
4	0.256	42.54	10.34	61.56	-19.02	Peak	L	Pass
4**	0.256	28.02	10.34	51.56	-23.54	AV	L	Pass
5	3.862	39.80	10.30	56.00	-16.20	Peak	L	Pass
5**	3.862	26.08	10.30	46.00	-19.92	AV	L	Pass
6	20.002	42.34	10.55	60.00	-17.66	Peak	L	Pass
6**	20.002	27.23	10.55	50.00	-22.77	AV	L	Pass

PHASE N

CE Test case_FCC_CE_FCC PART 15B_Class B

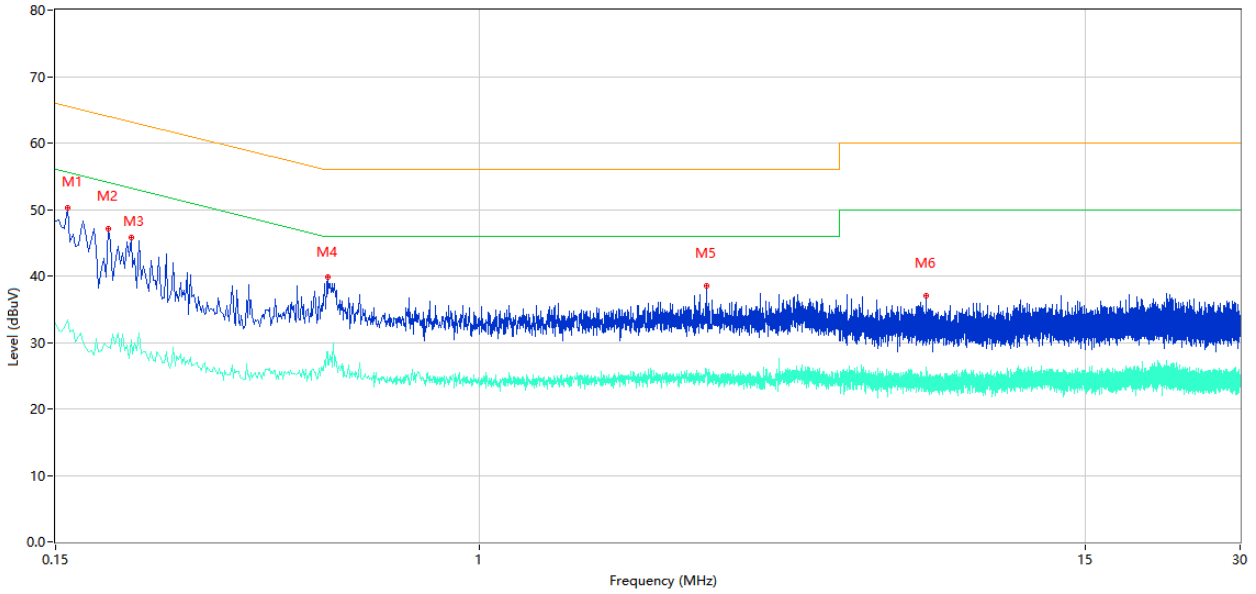

No.	Frequency (MHz)	Results (dBuV)	Factor (dB)	Limit (dBuV)	Over Limit (dB)	Detector	Line	Verdict
1	0.158	50.18	10.40	65.57	-15.39	Peak	N	Pass
1**	0.158	33.32	10.40	55.57	-22.25	AV	N	Pass
2	0.190	47.08	10.38	64.04	-16.96	Peak	N	Pass
2**	0.190	29.31	10.38	54.04	-24.73	AV	N	Pass
3	0.210	45.77	10.38	63.21	-17.44	Peak	N	Pass
3**	0.210	30.47	10.38	53.21	-22.74	AV	N	Pass
4	0.506	39.87	10.30	56.00	-16.13	Peak	N	Pass
4**	0.506	26.67	10.30	46.00	-19.33	AV	N	Pass
5	2.752	38.49	10.28	56.00	-17.51	Peak	N	Pass
5**	2.752	25.68	10.28	46.00	-20.32	AV	N	Pass
6	7.380	36.96	10.35	60.00	-23.04	Peak	N	Pass
6**	7.380	24.34	10.35	50.00	-25.66	AV	N	Pass

A.6 Radiated Spurious Emission

Note¹: The symbol of "--" in the table which means not application.

Note²: For the test data above 1 GHz, according the ANSI C63.4-2014, where limits are specified for both average and peak (or quasi-peak) detector functions, if the peak (or quasi-peak) measured value complies with the average limit, it is unnecessary to perform an average measurement.

Note³: The low frequency, which started from 9 kHz to 30 MHz, was pre-scanned and the result which was 20 dB lower than the limit line per 15.31(o) was not reported.

Note⁴: The marked spikes near 900 MHz with circle should be ignored because they are Fundamental signal.

Test Data and Plots

LOW CHANNEL, 850 MHz to 950 MHz, ANT H

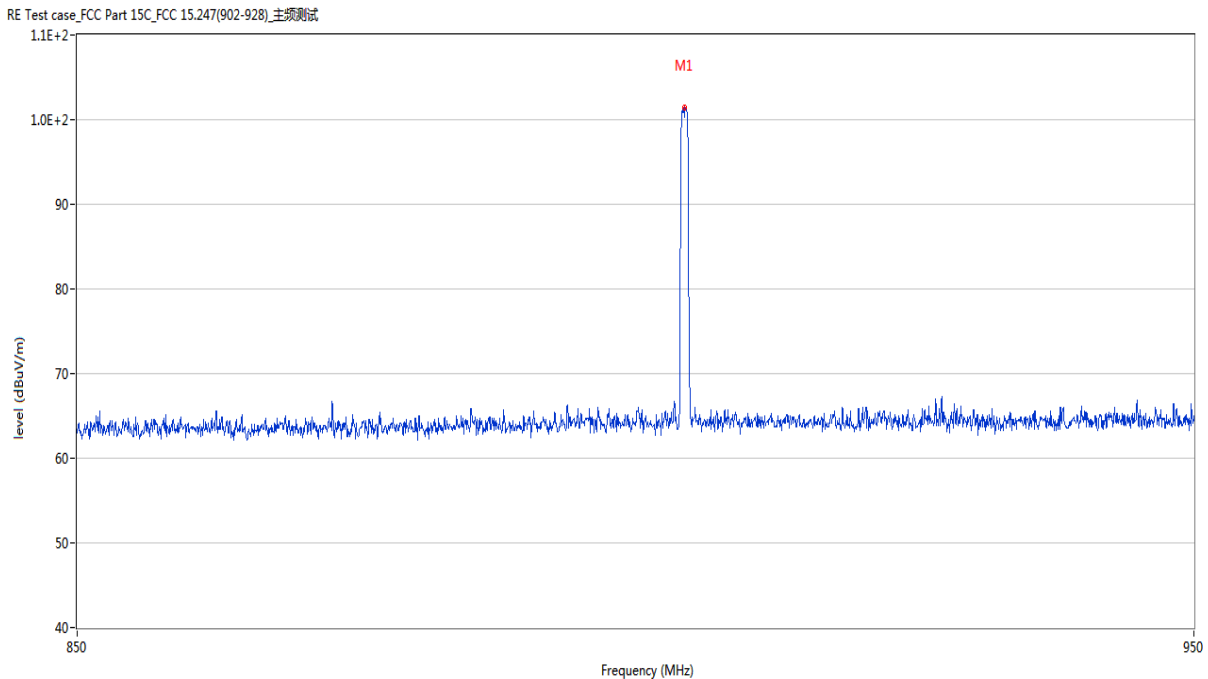

No.	Frequency (MHz)	Results (dBuV/m)	Factor (dB)	Limit (dBuV/m)	Over Limit (dB)	Detector	Table (Degree)	Height (cm)	Antenna	Verdict
1	903.049	101.39	30.03	--	--	Peak	82.00	200	Horizontal	N/A

LOW CHANNEL, 850 MHz to 950 MHz, ANT V

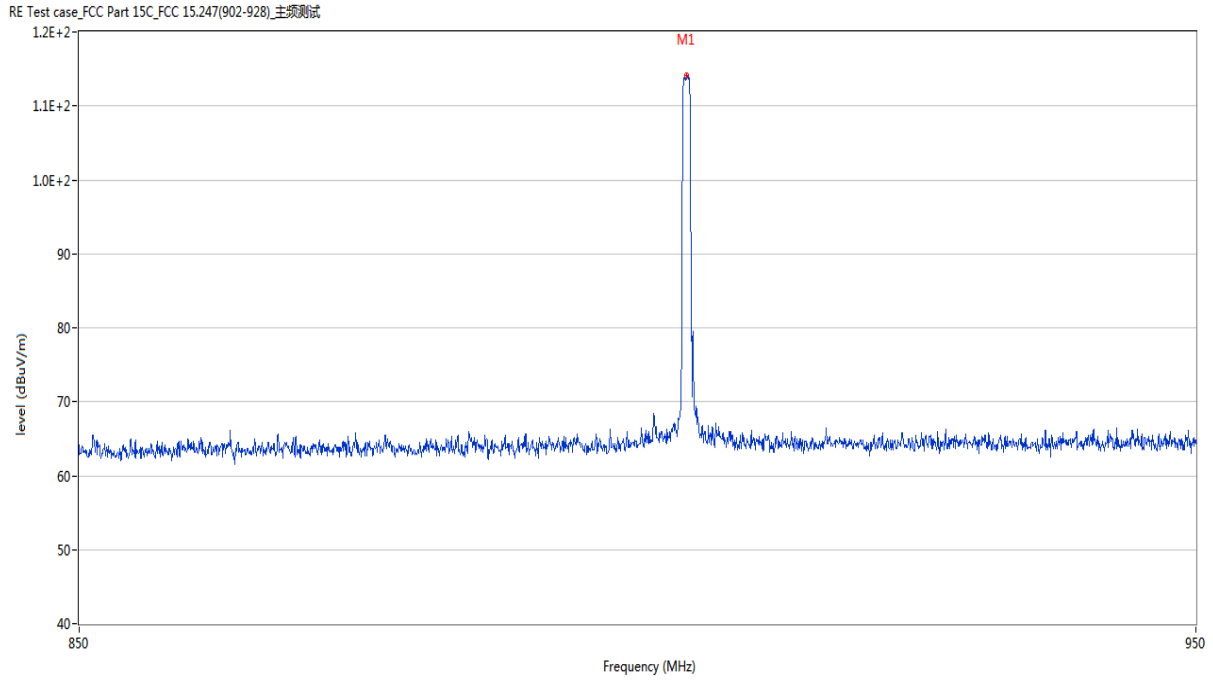

No.	Frequency (MHz)	Results (dBuV/m)	Factor (dB)	Limit (dBuV/m)	Over Limit (dB)	Detector	Table (Degree)	Height (cm)	Antenna	Verdict
1	903.049	114.06	30.03	--	--	Peak	120.00	200	Vertical	Pass

MIDDLE CHANNEL, 850 MHz to 950 MHz, ANT H

RE Test case_FCC Part 15C_FCC 15.247(902-928)_主频测试

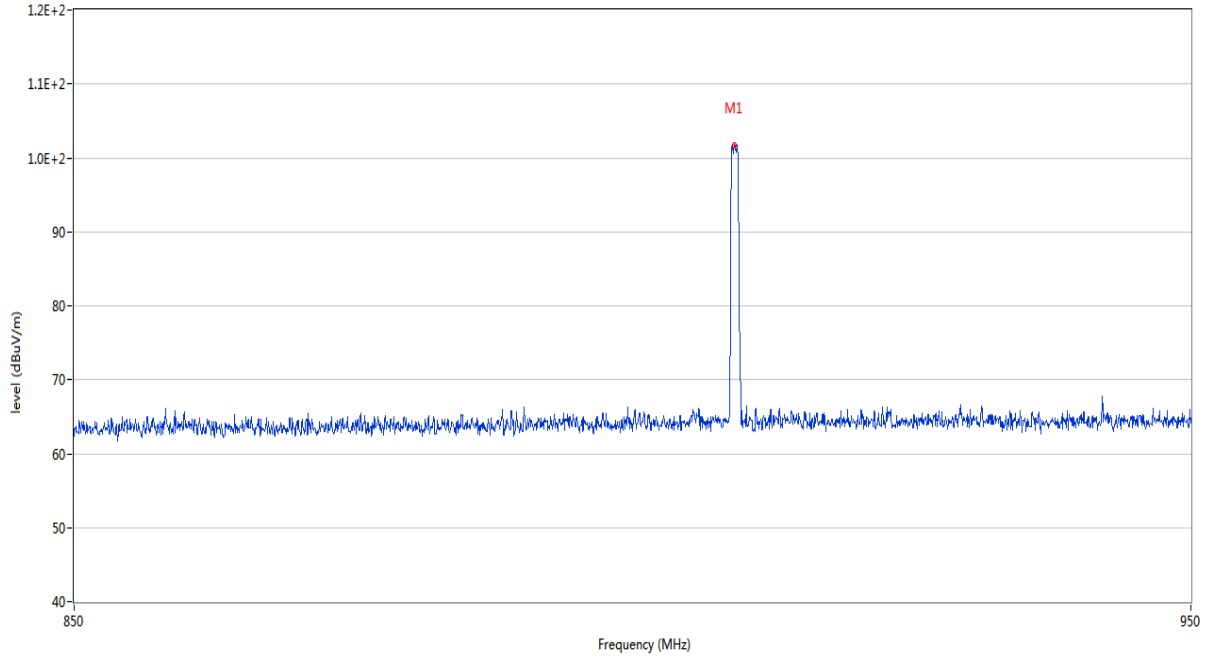

No.	Frequency (MHz)	Results (dBuV/m)	Factor (dB)	Limit (dBuV/m)	Over Limit (dB)	Detector	Table (Degree)	Height (cm)	Antenna	Verdict
1	907.802	101.73	30.23	--	--	Peak	73.00	200	Horizontal	N/A

MIDDLE CHANNEL, 850 MHz to 950 MHz, ANT V

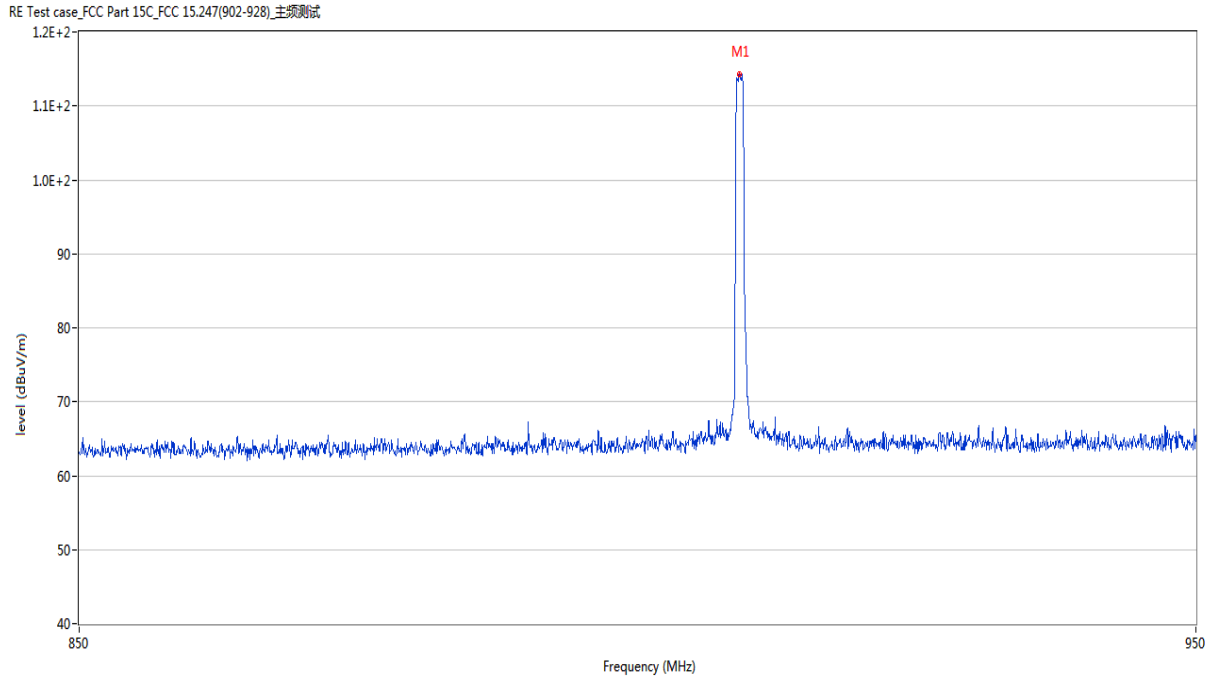

No.	Frequency (MHz)	Results (dBuV/m)	Factor (dB)	Limit (dBuV/m)	Over Limit (dB)	Detector	Table (Degree)	Height (cm)	Antenna	Verdict
1	907.753	114.29	30.23	--	--	Peak	117.00	200	Vertical	Pass

HIGH CHANNEL, 850 MHz to 950 MHz, ANT H

RE Test case_FCC Part 15C_FCC 15.247(902-928)_主频测试

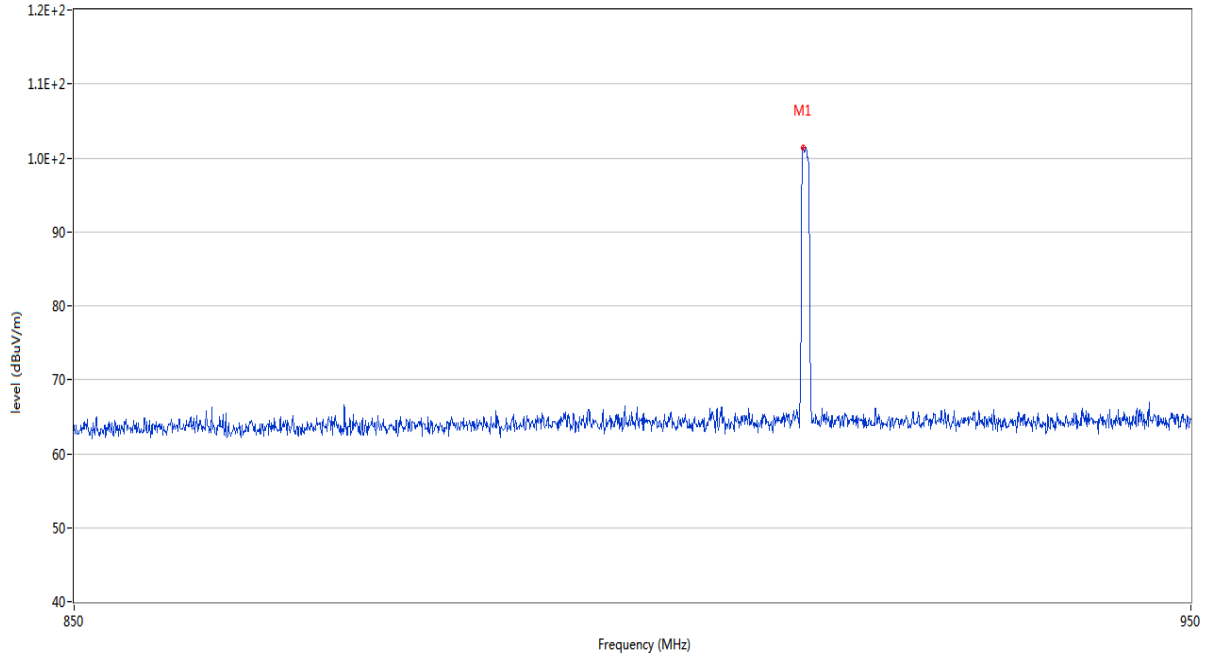

No.	Frequency (MHz)	Results (dBuV/m)	Factor (dB)	Limit (dBuV/m)	Over Limit (dB)	Detector	Table (Degree)	Height (cm)	Antenna	Verdict
1	914.058	101.45	30.38	--	--	Peak	75.00	200	Horizontal	N/A

HIGH CHANNEL, 850 MHz to 950 MHz, ANT V

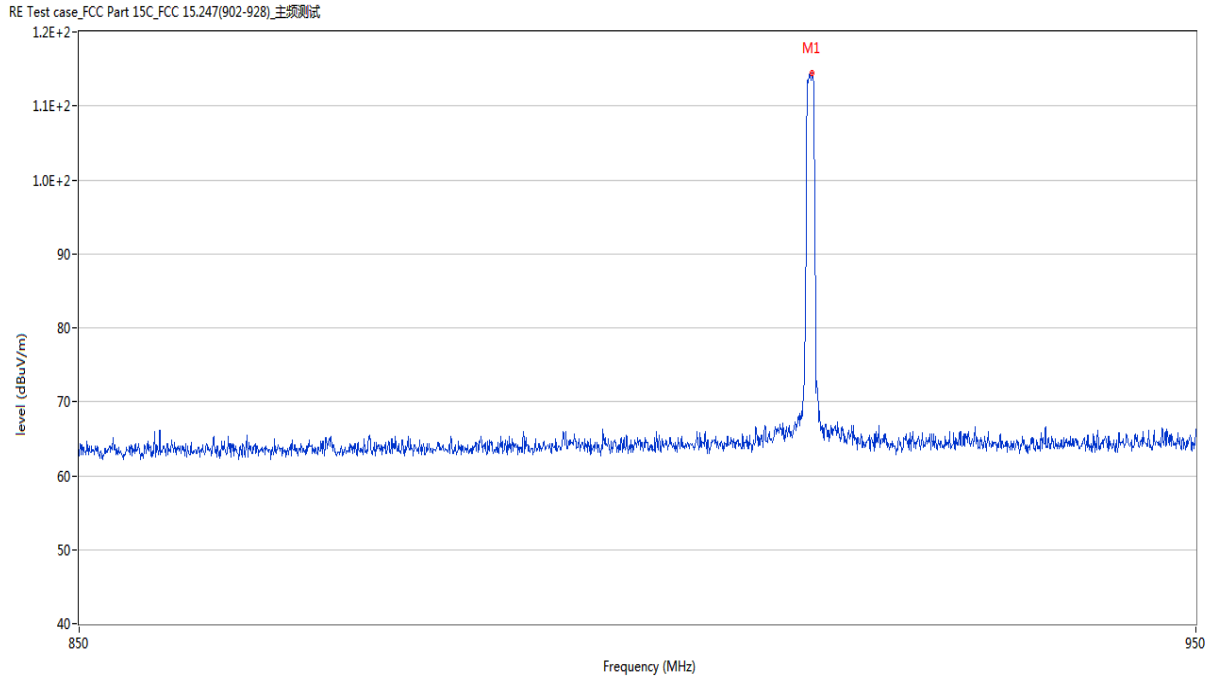

No.	Frequency (MHz)	Results (dBuV/m)	Factor (dB)	Limit (dBuV/m)	Over Limit (dB)	Detector	Table (Degree)	Height (cm)	Antenna	Verdict
1	914.398	114.46	30.38	--	--	Peak	113.00	200	Vertical	N/A

LOW CHANNEL, ANT H

RE Test case_FCC Part 15C_FCC 15.247(902-928MHz)_30MHz-1GHz

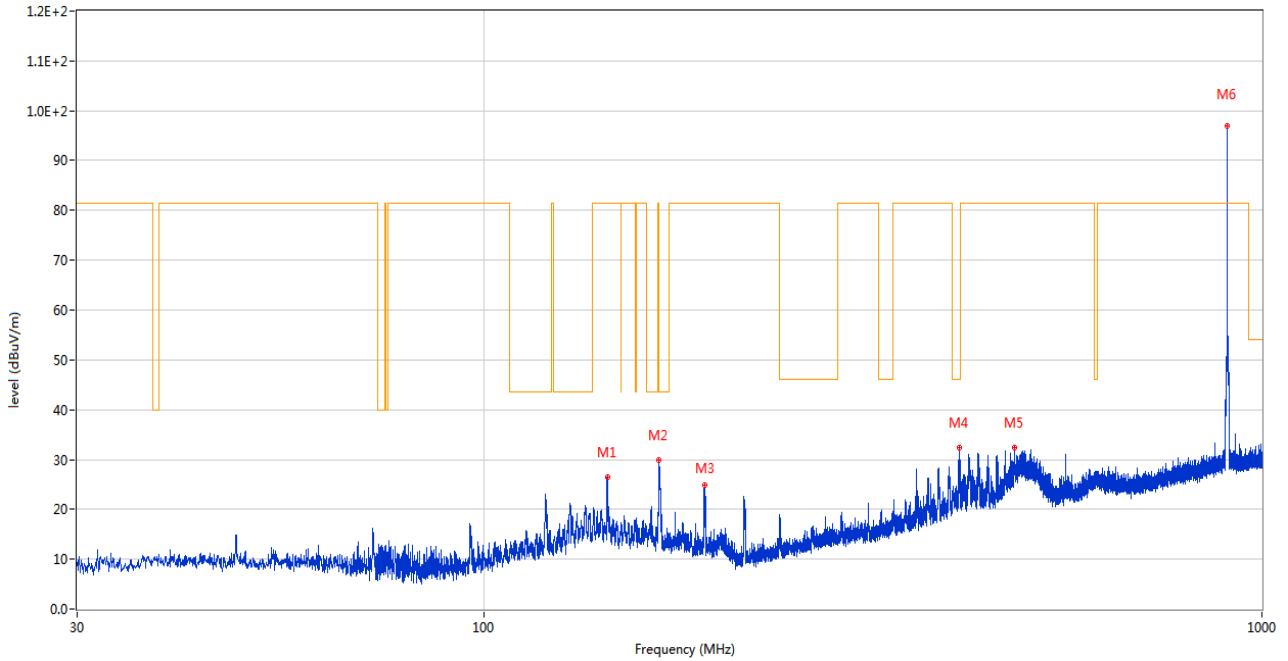

No.	Frequency (MHz)	Results (dBuV/m)	Factor (dB)	Limit (dBuV/m)	Over Limit (dB)	Detector	Table (Degree)	Height (cm)	Antenna	Verdict
1	144.024	26.50	-24.34	81.4	-54.90	Peak	242.00	100	Horizontal	Pass
2	168.031	29.89	-24.12	43.5	-13.61	Peak	78.00	200	Horizontal	Pass
3	192.038	24.95	-26.86	81.4	-56.45	Peak	119.00	100	Horizontal	Pass
4	408.009	32.29	-19.00	46.0	-13.71	Peak	187.00	200	Horizontal	Pass
5	481.098	32.51	-16.68	81.4	-48.89	Peak	338.00	100	Horizontal	Pass
6	903.194	96.96	-7.58	81.4	15.56	Peak	255.00	100	Horizontal	N/A

LOW CHANNEL, ANT V

RE Test case_FCC Part 15C_FCC 15.247(902-928MHz)_30MHz-1GHz

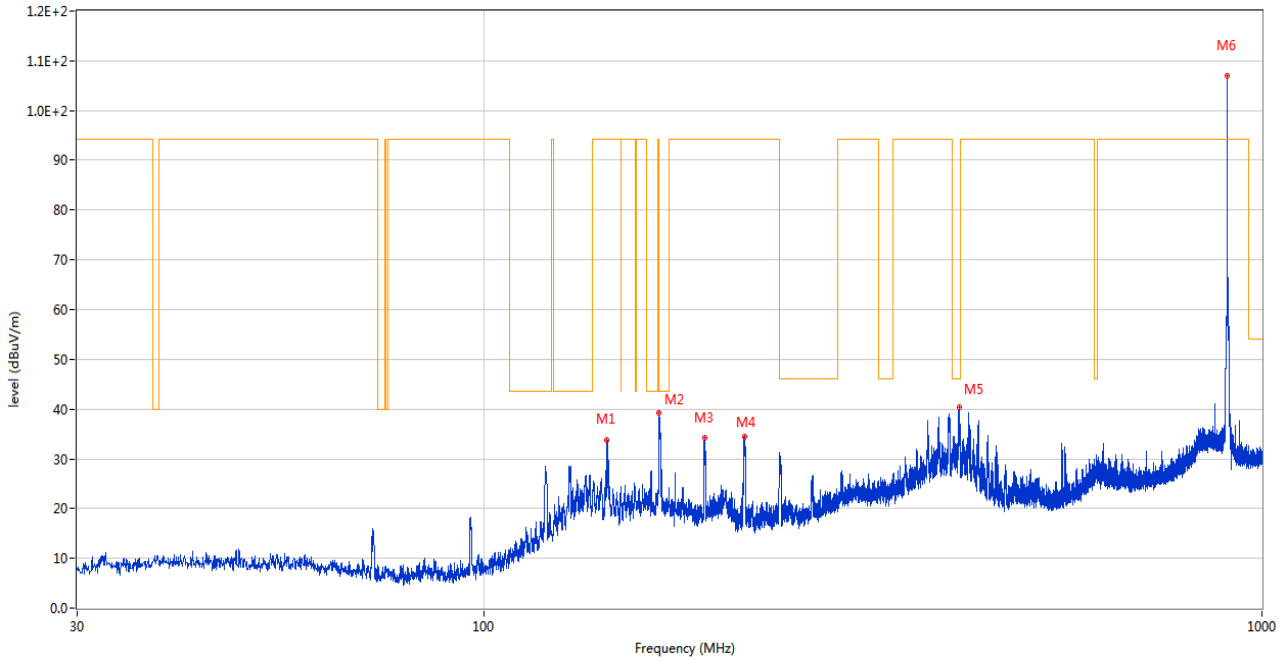

No.	Frequency (MHz)	Results (dBuV/m)	Factor (dB)	Limit (dBuV/m)	Over Limit (dB)	Detector	Table (Degree)	Height (cm)	Antenna	Verdict
1	143.975	33.69	-24.35	94.1	-60.41	Peak	206.00	100	Vertical	Pass
2	168.031	39.25	-24.12	43.5	-4.25	Peak	336.00	100	Vertical	Pass
3	191.990	34.27	-26.85	94.1	-59.83	Peak	343.00	200	Vertical	Pass
4	216.337	34.37	-26.20	94.1	-59.73	Peak	329.00	100	Vertical	Pass
5	408.009	40.34	-19.00	46.0	-5.66	Peak	336.00	200	Vertical	Pass
6	903.194	106.97	-7.58	94.1	12.87	Peak	343.00	100	Vertical	N/A

MIDDLE CHANNEL, ANT H

RE Test case_FCC Part 15C_FCC 15.247(902-928MHz)_30MHz-1GHz

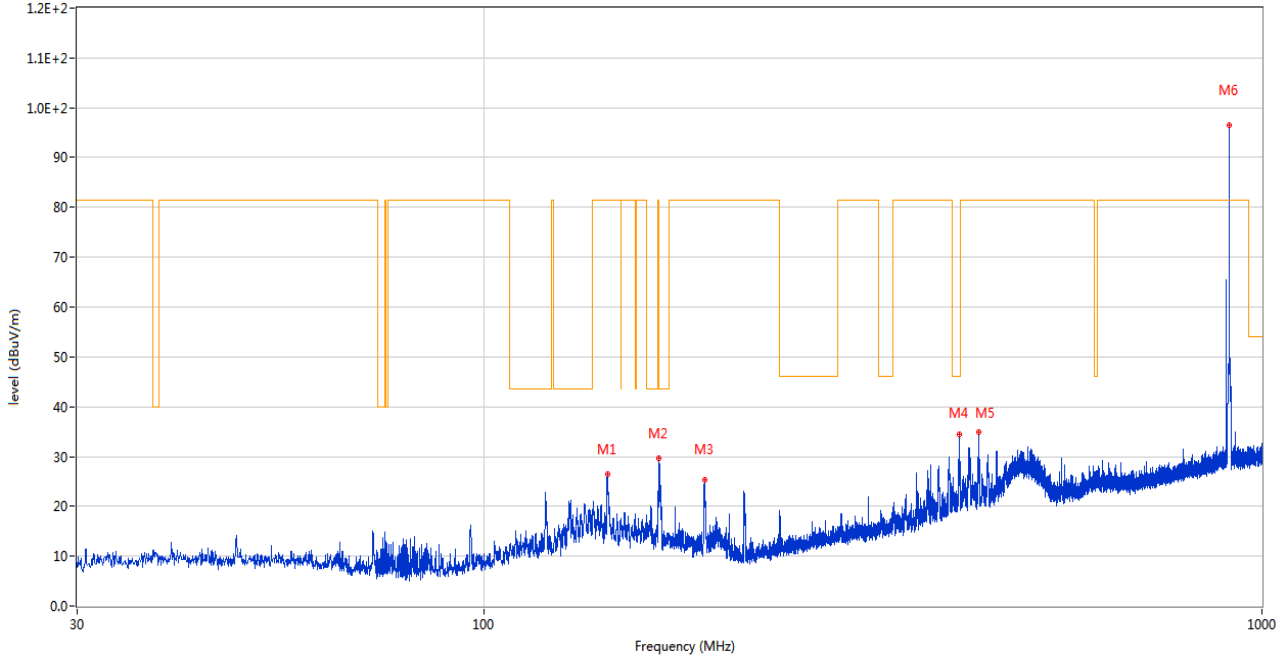

No.	Frequency (MHz)	Results (dBuV/m)	Factor (dB)	Limit (dBuV/m)	Over Limit (dB)	Detector	Table (Degree)	Height (cm)	Antenna	Verdict
1	144.024	26.49	-24.34	43.5	-17.01	Peak	287.00	100	Horizontal	Pass
2	167.982	29.57	-24.11	43.5	-13.93	Peak	232.00	100	Horizontal	Pass
3	192.038	25.39	-26.86	81.7	-56.31	Peak	107.00	200	Horizontal	Pass
4	408.009	34.35	-19.00	46.0	-11.65	Peak	295.00	100	Horizontal	Pass
5	432.405	35.01	-18.09	81.7	-46.69	Peak	78.00	100	Horizontal	Pass
6	907.559	96.59	-7.64	81.7	14.89	Peak	245.00	100	Horizontal	N/A

MIDDLE CHANNEL, ANT V

RE Test case_FCC Part 15C_FCC 15.247(902-928MHz)_30MHz-1GHz

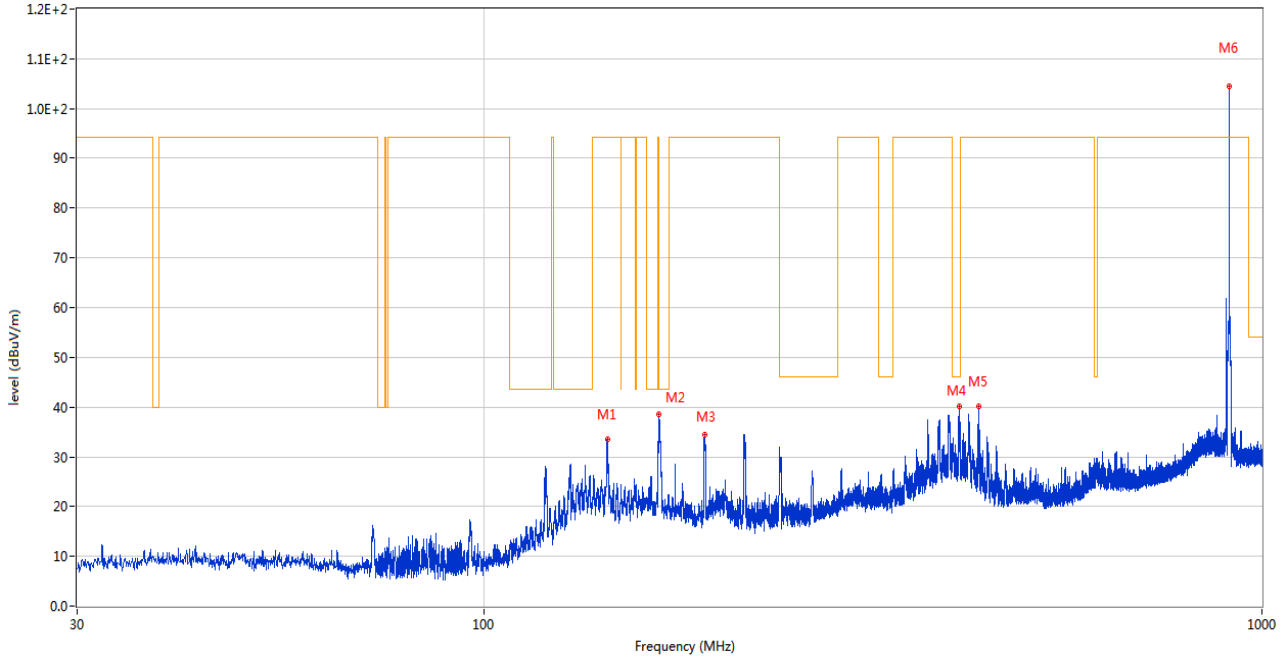

No.	Frequency (MHz)	Results (dBuV/m)	Factor (dB)	Limit (dBuV/m)	Over Limit (dB)	Detector	Table (Degree)	Height (cm)	Antenna	Verdict
1	144.024	33.57	-24.34	94.3	-60.73	Peak	162.00	100	Vertical	Pass
2	167.982	38.63	-24.11	43.5	-4.87	Peak	294.00	100	Vertical	Pass
3	192.038	34.55	-26.86	94.3	-59.75	Peak	329.00	200	Vertical	Pass
4	408.009	40.22	-19.00	46.0	-5.78	Peak	336.00	200	Vertical	Pass
5	432.210	40.04	-18.11	94.3	-54.26	Peak	349.00	100	Vertical	Pass
6	907.607	104.42	-7.65	94.3	10.12	Peak	329.00	100	Vertical	N/A

HIGH CHANNEL, ANT H

RE Test case_FCC Part 15C_FCC 15.247(902-928MHz)_30MHz-1GHz

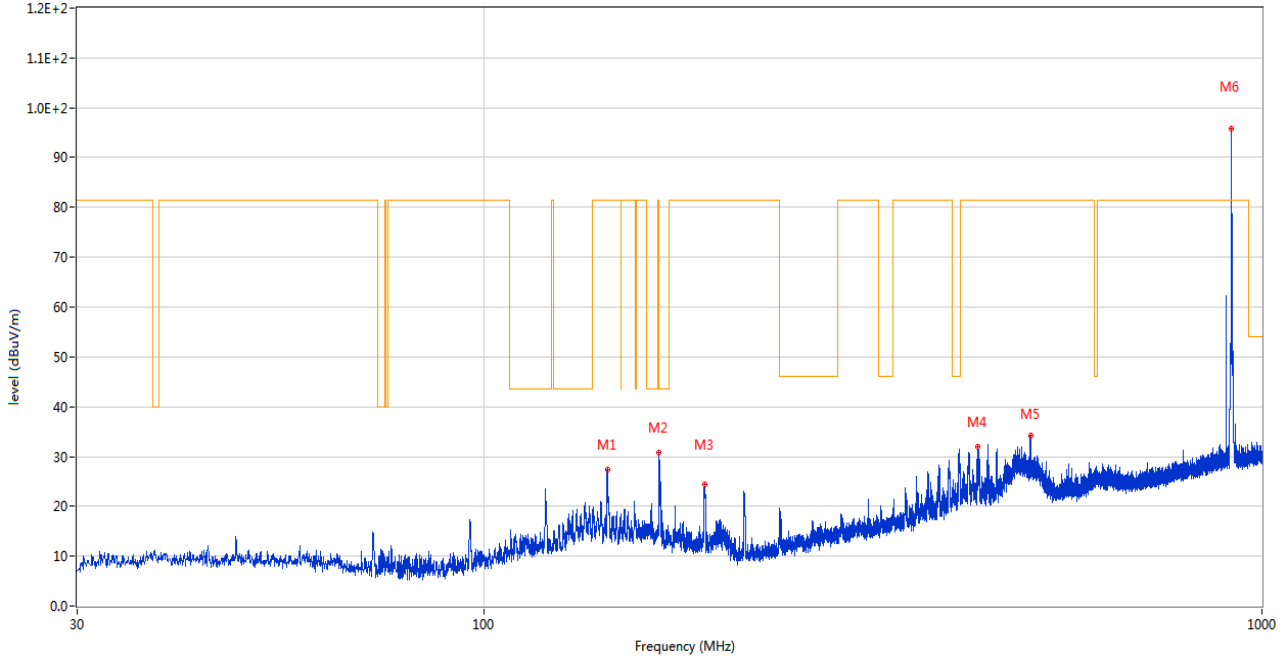

No.	Frequency (MHz)	Results (dBuV/m)	Factor (dB)	Limit (dBuV/m)	Over Limit (dB)	Detector	Table (Degree)	Height (cm)	Antenna	Verdict
1	144.024	27.44	-24.34	43.5	-16.06	Peak	276.00	100	Horizontal	Pass
2	167.982	30.73	-24.11	43.5	-12.77	Peak	249.00	100	Horizontal	Pass
3	191.990	24.46	-26.85	81.5	-57.04	Peak	123.00	200	Horizontal	Pass
4	431.629	32.00	-18.20	81.5	-49.50	Peak	96.00	100	Horizontal	Pass
5	503.990	34.32	-16.14	81.5	-47.18	Peak	325.00	100	Horizontal	Pass
6	914.398	95.76	-7.16	81.5	14.26	Peak	263.00	100	Horizontal	N/A

HIGH CHANNEL, ANT V

RE Test case_FCC Part 15C_FCC 15.247(902-928MHz)_30MHz-1GHz

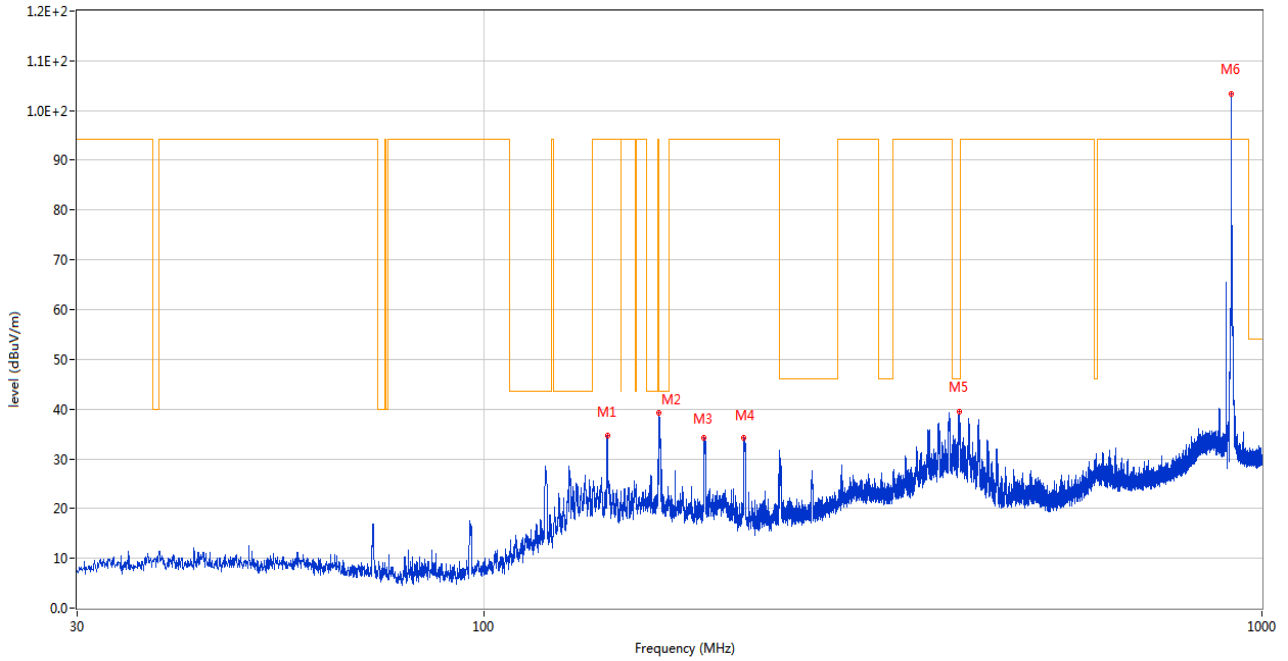

No.	Frequency (MHz)	Results (dBuV/m)	Factor (dB)	Limit (dBuV/m)	Over Limit (dB)	Detector	Table (Degree)	Height (cm)	Antenna	Verdict
1	144.024	34.58	-24.34	43.5	-8.92	Peak	176.00	200	Vertical	Pass
2	167.982	39.22	-24.11	43.5	-4.28	Peak	163.00	200	Vertical	Pass
3	191.796	34.17	-26.80	94.5	-60.33	Peak	321.00	100	Vertical	Pass
4	215.658	34.13	-26.29	94.5	-60.37	Peak	315.00	100	Vertical	Pass
5	408.300	39.36	-19.02	46.0	-6.64	Peak	342.00	100	Vertical	Pass
6	914.446	103.43	-7.16	94.5	8.93	Peak	293.00	100	Vertical	N/A

LOW CHANNEL 1 GHz to 10 GHz, ANT H

RE Test case_FCC Part 15C_FCC 15.247(902-928)_1GHz-10GHz

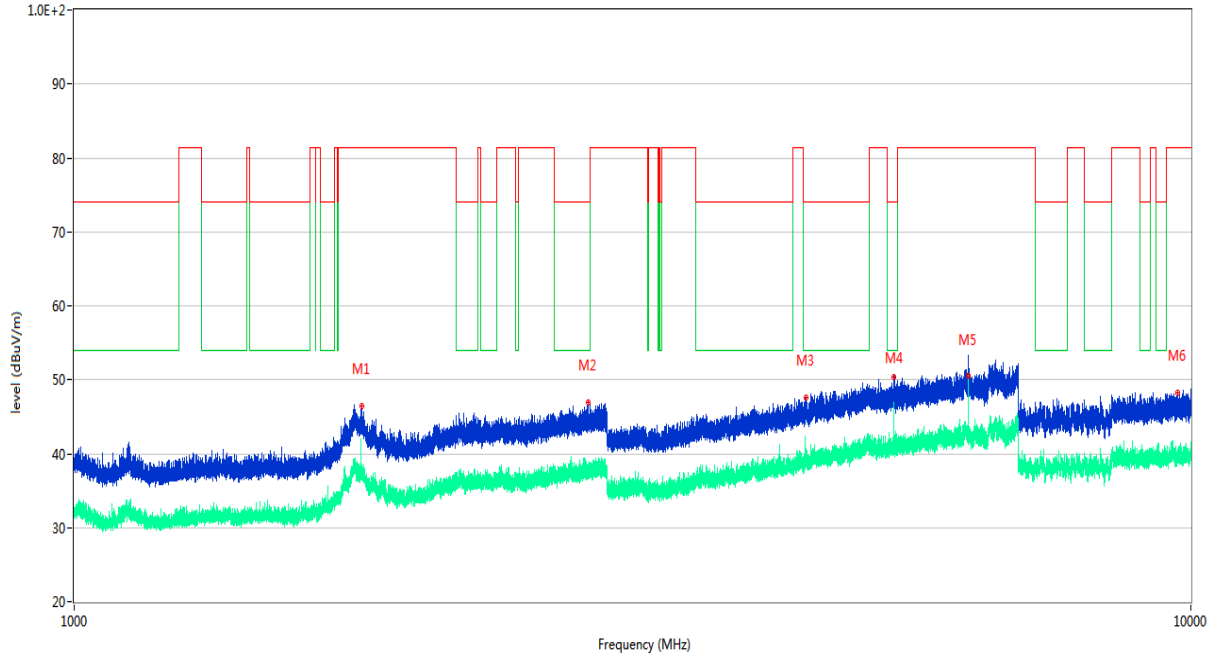

No.	Frequency (MHz)	Results (dBuV/m)	Factor (dB)	Limit (dBuV/m)	Over Limit (dB)	Detector	Table (Degree)	Height (cm)	Antenna	Verdict
1	1809.400	46.45	-8.55	81.4	-34.95	Peak	178.00	150	Horizontal	Pass
1**	1809.400	37.88	-8.55	81.4	-43.52	AV	178.00	150	Horizontal	Pass
2	2884.500	46.94	-5.80	74.0	-27.06	Peak	121.00	150	Horizontal	Pass
2**	2884.500	37.62	-5.80	54.0	-16.38	AV	121.00	150	Horizontal	Pass
3	4522.000	47.59	-3.81	74.0	-26.41	Peak	360.00	150	Horizontal	Pass
3**	4522.000	39.94	-3.81	54.0	-14.06	AV	360.00	150	Horizontal	Pass
4	5417.000	50.37	-2.79	74.0	-23.63	Peak	203.00	150	Horizontal	Pass
4**	5417.000	43.56	-2.79	54.0	-10.44	AV	203.00	150	Horizontal	Pass
5	6320.000	52.86	-1.45	81.4	-28.54	Peak	203.00	150	Horizontal	Pass
5**	6320.000	50.51	-1.45	81.4	-30.89	AV	203.00	150	Horizontal	Pass
6	9730.099	48.19	-0.51	81.4	-33.21	Peak	34.00	150	Horizontal	Pass
6**	9730.099	39.71	-0.51	81.4	-41.69	AV	34.00	150	Horizontal	Pass

LOW CHANNEL 1 GHz to 10 GHz, ANT H

RE Test case_FCC Part 15C_FCC 15.247(902-928)_1GHz-10GHz

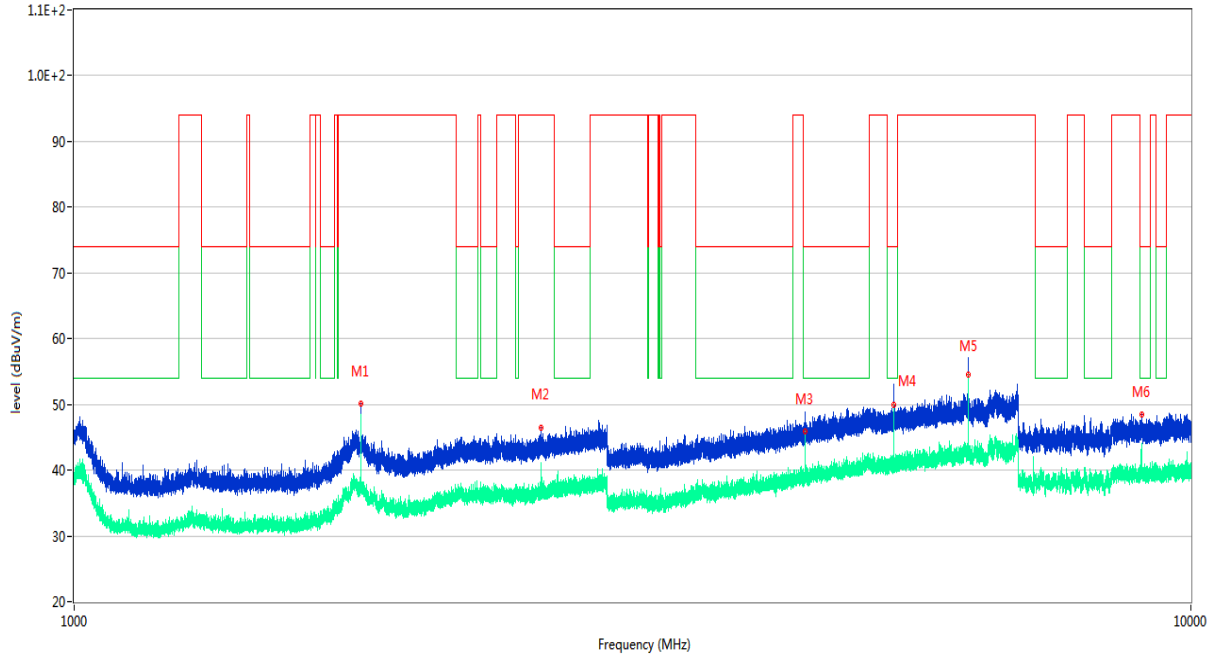

No.	Frequency (MHz)	Results (dBuV/m)	Factor (dB)	Limit (dBuV/m)	Over Limit (dB)	Detector	Table (Degree)	Height (cm)	Antenna	Verdict
1	1805.500	50.13	-8.71	94.1	-43.97	Peak	82.00	150	Vertical	Pass
1**	1805.500	47.13	-8.71	94.1	-46.97	AV	82.00	150	Vertical	Pass
2	2620.300	46.37	-8.09	94.1	-47.73	Peak	152.00	150	Vertical	Pass
2**	2620.300	38.68	-8.09	94.1	-55.42	AV	152.00	150	Vertical	Pass
3	4516.400	48.27	-3.72	74.0	-25.73	Peak	206.00	150	Vertical	Pass
3**	4516.400	45.96	-3.72	54.0	-8.04	AV	206.00	150	Vertical	Pass
4	5417.400	52.09	-2.78	74.0	-21.91	Peak	58.00	150	Vertical	Pass
4**	5417.400	49.95	-2.78	54.0	-4.05	AV	58.00	150	Vertical	Pass
5	6320.800	55.65	-1.46	94.1	-38.45	Peak	58.00	150	Vertical	Pass
5**	6320.800	54.48	-1.46	94.1	-39.62	AV	58.00	150	Vertical	Pass
6	9031.474	48.41	-0.82	74.0	-25.59	Peak	79.00	150	Vertical	Pass
6**	9031.474	42.60	-0.82	54.0	-11.40	AV	79.00	150	Vertical	Pass

MIDDLE CHANNEL 1 GHz to 10 GHz, ANT H

RE Test case_FCC Part 15C_FCC 15.247(902-928)_1GHz-10GHz

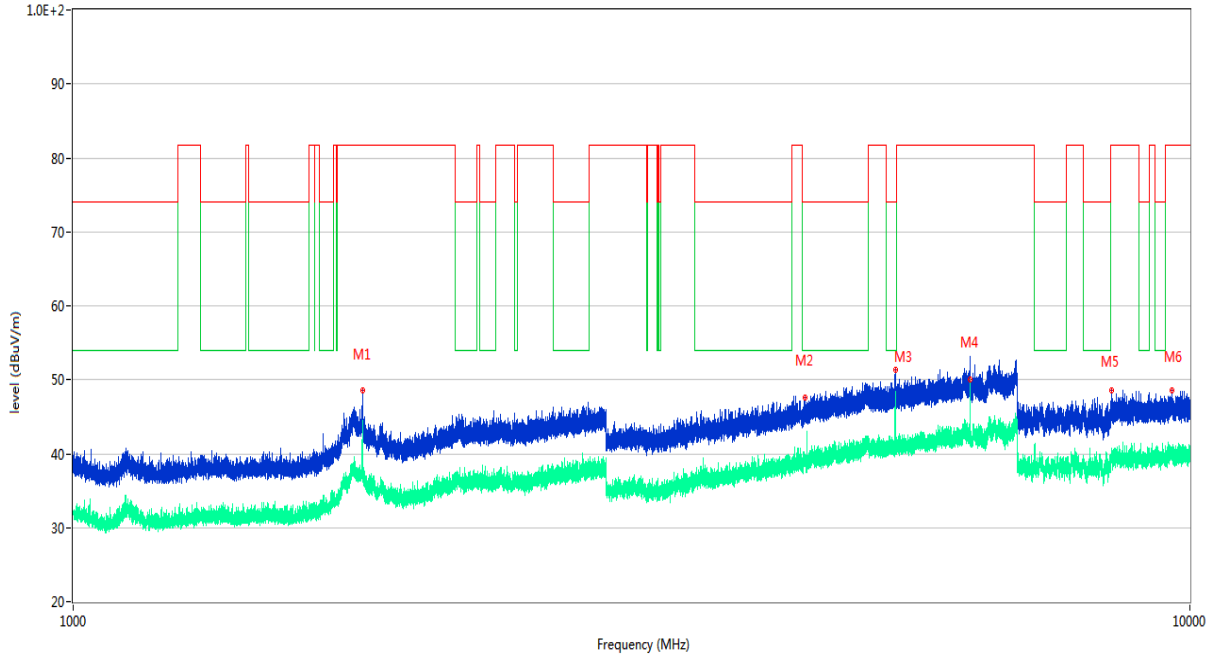

No.	Frequency (MHz)	Results (dBuV/m)	Factor (dB)	Limit (dBuV/m)	Over Limit (dB)	Detector	Table (Degree)	Height (cm)	Antenna	Verdict
1	1815.900	48.55	-8.71	81.7	-33.15	Peak	332.00	150	Horizontal	Pass
1**	1815.900	44.55	-8.71	81.7	-37.15	AV	332.00	150	Horizontal	Pass
2	4523.600	47.62	-3.80	74.0	-26.38	Peak	242.00	150	Horizontal	Pass
2**	4523.600	39.36	-3.80	54.0	-14.64	AV	242.00	150	Horizontal	Pass
3	5448.200	51.31	-2.36	74.0	-22.69	Peak	216.00	150	Horizontal	Pass
3**	5448.200	48.48	-2.36	54.0	-5.52	AV	216.00	150	Horizontal	Pass
4	6354.400	53.15	-1.95	81.7	-28.55	Peak	216.00	150	Horizontal	Pass
4**	6354.400	50.10	-1.95	81.7	-31.60	AV	216.00	150	Horizontal	Pass
5	8503.338	48.49	-1.34	81.7	-33.21	Peak	140.00	150	Horizontal	Pass
5**	8503.338	39.03	-1.34	81.7	-42.67	AV	140.00	150	Horizontal	Pass
6	9640.688	48.60	-0.13	81.7	-33.10	Peak	199.00	150	Horizontal	Pass
6**	9640.688	40.00	-0.13	81.7	-41.70	AV	199.00	150	Horizontal	Pass

MIDDLE CHANNEL 1 GHz to 10 GHz, ANT V

RE Test case_FCC Part 15C_FCC 15.247(902-928)_1GHz-10GHz

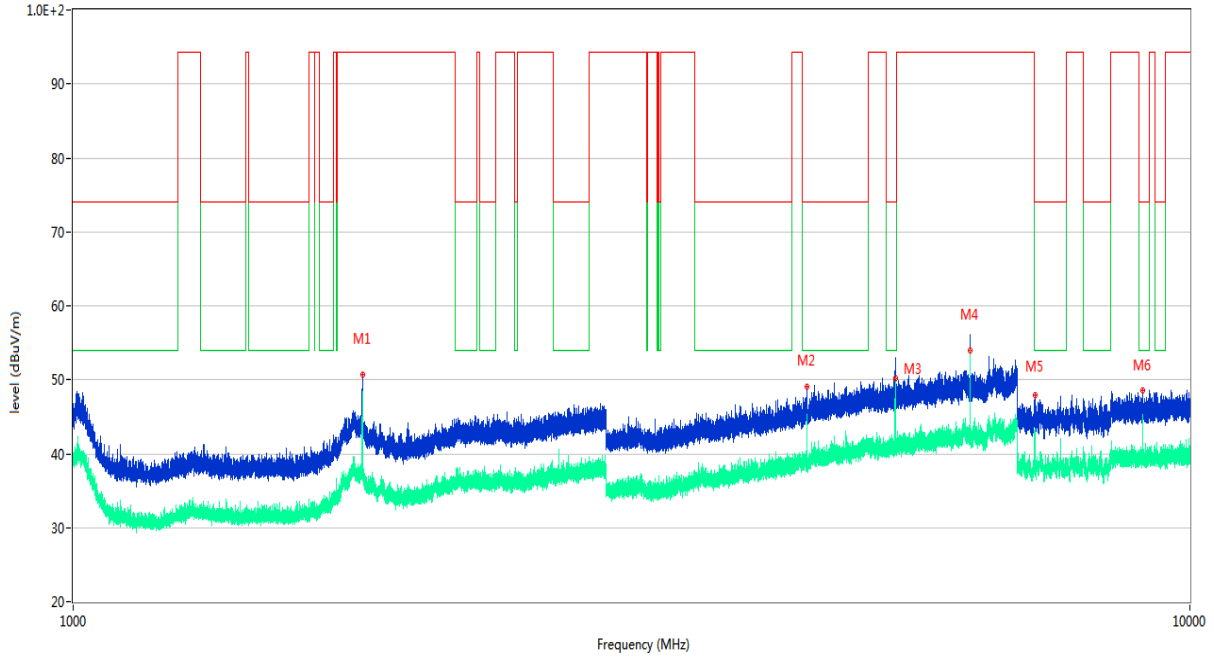

No.	Frequency (MHz)	Results (dBuV/m)	Factor (dB)	Limit (dBuV/m)	Over Limit (dB)	Detector	Table (Degree)	Height (cm)	Antenna	Verdict
1	1815.800	50.63	-8.71	94.3	-43.67	Peak	76.00	150	Vertical	Pass
1**	1815.800	48.00	-8.71	94.3	-46.30	AV	76.00	150	Vertical	Pass
2	4540.200	49.12	-4.32	74.0	-24.88	Peak	236.00	150	Vertical	Pass
2**	4540.200	44.62	-4.32	54.0	-9.38	AV	236.00	150	Vertical	Pass
3	5447.000	51.41	-2.42	74.0	-22.59	Peak	72.00	150	Vertical	Pass
3**	5447.000	50.21	-2.42	54.0	-3.79	AV	72.00	150	Vertical	Pass
4	6355.000	55.01	-1.98	94.3	-39.29	Peak	97.00	150	Vertical	Pass
4**	6355.000	53.91	-1.98	94.3	-40.39	AV	97.00	150	Vertical	Pass
5	7263.638	48.00	-3.03	74.0	-26.00	Peak	2.00	150	Vertical	Pass
5**	7263.638	42.24	-3.03	54.0	-11.76	AV	2.00	150	Vertical	Pass
6	9080.637	48.56	-1.41	74.0	-25.44	Peak	183.00	150	Vertical	Pass
6**	9080.637	45.37	-1.41	54.0	-8.63	AV	183.00	150	Vertical	Pass

HIGH CHANNEL 1 GHz to 10 GHz, ANT H

RE Test case_FCC Part 15C_FCC 15.247(902-928)_1GHz-10GHz

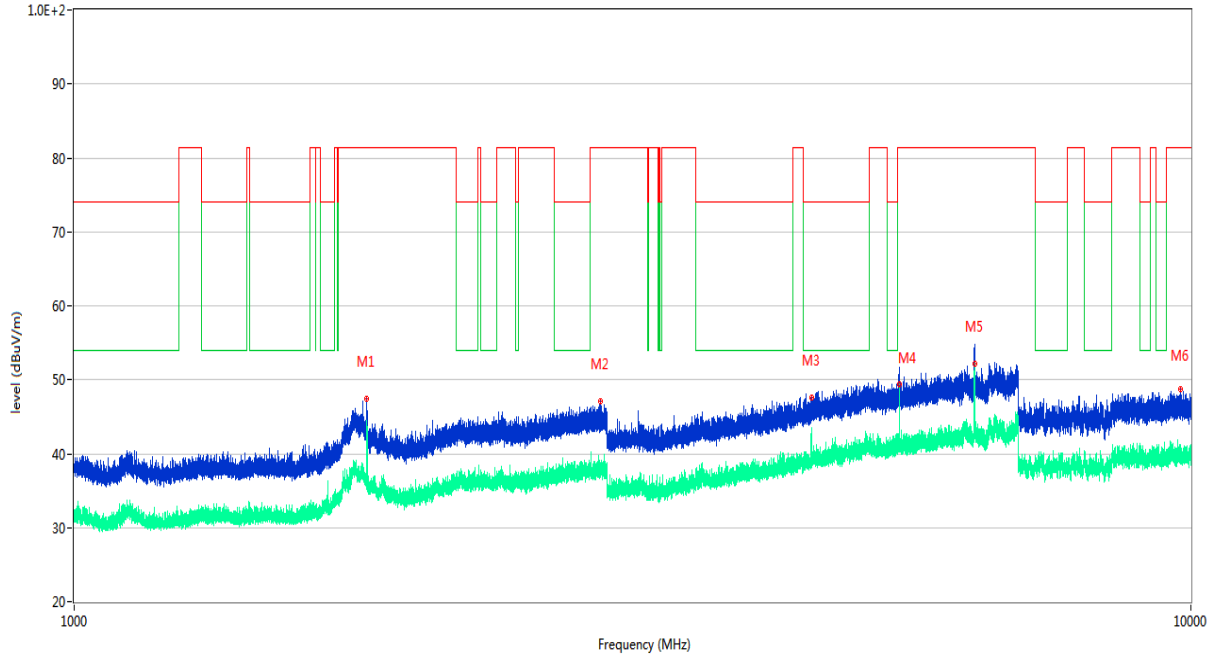

No.	Frequency (MHz)	Results (dBuV/m)	Factor (dB)	Limit (dBuV/m)	Over Limit (dB)	Detector	Table (Degree)	Height (cm)	Antenna	Verdict
1	1829.100	47.41	-10.02	81.5	-34.09	Peak	347.00	150	Horizontal	Pass
1**	1829.100	42.85	-10.02	81.5	-38.65	AV	347.00	150	Horizontal	Pass
2	2958.100	47.02	-5.73	81.5	-34.48	Peak	277.00	150	Horizontal	Pass
2**	2958.100	38.04	-5.73	81.5	-43.46	AV	277.00	150	Horizontal	Pass
3	4571.600	47.67	-3.96	74.0	-26.33	Peak	212.00	150	Horizontal	Pass
3**	4571.600	43.58	-3.96	54.0	-10.42	AV	212.00	150	Horizontal	Pass
4	5485.000	50.95	-2.49	81.5	-30.55	Peak	212.00	150	Horizontal	Pass
4**	5485.000	49.41	-2.49	81.5	-32.09	AV	212.00	150	Horizontal	Pass
5	6400.600	53.57	-1.12	81.5	-27.93	Peak	225.00	150	Horizontal	Pass
5**	6400.600	52.11	-1.12	81.5	-29.39	AV	225.00	150	Horizontal	Pass
6	9791.912	48.76	-0.30	81.5	-32.74	Peak	219.00	150	Horizontal	Pass
6**	9791.912	40.45	-0.30	81.5	-41.05	AV	219.00	150	Horizontal	Pass

HIGH CHANNEL 1 GHz to 10 GHz, ANT V

RE Test case_FCC Part 15C_FCC 15.247(902-928)_1GHz-10GHz

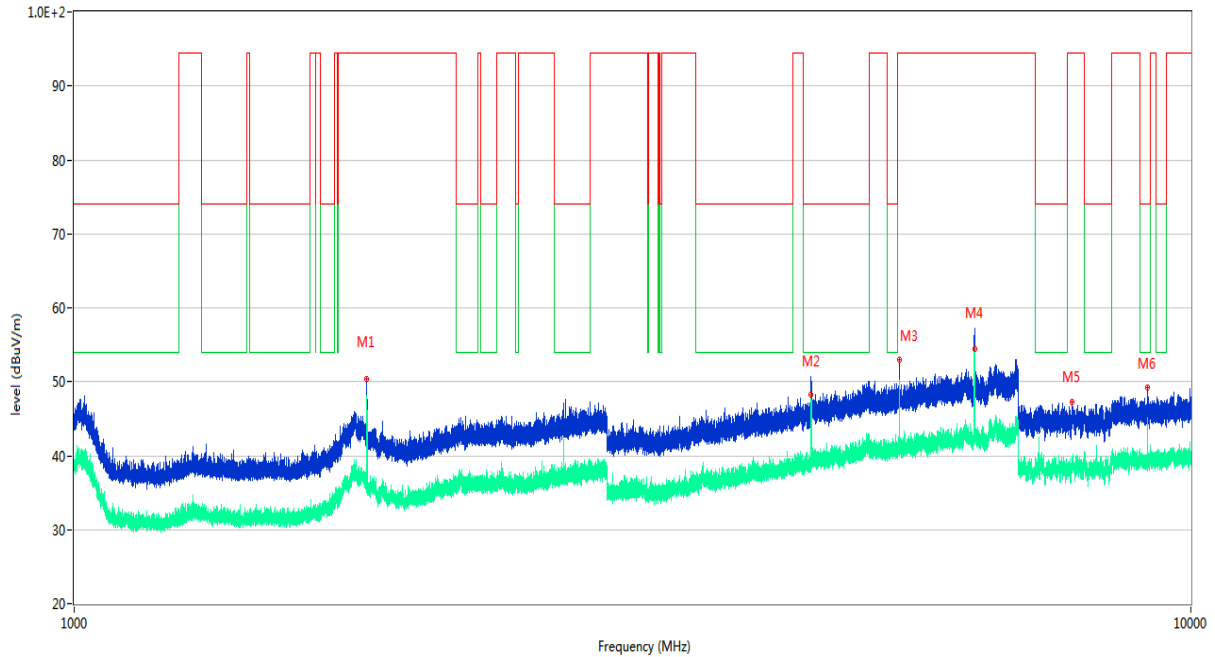

No.	Frequency (MHz)	Results (dBuV/m)	Factor (dB)	Limit (dBuV/m)	Over Limit (dB)	Detector	Table (Degree)	Height (cm)	Antenna	Verdict
1	1828.600	50.37	-9.98	94.5	-44.13	Peak	71.00	150	Vertical	Pass
1**	1828.600	46.60	-9.98	94.5	-47.90	AV	71.00	150	Vertical	Pass
2	4612.400	48.23	-4.13	74.0	-25.77	Peak	360.00	150	Vertical	Pass
2**	4612.400	38.92	-4.13	54.0	-15.08	AV	360.00	150	Vertical	Pass
3	5485.400	53.04	-2.48	94.5	-41.46	Peak	68.00	150	Vertical	Pass
3**	5485.400	48.71	-2.48	94.5	-45.79	AV	68.00	150	Vertical	Pass
4	6401.000	56.33	-1.10	94.5	-38.17	Peak	30.00	150	Vertical	Pass
4**	6401.000	54.52	-1.10	94.5	-39.98	AV	30.00	150	Vertical	Pass
5	7828.862	47.28	-2.35	94.5	-47.22	Peak	36.00	150	Vertical	Pass
5**	7828.862	38.66	-2.35	94.5	-55.84	AV	36.00	150	Vertical	Pass
6	9144.750	49.24	-1.45	74.0	-24.76	Peak	219.00	150	Vertical	Pass
6**	9144.750	44.04	-1.45	54.0	-9.96	AV	219.00	150	Vertical	Pass

A.7 Band Edge (Restricted-band band-edge)

Note¹: The lowest and highest channels are tested to verify the band edge emissions. Please refer to the following the plots for emissions values.

Note²: The test data all are tested in the vertical and horizontal antenna which the trace is max hold. So these plots have shown the worst case.

Note³: According the ANSI C63.10-2013, where limits are specified for both average and peak (or quasi-peak) detector functions, if the peak (or quasi-peak) measured value complies with the average limit, it is unnecessary to perform an average measurement.

Note⁴: The Level (dBuV/m) has been corrected by factor.

Test Mode	Test Channel	Frequency (MHz)	Level (dBuV/m)	Factor (dB)	Limit Line (dBuV/m)	Margin (dB)	Remark	Verdict
LoRa	Low	614	43.394	3.16	74	30.606	PEAK	Pass
		614	N/A	N/A	54	N/A	AVERAGE	Pass
LoRa	High	960	48.625	28.00	74	25.375	PEAK	Pass
		960	N/A	N/A	54	N/A	AVERAGE	Pass

LOW CHANNEL, PEAK

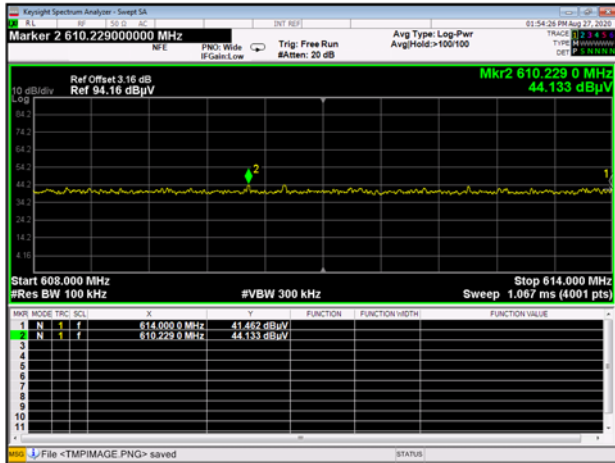

HIGH CHANNEL, PEAK

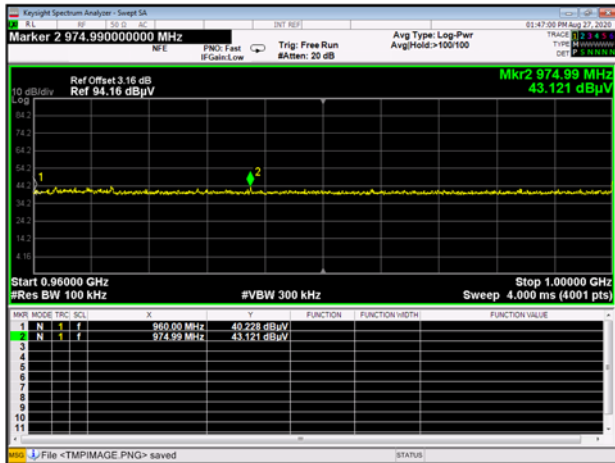

HIGH CHANNEL, AV

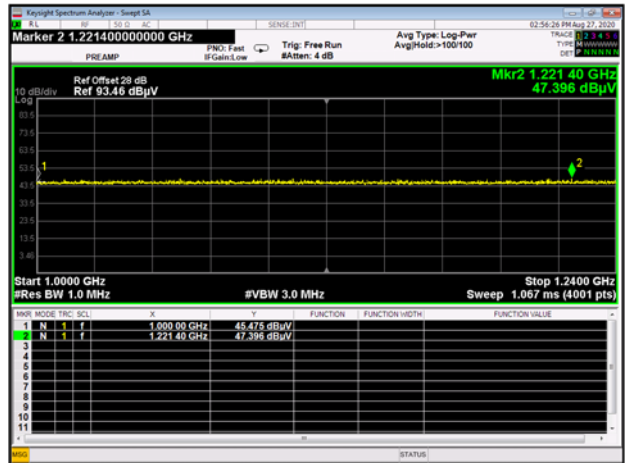

A.8 Power Spectral Density (PSD)

Test Data

Channel	Spectral power density (dBm/3kHz)	Limit (dBm/3kHz)	Verdict
Low Channel	-5.34	8	Pass
Middle Channel	-5.37	8	Pass
High Channel	-5.26	8	Pass

Test plots

LOW CHANNEL

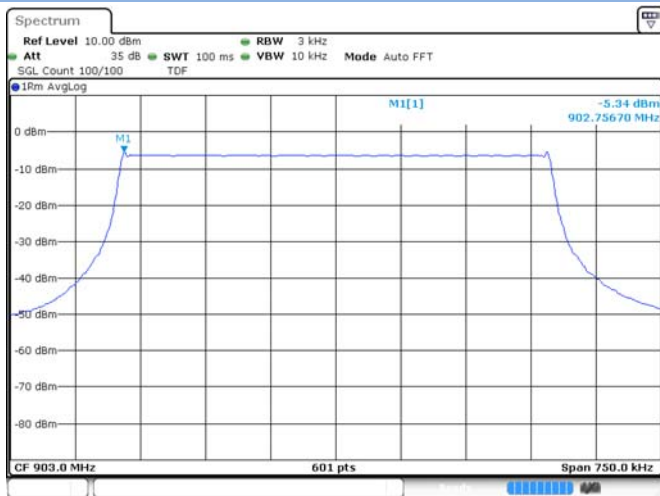

Date: 10.NOV.2020 18:48:32

MIDDLE CHANNEL

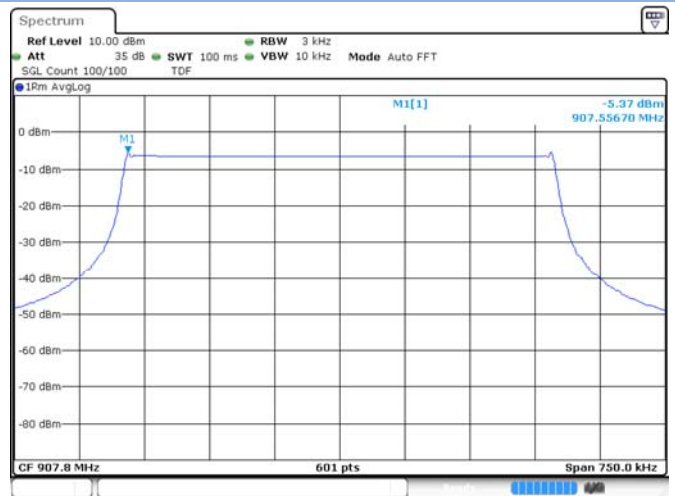

Date: 10.NOV.2020 18:59:16

HIGH CHANNEL

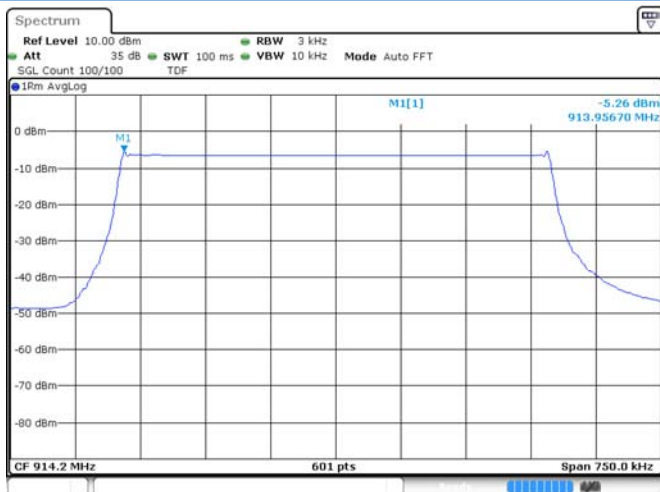

Date: 10.NOV.2020 19:07:53

ANNEX B TEST SETUP PHOTOS

Please refer the document "BL-SZ2080372-AR.PDF".

ANNEX C EUT EXTERNAL PHOTOS

Please refer the document "BL-SZ2080372-AW.PDF".

ANNEX D EUT INTERNAL PHOTOS

Please refer the document "BL-SZ2080372-AI.PDF".

--END OF REPORT--