

14+
AGES

Instruction Manual Quad-rotor

PIONEER UFO



Important note:

In order to you more easily, more skilled, more secure operation The aircraft, please read this manual carefully, At the same time, please keep this instruction manual for the day. After reference.

Chart indicating each key function on the transmitter

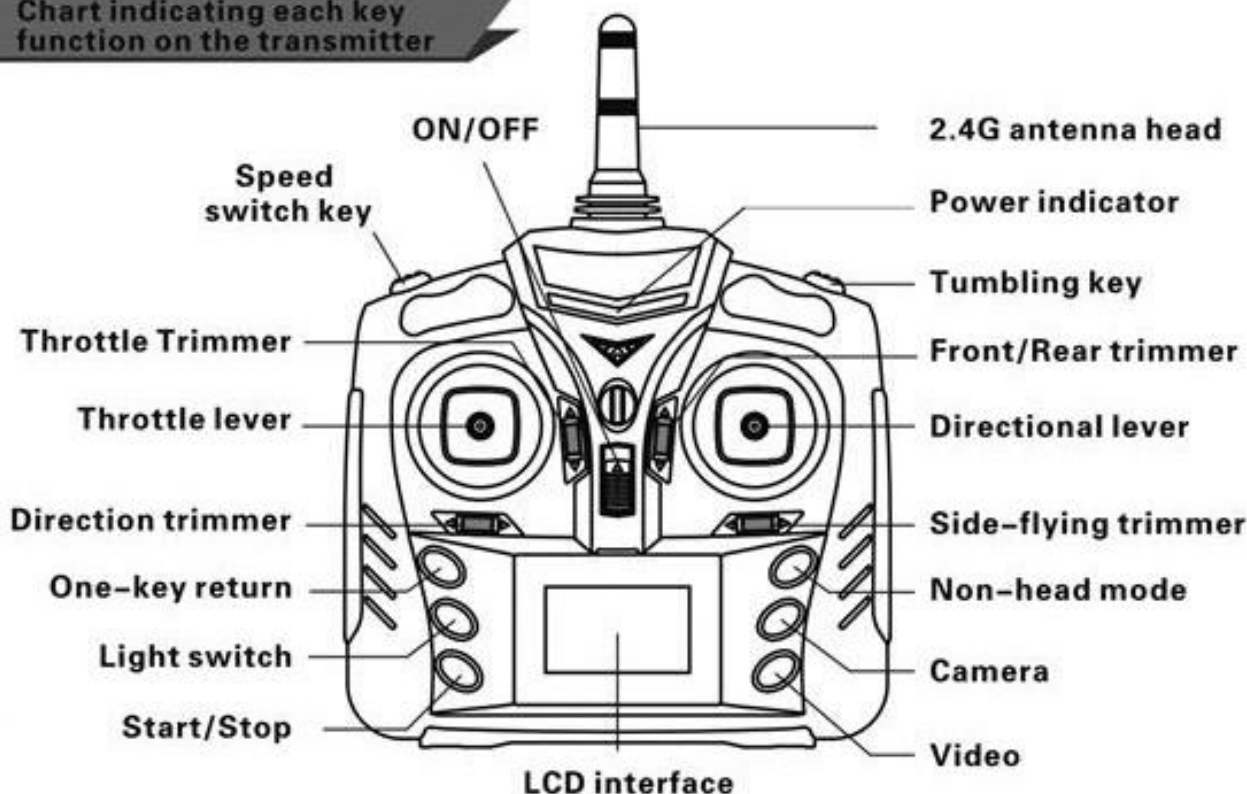

List of product configuration and parameters:

<p>Configuration list: aircraft x 1, remote control x 1, 3.7V lithium-ion battery (built-in), Screwdriver x 1, USB x 1, Instruction manual x 1, Attached to the blades x 1 Set of.</p>	
<p>Aircraft battery: 3.7V600mA lithium batteries (built-in)</p>	<p>Remote control radius: 80 meters</p>
<p>The remote control battery: 4 grain of 1.5 v "AA" battery (Another purchase)</p>	<p>The flying time: about 6 minutes</p>
<p>Aircraft size: Length 316mm * Width 316mm * High 106mm</p>	<p>Aircraft weight: 130 g</p>



Warning:

- *Please follow the instruction or packing instructions for proper installation and use. Some parts are assembled by the adult.
- *The product contains small parts, eating or possible choking hazard
- *Please put away the packing material in time, so as not to cause harm to children.
- *Need to regularly check the charger, wire, plug, shell and other components, found that damage, should stop using, until the repair.
- *The charger, the battery pack, and the charging device must be inserted in the same power as the product labeling.
- *Can only use the original configuration of the charger, the charger is not a toy.
- *Clean toys should be disconnected from the charger.
- *Non rechargeable battery.
- *When charging the rechargeable battery, the need for adult guardianship.
- *Do not mix old and new batteries or batteries of different types, the exhaustion of the battery should be promptly removed.
- *Do not short-circuit the battery, break down, or fall into the fire.
- *Long time does not control the product, please take out the battery.
- *Do not touch the rotating parts, to avoid causing harm to the body
- *Please do not serious impact or drop aircraft and remote control.
- *Clean the product with a clean, soft cloth.
- *Users are responsible for ensuring that the product will not cause damage to itself or others, and that the manufacturer or distributor does not take any responsibility for the operation of the damage caused by improper operation of their own or other people's safety.
- *The package and the instruction manual contain the important information of the product, please keep it.

Battery installation

1. As the picture shown, please unload the battery cover of the transmitter. Load 4PCS "AA" batteries (not included) as the correct polarity shown in the battery compartment, and then load the battery cover and tightly wrench the screw.



Caution: a. When loading batteries, please load the batteries as per the correct "+" "-" polarity shown on the battery compartment. Please DO NOT load them upside down.
b. Please DO NOT mix using the old batteries with the new ones or mix batteries of different types or brands.

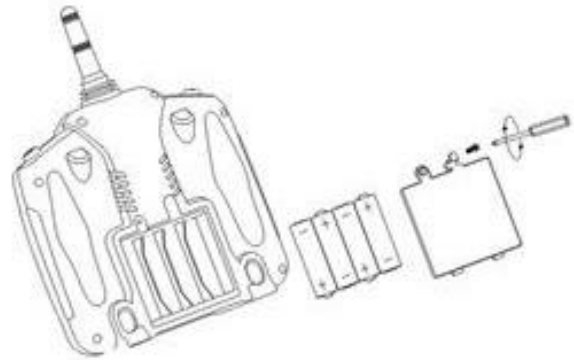

Charging instruction of lithium battery

(Please remove the batteries from the aircraft before charging)

- 1, Insert the USB charging cable has turned on the computer USB interface, the USB light is lit up at this time.
- 2, And then the USB charging connection wire and the other end of the battery plug connection, at this time the USB indicator light goes out, said it is charging
- 3, Charging 1.2 hours or so, USB lights up, indicating that the charge is completed, please disconnect all the connections and put in a safe place.

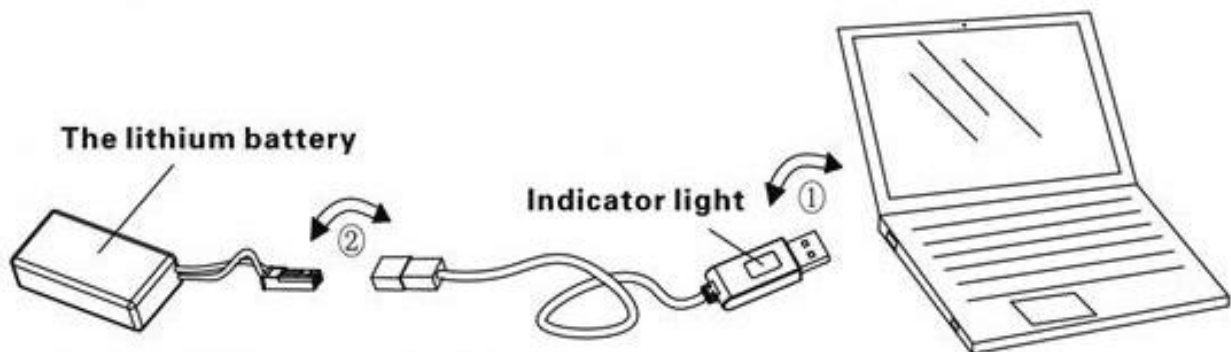

Related matters needing attention in the use of lithium batteries:

- A, charging, the staff do not leave and charging time is not too long, charging process found the battery, please stop charging, avoid battery damage or fire, etc..
- B, do not put the battery in the inflammable and explosive goods next to charge, when the battery in the use or charging process, once the smell or battery suddenly become hot, deformation, discoloration and other abnormal phenomenon, please stop using the battery.
- C, if the battery leaks, avoid contact with skin and eyes. If contact with skin and eyes, rinse immediately with plenty of cold water and immediately seek medical attention.
- D, can only use the original charger to charge the product to the product, and determine the charger voltage to meet your local standards.
- E, do not put the battery into the fire, microwave or pressure tank.
- F, please do not use solvents, industrial alcohol or other flammable solvents to clean the product and the charger.
- G, products include plastic, electronic components and battery components, please do not use such items as daily garbage disposal, please according to the local garbage collection requirements, the classification process.

Preparation before operating the aircraft.

1. Battery loading and power connection: Load the battery into the battery compartment as the picture A shown and then well connects with the power plug.
Caution: When connecting the power plug, please do recognize well the "+" "-" polarity, say red line to red line.

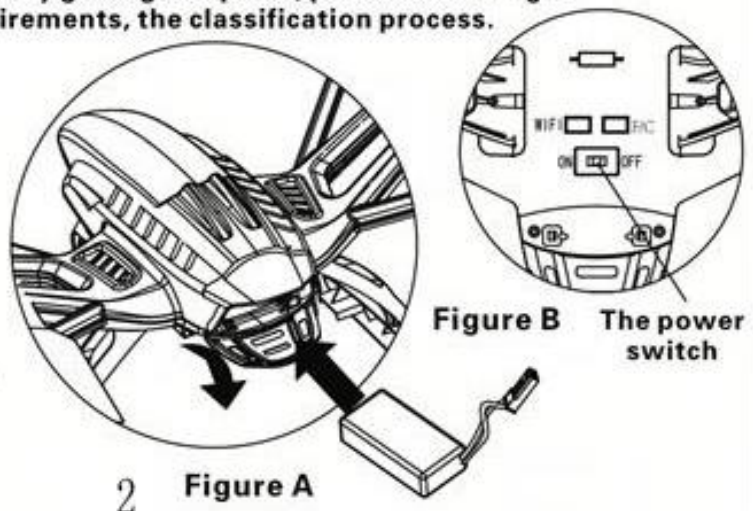

2 Figure A

Figure B The power switch

Decoding operation:

1. When connecting correctly with the power plug, please point the tail part of the aircraft to yourself and place it on the flat ground. This time the light on the aircraft will be flashing quickly and please **DO NOT** move the fuselage.
2. Switch on the transmitter, this time you will hear two sound of "di, di" sending out from the transmitter. Then please push the throttle lever to the highest position. The LED light on the aircraft will be flashing slowly, and then please pull it to the lowest position and you will hear "di" sound sending out from the transmitter, the power indicator of the transmitter and the LED light of the aircraft will show eternal bright, which represents decoding is successfully made and you can control the aircraft.

START/STOP operating method of the aircraft:

(Applies only to 509 set high version, the ordinary version without this feature)

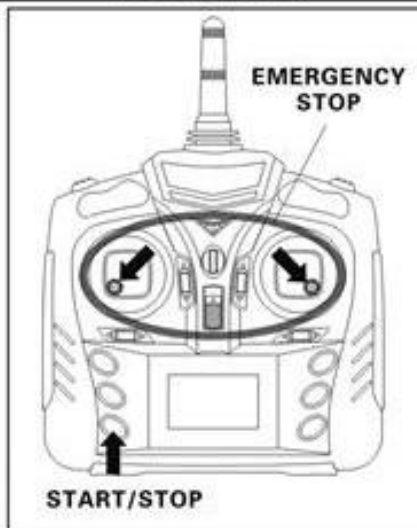

A. START/STOP:

1. Press "START/STOP" key to start the aircraft. This time the motor of the aircraft will be running slowly. Push upward the throttle lever, the aircraft will take off.
2. Press "START/STOP" key during the course of flying, the aircraft will be landing slowly until landing on the ground and stop flying.

B. EMERGENCY STOP:





In the case that it is fallen off by accident or meeting the danger during the course of flying, please pull the throttle lever to the left down corner and also the direction lever to the right down corner in the same time in order to start the EMERGENCY STOP as the picture shown. This time the aircraft will stop working very quickly.

Tips on Height Setting: Push upward the throttle lever and the aircraft will be ascending to the assigned height. Then please loosen the throttle lever and the aircraft will be flying steadily as per this height.

Instruction on normal flying control of the aircraft:

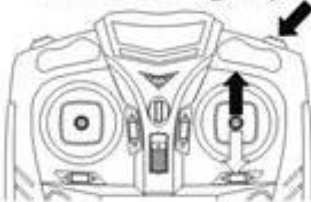
	<p>Ascending</p> <p>Descending</p>	<p>When pushing the throttle lever upward, the aircraft will be ascending;</p> <p>When the throttle lever is pushed down, the aircraft drops;</p>
	<p>Turn-left</p> <p>Turn-right</p>	<p>When pushing the throttle lever to the left, the aircraft will be turning left.</p> <p>When the throttle lever is pushed to the right, the aircraft turn right.</p>
	<p>Forward</p> <p>Backward</p>	<p>When pushing the direction lever upward, the aircraft will be advancing forward.</p> <p>When the direction of the lever back to pull down the aircraft.</p>
	<p>Left-side flying</p> <p>Right-side flying</p>	<p>When pushing the direction lever to the left, the aircraft will be flying to the left side.</p> <p>When the direction of the joystick to the right, aircraft fly on the right side.</p>

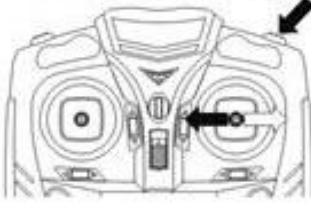
Instruction on tumbling control of the aircraft.

<p>Firstly please press the Tumbling Key</p> 	<p>Tumbling forward</p>  <p>Tumbling backward</p> 	<p>When pushing the direction lever upward, the aircraft will be tumbling forward.</p> <p>When the direction of the lever is pulled down, the aircraft turn.</p>
<p>Firstly please press the Tumbling Key</p> 	<p>Tumbling to the left</p>  <p>Tumbling to the right</p> 	<p>When the direction of the joystick to the left, the aircraft left turn</p> <p>When the direction of the joystick to the right, aircraft right turn.</p>

Tips: Please fly the aircraft to the height of 1.5meters or above, and then make the aircraft tumbling.

Instruction on Action Trimming of the aircraft:

Push slowly the throttle lever. When the aircraft ascending till about 1.5 meters, if the aircraft make spinning in the air or titling toward different direction, you can use Trimmer to correct the action.

Caution: When the aircraft flies 30cm above the ground, the aircraft may become unstable due to the turbulence produced by its own blade. This is called "Gravity Reaction". The lighter of the weight of the aircraft, the bigger affection of the "Gravity Reaction" it may be.

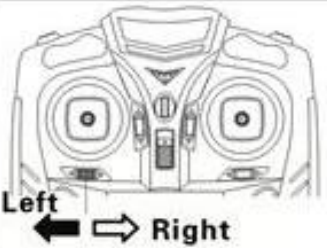
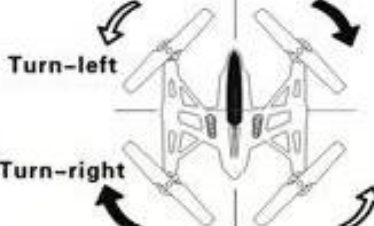
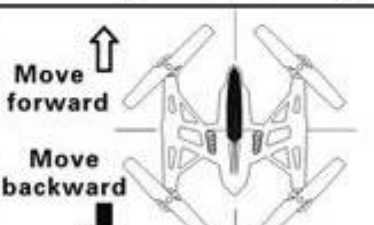
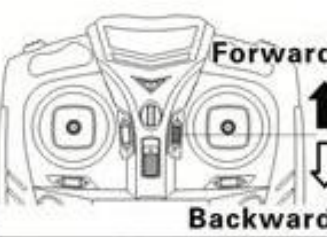
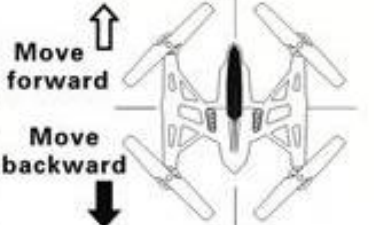
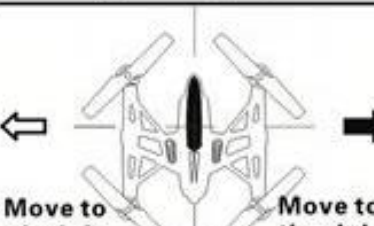
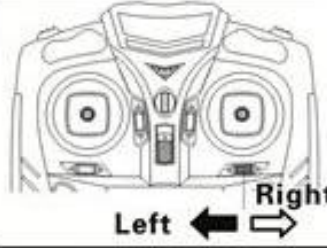
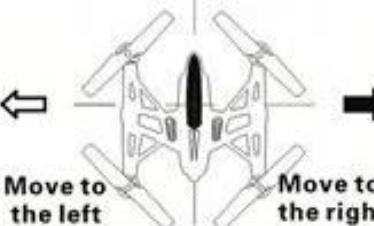
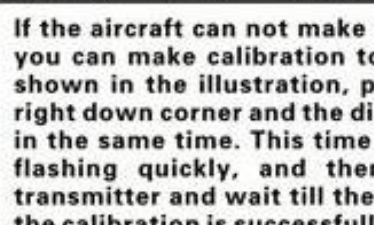
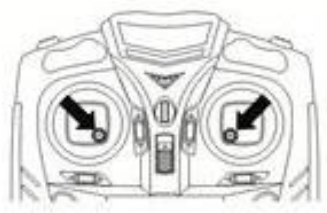
	<p>Turn-left</p>  <p>Turn-right</p> 	<p>When spinning to the left, please trim it to the right till it is well repaired.</p> <p>When the right spin, spinner left adjusted until repaired.</p>
<p>Forward</p>  <p>Backward</p>	<p>Move forward</p>  <p>Move backward</p> 	<p>When deviating toward forward, please trim it to the back until it is well repaired. when trimming to before adjustment, until repaired</p>
	<p>Move to the left</p>  <p>Move to the right</p> 	<p>When deviating to the left, please trim it to the right until it is well repaired.</p> <p>The bias to the right, fine-tuning adjustments to the left, until the repair.</p>
	<p>If the aircraft can not make vertical ascending when taking off, you can make calibration to the aircraft; As per the methods shown in the illustration, please pull the throttle lever to the right down corner and the direction lever to the left down corner in the same time. This time the indicator of the aircraft will be flashing quickly, and then loosen all the actions on the transmitter and wait till the indicator shows eternal bright and the calibration is successfully finished.</p>	

Operating method on the Non-head Mode of the aircraft:

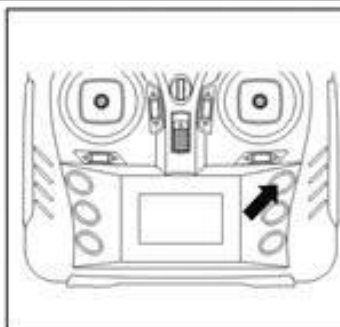

1. Before entering into the Non-head Mode, please well confirm the Forward direction of the decoding. Press the key for Non-head Mode, you will hear the transmitter sending out inter-mitten sound of "Di, Di, Di" , this time it enters into the Non-head Mode. No matter which direction the aircraft may rotate to, the flying direction will be as per the direction that the decoding is made.
2. If you need to exit from the Non-head Mode, please press the key for Non-head Mode once again. When hearing the sound of "Di, Di, Di" sending out from the transmitter, it will exit and enter into the Ordinary Mode.

Operating instruction on One-key Return of the aircraft:

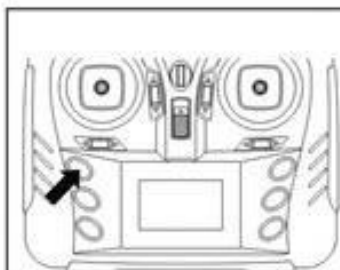

1. Press the "One-key Return" key, the transmitter will send out inter-mitten sound "Di, Di" , this time it has entered into the "One-key Return Mode" , the aircraft will be flying backward slowly as per the backward direction the decoding is made.
2. When the aircraft is flying too closed to you, please DO NOT press "One-key Return" key so as to avoid being wounded by accident due to carelessness.

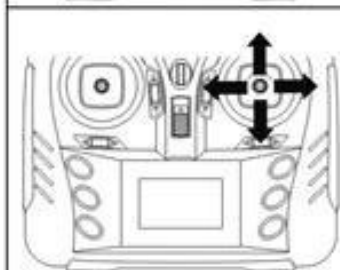

When entering "One-key Return Mode" , simply pushing the Direction Lever toward either direction(forward or backward or to the left or to the right) can exit from the "One-key Return Mode" .

Operating instruction on Camera/Video

(Only applicable to 509V)

1.Component installation:

1, according to the picture on the right camera components shown in "1" and the up Quasi fixed hooks, and then according to the picture on the right to "2" Before advancing fixed hooks.

2, according to the picture on the right position as shown in the connector plug correctly inserted into the aircraftAt the bottom of the F/C outlet

3, as shown in the right direction insert SD card right camera component SD card slot, gently press, SD card inserted, and then gently press, SD card automatically pop up.

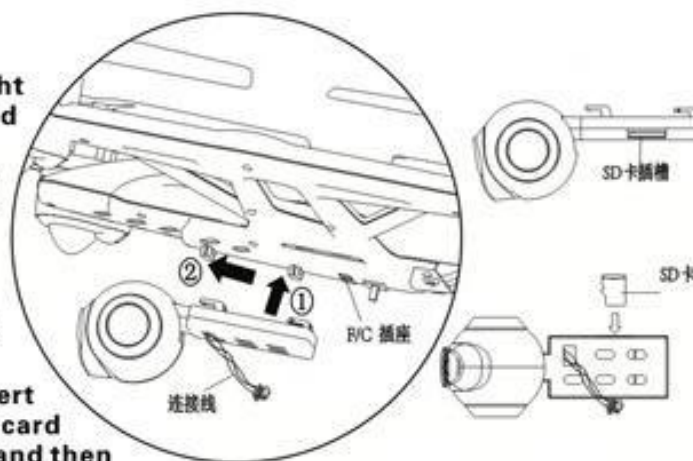

2. Taking picture:

Press the Camera Key on the transmitter, the blue indicator at the bottom of the aircraft will show eternal bright and the red indicator will be flashing for 2 times, which means that the aircraft has taken one picture and has automatically preserved the picture into the SD card.

3.Video shooting:

Press the Video key on the transmitter, the blue indicator at the bottom of the aircraft and the red indicator will both show eternal bright, it means that the aircraft is taking picture; then press the Video Key on the transmitter, the blue indicator and the red indicator at the bottom of the aircraft will be OFF, it means the aircraft has exited from the Video-shooting state and has automatically preserved the video into the SD Card. (Tips: When the blue indicator at the bottom of the aircraft appears eternal bright and the red indicator appears flashing, it means that the aircraft has been connected with power, however, no SD card is found or the SD is not well loaded.)

4. Read the content in the SD card:

Please switch off the power of the aircraft and then remove the SD card. The content can be read on the computer via the card reader or the SD card can be directly loaded into the mobile. Use the player with the corresponding format to play the video and also check the picture.

Precautions:

- 1, when the remote control or the aircraft power is low, the remote distance affected.
- 2, if the aircraft power is low, there will be flying high enough or take off difficult.
- 3, if the aircraft appeared damaged, deformation please timely repair, severe wind leaves broken or damaged do not fly, Doing so may result in injury.
- 4, the long-term is not used when the remote controller of the battery to prevent damage to the product from battery leakage.
- 5, cut can not let the aircraft crashed from a height or a serious collision, this will damage the aircraft or shorten the aircraft Life.
- 6, in order to ensure the stability of the aircraft, when the aircraft hit to the real object and then fall back, place the aircraft placed Level ground to stay for 2-3 seconds, until the aircraft automatic detection level, and then manipulate.

Problem Solving Guidelines:

Question	Reason	Treatment
Powered, can not control	1, Remote control and aircraft power supply bad	1, check and in accordance with the battery installation instructions to install Fully charged battery, and the code.
	2, the remote control and aircraft to code without success	2, according to the front of the code description, re code
Aircraft severe shock	1, the rotor deformation	1, the replacement of the new corresponding rotor
	2, hollow shaft bending	2, the replacement of the new hollow shaft
Aircraft from total flying to one side	1, the rotor deformation	1, the replacement of the new rotor
	2, there is a motor damage	2, the replacement of the new corresponding motor
	3, the code, the aircraft is not flat	3, the aircraft on the horizontal plane, the re code
Out of control	1, beyond effective remote control distance	1, please ensure that the radius of 100 meters control
	2, the code, there are a number of aircraft at the same time Open the power supply	2, please re code (multi aircraft to the code, the need to code one by one, to avoid the right or wrong or not)
Aircraft cannot rise	1, the rotor rotating speed is too slow	1, will throttle control lever slowly push up
	2, aircraft battery shortage	2, replace the full battery or battery full of power Re control
Aircraft landing too fast	Quickly back to the throttle lever	Let the aircraft fall, please slowly pull back the throttle control lever

Parts Picture:

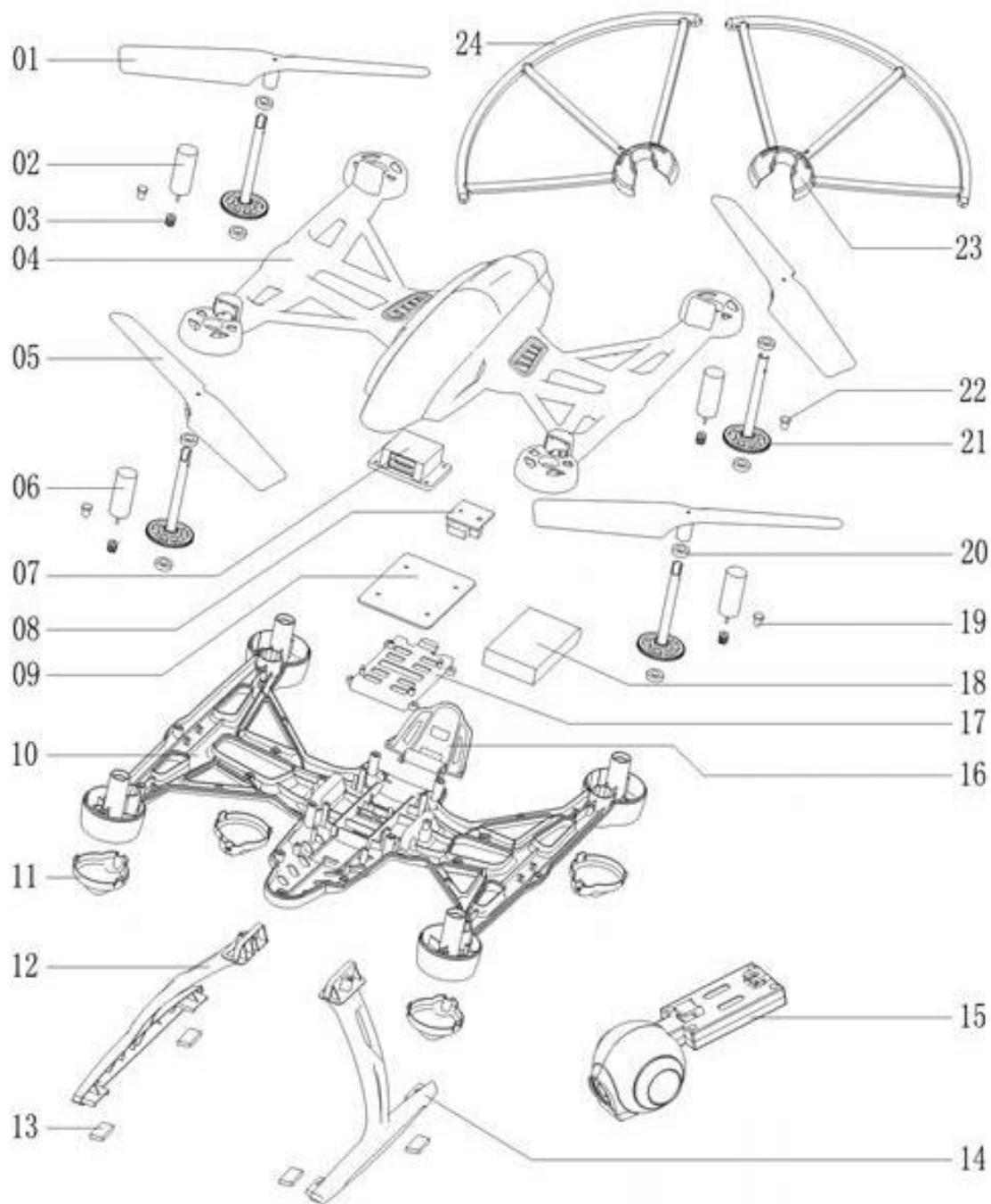

Serial number	The name of the accessories	Dosage	Serial number	The name of the accessories	Dosage	Serial number	The name of the accessories	Dosage
01	Forward blades	2	09	The main circuit board	1	17	Battery box	1
02	Forward motor	2	10	Under shell	1	18	Lithium battery	1
03	Motor gear	4	11	Lampshade	4	19	Blue light	2
04	On shell	1	12	Right foot rack	1	20	Bearing	8
05	Reverse blades	2	13	Cushion	4	21	Steel tube and drive tooth	4
06	Reverse motor	2	14	His left foot rack	1	22	White light	2
07	Gyroscope components	1	15	Camera Components	1	23	Left protective cover	2
08	Switch socket board	1	16	Battery cover	1	24	Right protective cover	2

NOTE: This equipment has been tested and found to comply with the limits for a Class B digital device, pursuant to part 15 of the FCC Rules. These limits are designed to provide reasonable protection against harmful interference in a residential installation. This equipment generates uses and can radiate radio frequency energy and, if not installed and used in accordance with the instructions, may cause harmful interference to radio communications. However, there is no guarantee that interference will not occur in a particular installation. If this equipment does cause harmful interference to radio or television reception, which can be determined by turning the equipment off and on, the user is encouraged to try to correct the interference by one or more of the following measures:

- Reorient or relocate the receiving antenna.
- Increase the separation between the equipment and receiver.
- Connect the equipment into an outlet on a circuit different from that to which the receiver is connected.
- Consult the dealer or an experienced radio/TV technician for help

Changes or modifications not expressly approved by the party responsible for compliance could void the user's authority to operate the equipment. This device complies with Part 15 of the FCC Rules. Operation is subject to the following two conditions:

- (1) this device may not cause harmful interference, and
- (2) this device must accept any interference received, including interference that may cause undesired operation.