

6

5

4

3

2

1

REVISION RECORD

LTR	ECO NO:	APPROVED:	DATE:

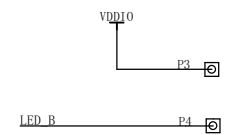
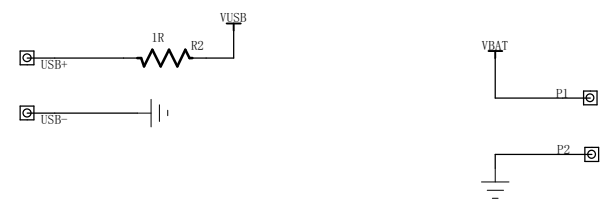
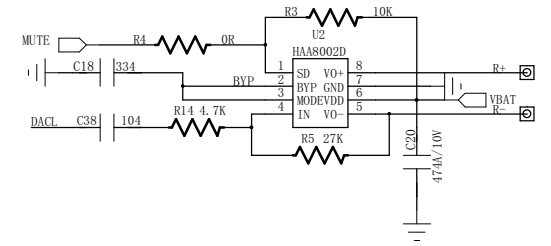
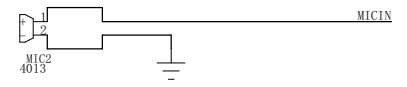
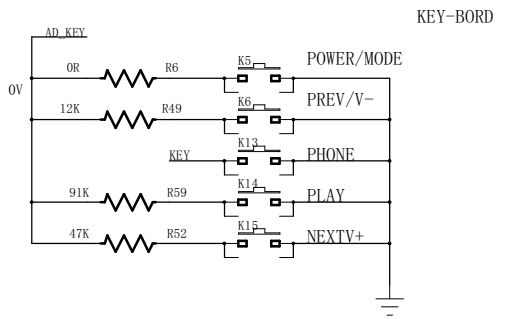
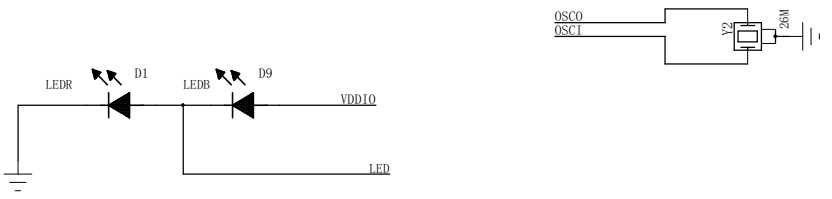
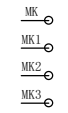
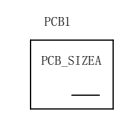
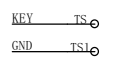
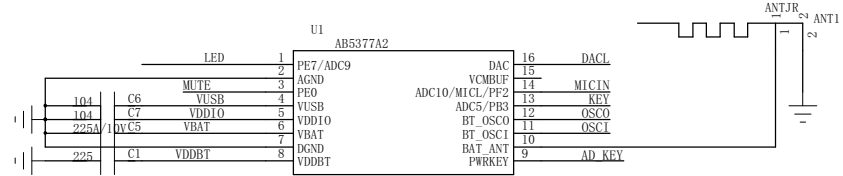

DRAWN:		DATED:		SIZE:
RELEASED:		DATED:		
CHECKED:		DATED:		DRAWING NO:
SCALE:		SHEET: OF		
				REV: