

**FCC TEST REPORT****FCC Part 22 /Part 24**Report Reference No..... : **LCS190306003AED**FCC ID..... : **2AJTU-K5**Date of Issue. .... : **April 24, 2019**Testing Laboratory Name ..... : **Shenzhen LCS Compliance Testing Laboratory Ltd.**Address..... : 1/F., Xingyuan Industrial Park, Tongda Road, Bao'an Avenue,  
Bao'an District, Shenzhen, Guangdong, ChinaApplicant's name..... : **South Surveying & Mapping Technology Co., Ltd.**

Address..... : No.39, Sicheng Road, Tianhe District, Guangzhou, China

Test specification ..... :

Standard ..... : **FCC Part 22: Public Mobile Services****FCC Part 24: Personal Communication Services**

Test Report Form No ..... : LCSEMC-1.0

TRF Originator..... : Shenzhen LCS Compliance Testing Laboratory Ltd.

Master TRF..... : Dated 2011-03

**Shenzhen LCS Compliance Testing Laboratory Ltd. All rights reserved.**

This publication may be reproduced in whole or in part for non-commercial purposes as long as the Shenzhen LCS Compliance Testing Laboratory Ltd. is acknowledged as copyright owner and source of the material. Shenzhen LCS Compliance Testing Laboratory Ltd. takes no responsibility for and will not assume liability for damages resulting from the reader's interpretation of the reproduced material due to its placement and context.

Test item description ..... : **GNSS RECEIVER**

Trade Mark ..... : SOUTH, KOLIDA, SANDING, RUIDE, TIANYU

Model/Type reference..... : K5

Listed Models ..... : K3, K9, R90i, R8i, C1, T3, T5, H3 plus, A20, M6

DC 7.4V by Rechargeable Li-ion Battery(3400mAh) or

Ratings..... : DC 13.8V by external power

Recharged by DC 4.2V 1.35A or DC 8.4V/0.67A for battery

Hardware version ..... : SG3000001

Software version ..... : GalaxyRTK\_LWB-V20181210

Frequency..... : GSM 850MHz; PCS 1900MHz

Result..... : **PASS**

Compiled by:



Aking Jin/ File administrator

Supervised by:

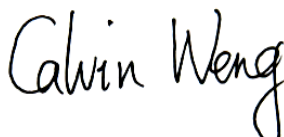

Calvin Weng/ Technique principal

Approved by:



Gavin Liang/ Manager

**TEST REPORT****Test Report No. : LCS190306003AED**

April 24, 2019

Date of issue

Equipment under Test : GNSS RECEIVER

Model /Type : K5

Listed Models : K3, K9, R90i, R8i, C1, T3, T5, H3 plus, A20, M6

Model Declaration : PCB board, structure and internal of these model(s) are the same,  
so no additional models were tested**Applicant : South Surveying & Mapping Technology Co., Ltd.**

Address : No.39, Sicheng Road, Tianhe District, Guangzhou, China

**Manufacturer : South Surveying & Mapping Technology Co., Ltd.**

Address : No.39, Sicheng Road, Tianhe District, Guangzhou, China

**Factory : South Surveying & Mapping Technology Co., Ltd.**

Address : No.39, Sicheng Road, Tianhe District, Guangzhou, China

**Test Result:****PASS**

The test report merely corresponds to the test sample.

It is not permitted to copy extracts of these test result without the written permission of the test laboratory.

### Revision History

| Revision | Issue Date     | Revisions     | Revised By  |
|----------|----------------|---------------|-------------|
| 000      | April 24, 2019 | Initial Issue | Gavin Liang |
|          |                |               |             |
|          |                |               |             |

## Contents

|          |   |                  |
|----------|---|------------------|
| <b>1</b> | <b><u>TEST STANDARDS .....</u></b>                  | <b><u>5</u></b>  |
| <b>2</b> | <b><u>SUMMARY .....</u></b>                         | <b><u>6</u></b>  |
| 2.1      | General Remarks                                     | 6                |
| 2.2      | Product Description                                 | 6                |
| 2.3      | Equipment under Test                                | 7                |
| 2.4      | Short description of the Equipment under Test (EUT) | 7                |
| 2.5      | Internal Identification of AE used during the test  | 8                |
| 2.6      | Normal Accessory setting                            | 8                |
| 2.7      | EUT configuration                                   | 8                |
| 2.8      | Related Submittal(s) / Grant (s)                    | 8                |
| 2.9      | Modifications                                       | 8                |
| 2.10     | General Test Conditions/Configurations              | 8                |
| <b>3</b> | <b><u>TEST ENVIRONMENT .....</u></b>                | <b><u>10</u></b> |
| 3.1      | Address of the test laboratory                      | 10               |
| 3.2      | Test Facility                                       | 10               |
| 3.3      | Environmental conditions                            | 10               |
| 3.4      | Test Description                                    | 10               |
| 3.5      | Equipments Used during the Test                     | 12               |
| 3.6      | Measurement uncertainty                             | 13               |
| <b>4</b> | <b><u>TEST CONDITIONS AND RESULTS .....</u></b>     | <b><u>14</u></b> |
| 4.1      | Output Power  | 14               |
| 4.2      | Radiated Spurious Emission                          | 18               |
| 4.3      | Occupied Bandwidth and Emission Bandwidth           | 22               |
| 4.4      | Band Edge Complicance                               | 25               |
| 4.5      | Spurious Emission on Antenna Port                   | 28               |
| 4.6      | Frequency Stability Test                            | 38               |
| 4.7      | Peak-to-Average Ratio (PAR)                         | 41               |
| <b>5</b> | <b><u>TEST SETUP PHOTOGRAPHS OF EUT .....</u></b>   | <b><u>44</u></b> |
| <b>6</b> | <b><u>EXTERIOR PHOTOGRAPHS OF THE EUT .....</u></b> | <b><u>44</u></b> |
| <b>7</b> | <b><u>INTERIOR PHOTOGRAPHS OF THE EUT .....</u></b> | <b><u>44</u></b> |

# **1 TEST STANDARDS**

The tests were performed according to following standards:

[FCC Part 22 \(10-1-16 Edition\)](#): Private Land Mobile Radio Services.

[FCC Part 24\(10-1-16 Edition\)](#): Public Mobile Services.

[TIA/EIA 603 D June 2010](#): Land Mobile FM or PM Communications Equipment Measurement and Performance Standards.

[47 CFR FCC Part 15 Subpart B](#): Unintentional Radiators.

[FCC Part 2](#): Frequency Allocations And Radio Treaty Matters: General Rules And Regulations.

[ANSI C63.4:2014](#): Methods of Measurement of Radio-Noise Emissions from Low-Voltage Electrical and Electronic Equipment in the Range of 9 kHz to 40 GHz.

## 2 SUMMARY

### 2.1 General Remarks

|                                |   |                |
|--------------------------------|---|----------------|
| Date of receipt of test sample | : | March 06, 2019 |
| Testing commenced on           | : | March 06, 2019 |
| Testing concluded on           | : | April 19, 2019 |

### 2.2 Product Description

The **South Surveying & Mapping Technology Co., Ltd.**'s Model: K5 or the "EUT" as referred to in this report; more general information as follows, for more details, refer to the user's manual of the EUT.

|  |   |
|--|---|
| Name of EUT                            | GNSS RECEIVER   |
| Model No.                              | K3, K5, K9, R90i, R8i, C1, T3, T5, H3 plus, A20, M6   |
| Model Declaration                      | PCB board, structure and internal of these model(s) are the same, so no additional models were tested                                       |
| Test Model                             | K5  |
| Power Supply                           | DC 7.4V by Rechargeable Li-ion Battery(3400mAh) or<br>DC 13.8V by external power<br>Recharged by DC 4.2V 1.35A or DC 8.4V/0.67A for battery |
| Hardware version                       | SG3000001   |
| Software version                       | GalaxyRTK_LWB-V20181210   |
| GSM/EDGE/GPRS Operation Frequency Band | GSM850/PCS1900/GPRS850/GPRS1900/EDGE850/EDGE1900  |
| UMTS Operation Frequency Band          | UMTS FDD Band I/V/VIII  |
| LTE Operation Frequency Band           | LTE Band 38/39/40/41  |
| Modulation Type                        | GMSK for GSM/GPRS; 8-PSK for EDGE; QPSK for UMTS; QPSK, 16QAM for LTE   |
| GSM/EDGE/GPRS                          | Supported GSM/GPRS/EDGE   |
| GSM Release Version                    | R99   |
| GSM/EDGE/GPRS Power Class              | GSM850:Power Class 4/ PCS1900:Power Class 1   |
| GPRS/EDGE Multislot Class              | GPRS/EDGE: Multi-slot Class 12  |
| GPRS operation mode                    | Class B   |
| WCDMA Release Version                  | R8  |
| HSDPA Release Version                  | Release 8   |
| HSUPA Release Version                  | Release 8   |
| DC-HSUPA Release Version               | Not Supported   |
| LTE Release Version                    | Release 9   |
| LTE/UMTS Power Class                   | Class 3   |
| Antenna Type                           | SMA Antenna   |
| Antenna Gain                           | 2.0dBi (max.) for GSM 850, PCS 1900;<br>2.0dBi (max.) for WCDMA Band V;<br>2.0dBi (max.) for LTE Band 41                                    |
| BT FCC Operation frequency             | 2402-2480MHz  |
| BT FCC Modulation Type                 | GFSK, $\pi/4$ -DQPSK, 8-DPSK for Bluetooth V4.0 (BDR/EDR)<br>GFSK for Bluetooth V4.0 (BT LE)  |
| Bluetooth Version                      | V4.0  |
| Antenna Type                           | Ceramic Antenna   |
| Antenna Gain                           | 2.0dBi (max.) for Bluetooth   |
| WLAN FCC Operation frequency           | IEEE 802.11b/g/n HT20:2412-2462MHz  |
| WLAN FCC Modulation Type               | IEEE 802.11b: DSSS(CCK,DQPSK,DBPSK)<br>IEEE 802.11g/n: OFDM(64QAM, 16QAM, QPSK, BPSK)   |
| Antenna Type                           | Ceramic Antenna   |
| Antenna Gain                           | 2.0dBi (max.) for WLAN  |

|                             |  |
|-----------------------------|--|
| PMR FCC Operation frequency | 460.125-467.625MHz   |
| Channel Separation          | 12.5KHz & 25KHz  |
| Modulation Type             | GMSK   |
| Emission Designator         | 11K0G1D for GMSK Modulation at 12.5KHz Channel Separation<br>16K0G1D for GMSK Modulation at 25KHz Channel Separation |
| Rate Power                  | 25W/10W  |
| Antenna Type                | SMA Antenna  |
| Antenna Gain                | 5.0dBi (max.) for PMR  |
| GPS function                | Support and only RX  |
| FM function                 | Support and only RX  |
| NFC Function                | Support and only RX  |
| Extreme temp. Tolerance     | -10°C to +55°C   |
| Extreme Voltage Tolerance   | DC 6.66V to 8.14V  |

## 2.3 Equipment under Test

### Power supply system utilised

|                      |   |   |                                   |
|----------------------|---|---|-----------------------------------|
| Power supply voltage | : | <input type="radio"/> 120V / 60 Hz                                | <input type="radio"/> 115V / 60Hz |
|                      |   | <input type="radio"/> 12 V DC                                     | <input type="radio"/> 24 V DC     |
|                      |   | <input checked="" type="radio"/> Other (specified in blank below) |                                   |

DC 7.40V

### Test frequency list

| Test Mode | TX/RX | RF Channel  |             |             |
|-----------|-------|-------------|-------------|-------------|
|           |       | Low(L)      | Middle (M)  | High (H)    |
| GSM850    | TX    | Channel 128 | Channel 190 | Channel 251 |
|           |       | 824.2 MHz   | 836.6 MHz   | 848.8 MHz   |
|           | RX    | Channel 128 | Channel 190 | Channel 251 |
|           |       | 869.2 MHz   | 881.6 MHz   | 893.8 MHz   |
| Test Mode | TX/RX | RF Channel  |             |             |
|           |       | Low(L)      | Middle (M)  | High (H)    |
| GSM1900   | TX    | Channel 512 | Channel 661 | Channel 810 |
|           |       | 1850.2 MHz  | 1880.0 MHz  | 1909.8 MHz  |
|           | RX    | Channel 512 | Channel 661 | Channel 810 |
|           |       | 1930.2 MHz  | 1960.0 MHz  | 1989.8 MHz  |

## 2.4 Short description of the Equipment under Test (EUT)

### 2.4.1 General Description

K5 is subscriber equipment in the LTE/WCDMA/GSM system. The HSPA/UMTS frequency band is Band II/IV/V, LTE frequency band is band 41. The GSM/GPRS/EDGE frequency band includes GSM850 and PCS1900. The K5 implements such functions as RF signal receiving/transmitting, HSPA/UMTS and GSM/GPRS/EDGE protocol processing. Externally it provides SIM card interface.

NOTE: Unless otherwise noted in the report, the functional boards installed in the units shall be selected from the below list, but not means all the functional boards listed below shall be installed in one unit.

## 2.5 Internal Identification of AE used during the test

| AE ID* | Description       |
|--------|-------------------|
| AE1    | Battery (3400mAh) |
| AE2    | N/A               |

\*AE ID: is used to identify the test sample in the lab internally.

## 2.6 Normal Accessory setting

Fully charged battery was used during the test.

## 2.7 EUT configuration

The following peripheral devices and interface cables were connected during the measurement:

● - supplied by the manufacturer

○ - supplied by the lab

|                       |             |                |   |
|-----------------------|-------------|----------------|---|
| <input type="radio"/> | Power Cable | Length (m) :   | / |
|                       |             | Shield :       | / |
|                       |             | Detachable :   | / |
| <input type="radio"/> | Multimeter  | Manufacturer : | / |
|                       |             | Model No. :    | / |

## 2.8 Related Submittal(s) / Grant (s)

This submittal(s) (test report) is intended for **FCC ID: 2AJTU-K5** filing to comply with FCC Part 22 and Part 24 Rules.

## 2.9 Modifications

No modifications were implemented to meet testing criteria.

## 2.10 General Test Conditions/Configurations

### 2.10.1 Test Modes

NOTE: The test mode(s) are selected according to relevant radio technology specifications.

| Test Mode | Test Modes Description            |
|-----------|-----------------------------------|
| GSM/TM1   | GSM system, GSM, GMSK modulation  |
| GSM/TM2   | GSM system, GPRS, GMSK modulation |
| GSM/TM3   | GSM system, EDGE, 8PSK modulation |

Note:

- As GSM and GPRS with the same emission designator, test result recorded in this report at the worst case GSM/TM1 only after exploratory scan.



### 2.10.2 Test Environment

| Environment Parameter | Selected Values During Tests |         |
|-----------------------|------------------------------|---------|
| Relative Humidity     | Ambient                      |         |
| Temperature           | TN                           | Ambient |
| Voltage               | VL                           | 6.66V   |
|                       | VN                           | 7.40V   |
|                       | VH                           | 8.14V   |

NOTE: VL=lower extreme test voltage VN=nominal voltage  
VH=upper extreme test voltage TN=normal temperature

### 3 TEST ENVIRONMENT

#### 3.1 Address of the test laboratory

##### Shenzhen LCS Compliance Testing Laboratory Ltd

1/F., Xingyuan Industrial Park, Tongda Road, Bao'an Avenue, Bao'an District, Shenzhen, Guangdong, China

The sites are constructed in conformance with the requirements of ANSI C63.4 (2014) and CISPR Publication 22.

#### 3.2 Test Facility

The test facility is recognized, certified, or accredited by the following organizations:

FCC Registration Number is 254912.

Industry Canada Registration Number is 9642A-1.

EMSD Registration Number is ARCB0108.

UL Registration Number is 100571-492.

TUV SUD Registration Number is SCN1081.

TUV RH Registration Number is UA 50296516-001.

NVLAP Accreditation Code is 600167-0.

FCC Designation Number is CN5024.

CAB identifier is CN0071.

#### 3.3 Environmental conditions

During the measurement the environmental conditions were within the listed ranges:

|                       |              |
|-----------------------|--------------|
| Temperature:          | 15-35 ° C    |
|                       |              |
| Humidity:             | 30-60 %      |
|                       |              |
| Atmospheric pressure: | 950-1050mbar |

#### 3.4 Test Description

##### 3.4.1 Cellular Band (824-849MHz paired with 869-894MHz)

| Test Item                                  | FCC Rule No.        | Requirements   | Verdict |
|--|---------------------|--|---------|
| Effective(Isotropic) Radiated Output Power | §2.1046,<br>§22.913 | FCC: ERP ≤ 7W.<br>ISED: ERP ≤ 11.5W.   | Pass    |
| Modulation Characteristics                 | §2.1047             | Digital modulation   | N/A     |
| Bandwidth                                  | §2.1049             | OBW: No limit.<br>EBW: No limit.   | Pass    |
| Band Edges Compliance                      | §2.1051,<br>§22.917 | ≤ -13dBm/1%*EBW, in 1MHz bands immediately outside and adjacent to The frequency block.            | Pass    |
| Spurious Emission at Antenna Terminals     | §2.1051,<br>§22.917 | ≤ -13dBm/100kHz,<br>from 9kHz to 10th harmonics but outside authorized operating frequency ranges. | Pass    |
| Field Strength of Spurious Radiation       | §2.1053,<br>§22.917 | ≤ -13dBm/100kHz.   | Pass    |
| Frequency Stability                        | §2.1055,<br>§22.355 | ≤ ±2.5ppm.   | Pass    |
| Peak-Average Ratio                         | §22.913             | IC:Limit≤13dB  | Pass    |
| Receiver Spurious Emissions                | N/A                 | --   | Pass    |

NOTE 1: For the verdict, the "N/A" denotes "not applicable", the "N/T" de notes "not tested".

**3.4.2 PCS Band (1850-1915MHz paired with 1930-1995MHz)**

| Test Item                                  | FCC Rule No.        | Requirements  | Verdict |
|--|---------------------|---|---------|
| Effective(Isotropic) Radiated Output Power | §2.1046,<br>§24.232 | EIRP ≤ 2W   | Pass    |
| Peak-Average Ratio                         | §2.1046,<br>§24.232 | ≤13dB   | Pass    |
| Modulation Characteristics                 | §2.1047             | Digital modulation  | N/A     |
| Bandwidth                                  | §2.1049             | OBW: No limit.<br>EBW: No limit.  | Pass    |
| Band Edges Compliance                      | §2.1051,<br>§24.238 | ≤ -13dBm/1%*EBW, In 1MHz bands immediately outside and adjacent to The frequency block.     | Pass    |
| Spurious Emission at Antenna Terminals     | §2.1051,<br>§24.238 | ≤-13dBm/1MHz, from 9kHz to10th harmonics but outside authorized Operating frequency ranges. | Pass    |
| Field Strength of Spurious Radiation       | §2.1053,<br>§24.238 | ≤ -13dBm/1MHz.  | Pass    |
| Frequency Stability                        | §2.1055,<br>§24.235 | ≤ ±2.5ppm.  | Pass    |
| Peak-Average Ratio                         | §24.232             | IC:Limit≤13dB   | Pass    |
| Receiver Spurious Emissions                | N/A                 | --  | Pass    |

NOTE 1: For the verdict, the "N/A" denotes "not applicable", the "N/T" de notes "not tested".

Remark: 1. The measurement uncertainty is not included in the test result.

### 3.5 Equipments Used during the Test

| Item | Equipment                            | Manufacturer      | Model No.    | Serial No.  | Cal Date   | Due Date   |
|------|--------------------------------------|-------------------|--------------|-------------|------------|------------|
| 1    | Power Meter                          | R&S               | NRVS         | 100444      | 2018-06-16 | 2019-06-15 |
| 2    | Power Sensor                         | R&S               | NRV-Z81      | 100458      | 2018-06-16 | 2019-06-15 |
| 3    | Power Sensor                         | R&S               | NRV-Z32      | 10057       | 2018-06-16 | 2019-06-15 |
| 4    | LTE Test Software                    | Tonscend          | JS1120-1     | N/A         | N/A        | N/A        |
| 5    | RF Control Unit                      | Tonscend          | JS0806       | 158060009   | 2018-06-16 | 2019-06-15 |
| 6    | MXA Signal Analyzer                  | Agilent           | N9020A       | MY51250905  | 2018-11-15 | 2019-11-14 |
| 7    | WIDEBAND RADIO COMMUNICATION TESTER  | R&S               | CMW 500      | 103818      | 2018-06-16 | 2019-06-15 |
| 8    | DC Power Supply                      | Agilent           | E3642A       | N/A         | 2018-11-15 | 2019-11-14 |
| 9    | EMI Test Software                    | AUDIX             | E3           | N/A         | 2018-06-16 | 2019-06-15 |
| 10   | 3m Semi Anechoic Chamber             | SIDT FRANKONIA    | SAC-3M       | 03CH03-HY   | 2018-06-16 | 2019-06-15 |
| 11   | Positioning Controller               | MF                | MF-7082      | N/A         | 2018-06-16 | 2019-06-15 |
| 12   | Active Loop Antenna                  | SCHWARZBECK       | FMZB 1519B   | 00005       | 2018-07-26 | 2019-07-25 |
| 13   | By-log Antenna                       | SCHWARZBECK       | VULB9163     | 9163-470    | 2018-07-26 | 2019-07-25 |
| 14   | Horn Antenna                         | SCHWARZBECK       | BBHA 9120D   | 9120D-1925  | 2018-07-02 | 2019-07-01 |
| 15   | Broadband Horn Antenna               | SCHWARZBECK       | BBHA 9170    | 791         | 2018-09-20 | 2019-09-19 |
| 16   | Broadband Preamplifier               | SCHWARZBECK       | BBV 9719     | 9719-025    | 2018-09-20 | 2019-09-19 |
| 17   | EMI Test Receiver                    | R&S               | ESR 7        | 101181      | 2018-06-16 | 2019-06-15 |
| 18   | RS SPECTRUM ANALYZER                 | R&S               | FSP40        | 100503      | 2018-11-15 | 2019-11-14 |
| 19   | AMPLIFIER                            | QuieTek           | QTK          | CHM/0809065 | 2018-11-15 | 2019-11-14 |
| 20   | RF Cable-R03m                        | Jye Bao           | RG142        | CB021       | 2018-06-16 | 2019-06-15 |
| 21   | RF Cable-HIGH                        | SUHNER            | SUCOFLEX 106 | 03CH03-HY   | 2018-06-16 | 2019-06-15 |
| 22   | 6dB Attenuator                       | /                 | 100W/6dB     | 1172040     | 2018-06-16 | 2019-06-15 |
| 23   | 3dB Attenuator                       | /                 | 2N-3dB       | /           | 2018-06-16 | 2019-06-15 |
| 24   | Temperature & Humidity Chamber       | GUANGZHOU GOGNWEN | GDS-100      | 70932       | 2018-10-10 | 2019-10-09 |
| 25   | Universal Radio Communication Tester | R&S               | CMU 200      | 105788      | 2018-06-16 | 2019-06-15 |

Note: All equipment is calibrated through GUANGZHOU LISAI CALIBRATION AND TEST CO.,LTD.

### 3.6 Measurement uncertainty

The data and results referenced in this document are true and accurate. The reader is cautioned that there may be errors within the calibration limits of the equipment and facilities. The measurement uncertainty was calculated for all measurements listed in this test report acc. to ETSI TR 100 028 “ Electromagnetic compatibility and Radio spectrum Matters (ERM); Uncertainties in the measurement of mobile radio equipment characteristics” and is documented in the Shenzhen LCS Compliance Testing Laboratory Ltd. quality system acc. to DIN EN ISO/IEC 17025. Furthermore, component and process variability of devices similar to that tested may result in additional deviation. The manufacturer has the sole responsibility of continued compliance of the device.

Hereafter the best measurement capability for Shenzhen LCS Compliance Testing Laboratory Ltd. is reported:

| Test                                | Range      | Measurement Uncertainty | Notes |
|-------------------------------------|------------|-------------------------|-------|
| Radiated Emission                   | 30~1000MHz | 3.10 dB                 | (1)   |
| Radiated Emission                   | 1~18GHz    | 3.80 dB                 | (1)   |
| Radiated Emission                   | 18-40GHz   | 3.90 dB                 | (1)   |
| Conducted Disturbance               | 0.15~30MHz | 1.63 dB                 | (1)   |
| Conducted Power                     | 9KHz~18GHz | 0.61 dB                 | (1)   |
| Spurious RF Conducted Emission      | 9KHz~40GHz | 1.22 dB                 | (1)   |
| Band Edge Compliance of RF Emission | 9KHz~40GHz | 1.22 dB                 | (1)   |
| Occupied Bandwidth                  | 9KHz~40GHz | -                       | (1)   |

(1) This uncertainty represents an expanded uncertainty expressed at approximately the 95% confidence level using a coverage factor of k=1.96.

## 4 TEST CONDITIONS AND RESULTS

### 4.1 Output Power

#### TEST APPLICABLE

During the process of testing, the EUT was controlled via R&S Digital Radio Communication tester (CMU200) to ensure max power transmission and proper modulation. This result contains output power and EIRP measurements for the EUT. In all cases, output power is within the specified limits.

#### 4.1.1 Conducted Output Power

##### TEST CONFIGURATION

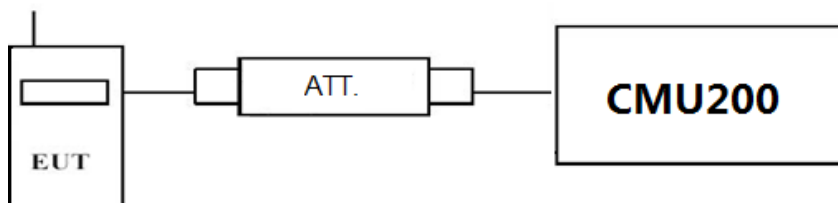

##### TEST PROCEDURE

###### Conducted Power Measurement:

- Place the EUT on a bench and set it in transmitting mode.
- Connect a low loss RF cable from the antenna port to a CMU200 by an Att.
- EUT Communicate with CMU200 then selects a channel for testing.
- Add a correction factor to the display CMU200, and then test.

##### TEST RESULTS

| GSM 850        |          | Burst Average Conducted power (dBm) |           |           |
|----------------|----------|-------------------------------------|-----------|-----------|
|                |          | Channel/Frequency(MHz)              |           |           |
|                |          | 128/824.2                           | 190/836.6 | 251/848.8 |
| GSM            |          | 32.64                               | 32.70     | 32.57     |
| GPRS<br>(GMSK) | 1TX slot | 32.42                               | 32.22     | 32.39     |
|                | 2TX slot | 30.31                               | 31.97     | 31.86     |
|                | 3TX slot | 29.58                               | 29.25     | 29.98     |
|                | 4TX slot | 27.08                               | 29.00     | 28.03     |
| EDGE<br>(8PSK) | 1TX slot | 26.91                               | 26.54     | 26.12     |
|                | 2TX slot | 24.41                               | 24.04     | 25.95     |
|                | 3TX slot | 22.80                               | 23.62     | 23.01     |
|                | 4TX slot | 21.97                               | 21.12     | 21.62     |

| GSM 1900       |          | Burst Average Conducted power (dBm) |          |            |
|----------------|----------|-------------------------------------|----------|------------|
|                |          | Channel/Frequency(MHz)              |          |            |
|                |          | 512/1850.2                          | 661/1880 | 810/1909.8 |
| GSM            |          | 29.67                               | 29.70    | 29.70      |
| GPRS<br>(GMSK) | 1TX slot | 29.22                               | 29.20    | 29.16      |
|                | 2TX slot | 27.36                               | 27.36    | 28.01      |
|                | 3TX slot | 26.19                               | 26.21    | 26.46      |
|                | 4TX slot | 25.95                               | 25.37    | 25.24      |
| EDGE<br>(8PSK) | 1TX slot | 25.96                               | 25.39    | 25.59      |
|                | 2TX slot | 23.57                               | 24.47    | 24.57      |
|                | 3TX slot | 22.43                               | 22.28    | 22.49      |
|                | 4TX slot | 21.72                               | 21.11    | 21.47      |

## 4.1.2 Radiated Output Power

### TEST DESCRIPTION

This is the test for the maximum radiated power from the EUT.

Per rule Part 24.232(c) specifies, "Mobile/portable stations are limited to 2 watts e.i.r.p. Peak power" and 24.232(e) specifies that "Peak transmit power must be measured over any interval of continuous transmission using instrumentation calibrated in terms of an rms-equivalent voltage."

Per rule Part 22.913(a) specifies "The ERP of mobile transmitters and auxiliary test transmitters must not exceed 7 Watts."

### TEST CONFIGURATION

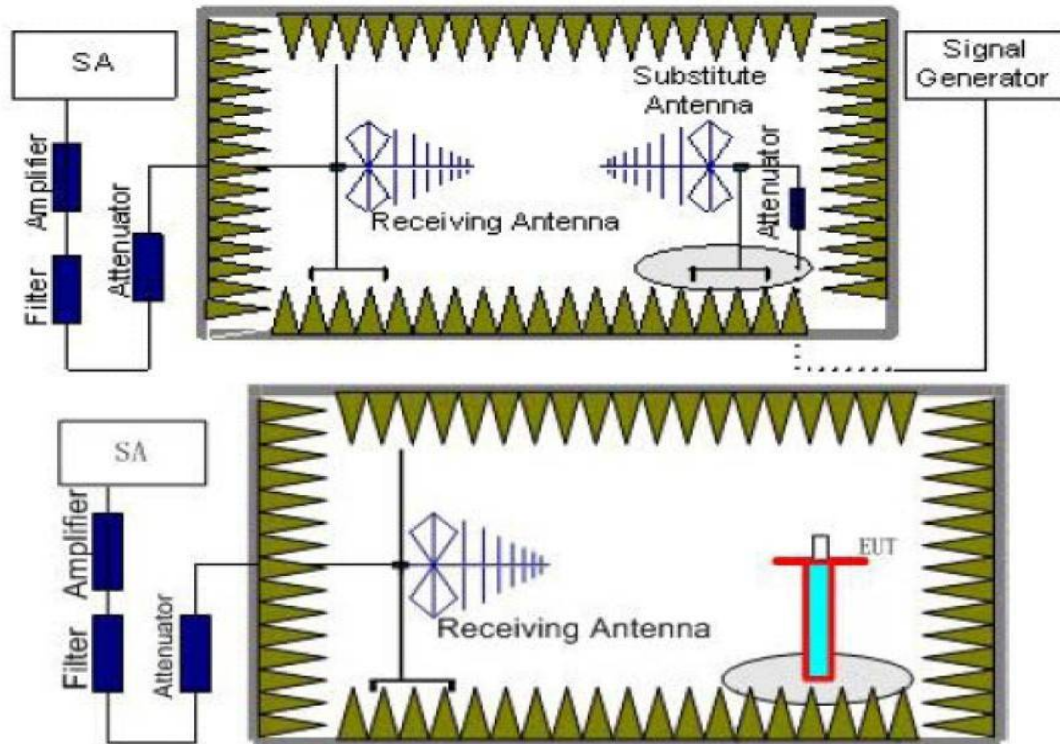

### TEST PROCEDURE

1. EUT was placed on a 1.50 meter high non-conductive stand at a 3 meter test distance from the receive antenna. A receiving antenna was placed on the antenna mast 3 meters from the EUT for emission measurements. The height of receiving antenna is 1.50 m. Detected emissions were maximized at each frequency by rotating the EUT through 360° and adjusting the receiving antenna polarization. The radiated emission measurements of all transmit frequencies in three channels (High, Middle, Low) were measured with peak detector.
2. A log-periodic antenna or double-ridged waveguide horn antenna shall be substituted in place of the EUT. The log-periodic antenna will be driven by a signal generator and the level will be adjusted till the same power value on the spectrum analyzer or receiver. The level of the spurious emissions can be calculated through the level of the signal generator, cable loss, the gain of the substitution antenna and the reading of the spectrum analyzer or receiver.
3. The EUT is then put into continuously transmitting mode at its maximum power level during the test. Set Test Receiver or Spectrum RBW=1MHz, VBW=3MHz, And the maximum value of the receiver should be recorded as ( $P_r$ ).
4. The EUT shall be replaced by a substitution antenna. In the chamber, an substitution antenna for the frequency band of interest is placed at the reference point of the chamber. An RF Signal source for the frequency band of interest is connected to the substitution antenna with a cable that has been constructed to not interfere with the radiation pattern of the antenna. A power ( $P_{Mea}$ ) is applied to the input of the substitution antenna, and adjust the level of the signal generator output until the value of the receiver reach the

previously recorded ( $P_r$ ). The power of signal source ( $P_{Mea}$ ) is recorded. The test should be performed by rotating the test item and adjusting the receiving antenna polarization.

5. A amplifier should be connected to the Signal Source output port. And the cable should be connect between the Amplifier and the Substitution Antenna. The cable loss ( $P_{cl}$ ), the Substitution Antenna Gain ( $G_a$ ) and the Amplifier Gain ( $P_{Ag}$ ) should be recorded after test.

The measurement results are obtained as described below:

$$\text{Power(EIRP)} = P_{Mea} + P_{Ag} - P_{cl} + G_a$$

6. This value is EIRP since the measurement is calibrated using an antenna of known gain (2.15 dBi) and known input power.
7. ERP can be calculated from EIRP by subtracting the gain of the dipole,  $\text{ERP} = \text{EIRP} - 2.15\text{dBi}$ .

## TEST LIMIT

According to 22.913(a), 24.232(c), the ERP should be not exceed following table limits:

| GSM850(GPRS850,EDGE850) |            |                                  |
|-------------------------|------------|----------------------------------|
| Function                | Power Step | Burst Peak ERP (dBm)             |
| GSM                     | 5          | FCC: $\leq 38.45\text{dBm}$ (7W) |
| GPRS                    | 3          | FCC: $\leq 38.45\text{dBm}$ (7W) |
| EDGE                    | 8          | FCC: $\leq 38.45\text{dBm}$ (7W) |

| PCS1900(GPRS1900,EDGE1900) |            |                             |
|----------------------------|------------|-----------------------------|
| Function                   | Power Step | Burst Peak EIRP (dBm)       |
| GSM                        | 0          | $\leq 33.01\text{dBm}$ (2W) |
| GPRS                       | 3          | $\leq 33.01\text{dBm}$ (2W) |
| EDGE                       | 2          | $\leq 33.01\text{dBm}$ (2W) |

## TEST RESULTS

Remark:

- We were tested all Configuration refer 3GPP TS151 010.
- $\text{EIRP} = P_{Mea}(\text{dBm}) - P_{cl}(\text{dB}) + P_{Ag}(\text{dB}) + G_a(\text{dBi})$
- $\text{ERP} = \text{EIRP} - 2.15\text{dBi}$  as EIRP by subtracting the gain of the dipole.
- Margin = Emission Level - Limit
- We test the H direction and V direction recorded worst case.

### GSM/TM1/GSM850

| Frequency (MHz) | $P_{Mea}$ (dBm) | $P_{cl}$ (dB) | $G_a$ Antenna Gain(dB) | Correction (dB) | $P_{Ag}$ (dB) | Burst Average ERP (dBm) | Limit (dBm) | Margin (dB) | Polarization |
|-----------------|-----------------|---------------|------------------------|-----------------|---------------|-------------------------|-------------|-------------|--------------|
| 824.20          | -6.32           | 3.45          | 8.45                   | 2.15            | 33.79         | 30.32                   | 38.45       | -8.13       | V            |
| 836.60          | -7.07           | 3.49          | 8.45                   | 2.15            | 33.85         | 29.59                   | 38.45       | -8.86       | V            |
| 848.80          | -7.69           | 3.55          | 8.36                   | 2.15            | 33.88         | 28.85                   | 38.45       | -9.60       | V            |

### GSM/TM3/EDGE850

| Frequency (MHz) | $P_{Mea}$ (dBm) | $P_{cl}$ (dB) | $G_a$ Antenna Gain(dB) | Correction (dB) | $P_{Ag}$ (dB) | Burst Average ERP (dBm) | Limit (dBm) | Margin (dB) | Polarization |
|-----------------|-----------------|---------------|------------------------|-----------------|---------------|-------------------------|-------------|-------------|--------------|
| 824.20          | -13.68          | 3.45          | 8.45                   | 2.15            | 33.79         | 22.96                   | 38.45       | -15.49      | V            |
| 836.60          | -13.21          | 3.49          | 8.45                   | 2.15            | 33.85         | 23.45                   | 38.45       | -15.00      | V            |
| 848.80          | -13.08          | 3.55          | 8.36                   | 2.15            | 33.88         | 23.46                   | 38.45       | -14.99      | V            |

### GSM/TM1/GSM1900

| Frequency (MHz) | $P_{Mea}$ (dBm) | $P_{cl}$ (dB) | $G_a$ Antenna Gain(dB) | $P_{Ag}$ (dB) | Burst Average EIRP (dBm) | Limit (dBm) | Margin (dB) | Polarization |
|-----------------|-----------------|---------------|------------------------|---------------|--------------------------|-------------|-------------|--------------|
| 1850.20         | -11.74          | 4.03          | 8.38                   | 35.51         | 28.12                    | 33.01       | -4.89       | V            |
| 1880.00         | -12.69          | 4.08          | 8.33                   | 35.56         | 27.12                    | 33.01       | -5.89       | V            |
| 1909.80         | -11.78          | 4.14          | 8.26                   | 35.63         | 27.97                    | 33.01       | -5.04       | V            |



## GSM/TM3/EDGE1900

| Frequency (MHz) | P <sub>Mea</sub> (dBm) | P <sub>cl</sub> (dB) | G <sub>a</sub> Antenna Gain(dB) | P <sub>Ag</sub> (dB) | Burst Average EIRP (dBm) | Limit (dBm) | Margin (dB) | Polarization |
|-----------------|------------------------|----------------------|---------------------------------|----------------------|--------------------------|-------------|-------------|--------------|
| 1850.20         | -16.66                 | 4.03                 | 8.38                            | 35.51                | 23.20                    | 33.01       | -9.81       | V            |
| 1880.00         | -17.80                 | 4.08                 | 8.33                            | 35.56                | 22.01                    | 33.01       | -11.00      | V            |
| 1909.80         | -16.09                 | 4.14                 | 8.26                            | 35.63                | 23.66                    | 33.01       | -9.35       | V            |

## 4.2 Radiated Spurious Emission

### TEST APPLICABLE

According to the TIA/EIA 603D:2010 and FCC Part 2.1033 test method, The Receiver or Spectrum was scanned from lowest frequency frequency generated within the equipment to the 10<sup>th</sup> harmonic of the highest frequency generated within the equipment, which is the transmitted carrier that can be as high as 1910 MHz. The resolution bandwidth is set as outlined in Part 24.238, Part 22.917, RSS-132 §5.5 and RSS-133 §6.5. The spectrum is scanned with the mobile station transmitting at carrier frequencies that pertain to low, mid and high channels of PCS1900 and GSM850.

### TEST CONFIGURATION

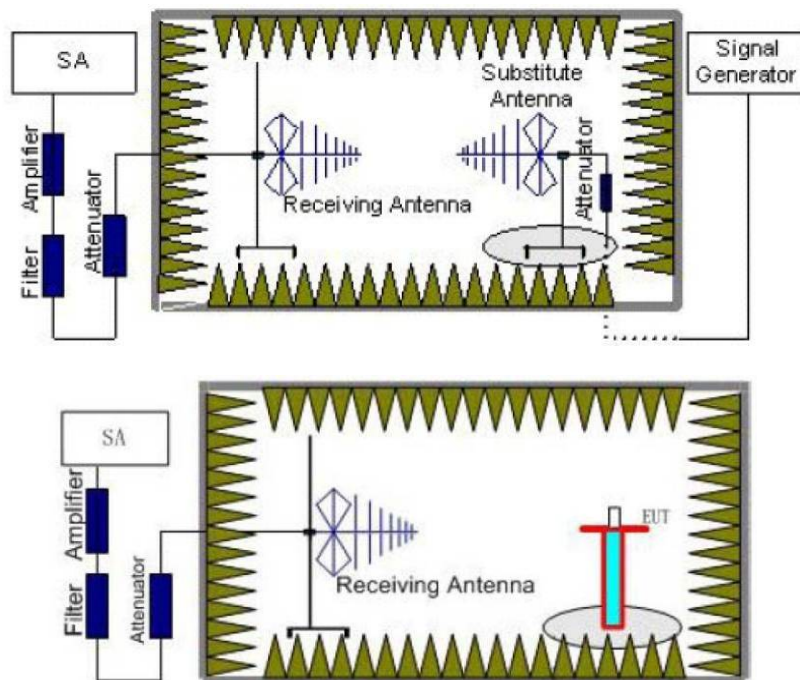

### TEST PROCEDURE

1. EUT was placed on a 1.50 meter high non-conductive stand at a 3 meter test distance from the receive antenna. A receiving antenna was placed on the antenna mast 3 meters from the EUT for emission measurements. The height of receiving antenna is 1.50 m. Detected emissions were maximized at each frequency by rotating the EUT through 360° and adjusting the receiving antenna polarization. The radiated emission measurements of all transmit frequencies in three channels (High, Middle, Low) were measured with peak detector.
2. A log-periodic antenna or double-ridged waveguide horn antenna shall be substituted in place of the EUT. The log-periodic antenna will be driven by a signal generator and the level will be adjusted till the same power value on the spectrum analyzer or receiver. The level of the spurious emissions can be calculated through the level of the signal generator, cable loss, the gain of the substitution antenna and the reading of the spectrum analyzer or receiver.
3. The EUT is then put into continuously transmitting mode at its maximum power level during the test. Set Test Receiver or Spectrum RBW=1MHz, VBW=3MHz, And the maximum value of the receiver should be recorded as ( $P_r$ ).
4. The EUT shall be replaced by a substitution antenna. In the chamber, an substitution antenna for the frequency band of interest is placed at the reference point of the chamber. An RF Signal source for the frequency band of interest is connected to the substitution antenna with a cable that has been constructed to not interfere with the radiation pattern of the antenna. A power ( $P_{Mea}$ ) is applied to the input of the substitution antenna, and adjust the level of the signal generator output until the value of the receiver reach the previously recorded ( $P_r$ ). The power of signal source ( $P_{Mea}$ ) is recorded. The test should be performed by rotating the test item and adjusting the receiving antenna polarization.

5. An amplifier should be connected to the Signal Source output port. And the cable should be connect between the Amplifier and the Substitution Antenna. The cable loss ( $P_{cl}$ ), the Substitution Antenna Gain ( $G_a$ ) and the Amplifier Gain ( $P_{Ag}$ ) should be recorded after test.

The measurement results are obtained as described below:

$$\text{Power(EIRP)} = P_{\text{Mea}} + P_{\text{Ag}} - P_{\text{cl}} + G_a$$

6. This value is EIRP since the measurement is calibrated using an antenna of known gain (2.15 dBi) and known input power.
7. ERP can be calculated from EIRP by subtracting the gain of the dipole,  $\text{ERP} = \text{EIRP} - 2.15\text{dBi}$ .
8. In order to make sure test results more clearly, we set frequency range and sweep time for difference frequency range as follows table:

| Working Frequency | Subrange (GHz) | RBW    | VBW    | Sweep time (s) |
|-------------------|----------------|--------|--------|----------------|
| TM1/GSM 850       | 0.00009~0.15   | 1KHz   | 3KHz   | 30             |
|                   | 0.00015~0.03   | 10KHz  | 30KHz  | 10             |
|                   | 0.03~1         | 100KHz | 300KHz | 10             |
|                   | 1~2            | 1 MHz  | 3 MHz  | 2              |
|                   | 2~5            | 1 MHz  | 3 MHz  | 3              |
|                   | 5~8            | 1 MHz  | 3 MHz  | 3              |
|                   | 8~10           | 1 MHz  | 3 MHz  | 3              |
| TM1/GSM 1900      | 0.00009~0.15   | 1KHz   | 3KHz   | 30             |
|                   | 0.00015~0.03   | 10KHz  | 30KHz  | 10             |
|                   | 0.03~1         | 100KHz | 300KHz | 10             |
|                   | 1~2            | 1 MHz  | 3 MHz  | 2              |
|                   | 2~5            | 1 MHz  | 3 MHz  | 3              |
|                   | 5~8            | 1 MHz  | 3 MHz  | 3              |
|                   | 8~11           | 1 MHz  | 3 MHz  | 3              |
|                   | 11~14          | 1 MHz  | 3 MHz  | 3              |
|                   | 14~18          | 1 MHz  | 3 MHz  | 3              |
| 18~20             | 1 MHz          | 3 MHz  | 2      |                |

## TEST LIMITS

According to 24.238 and 22.917 specify that the power of any emission outside of the authorized operating frequency ranges must be attenuated below the transmitting power ( $P$ ) by a factor of at least  $43 + 10 \log(P)$  dB. The specification that emissions shall be attenuated below the transmitter power ( $P$ ) by at least  $43 + 10 \log(P)$  dB, translates in the relevant power range (1 to 0.001 W) to -13 dBm. At 1 W the specified minimum attenuation becomes 43 dB and relative to a 30 dBm (1 W) carrier becomes a limit of -13 dBm. At 0.001 W (0 dBm) the minimum attenuation is 13 dB, which again yields a limit of -13 dBm. In this way a translation of the specification from relative to absolute terms is carried out.

| Frequency    | Channel | Frequency Range | Verdict |
|--------------|---------|-----------------|---------|
| TM1/GSM 850  | Low     | 9KHz -10GHz     | PASS    |
|              | Middle  | 9KHz -10GHz     | PASS    |
|              | High    | 9KHz -10GHz     | PASS    |
| TM1/GSM 1900 | Low     | 9KHz -20GHz     | PASS    |
|              | Middle  | 9KHz -20GHz     | PASS    |
|              | High    | 9KHz -20GHz     | PASS    |

## TEST RESULTS

Remark:

- We were tested all refer 3GPP TS151 010.
- $\text{EIRP} = P_{\text{Mea}}(\text{dBm}) - P_{\text{cl}}(\text{dB}) + G_a(\text{dBi})$
- We were not recorded other points as values lower than limits.
- $\text{Margin} = \text{EIRP} - \text{Limit}$

*GSM/TM1/GSM850\_ Low Channel*

| Frequency (MHz) | P <sub>Mea</sub> (dBm) | P <sub>cl</sub> (dB) | Diatance | G <sub>a</sub> Antenna Gain(dB) | Peak EIRP (dBm) | Limit (dBm) | Margin (dB) | Polarization |
|-----------------|------------------------|----------------------|----------|---------------------------------|-----------------|-------------|-------------|--------------|
| 1648.40         | -45.26                 | 3.86                 | 3.00     | 8.56                            | -40.56          | -13.00      | -27.56      | H            |
| 2472.60         | -55.93                 | 4.29                 | 3.00     | 6.98                            | -53.24          | -13.00      | -40.24      | H            |
| 1648.40         | -42.34                 | 3.86                 | 3.00     | 8.56                            | -37.64          | -13.00      | -24.64      | V            |
| 2472.60         | -51.48                 | 4.29                 | 3.00     | 6.98                            | -48.79          | -13.00      | -35.79      | V            |

*GSM/TM1/GSM850\_ Middle Channel*

| Frequency (MHz) | P <sub>Mea</sub> (dBm) | P <sub>cl</sub> (dB) | Diatance | G <sub>a</sub> Antenna Gain(dB) | Peak EIRP (dBm) | Limit (dBm) | Margin (dB) | Polarization |
|-----------------|------------------------|----------------------|----------|---------------------------------|-----------------|-------------|-------------|--------------|
| 1673.20         | -44.43                 | 3.90                 | 3.00     | 8.58                            | -39.75          | -13.00      | -26.75      | H            |
| 2509.80         | -55.51                 | 4.32                 | 3.00     | 6.80                            | -53.03          | -13.00      | -40.03      | H            |
| 1673.20         | -40.00                 | 3.90                 | 3.00     | 8.58                            | -35.32          | -13.00      | -22.32      | V            |
| 2509.80         | -55.13                 | 4.32                 | 3.00     | 6.80                            | -52.65          | -13.00      | -39.65      | V            |

*GSM/TM1/GSM850\_ High Channel*

| Frequency (MHz) | P <sub>Mea</sub> (dBm) | P <sub>cl</sub> (dB) | Diatance | G <sub>a</sub> Antenna Gain(dB) | Peak EIRP (dBm) | Limit (dBm) | Margin (dB) | Polarization |
|-----------------|------------------------|----------------------|----------|---------------------------------|-----------------|-------------|-------------|--------------|
| 1697.60         | -41.31                 | 3.91                 | 3.00     | 9.06                            | -36.16          | -13.00      | -23.16      | H            |
| 2546.40         | -47.59                 | 4.32                 | 3.00     | 6.65                            | -45.26          | -13.00      | -32.26      | H            |
| 1697.60         | -41.62                 | 3.91                 | 3.00     | 9.06                            | -36.47          | -13.00      | -23.47      | V            |
| 2546.40         | -55.75                 | 4.32                 | 3.00     | 6.65                            | -53.42          | -13.00      | -40.42      | V            |

*GSM/TM3/GSM850\_ Low Channel*

| Frequency (MHz) | P <sub>Mea</sub> (dBm) | P <sub>cl</sub> (dB) | Diatance | G <sub>a</sub> Antenna Gain(dB) | Peak EIRP (dBm) | Limit (dBm) | Margin (dB) | Polarization |
|-----------------|------------------------|----------------------|----------|---------------------------------|-----------------|-------------|-------------|--------------|
| 1648.40         | -42.93                 | 3.86                 | 3.00     | 8.56                            | -38.23          | -13.00      | -25.23      | H            |
| 2472.60         | -54.61                 | 4.29                 | 3.00     | 6.98                            | -51.92          | -13.00      | -38.92      | H            |
| 1648.40         | -42.88                 | 3.86                 | 3.00     | 8.56                            | -38.18          | -13.00      | -25.18      | V            |
| 2472.60         | -55.90                 | 4.29                 | 3.00     | 6.98                            | -53.21          | -13.00      | -40.21      | V            |

*GSM/TM3/GSM850\_ Middle Channel*

| Frequency (MHz) | P <sub>Mea</sub> (dBm) | P <sub>cl</sub> (dB) | Diatance | G <sub>a</sub> Antenna Gain(dB) | Peak EIRP (dBm) | Limit (dBm) | Margin (dB) | Polarization |
|-----------------|------------------------|----------------------|----------|---------------------------------|-----------------|-------------|-------------|--------------|
| 1673.20         | -43.49                 | 3.90                 | 3.00     | 8.58                            | -38.81          | -13.00      | -25.81      | H            |
| 2509.80         | -51.29                 | 4.32                 | 3.00     | 6.80                            | -48.81          | -13.00      | -35.81      | H            |
| 1673.20         | -40.79                 | 3.90                 | 3.00     | 8.58                            | -36.11          | -13.00      | -23.11      | V            |
| 2509.80         | -48.04                 | 4.32                 | 3.00     | 6.80                            | -45.56          | -13.00      | -32.56      | V            |

*GSM/TM3/GSM850\_ High Channel*

| Frequency (MHz) | P <sub>Mea</sub> (dBm) | P <sub>cl</sub> (dB) | Diatance | G <sub>a</sub> Antenna Gain(dB) | Peak EIRP (dBm) | Limit (dBm) | Margin (dB) | Polarization |
|-----------------|------------------------|----------------------|----------|---------------------------------|-----------------|-------------|-------------|--------------|
| 1697.60         | -44.18                 | 3.91                 | 3.00     | 9.06                            | -39.03          | -13.00      | -26.03      | H            |
| 2546.40         | -52.65                 | 4.32                 | 3.00     | 6.65                            | -50.32          | -13.00      | -37.32      | H            |
| 1697.60         | -40.58                 | 3.91                 | 3.00     | 9.06                            | -35.43          | -13.00      | -22.43      | V            |
| 2546.40         | -49.15                 | 4.32                 | 3.00     | 6.65                            | -46.82          | -13.00      | -33.82      | V            |

*GSM/TM1/GSM1900\_ Low Channel*

| Frequency (MHz) | P <sub>Mea</sub> (dBm) | P <sub>cl</sub> (dB) | Diatance | G <sub>a</sub> Antenna Gain(dB) | Peak EIRP (dBm) | Limit (dBm) | Margin (dB) | Polarization |
|-----------------|------------------------|----------------------|----------|---------------------------------|-----------------|-------------|-------------|--------------|
| 3700.40         | -43.69                 | 5.26                 | 3.00     | 9.88                            | -39.07          | -13.00      | -26.07      | H            |
| 5550.60         | -52.95                 | 6.11                 | 3.00     | 11.36                           | -47.70          | -13.00      | -34.70      | H            |
| 3700.40         | -44.92                 | 5.26                 | 3.00     | 9.88                            | -40.30          | -13.00      | -27.30      | V            |
| 5550.60         | -49.51                 | 6.11                 | 3.00     | 11.36                           | -44.26          | -13.00      | -31.26      | V            |

*GSM/TM1/GSM1900\_ Middle Channel*

| Frequency (MHz) | P <sub>Mea</sub> (dBm) | P <sub>cl</sub> (dB) | Diatance | G <sub>a</sub> Antenna Gain(dB) | Peak EIRP (dBm) | Limit (dBm) | Margin (dB) | Polarization |
|-----------------|------------------------|----------------------|----------|---------------------------------|-----------------|-------------|-------------|--------------|
| 3760.00         | -41.00                 | 5.32                 | 3.00     | 10.03                           | -36.29          | -13.00      | -23.29      | H            |
| 5640.00         | -54.25                 | 6.19                 | 3.00     | 11.41                           | -49.03          | -13.00      | -36.03      | H            |
| 3760.00         | -45.82                 | 5.32                 | 3.00     | 10.03                           | -41.11          | -13.00      | -28.11      | V            |
| 5640.00         | -49.70                 | 6.19                 | 3.00     | 11.41                           | -44.48          | -13.00      | -31.48      | V            |

*GSM/TM1/GSM1900\_ High Channel*

| Frequency (MHz) | P <sub>Mea</sub> (dBm) | P <sub>cl</sub> (dB) | Diatance | G <sub>a</sub> Antenna Gain(dB) | Peak EIRP (dBm) | Limit (dBm) | Margin (dB) | Polarization |
|-----------------|------------------------|----------------------|----------|---------------------------------|-----------------|-------------|-------------|--------------|
| 3819.60         | -41.48                 | 5.36                 | 3.00     | 9.62                            | -37.22          | -13.00      | -24.22      | H            |
| 5729.40         | -52.76                 | 6.24                 | 3.00     | 11.46                           | -47.54          | -13.00      | -34.54      | H            |
| 3819.60         | -40.98                 | 5.36                 | 3.00     | 9.62                            | -36.72          | -13.00      | -23.72      | V            |
| 5729.40         | -53.12                 | 6.24                 | 3.00     | 11.46                           | -47.90          | -13.00      | -34.90      | V            |

*GSM/TM3/GSM1900\_ Low Channel*

| Frequency (MHz) | P <sub>Mea</sub> (dBm) | P <sub>cl</sub> (dB) | Diatance | G <sub>a</sub> Antenna Gain(dB) | Peak EIRP (dBm) | Limit (dBm) | Margin (dB) | Polarization |
|-----------------|------------------------|----------------------|----------|---------------------------------|-----------------|-------------|-------------|--------------|
| 3700.40         | -43.90                 | 5.26                 | 3.00     | 9.88                            | -39.28          | -13.00      | -26.28      | H            |
| 5550.60         | -46.98                 | 6.11                 | 3.00     | 11.36                           | -41.73          | -13.00      | -28.73      | H            |
| 3700.40         | -40.94                 | 5.26                 | 3.00     | 9.88                            | -36.32          | -13.00      | -23.32      | V            |
| 5550.60         | -49.89                 | 6.11                 | 3.00     | 11.36                           | -44.64          | -13.00      | -31.64      | V            |

*GSM/TM3/GSM1900\_ Middle Channel*

| Frequency (MHz) | P <sub>Mea</sub> (dBm) | P <sub>cl</sub> (dB) | Diatance | G <sub>a</sub> Antenna Gain(dB) | Peak EIRP (dBm) | Limit (dBm) | Margin (dB) | Polarization |
|-----------------|------------------------|----------------------|----------|---------------------------------|-----------------|-------------|-------------|--------------|
| 3760.00         | -43.13                 | 5.32                 | 3.00     | 10.03                           | -38.42          | -13.00      | -25.42      | H            |
| 5640.00         | -47.79                 | 6.19                 | 3.00     | 11.41                           | -42.57          | -13.00      | -29.57      | H            |
| 3760.00         | -45.67                 | 5.32                 | 3.00     | 10.03                           | -40.96          | -13.00      | -27.96      | V            |
| 5640.00         | -49.03                 | 6.19                 | 3.00     | 11.41                           | -43.81          | -13.00      | -30.81      | V            |

*GSM/TM3/GSM1900\_ High Channel*

| Frequency (MHz) | P <sub>Mea</sub> (dBm) | P <sub>cl</sub> (dB) | Diatance | G <sub>a</sub> Antenna Gain(dB) | Peak EIRP (dBm) | Limit (dBm) | Margin (dB) | Polarization |
|-----------------|------------------------|----------------------|----------|---------------------------------|-----------------|-------------|-------------|--------------|
| 3819.60         | -43.45                 | 5.36                 | 3.00     | 9.62                            | -39.19          | -13.00      | -26.19      | H            |
| 5729.40         | -51.51                 | 6.24                 | 3.00     | 11.46                           | -46.29          | -13.00      | -33.29      | H            |
| 3819.60         | -41.65                 | 5.36                 | 3.00     | 9.62                            | -37.39          | -13.00      | -24.39      | V            |
| 5729.40         | -46.23                 | 6.24                 | 3.00     | 11.46                           | -41.01          | -13.00      | -28.01      | V            |

### 4.3 Occupied Bandwidth and Emission Bandwidth

#### TEST APPLICABLE

Similar to conducted emissions; occupied bandwidth measurements are only provided for selected frequencies in order to reduce the amount of submitted data. Data were taken at the extreme and mid frequencies of PCS1900 band and GSM850 band. The table below lists the measured 99% Bandwidth and -26dBc Bandwidth.

#### TEST CONFIGURATION

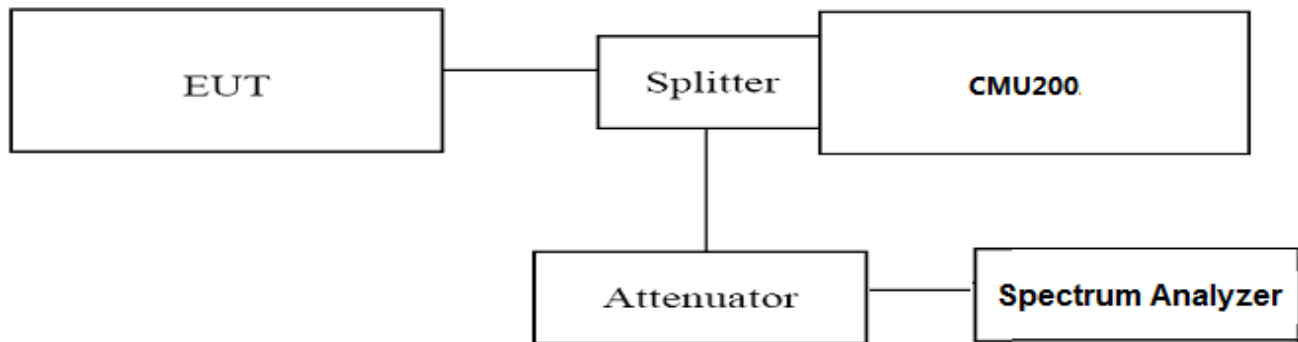

#### TEST PROCEDURE

1. The EUT was set up for the max output power with pseudo random data modulation;
2. The Occupied bandwidth and Emission Bandwidth were measured with Spectrum AnalyzerN9020A;
3. Set RBW=5.1KHz,VBW=51KHz,Span=1MHz,SWT=Auto;
4. Set SPA Max hold and View, Set 99% Occupied Bandwidth/ Set -26dBc Occupied Bandwidth
5. These measurements were done at 3 frequencies, 1850.20 MHz, 1880.00 MHz and 1909.80 MHz for PCS1900 band; 824.20MHz, 836.60 MHz and 848.80 MHz for GSM850 band. (Low, middle and high of operational frequency range).

#### TEST RESULTS

| Test Mode         | Channel | Frequency (MHz) | Occupied Bandwidth (99% BW) (KHz) | Emission Bandwidth (-26 dBc BW) (KHz) | Verdict |
|-------------------|---------|-----------------|-----------------------------------|---------------------------------------|---------|
| GSM/TM1 /GSM850   | 128     | 824.2           | 244.36                            | 313.8                                 | PASS    |
|                   | 190     | 836.6           | 244.81                            | 315.5                                 | PASS    |
|                   | 251     | 848.8           | 247.08                            | 316.2                                 | PASS    |
| GSM/TM3 /EDGE850  | 128     | 824.2           | 249.51                            | 308.5                                 | PASS    |
|                   | 190     | 836.6           | 247.81                            | 310.9                                 | PASS    |
|                   | 251     | 848.8           | 249.61                            | 314.0                                 | PASS    |
| GSM/TM1 /GSM1900  | 512     | 1850.2          | 247.33                            | 316.2                                 | PASS    |
|                   | 661     | 1880.0          | 244.38                            | 310.0                                 | PASS    |
|                   | 810     | 1909.8          | 247.07                            | 315.6                                 | PASS    |
| GSM/TM3 /EDGE1900 | 512     | 1850.2          | 250.28                            | 306.9                                 | PASS    |
|                   | 661     | 1880.0          | 248.98                            | 312.5                                 | PASS    |
|                   | 810     | 1909.8          | 247.51                            | 296.6                                 | PASS    |

#### Remark:

1. Test results including cable loss;
2. Please refer to following plots;



Occupied Bandwidth and Emission Bandwidth

GSM/TM1/GSM850

GSM/TM3/EDGE850

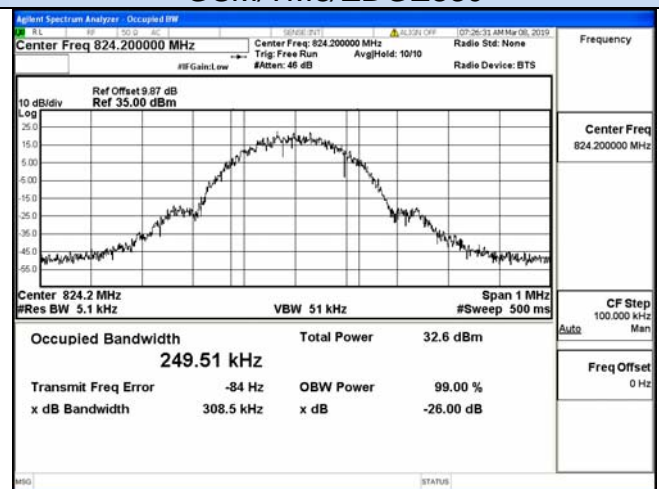
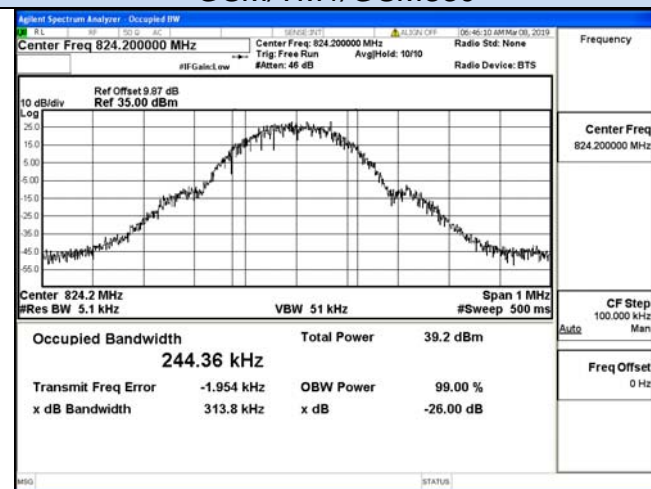

Channel 128 / 824.2 MHz

Channel 128 / 824.2 MHz

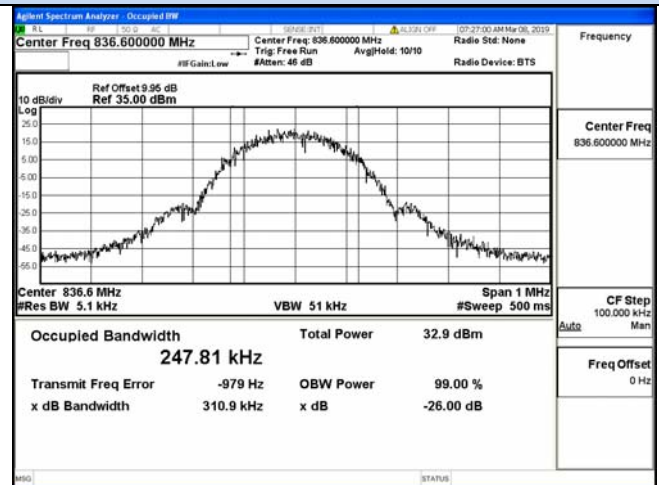
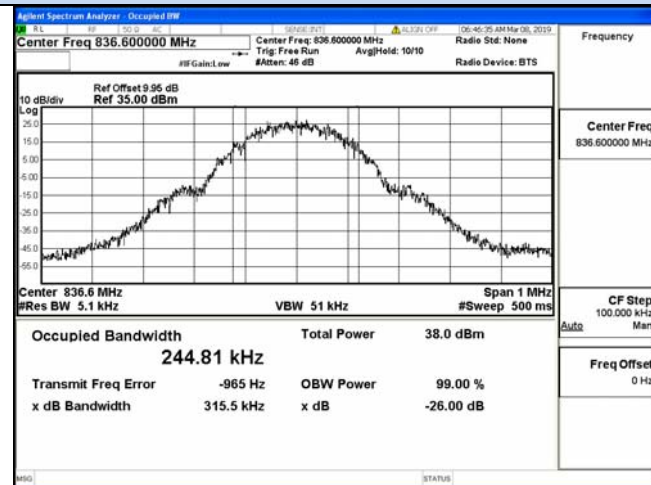

Channel 190 / 836.6 MHz

Channel 190 / 836.6 MHz

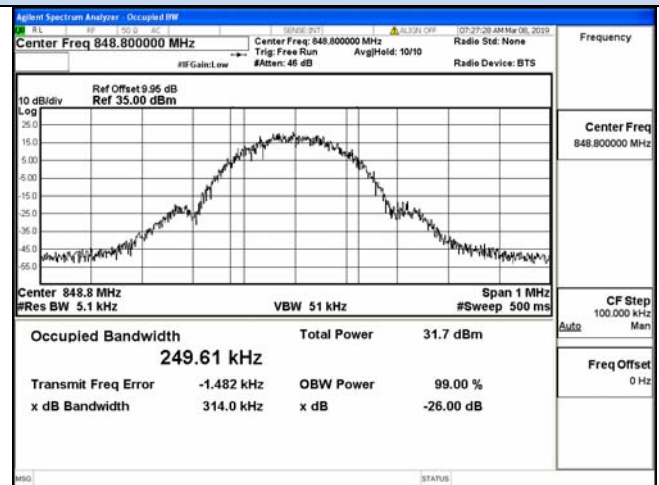
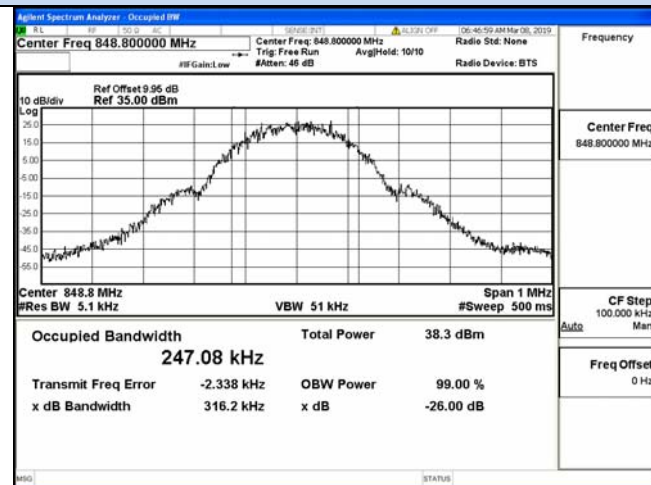

Channel 251 / 848.8 MHz

Channel 251 / 848.8 MHz

Occupied Bandwidth and Emission Bandwidth

GSM/TM1/GSM1900

GSM/TM3/EDGE1900

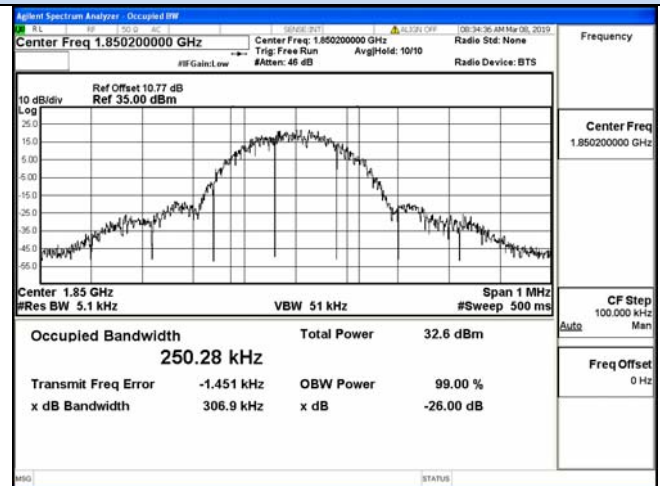
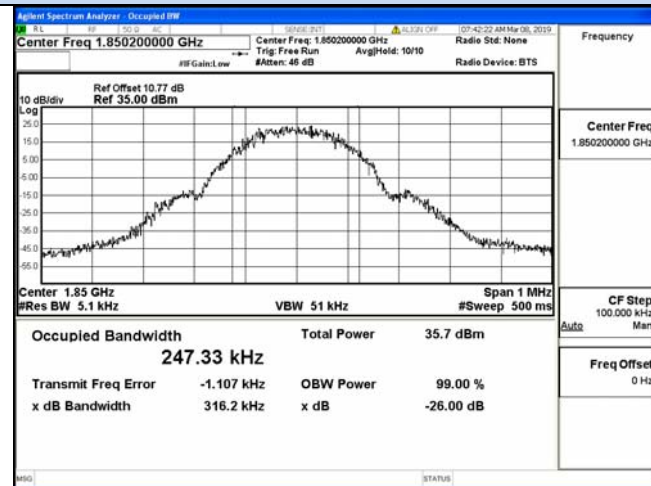

Channel 512 / 1850.2 MHz

Channel 512 / 1850.2 MHz

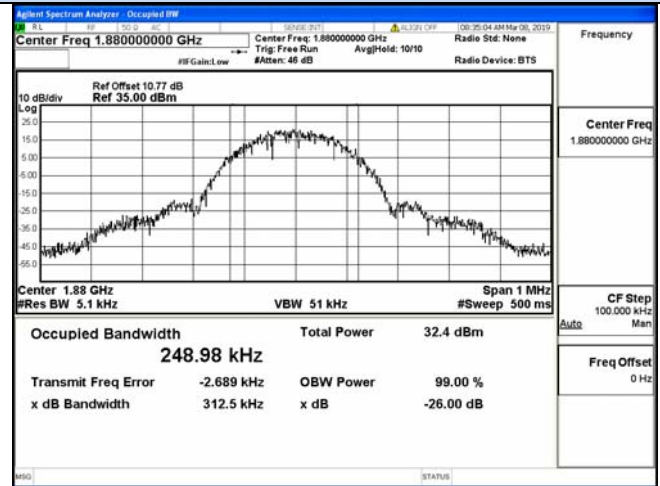
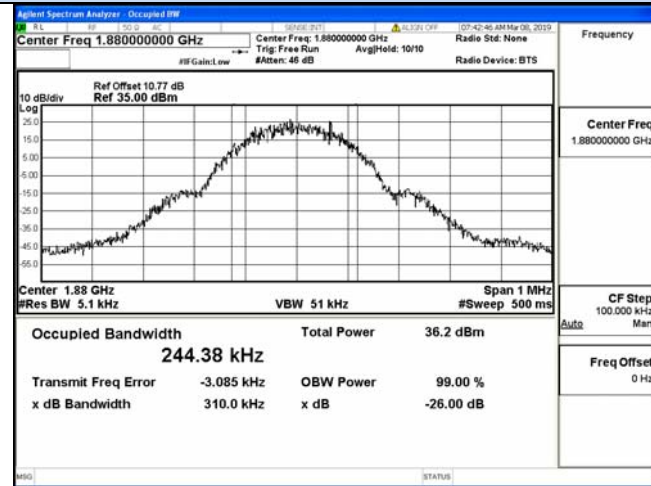

Channel 661 / 1880.0MHz

Channel 661 / 1880.0MHz

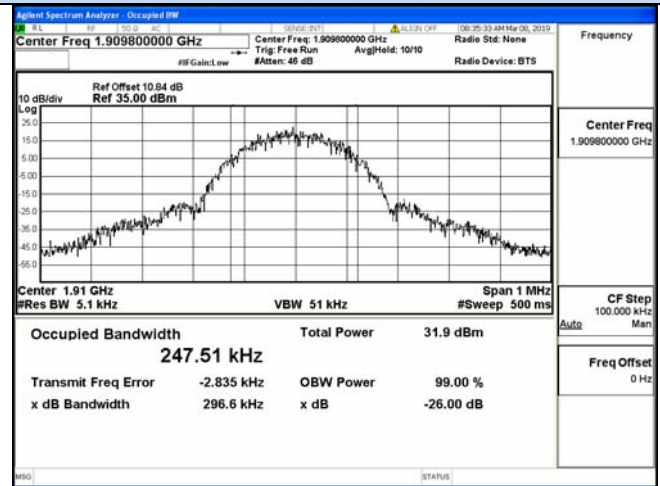
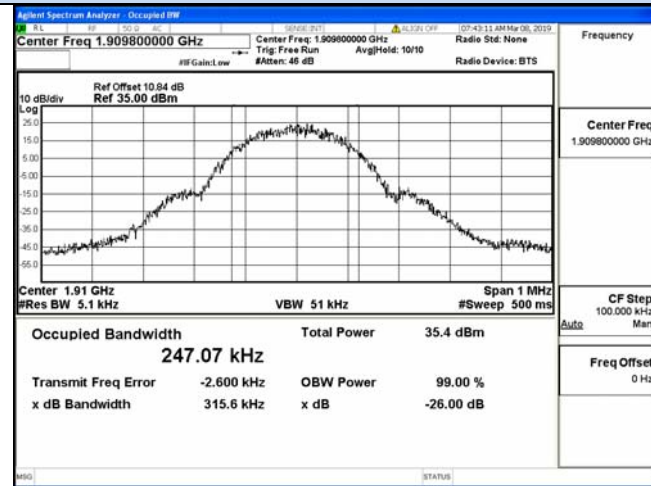

Channel 810 / 1909.8 MHz

Channel 810 / 1909.8 MHz



## 4.4 Band Edge Compliance

### TEST APPLICABLE

During the process of testing, the EUT was controlled via Digital Radio Communication tester (CMU200) to ensure max power transmission and proper modulation.

### TEST CONFIGURATION

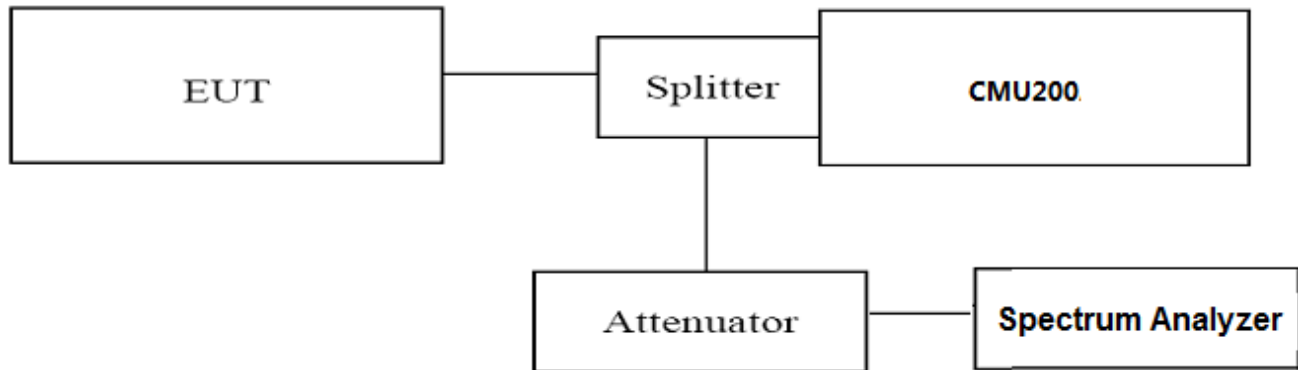

### TEST PROCEDURE

1. The EUT was set up for the max output power with pseudo random data modulation;
2. The power was measured with Spectrum Analyzer N9020A;
3. Set RBW=5.1KHz,VBW=51KHz,Span=2MHz,SWT=Auto, Dector: RMS;
1. These measurements were done at 2 frequencies, 1850.20 MHz and 1909.80 MHz for PCS1900 band; 824.20 MHz and 848.80 MHz for GSM850 band. (bottom and top of operational frequency range).

### TEST RESULTS

| Test Mode        | Channel | Frequency (MHz) | Band Edg Compliance (dBm) | Limits (dBm) | Verdict |
|------------------|---------|-----------------|---------------------------|--------------|---------|
| GSM/TM1/GSM850   | 128     | 824.2           | <-13dBm                   | -13dBm       | PASS    |
|                  | 251     | 848.8           | <-13dBm                   | -13dBm       |         |
| GSM/TM3/EDGE850  | 128     | 824.2           | <-13dBm                   | -13dBm       | PASS    |
|                  | 251     | 848.8           | <-13dBm                   | -13dBm       |         |
| GSM/TM1/GSM1900  | 512     | 1850.2          | <-13dBm                   | -13dBm       | PASS    |
|                  | 810     | 1909.8          | <-13dBm                   | -13dBm       |         |
| GSM/TM3/EDGE1900 | 512     | 1850.2          | <-13dBm                   | -13dBm       | PASS    |
|                  | 810     | 1909.8          | <-13dBm                   | -13dBm       |         |

#### Remark:

1. Test results including cable loss;
2. Please refer to following plots;

Band-edge Compliance

GSM/TM1/GSM850

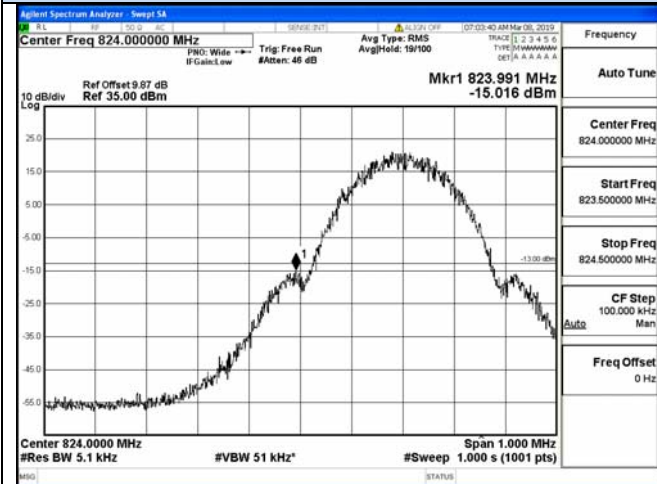

GSM/TM3/EDGE850

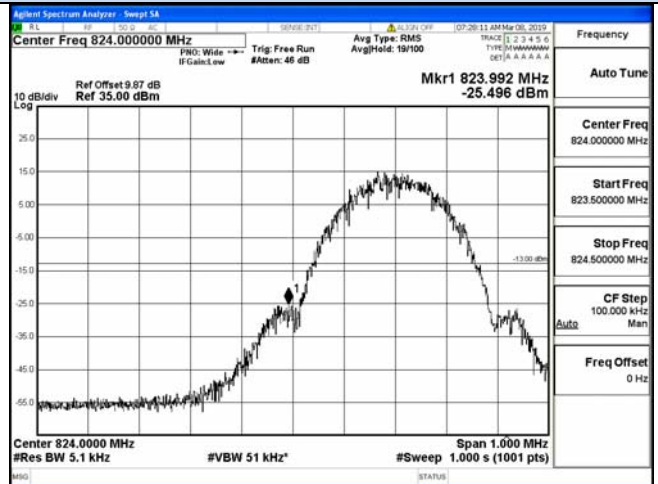

Channel 128 / 824.2 MHz

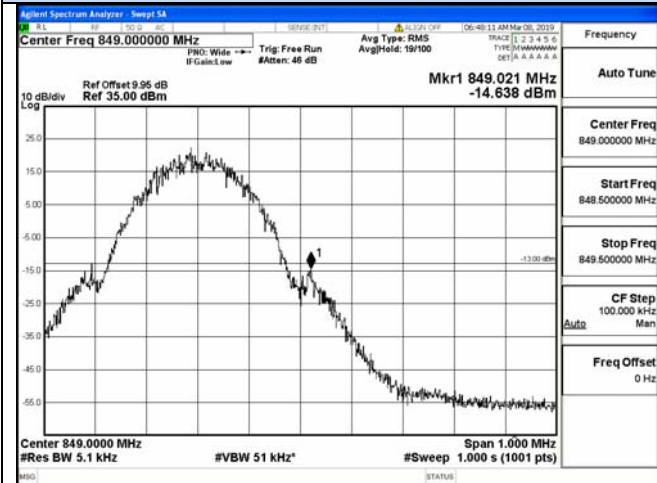

Channel 128 / 824.2 MHz

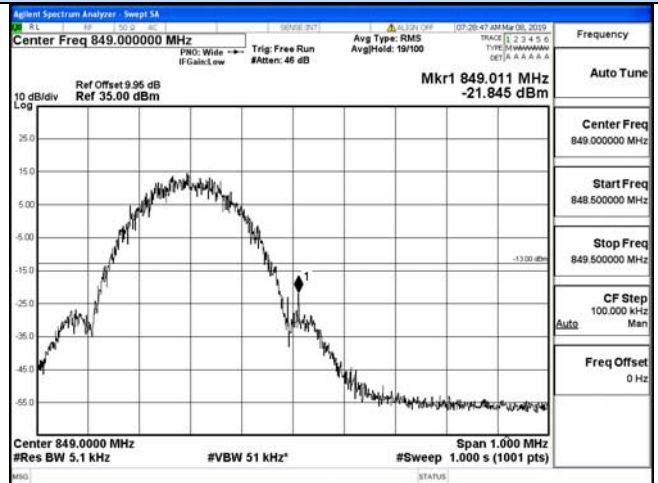

Channel 251 / 848.8 MHz



Channel 251 / 848.8 MHz



Band-edge Compliance

GSM/TM1/GSM1900

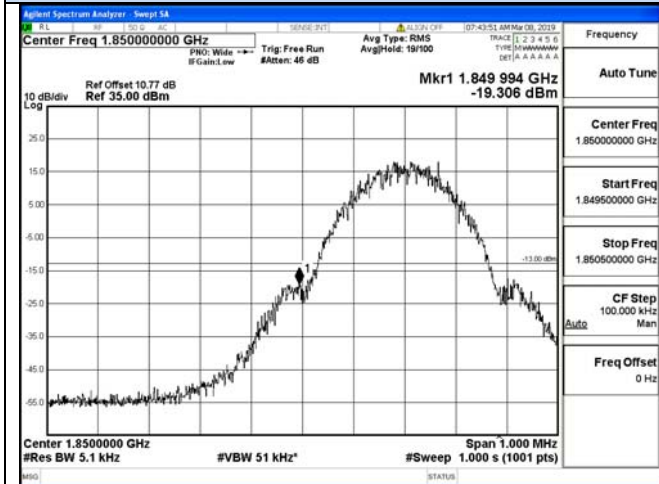

GSM/TM3/EDGE1900

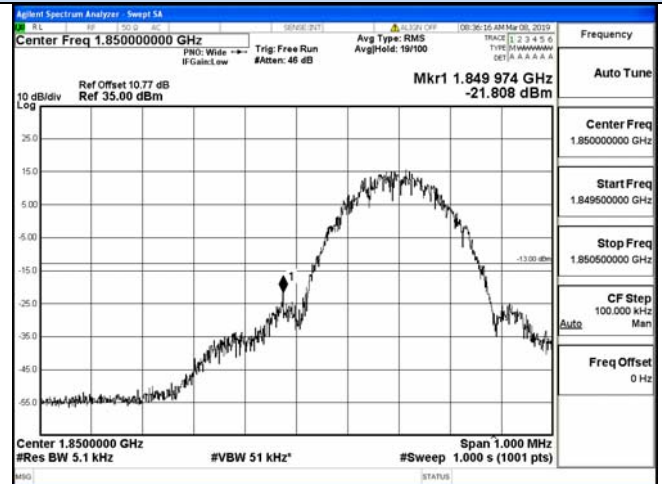

Channel 512 / 1850.2 MHz

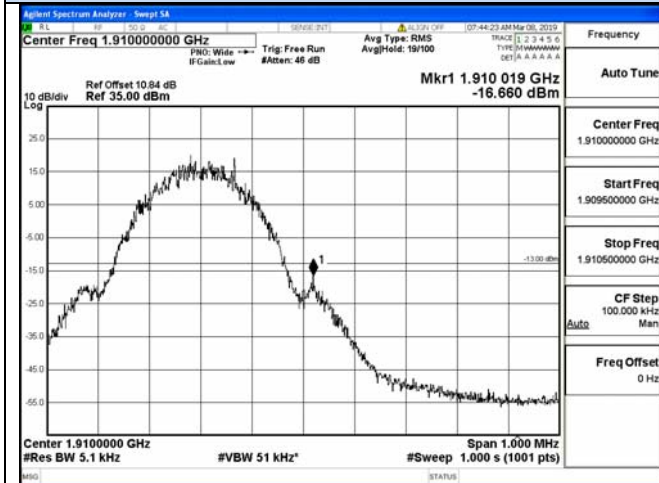

Channel 512 / 1850.2 MHz

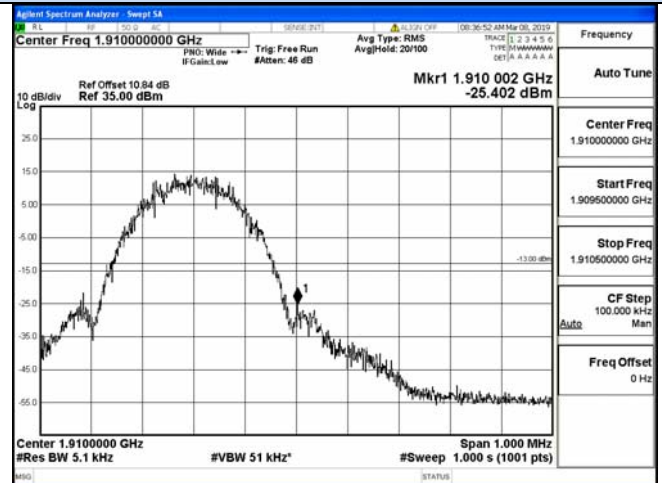

Channel 810 / 1909.8 MHz



Channel 810 / 1909.8 MHz



## 4.5 Spurious Emission on Antenna Port

### TEST APPLICABLE

The following steps outline the procedure used to measure the conducted emissions from the EUT.

1. Determine frequency range for measurements: From CFR 2.1057 and RSS-GEN the spectrum should be investigated from the lowest radio frequency generated in the equipment up to at least the 10<sup>th</sup> harmonic of the carrier frequency. For the equipment of PCS1900 band, this equates to a frequency range of 9 KHz to 20 GHz, data taken from 30 MHz to 20 GHz. For GSM850, this equates to a frequency range of 9 KHz to 9 GHz, data taken from 30 MHz to 9 GHz.
2. The sweep time is set automatically by instrument itself. That should be the optimal sweep time for the span and the RBW. If the sweep time is too short, that is sweep is too fast, the sweep result is not accurate; if the sweep time is too long, that is sweep is too low, some frequency components may be lost. The instrument will give an optimal sweep time according the selected span and RBW.
3. The procedure to get the conducted spurious emission is as follows:  
The trace mode is set to MaxHold to get the highest signal at each frequency;  
Wait 25 seconds;  
Get the result.
4. Determine EUT transmit frequencies: below outlines the band edge frequencies pertinent to conducted emissions testing.

### TEST CONFIGURATION

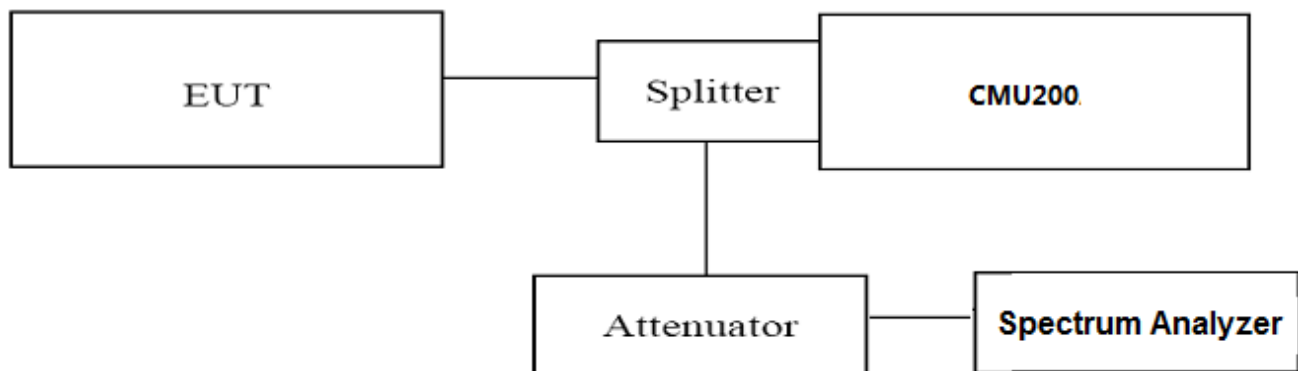

### TEST PROCEDURE

1. The EUT was set up for the max output power with pseudo random data modulation;
2. The power was measured with Spectrum Analyzer N9020A;
3. These measurements were done at 3 frequencies, 1850.20 MHz, 1880.00 MHz and 1909.80 MHz for PCS1900 band; 824.20 MHz, 836.60 MHz and 848.80 MHz for GSM850 band. (Low, middle and high of operational frequency range).

### TEST LIMIT

Part 24.238, Part 22.917 specify that the power of any emission outside of the authorized operating frequency ranges must be attenuated below the transmitting power (P) by a factor of at least  $43 + 10 \log(P)$  dB. The specification that emissions shall be attenuated below the transmitter power (P) by at least  $43 + 10 \log(P)$  dB, translates in the relevant power range (1 to 0.001 W) to -13 dBm. At 1 W the specified minimum attenuation becomes 43 dB and relative to a 30 dBm (1 W) carrier becomes a limit of -13 dBm. At 0.001 W (0 dBm) the minimum attenuation is 13 dB, which again yields a limit of -13 dBm. In this way a translation of the specification from relative to absolute terms is carried out.

**TEST RESULTS**

| Test Mode        | Channel | Frequency (MHz) | Spurious RF Conducted Emission (dBm) | Limits (dBm) | Verdict |
|------------------|---------|-----------------|--------------------------------------|--------------|---------|
| GSM/TM1/GSM850   | 128     | 824.2           | <-13dBm                              | -13dBm       | PASS    |
|                  | 190     | 836.6           | <-13dBm                              | -13dBm       |         |
|                  | 251     | 848.8           | <-13dBm                              | -13dBm       |         |
| GSM/TM3/EDGE850  | 128     | 824.2           | <-13dBm                              | -13dBm       | PASS    |
|                  | 190     | 836.6           | <-13dBm                              | -13dBm       |         |
|                  | 251     | 848.8           | <-13dBm                              | -13dBm       |         |
| GSM/TM1/GSM1900  | 512     | 1850.2          | <-13dBm                              | -13dBm       | PASS    |
|                  | 661     | 1880.0          | <-13dBm                              | -13dBm       |         |
|                  | 810     | 1909.8          | <-13dBm                              | -13dBm       |         |
| GSM/TM3/EDGE1900 | 512     | 1850.2          | <-13dBm                              | -13dBm       | PASS    |
|                  | 661     | 1880.0          | <-13dBm                              | -13dBm       |         |
|                  | 810     | 1909.8          | <-13dBm                              | -13dBm       |         |

**Remark:**

1. Test results including cable loss;
2. Please refer to following plots;
3. Not recorded test plots from 9 KHz to 30 MHz as emission levels 20dB lower than emission limit;

Spurious Emission on Antenna Port

GSM/TM1/GSM850

Channel 128 / 824.2 MHz

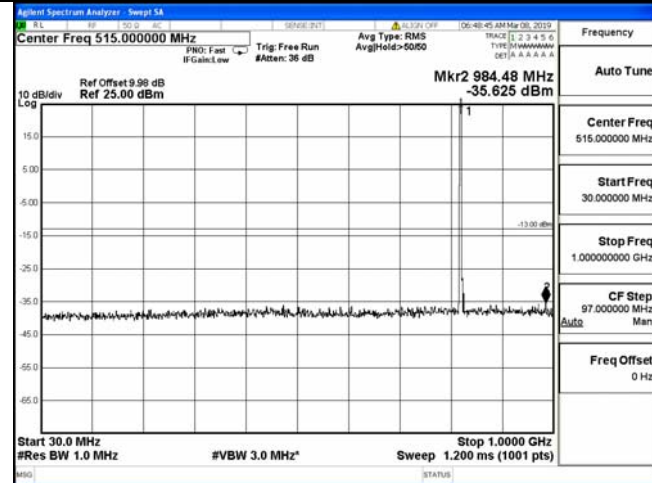

GSM/TM3/EDGE850

Channel 128 / 824.2 MHz

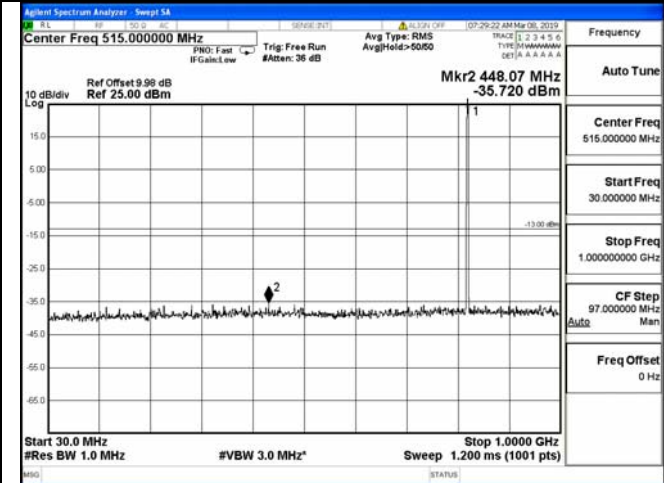

30 MHz – 1000 MHz

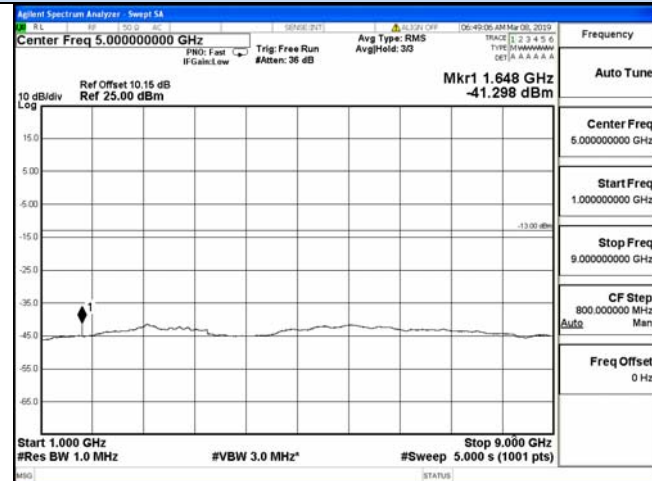

30 MHz – 1000 MHz

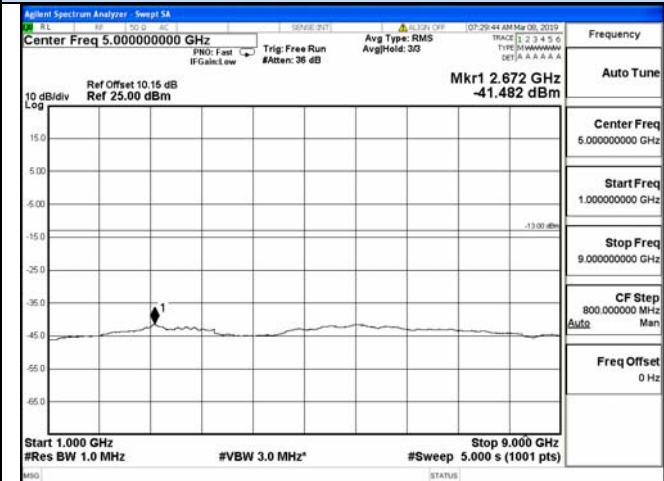

1 GHz – 9 GHz

Channel 190 / 836.6 MHz

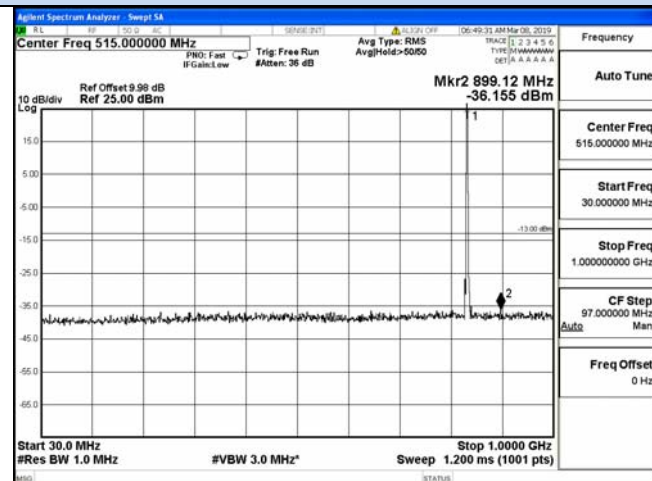

1 GHz – 9 GHz

Channel 190 / 836.6 MHz

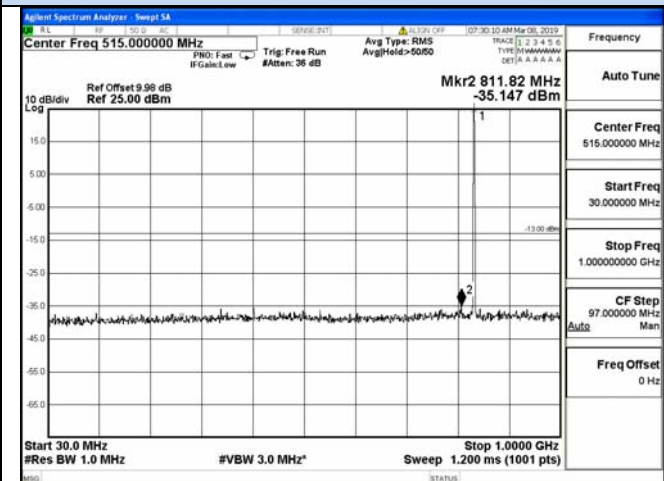

30 MHz – 1000 MHz

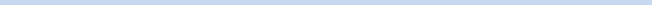

30 MHz – 1000 MHz

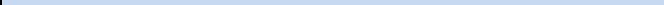



Spurious Emission on Antenna Port

GSM/TM1/GSM850

Channel 190 / 836.6 MHz

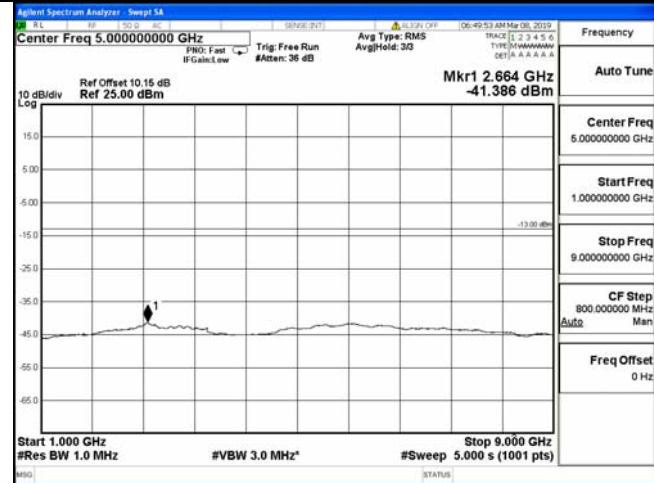

1 GHz – 9 GHz

Channel 251 / 848.8 MHz

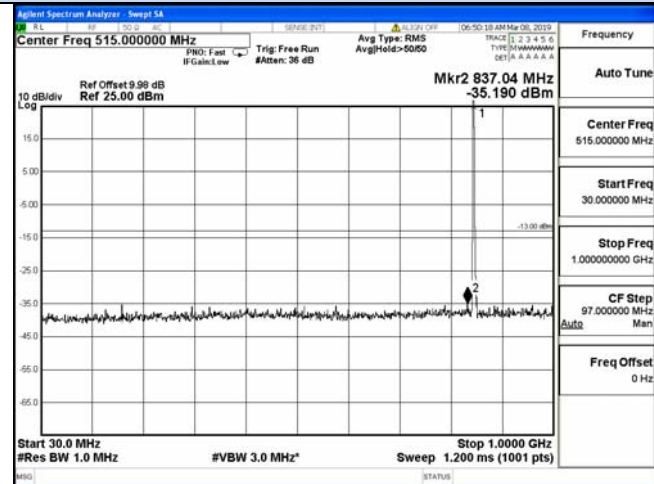

30 MHz – 1000 MHz

Channel 190 / 836.6 MHz

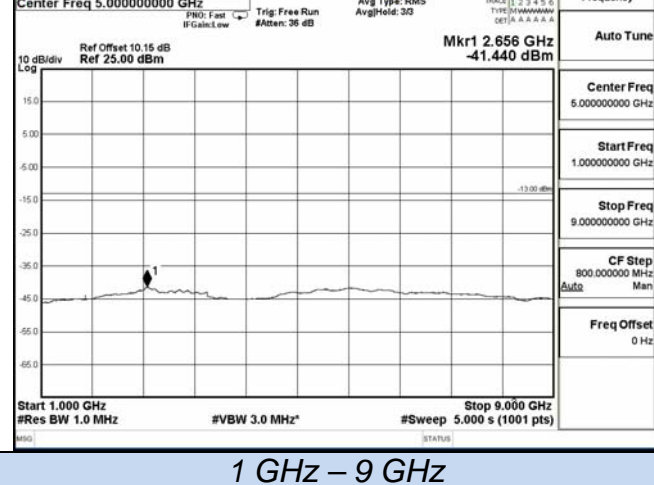

1 GHz – 9 GHz

GSM/TM3/EDGE850

Channel 190 / 836.6 MHz

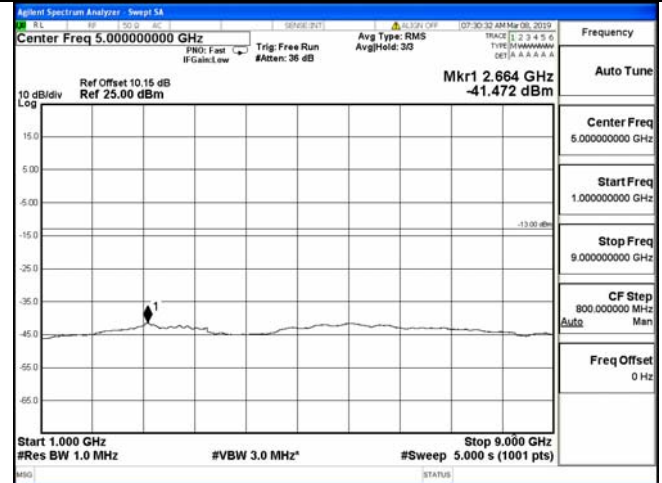

1 GHz – 9 GHz

Channel 251 / 848.8 MHz

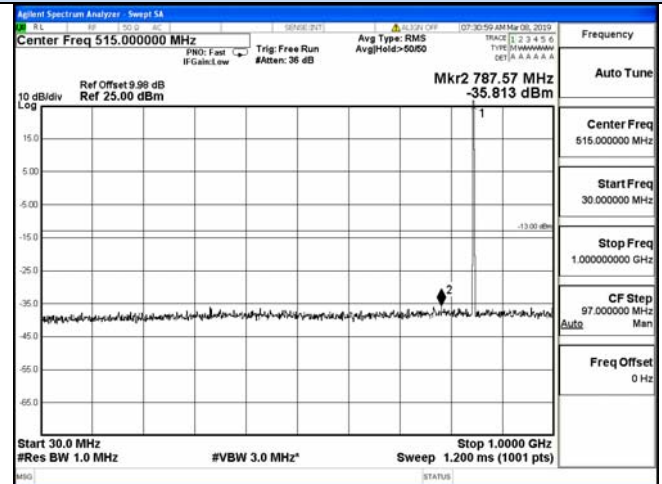

30 MHz – 1000 MHz

Channel 190 / 836.6 MHz

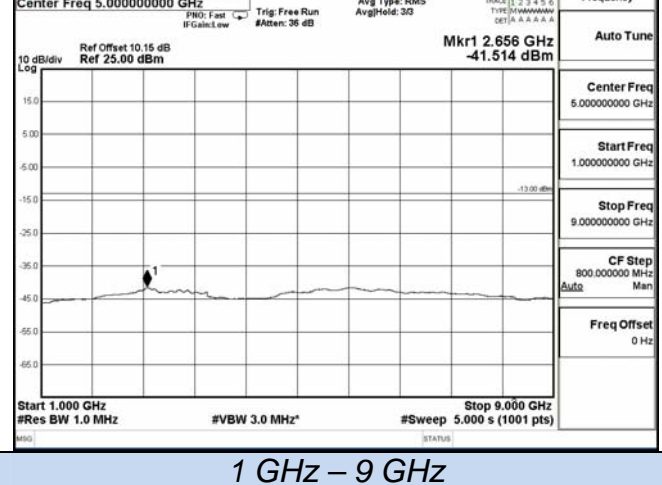

1 GHz – 9 GHz

**Spurious Emssion on Antenna Port**  
**GSM/TM1/GSM1900**  
**Channel 512 / 1850.2 MHz**

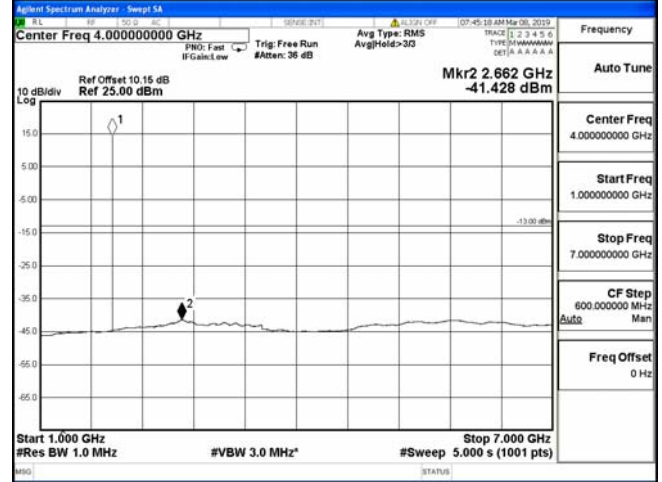
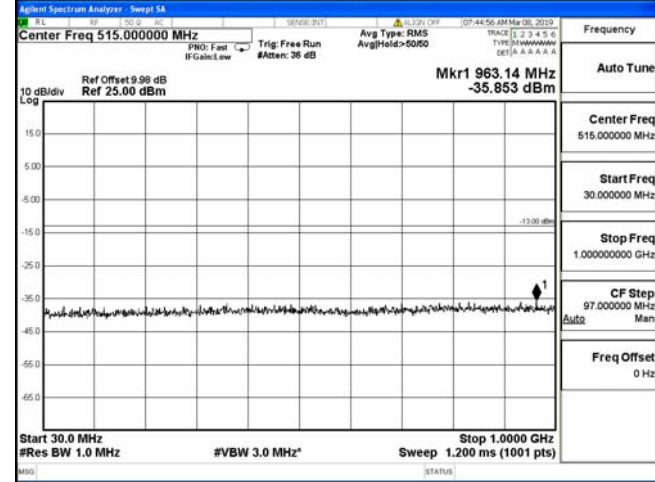

**30 MHz – 1000 MHz**

**1 GHz – 7 GHz**

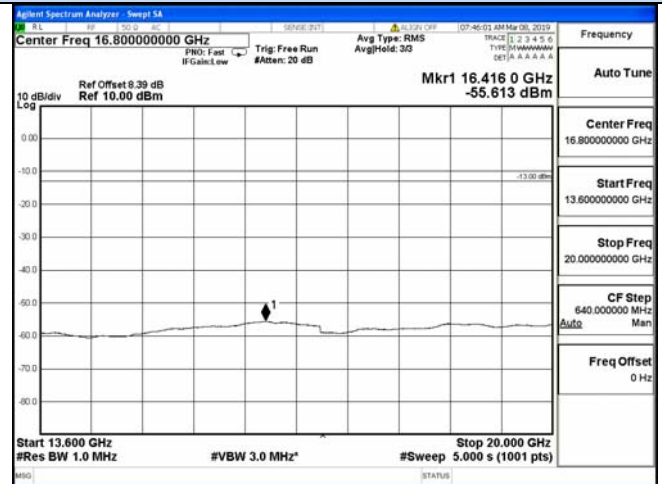
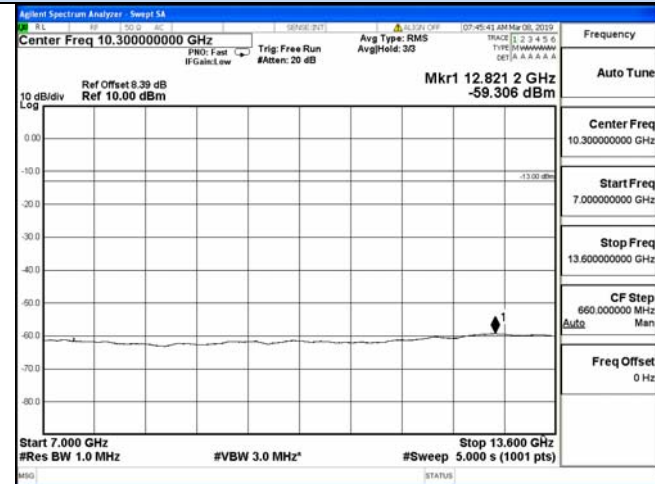

**7 GHz – 13.6 GHz**

**13.6 GHz – 20 GHz**



**Spurious Emission on Antenna Port**  
**GSM/TM1/GSM1900**  
**Channel 661 / 1880 MHz**

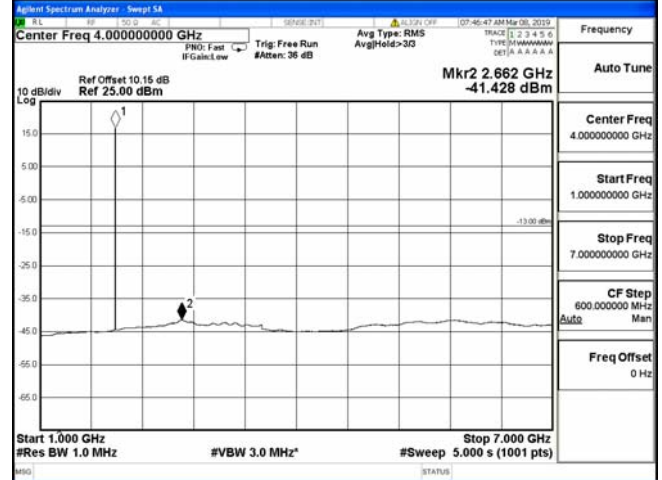
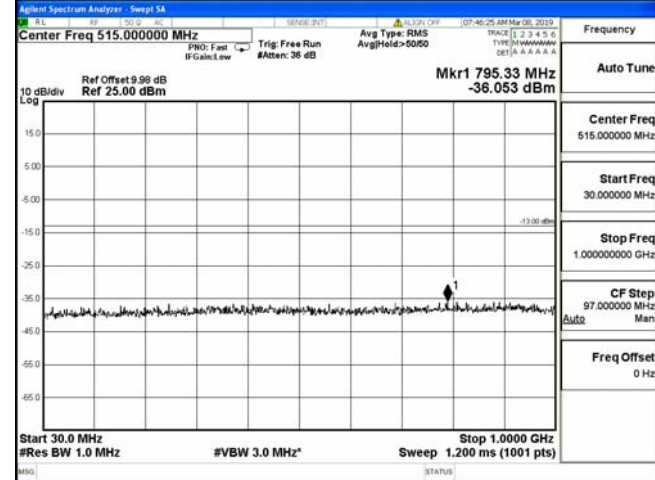

**30 MHz – 1000 MHz**

**1 GHz – 7 GHz**

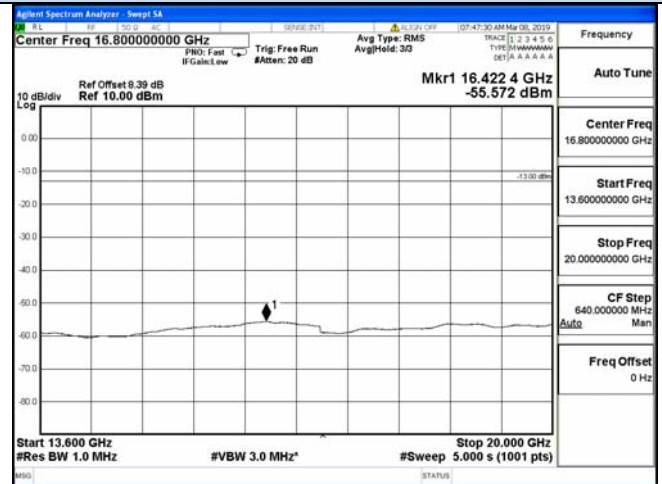
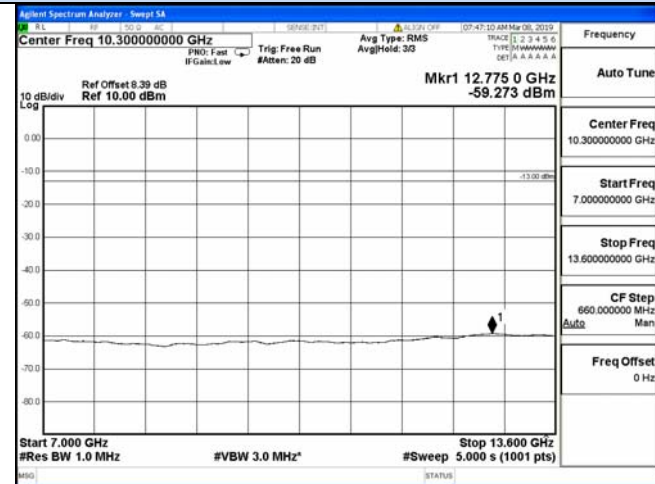

**7 GHz – 13.6 GHz**

**13.6 GHz – 20 GHz**

**Spurious Emission on Antenna Port**  
**GSM/TM1/GSM1900**  
**Channel 810 / 1909.8 MHz**

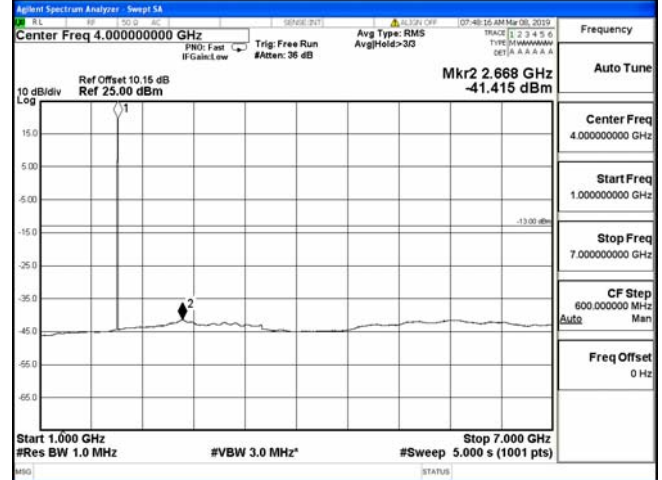
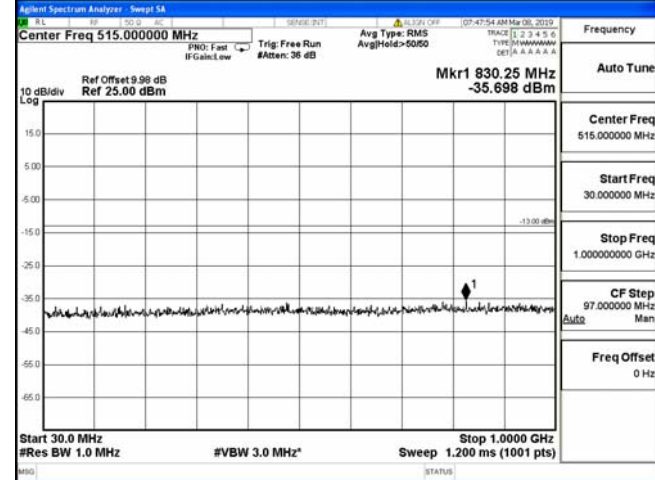

**30 MHz – 1000 MHz**

**1 GHz – 7 GHz**

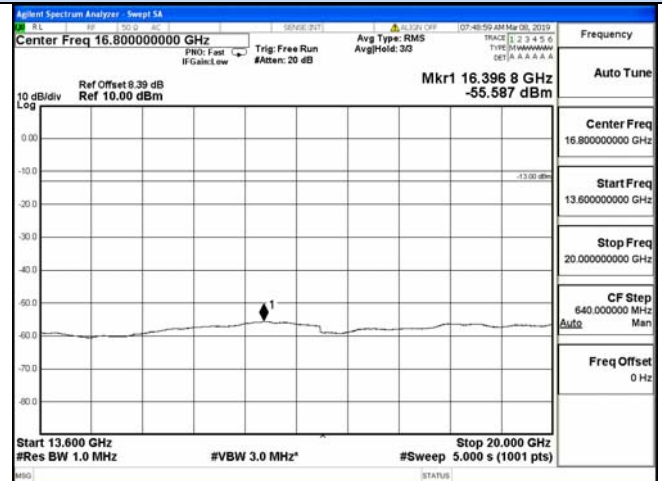
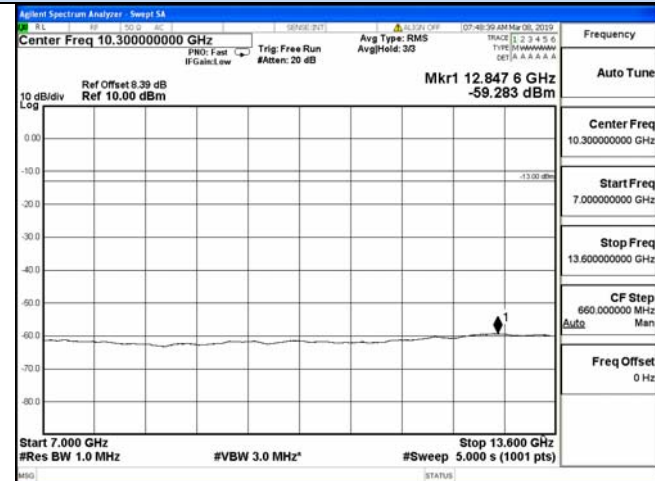

**7 GHz – 13.6 GHz**

**13.6 GHz – 20 GHz**

**Spurious Emssion on Antenna Port**  
**GSM/TM3/EDGE1900**  
**Channel 512 / 1850.2 MHz**

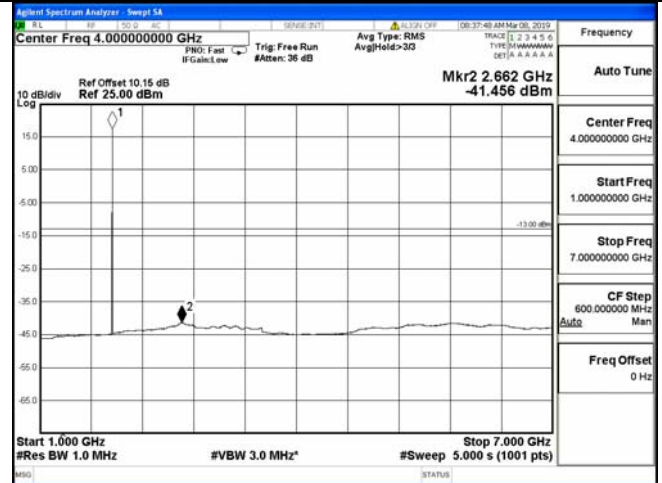
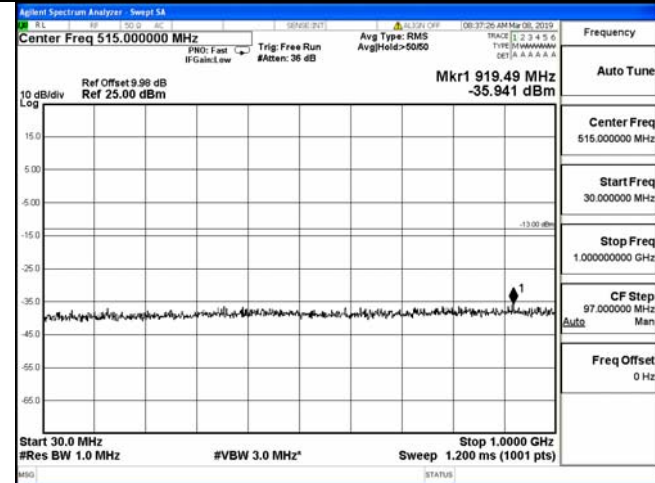

**30 MHz – 1000 MHz**

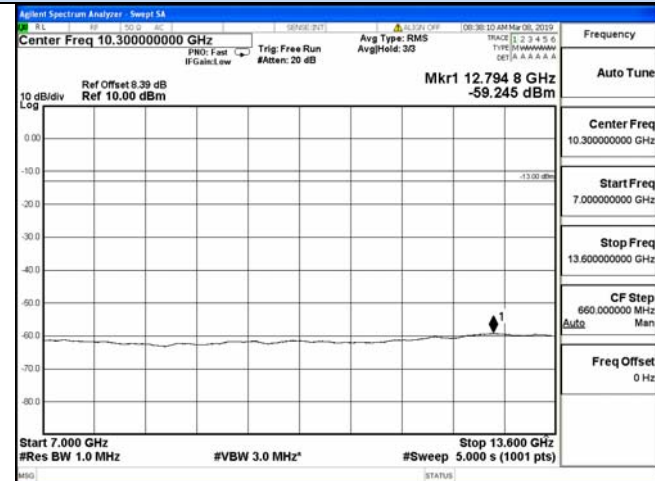

**1 GHz – 7 GHz**

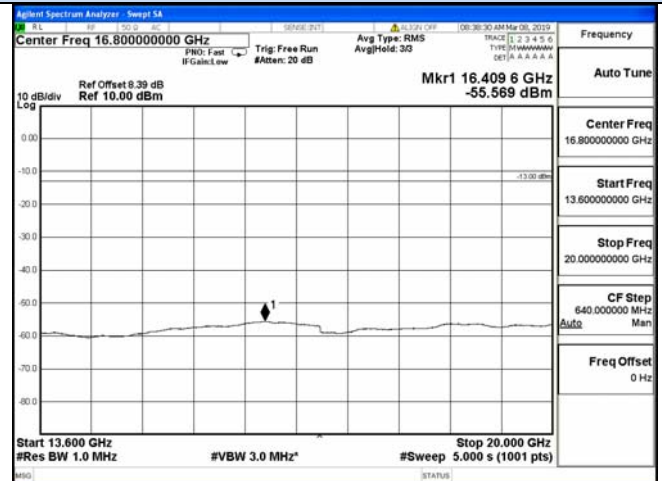

**7 GHz – 13.6 GHz**

**13.6 GHz – 20 GHz**

**Spurious Emission on Antenna Port**  
**GSM/TM3/EDGE1900**  
**Channel 661 / 1880 MHz**

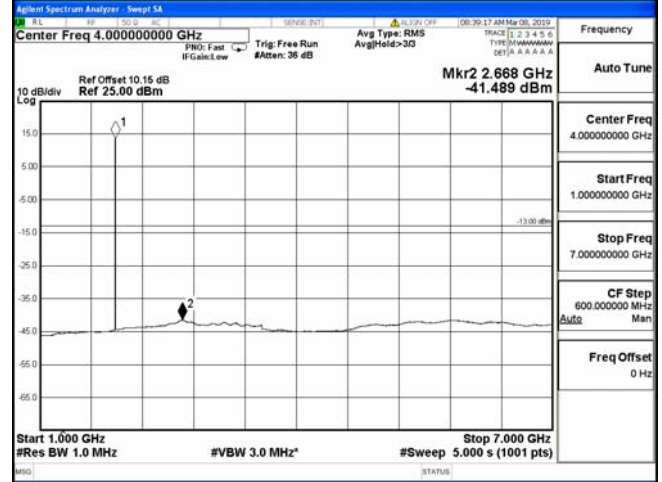
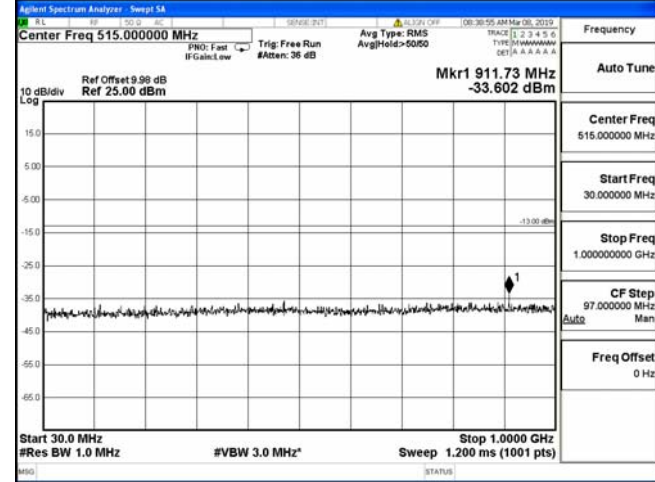

**30 MHz – 1000 MHz**

**1 GHz – 7 GHz**

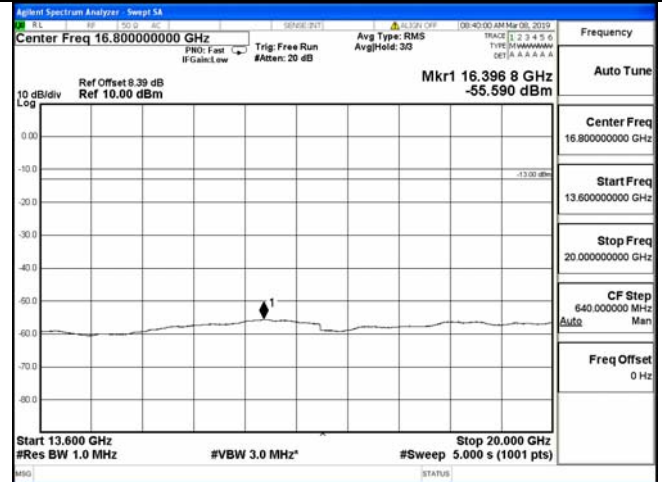
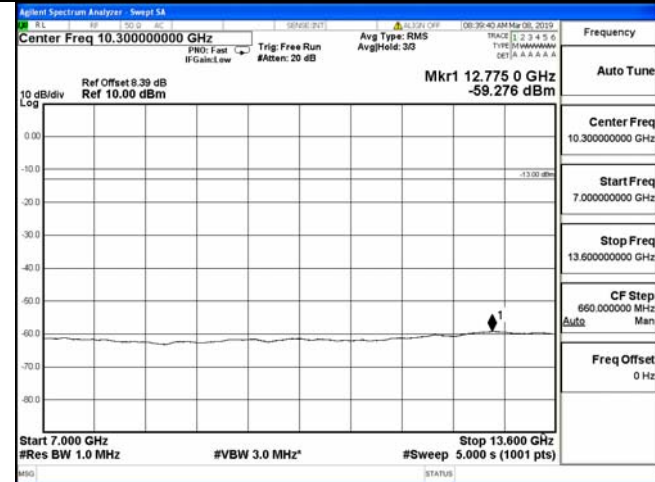

**7 GHz – 13.6 GHz**

**13.6 GHz – 20 GHz**

**Spurious Emssion on Antenna Port**  
**GSM/TM3/EDGE1900**  
**Channel 810 / 1909.8 MHz**

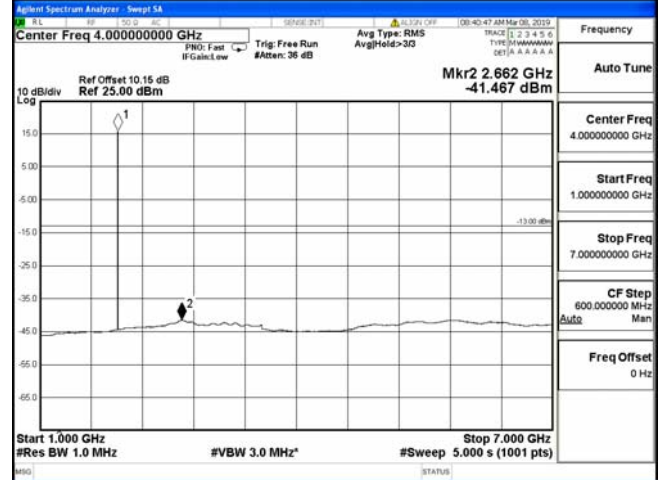
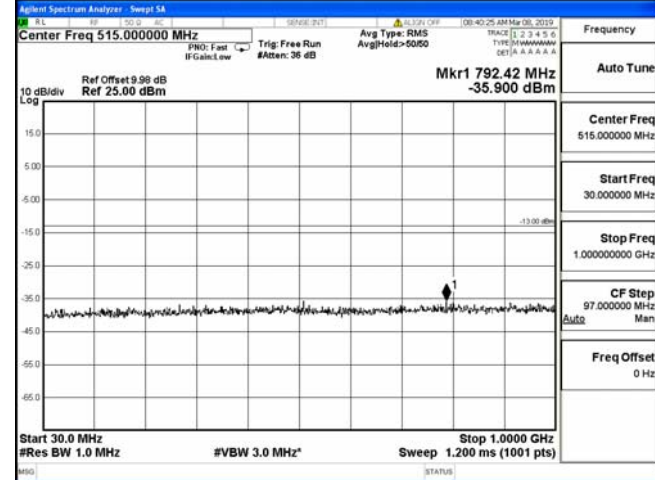

**30 MHz – 1000 MHz**

**1 GHz – 7 GHz**

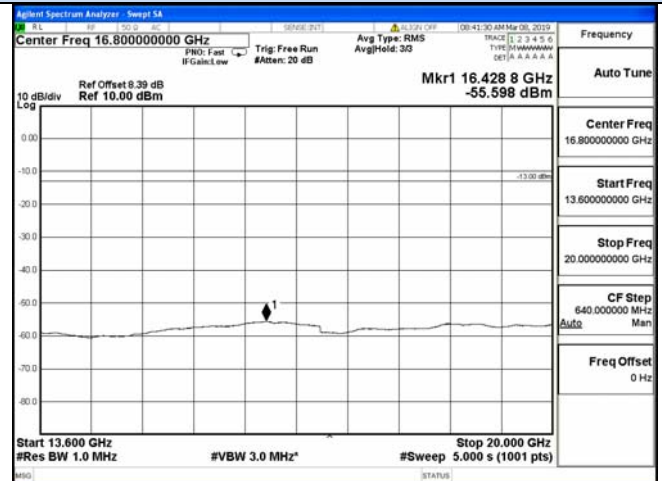
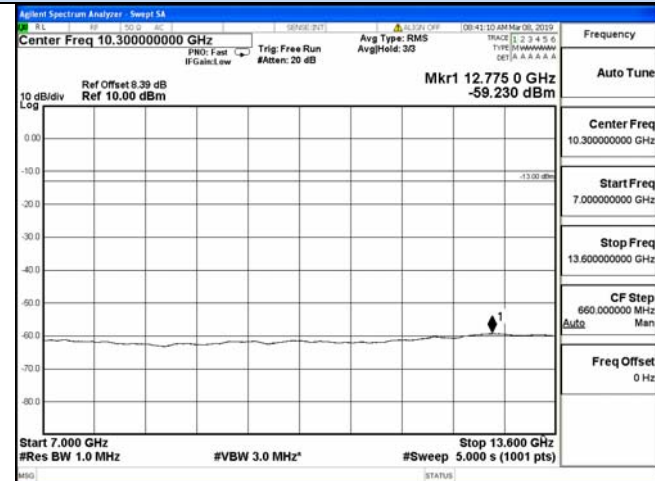

**7 GHz – 13.6 GHz**

**13.6 GHz – 20 GHz**

## 4.6 Frequency Stability Test

### TEST APPLICABLE

1. According to FCC Part 2 Section 2.1055 (a)(1) and RSS-GEN, the frequency stability shall be measured with variation of ambient temperature from  $-30^{\circ}\text{C}$  to  $+50^{\circ}\text{C}$  centigrade.
2. According to FCC Part 2 Section 2.1055 (E) (2) and RSS-GEN, for battery powered equipment, the frequency stability shall be measured with reducing primary supply voltage to the battery operating end point, which is specified by the manufacture.
3. Vary primary supply voltage from 85 to 115 percent of the nominal value for other than hand carried voltage equipment and the end voltage point was 3.40V.

### TEST PROCEDURE

In order to measure the carrier frequency under the condition of AFC lock, it is necessary to make measurements with the EUT in a "call mode". This is accomplished with the use of R&S CMU200 DIGITAL RADIO COMMUNICATION TESTER.

1. Measure the carrier frequency at room temperature;
2. Subject the EUT to overnight soak at  $-30^{\circ}\text{C}$ ;
3. With the EUT, powered via nominal voltage, connected to the CMU200 and in a simulated call on middle channel of PCS 1900 and GSM850, measure the carrier frequency. These measurements should be made within 2 minutes of Powering up the EUT, to prevent significant self-warming;
4. Repeat the above measurements at  $10^{\circ}\text{C}$  increments from  $-30^{\circ}\text{C}$  to  $+50^{\circ}\text{C}$ . Allow at least 0.5 hours at each temperature, unpowered, before making measurements;
5. Remeasure carrier frequency at room temperature with nominal voltage. Vary supply voltage from minimum voltage to maximum voltage, in 0.1Volt increments remeasuring carrier frequency at each voltage. Pause at nominal voltage for 0.5 hours unpowered, to allow any self-heating to stabilize, before continuing;
6. Subject the EUT to overnight soak at  $+50^{\circ}\text{C}$ ;
7. With the EUT, powered via nominal voltage, connected to the CMU200 and in a simulated call on the centre channel, measure the carrier frequency. These measurements should be made within 2 minutes of Powering up the EUT, to prevent significant self-warming;
8. Repeat the above measurements at  $10^{\circ}\text{C}$  increments from  $+50^{\circ}\text{C}$  to  $-30^{\circ}\text{C}$ . Allow at least 0.5 hours at each temperature, unpowered, before making measurements;
9. At all temperature levels hold the temperature to  $\pm 0.5^{\circ}\text{C}$  during the measurement procedure;

### TEST CONFIGURATION

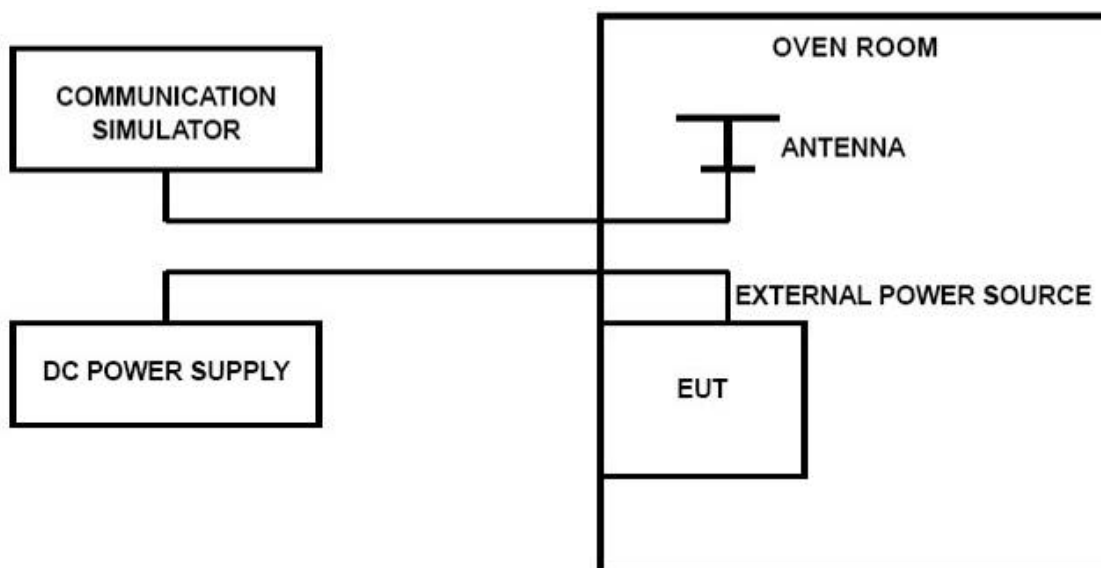

**TEST LIMITS****For Hand carried battery powered equipment**

According to the JTC standard the frequency stability of the carrier shall be accurate to within 0.1 ppm of the received frequency from the base station. This accuracy is sufficient to meet Sec. 24.235, Frequency Stability. The frequency stability shall be sufficient to ensure that the fundamental emission stays within the authorized frequency block. As this transceiver is considered "Hand carried, battery powered equipment" Section 2.1055(d)(2) applies. This requires that the lower voltage for frequency stability testing be specified by the manufacturer. This transceiver is specified to operate with an input voltage of between 3.40VDC and 4.20VDC, with a nominal voltage of 3.80DC. Operation above or below these voltage limits is prohibited by transceiver software in order to prevent improper operation as well as to protect components from overstress. These voltages represent a tolerance of -10 % and +12.5 %. For the purposes of measuring frequency stability these voltage limits are to be used.

**For equipment powered by primary supply voltage**

According to the JTC standard the frequency stability of the carrier shall be accurate to within 0.1 ppm of the received frequency from the base station. This accuracy is sufficient to meet Sec. 24.235, Frequency Stability. The frequency stability shall be sufficient to ensure that the fundamental emission stays within the authorized frequency block. For this EUT section 2.1055(d)(1) applies. This requires varying primary supply voltage from 85 to 115 percent of the nominal value for other than hand carried battery equipment.

**TEST RESULTS**

| GSM/TM1/GSM850 |                  |                     |                      |             |         |
|----------------|------------------|---------------------|----------------------|-------------|---------|
| DC Power       | Temperature (°C) | Frequency error(Hz) | Frequency error(ppm) | Limit (ppm) | Verdict |
| 6.66           | 25               | -37                 | -0.045               | 2.50        | PASS    |
| 7.40           | 25               | 18                  | 0.022                | 2.50        | PASS    |
| 8.14           | 25               | -34                 | -0.041               | 2.50        | PASS    |
| 7.40           | -30              | 29                  | 0.035                | 2.50        | PASS    |
| 7.40           | -20              | -37                 | -0.045               | 2.50        | PASS    |
| 7.40           | -10              | -41                 | -0.050               | 2.50        | PASS    |
| 7.40           | 0                | -26                 | -0.032               | 2.50        | PASS    |
| 7.40           | 10               | 33                  | 0.040                | 2.50        | PASS    |
| 7.40           | 20               | 1                   | 0.001                | 2.50        | PASS    |
| 7.40           | 30               | 17                  | 0.021                | 2.50        | PASS    |
| 7.40           | 40               | -32                 | -0.039               | 2.50        | PASS    |
| 7.40           | 50               | -29                 | -0.035               | 2.50        | PASS    |

| GSM/TM3/EDGE850 |                  |                     |                      |             |         |
|-----------------|------------------|---------------------|----------------------|-------------|---------|
| DC Power        | Temperature (°C) | Frequency error(Hz) | Frequency error(ppm) | Limit (ppm) | Verdict |
| 6.66            | 25               | -20                 | -0.024               | 2.50        | PASS    |
| 7.40            | 25               | -11                 | -0.013               | 2.50        | PASS    |
| 8.14            | 25               | 27                  | 0.033                | 2.50        | PASS    |
| 7.40            | -30              | -48                 | -0.058               | 2.50        | PASS    |
| 7.40            | -20              | 44                  | 0.053                | 2.50        | PASS    |
| 7.40            | -10              | -42                 | -0.051               | 2.50        | PASS    |
| 7.40            | 0                | -18                 | -0.022               | 2.50        | PASS    |
| 7.40            | 10               | 3                   | 0.004                | 2.50        | PASS    |
| 7.40            | 20               | -46                 | -0.056               | 2.50        | PASS    |
| 7.40            | 30               | -50                 | -0.061               | 2.50        | PASS    |
| 7.40            | 40               | -44                 | -0.053               | 2.50        | PASS    |
| 7.40            | 50               | 50                  | 0.061                | 2.50        | PASS    |

| GSM/TM1/GSM1900 |                  |                     |                      |             |         |
|-----------------|------------------|---------------------|----------------------|-------------|---------|
| DC Power        | Temperature (°C) | Frequency error(Hz) | Frequency error(ppm) | Limit (ppm) | Verdict |
| 6.66            | 25               | 3                   | 0.002                | 2.50        | PASS    |
| 7.40            | 25               | -10                 | -0.005               | 2.50        | PASS    |
| 8.14            | 25               | -23                 | -0.012               | 2.50        | PASS    |
| 7.40            | -30              | 39                  | 0.021                | 2.50        | PASS    |
| 7.40            | -20              | -34                 | -0.018               | 2.50        | PASS    |
| 7.40            | -10              | -17                 | -0.009               | 2.50        | PASS    |
| 7.40            | 0                | 6                   | 0.003                | 2.50        | PASS    |
| 7.40            | 10               | 44                  | 0.023                | 2.50        | PASS    |
| 7.40            | 20               | 41                  | 0.022                | 2.50        | PASS    |
| 7.40            | 30               | 26                  | 0.014                | 2.50        | PASS    |
| 7.40            | 40               | 8                   | 0.004                | 2.50        | PASS    |
| 7.40            | 50               | 3                   | 0.002                | 2.50        | PASS    |

| GSM/TM3/EDGE1900 |                  |                     |                      |             |         |
|------------------|------------------|---------------------|----------------------|-------------|---------|
| DC Power         | Temperature (°C) | Frequency error(Hz) | Frequency error(ppm) | Limit (ppm) | Verdict |
| 6.66             | 25               | -5                  | -0.003               | 2.50        | PASS    |
| 7.40             | 25               | -45                 | -0.024               | 2.50        | PASS    |
| 8.14             | 25               | 30                  | 0.016                | 2.50        | PASS    |
| 7.40             | -30              | -17                 | -0.009               | 2.50        | PASS    |
| 7.40             | -20              | 2                   | 0.001                | 2.50        | PASS    |
| 7.40             | -10              | -21                 | -0.011               | 2.50        | PASS    |
| 7.40             | 0                | -45                 | -0.024               | 2.50        | PASS    |
| 7.40             | 10               | 13                  | 0.007                | 2.50        | PASS    |
| 7.40             | 20               | -16                 | -0.009               | 2.50        | PASS    |
| 7.40             | 30               | -35                 | -0.019               | 2.50        | PASS    |
| 7.40             | 40               | 37                  | 0.020                | 2.50        | PASS    |
| 7.40             | 50               | -19                 | -0.010               | 2.50        | PASS    |



## 4.7 Peak-to-Average Ratio (PAR)

### LIMIT

The Peak-to-Average Ratio (PAR) of the transmission may not exceed 13 dB.

### TEST CONFIGURATION

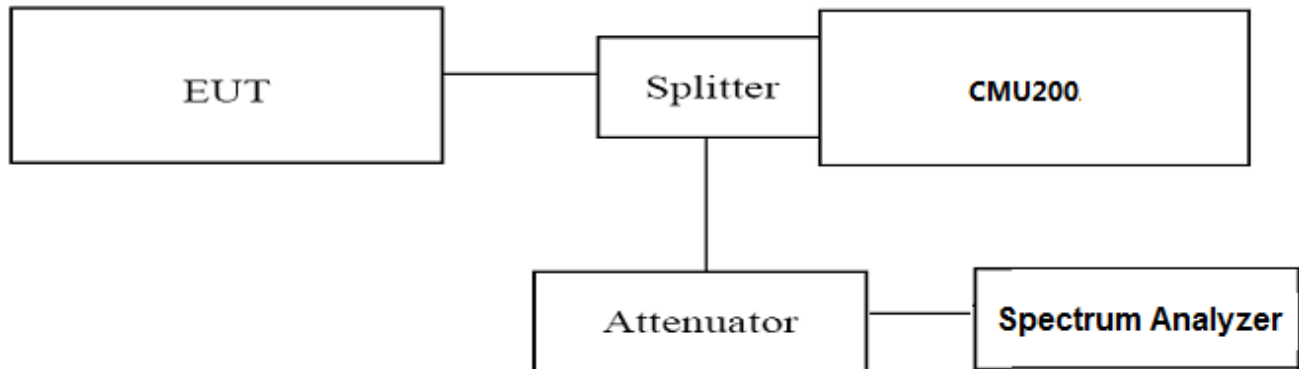

### TEST PROCEDURE

Use spectrum to measure the total peak power and record as  $P_{Pk}$ . Use spectrum to measure the total average power and record as  $P_{Avg}$ . Both the peak and average power levels must be expressed in the same logarithmic units (e.g., dBm).

Determine the PAPR from:

$$PAPR (dB) = P_{Pk} (dBm) - P_{Avg} (dBm).$$

### TEST RESULTS

| Test Mode        | Channel | Frequency (MHz) | PAPR Value (dB) | Limits (dB) | Verdict |
|------------------|---------|-----------------|-----------------|-------------|---------|
| GSM/TM1/GSM850   | 128     | 824.2           | 2.61            | 13.0        | PASS    |
|                  | 190     | 836.6           | 2.62            | 13.0        |         |
|                  | 251     | 848.8           | 2.64            | 13.0        |         |
| GSM/TM3/EDGE850  | 128     | 824.2           | 2.62            | 13.0        | PASS    |
|                  | 190     | 836.6           | 2.61            | 13.0        |         |
|                  | 251     | 848.8           | 2.64            | 13.0        |         |
| GSM/TM1/GSM1900  | 512     | 1850.2          | 2.64            | 13.0        | PASS    |
|                  | 661     | 1880.0          | 2.65            | 13.0        |         |
|                  | 810     | 1909.8          | 2.69            | 13.0        |         |
| GSM/TM3/EDGE1900 | 512     | 1850.2          | 2.65            | 13.0        | PASS    |
|                  | 661     | 1880.0          | 2.66            | 13.0        |         |
|                  | 810     | 1909.8          | 2.69            | 13.0        |         |

Peak-to-Average Ratio (PAR)

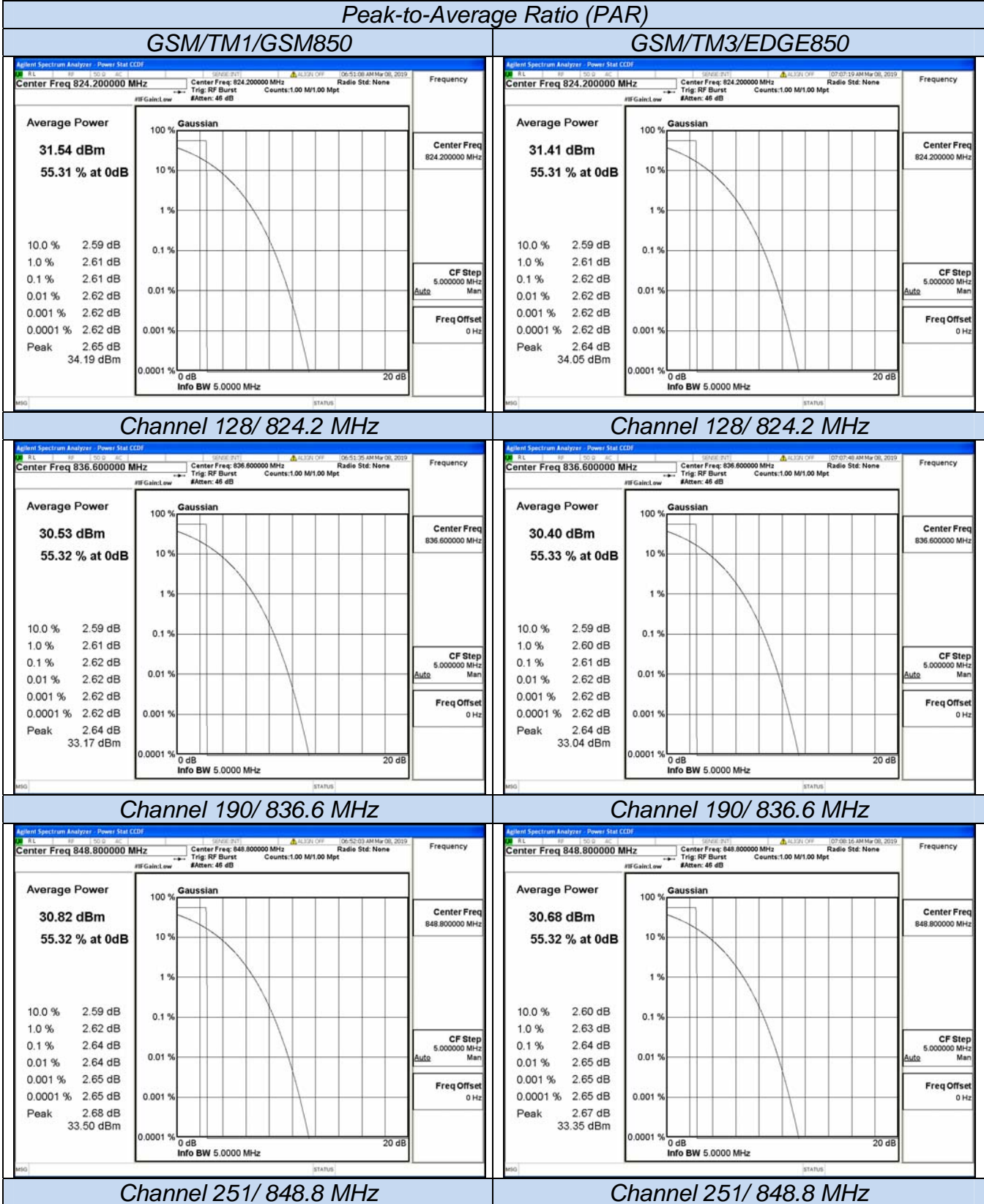

Peak-to-Average Ratio (PAR)

GSM/TM1/GSM1900

GSM/TM3/EDGE1900

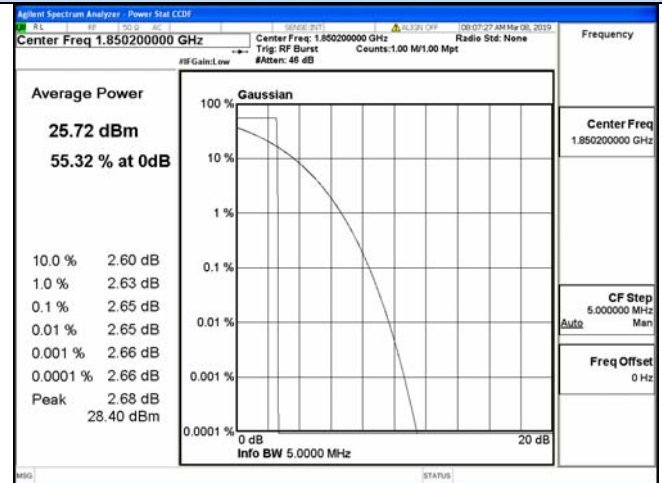
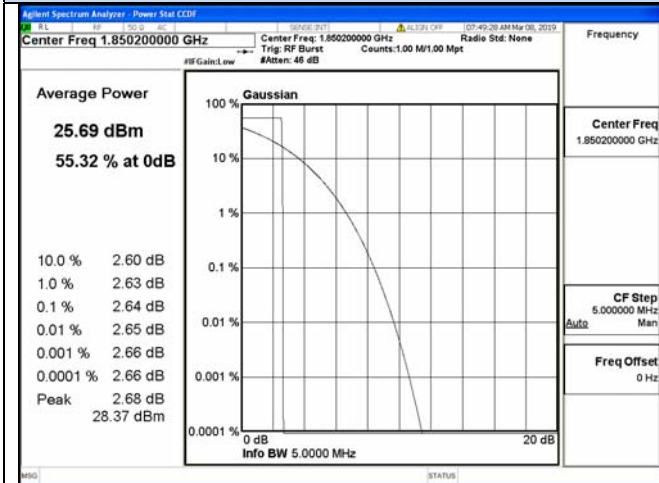

Channel 512/ 1850.2 MHz

Channel 512/ 1850.2 MHz

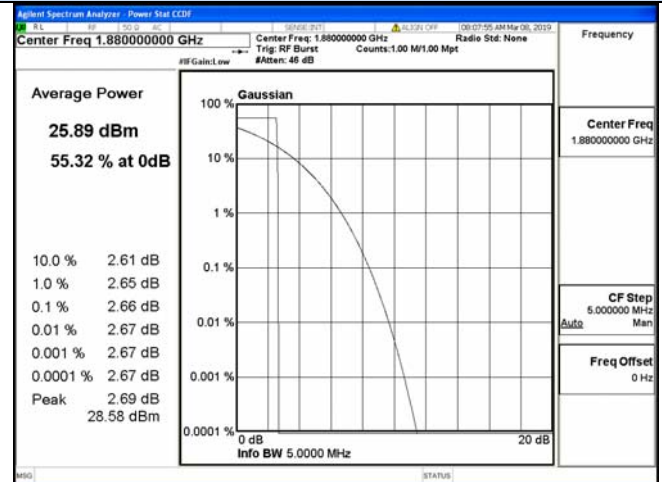
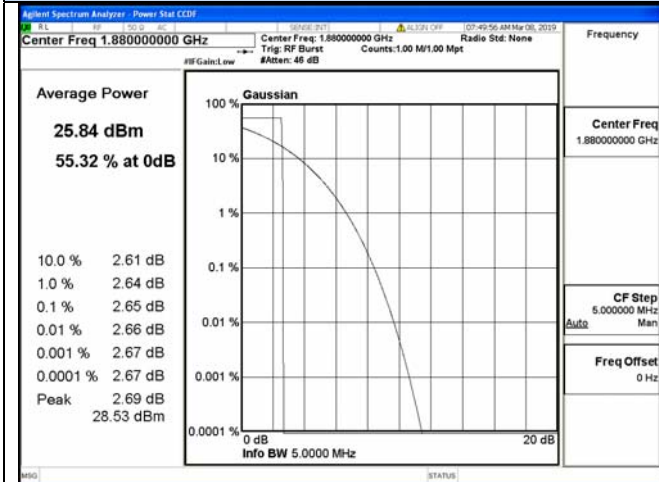

Channel 661/ 1880 MHz

Channel 661/ 1880 MHz

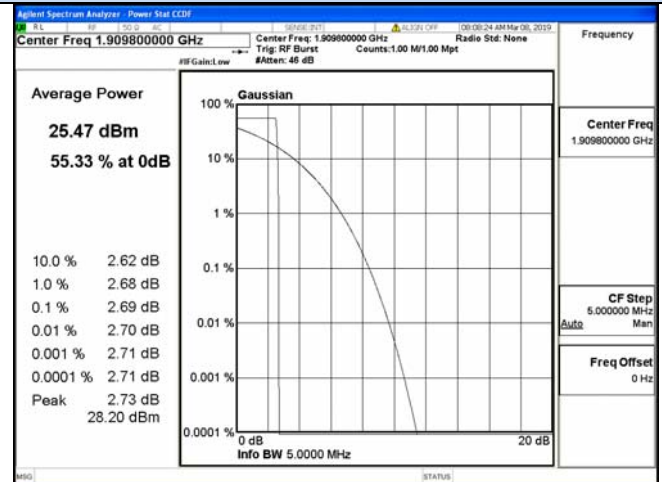
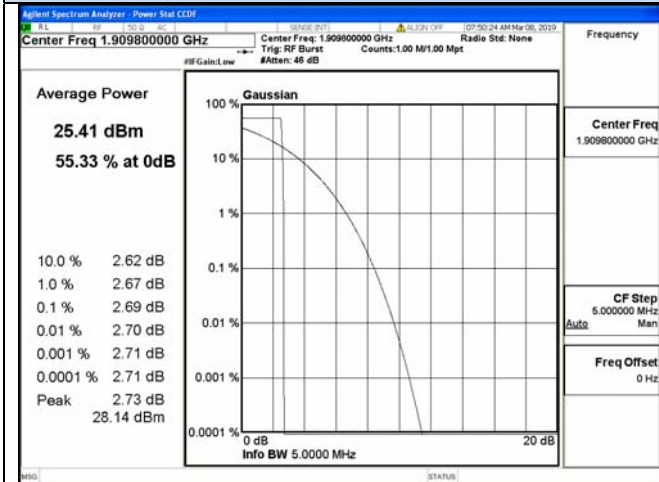

Channel 810/ 1909.8 MHz

Channel 810/ 1909.8 MHz

**5 TEST SETUP PHOTOGRAPHS OF EUT**

Please refer to separated files for Test Setup Photos of the EUT.

**6 EXTERIOR PHOTOGRAPHS OF THE EUT**

Please refer to separated files for External Photos of the EUT.

**7 INTERIOR PHOTOGRAPHS OF THE EUT**

Please refer to separated files for Internal Photos of the EUT.

.....**End of Report**.....