

Band Edge, Left Side - 802.11n20

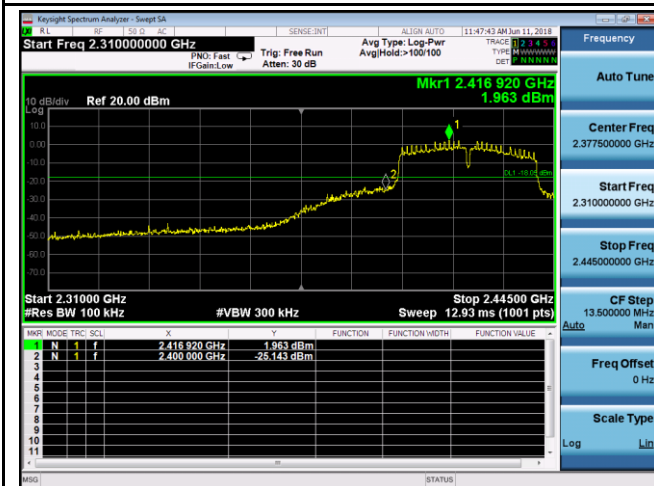

Band Edge, Right Side - 802.11n20



Band Edge, Left Side - 802.11n40



Band Edge, Right Side - 802.11n40

Note: Both Horizontal and vertical polarities were investigated

6.6 AC Power Line Conducted Emissions

Temperature	26°C
Relative Humidity	55%
Atmospheric Pressure	1020mbar
Test date :	June 11, 2018
Tested By :	Aaron Liang

Requirement(s):

Spec	Item	Requirement	Applicable														
47CFR§15.207, RSS210 (A8.1)	a)	For Low-power radio-frequency devices that is designed to be connected to the public utility (AC) power line, the radio frequency voltage that is conducted back onto the AC power line on any frequency or frequencies, within the band 150 kHz to 30 MHz, shall not exceed the limits in the following table, as measured using a 50 [mu] H/50 ohms line impedance stabilization network (LISN). The lower limit applies at the boundary between the frequencies ranges.	<input checked="" type="checkbox"/>														
		<table border="1"> <thead> <tr> <th rowspan="2">Frequency ranges (MHz)</th> <th colspan="2">Limit (dBµV)</th> </tr> <tr> <th>QP</th> <th>Average</th> </tr> </thead> <tbody> <tr> <td>0.15 ~ 0.5</td> <td>66 – 56</td> <td>56 – 46</td> </tr> <tr> <td>0.5 ~ 5</td> <td>56</td> <td>46</td> </tr> <tr> <td>5 ~ 30</td> <td>60</td> <td>50</td> </tr> </tbody> </table>		Frequency ranges (MHz)	Limit (dBµV)		QP	Average	0.15 ~ 0.5	66 – 56	56 – 46	0.5 ~ 5	56	46	5 ~ 30	60	50
		Frequency ranges (MHz)			Limit (dBµV)												
				QP	Average												
0.15 ~ 0.5	66 – 56	56 – 46															
0.5 ~ 5	56	46															
5 ~ 30	60	50															

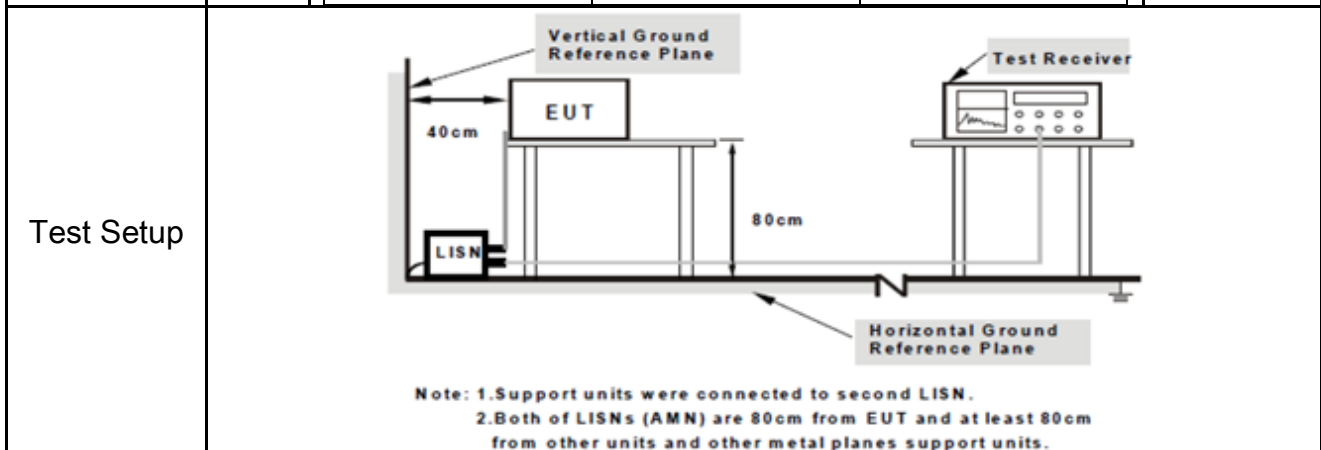

Procedure	<ol style="list-style-type: none"> The EUT and supporting equipment were set up in accordance with the requirements of the standard on top of a 1.5m x 1m x 0.8m high, non-metallic table. The power supply for the EUT was fed through a 50W/50mH EUT LISN, connected to filtered mains. The RF OUT of the EUT LISN was connected to the EMI test receiver via a low-loss
-----------	---

Test Report No.	18070574-FCC-R
Page	42 of 66

	<p>coaxial cable.</p> <ol style="list-style-type: none"> 4. All other supporting equipment were powered separately from another main supply. 5. The EUT was switched on and allowed to warm up to its normal operating condition. 6. A scan was made on the NEUTRAL line (for AC mains) or Earth line (for DC power) over the required frequency range using an EMI test receiver. 7. High peaks, relative to the limit line, The EMI test receiver was then tuned to the selected frequencies and the necessary measurements made with a receiver bandwidth setting of 10 kHz. 8. Step 7 was then repeated for the LIVE line (for AC mains) or DC line (for DC power).
Remark	Transformer model: EPC13 test data
Result	<input checked="" type="checkbox"/> Pass <input type="checkbox"/> Fail

Test Data Yes N/A

Test Plot Yes (See below) N/A

Ant. 1:

Test Mode:	Transmitting Mode
-------------------	--------------------------

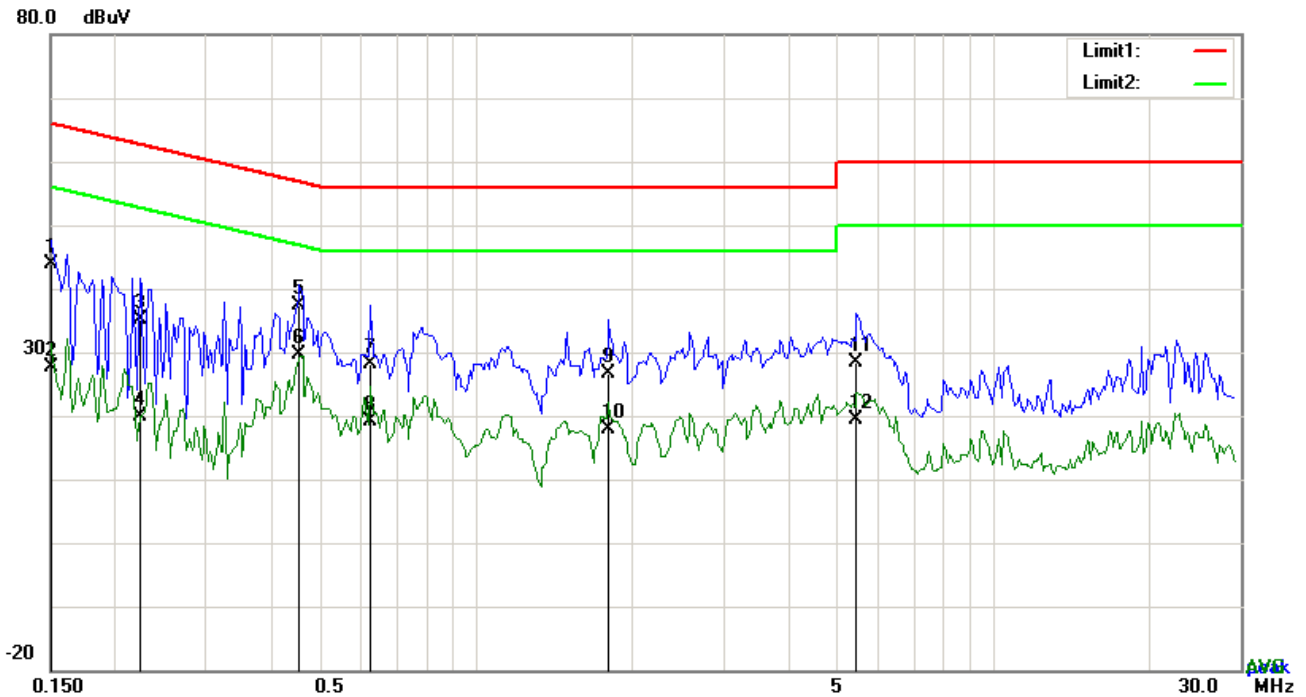

Test Data

Phase Line Plot at 120Vac, 60Hz

No.	P/L	Frequency (MHz)	Reading (dBμV)	Detector	Corrected (dB)	Result (dBμV)	Limit (dBμV)	Margin (dB)
1	L1	0.1500	33.77	QP	10.02	43.79	66.00	-22.21
2	L1	0.1500	17.68	AVG	10.02	27.70	56.00	-28.30
3	L1	0.2241	25.02	QP	10.02	35.04	62.67	-27.63
4	L1	0.2241	9.77	AVG	10.02	19.79	52.67	-32.88
5	L1	0.4542	27.44	QP	10.02	37.46	56.80	-19.34
6	L1	0.4542	19.58	AVG	10.02	29.60	46.80	-17.20
7	L1	0.6219	18.07	QP	10.02	28.09	56.00	-27.91
8	L1	0.6219	9.01	AVG	10.02	19.03	46.00	-26.97
9	L1	1.8036	16.65	QP	10.04	26.69	56.00	-29.31
10	L1	1.8036	7.95	AVG	10.04	17.99	46.00	-28.01
11	L1	5.4375	18.35	QP	10.08	28.43	60.00	-31.57
12	L1	5.4375	9.29	AVG	10.08	19.37	50.00	-30.63

Test Mode:	Transmitting Mode
-------------------	--------------------------

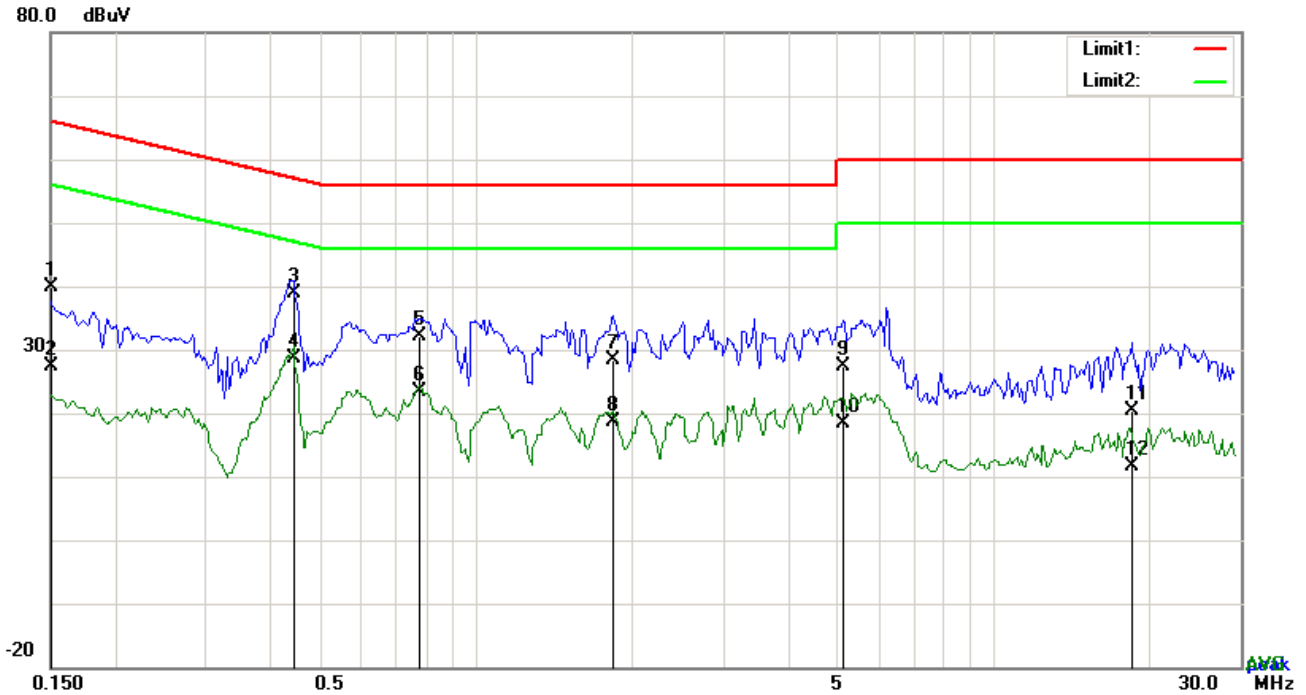

Test Data

Phase Neutral Plot at 120Vac, 60Hz

No.	P/L	Frequency (MHz)	Reading (dBμV)	Detector	Corrected (dB)	Result (dBμV)	Limit (dBμV)	Margin (dB)
1	N	0.1500	29.81	QP	10.02	39.83	66.00	-26.17
2	N	0.1500	17.33	AVG	10.02	27.35	56.00	-28.65
3	N	0.4425	28.95	QP	10.02	38.97	57.01	-18.04
4	N	0.4425	18.68	AVG	10.02	28.70	47.01	-18.31
5	N	0.7779	22.17	QP	10.03	32.20	56.00	-23.80
6	N	0.7779	13.28	AVG	10.03	23.31	46.00	-22.69
7	N	1.8348	18.23	QP	10.04	28.27	56.00	-27.73
8	N	1.8348	8.52	AVG	10.04	18.56	46.00	-27.44
9	N	5.1372	17.42	QP	10.07	27.49	60.00	-32.51
10	N	5.1372	8.41	AVG	10.07	18.48	50.00	-31.52
11	N	18.4401	10.06	QP	10.24	20.30	60.00	-39.70
12	N	18.4401	1.45	AVG	10.24	11.69	50.00	-38.31

Test Mode:	Transmitting Mode
-------------------	--------------------------

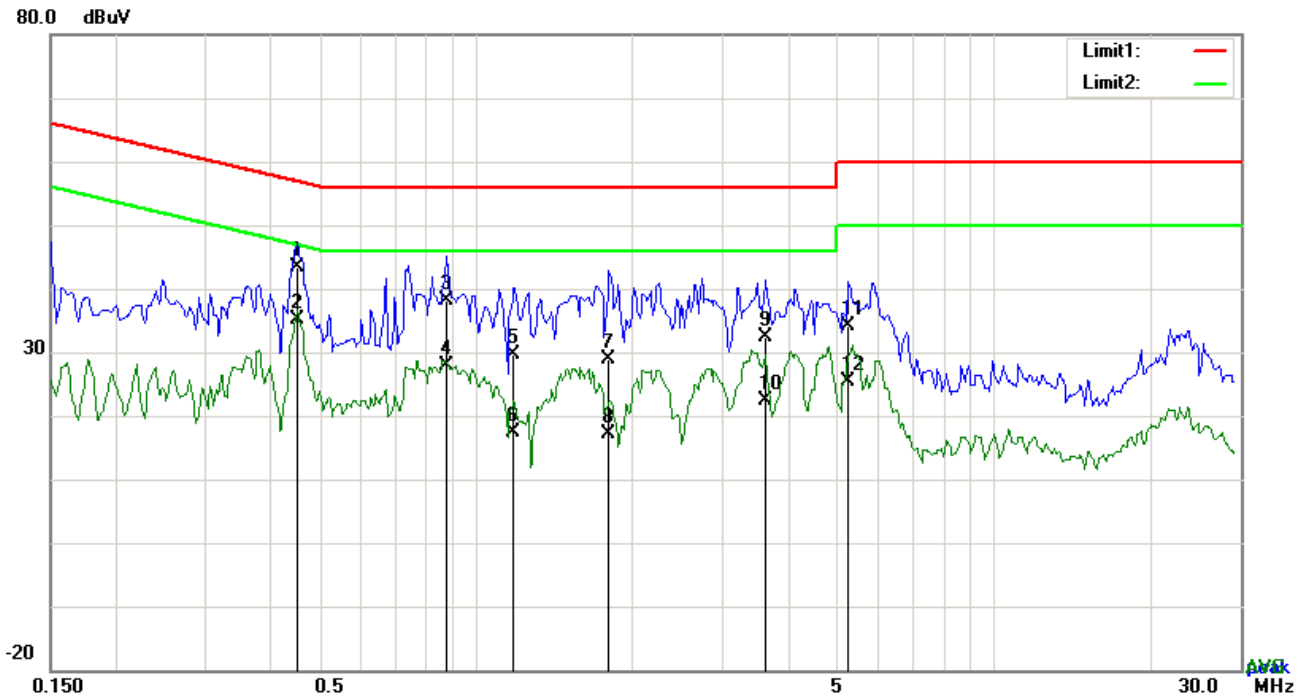

Test Data

Phase Line Plot at 240Vac, 60Hz

No.	P/L	Frequency (MHz)	Reading (dBµV)	Detector	Corrected (dB)	Result (dBµV)	Limit (dBµV)	Margin (dB)
1	L1	0.4503	33.40	QP	10.03	43.43	56.87	-13.44
2	L1	0.4503	25.07	AVG	10.03	35.10	46.87	-11.77
3	L1	0.8754	28.04	QP	10.03	38.07	56.00	-17.93
4	L1	0.8754	17.89	AVG	10.03	27.92	46.00	-18.08
5	L1	1.1835	19.62	QP	10.03	29.65	56.00	-26.35
6	L1	1.1835	7.43	AVG	10.03	17.46	46.00	-28.54
7	L1	1.8036	18.76	QP	10.04	28.80	56.00	-27.20
8	L1	1.8036	7.11	AVG	10.04	17.15	46.00	-28.85
9	L1	3.6162	22.26	QP	10.06	32.32	56.00	-23.68
10	L1	3.6162	12.28	AVG	10.06	22.34	46.00	-23.66
11	L1	5.2308	24.02	QP	10.08	34.10	60.00	-25.90
12	L1	5.2308	15.36	AVG	10.08	25.44	50.00	-24.56

Test Mode:	Transmitting Mode
-------------------	--------------------------

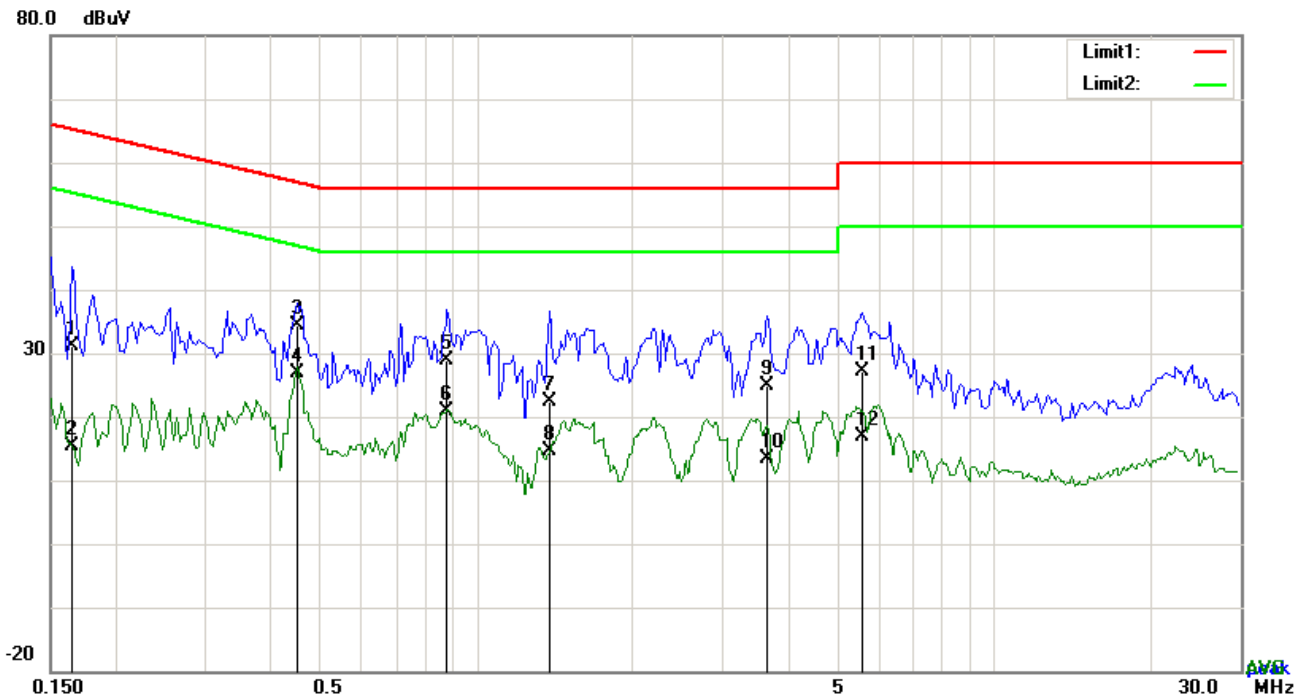

Test Data

Phase Neutral Plot at 240Vac, 60Hz

No.	P/L	Frequency (MHz)	Reading (dBμV)	Detector	Corrected (dB)	Result (dBμV)	Limit (dBμV)	Margin (dB)
1	N	0.1656	21.11	QP	10.02	31.13	65.18	-34.05
2	N	0.1656	5.25	AVG	10.02	15.27	55.18	-39.91
3	N	0.4503	24.37	QP	10.02	34.39	56.87	-22.48
4	N	0.4503	16.78	AVG	10.02	26.80	46.87	-20.07
5	N	0.8793	18.93	QP	10.03	28.96	56.00	-27.04
6	N	0.8793	10.83	AVG	10.03	20.86	46.00	-25.14
7	N	1.3824	12.38	QP	10.03	22.41	56.00	-33.59
8	N	1.3824	4.61	AVG	10.03	14.64	46.00	-31.36
9	N	3.6552	14.93	QP	10.06	24.99	56.00	-31.01
10	N	3.6552	3.36	AVG	10.06	13.42	46.00	-32.58
11	N	5.5701	17.11	QP	10.08	27.19	60.00	-32.81
12	N	5.5701	6.71	AVG	10.08	16.79	50.00	-33.21

Ant. 2:

Test Mode:	Transmitting Mode
-------------------	--------------------------

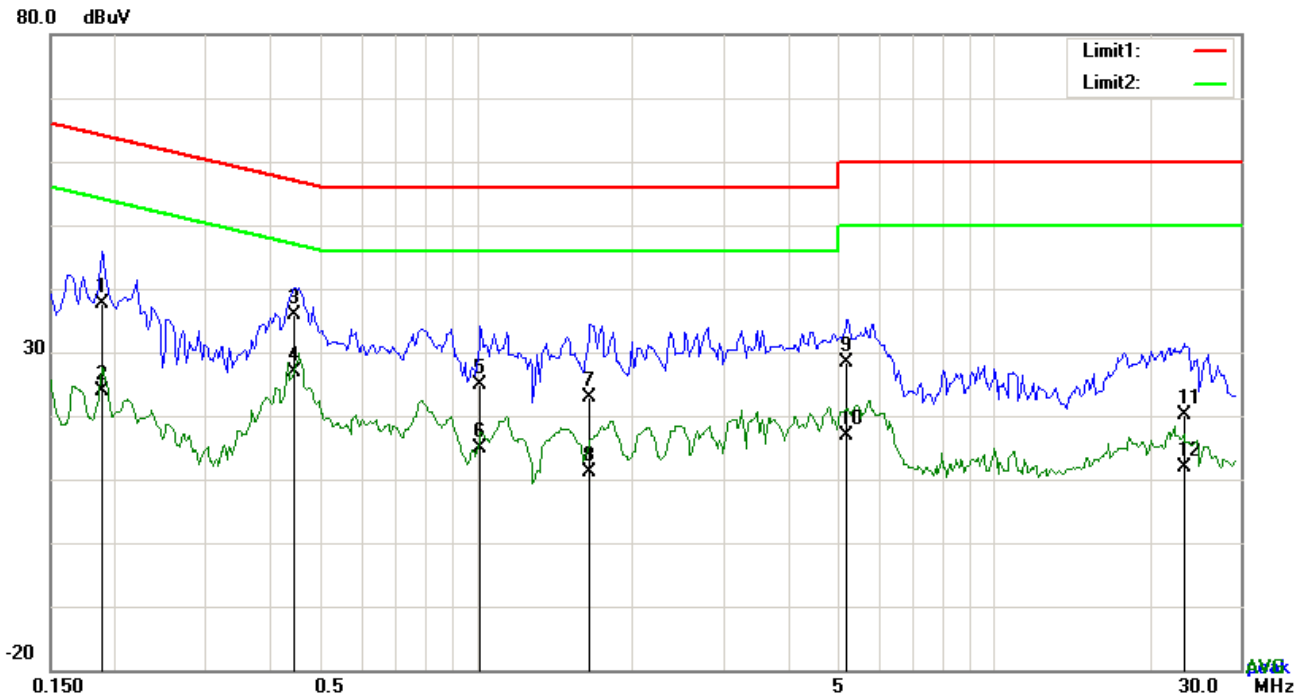

Test Data

Phase Line Plot at 120Vac, 60Hz

No.	P/L	Frequency (MHz)	Reading (dBµV)	Detector	Corrected (dB)	Result (dBµV)	Limit (dBµV)	Margin (dB)
1	L1	0.1890	27.49	QP	10.03	37.52	64.08	-26.56
2	L1	0.1890	13.80	AVG	10.03	23.83	54.08	-30.25
3	L1	0.4425	25.91	QP	10.03	35.94	57.01	-21.07
4	L1	0.4425	16.77	AVG	10.03	26.80	47.01	-20.21
5	L1	1.0197	14.76	QP	10.03	24.79	56.00	-31.21
6	L1	1.0197	4.73	AVG	10.03	14.76	46.00	-31.24
7	L1	1.6554	12.91	QP	10.04	22.95	56.00	-33.05
8	L1	1.6554	1.02	AVG	10.04	11.06	46.00	-34.94
9	L1	5.2191	18.37	QP	10.08	28.45	60.00	-31.55
10	L1	5.2191	6.87	AVG	10.08	16.95	50.00	-33.05
11	L1	23.2917	9.85	QP	10.36	20.21	60.00	-39.79
12	L1	23.2917	1.45	AVG	10.36	11.81	50.00	-38.19

Test Mode:	Transmitting Mode
-------------------	--------------------------

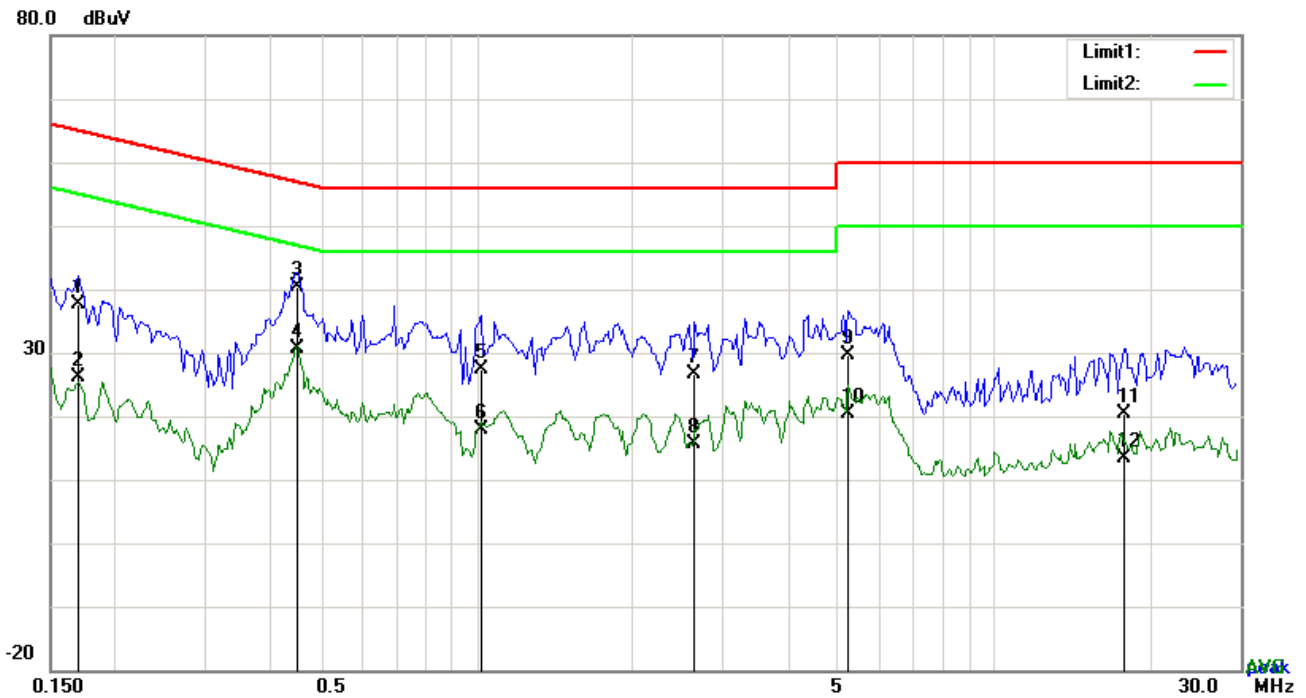

Test Data

Phase Neutral Plot at 120Vac, 60Hz

No.	P/L	Frequency (MHz)	Reading (dBµV)	Detector	Corrected (dB)	Result (dBµV)	Limit (dBµV)	Margin (dB)
1	N	0.1695	27.61	QP	10.02	37.63	64.98	-27.35
2	N	0.1695	16.17	AVG	10.02	26.19	54.98	-28.79
3	N	0.4503	30.33	QP	10.02	40.35	56.87	-16.52
4	N	0.4503	20.71	AVG	10.02	30.73	46.87	-16.14
5	N	1.0236	17.43	QP	10.03	27.46	56.00	-28.54
6	N	1.0236	7.84	AVG	10.03	17.87	46.00	-28.13
7	N	2.6382	16.57	QP	10.05	26.62	56.00	-29.38
8	N	2.6382	5.65	AVG	10.05	15.70	46.00	-30.30
9	N	5.2308	19.44	QP	10.07	29.51	60.00	-30.49
10	N	5.2308	10.26	AVG	10.07	20.33	50.00	-29.67
11	N	17.9409	10.19	QP	10.24	20.43	60.00	-39.57
12	N	17.9409	3.03	AVG	10.24	13.27	50.00	-36.73

Test Mode: Transmitting Mode

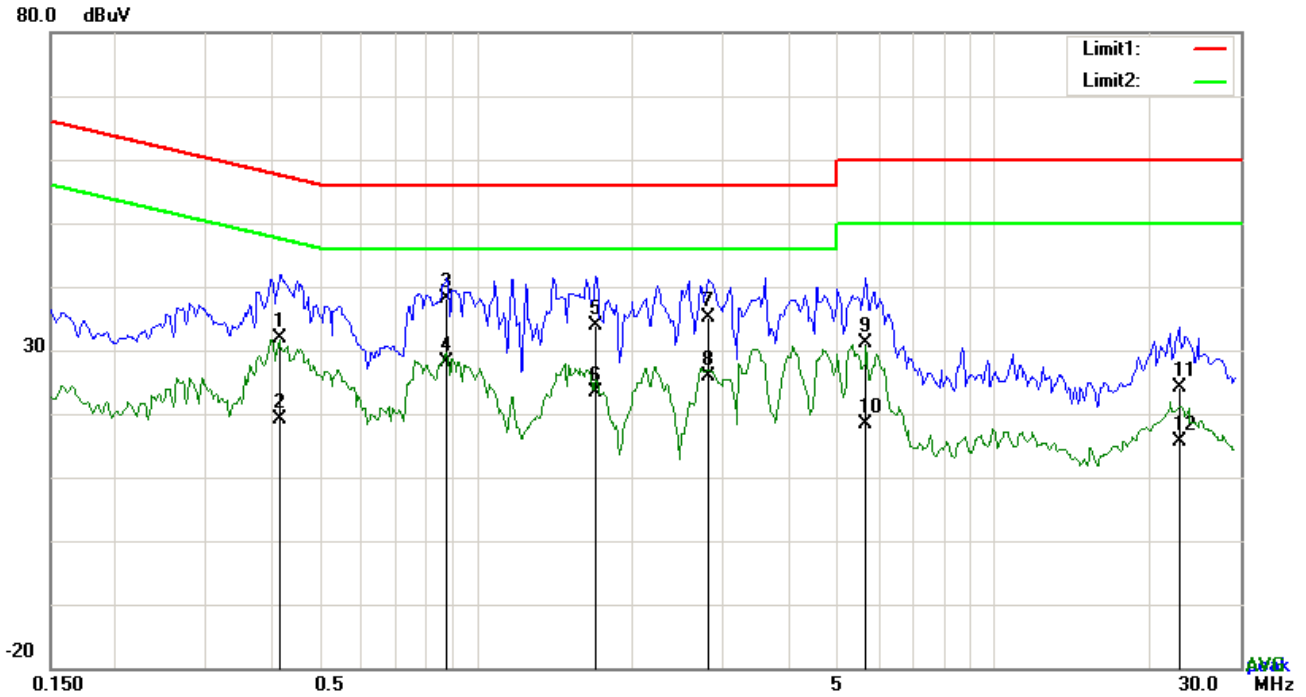

Test Data

Phase Line Plot at 240Vac, 60Hz

No.	P/L	Frequency (MHz)	Reading (dBµV)	Detector	Corrected (dB)	Result (dBµV)	Limit (dBµV)	Margin (dB)
1	L1	0.4191	21.93	QP	10.03	31.96	57.47	-25.51
2	L1	0.4191	8.98	AVG	10.03	19.01	47.47	-28.46
3	L1	0.8793	28.18	QP	10.03	38.21	56.00	-17.79
4	L1	0.8793	18.13	AVG	10.03	28.16	46.00	-17.84
5	L1	1.7061	23.76	QP	10.04	33.80	56.00	-22.20
6	L1	1.7061	13.44	AVG	10.04	23.48	46.00	-22.52
7	L1	2.8059	25.05	QP	10.05	35.10	56.00	-20.90
8	L1	2.8059	15.71	AVG	10.05	25.76	46.00	-20.24
9	L1	5.6559	21.07	QP	10.09	31.16	60.00	-28.84
10	L1	5.6559	8.25	AVG	10.09	18.34	50.00	-31.66
11	L1	22.7886	13.85	QP	10.35	24.20	60.00	-35.80
12	L1	22.7886	5.38	AVG	10.35	15.73	50.00	-34.27

Test Mode:	Transmitting Mode
-------------------	--------------------------

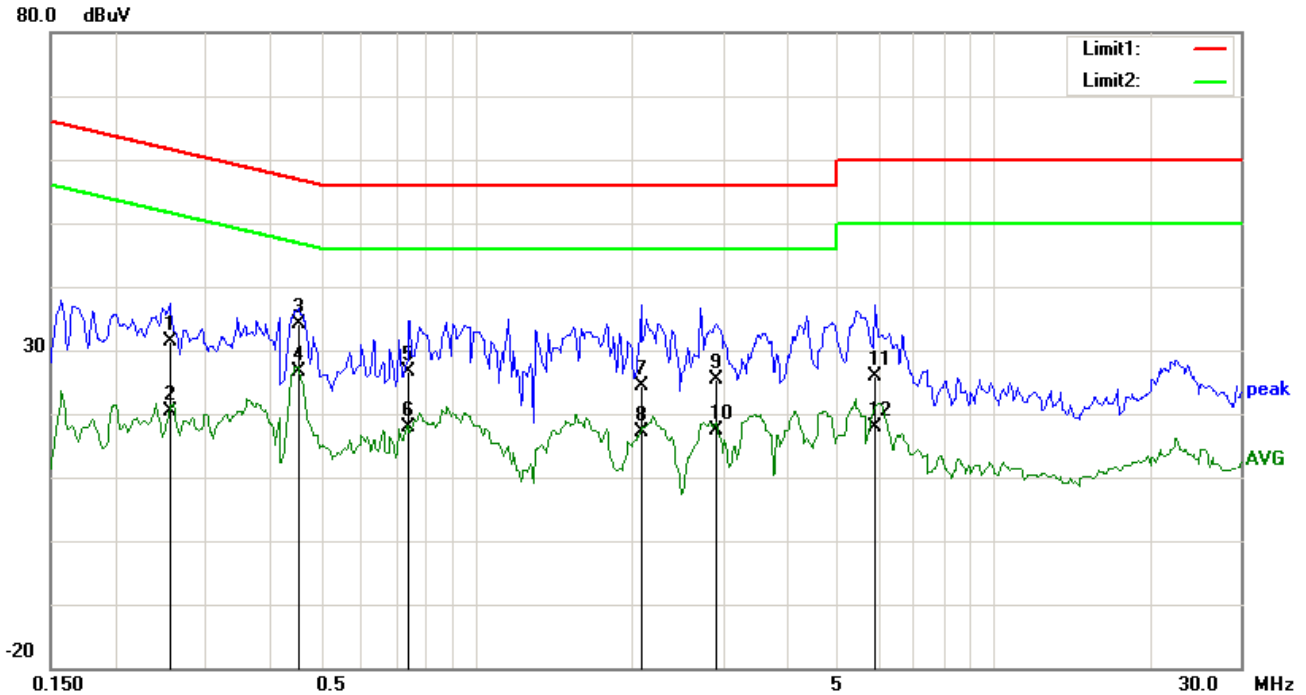

Test Data

Phase Neutral Plot at 240Vac, 60Hz

No.	P/L	Frequency (MHz)	Reading (dBμV)	Detector	Corrected (dB)	Result (dBμV)	Limit (dBμV)	Margin (dB)
1	N	0.2553	21.27	QP	10.02	31.29	61.58	-30.29
2	N	0.2553	10.36	AVG	10.02	20.38	51.58	-31.20
3	N	0.4542	24.03	QP	10.02	34.05	56.80	-22.75
4	N	0.4542	16.61	AVG	10.02	26.63	46.80	-20.17
5	N	0.7428	16.50	QP	10.02	26.52	56.00	-29.48
6	N	0.7428	7.77	AVG	10.02	17.79	46.00	-28.21
7	N	2.0805	14.40	QP	10.04	24.44	56.00	-31.56
8	N	2.0805	7.10	AVG	10.04	17.14	46.00	-28.86
9	N	2.9073	15.41	QP	10.05	25.46	56.00	-30.54
10	N	2.9073	7.27	AVG	10.05	17.32	46.00	-28.68
11	N	5.8860	15.71	QP	10.08	25.79	60.00	-34.21
12	N	5.8860	7.89	AVG	10.08	17.97	50.00	-32.03

6.7 Radiated Spurious Emissions & Restricted Band

Temperature	26°C
Relative Humidity	55%
Atmospheric Pressure	1020mbar
Test date :	June 11, 2018
Tested By :	Aaron Liang

Requirement(s):

Spec	Item	Requirement	Applicable																
47CFR§15.247(d), RSS210 (A8.5)	a)	<p>Except higher limit as specified elsewhere in other section, the emissions from the low-power radio-frequency devices shall not exceed the field strength levels specified in the following table and the level of any unwanted emissions shall not exceed the level of the fundamental emission. The tighter limit applies at the band edges</p> <table border="1"> <thead> <tr> <th>Frequency range (MHz)</th> <th>Field Strength (μV/m)</th> </tr> </thead> <tbody> <tr> <td>0.009~0.490</td> <td>2400/F(KHz)</td> </tr> <tr> <td>0.490~1.705</td> <td>24000/F(KHz)</td> </tr> <tr> <td>1.705~30.0</td> <td>30</td> </tr> <tr> <td>30 – 88</td> <td>100</td> </tr> <tr> <td>88 – 216</td> <td>150</td> </tr> <tr> <td>216 960</td> <td>200</td> </tr> <tr> <td>Above 960</td> <td>500</td> </tr> </tbody> </table>	Frequency range (MHz)	Field Strength (μV/m)	0.009~0.490	2400/F(KHz)	0.490~1.705	24000/F(KHz)	1.705~30.0	30	30 – 88	100	88 – 216	150	216 960	200	Above 960	500	<input checked="" type="checkbox"/>
	Frequency range (MHz)	Field Strength (μV/m)																	
	0.009~0.490	2400/F(KHz)																	
0.490~1.705	24000/F(KHz)																		
1.705~30.0	30																		
30 – 88	100																		
88 – 216	150																		
216 960	200																		
Above 960	500																		
b)	<p>For non-restricted band, In any 100 kHz bandwidth outside the frequency band in which the spread spectrum or digitally modulated intentional radiator is operating, the radio frequency power that is produced by the intentional radiator shall be at least 20 dB or 30dB below that in the 100 kHz bandwidth within the band that contains the highest level of the desired power, determined by the measurement method on output power to be used. Attenuation below the general limits specified in § 15.209(a) is not required</p> <p><input checked="" type="checkbox"/> 20 dB down <input type="checkbox"/> 30 dB down</p>	<input checked="" type="checkbox"/>																	
c)	<p>or restricted band, emission must also comply with the radiated emission limits specified in 15.209</p>	<input checked="" type="checkbox"/>																	

<p>Test Setup</p>	
<p>Procedure</p>	<ol style="list-style-type: none"> 1. The EUT was switched on and allowed to warm up to its normal operating condition. 2. The test was carried out at the selected frequency points obtained from the EUT characterization. Maximization of the emissions, was carried out by rotating the EUT, changing the antenna polarization, and adjusting the antenna height in the following manner: <ol style="list-style-type: none"> a. Vertical or horizontal polarization (whichever gave the higher emission level over a full rotation of the EUT) was chosen. b. The EUT was then rotated to the direction that gave the maximum emission. c. Finally, the antenna height was adjusted to the height that gave the maximum emission. 3. The resolution bandwidth and video bandwidth of test receiver/spectrum analyzer is 120 kHz for Quasiy Peak detection at frequency below 1GHz. 4. The resolution bandwidth of test receiver/spectrum analyzer is 1MHz and video bandwidth is 3MHz with Peak detection for Peak measurement at frequency above 1GHz.

Test Report No.	18070574-FCC-R
Page	53 of 66

	<p>The resolution bandwidth of test receiver/spectrum analyzer is 1MHz and the video bandwidth is 10Hz with Peak detection for Average Measurement as below at frequency above 1GHz.</p> <p>5. Steps 2 and 3 were repeated for the next frequency point, until all selected frequency points were measured.</p>
Remark	Transformer model: EPC13 test data
Result	<input checked="" type="checkbox"/> Pass <input type="checkbox"/> Fail

Test Data Yes N/A

Test Plot Yes (See below) N/A

Test Result:

Test Mode:	Transmitting Mode
-------------------	-------------------

Frequency range: 9KHz - 30MHz

Freq. (MHz)	Detection value	Factor (dB/m)	Reading (dBuV/m)	Result (dBuV/m)	Limit@3m (dBuV/m)	Margin (dB)
--	--	--	--	--	--	>20
--	--	--	--	--	--	>20

Note:

The amplitude of spurious emissions which are attenuated by more than 20dB below the permissible value has no need to be reported.

Distance extrapolation factor = $40 \log (\text{specific distance}/\text{test distance})$ (dB);

Limit line = specific limits(dBuv) + distance extrapolation factor.

Ant.1:

Test Mode:	Transmitting Mode
------------	-------------------

30MHz -1GHz

80.0 dBuV/m

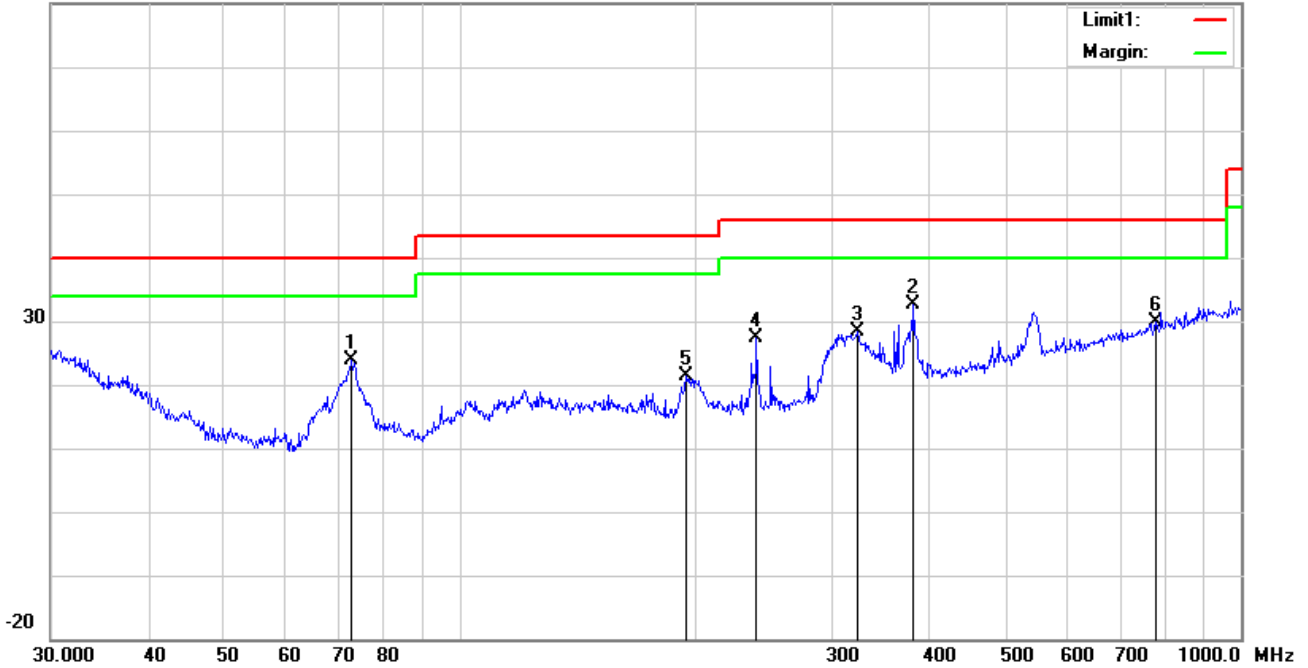

Test Data

Vertical Polarity Plot @3m

No	P/L	Frequency	Reading	Detector	Ant_F	PA_G	Cab_L	Result	Limit	Margin	Height	Degree
		(MHz)	(dBuV/m)		(dB/m)	(dB)	(dB)	(dBuV/m)	(dBuV/m)	(dB)	(cm)	(°)
1	H	72.8466	37.46	peak	7.74	22.39	0.97	23.78	40.00	-16.22	100	237
2	H	381.2487	37.38	peak	15.31	22.06	2.02	32.65	46.00	-13.35	100	146
3	H	323.3204	34.58	peak	14.09	22.22	1.91	28.36	46.00	-17.64	100	139
4	H	239.9873	36.36	peak	11.54	22.31	1.67	27.26	46.00	-18.74	200	91
5	H	195.1365	30.24	peak	11.83	22.35	1.54	21.26	43.50	-22.24	100	112
6	H	776.8778	26.95	peak	21.12	21.20	2.92	29.79	46.00	-16.21	100	297

30MHz -1GHz

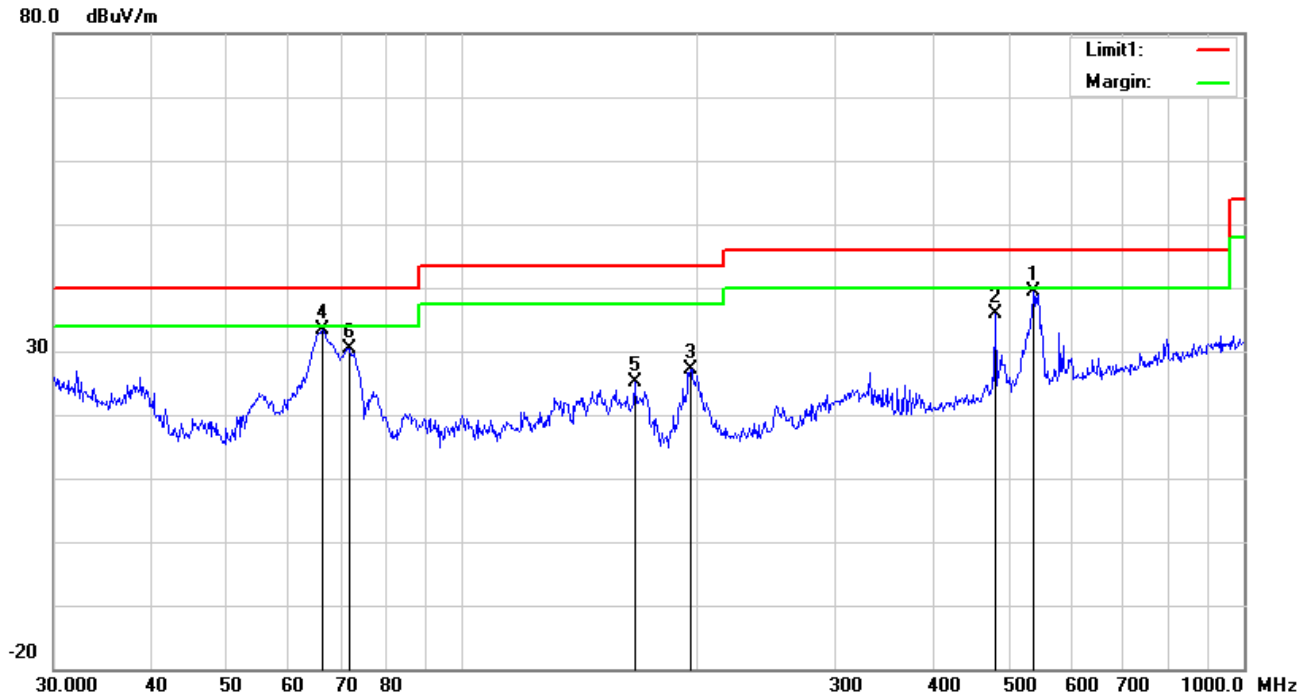

Test Data

Horizontal Polarity Plot @3m

N o.	P/ L	Frequency (MHz)	Reading (dBuV/m)	Detect or	Ant_F (dB/m)	PA_G (dB)	Cab_L (dB)	Result (dBuV/m)	Limit (dBuV/m)	Margin (dB)	Height (cm)	Degree (°)
1	V	537.5891	40.31	peak	18.23	21.72	2.47	39.29	46.00	-6.71	100	233
2	V	480.5276	38.10	peak	17.31	21.85	2.31	35.87	46.00	-10.13	100	85
3	V	195.8220	36.12	peak	11.87	22.35	1.54	27.18	43.50	-16.32	100	252
4	V	66.2662	47.36	peak	7.61	22.39	0.91	33.49	40.00	-6.51	100	6
5	V	166.0680	34.00	peak	12.11	22.26	1.37	25.22	43.50	-18.28	100	254
6	V	71.8320	44.06	peak	7.76	22.39	0.97	30.40	40.00	-9.60	100	182

Above 1GHz

Test Mode:	Transmitting Mode
-------------------	--------------------------

Frequency (MHz)	Meter Reading (dBμV)	Antenna Factor (dB)	Cable loss (dB)	Preamp factor (dB)	Emission Level (dBμV/m)	Limits (dBμV/m)	Margin (dB)	Detector (PK/AV)	Polarity (H/V)
Low Channel:802.11b(Worst Case)-2412MHz									
2390	40.38	28.72	3.36	26.32	46.14	74	-27.86	peak	Vertical
4824	31.21	32.94	3.98	27.49	40.64	54	-13.36	Average	Vertical
4824	40.46	32.94	3.98	27.49	49.89	74	-24.11	peak	Vertical
7236	30.16	25.28	5.51	27.94	33.01	54	-20.99	Average	Vertical
7236	40.45	25.28	5.51	27.94	43.30	74	-30.70	peak	Vertical
2390	40.14	28.72	3.36	26.32	45.90	74	-28.10	peak	Horizontal
4824	30.25	32.94	3.98	27.49	39.68	54	-14.32	Average	Horizontal
4824	40.37	32.94	3.98	27.49	49.80	74	-24.20	peak	Horizontal
7236	31.34	25.28	5.51	27.94	34.19	54	-19.81	Average	Horizontal
7236	39.63	25.28	5.51	27.94	42.48	74	-31.52	peak	Horizontal
Middle Channel:802.11b(Worst Case)-2437MHz									
4874	30.61	32.11	4.04	27.53	39.23	54	-14.77	Average	Vertical
4874	40.64	32.11	4.04	27.53	49.26	74	-24.74	peak	Vertical
7311	31.12	24.33	5.58	27.96	33.07	54	-20.93	Average	Vertical
7311	40.32	24.33	5.58	27.96	42.27	74	-31.73	peak	Vertical
4874	32.38	32.11	4.04	27.53	41.00	54	-13.00	Average	Horizontal
4874	40.31	32.11	4.04	27.53	48.93	74	-25.07	peak	Horizontal
7311	31.54	24.33	5.58	27.96	33.49	54	-20.51	Average	Horizontal
7311	40.17	24.33	5.58	27.96	42.12	74	-31.88	peak	Horizontal
High Channel:802.11b(Worst Case)-2462MHz									
2483.5	40.15	28.79	3.48	26.34	46.08	74	-27.92	peak	Vertical
4924	31.38	31.32	4.12	27.58	39.24	54	-14.76	Average	Vertical
4924	41.52	31.32	4.12	27.58	49.38	74	-24.62	peak	Vertical
7386	31.55	24.38	5.68	27.99	33.62	54	-20.38	Average	Vertical
7386	41.21	24.38	5.68	27.99	43.28	74	-30.72	peak	Vertical
2483.5	39.35	28.79	3.48	26.34	45.28	74	-28.72	peak	Horizontal
4924	30.38	31.32	4.12	27.58	38.24	54	-15.76	Average	Horizontal
4924	41.16	31.32	4.12	27.58	49.02	74	-24.98	peak	Horizontal
7386	31.35	24.38	5.68	27.99	33.42	54	-20.58	Average	Horizontal
7386	41.92	24.38	5.68	27.99	43.99	74	-30.01	peak	Horizontal

NOTE:1.Absolute Level= ReadingLevel+antenna Factor+cable loss-preamp factor.

Note:

- 1, The testing has been conformed to $10 \times 2462\text{MHz} = 24,620\text{MHz}$
- 2, All other emissions more than 30 dB below the limit
- 3, X-Axis, Y-Axis and Z-Axis were investigated. The results above show only the worst case.
- 4, The radiated spurious test above 18GHz is subcontracted to SIEMIC (Nanjing-China) Laboratories. and found 30dB below the limit at least.

Ant. 2:

Test Mode:	Transmitting Mode
-------------------	--------------------------

30MHz -1GHz

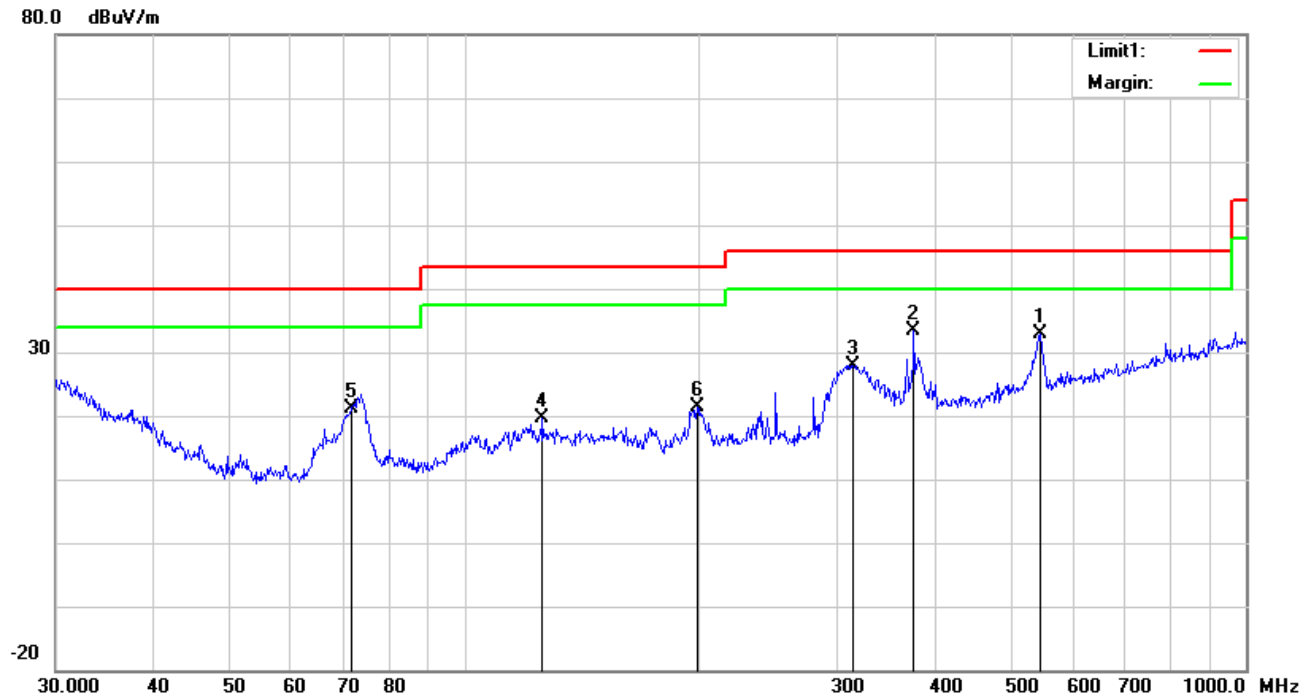

Test Data

Vertical Polarity Plot @3m

No.	P/L	Frequency	Reading	Detect or	Ant_F	PA_G	Cab_L	Result	Limit	Margin	Height	Degree
		(MHz)	(dBuV/m)		(dB/m)	(dB)	(dB)	(dBuV/m)	(dBuV/m)	(dB)	(cm)	(°)
1	H	545.1826	33.70	peak	18.33	21.71	2.47	32.79	46.00	-13.21	100	265
2	H	375.9385	38.28	peak	15.19	22.08	2.02	33.41	46.00	-12.59	100	86
3	H	314.3765	34.45	peak	13.90	22.25	1.86	27.96	46.00	-18.04	100	307
4	H	125.8864	27.32	peak	13.52	22.37	1.18	19.65	43.50	-23.85	100	138
5	H	71.8320	34.67	peak	7.76	22.39	0.97	21.01	40.00	-18.99	100	217
6	H	198.5880	30.22	peak	12.02	22.37	1.54	21.41	43.50	-22.09	100	48

30MHz -1GHz

80.0 dBuV/m

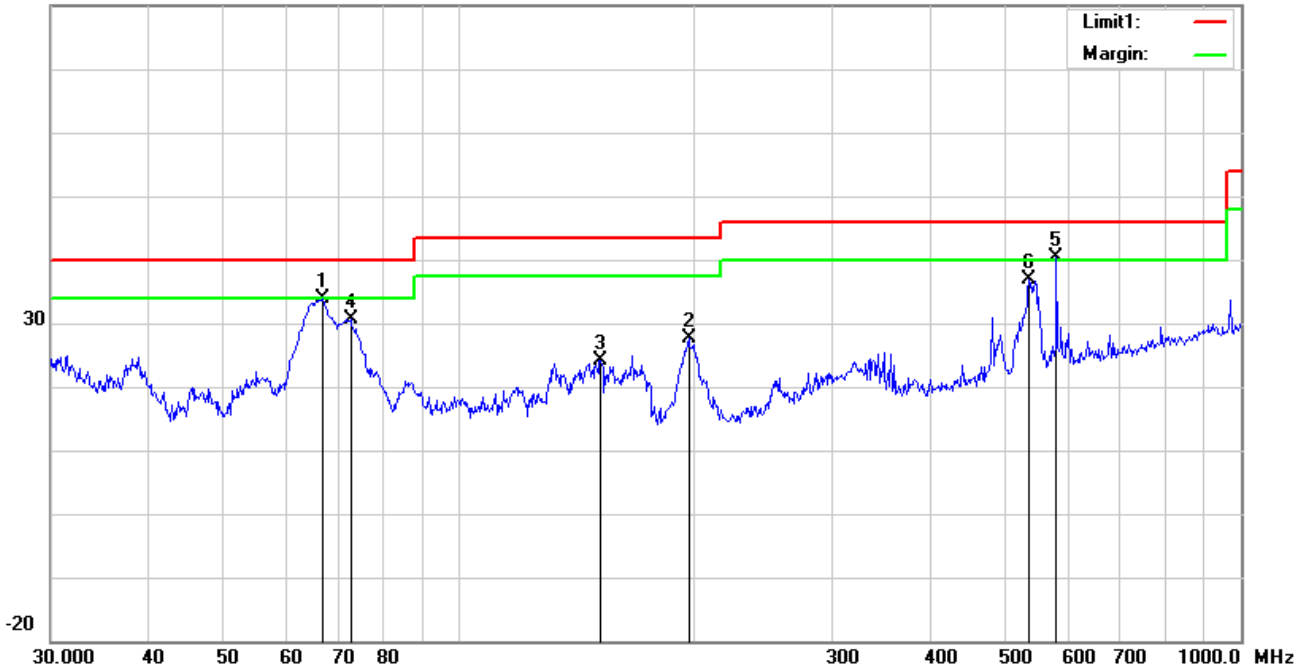

Test Data

Horizontal Polarity Plot @3m

N o.	P/L	Frequency (MHz)	Reading (dBuV/m)	Detect or	Ant_F (dB/m)	PA_G (dB)	Cab_L (dB)	Result (dBuV/m)	Limit (dBuV/m)	Margin (dB)	Height (cm)	Degree (°)
1	V	66.9669	47.66	peak	7.65	22.39	0.92	33.84	40.00	-6.16	100	339
2	V	196.5098	36.52	peak	11.91	22.36	1.54	27.61	43.50	-15.89	200	19
3	V	151.5972	32.61	peak	12.60	22.33	1.35	24.23	43.50	-19.27	100	48
4	V	72.5917	44.20	peak	7.75	22.39	0.97	30.53	40.00	-9.47	100	278
5	V	580.7026	40.63	peak	18.83	21.62	2.49	40.33	46.00	-5.67	100	16
6	V	535.7073	37.96	peak	18.20	21.73	2.46	36.89	46.00	-9.11	100	318

Above 1GHz

Test Mode:	Transmitting Mode
-------------------	--------------------------

Frequency (MHz)	Meter Reading (dBμV)	Antenna Factor (dB)	Cable loss (dB)	Preamp factor (dB)	Emission Level (dBμV/m)	Limits (dBμV/m)	Margin (dB)	Detector (PK/AV)	Polarity (H/V)
Low Channel:802.11n40(Worst Case)-2422MHz									
2390	41.26	28.72	3.36	26.32	47.02	74	-26.98	peak	Vertical
4844	30.69	32.94	3.98	27.49	40.12	54	-13.88	Average	Vertical
4844	41.57	32.94	3.98	27.49	51.00	74	-23.00	peak	Vertical
7266	31.23	25.28	5.51	27.94	34.08	54	-19.92	Average	Vertical
7266	41.67	25.28	5.51	27.94	44.52	74	-29.48	peak	Vertical
2390	41.29	28.72	3.36	26.32	47.05	74	-26.95	peak	Horizontal
4844	31.32	32.94	3.98	27.49	40.75	54	-13.25	Average	Horizontal
4844	41.37	32.94	3.98	27.49	50.80	74	-23.20	peak	Horizontal
7266	31.39	25.28	5.51	27.94	34.24	54	-19.76	Average	Horizontal
7266	40.58	25.28	5.51	27.94	43.43	74	-30.57	peak	Horizontal
Middle Channel:802.11n40(Worst Case)-2437MHz									
4874	31.26	32.11	4.04	27.53	39.88	54	-14.12	Average	Vertical
4874	41.09	32.11	4.04	27.53	49.71	74	-24.29	peak	Vertical
7311	32.37	24.33	5.58	27.96	34.32	54	-19.68	Average	Vertical
7311	40.56	24.33	5.58	27.96	42.51	74	-31.49	peak	Vertical
4874	32.15	32.11	4.04	27.53	40.77	54	-13.23	Average	Horizontal
4874	40.21	32.11	4.04	27.53	48.83	74	-25.17	peak	Horizontal
7311	30.69	24.33	5.58	27.96	32.64	54	-21.36	Average	Horizontal
7311	39.89	24.33	5.58	27.96	41.84	74	-32.16	peak	Horizontal
High Channel:802.11n40(Worst Case)-2452MHz									
2483.5	41.26	28.79	3.48	26.34	47.19	74	-26.81	peak	Vertical
4904	32.36	31.32	4.12	27.58	40.22	54	-13.78	Average	Vertical
4904	41.87	31.32	4.12	27.58	49.73	74	-24.27	peak	Vertical
7356	32.33	24.38	5.68	27.99	34.40	54	-19.60	Average	Vertical
7356	42.57	24.38	5.68	27.99	44.64	74	-29.36	peak	Vertical
2483.5	40.67	28.79	3.48	26.34	46.60	74	-27.40	peak	Horizontal
4904	31.26	31.32	4.12	27.58	39.12	54	-14.88	Average	Horizontal
4904	42.64	31.32	4.12	27.58	50.50	74	-23.50	peak	Horizontal
7356	32.38	24.38	5.68	27.99	34.45	54	-19.55	Average	Horizontal
7356	42.59	24.38	5.68	27.99	44.66	74	-29.34	peak	Horizontal

NOTE:1.Absolute Level= ReadingLevel+antenna Factor+cable loss-preamp factor.

Note:

- 1, The testing has been conformed to 10*2462MHz=24,620MHz
- 2, All other emissions more than 30 dB below the limit
- 3, X-Axis, Y-Axis and Z-Axis were investigated. The results above show only the worst case.
- 4, The radiated spurious test above 18GHz is subcontracted to SIEMIC (Nanjing-China) Laboratories. and found 30dB below the limit at least.

Annex A. TEST INSTRUMENT

Instrument	Model	Serial #	Cal Date	Cal Due	In use
AC Line Conducted					
EMI test receiver	ESCS30	8471241027	09/15/2017	09/14/2018	<input checked="" type="checkbox"/>
Line Impedance	LI-125A	191106	09/23/2017	09/22/2018	<input checked="" type="checkbox"/>
Line Impedance	LI-125A	191107	09/23/2017	09/22/2018	<input checked="" type="checkbox"/>
ISN	ISN T800	34373	09/23/2017	09/22/2018	<input type="checkbox"/>
Transient Limiter	LIT-153	531118	08/30/2017	08/29/2018	<input type="checkbox"/>
RF conducted test					
Agilent ESA-E SERIES	E4407B	MY45108319	09/15/2017	09/14/2018	<input checked="" type="checkbox"/>
Power Splitter	1#	1#	08/30/2017	08/29/2018	<input checked="" type="checkbox"/>
DC Power Supply	E3640A	MY40004013	09/15/2017	09/14/2018	<input checked="" type="checkbox"/>
Radiated Emissions					
EMI test receiver	ESL6	100262	09/15/2017	09/14/2018	<input checked="" type="checkbox"/>
Positioning Controller	UC3000	MF780208282	11/17/2017	11/16/2018	<input checked="" type="checkbox"/>
OPT 010 AMPLIFIER (0.1-1300MHz)	8447E	2727A02430	08/30/2017	08/29/2018	<input checked="" type="checkbox"/>
Microwave Preamplifier (1 ~ 26.5GHz)	8449B	3008A02402	03/22/2018	03/21/2019	<input checked="" type="checkbox"/>
Horn Antenna	BBHA9170	3145226D1	09/27/2017	09/26/2018	<input checked="" type="checkbox"/>
Active Antenna (9kHz-30MHz)	AL-130	121031	10/12/2017	10/11/2018	<input checked="" type="checkbox"/>
Bilog Antenna (30MHz~6GHz)	JB6	A110712	09/19/2017	09/18/2018	<input checked="" type="checkbox"/>
Double Ridge Horn Antenna (1 ~18GHz)	AH-118	71283	09/22/2017	09/21/2018	<input checked="" type="checkbox"/>
Universal Radio Communication Tester	CMU200	121393	09/23/2017	09/22/2018	<input checked="" type="checkbox"/>

Annex B. TEST SETUP AND SUPPORTING EQUIPMENT

Annex B.i. TEST SET UP BLOCK

Block Configuration Diagram for AC Line Conducted Emissions

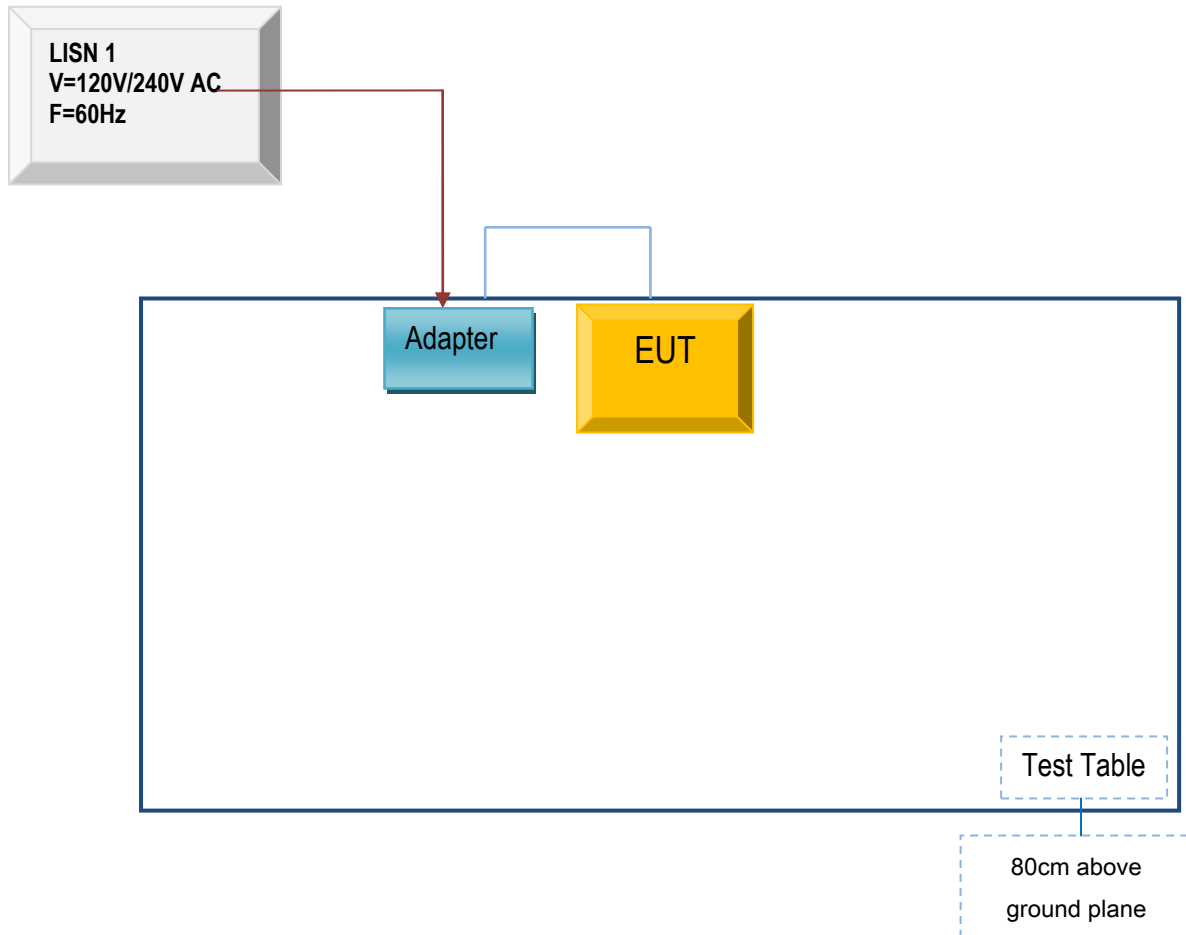

Block Configuration Diagram for Radiated Emissions (Below 1GHz) .

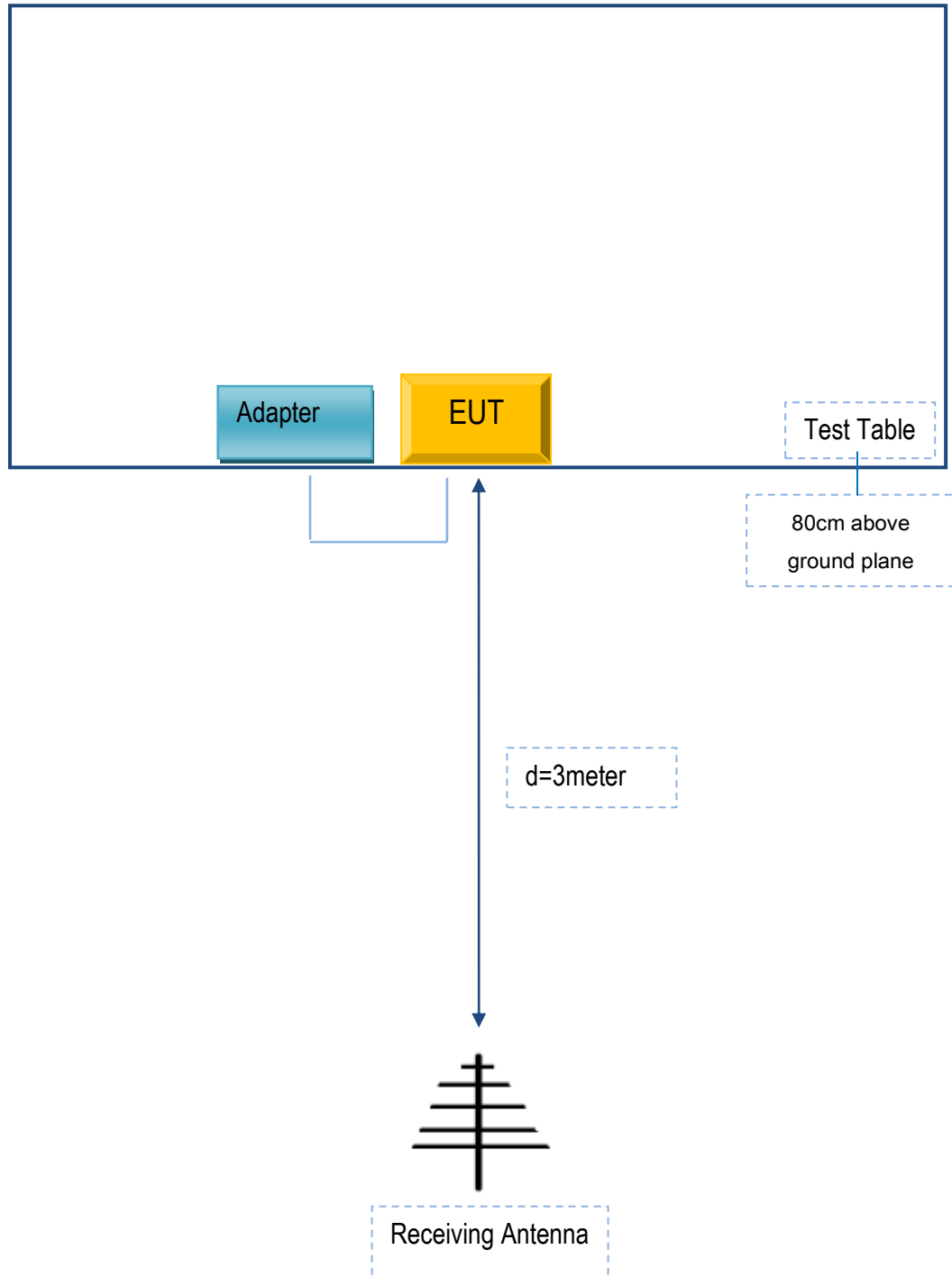

Block Configuration Diagram for Radiated Emissions (Above 1GHz) .

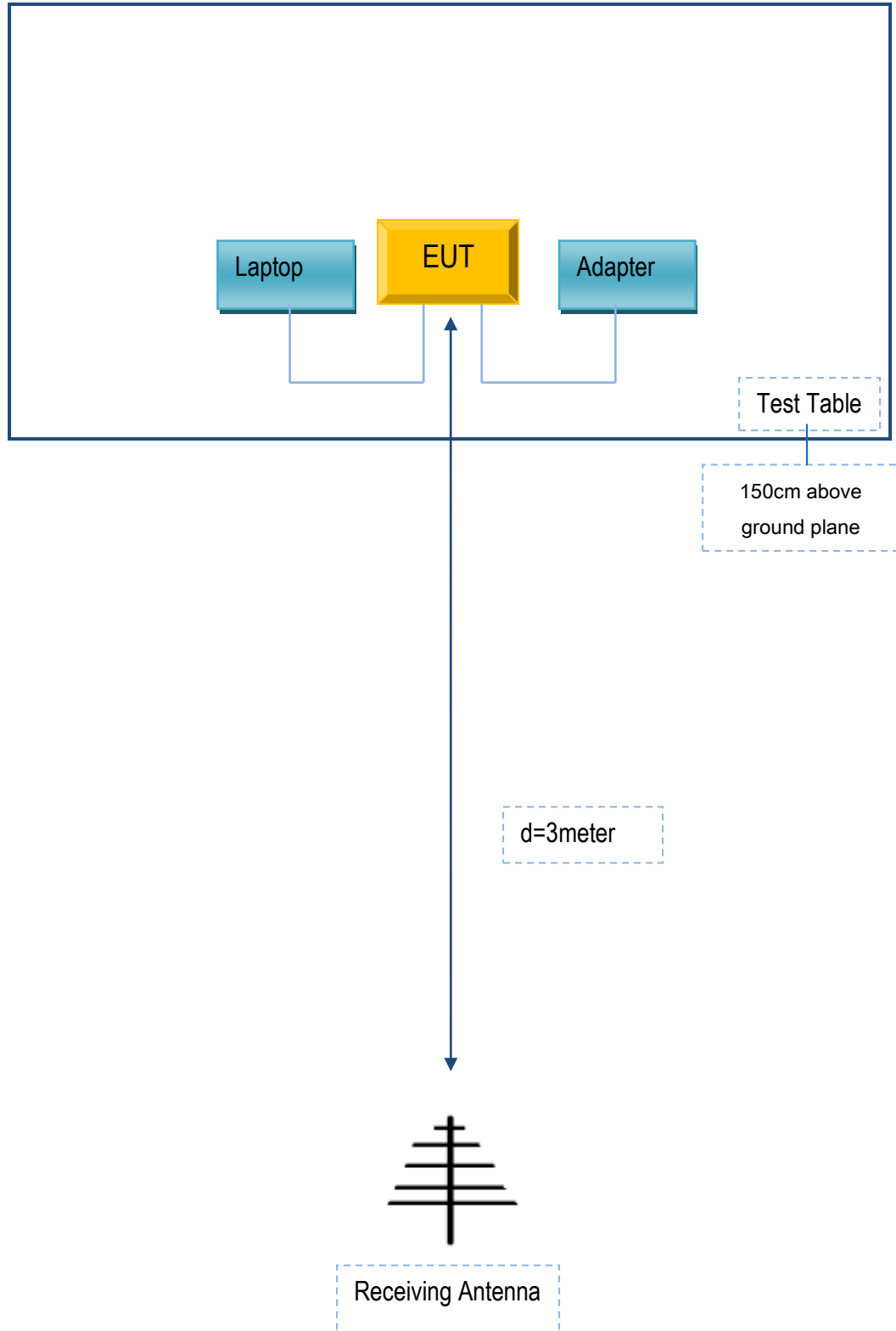

Annex B. ii. SUPPORTING EQUIPMENT DESCRIPTION

The following is a description of supporting equipment and details of cables used with the EUT.

Supporting Equipment:

Manufacturer	Equipment Description	Model	Serial No
Lenovo	Laptop	E40	N/A
Shenzheng Gongjin Electronics Co., Ltd.	Adapter	S06A12-050A100-C4	N/A

Supporting Cable:

Cable type	Shield Type	Ferrite Core	Length	Serial No
USB Cable	Un-shielding	No	0.8m	N/A
Power Cable	Un-shielding	No	0.8m	N/A

Test Report No.	18070574-FCC-R
Page	66 of 66

**Annex C. User Manual / Block Diagram / Schematics / Partlist/
DECLARATION OF SIMILARITY**

Please see the attachment