

FCC Radio Test Report

FCC ID: 2AJSN-S1

Original Grant

Report No. : TB-FCC149703
Applicant : WellCare Today, LLC
Equipment Under Test (EUT)
EUT Name : Smart Watch
Model No. : S1
Series No. : N/A
Brand Name : N/A
Receipt Date : 2016-09-01
Test Date : 2016-09-02 to 2016-09-21
Issue Date : 2016-09-23
Standards : FCC Part 2
FCC Part 22 Subpart H, FCC Part 24 Subpart E, 2015
ANSI/TIAC63.26: 2015
Conclusions : **PASS**
In the configuration tested, the EUT complied with the standards specified above,
The EUT technically complies with the FCC requirements

Test/Witness Engineer :

Iwan Su

Approved & Authorized :

Ray Lai



This report details the results of the testing carried out on one sample. The results contained in this test report do not relate to other samples of the same product. The manufacturer should ensure that all products in series production are in conformity with the product sample detailed in the report.

Contents

CONTENTS	2
1. GENERAL INFORMATION ABOUT EUT	4
1.1 Client Information.....	4
1.2 General Description of EUT (Equipment Under Test)	4
1.3 Block Diagram Showing the Configuration of System Tested.....	5
1.4 Description of Support Units	5
1.5 Description of Test Mode.....	5
1.6 Measurement Uncertainty	6
1.7 Test Facility.....	7
2. TEST SUMMARY	8
3. TEST EQUIPMENT	9
4. FREQUENCY STABILITY	10
4.1 Test Standard and Requirement	10
4.2 Test Setup.....	10
4.3 Test Procedure.....	11
4.4 EUT Operating Condition	11
5. CONDUCTED RF OUTPUT POWER	14
5.1 Test Standard and Limit.....	14
5.2 Test Setup.....	14
5.3 Test Procedure.....	14
5.4 EUT Operating Condition	14
5.5 EUT Operating Condition	14
6. PEAK-AVERAGE RATIO	17
6.1 Test Standard and Limit.....	17
6.2 Test Setup.....	17
6.3 Test Procedure.....	17
6.4 EUT Operating Condition	17
6.5 Test Data.....	18
7. RADIATED OUTPUT POWER	20
7.1 Test Standard and Limit.....	20
7.2 Test Setup.....	20
7.3 Test Procedure.....	21
7.4 EUT Operating Condition	21
7.5 Test Data.....	22
8. OCCUPIED BANDWIDTH	24
8.1 Test Standard and Limit.....	24
8.2 Test Setup.....	24

8.3 Test Procedure.....	24
8.4 EUT Operating Condition	25
8.5 Test Data.....	25
9. CONDUCTED OUT OF BAND EMISSIONS.....	39
9.1 Test Standard and Limit.....	39
9.2 Test Setup.....	39
9.3 Test Procedure.....	39
9.4 EUT Operating Condition	39
9.5 Test Data.....	40
Please refer following plots:.....	40
10. BAND EDGE TEST	52
10.1 Test Standard and Limit	52
10.2 Test Setup.....	52
10.3 Test Procedure.....	52
10.4 EUT Operating Condition	52
10.5 Test Data.....	53
11. RADIATED OUT BAND OF EMISSIONS.....	59
11.1 Test Standard and Limit	59
11.2 Test Setup.....	59
11.3 Test Procedure.....	59
11.4 EUT Operating Condition	60
11.5 Test Data.....	60

1. General Information about EUT

1.1 Client Information

Applicant : WellCare Today, LLC
Address : 75 Lane Road, Suite 404 Fairfield, NJ. 07004, United States
Manufacturer : Shenzhen NJY Science & Technology Co., Ltd
Address : No 5 Songpingshan Road, #202Jia Da R&D Bulding Lobby B, ShenZhen, 518057 China

1.2 General Description of EUT (Equipment Under Test)

EUT Name	: Smart Watch								
Models No.	: S1								
Model Difference	: N/A								
Product Description	Frequency Bands: GSM 850: 824.20MHz-848.80MHz PCS1900: 1850.20MHz-1909.80MHz Bluetooth3.0: 2402MHz~2480MHz see note(1)								
	<table border="1"> <tr> <td>GSM 850 Power :</td> <td>Cond:33.67 dBm ERP:30.57 dBm</td> </tr> <tr> <td>PCS 1900 Power :</td> <td>Cond:29.96 dBm EIRP:27.34 dBm</td> </tr> <tr> <td>Antenna Gain:</td> <td>GSM 850:-0.8 dBi PCS 1900: -0.7 dBi</td> </tr> <tr> <td>Modulation Type:</td> <td>GSM/GPRS/ EDGE:GMSK</td> </tr> </table>	GSM 850 Power :	Cond:33.67 dBm ERP:30.57 dBm	PCS 1900 Power :	Cond:29.96 dBm EIRP:27.34 dBm	Antenna Gain:	GSM 850:-0.8 dBi PCS 1900: -0.7 dBi	Modulation Type:	GSM/GPRS/ EDGE:GMSK
	GSM 850 Power :	Cond:33.67 dBm ERP:30.57 dBm							
	PCS 1900 Power :	Cond:29.96 dBm EIRP:27.34 dBm							
	Antenna Gain:	GSM 850:-0.8 dBi PCS 1900: -0.7 dBi							
Modulation Type:	GSM/GPRS/ EDGE:GMSK								
FCC Operating Frequency	: GSM 850: 824.20MHz-848.80MHz PCS1900: 1850.20MHz-1909.80MHz								
Emission Designator	: GSM 850: 249KGXW, PCS 1900: 247KGXW GPRS 850: 244KG7W, GPRS 1900: 249KG7W EGPRS 850: 246KG7W, EGPRS 1900: 252KG7W								
Power Supply	: DC Voltage supplied from travel charger. DC power by Li-ion Battery.								
Power Rating	: Travel Charger: Input: AC 100~240V, 50/60Hz, 0.2A. Output: DC 5V, 1A. DC 3.7V by Li-ion Battery.								
Connecting I/O Port(S)	: Please refer to the User's Manual								

Note:

(1) For a more detailed features description, please refer to the manufacturer's specifications or

the User’s Manual. The EUT has also been tested and complied the FCC 15C for Bluetooth function, and recorded in the separate test report.

(2) This test report only product for PCS Licensed Transmitter (PCB).

1.3 Block Diagram Showing the Configuration of System Tested

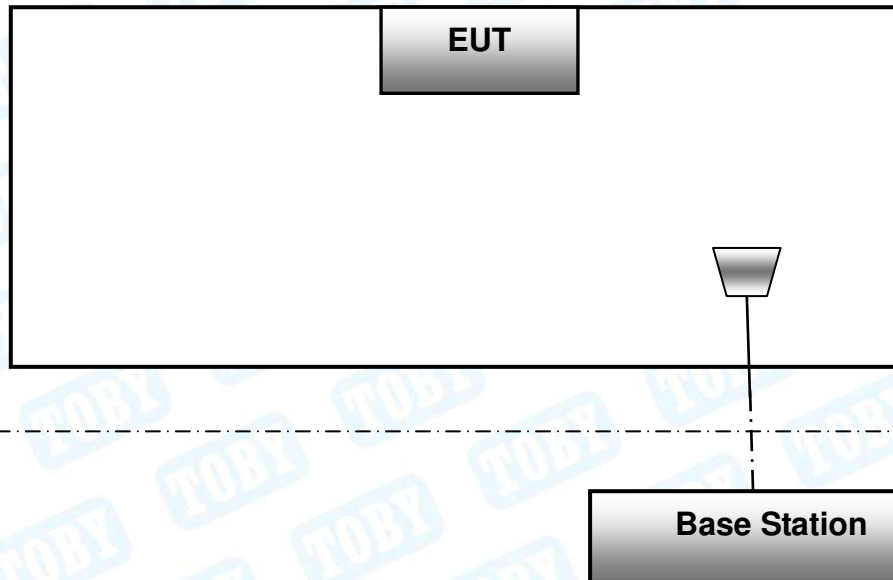

The above block diagram of setup is the normal mode. And more detail please refer to the test setup of each test item of bellow.

1.4 Description of Support Units

The EUT has been tested as an independent unit.

1.5 Description of Test Mode

To investigate the maximum EMI emission characteristics generates from EUT, the test system was pre-scanning tested base on the consideration of following EUT operation mode or test configuration mode which possible have effect on EMI emission level. Each of these EUT operation mode(s) or test configuration mode(s) mentioned follow was evaluated respectively.

During all testing, EUT is link mode with base station at maximum power level. The spurious emission measurements were carried out in semi-anechoic chamber with 3-meter test range. Frequency range investigated for radiated emission as below:

1. 9kHz~10GHz for GSM850.
2. 9kHz~20GHz for PCS1900.

Test Channel		
Mode	Channel	Frequency(MHz)
GSM 850	128	824.20

	190	836.60
	251	848.80
PCS 1900	512	1850.20
	661	1880.00
	810	1909.80
Pre-scanning test Mode		Description
GSM 850		highest , middle, lowest channels
GPRS 850		highest , middle, lowest channels
GSM 1900		highest , middle, lowest channels
GPRS 1900		highest , middle, lowest channels
Final test Mode		Description
GSM 850		highest , middle, lowest channels
GSM 1900		highest , middle, lowest channels

Note:

- (1) The measurements are performed at the highest, middle, lowest available channels.
- (2) During the testing procedure, the EUT is in link mode with base station emulator at maximum power level in each test mode.
- (3) The EUT has GSM, GPRS, EDGE functions, and after pre-testing, GSM function is the worst case for all the emission tests.
- (4) The EUT is considered a portable unit; it was pre-tested on the positioned of each 3 axis, X-plane, Y-plane and Z-plane. The worst case was found positioned on Z-plane as the normal use. Therefore only the test data of this Z-plane was used for radiated emission measurement test.

1.6 Measurement Uncertainty

Test Item	Parameters	Expanded Uncertainty (U _{Lab})
Conducted Emission	Level Accuracy: 9kHz~150kHz	±3.42 dB
	150kHz to 30MHz	±3.42 dB
Radiated Emission	Level Accuracy: 9kHz to 30 MHz	±4.60 dB
Radiated Emission	Level Accuracy: 30MHz to 1000 MHz	±4.40 dB
Radiated Emission	Level Accuracy: Above 1000MHz	±4.20 dB

1.7 Test Facility

The testing was performed by the Shenzhen Toby Technology Co., Ltd., in their facilities located at: 1A/F., Bldg.6, Yusheng Industrial Zone, The National Road No.107 Xixiang Section 467, Xixiang, Bao'an, Shenzhen, Guangdong, China.

At the time of testing, the following bodies accredited the Laboratory:

CNAS (L5813)

The Laboratory has been accredited by CNAS to ISO/IEC 17025: 2005 General Requirements for the Competence of Testing and Calibration Laboratories for the competence in the field of testing. And the Registration No.: CNAS L5813.

FCC List No.: (811562)

The Laboratory is listed in the United States of American Federal Communications Commission (FCC), and the registration number is 811562.

IC Registration No.: (11950A-1)

The Laboratory has been registered by Certification and Engineering Bureau of Industry Canada for radio equipment testing. The site registration: Site# 11950A-1.

2. Test Summary

Test Standards and Test Results			
Standard	Document Title		
FCC Part 2 (10-1-05 Edition)	Frequency Allocations and Radio Treaty Matters; General Rules and Regulations		
FCC Part 22 (10-1-05 Edition)	Public Mobile Services		
FCC Part 24 (10-1-05 Edition)	Personal Communications Services		
Standard Section	Test Item	Judgment	Remark
2.1046	Conducted RF Output Power	PASS	N/A
24.232(d)	Peak-Average Ratio	PASS	N/A
2.1049; 22.917; 24.238	99% & -26 dB Occupied Bandwidth	PASS	N/A
2.1055; 22.355; 24.235	Frequency Stability	PASS	N/A
2.1051; 2.1057; 22.917; 24.238	Conducted Out of Band Emissions	PASS	N/A
2.1051; 2.1057; 22.917; 24.238	Band Edge	PASS	N/A
22.913; 24.238	Transmitter Radiated Power (EIRP/ERP)	PASS	N/A
2.1053; 2.1057; 22.917; 24.238	Radiated Out of Band Emissions	PASS	N/A
Note: N/A is an abbreviation for Not Applicable.			

3. Test Equipment

AC Main Conducted Emission					
Description	Manufacturer	Model No.	Serial No.	Cal. Date	Cal. Due Date
EMI Test Receiver	ROHDE& SCHWARZ	ESCI	100321	Jul. 22, 2016	Jul. 21, 2017
50ΩCoaxial Switch	Anritsu	MP59B	X10321	Jul. 22, 2016	Jul. 21, 2017
L.I.S.N	Rohde & Schwarz	ENV216	101131	Jul. 22, 2016	Jul. 21, 2017
L.I.S.N	SCHWARZBECK	NNBL 8226-2	8226-2/164	Jul. 22, 2016	Jul. 21, 2017
Radiation Spurious Emission					
Description	Manufacturer	Model No.	Serial No.	Cal. Date	Cal. Due Date
Spectrum Analyzer	Agilent	E4407B	MY45106456	Jul. 22, 2016	Jul. 21, 2017
EMI Test Receiver	Rohde & Schwarz	ESCI	100010/007	Jul. 22, 2016	Jul. 21, 2017
Bilog Antenna	ETS-LINDGREN	3142E	00117537	Mar. 20, 2016	Mar. 19, 2017
Bilog Antenna	ETS-LINDGREN	3142E	00117542	Mar. 20, 2016	Mar. 19, 2017
Horn Antenna	ETS-LINDGREN	3117	00143207	Mar. 19, 2016	Mar. 18, 2017
Horn Antenna	ETS-LINDGREN	3117	00143209	Mar. 19, 2016	Mar. 18, 2017
Pre-amplifier	Sonoma	310N	185903	Mar. 20, 2016	Mar. 19, 2017
Pre-amplifier	HP	8449B	3008A00849	Mar. 26, 2016	Mar. 25, 2017
Cable	HUBER+SUHNER	100	SUCOFLEX	Mar. 26, 2016	Mar. 25, 2017
Signal Generator	Rohde & Schwarz	SML03	IKW682-054	Mar. 26, 2016	Mar. 25, 2017
Positioning Controller	ETS-LINDGREN	2090	N/A	N/A	N/A
Universal Radio Communication Tester	Rohde&Schwarz	CMU200	103903	Jun.23, 2016	Jun.22, 2017
Antenna Conducted Emission					
Description	Manufacturer	Model No.	Serial No.	Cal. Date	Cal. Due Date
Spectrum Analyzer	Agilent	E4407B	MY45106456	Jul. 22, 2016	Jul. 21, 2017
EMI Test Receiver	Rohde & Schwarz	ESCI	100010/007	Jul. 22, 2016	Jul. 21, 2017
Universal Radio Communication Tester	Rohde&Schwarz	CMU200	103903	Jun.23, 2016	Jun.22, 2017

4. Frequency Stability

4.1 Test Standard and Requirement

4.1.1 Test Standard

FCC Part 2.1055

FCC Part 22.355

FCC Part 24.235

4.1.2 Requirement

According to FCC section 22.355 and FCC section 24.235, the frequency stability shall be sufficient to ensure that the fundamental emission stays within the authorized frequency block. According to FCC section 2.1055, the test conditions are:

(1) Temperature:

The temperature is varied from -30°C to $+50^{\circ}\text{C}$ at intervals of not more than 10°C .

(2) Primary Supply Voltage:

For hand carried battery powered equipment, the primary supply voltage is reduced to the battery operating end point which shall be specified by the manufacture. The supply voltage shall be measured at input to the cable normally provide with the equipment, or at the power supply terminals if cables are not normally provided.

4.2 Test Setup

For Temperature Test:

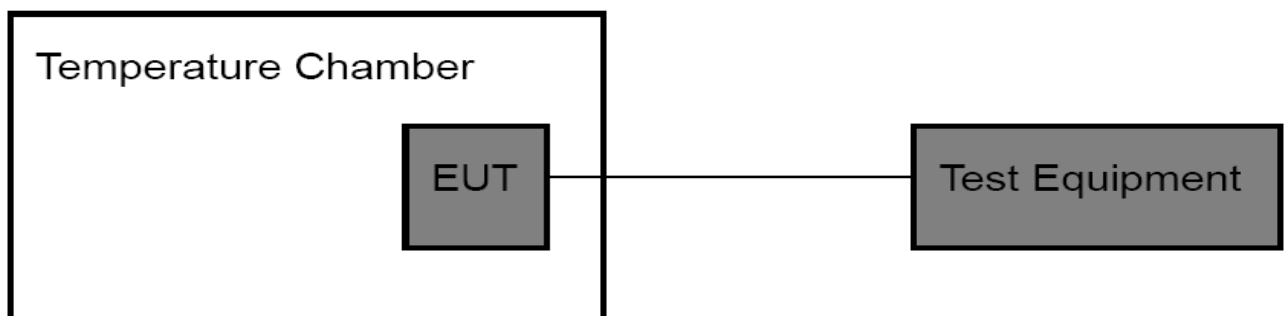

For Voltage Test:

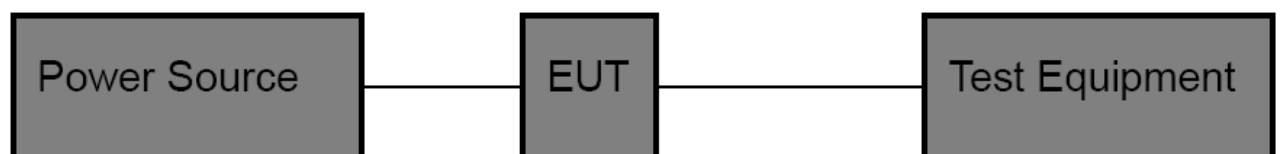

4.3 Test Procedure

Test Procedures for Temperature Variation:

- (1) The EUT was set up in the thermal chamber and connected with the base station.
- (2) With power off, the temperature was decreased to -30°C and the EUT was stabilized for three hours. Power was applied and the maximum change in frequency was recorded within one minute.
- (3) With power off, the temperature was raised in 10°C set up to 50°C and the EUT was stabilized for three hours. Power was applied and the maximum change in frequency was recorded within one minute.
- (4) If the EUT cannot be turned on at -30°C , the testing lowest temperature will be raised in 10°C step until the EUT can be turned on.

Test Procedures for Voltage Variation:

- (1) The EUT was placed in a temperature chamber at $25 \pm 5^{\circ}\text{C}$ and connected with the base station.
- (2) Reduce the input voltage to specify extreme voltage variation ($\pm 15\%$) and endpoint, record the maximum frequency change.
- (3) The variation in frequency was measured for the worst case.

4.4 EUT Operating Condition

The Equipment Under Test was set to Communication with the Base Station.

3.5 Test Data

Please refer the following pages.

Temperature Variation

Temperature Variation GSM 850 (CH190)						
Temperature (°C)	GSM		GPRS		EDGE	
	Freq. Dev. (Hz)	Deviation (ppm)	Freq. Dev. (Hz)	Deviation (ppm)	Freq. Dev. (Hz)	Deviation (ppm)
-30	20	0.024	18	0.022	12	0.014
-20	19	0.023	15	0.018	11	0.013
-10	21	0.025	16	0.019	9	0.011
0	22	0.026	14	0.017	13	0.016
10	17	0.020	19	0.023	14	0.017
20	16	0.019	20	0.024	10	0.012
30	12	0.014	13	0.016	9	0.011
40	11	0.013	14	0.017	13	0.016
50	10	0.012	16	0.019	11	0.013
60	12	0.014	10	0.012	10	0.012
Limit	2.5 (ppm)					
Result	PASS					

Temperature Variation GSM 1900 (CH661)						
Temperature (°C)	GSM		GPRS		EDGE	
	Freq. Dev. (Hz)	Deviation (ppm)	Freq. Dev. (Hz)	Deviation (ppm)	Freq. Dev. (Hz)	Deviation (ppm)
-30	25	0.038	13	0.020	22	0.033
-20	23	0.035	16	0.024	20	0.030
-10	26	0.039	19	0.029	18	0.027
0	29	0.044	17	0.026	17	0.026
10	20	0.030	13	0.020	16	0.024
20	22	0.033	10	0.015	13	0.020
30	24	0.036	14	0.021	15	0.023
40	20	0.030	13	0.020	17	0.026
50	22	0.033	14	0.021	18	0.027
60	21	0.032	16	0.024	20	0.030
Limit	2.5 (ppm)					
Result	PASS					

Voltage Variation

Voltage Variation GSM 850 (CH190)						
Voltage (V)	GSM		GPRS		EDGE	
	Freq. Dev. (Hz)	Deviation (ppm)	Freq. Dev. (Hz)	Deviation (ppm)	Freq. Dev. (Hz)	Deviation (ppm)
3.15	16	0.019	9	0.011	13	0.016
3.70	20	0.024	11	0.013	11	0.013
4.26	19	0.023	12	0.014	15	0.018
Limit	2.5 (ppm)					
Result	PASS					

Voltage Variation GSM 1900 (CH661)						
Voltage (V)	GSM		GPRS		EDGE	
	Freq. Dev. (Hz)	Deviation (ppm)	Freq. Dev. (Hz)	Deviation (ppm)	Freq. Dev. (Hz)	Deviation (ppm)
3.15	20	0.030	14	0.021	16	0.024
3.70	18	0.027	11	0.017	12	0.018
4.26	22	0.033	10	0.015	15	0.023
Limit	2.5 (ppm)					
Result	PASS					

5. Conducted RF Output Power

5.1 Test Standard and Limit

5.1.1 Test Standard

FCC Part 2: 2.1046

FCC Part 22H : 22.913 (a)

FCC Part 24E: 24.232 (c)

5.1.2 Test Limit

GSM850	PCS 1900
38.5 dBm (ERP)	33 dBm (EIRP)

5.2 Test Setup

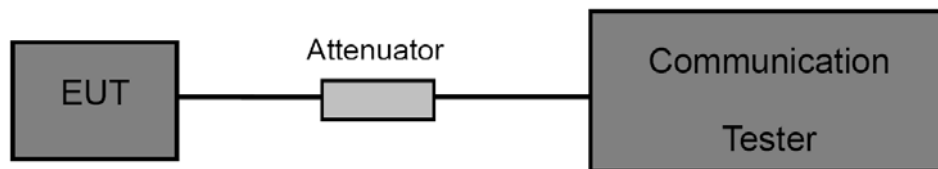

5.3 Test Procedure

- (1) The EUT is coupled to the Base Station with the suitable Attenuator, the path loss is calibrated to correct the reading.
- (2) A call is set up by the Base Station to the generic call set up procedure.
- (3) Set EUT at maximum power level through base station by power level command.
- (4) Then read record the power value from the Base Station in dBm.

5.4 EUT Operating Condition

The EUT was continuously connected with the Base station and transmitting in the max power during the test.

5.5 EUT Operating Condition

GSM 850				
Mode	Channel	Frequency (MHz)	Conducted Power (dBm)	Conducted Power (W)
GSM 850	128	824.2	33.25	2.113
	190	836.6	33.67	2.328
	251	848.8	33.02	2.004
GPRS 850 (1 Slot)	128	824.2	31.44	1.393
	190	836.6	31.95	1.567
	251	848.8	31.31	1.702
GPRS 850 (2 Slot)	128	824.2	31.21	1.321
	190	836.6	31.02	1.265
	251	848.8	31.23	1.327
GPRS 850 (3 Slot)	128	824.2	31.09	1.285
	190	836.6	31.06	1.276
	251	848.8	31.14	1.300
GPRS 850 (4 Slot)	128	824.2	31.06	1.276
	190	836.6	31.19	1.315
	251	848.8	31.54	1.426
EDGE 850 (1 Slot)	128	824.2	31.53	1.422
	190	836.6	31.99	1.581
	251	848.8	31.30	1.349
EDGE 850 (2 Slot)	128	824.2	30.98	1.253
	190	836.6	30.96	1.247
	251	848.8	30.06	1.276
EDGE 850 (3 Slot)	128	824.2	30.87	1.222
	190	836.6	30.69	1.172
	251	848.8	30.57	1.140
EDGE 850 (4 Slot)	128	824.2	30.76	1.191
	190	836.6	30.83	1.211
	251	848.8	30.59	1.146

PCS 1900				
Mode	Channel	Frequency (MHz)	Conducted Power (dBm)	Conducted Power (W)
GSM 1900	512	1850.2	29.60	0.912
	661	1880.0	29.96	0.991
	810	1909.8	29.33	0.857
GPRS 1900 (1 Slot)	512	1850.2	28.64	0.731
	661	1880.0	29.00	0.794
	810	1909.8	29.37	0.865
GPRS 1900 (2 Slot)	512	1850.2	28.69	0.740
	661	1880.0	28.34	0.682
	810	1909.8	28.96	0.787
GPRS 1900 (3 Slot)	512	1850.2	28.67	0.736
	661	1880.0	28.53	0.713
	810	1909.8	28.66	0.735
GPRS 1900 (4 Slot)	512	1850.2	28.47	0.703
	661	1880.0	28.59	0.723
	810	1909.8	28.72	0.745
EDGE 1900 (1 Slot)	512	1850.2	28.67	0.736
	661	1880.0	28.97	0.789
	810	1909.8	28.38	0.689
EDGE 1900 (2 Slot)	512	1850.2	28.16	0.655
	661	1880.0	28.24	0.667
	810	1909.8	28.31	0.678
EDGE 1900 (3 Slot)	512	1850.2	28.46	0.701
	661	1880.0	28.51	0.710
	810	1909.8	28.44	0.698
EDGE 1900 (4 Slot)	512	1850.2	28.39	0.690
	661	1880.0	28.20	0.661
	810	1909.8	28.42	0.695

6. Peak-Average Ratio

6.1 Test Standard and Limit

- 6.1.1 Test Standard
FCC Part 24E: 24.232 (d)
- 6.1.2 Test Limit

PCS 1900
The peak-to-average ratio (PAR) of the transmission may not exceed 13 dB.

6.2 Test Setup

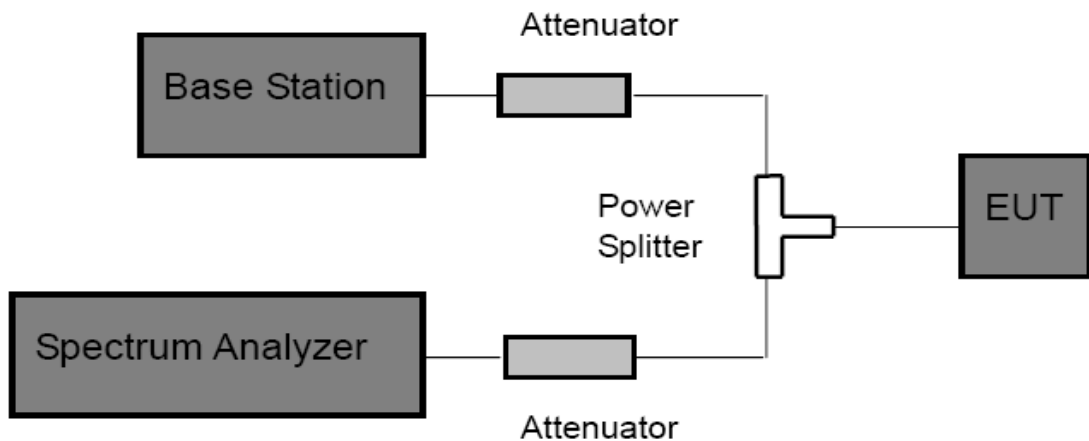

6.3 Test Procedure

According with KDB 971168

- (1) The signal analyzer's CCDF measurement profile is enabled.
- (2) Frequency = carrier center frequency.
- (3) Measurement BW > Emission bandwidth of signal.
- (4) The signal analyzer was set to collect one million samples to generate the CCDF curve.
- (5) The measurement interval was set depending on the type of signal analyzed. For continuous signals (>98% duty cycle), the measurement interval was set to 1ms. For burst transmissions, the spectrum analyzer is set to use an internal "RF Burst" trigger that is synced with an incoming pulse and the measurement interval is set to less than the duration of the "on time" of one burst to ensure that energy is only captured during a time in which of the transmitter is operating at maximum power.

6.4 EUT Operating Condition

The EUT was continuously connected with the Base station and transmitting in the max power during the test.

6.5 Test Data

PCS 1900			
Mode	Channel	Frequency (MHz)	Peak-Average Ratio (PAR)
PCS 1900	512	1850.2	0.112
	661	1880.0	0.131
	810	1909.8	0.107

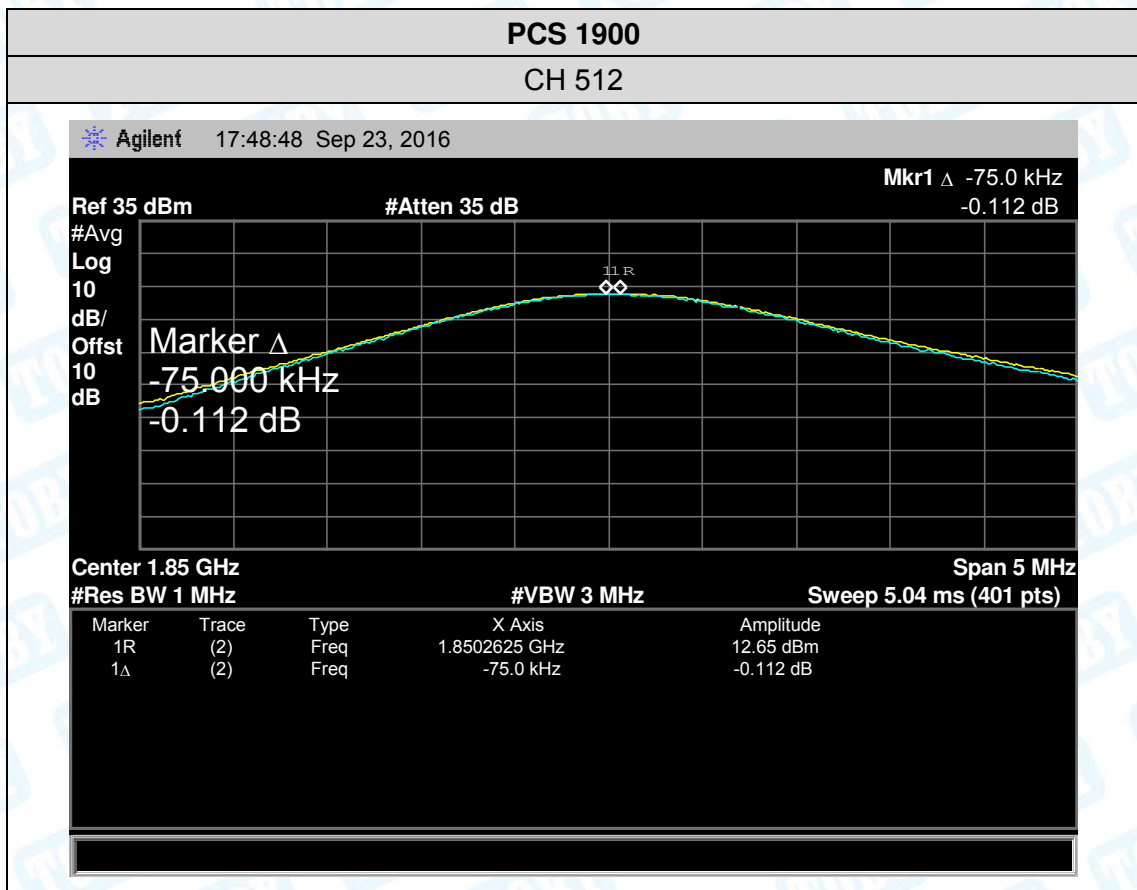

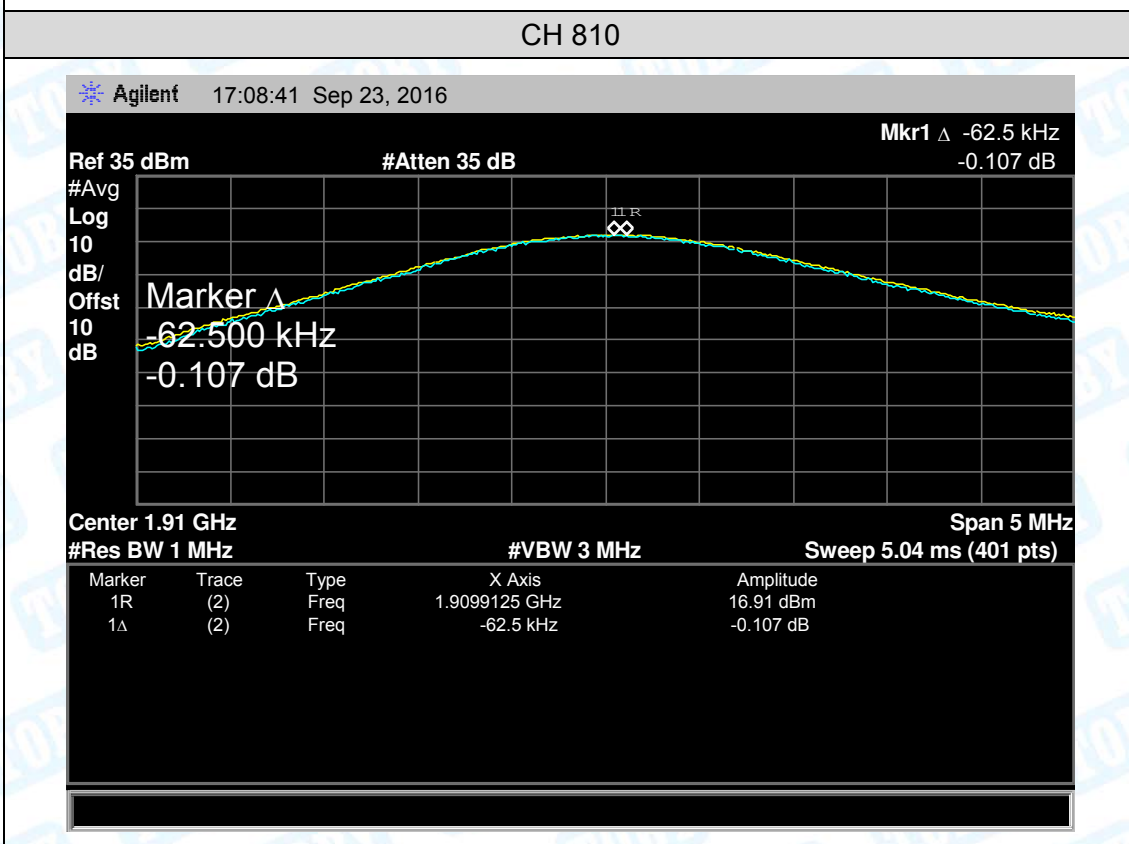
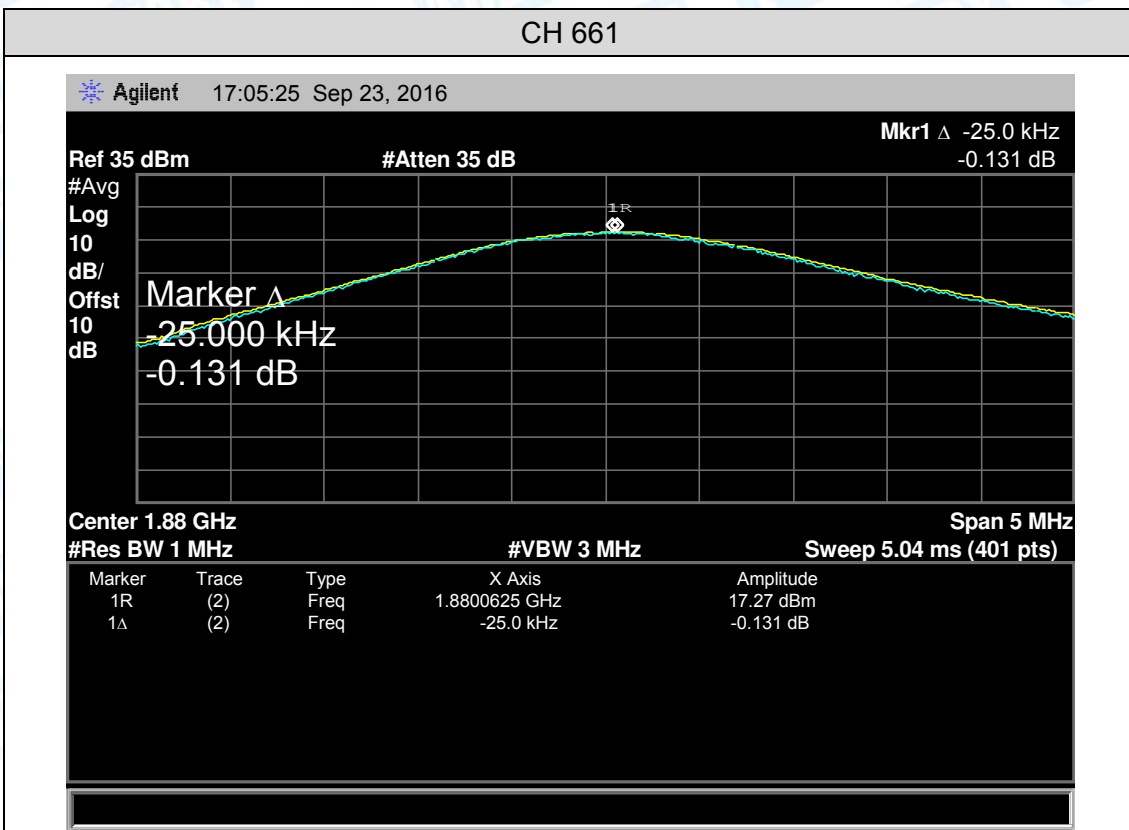

7. Radiated Output Power

7.1 Test Standard and Limit

7.1.1 Test Standard

FCC Part 22H : 22.913 (a)

FCC Part 24E: 24.232 (c)

7.1.2 Test Limit

According to FCC Part 22.913 (a), the ERP of Cellular mobile transmitters must not exceed 7 Watts(38.5 dBm).

According to FCC Part 24.232 (c), the Mobile/portable stations are limited to 2 Watts(33 dBm) EIRP peak power.

Cellular Band	PCS Band
GSM850	PCS 1900
38.5 dBm (ERP)	33 dBm (EIRP)

7.2 Test Setup

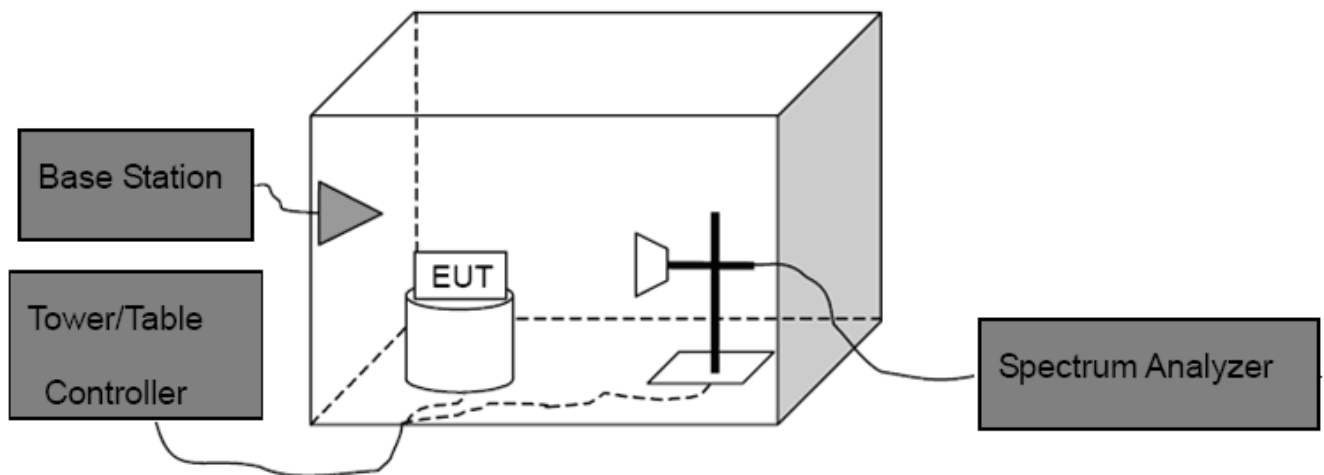

Above 1G

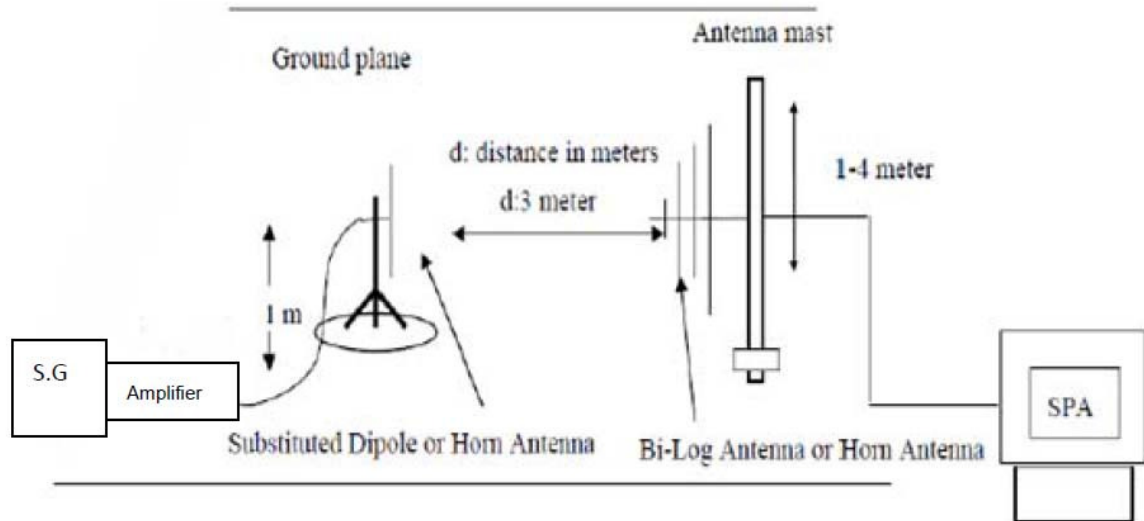

Substituted Method

7.3 Test Procedure

- (1) The EUT was placed on a non-conductive rotating platform with 0.8 meter height in an anechoic chamber. The radiated emission at the fundamental frequency was measured at 3 m with a test antenna and a spectrum analyzer with RBW=3 MHz, VBW=3 MHz and peak detector settings.
- (2) During the measurement, the EUT was enforced in maximum power and linked with the Base Station. The highest was recorded from analyzer power level (LVT) from the 360 degrees rotation of the turntable and the test antenna raised and lowered over a range from 1 to 4 meters in both horizontally and vertically polarized orientations.
- (3) Effective Isotropic Radiated Power (EIRP) was measured by substitution method according to TIA/EIA-603-D. The EUT was replaced by dipole antenna (for frequency below 1 GHz) or Horn antenna (for frequency above 1 GHz) at same location with same polarize of receiver antenna and then a known power of each measure frequency from S.G. was applied into the dipole antenna or Horn antenna through a TX cable, and then recorded the maximum Analyzer reading through raised and lowered the test antenna.

Note: In test, the S.G. Connect the Pre-amplifier (Sonoma 310N Pre-amplifier for frequency below 1 GHz, HP 8449B Pre-amplifier for frequency above 1 GHz)

Then the EUT's EIRP and ERP was calculated with the correction factor:
 $ERP = S.G. Level + Antenna Gain Cord. (dBd) - Cable Loss (dB)$
 $EIRP = S.G. Level + Antenna Gain Cord. (dBi) - Cable Loss (dB)$

7.4 EUT Operating Condition

The EUT was continuously connected with the Base station and transmitting in the max power during the test.

7.5 Test Data

Measurement Data (worst case)

GSM 850								
Mode	Channel	Frequency (MHz)	Antenna (H&V)	SG Level (dBm)	Antenna Gain (dBd)	Cable Loss (dB)	ERP Power (dBm)	ERP Power (W)
GSM 850	128	824.2	H	28.08	3.46	1.26	30.28	1.067
			V	26.14	3.46	1.26	28.34	0.682
	190	836.6	H	27.98	3.82	1.26	30.54	1.132
			V	25.56	3.82	1.26	28.12	0.649
	251	848.8	H	27.34	4.16	1.26	30.24	1.057
			V	25.08	4.16	1.26	27.98	0.628
GPRS 850 (1 Slot)	128	824.2	H	28.37	3.46	1.26	30.57	1.140
			V	25.66	3.46	1.26	27.86	0.611
	190	836.6	H	27.33	3.82	1.26	29.89	0.975
			V	24.76	3.82	1.26	27.32	0.540
	251	848.8	H	26.44	4.16	1.26	29.34	0.859
			V	24.16	4.16	1.26	27.06	0.508
EDGE 850 (1 Slot)	128	824.2	H	26.47	3.46	1.26	28.67	0.736
			V	24.91	3.46	1.26	27.11	0.514
	190	836.6	H	26.40	3.82	1.26	28.96	0.787
			V	24.33	3.82	1.26	26.89	0.489
	251	848.8	H	25.82	4.16	1.26	28.72	0.745
			V	23.86	4.16	1.26	26.76	0.474
Limit						38.5	7	

PCS 1900								
Mode	Channel	Frequency (MHz)	Antenna (H&V)	SG Level (dBm)	Antenna Gain (dBi)	Cable Loss (dB)	EIRP Power (dBm)	EIRP Power (W)
GSM 1900	512	1850.2	H	24.92	5.01	2.59	27.34	0.542
			V	22.22	5.01	2.59	24.64	0.291
	661	1880.0	H	24.93	4.82	2.59	27.16	0.520
			V	21.51	4.82	2.59	23.74	0.237
	810	1909.8	H	25.47	4.45	2.59	27.33	0.541
			V	22.15	4.45	2.59	24.01	0.252
GPRS 1900 (1 Slot)	512	1850.2	H	24.55	5.01	2.59	26.97	0.498
			V	21.15	5.01	2.59	23.57	0.228
	661	1880.0	H	24.89	4.82	2.59	27.12	0.515
			V	21.90	4.82	2.59	24.13	0.259
	810	1909.8	H	24.26	4.45	2.59	26.12	0.409
			V	21.15	4.45	2.59	23.01	0.200
EDGE 1900 (1 Slot)	512	1850.2	H	23.54	5.01	2.59	25.96	0.394
			V	20.74	5.01	2.59	23.16	0.207
	661	1880.0	H	23.61	4.82	2.59	25.84	0.384
			V	20.86	4.82	2.59	23.09	0.204
	810	1909.8	H	24.15	4.45	2.59	26.01	0.399
			V	21.26	4.45	2.59	23.12	0.205
Limit						33	2	

8. Occupied Bandwidth

8.1 Test Standard and Limit

8.1.1 Test Standard

FCC Part 2: 2.1049

FCC Part 22H : 22.913 (a)

FCC Part 24E: 24.232 (c)

8.1.2 Test Requirement

According to FCC section 2.1049, the occupied bandwidth is the frequency bandwidth such that below its lower and above its upper frequency limits, the mean powers radiated are each equal to 0.5 percent of the total mean power radiated by a given emission.

Occupied bandwidth is also known as 99% power and -26dBC occupied bandwidths.

8.2 Test Setup

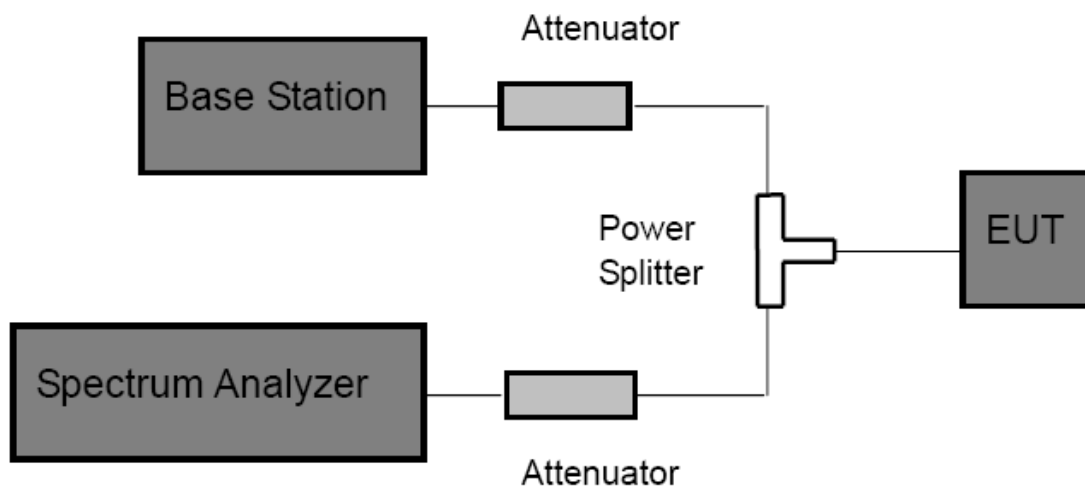

8.3 Test Procedure

- (1) The EUT was directly connected to the spectrum analyzer and Base station via power splitter as show in the block diagram above.
- (2) The resolution bandwidth of the Spectrum Analyzer is set to at least 1% of the occupied bandwidth.
- (3) The low, middle and the high channels are selected to perform tests respectively.
- (4) Set the frequency range of the Spectrum Analyzer suitably to capture the waveform; search peak; make a line whose value is 26dB lower than the peak; mark two points which the line intersected the waveform at; finally record the delta of the two points as the occupied bandwidth and the plot.
- (5) Set the Spectrum Analyzer Occupied bandwidth function to measure the 99% occupied bandwidth.

8.4 EUT Operating Condition

The EUT was continuously connected with the Base station and transmitting in the max power during the test.

8.5 Test Data

Please refer following pages.

GSM 850				
Mode	Channel	Frequency (MHz)	99% OBW (KHz)	-26dB Bandwidth (kHz)
GSM 850	128	824.2	242.1698	316.254
	190	836.6	248.8772	320.757
	251	848.8	243.7949	318.084
GPRS 850 (1 Slot)	128	824.2	243.9777	309.868
	190	836.6	240.3492	316.320
	251	848.8	243.4365	316.876
EDGE 850 (1 Slot)	128	824.2	245.5205	316.774
	190	836.6	244.3482	319.751
	251	848.8	244.6015	317.746
PCS 1900				
Mode	Channel	Frequency (MHz)	99% OBW (KHz)	-26dB Bandwidth (kHz)
GSM 1900	512	1850.2	241.4164	318.238
	661	1880.0	247.4943	310.779
	810	1909.8	246.3760	318.599
GPRS 1900 (1 Slot)	512	1850.2	247.9840	315.532
	661	1880.0	245.4171	319.992
	810	1909.8	249.1125	317.005
EDGE 1900 (1 Slot)	512	1850.2	247.2243	324.079
	661	1880.0	251.8968	319.800
	810	1909.8	243.0744	319.918

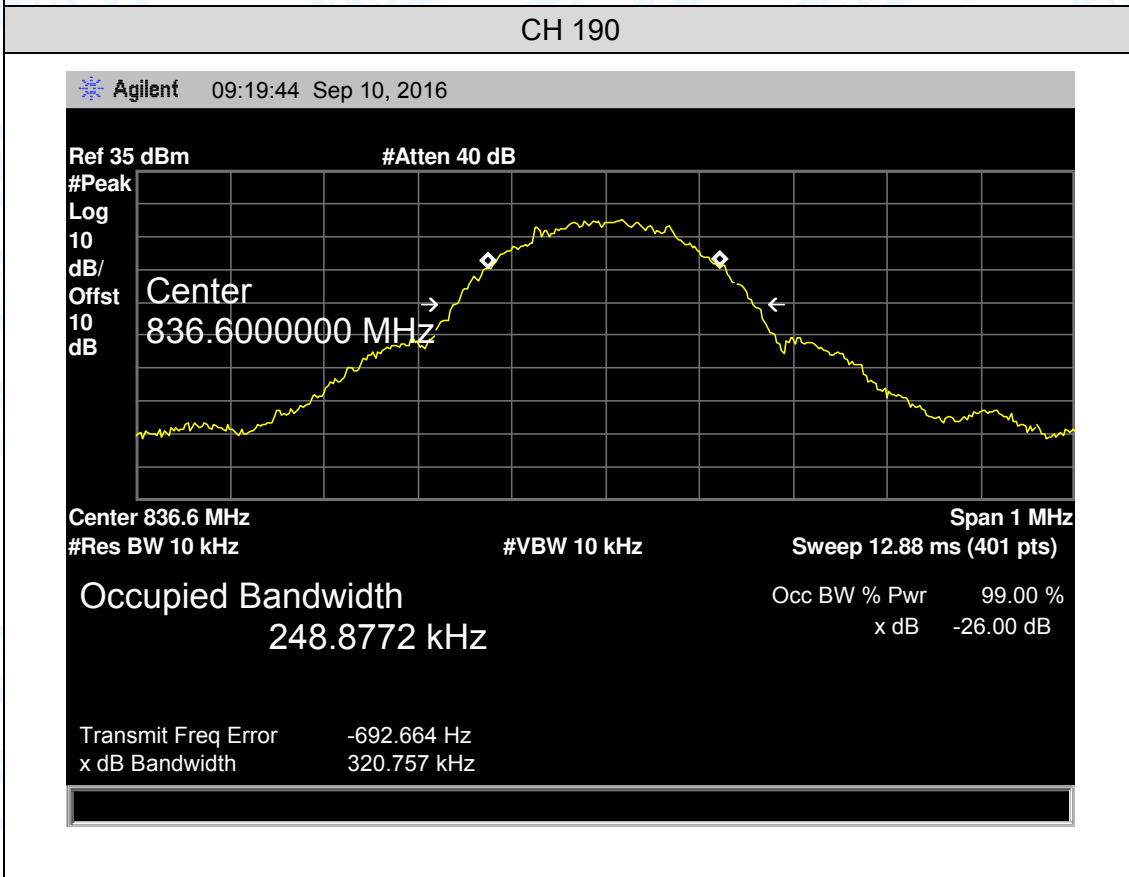
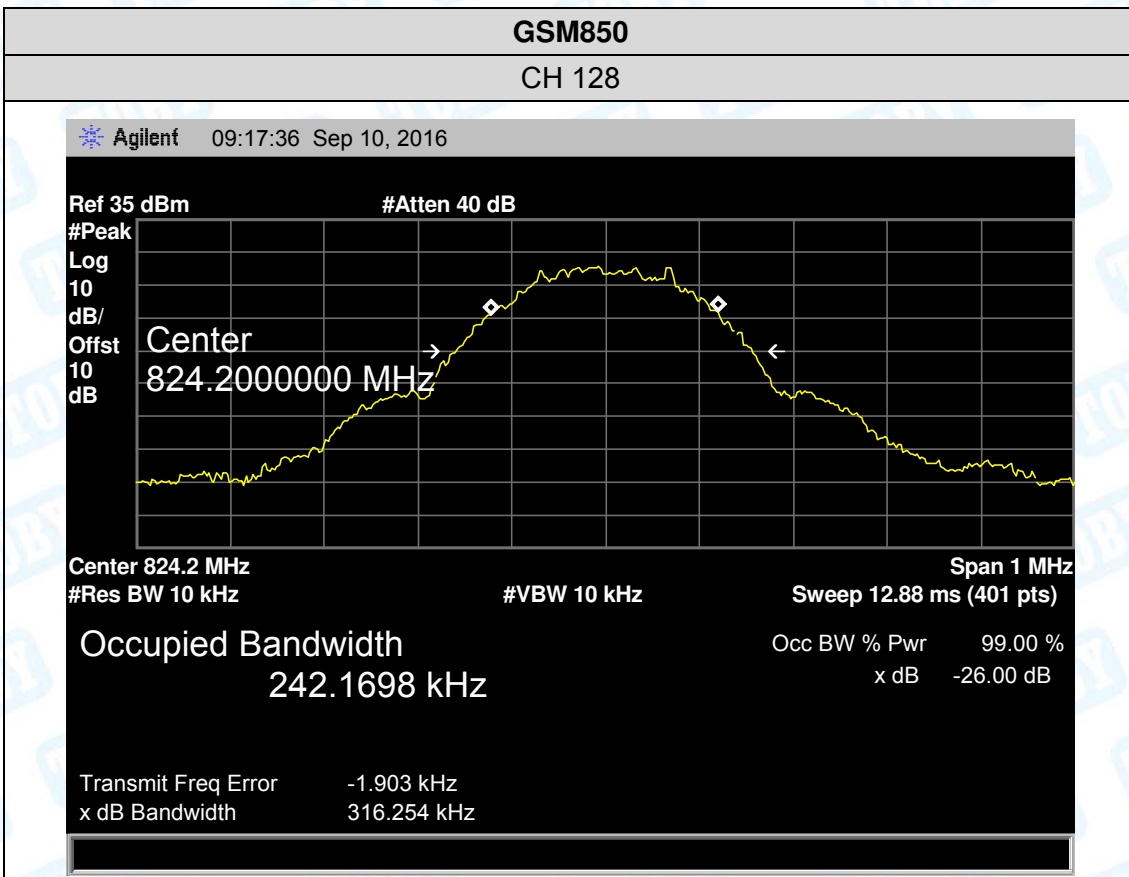

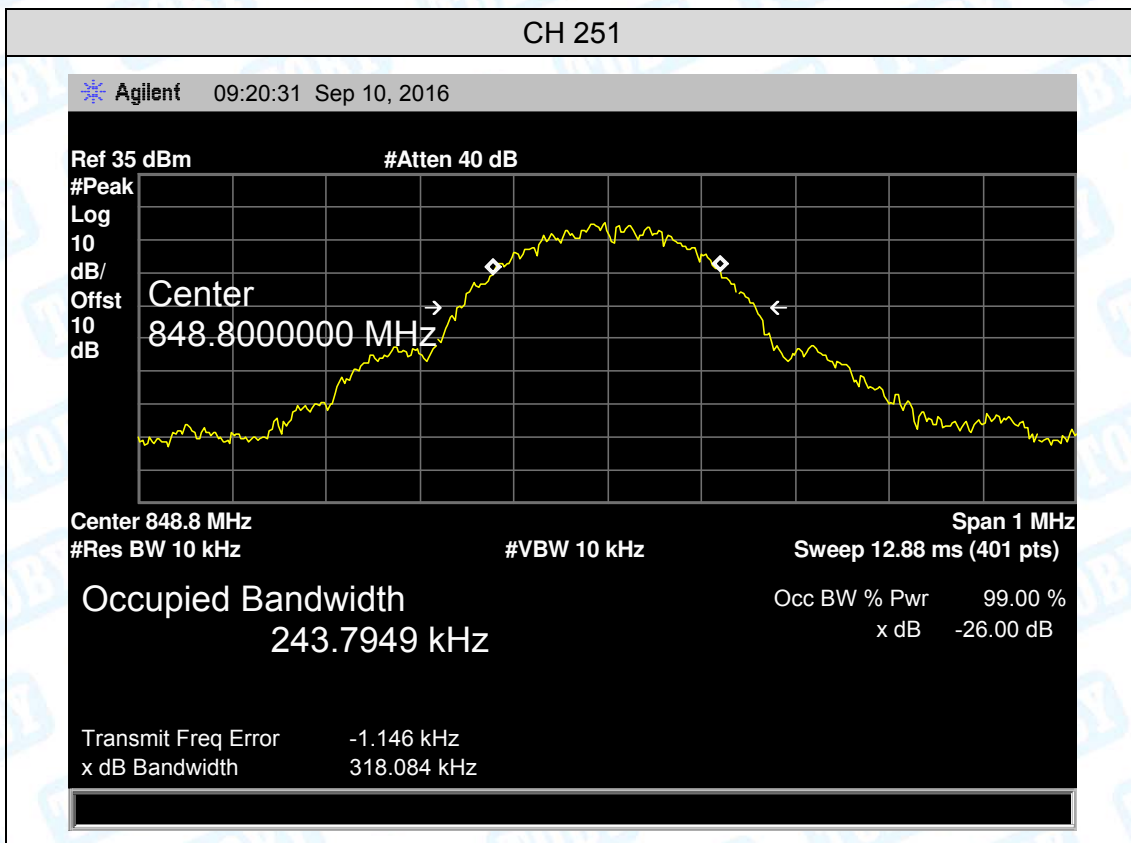

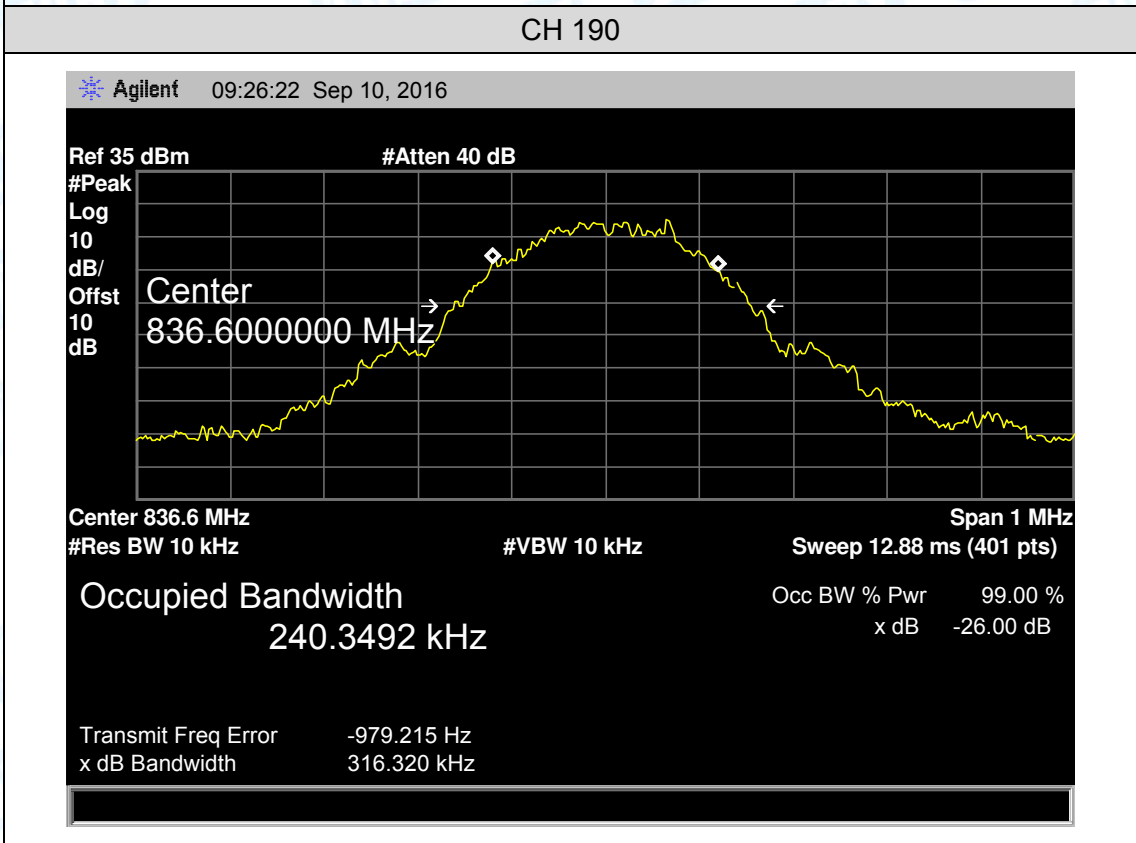
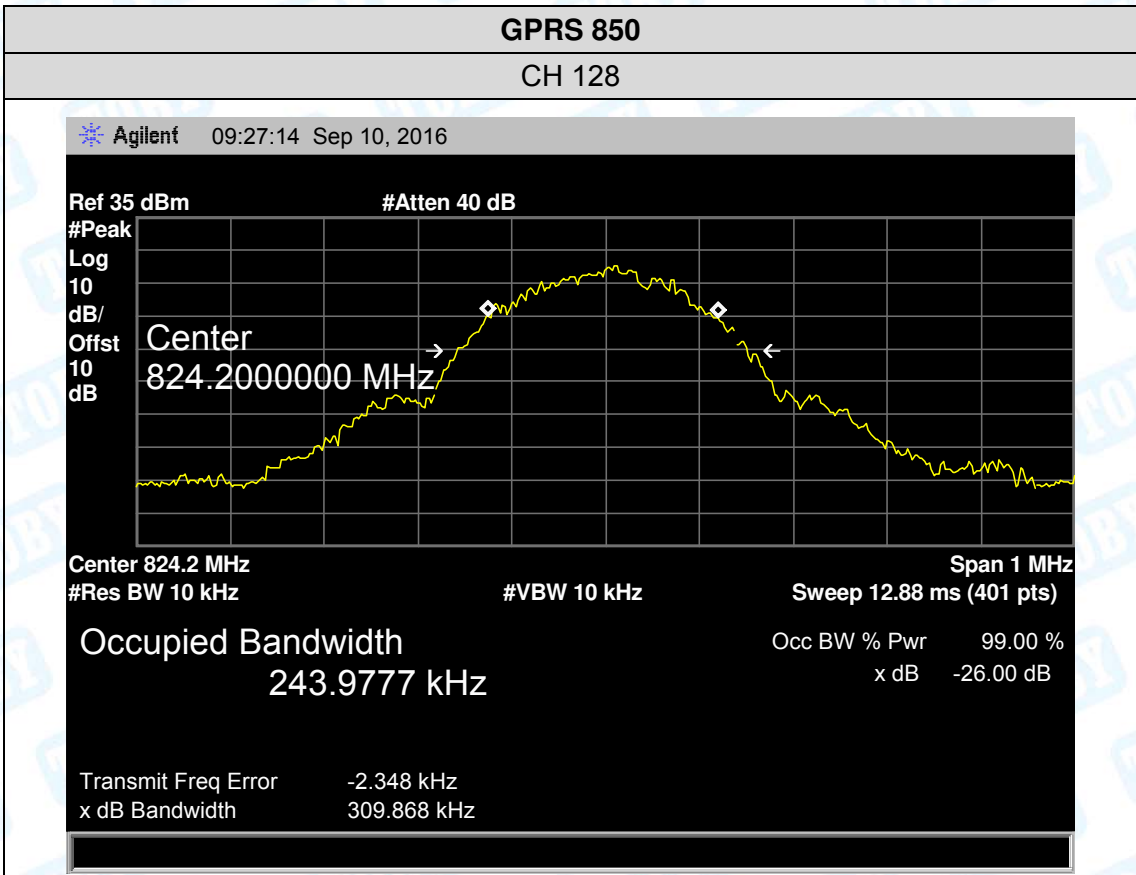

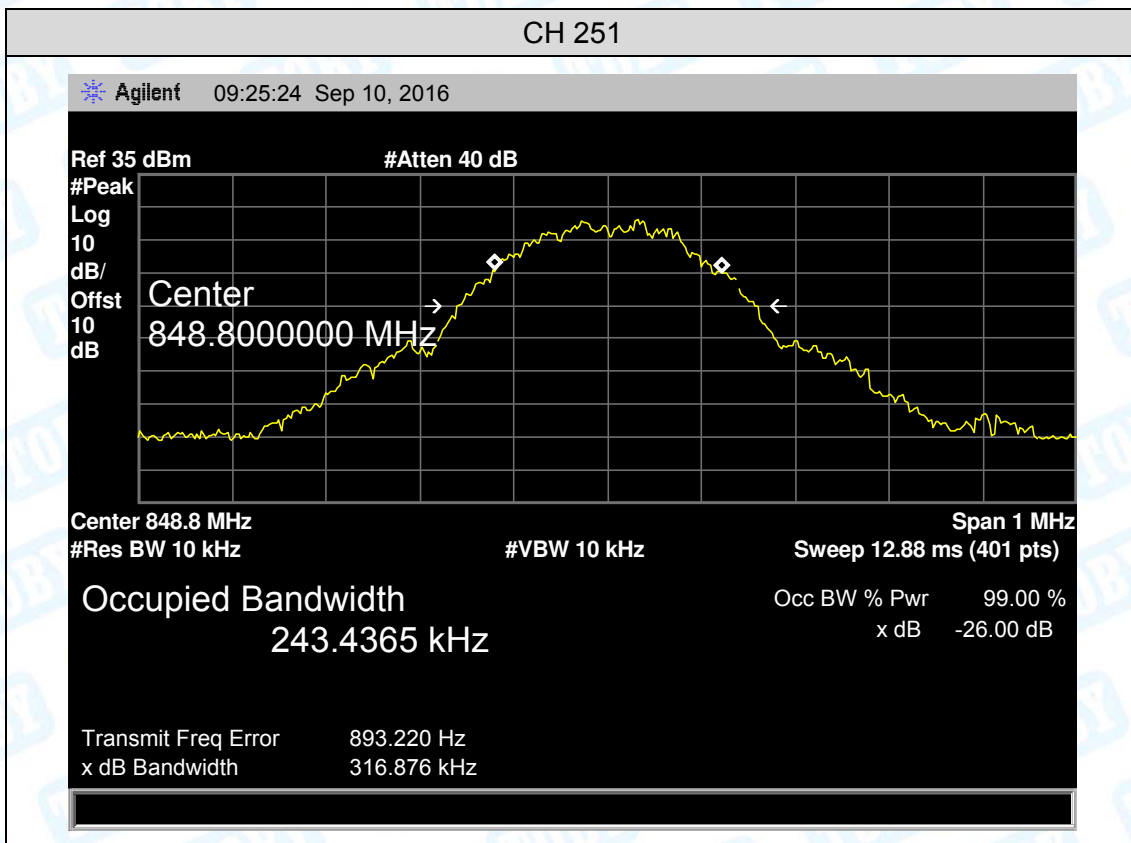

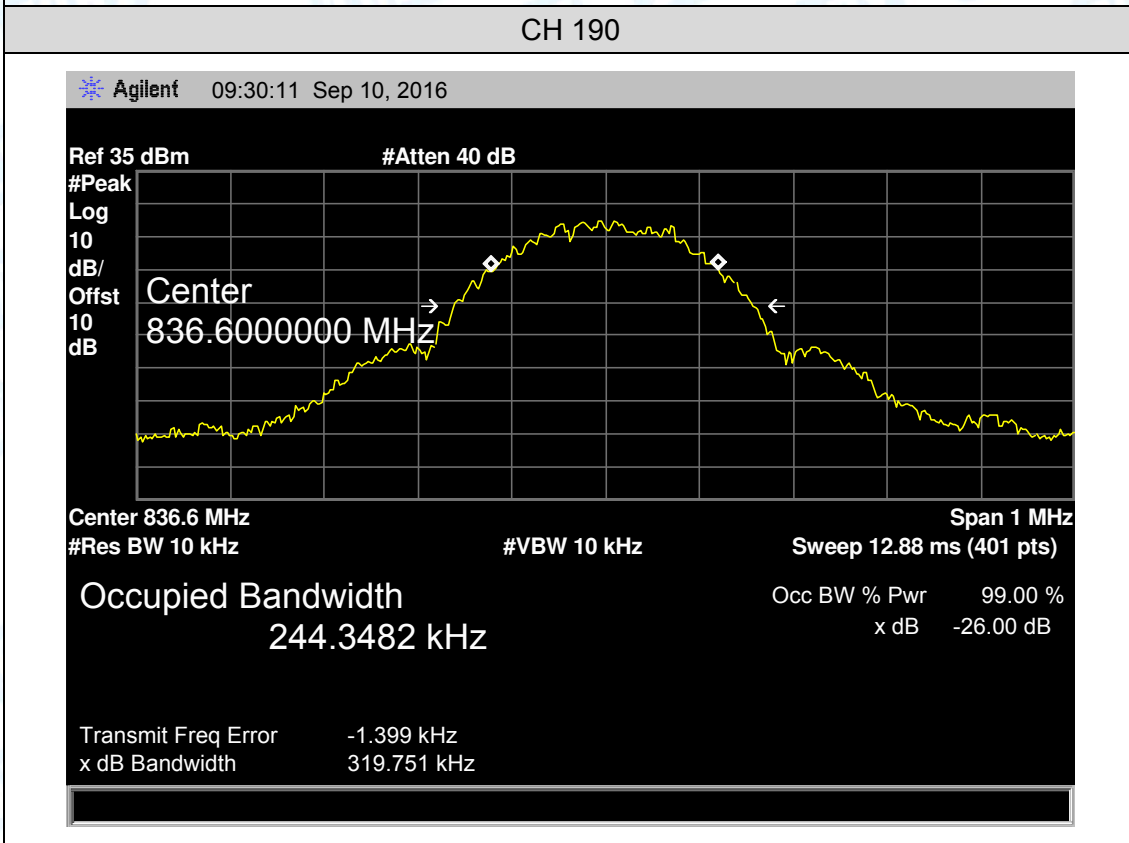
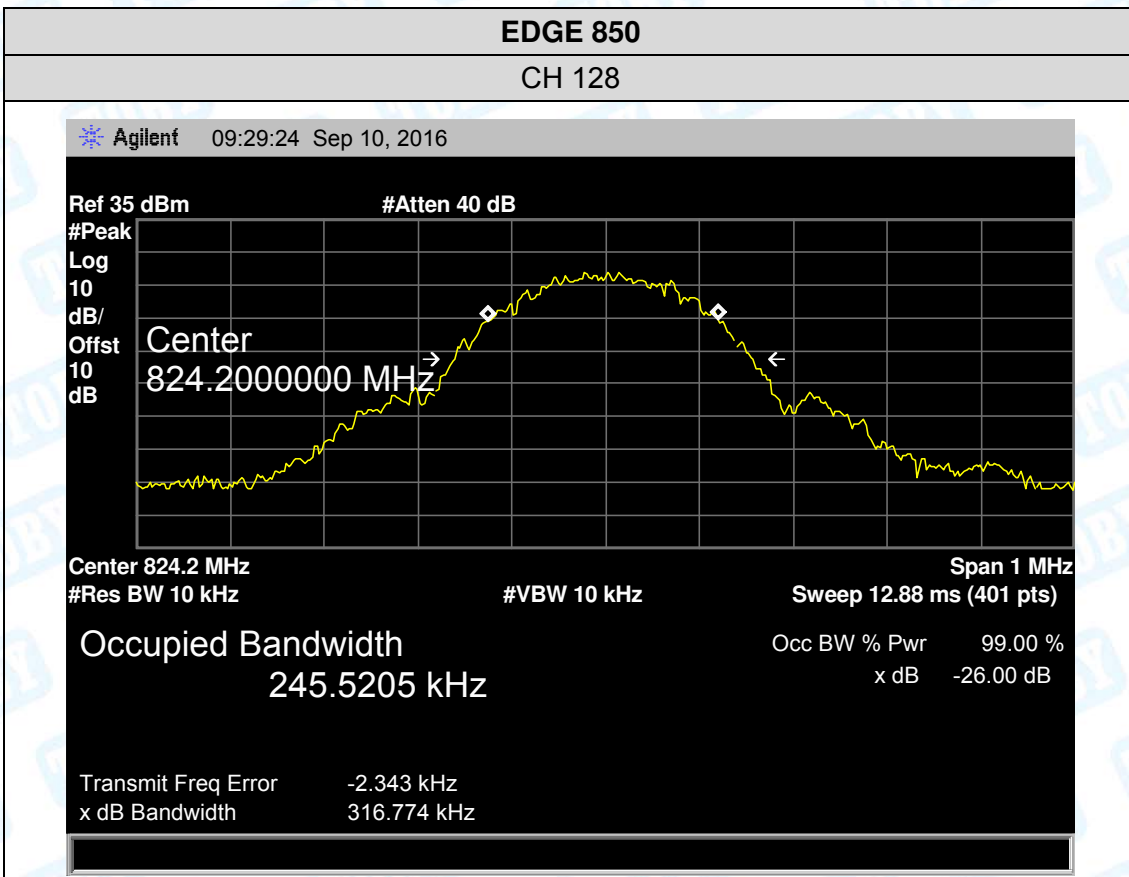

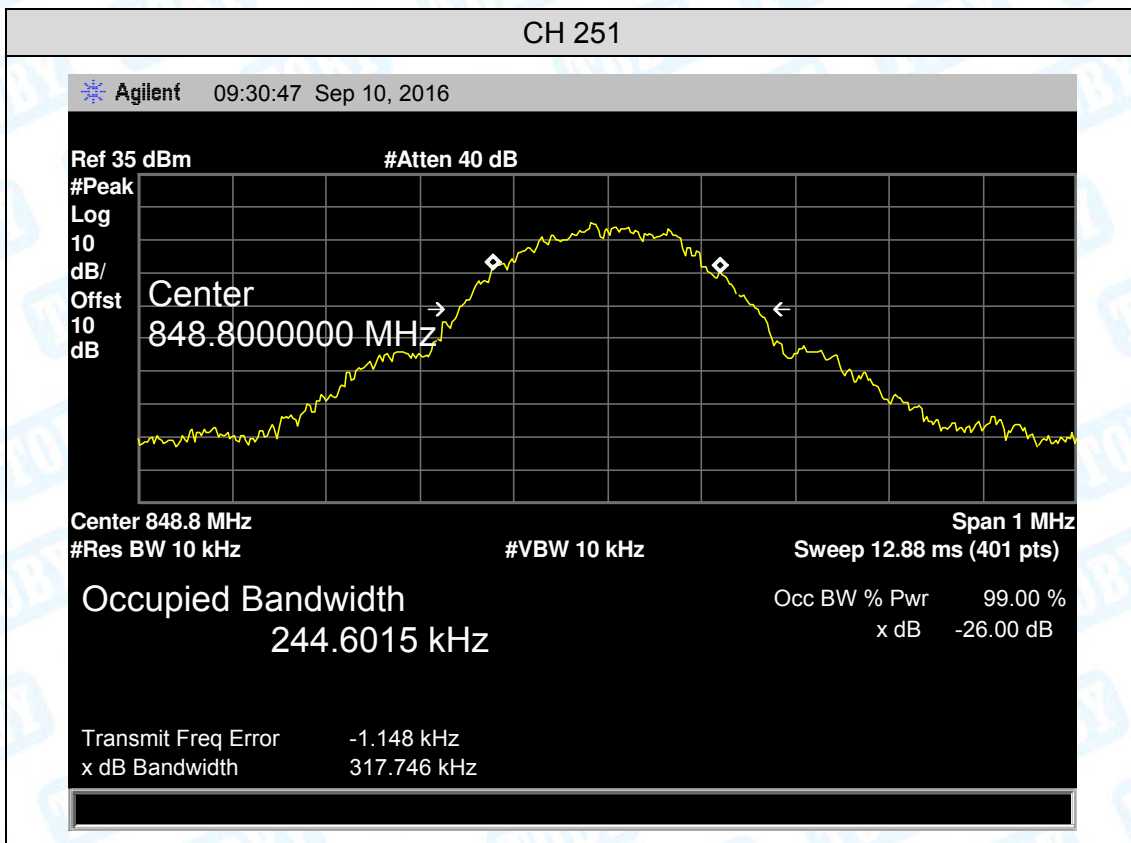

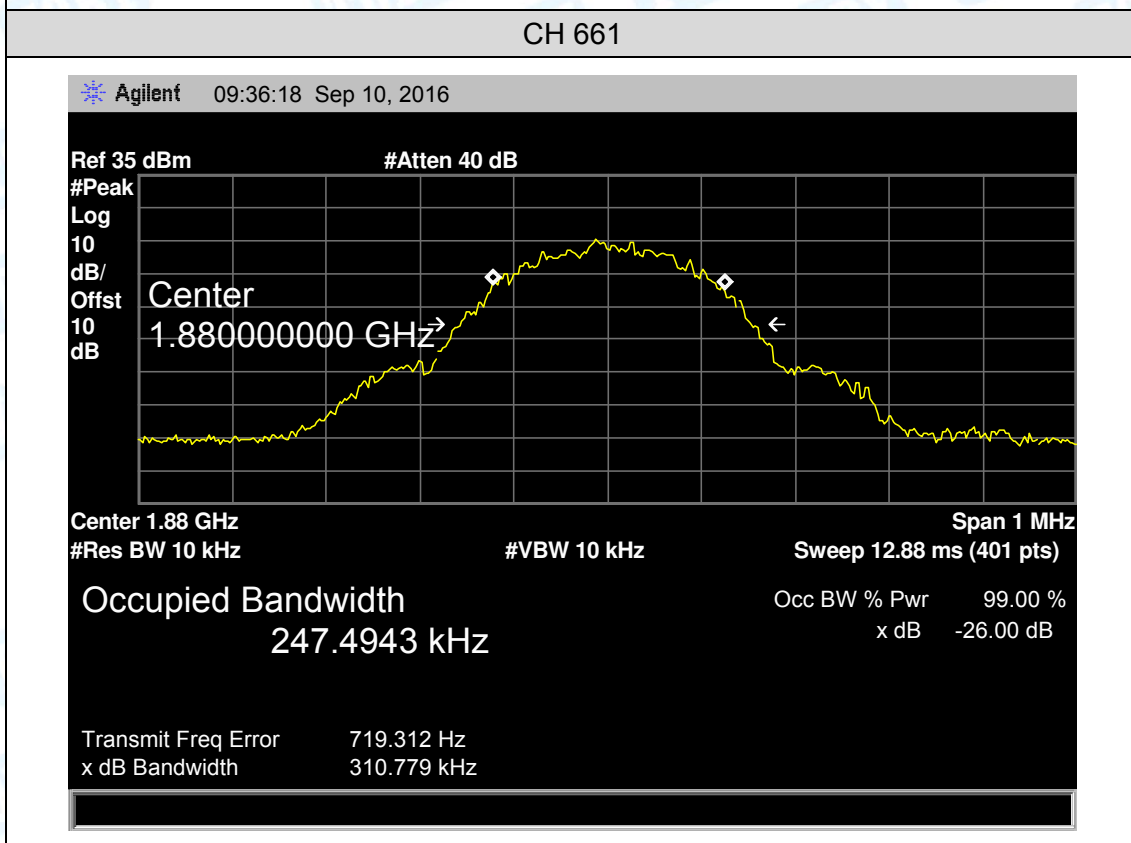
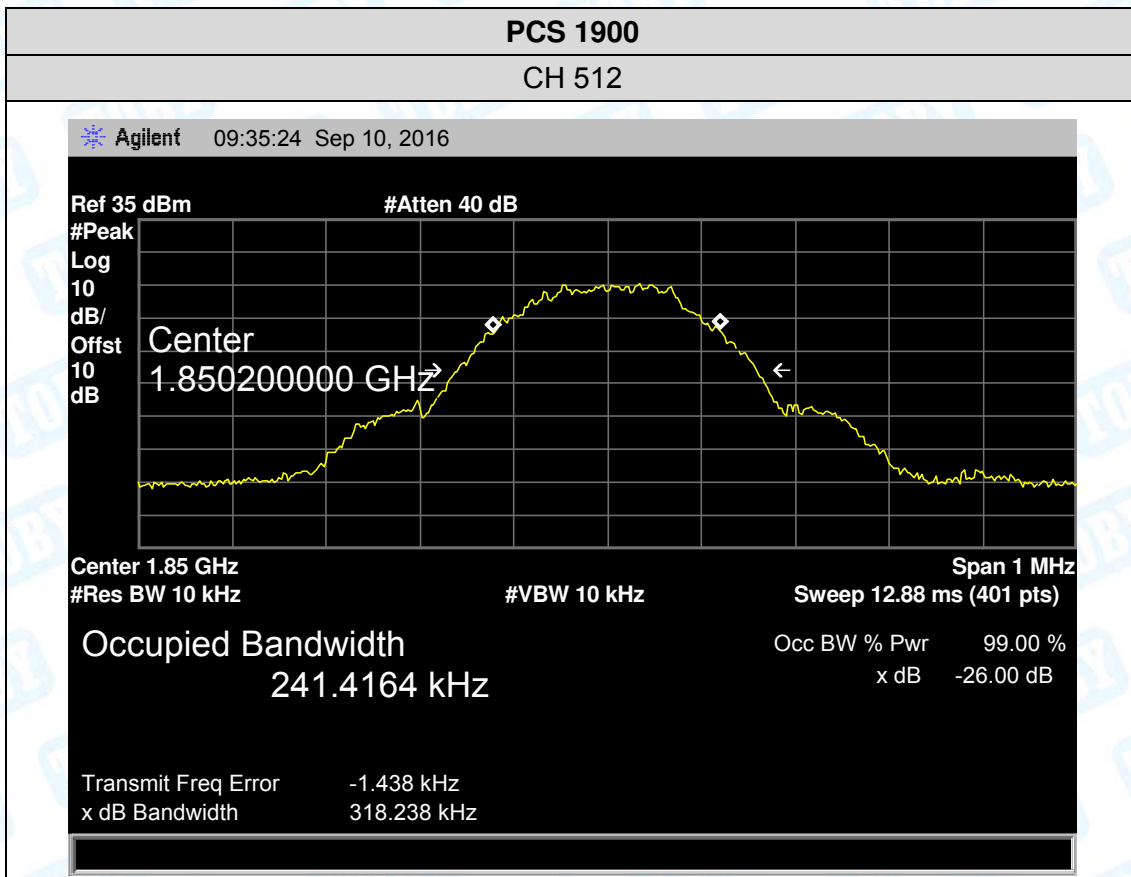

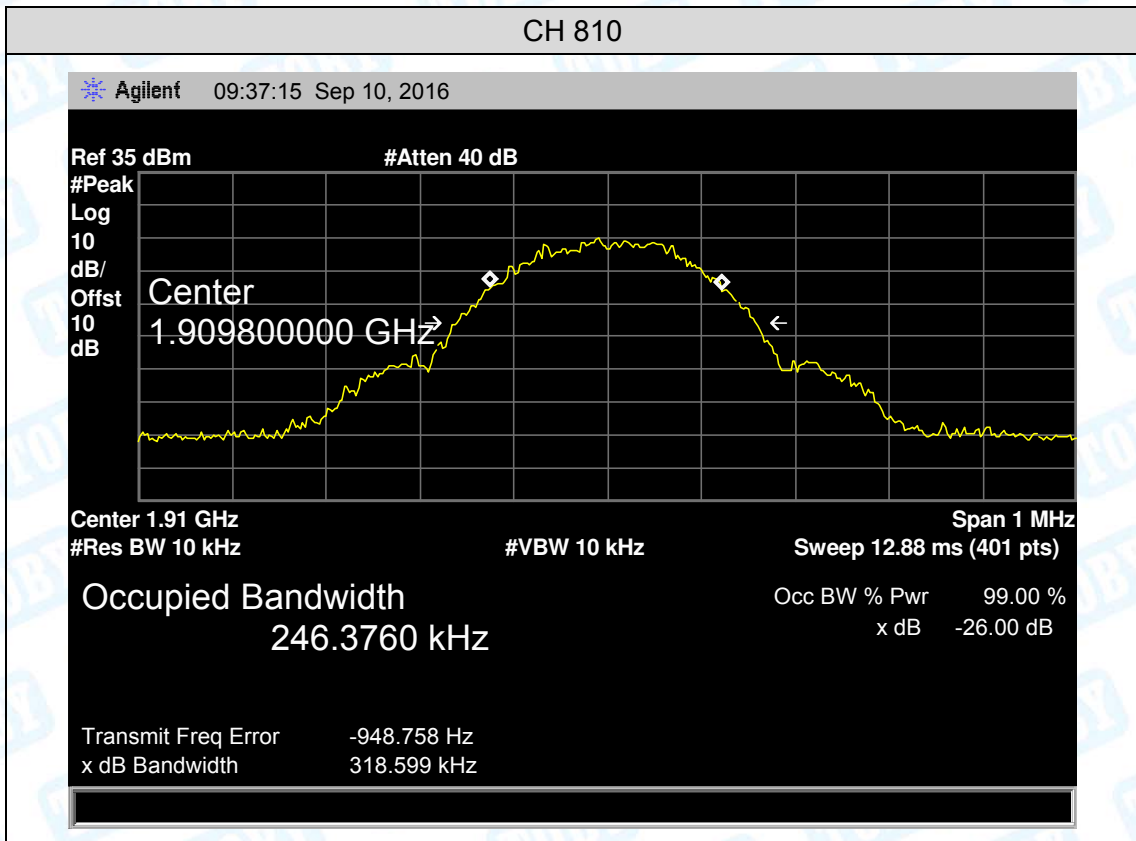

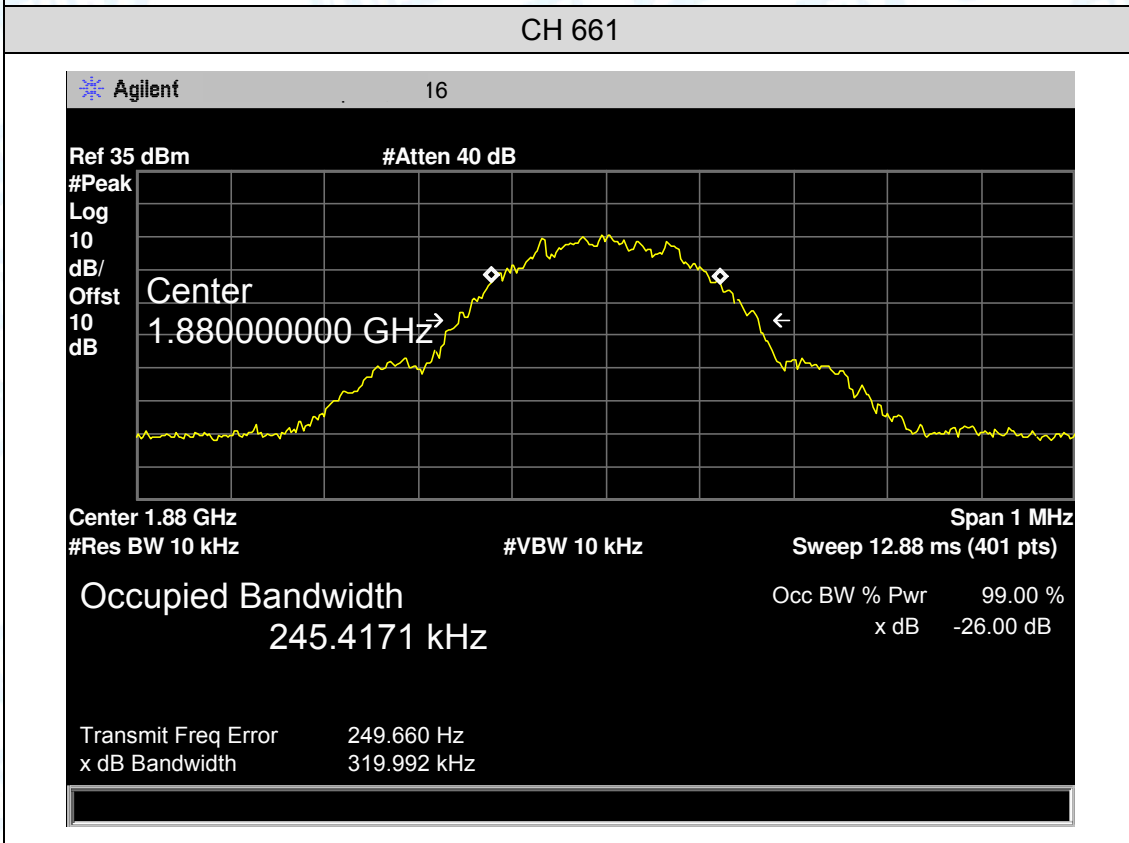
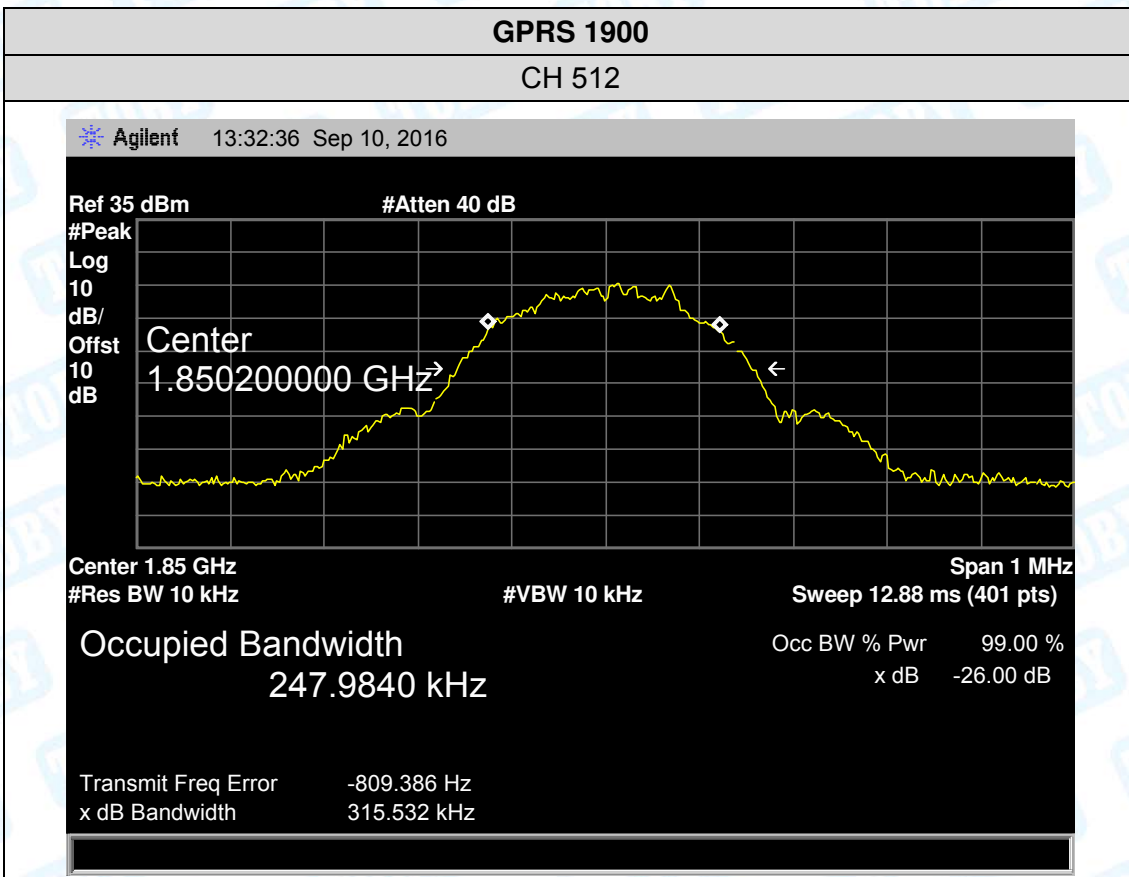

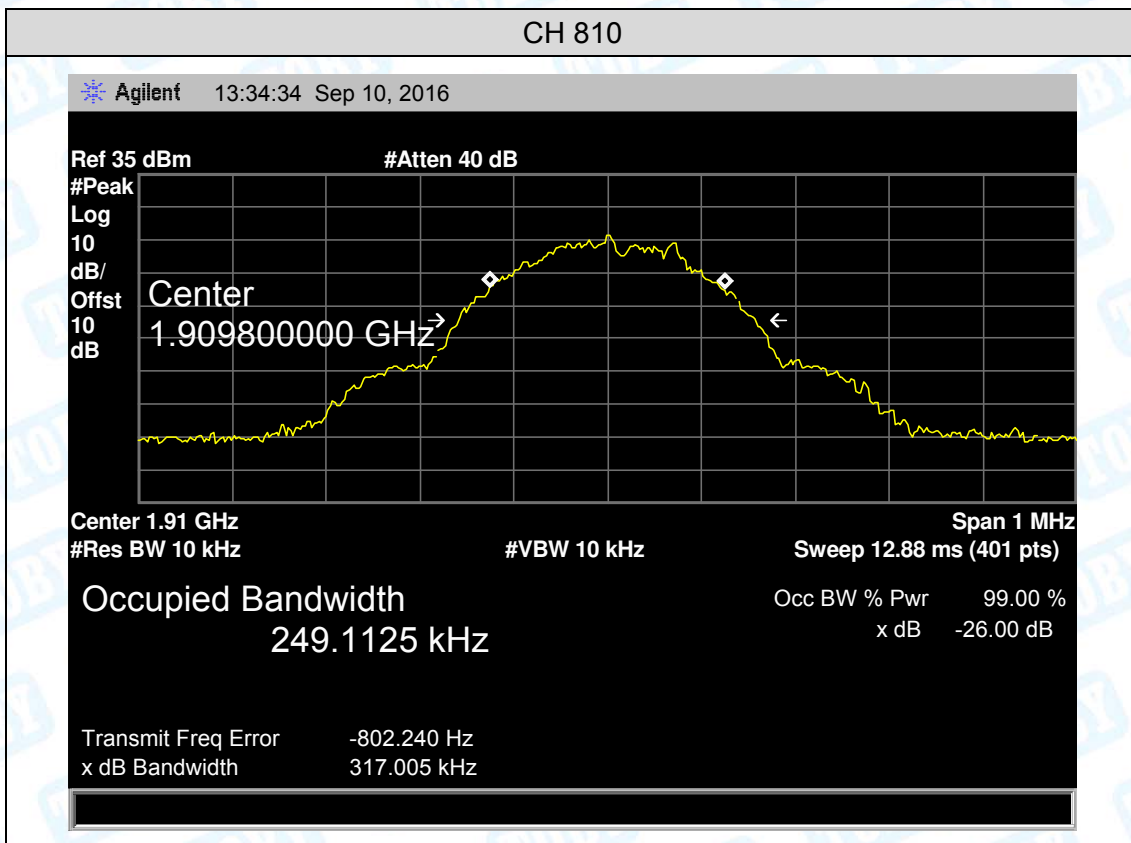

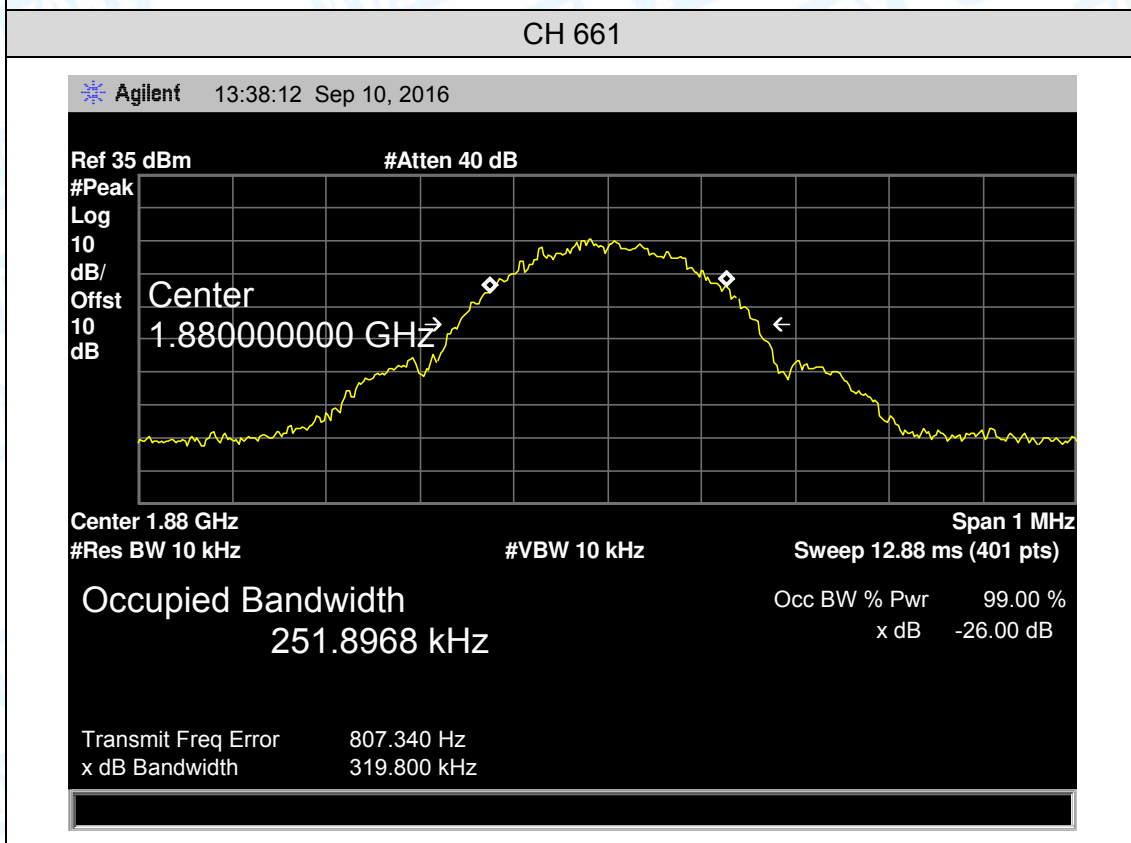
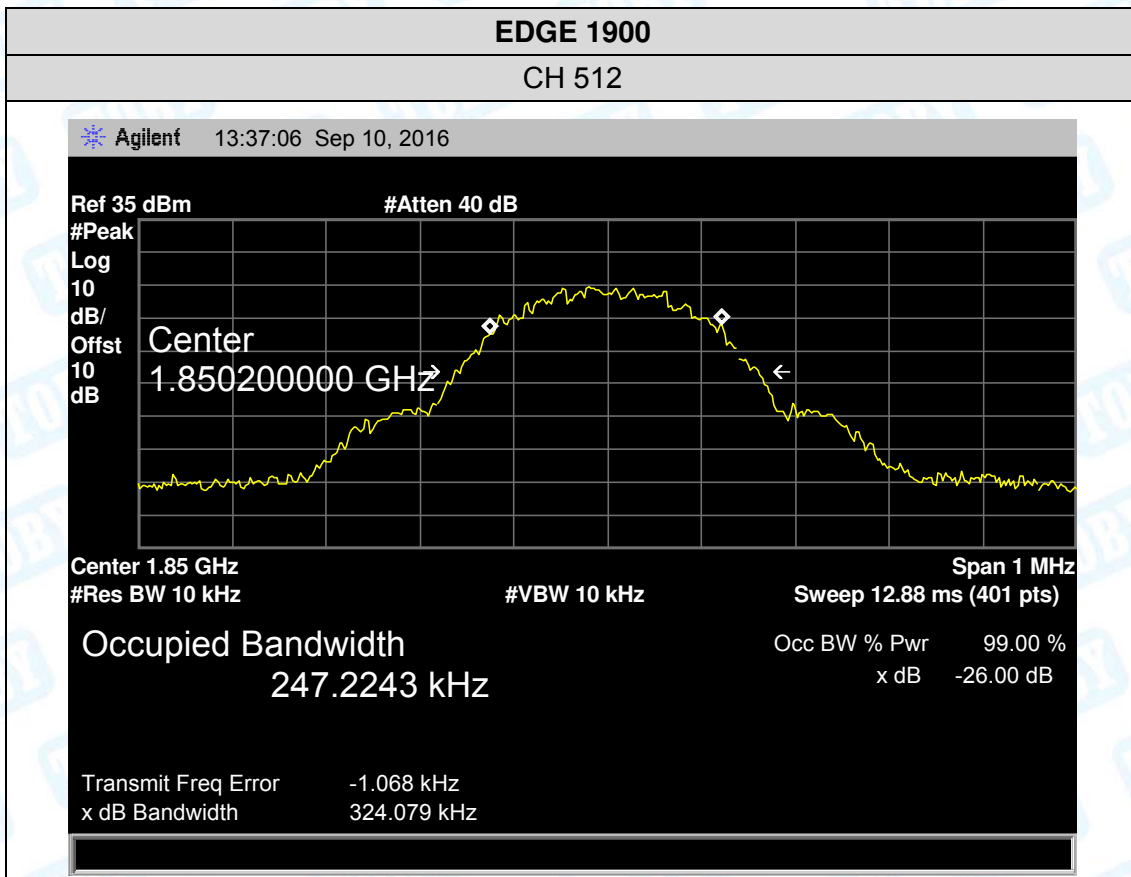

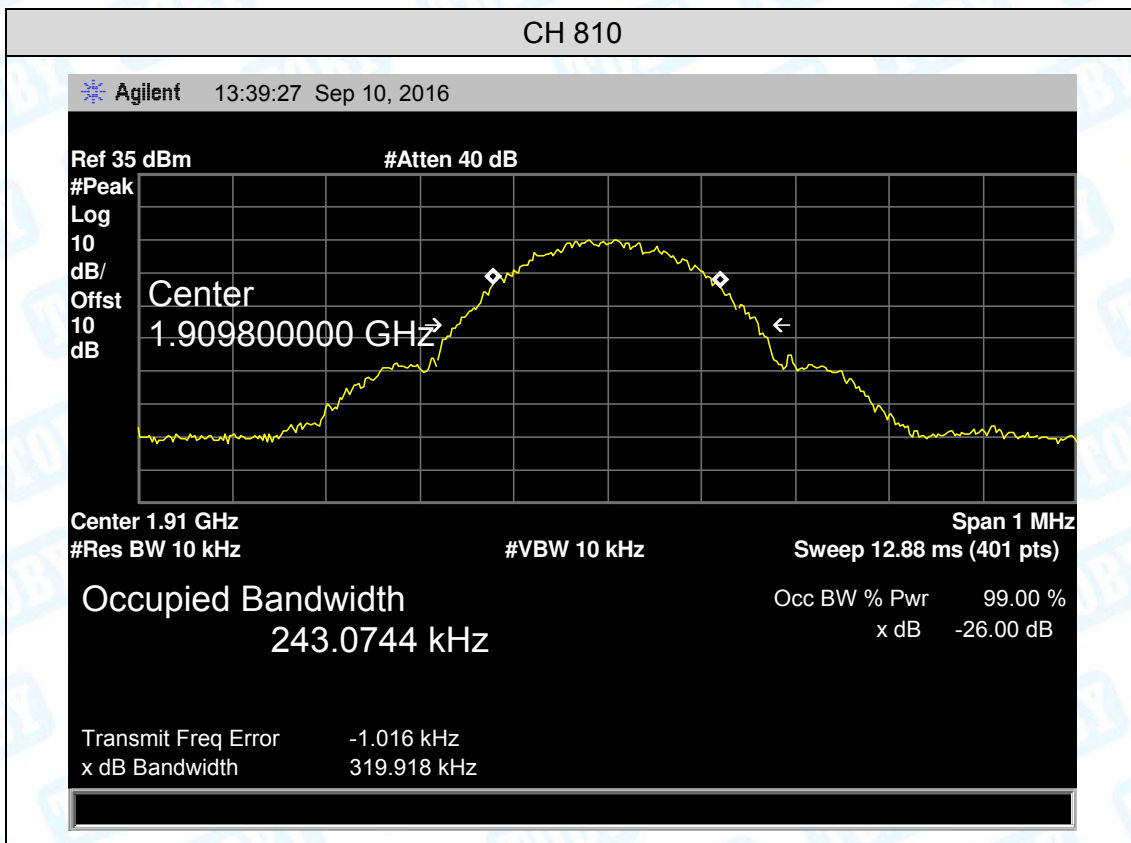

9. Conducted Out of Band Emissions

9.1 Test Standard and Limit

9.1.1 Test Standard

FCC Part 2: 2.1051, 2.1057

FCC Part 22H: 22.917(a)

FCC Part 24E: 24.238(a)

9.1.2 Test Limit

The power of any emission outside of the authorized operating frequency ranges must be attenuated below the transmitting power(P) by a factor of at least $43+10\log(P)$ dB. For all power levels +30 dBm to 0 dBm, this becomes a constant specification limit of -13 dBm.

9.2 Test Setup

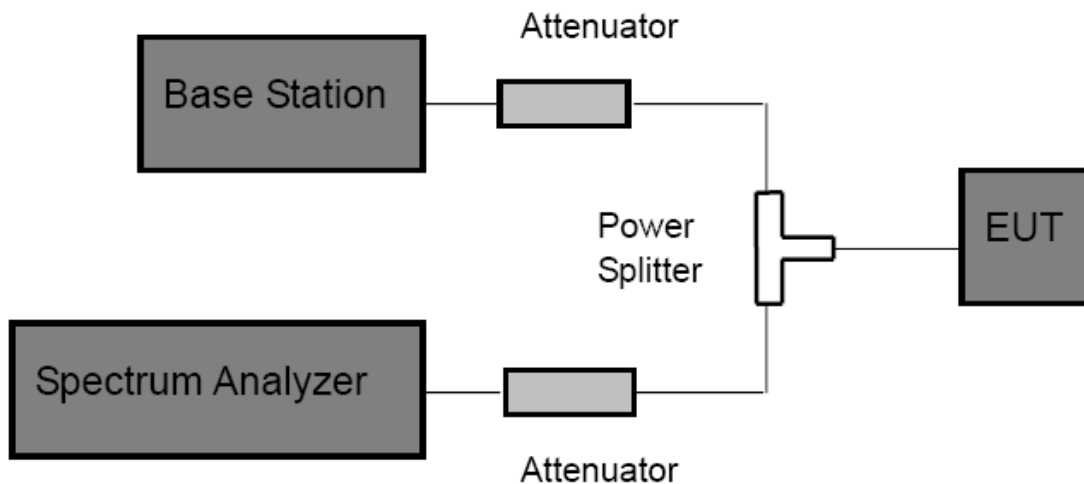

9.3 Test Procedure

- (1) The EUT was directly connected to the spectrum analyzer and Base station via power splitter as show in the block diagram above.
- (2) Spectrum Setting:
 Frequency bellow 1 GHz: RBW=100 kHz, VBW=300 kHz.
 Frequency above 1 GHz: RBW=1 MHz, VBW=3 MHz.
- (3) The low, middle and high channels of each band and mode's spurious emissions for 30 MHz to 10th Harmonic were measured by Spectrum analyzer.

9.4 EUT Operating Condition

The EUT was continuously connected with the Base station and transmitting in the max power during the test.

9.5 Test Data

Please refer following plots:

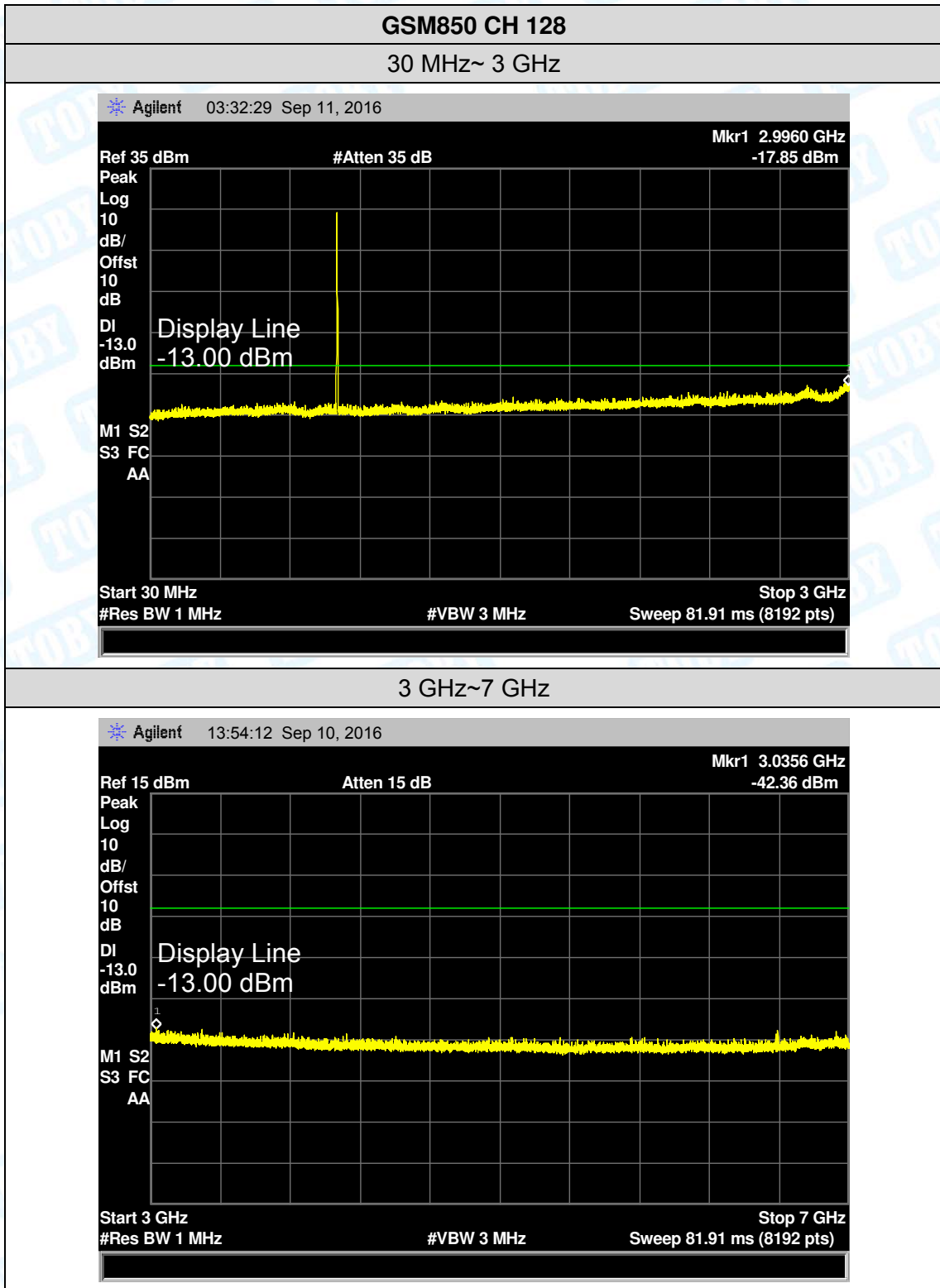

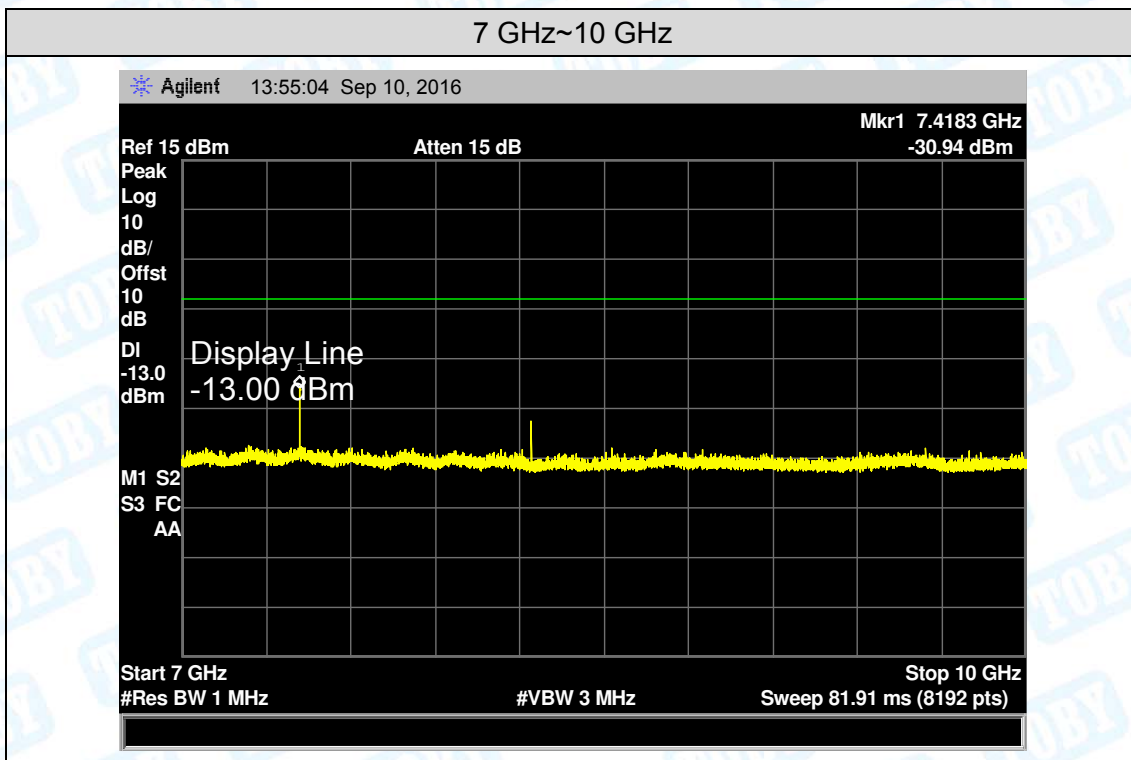

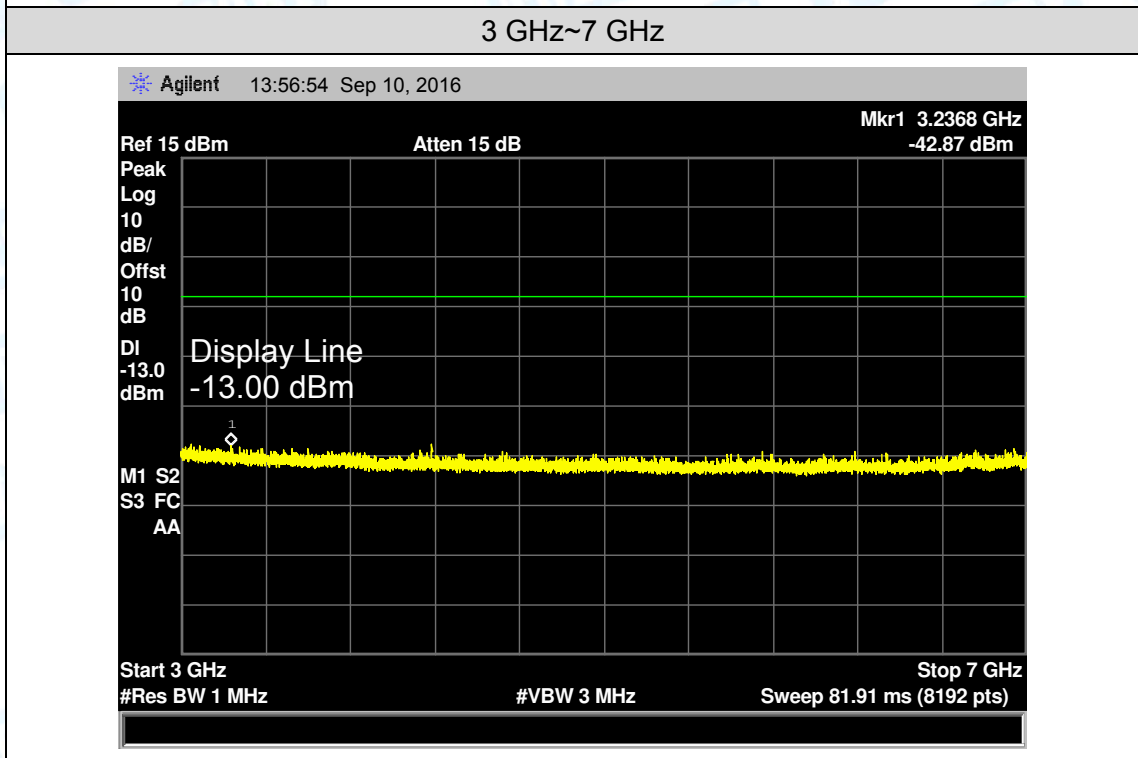
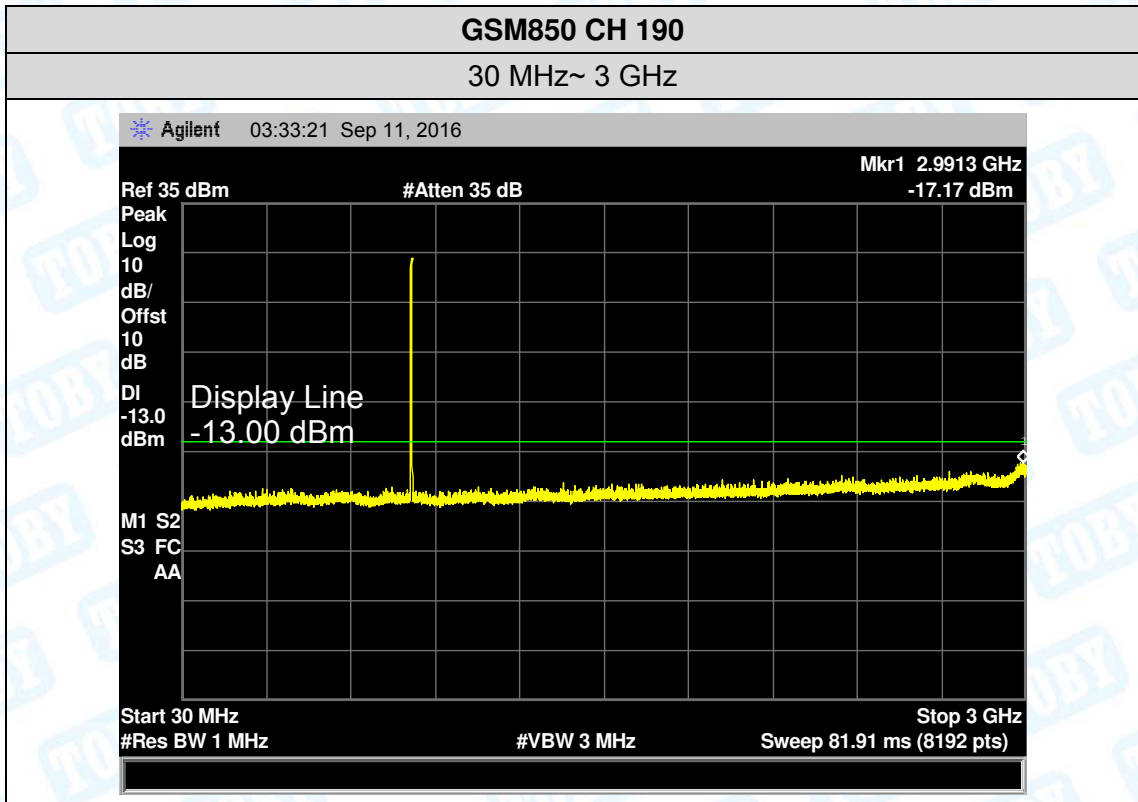

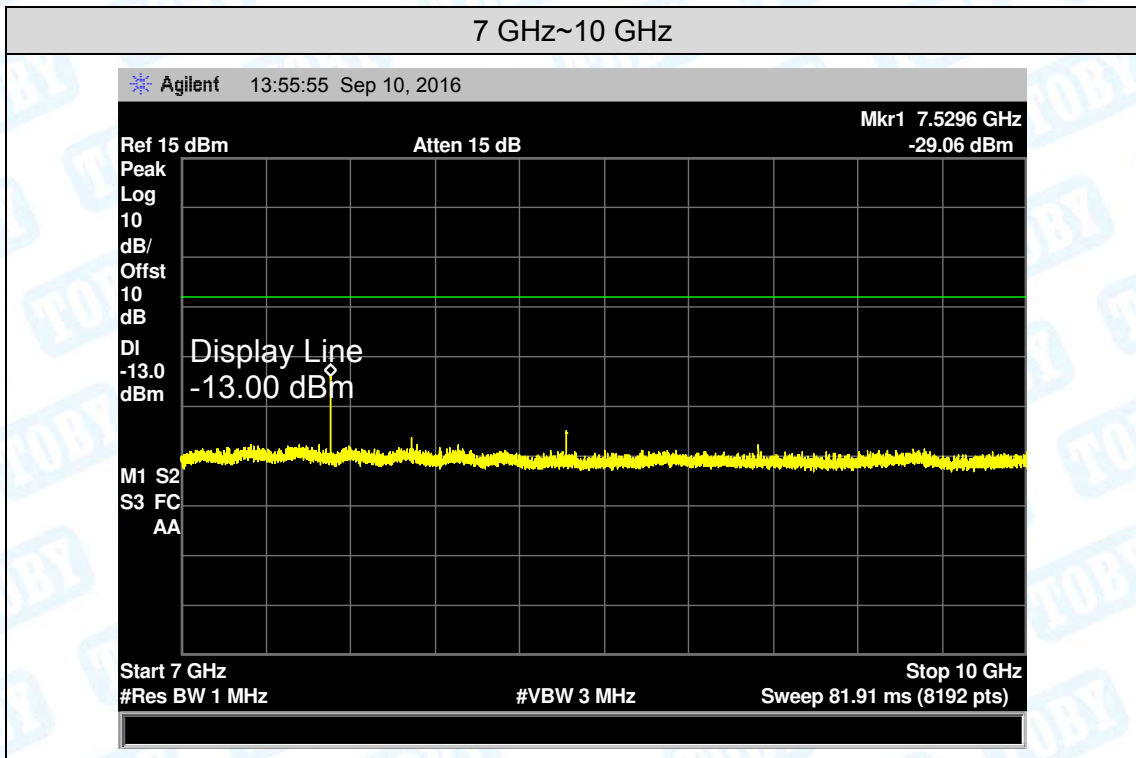

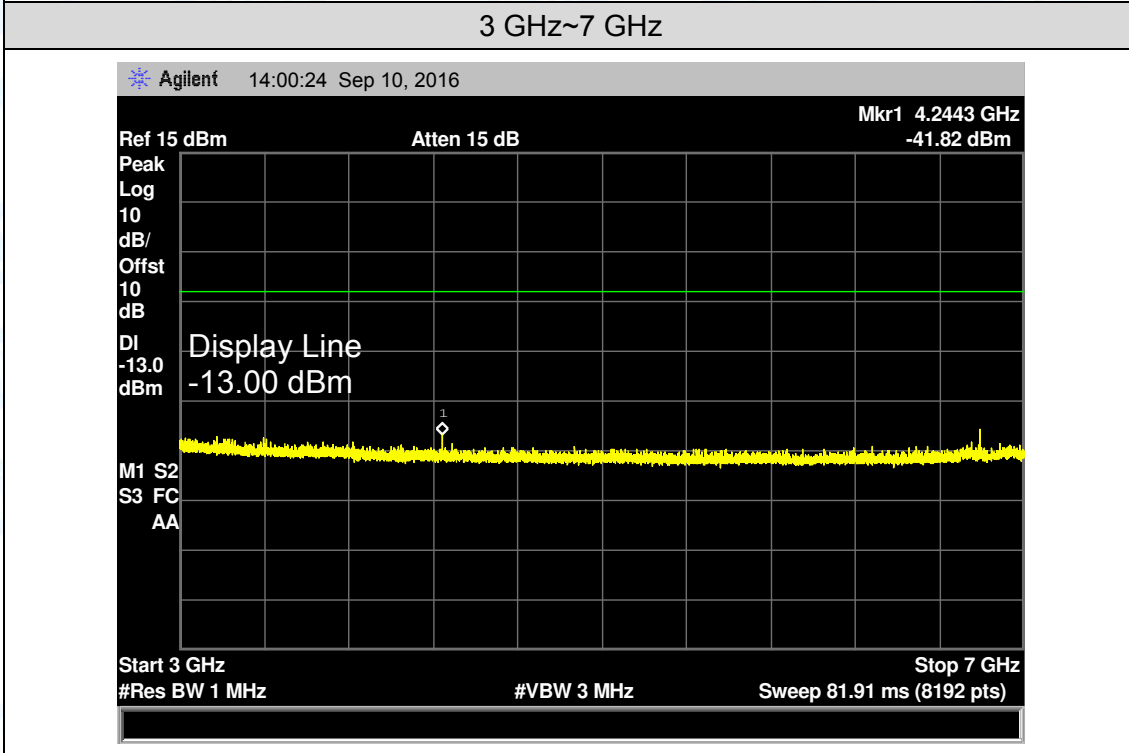
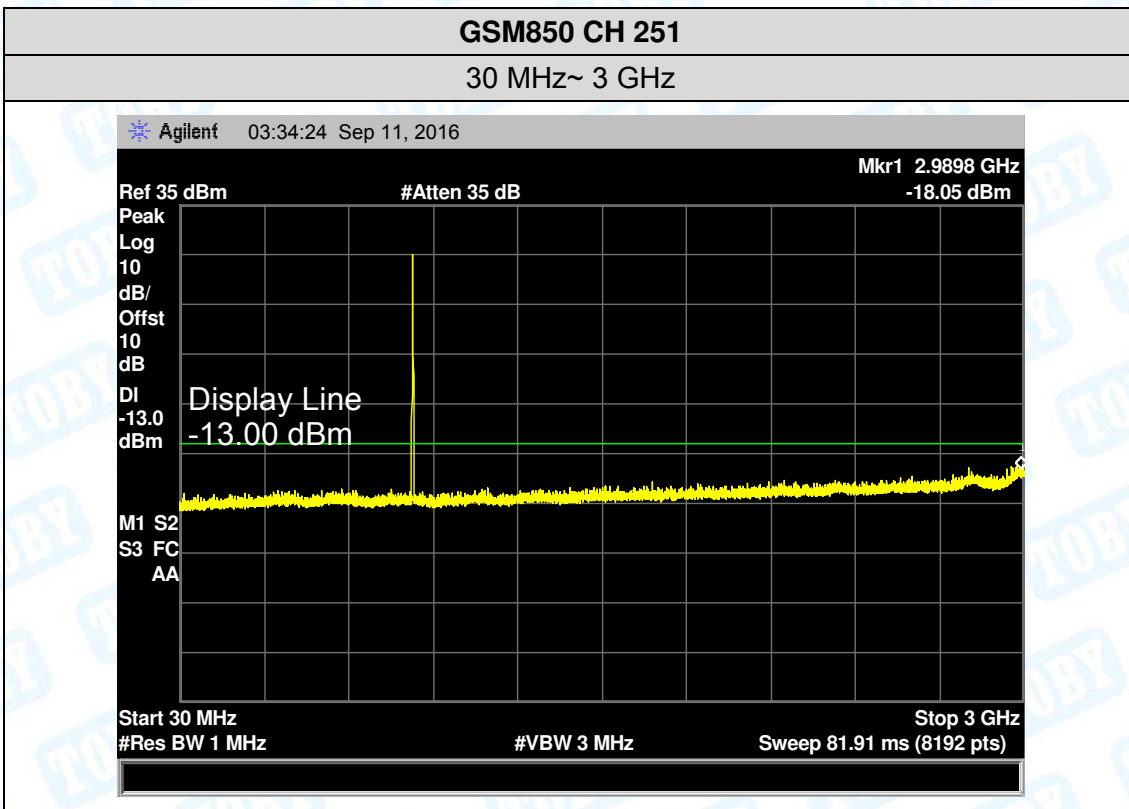

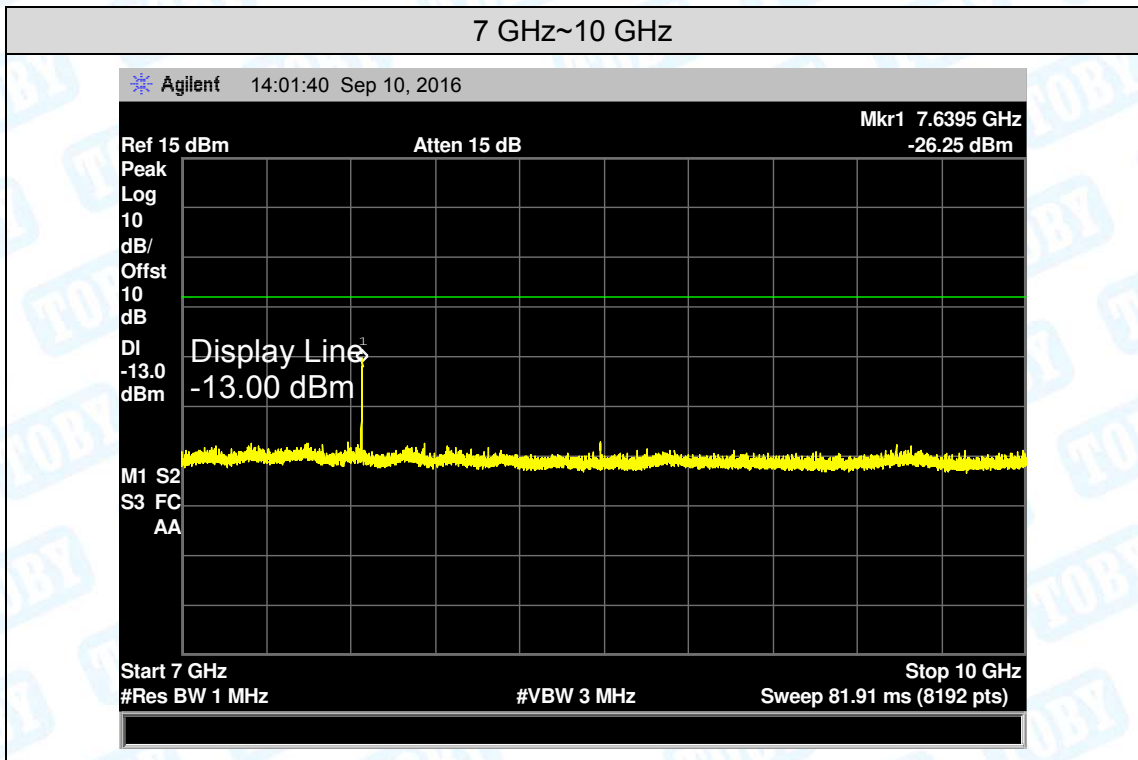

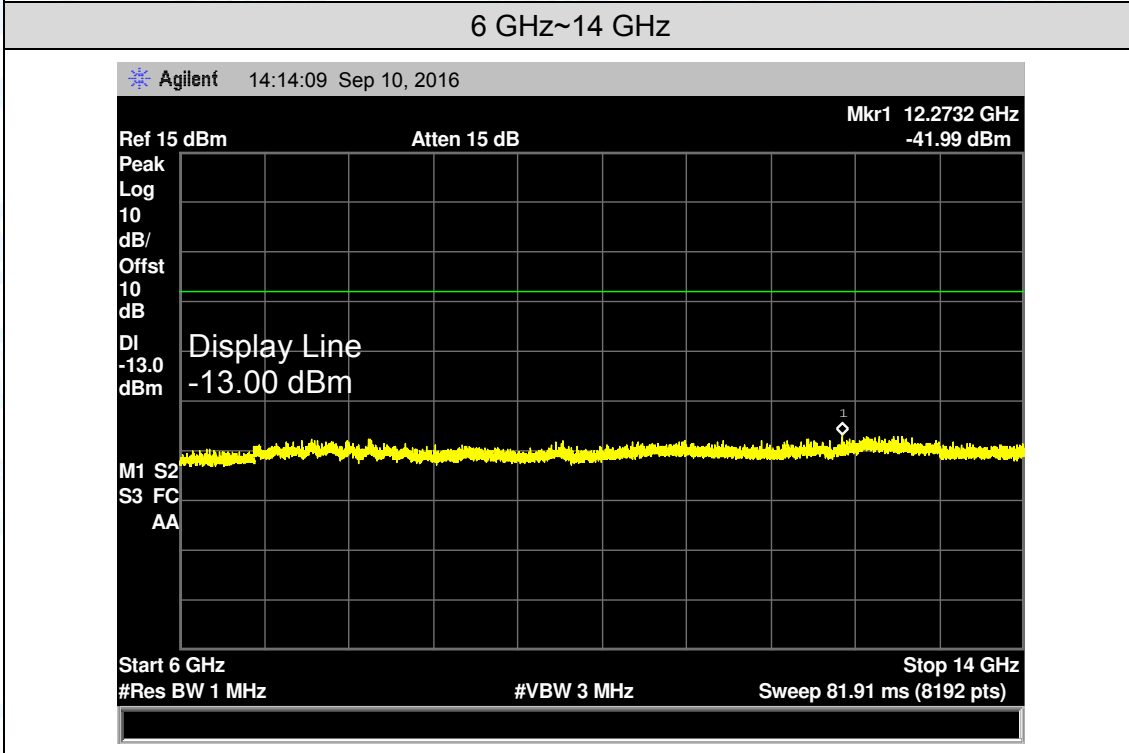
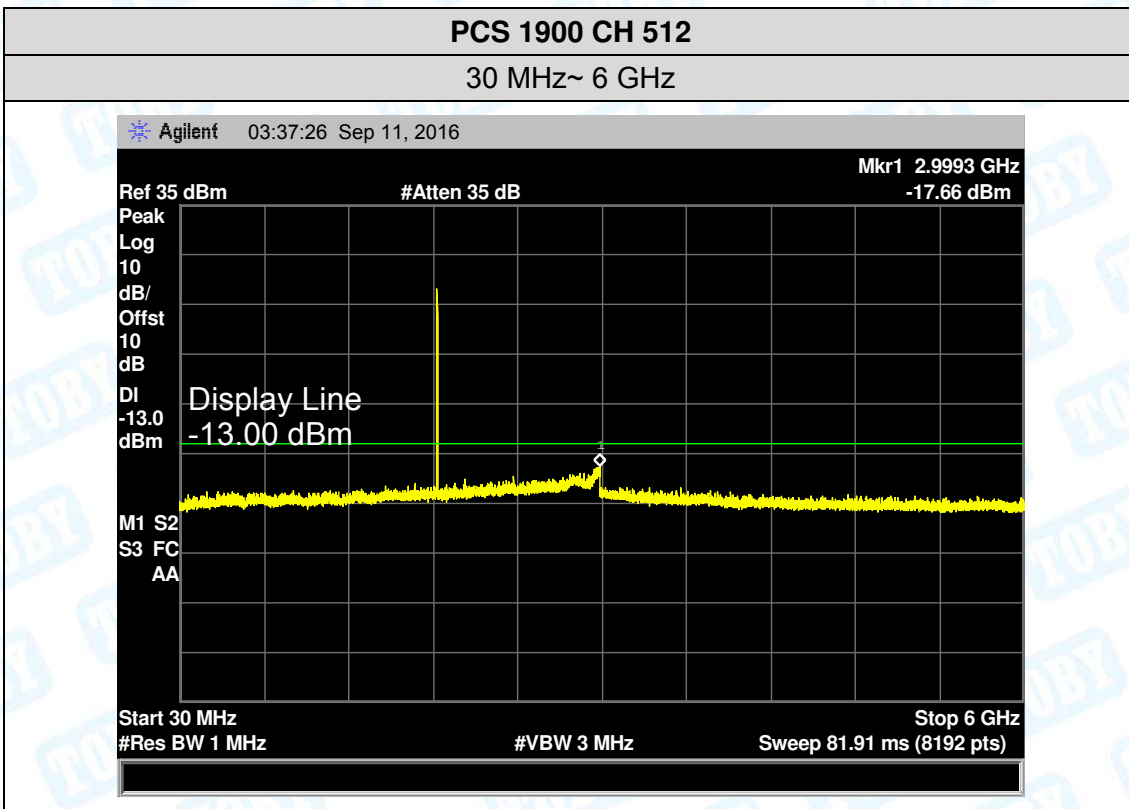

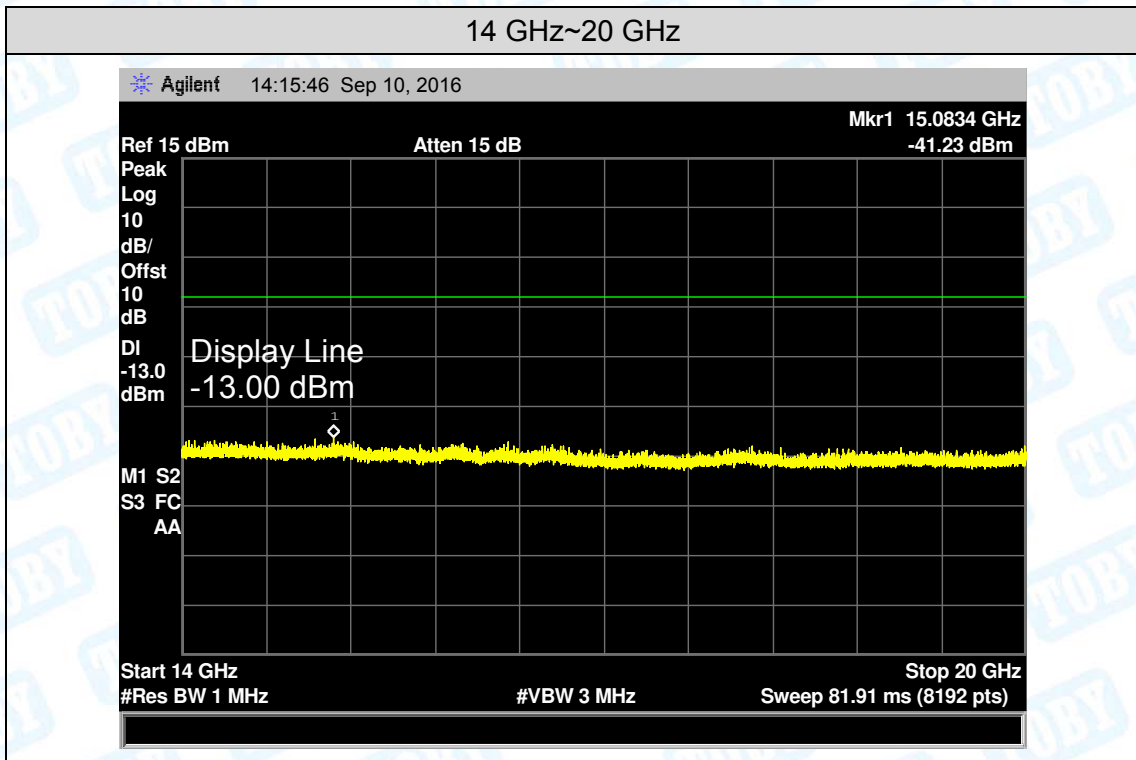

PCS 1900 CH 661
30 MHz~ 6 GHz

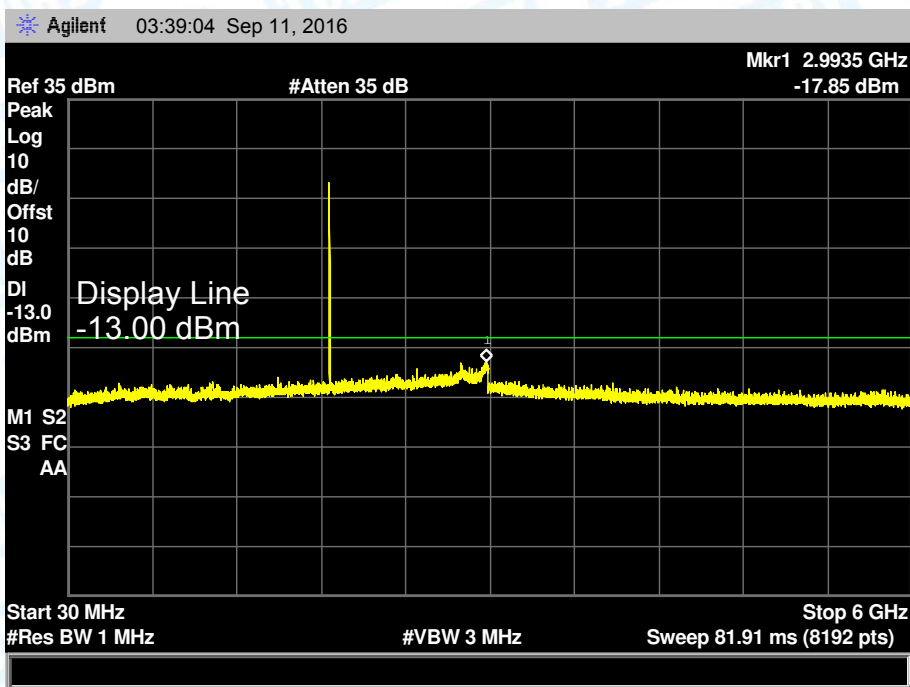

6 GHz~14 GHz

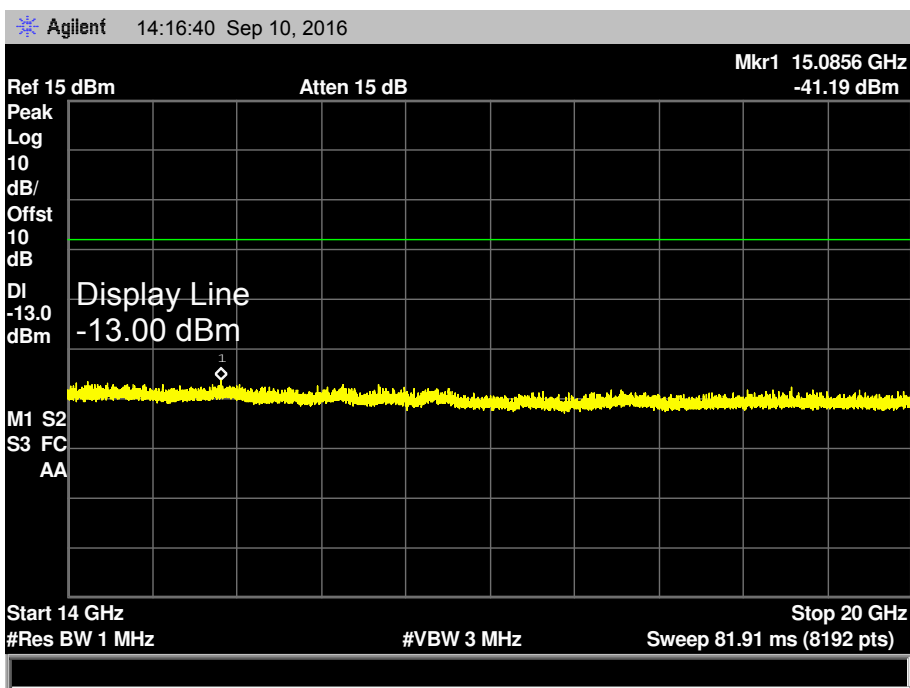

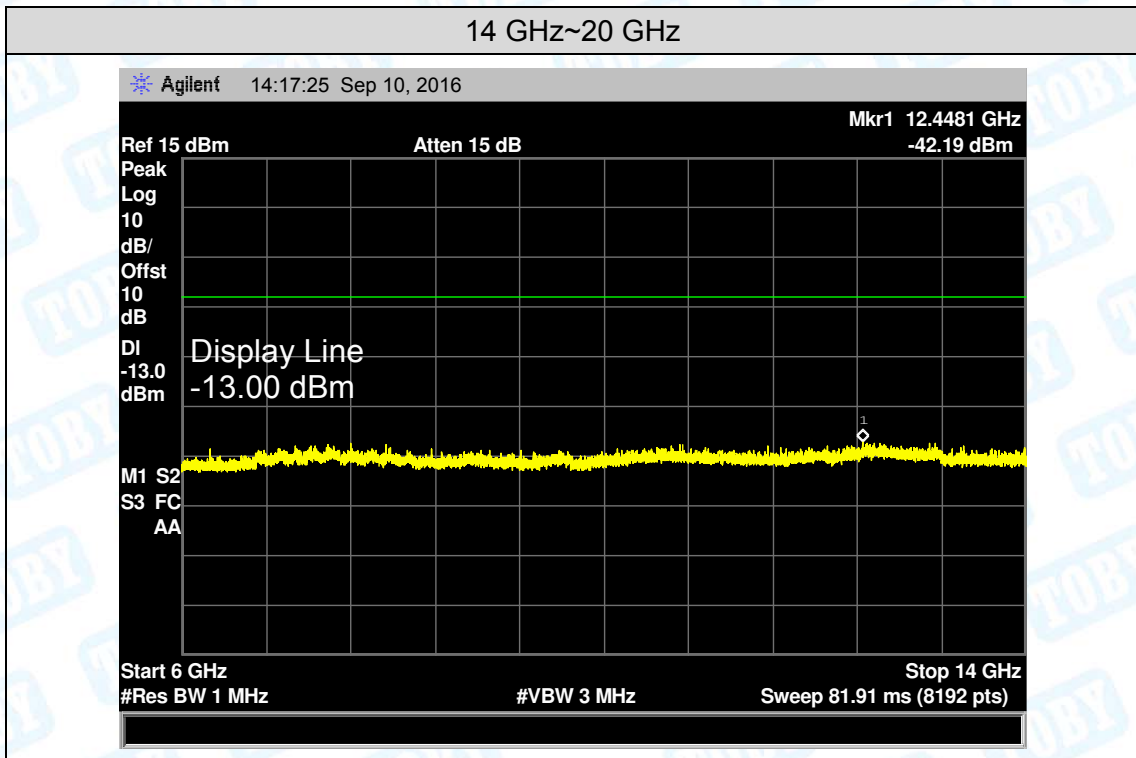

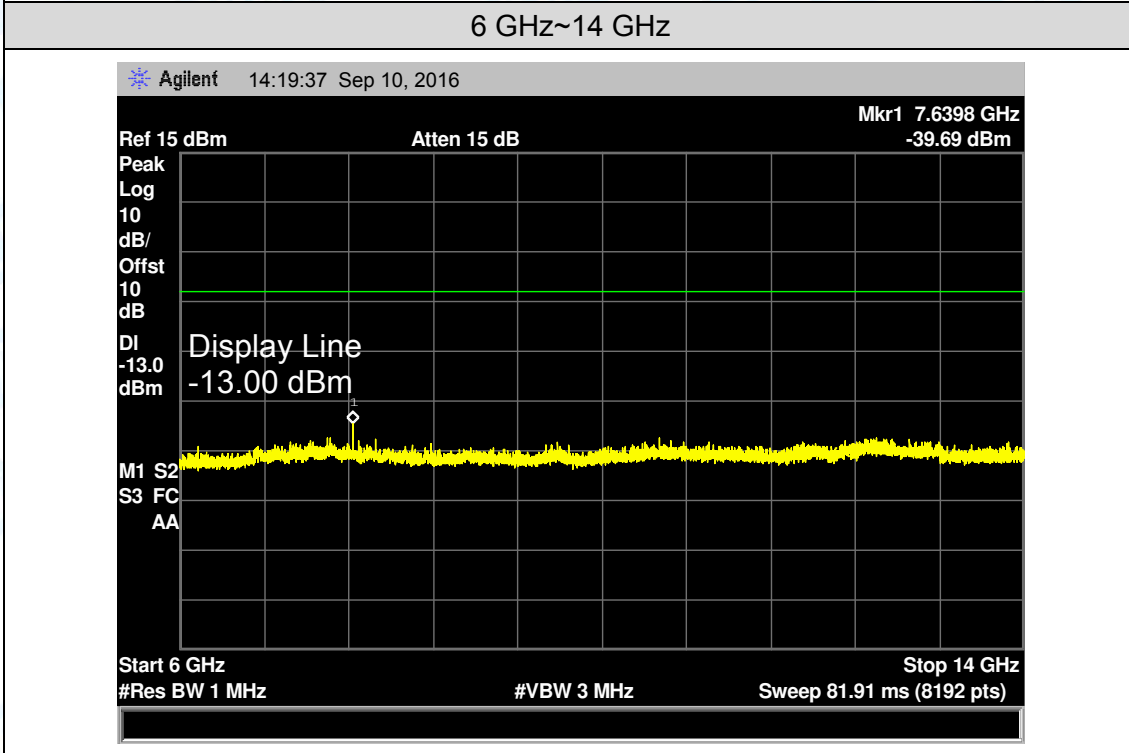
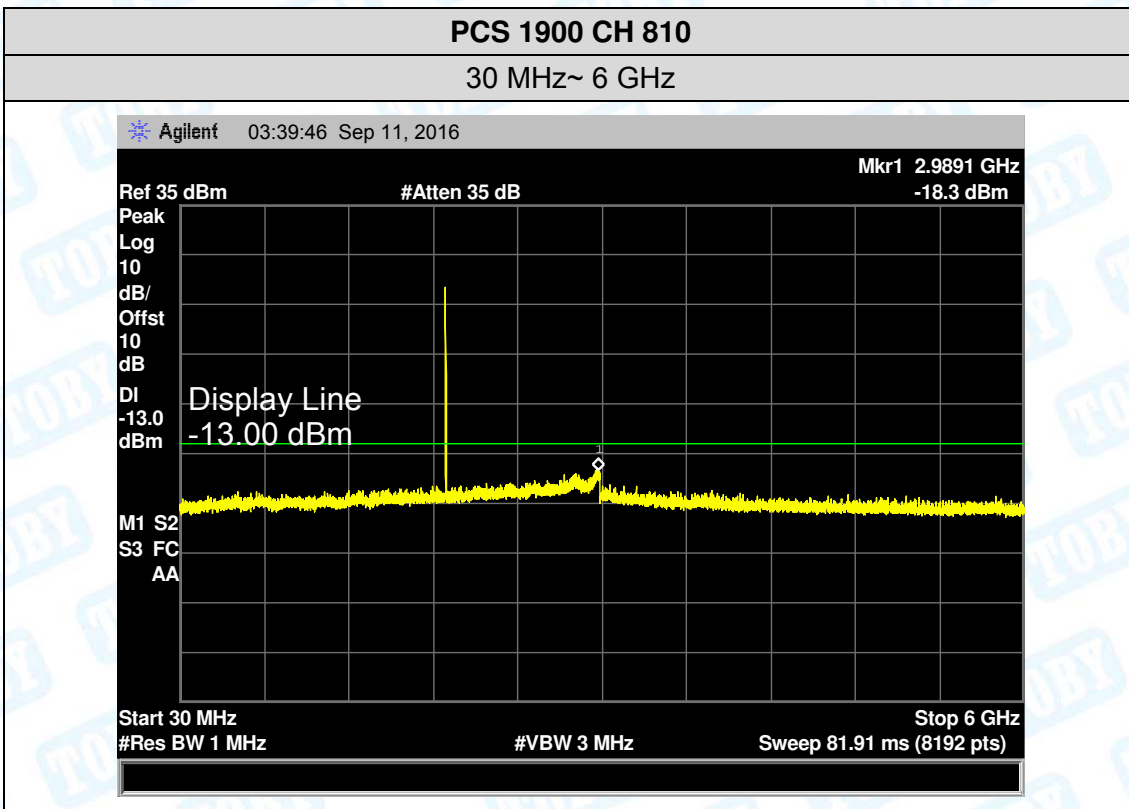

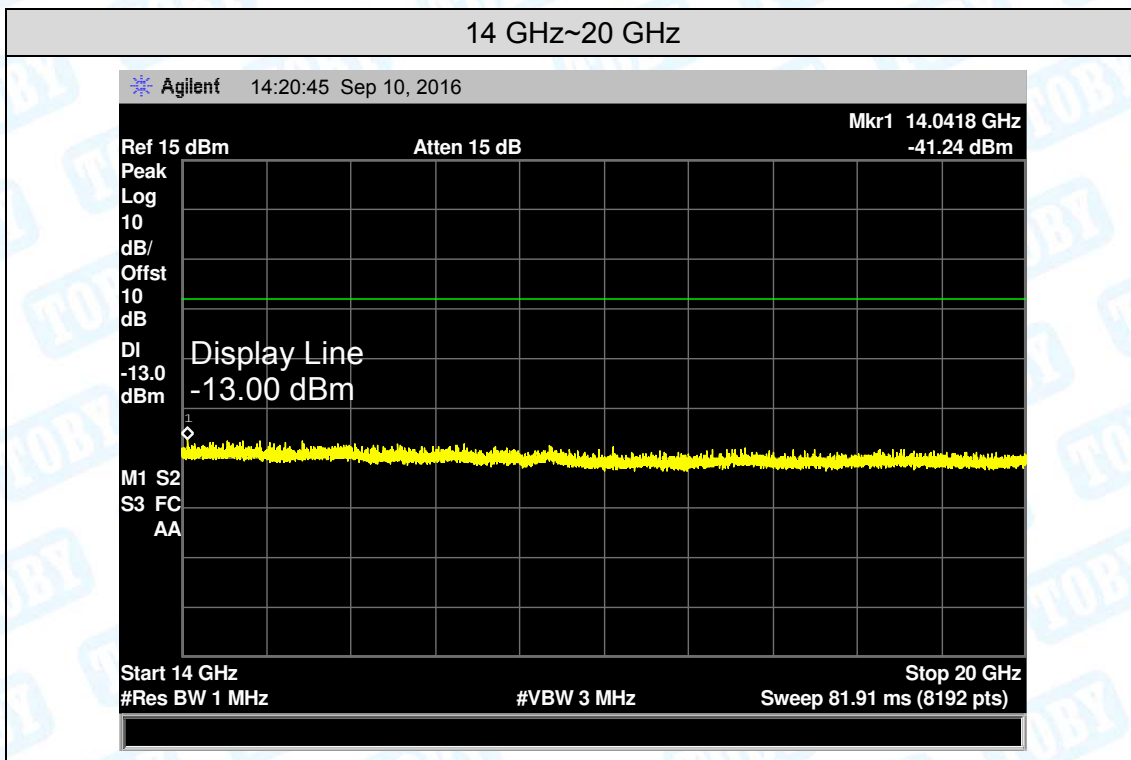

10. Band Edge Test

10.1 Test Standard and Limit

10.1.1 Test Standard

FCC Part 2: 2.1051, 2.1057

FCC Part 22H: 22.917(a)

FCC Part 24E: 24.238(a)

10.1.2 Test Limit

The power of any emission outside of the authorized operating frequency ranges must be attenuated below the transmitting power(P) by a factor of at least $43+10\log(P)$ dB. For all power levels +30 dBm to 0 dBm, this becomes a constant specification limit of -13 dBm.

10.2 Test Setup

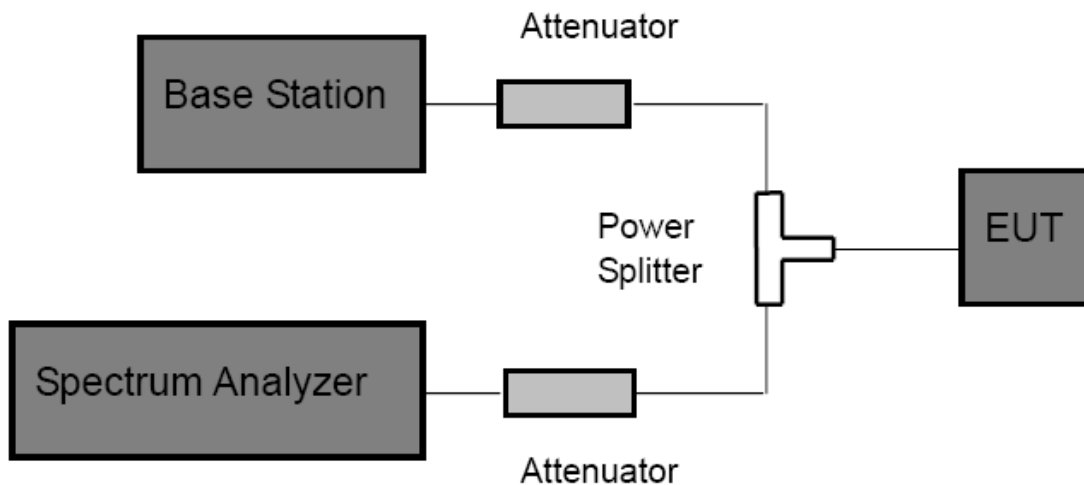

10.3 Test Procedure

- (1) The EUT was directly connected to the spectrum analyzer and Base station via power splitter as show in the block diagram above.
- (2) Spectrum Setting:
 GSM and PCS: RBW=3 kHz, VBW=10 kHz, Span 1 MHz, Detector: Peak Mode.
 WCDMA: RBW=100 kHz, VBW=300 kHz, Span 5 MHz, Detector: Peak Mode.
- (3) The band edges of low and high channels for the highest RF powers were measured.

10.4 EUT Operating Condition

The EUT was continuously connected with the Base station and transmitting in the max power during the test.

10.5 Test Data

Please refer the following plots:

Band edge emission:

Test Mode:	GSM850
------------	--------

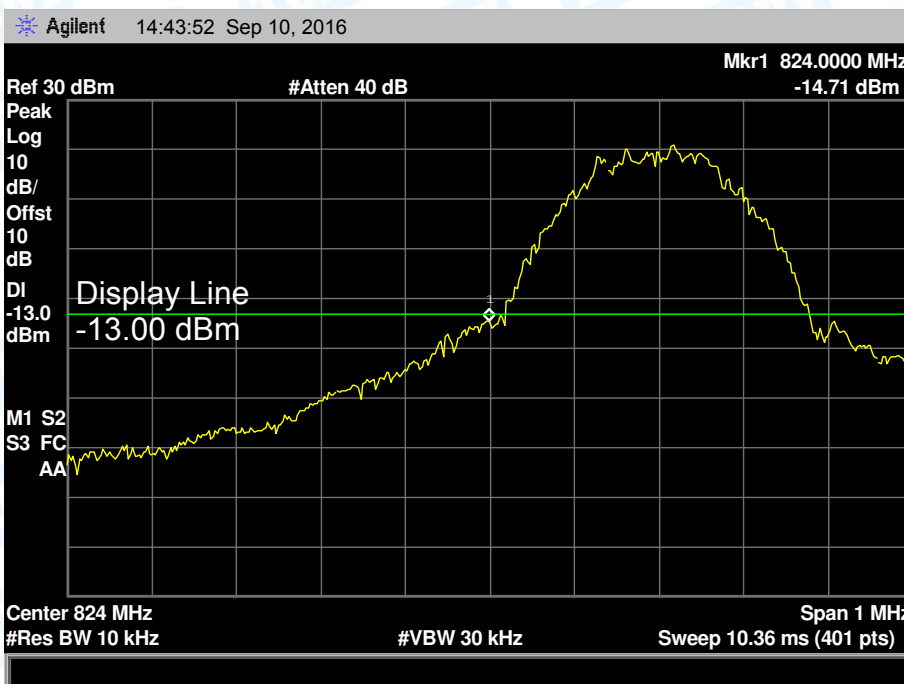

Lowest channel

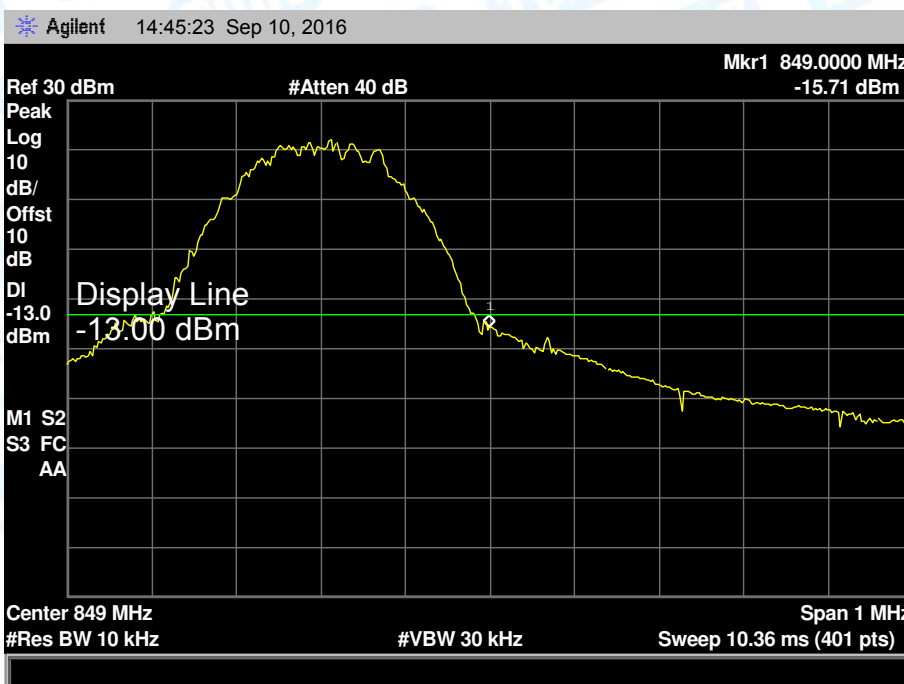

Highest channel

Test Mode: GPRS850

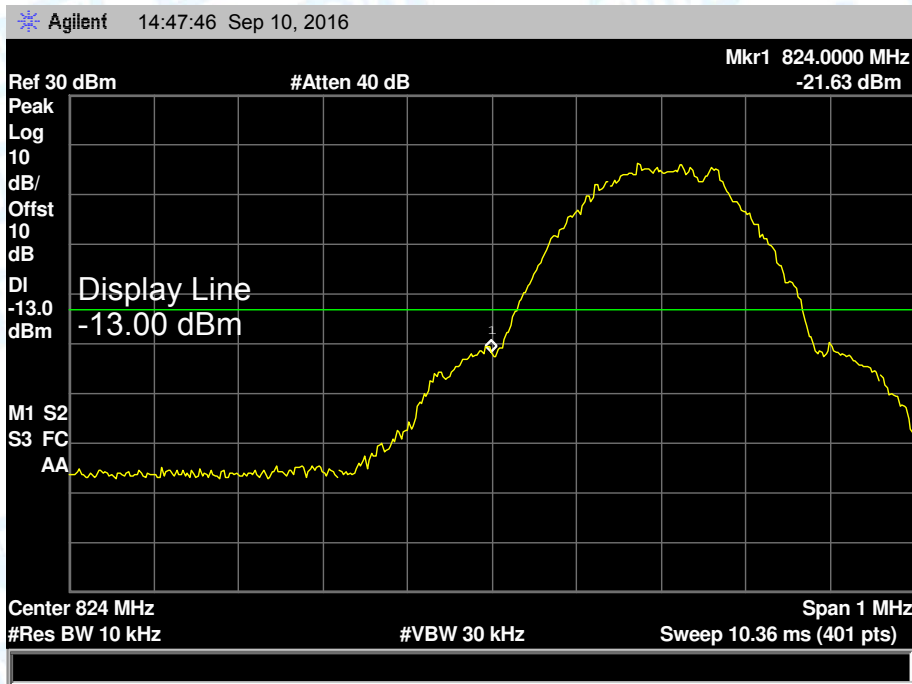

Lowest channel

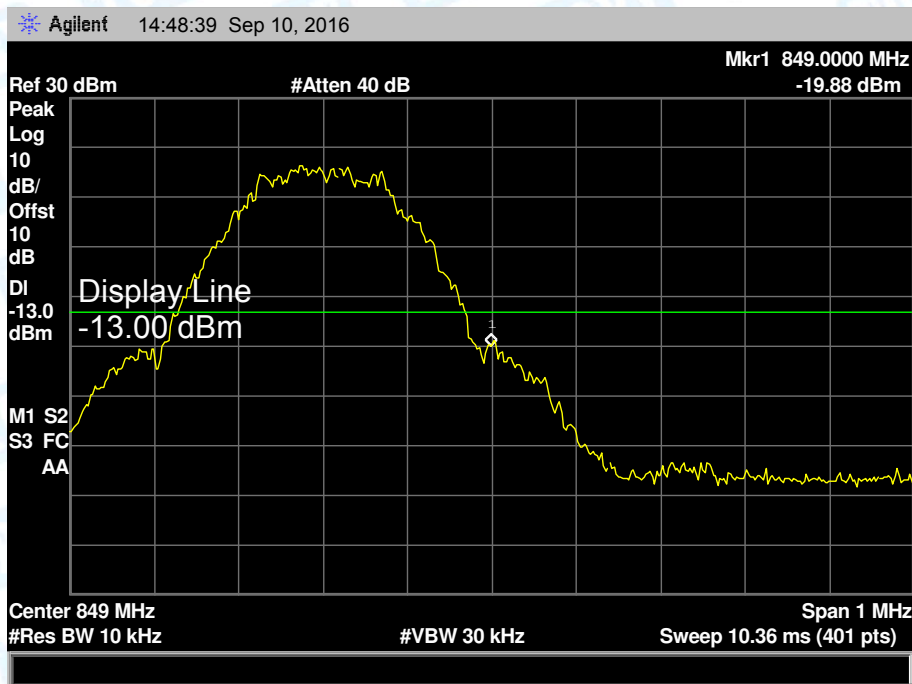

Highest channel

Test Mode: EGPRS850

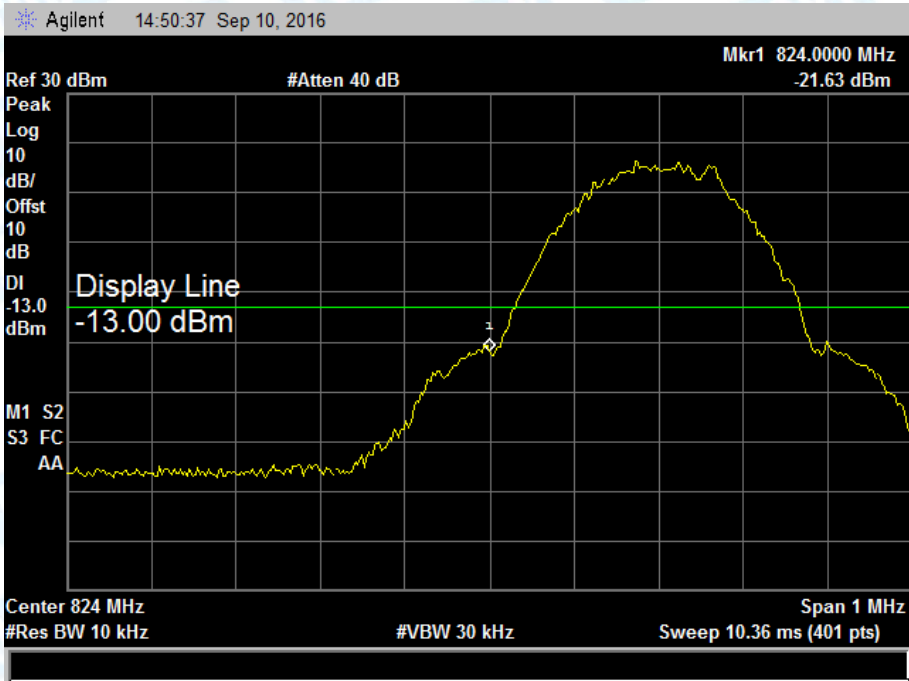

Lowest channel



Highest channel

Test Mode:	PCS1900
------------	---------

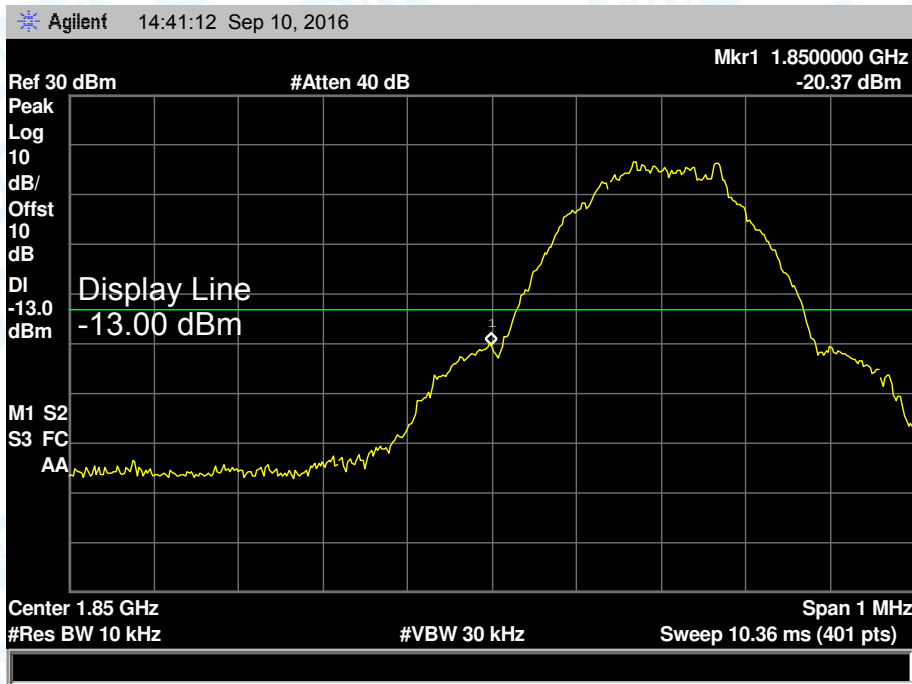

Lowest channel

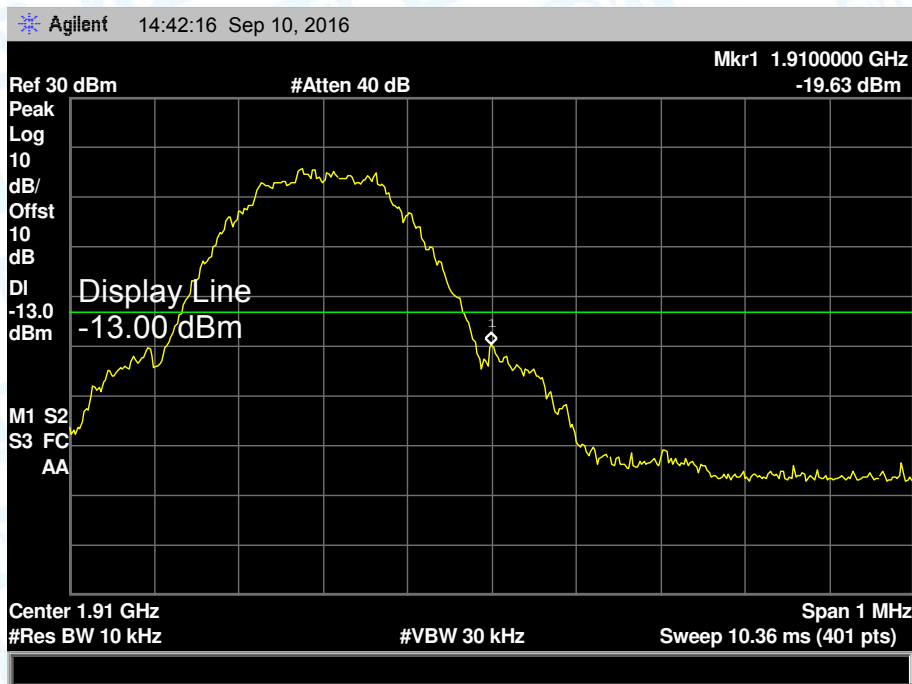

Highest channel

Test Mode: GPRS1900

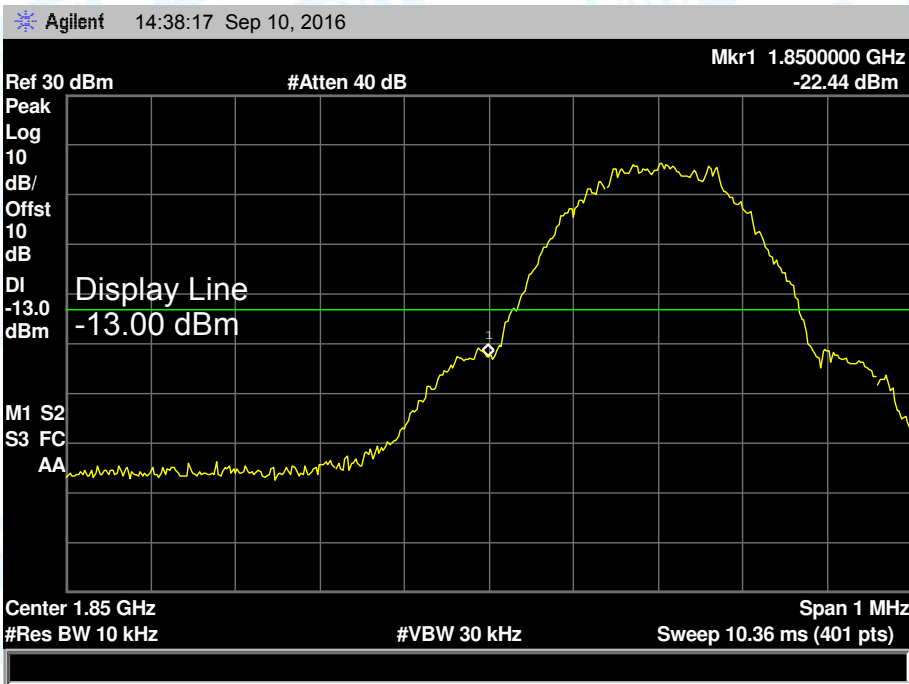

Lowest channel

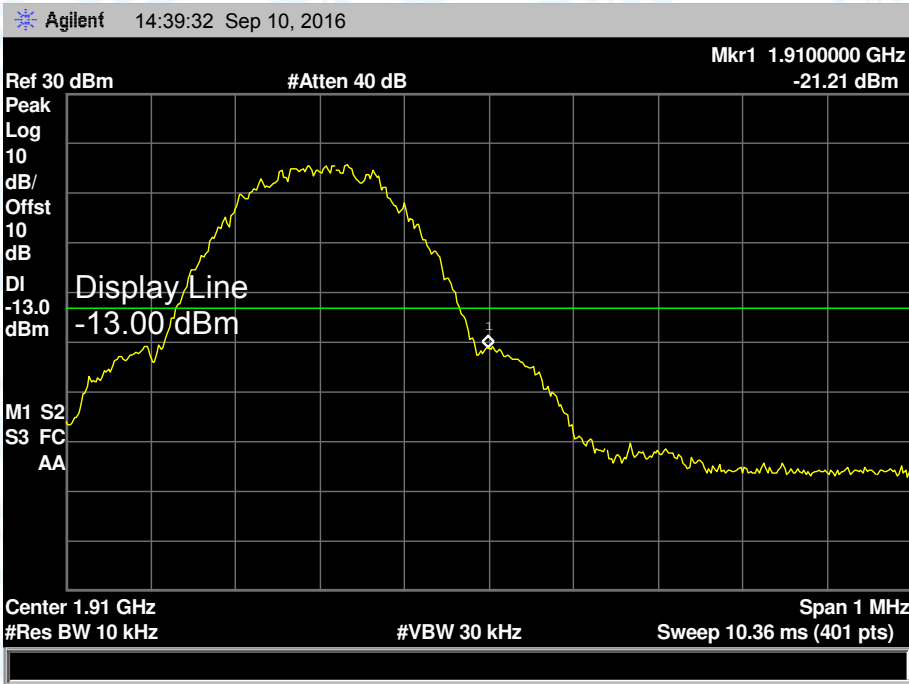

Highest channel

Test Mode:	EGPRS1900
------------	-----------

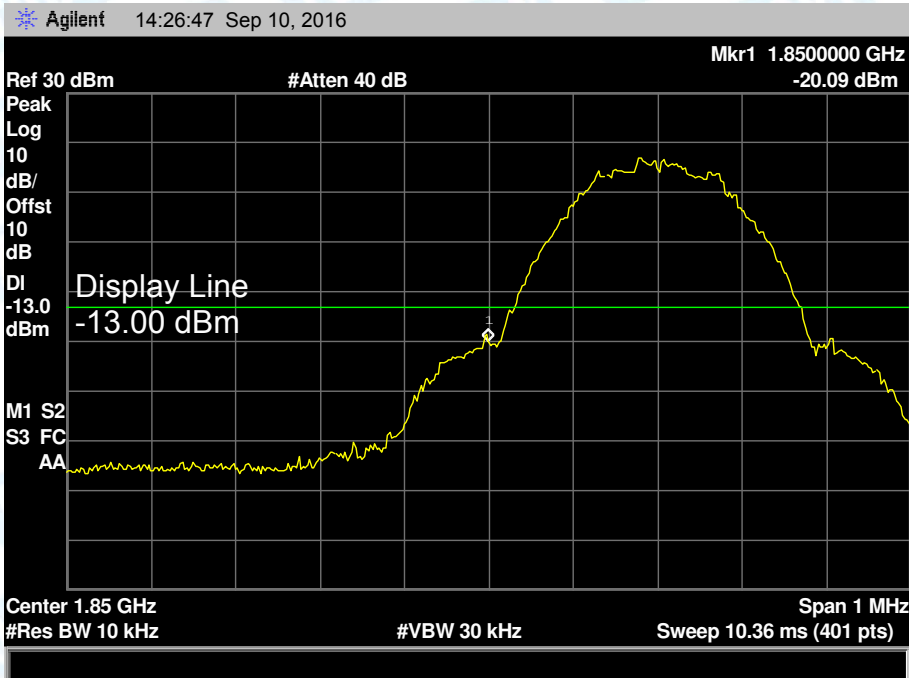

Lowest channel

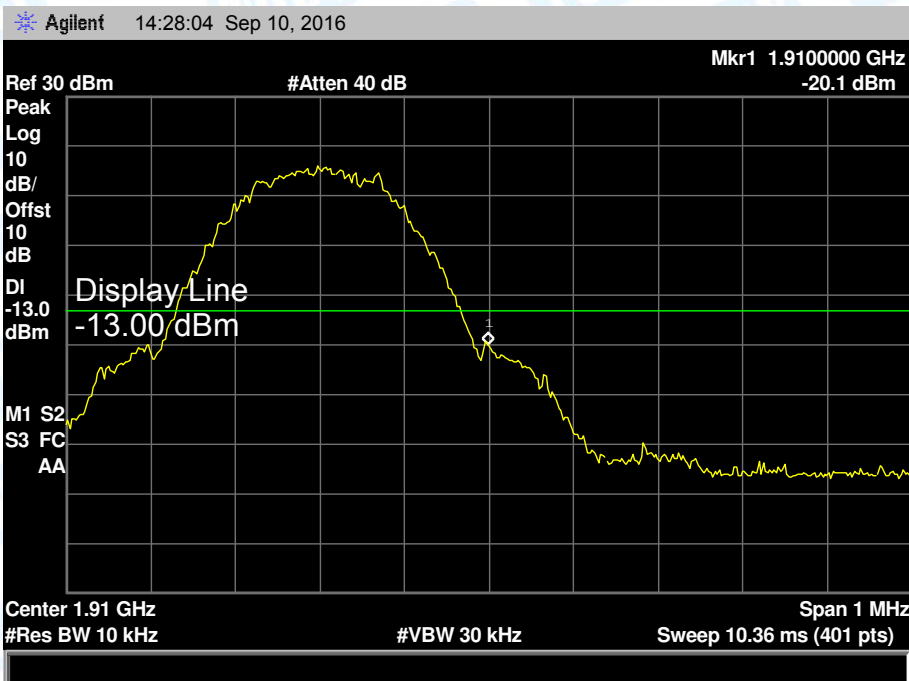

Highest channel

11. Radiated Out Band of Emissions

11.1 Test Standard and Limit

11.1.1 Test Standard

FCC Part 2: 2.1053, 2.1057

FCC Part 22H: 22.917

FCC Part 24E: 24.238

11.1.2 Test Limit

The power of any emission outside of the authorized operating frequency ranges must be attenuated below the transmitting power(P) by a factor of at least $43+10\log(P)$ dB. For all power levels +30 dBm to 0 dBm, this becomes a constant specification limit of -13 dBm.

11.2 Test Setup

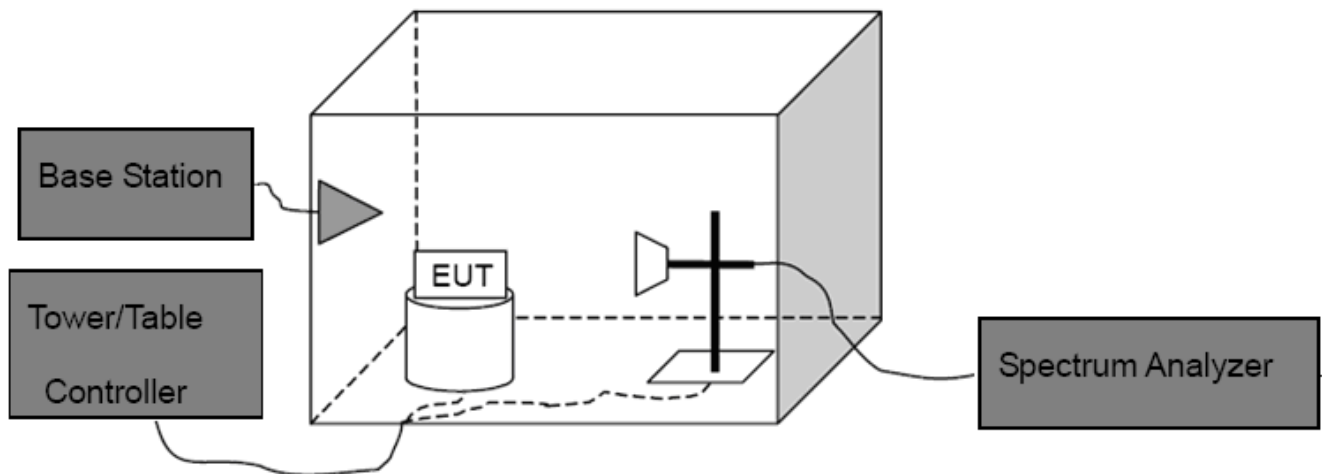

11.3 Test Procedure

- (1) The test system setup as show in the block diagram above.
- (2) The EUT was placed on an non-conductive rotating platform in an anechoic chamber. The radiated spurious emissions from 30MHz to 10th harmonious of fundamental frequency were measured at 3 m with a test antenna and a spectrum analyzer with RBW=1 MHz, VBW=1 MHz, peak detector settings.
- (3) During the measurement, the EUT was enforced in maximum power and linked with a base station. All the spurious emissions at 3m were measured by rotation of the turntable and the test antenna raised and lowered over a range from 1 to 4 meters in both horizontally and vertically polarized orientations.
- (4) When found the maximum level of emissions from the EUT. Remove the EUT and replace it with substitution antenna. A signal generator was connected to the substitution antenna by a non-radiating cable. The absolute levels of the spurious emissions were measured by the substitution.

Spurious emissions in dB=10 log(TX power in Watts/0.001)-the absolute level
Spurious attenuation limit in dB=43+10 log(power out in Watts)

11.4 EUT Operating Condition

The EUT was continuously connected with the Base station and transmitting in the max power during the test.

11.5 Test Data

Please refer the following pages.

Measurement Data (worst case)

Test mode:		GSM850						
Channel:		Middle			Date of Test:		2016-09-14	
Frequency (MHz)	Spurious Emission					Limit (dBm)	Result	
	Polarization (H&V)	Read Level (dBm)	Antenna Correct Factor (dBi)	Cable Loss (dB)	Emission Level (dBm)			
1673.20	Horizontal	-27.18	7.49	3.97	-16.18	-13.00	Pass	
2509.80	H	-36.17	7.03	5.05	-18.64			
3346.40	H	-42.82	12.48	5.98	-24.36			
4183.00	H	---	---	---	---			
5019.60	H	---	---	---	---			
5856.20	H	---	---	---	---			
1673.20	Vertical	-31.79	8.02	3.97	-17.35	-13.00	Pass	
2509.80	V	-42.64	10.47	5.05	-20.67			
3346.40	V	-49.36	16.92	5.98	-28.34			
4183.00	V	---	---	---	---			
5019.60	V	---	---	---	---			
5856.20	V	---	---	---	---			

Test mode:		GPRS850						
Channel:		Middle			Date of Test:		2016-09-14	
Frequency (MHz)	Spurious Emission					Limit (dBm)	Result	
	Polarization (H&V)	Read Level (dBm)	Antenna Correct Factor (dBi)	Cable Loss (dB)	Emission Level (dBm)			
1673.20	Horizontal	-28.62	7.49	3.97	-17.62	-13.00	Pass	
2509.80	H	-38.06	7.03	5.05	-20.53			
3346.40	H	-45.95	12.48	5.98	-27.49			
4183.00	H	---	---	---	---			
5019.60	H	---	---	---	---			
5856.20	H	---	---	---	---			
1673.20	Vertical	-32.78	8.02	3.97	-18.34	-13.00	Pass	
2509.80	V	-45.78	10.47	5.05	-23.81			
3346.40	V	-50.10	16.92	5.98	-29.08			
4183.00	V	---	---	---	---			
5019.60	V	---	---	---	---			
5856.20	V	---	---	---	---			

 Remark: 1, The testing has been conformed to $10 \times 836.6\text{MHz} = 8,366\text{MHz}$.

2, All other emissions more than 30 dB below the limit.

3, Emission Level= Read Level+ Antenna Correct Factor +Cable Loss

Test mode: EGPRS850							
Channel: Middle		Date of Test: 2016-09-14					
Frequency (MHz)	Spurious Emission					Limit (dBm)	Result
	Polarization (H&V)	Read Level (dBm)	Antenna Correct Factor (dBi)	Cable Loss (dB)	Emission Level (dBm)		
1673.20	Horizontal	-29.35	7.49	3.97	-18.35	-13.00	Pass
2509.80	H	-40.99	7.03	5.05	-23.46		
3346.40	H	-48.30	12.48	5.98	-29.84		
4183.00	H	---	---	---	---		
5019.60	H	---	---	---	---		
5856.20	H	---	---	---	---		
1673.20	Vertical	-33.67	8.02	3.97	-19.23	-13.00	Pass
2509.80	V	-44.48	10.47	5.05	-22.51		
3346.40	V	-51.51	16.92	5.98	-30.49		
4183.00	V	---	---	---	---		
5019.60	V	---	---	---	---		
5856.20	V	---	---	---	---		

Test mode: PCS1900							
Channel: Middle		Date of Test: 2016-09-14					
Frequency (MHz)	Spurious Emission					Limit (dBm)	Result
	Polarization (H&V)	Read Level (dBm)	Antenna Correct Factor (dBi)	Cable Loss (dB)	Emission Level (dBm)		
3760.00	Horizontal	-38.17	14.70	6.12	-17.35	-13.00	Pass
5640.00	H	-41.90	13.67	7.86	-20.37		
7520.00	H	-50.16	14.27	9.54	-26.35		
9400.00	H	---	---	---	---		
11280.00	H	---	---	---	---		
13160.00	H	---	---	---	---		
3760.00	Vertical	-40.29	15.81	6.12	-18.36	-13.00	Pass
5640.00	V	-45.18	13.80	7.86	-23.52		
7520.00	V	-52.28	13.40	9.54	-29.34		
9400.00	V	---	---	---	---		
11280.00	V	---	---	---	---		
13160.00	V	---	---	---	---		

Remark: 1, The testing has been conformed to $10 \times 836.6\text{MHz} = 8,366\text{MHz}$.

2, All other emissions more than 30 dB below the limit.

3, Emission Level= Read Level+ Antenna Correct Factor +Cable Loss

Test mode: GPRS1900							
Channel: Middle		Date of Test: 2016-08-16					
Frequency (MHz)	Spurious Emission					Limit (dBm)	Result
	Polarization (H&V)	Read Level (dBm)	Antenna Correct Factor (dBi)	Cable Loss (dB)	Emission Level (dBm)		
3760.00	Horizontal	-42.17	14.70	6.12	-21.35	-13.00	Pass
5640.00	H	-49.94	13.67	7.86	-28.41		
7520.00	H	-54.13	14.27	9.54	-30.32		
9400.00	H	---	---	---	---		
11280.00	H	---	---	---	---		
13160.00	H	---	---	---	---		
3760.00	Vertical	-44.01	15.81	6.12	-22.08	-13.00	Pass
5640.00	V	-47.84	13.80	7.86	-26.18		
7520.00	V	-52.61	13.40	9.54	-29.67		
9400.00	V	---	---	---	---		
11280.00	V	---	---	---	---		
13160.00	V	---	---	---	---		

Test mode: EGPRS1900							
Channel: Middle		Date of Test: 2016-08-16					
Frequency (MHz)	Spurious Emission					Limit (dBm)	Result
	Polarization (H&V)	Read Level (dBm)	Antenna Correct Factor (dBi)	Cable Loss (dB)	Emission Level (dBm)		
3760.00	Horizontal	-43.13	14.70	6.12	-22.31	-13.00	Pass
5640.00	H	-50.38	13.67	7.86	-28.85		
7520.00	H	-53.86	14.27	9.54	-30.05		
9400.00	H	---	---	---	---		
11280.00	H	---	---	---	---		
13160.00	H	---	---	---	---		
3760.00	Vertical	-43.85	15.81	6.12	-21.92	-13.00	Pass
5640.00	V	-48.79	13.80	7.86	-27.13		
7520.00	V	-52.60	13.40	9.54	-29.66		
9400.00	V	---	---	---	---		
11280.00	V	---	---	---	---		
13160.00	V	---	---	---	---		

Remark: 1, The testing has been conformed to $10 \times 1880.0\text{MHz} = 18,800\text{MHz}$.

2, All other emissions more than 30 dB below the limit.

3, Emission Level= Read Level+ Antenna Correct Factor +Cable Loss

-----End of Report-----