

TEST REPORT

Product Name: 4 TERRA WIRELESS PHONE CHARGER
FCC ID: 2AJQ7-4TWCP02
Trademark: N/A
Model Number: 4TWCP02
Prepared For: QUEST USA CORP.
Address: 495 Flatbush Ave Brooklyn NY 11225, USA
Manufacturer: QUEST USA CORP
Address: 495 Flatbush Ave Brooklyn NY 11225, USA
Prepared By: Shenzhen CTB Testing Technology Co., Ltd.
Address: Floor 1&2, Building A, No. 26 of Xinhe Road, Xinqiao Community, Xinqiao Street, Baoan District, Shenzhen, Guangdong China
Sample Received Date: Apr. 6, 2021
Sample tested Date: Apr. 6, 2021 to Apr. 10, 2021
Issue Date: Apr. 10, 2021
Report No.: CTB210407026RFX
Test Standards FCC Part 15 C
Test Results PASS
Remark: This is wireless charger radio test report.

Compiled by:

Arron Liu

Arron Liu

Reviewed by:

Bin Mei

Bin Mei

Approved by:



Rita Xiao / Director

The test report is effective only with both signature and specialized stamp. This result(s) shown in this report refer only to the sample(s) tested. Without written approval of Shenzhen CTB Testing Technology Co., Ltd. this report can't be reproduced except in full. The tested sample(s) and the sample information are provided by the client.

TABLE OF CONTENTS

1.GENERAL INFORMATION	3
1.1. Report information.....	3
1.2. Measurement Uncertainty.....	3
1.3. Test Facility.....	3
1.4. Test Uncertainty.....	4
2.PRODUCT DESCRIPTION	5
2.1. EUT Description.....	5
2.2. Block Diagram of EUT Configuration.....	5
2.3. Test Conditions.....	5
2.4. Description Of Support Units (Conducted Mode).....	5
3.TEST RESULTS SUMMARY	6
4.TEST EQUIPMENT USED.....	7
4.1. MEASUREMENT INSTRUMENTS LIST.....	7
5.CONDUCTED EMISSION TEST.....	9
5.1. Block Diagram of Test Setup.....	9
5.2. Test Standard.....	9
5.3. Conducted Emission Limit.....	9
5.4. EUT Configuration on Test.....	9
5.5. Operating Condition of EUT.....	10
5.6. Test Procedure.....	10
5.7. Test Result.....	10
6.RADIATED EMISSION MEASUREMENT	13
6.1. Block Diagram of Test Setup.....	13
6.2. Test Standard.....	14
6.3. EMI Test Receiver Setup.....	14
6.4. Test Procedure.....	14
6.5. Test Result.....	14
7.OCCUPIED BANDWIDTH	18
7.1. Block Diagram of Test Setup.....	18
7.2. Rules and specifications.....	18
7.3. Test Procedure.....	18
7.4. Test Result.....	18
8.EUT TEST PHOTOS.....	20
9.EUT PHOTOS.....	22

1. GENERAL INFORMATION

1.1. Report information

- 1.1.1. This report is not a certificate of quality; it only applies to the sample of the specific product/equipment given at the time of its testing. The results are not used to indicate or imply that they are application to the similar items. In addition, such results must not be used to indicate or imply that CTB approves recommends or endorses the manufacture, supplier or use of such product/equipment, or that CTB in any way guarantees the later performance of the product/equipment.
- 1.1.2. The sample/s mentioned in this report is/are supplied by Applicant, CTB therefore assumes no responsibility for the accuracy of information on the brand name, model number, origin of manufacture or any information supplied.
- 1.1.3. Additional copies of the report are available to the Applicant at an additional fee. No third part can obtain a copy of this report through CTB, unless the applicant has authorized CTB in writing to do so.

1.2. Measurement Uncertainty

Available upon request.

1.3. Test Facility

Site Description
Name of Firm : Shenzhen CTB Testing Technology Co., Ltd.
Site Location : Floor 1&2, Building A, No. 26 of Xinxhe Road,
Xinqiao Community, Xinqiao Street, Baoan
District, Shenzhen, Guangdong China

1.4. Test Uncertainty

Item	Uncertainty
Occupancy bandwidth	54.3kHz
Conducted output power Above 1G	0.9dB
Conducted output power below 1G	0.9dB
Power Spectral Density , Conduction	0.9dB
Conduction spurious emissions	2.0dB
Out of band emission	2.0dB
3m chamber Radiated spurious emission(30MHz-1GHz)	4.6dB
3m chamber Radiated spurious emission(1GHz-18GHz)	5.1dB
3m chamber Radiated spurious emission(18GHz-40GHz)	3.4dB
humidity uncertainty	5.5%
Temperature uncertainty	0.63°C
frequency	1×10 ⁻⁷
Conducted Emission (150KHz-30MHz)	3.2 dB
Radiated Emission(30MHz ~ 1000MHz)	4.8 dB
Radiated Emission(1GHz ~6GHz)	4.9 dB

2. PRODUCT DESCRIPTION

2.1. EUT Description

Description : 4 TERRA WIRELESS PHONE CHARGER
 Model Number : 4TWCP02
 Serial Model : N/A
 Model : N/A
 Difference :
 Power Supply : AC charger: DC5.0V, 2A
 INPUT: 5V/2A, 9V/1.67A
 OUTPUT: 10W
 Work Frequency : 110-205KHz

2.2. Block Diagram of EUT Configuration

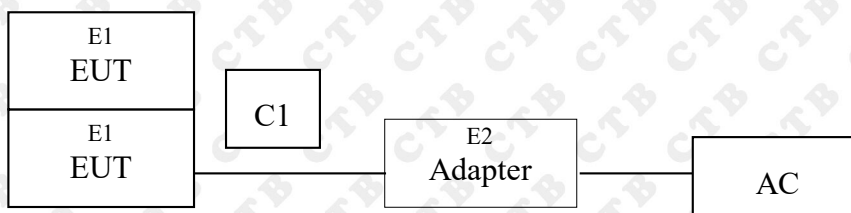

2.3. Test Conditions

Temperature: 23~25°C
 Relative Humidity: 55~63 %

2.4. Description Of Support Units (Conducted Mode)

The EUT has been tested as an independent unit together with other necessary accessories or support units. The following support units or accessories were used to form a representative test configuration during the tests.

Item	Equipment	Mfr/Brand	Model/Type No.	Series No.	Note
E1	4 TERRA WIRELESS PHONE CHARGER	N/A	4TWCP02	N/A	EUT

Item	Shielded Type	Ferrite Core	Length	Note

--	--	--	--	--

Note:

- (1) The support equipment was authorized by Declaration of Confirmation.
- (2) For detachable type I/O cable should be specified the length in cm in 「Length」 column.
- (3) "YES" is means "shielded" "with core"; "NO" is means "unshielded" "without core".

3. TEST RESULTS SUMMARY

Table 1 Test Results Summary

Test Items	Test Results
Conducted disturbance	Pass
Radiated disturbance	Pass

Remark: "N/A" means "Not applicable."

4. TEST EQUIPMENT USED

4.1. MEASUREMENT INSTRUMENTS LIST

Item	Equipment	Manufacturer	Type No.	Serial No.	Last calibration	Calibrated until
1	Spectrum Analyzer	Agilent	N9020A	MY52090073	Sep. 28, 2020	Sep. 28, 2021
2	Power Sensor	Agilent	U2021XA	MY56120032	Sep. 28, 2020	Sep. 28, 2021
3	Power Sensor	Agilent	U2021XA	MY56120034	Sep. 28, 2020	Sep. 28, 2021
4	Communication test set	R&S	CMW500	108058	Sep. 28, 2020	Sep. 28, 2021
5	Spectrum Analyzer	R&S	FSP40	100550	Sep. 28, 2020	Sep. 28, 2021
6	Signal Generator	Agilent	N5181A	MY49060920	Sep. 28, 2020	Sep. 28, 2021
7	Signal Generator	Agilent	N5182A	MY47420195	Sep. 28, 2020	Sep. 28, 2021
8	Communication test set	Agilent	E5515C	MY50102567	Oct. 10, 2020	Oct. 10, 2021
9	band rejection filter	Shenxiang	MSF2400-24 83.5MS-1154	20181015001	Sep. 28, 2020	Sep. 28, 2021
10	band rejection filter	Shenxiang	MSF5150-58 50MS-1155	20181015001	Sep. 28, 2020	Sep. 28, 2021
11	band rejection filter	Xingbo	XBLBQ-DZA 120	190821-1-1	Sep. 28, 2020	Sep. 28, 2021
12	BT&WI-FI Automatic test software	Microwave	MTS8310	Ver. 2.0.0.0	\	\
13	Rohde & Schwarz SFU Broadcast Test System	R&S	SFU	101017	Sep. 28, 2020	Sep. 28, 2021
14	Temperature humidity chamber	Hongjing	TH-80CH	DG-15174	Sep. 28, 2020	Sep. 28, 2021
15	234G Automatic test software	Microwave	MTS8200	Ver. 2.0.0.0	\	\
16	966 chamber	C.R.T.	966 Room	966	Nov. 9, 2019	Nov. 08, 2022
17	Receiver	R&S	ESPI	100362	Sep. 28, 2020	Sep. 28, 2021
18	Amplifier	HP	8447E	2945A02747	Sep. 28, 2020	Sep. 28, 2021
19	Amplifier	Agilent	8449B	3008A01838	Sep. 28, 2020	Sep. 28, 2021
20	TRILOG Broadband Antenna	Schwarzbeck	VULB 9168	00869	Nov. 02, 2020	Nov. 01, 2021
21	Horn Antenna	Schwarzbeck	BBHA9120D	1911	Nov. 02, 2020	Nov. 01, 2021
22	Software	Fala	EZ-EMC	FA-03A2 RE	\	\
23	3-Loop Antenna	Daze	ZN30401	17014	Sep. 28, 2020	Sep. 28, 2021
24	loop antenna	ZHINAN	ZN30900A	/	Sep. 28, 2020	Sep. 28, 2021

25	Horn antenna	A/H/System	SAS-574	588	Sep. 28, 2020	Sep. 28, 2021
26	Amplifier	AEROFLEX	/	S/N/ 097	Sep. 28, 2020	Sep. 28, 2021

Conducted emissions Test					
Equipment	Manufacturer	Model#	Serial#	Last Cal.	Next Cal.
AMN	ROHDE&SCHW ARZ	ESH3-Z5	100318	Sep. 28, 2020	Sep. 28, 2021
Pulse limiter	ROHDE&SCHW ARZ	ESH3Z2	357881052	Sep. 28, 2020	Sep. 28, 2021
EMI TEST RECEIVER	ROHDE&SCHW ARZ	ESCS30	834115/006	Sep. 28, 2020	Sep. 28, 2021
Coaxial cable	ZDECL	Z302S	18091804	Sep. 28, 2020	Sep. 28, 2021
ISN	TESEQ	NTFM815 8	183	Sep. 28, 2020	Sep. 28, 2021
EMI TEST RECEIVER	ROHDE&SCHW ARZ	ESCI	100428/003	Sep. 28, 2020	Sep. 28, 2021
Software	Fala	EZ-EMC	EMC-CON 3A1.1	\	\

5. CONDUCTED EMISSION TEST

5.1. Block Diagram of Test Setup

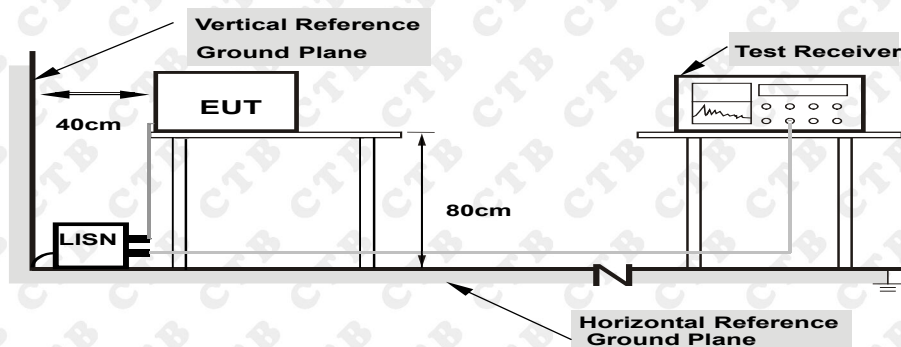

Note: 1.Support units were connected to second LISN.
2.Both of LISNs (AMN) are 80 cm from EUT and at least 80 from other units and other metal planes

The setup of EUT is according with per ANSI C63.10-2013 measurement procedure. The specification used was with the FCC Part 15.207 limits.

5.2. Test Standard

FCC§15.207

5.3. Conducted Emission Limit

Frequency MHz	Limits dB(μ V)	
	Quasi-peak Level	Average Level
0.15 ~ 0.50	66 ~ 56*	56 ~ 46*
0.50 ~ 5.00	56	46
5.00 ~ 30.00	60	50

Notes: 1. *Decreasing linearly with logarithm of frequency.

5.4. EUT Configuration on Test

The following equipments are installed on conducted emission test to meet FCC Part 15.207 requirement and operating in a manner, which tends to maximize its emission characteristics in a normal application.

5.5. Operating Condition of EUT

5.5.1. Setup the EUT and simulators as shown in Section 5.1.

5.5.2. Turn on the power of all equipments.

5.5.3. Let the EUT work in test modes (EUT Working) and test it.

5.6. Test Procedure

The EUT is put on a table of non-conducting material that is 80cm high. The vertical conducting wall of shielding is located 40cm to the rear of the EUT. The power line of the EUT is connected to the AC mains through a Artificial Mains Network (A.M.N.). A EMI test receiver (R&S Test Receiver ESHS30) is used to test the emissions form both sides of AC line. The bandwidth of EMI test receiver is set at 9kHz.

The bandwidth of the test receiver (R&S Test Receiver ESHS30) is set at 10kHz.

We pretest AC 120V and AC 240V, the worst voltage was AC 120V and the data recording in the report.

5.7. Test Result

PASS

Please refer to the following pages.

Temperature:	26 °C	Relative Humidity:	54%
Pressure:	1010hPa	Phase :	L
Test Voltage :	AC 120V/60Hz	Test Mode:	Normal Link

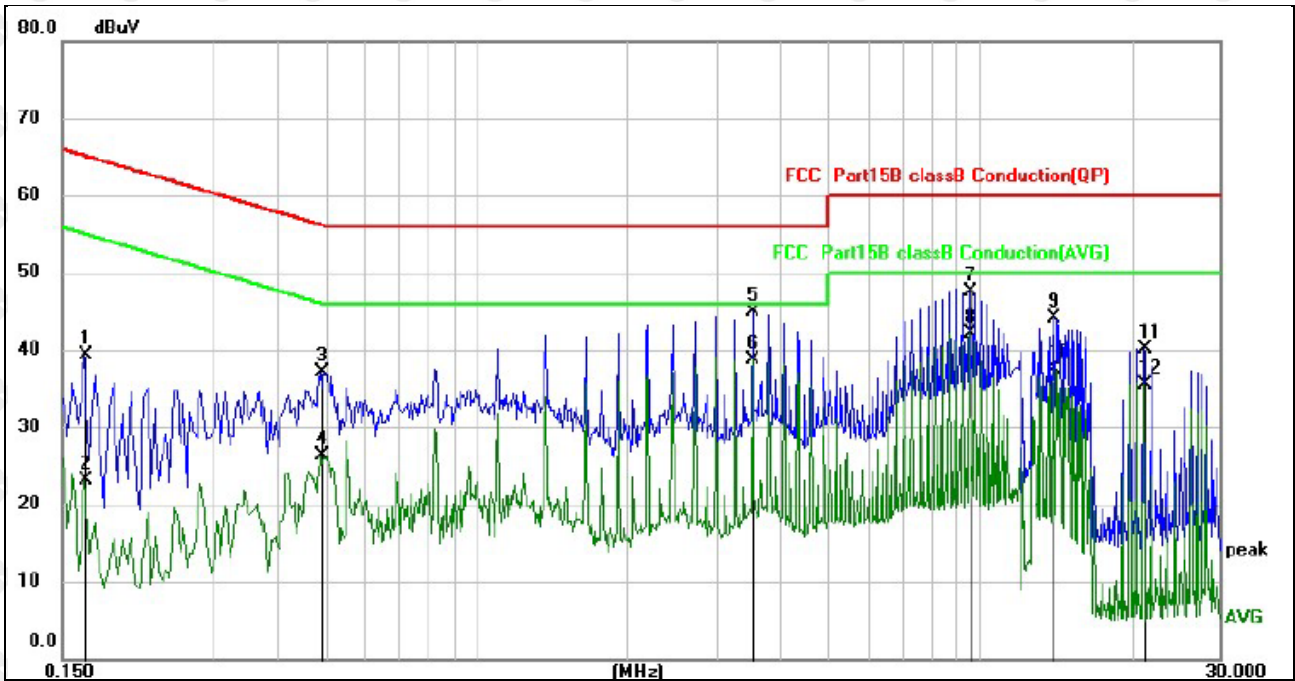

Remark:

1. All readings are Quasi-Peak and Average values.
2. Factor = Insertion Loss + Cable Loss.

No. Mk.	Freq. MHz	Reading Level dBuV	Correct Factor dB	Measure- ment dBuV	Limit dBuV	Margin dB	Detector
1	0.1660	29.12	10.09	39.21	65.16	-25.95	QP
2	0.1660	13.09	10.09	23.18	55.16	-31.98	AVG
3	0.4900	26.91	10.23	37.14	56.17	-19.03	QP
4	0.4900	16.13	10.23	26.36	46.17	-19.81	AVG
5	3.5420	34.49	10.33	44.82	56.00	-11.18	QP
6 *	3.5420	28.36	10.33	38.69	46.00	-7.31	AVG
7	9.5340	36.85	10.62	47.47	60.00	-12.53	QP
8	9.5340	31.51	10.62	42.13	50.00	-7.87	AVG
9	14.0140	33.48	10.69	44.17	60.00	-15.83	QP
10	14.0140	26.78	10.69	37.47	50.00	-12.53	AVG
11	21.2139	29.44	10.76	40.20	60.00	-19.80	QP
12	21.2139	24.66	10.76	35.42	50.00	-14.58	AVG

Temperature:	26 °C	Relative Humidity:	54%
Pressure:	1010hPa	Phase :	N
Test Voltage :	AC 120V/60Hz	Test Mode:	Normal Link

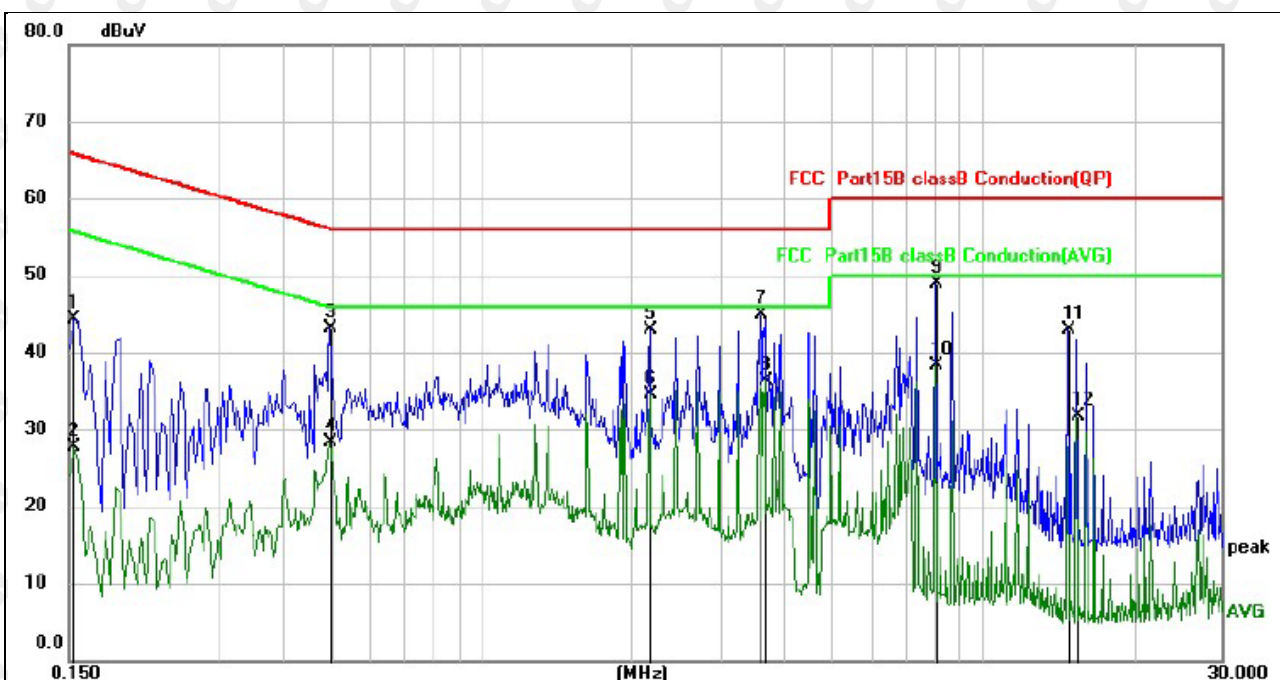

Remark:

1. All readings are Quasi-Peak and Average values.
2. Factor = Insertion Loss + Cable Loss.

No.	Mk.	Freq. MHz	Reading Level dBuV	Correct Factor dB	Measure- ment dBuV	Limit dBuV	Margin dB	Detector
1		0.1539	34.08	10.21	44.29	65.79	-21.50	QP
2		0.1539	17.51	10.21	27.72	55.79	-28.07	AVG
3		0.4980	33.13	10.05	43.18	56.03	-12.85	QP
4		0.4980	18.31	10.05	28.36	46.03	-17.67	AVG
5		2.1700	32.60	10.24	42.84	56.00	-13.16	QP
6		2.1700	24.33	10.24	34.57	46.00	-11.43	AVG
7		3.5860	34.51	10.32	44.83	56.00	-11.17	QP
8	*	3.6820	25.94	10.32	36.26	46.00	-9.74	AVG
9		8.0380	38.47	10.48	48.95	60.00	-11.05	QP
10		8.0380	27.87	10.48	38.35	50.00	-11.65	AVG
11		14.7780	32.27	10.70	42.97	60.00	-17.03	QP
12		15.4300	20.95	10.71	31.66	50.00	-18.34	AVG

6. RADIATED EMISSION MEASUREMENT

6.1. Block Diagram of Test Setup

6.1.1. Block Diagram of connection between the EUT and the simulators

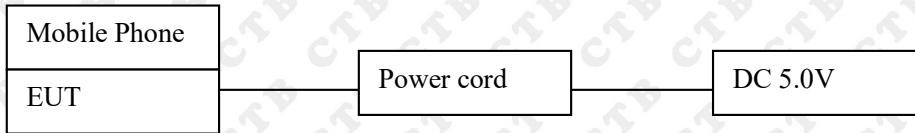

6.1.2. Anechoic Chamber Test Setup Diagram

(A) Radiated Emission Test-Up Frequency Below 30MHz

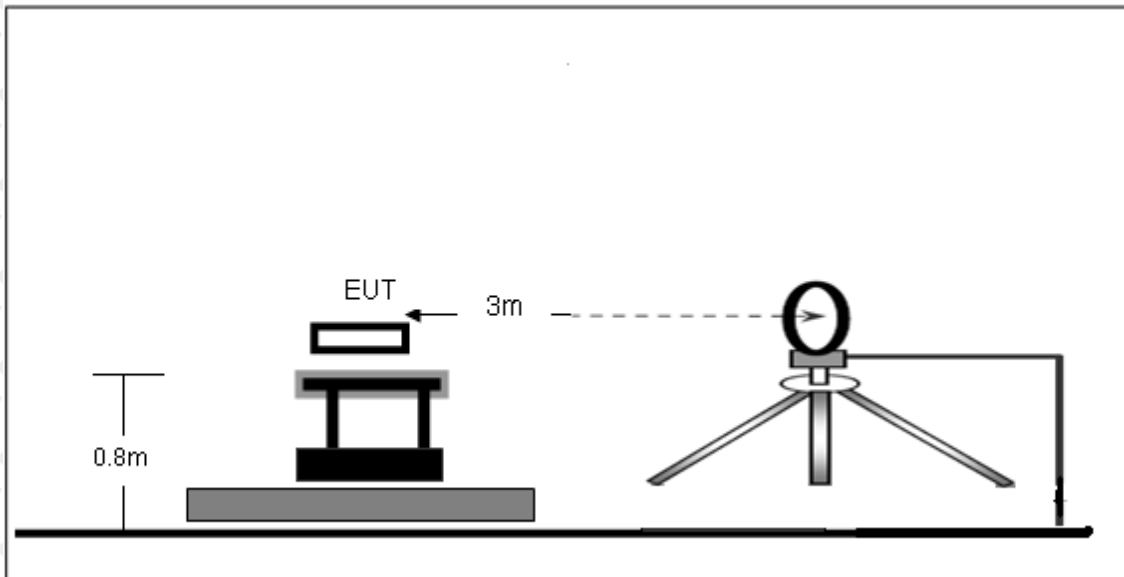

(B) Radiated Emission Test-Up Frequency 30MHz~1GHz

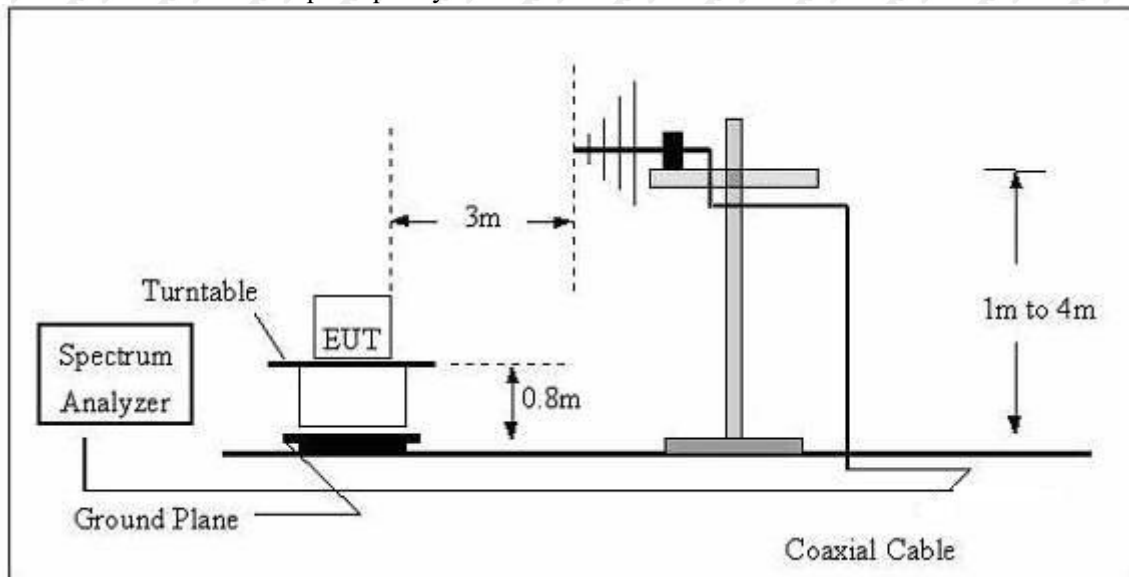

The radiated emission tests were performed in the 3 meters chamber test site, using the setup accordance with the ANSI C63.10-2013. The specification used was the FCC 15.209 and FCC 15.205 limits.

6.2. Test Standard

FCC §15.209; §15.205

6.3. EMI Test Receiver Setup

The system was investigated from 9kHz to 1GHz.

During the radiated emission test, the EMI test receiver setup was set with the following configurations:

Frequency Range	RBW	Video B/W	Detector
9 kHz – 150 kHz	200 kHz	1 kHz	QP
150 kHz – 30MHz	9kHz	30kHz	QP
30 MHz – 1000 MHz	120 kHz	300 kHz	QP

Note: For the frequency bands 9-90 kHz and 110-490 kHz, the test was based on average detector.

6.4. Test Procedure

The EUT is placed on a turn table which is 0.8 meter above ground. The turn table can rotate 360 degrees to determine the position of the maximum emission level. The EUT is set 3 meters away from the receiving antenna which is mounted on an antenna tower. The antenna can move up and down between 1 to 4 meters to find out the maximum emission level. Broadband antenna (calibrated by dipole antenna) are used as a receiving antenna. Both horizontal and vertical polarization of the antenna are set on measurement.

6.5. Test Result

PASS

Please refer to the following pages.

9kHz-30MHz

Temperature:	26 °C	Relative Humidity:	54%
Pressure:	1010 hPa	Polarization :	Horizontal
Test Voltage :	AC120V/60Hz	Test Mode :	10W

Freq. (KHz)	Detector Mode (PK/QP/AV)	Reading (dBUV)	Factor (dB)	Actual FS (dBUV/m)	Limits 3m (dBUV/m)	Margin (dBUV/m)
25.9500	PEAK	36.22	20.60	56.82	139.32	-82.50
25.9500	AV	36.32	20.43	56.75	119.32	-62.57
58.3500	PEAK	50.09	20.59	70.68	132.28	-61.60
58.3500	AV	46.23	20.67	66.90	112.28	-45.38
125.6500	PEAK	67.87	20.22	88.09	125.62	-37.53
125.6500	AV	63.39	20.41	83.81	105.62	-21.81
688.7500	QP	31.12	20.76	51.88	70.84	-18.96
968.6700	QP	35.39	20.46	55.85	67.88	-12.03

Note:

Pre-scan in the all of mode, the worst case in of was recorded.

Factor = antenna factor + cable loss – pre-amplifier.

Margin = Limit - Emission Level.

30MHz-1GHz

Temperature:	26 °C	Relative Humidity:	54%
Pressure:	1010 hPa	Polarization :	Horizontal
Test Voltage :	AC120V/60Hz	Test Mode :	10W

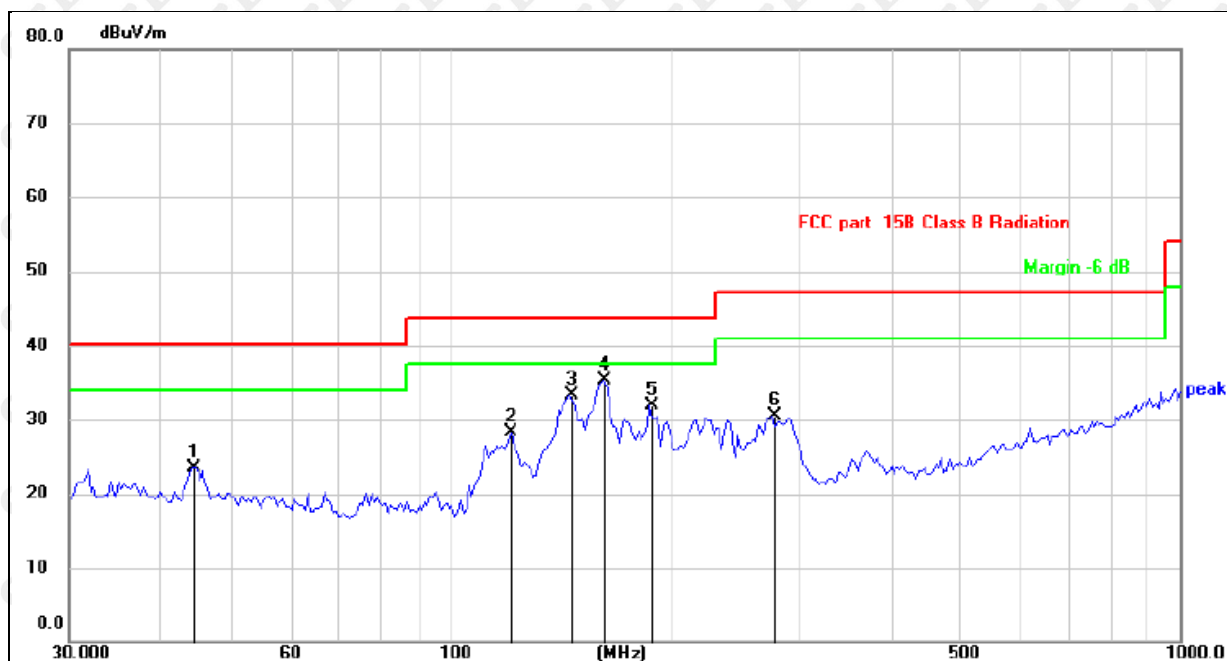

Remark:

Factor = Antenna Factor + Cable Loss – Pre-amplifier, Margin = Measurement– Limit.

No.	Mk.	Freq.	Reading Level	Correct Factor	Measurement	Limit	Over	
		MHz	dBuV	dB	dBuV/m	dB/m	dB	Detector
1		44.5087	30.54	-6.96	23.58	40.00	-16.42	QP
2		120.9109	36.74	-8.51	28.23	43.50	-15.27	QP
3		145.3506	40.36	-7.14	33.22	43.50	-10.28	QP
4	*	161.4742	42.16	-6.86	35.30	43.50	-8.20	QP
5		187.4241	41.37	-9.39	31.98	43.50	-11.52	QP
6		275.6399	38.28	-7.69	30.59	47.00	-16.41	QP

Temperature:	26 °C	Relative Humidity:	54%
Pressure:	1010 hPa	Polarization :	Vertical
Test Voltage :	AC120V/60Hz	Test Mode :	10W

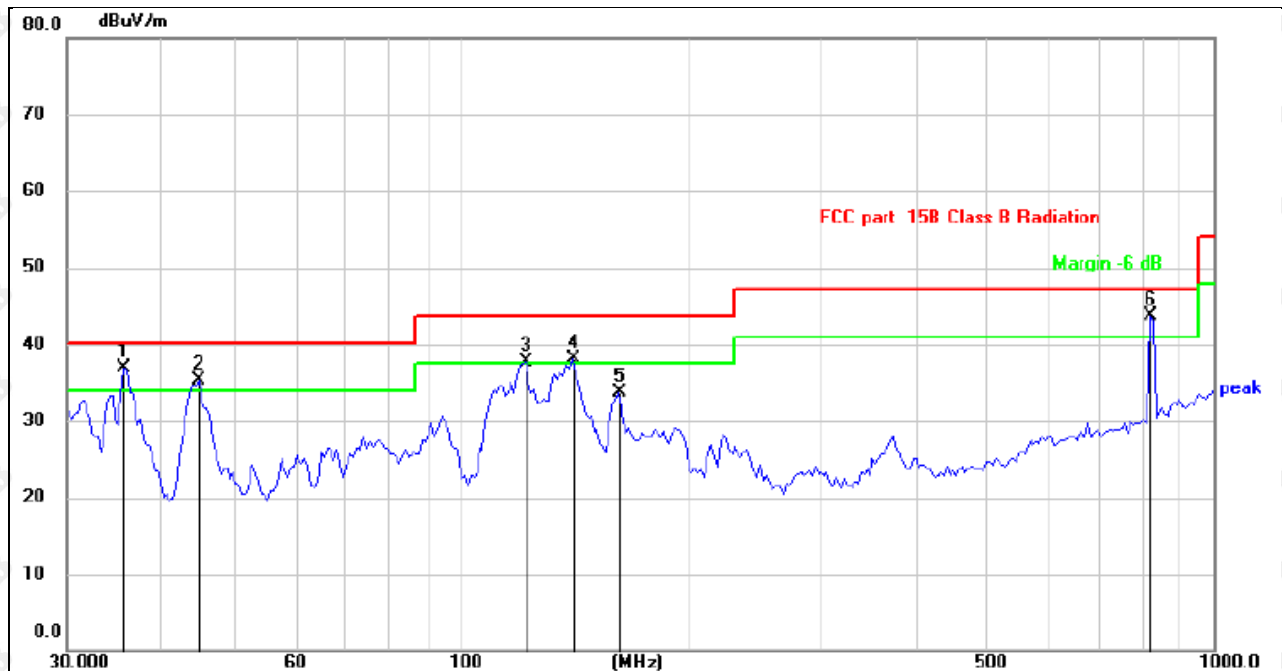

Remark:
Factor = Antenna Factor + Cable Loss – Pre-amplifier, Margin = Measurement– Limit.

No.	Mk.	Freq. MHz	Reading Level dBuV	Correct Factor dB	Measure- ment dBuV/m	Limit dB/m	Over dB	Detector
1	*	35.7490	44.16	-7.22	36.94	40.00	-3.06	QP
2	!	44.9006	42.29	-6.98	35.31	40.00	-4.69	QP
3	!	121.9755	46.20	-8.47	37.73	43.50	-5.77	QP
4	!	140.3421	45.44	-7.25	38.19	43.50	-5.31	QP
5		161.4742	40.48	-6.86	33.62	43.50	-9.88	QP
6	!	824.5968	39.48	4.16	43.64	47.00	-3.36	QP

7. OCCUPIED BANDWIDTH

7.1. Block Diagram of Test Setup

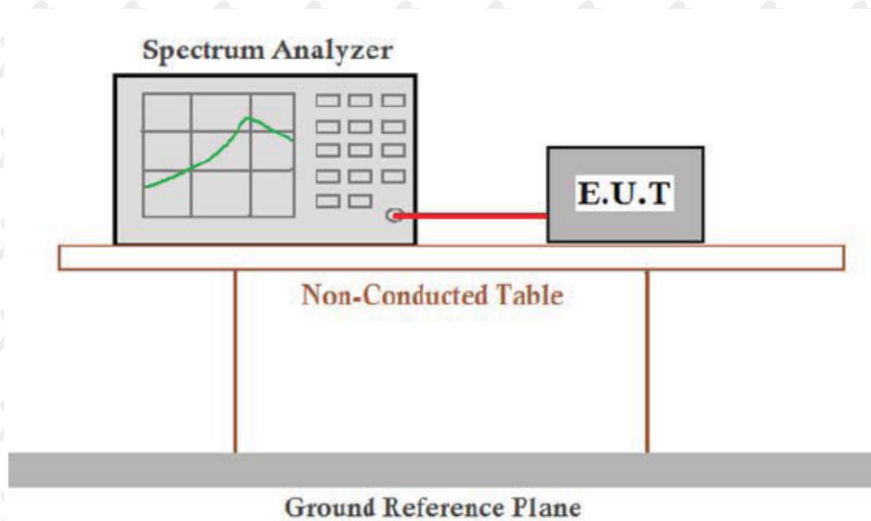

7.2. Rules and specifications

CFR 47 Part 15.215(c)
ANSI C63.10-2013

7.3. Test Procedure

Intentional radiators operating under the alternative provisions to the general emission limits, as contained in §§15.217 through 15.257 and in subpart E of this part, must be designed to ensure that 20dB bandwidth of the emission, or whatever bandwidth may otherwise be specified in the specific rule section under which the equip compliance with the 20dB attenuation specification may base on measurement at the intentional radiator's antenna output terminal unless the intentional radiator uses a permanently attached antenna, in which case compliance shall be demonstrated by measuring the radiated emissions.

7.4. Test Result

PASS

Mode	Freq (KHz)	20dB Bandwidth (KHz)	Limit (kHz)	Conclusion
Tx Mode	128	2.843	/	PASS

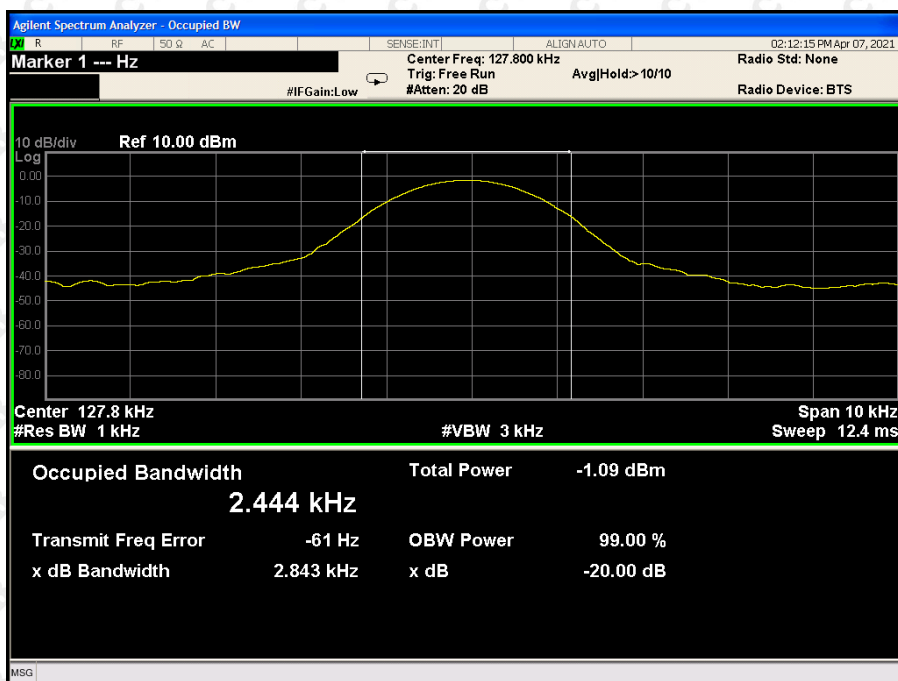

8. EUT TEST PHOTOS

Conducted Measurement Photos

30MHz-1GHz



Radiated Measurement Photos

30MHz-1GHz

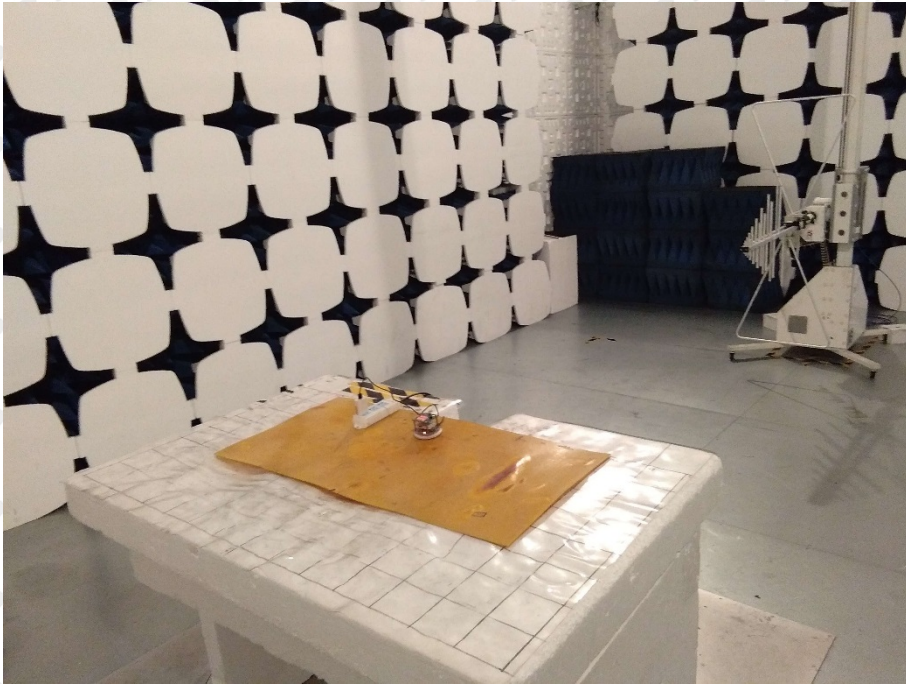

9K-30MHz

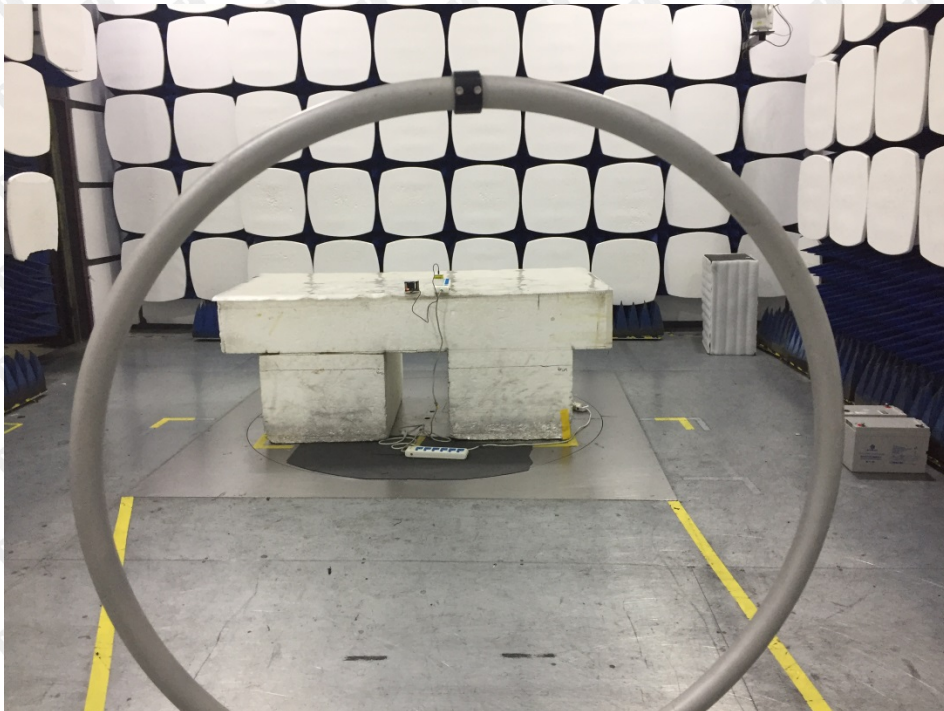

9. EUT PHOTOS

EUT 1



EUT 2

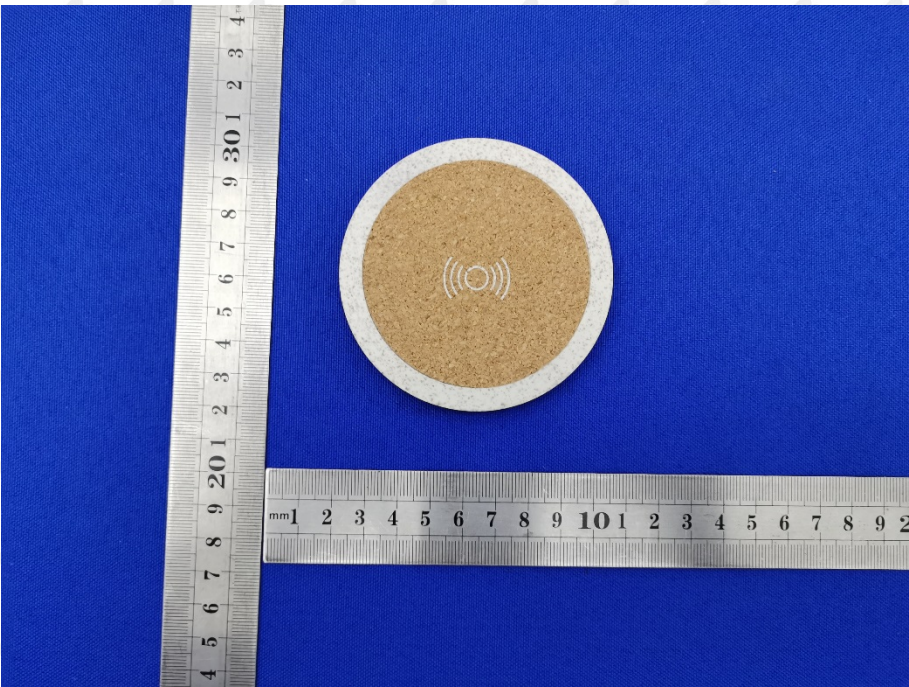

EUT 3

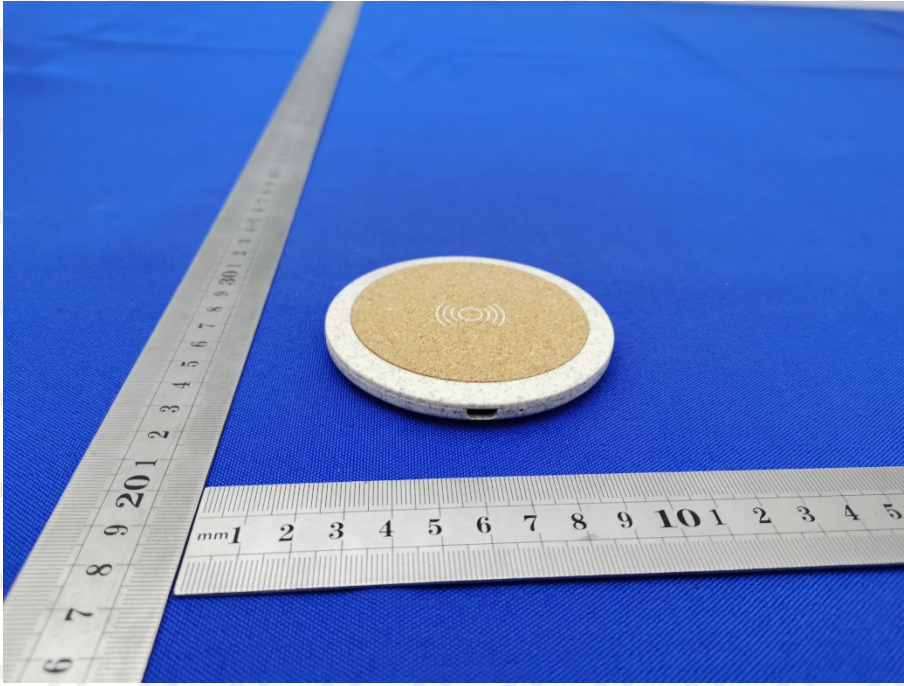

EUT 4

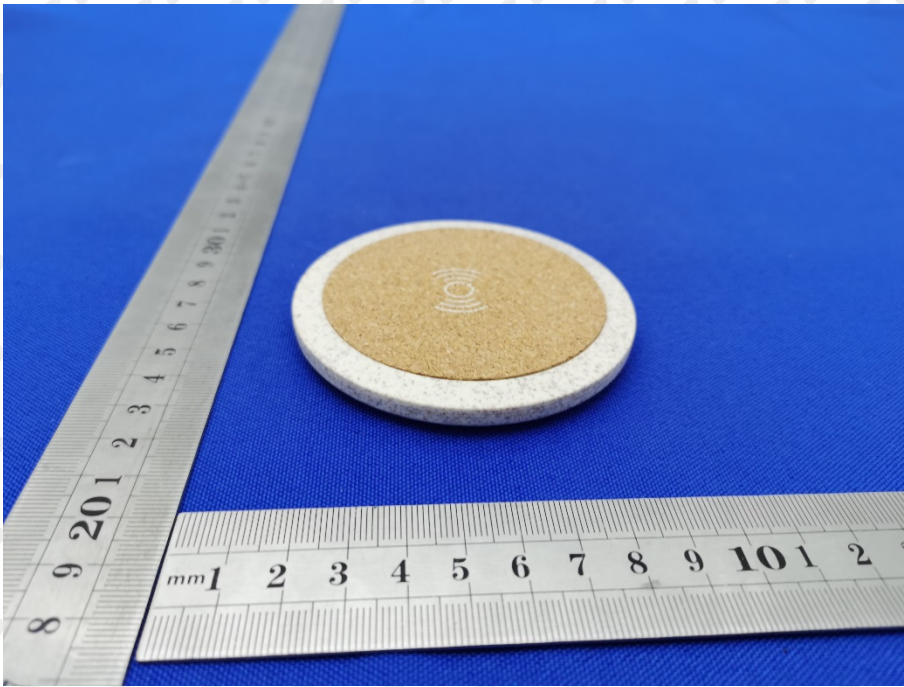

***** END OF REPORT *****