

APPLICATION CERTIFICATION FCC Part 15C  
On Behalf of  
Shenzhen Leshi Video Technology Co.,Ltd

Floodlight Camera  
Model No.: L820

FCC ID: 2AJPAL820

Prepared for : Shenzhen Leshi Video Technology Co.,Ltd  
Address : 5th Floor, 2nd Block, Zhongyuntai Industrial Park, No.1  
Road, Tangtou, Shiyan Street, Bao'an District, Shenzhen,  
China

Prepared by : Shenzhen Accurate Technology Co., Ltd.  
Address : 1/F., Building A, Changyuan New Material Port, Science  
& Industry Park, Nanshan District, Shenzhen, Guangdong,  
P.R. China

Tel: (0755) 26503290  
Fax: (0755) 26503396

Report No. : ATE20190564  
Date of Test : May 7-15, 2019  
Date of Report : May 16, 2019

## TABLE OF CONTENTS

Description	Page
Test Report Certification	
<b>1. GENERAL INFORMATION .....</b>	<b>5</b>
1.1. Description of Device (EUT).....	5
1.2. Carrier Frequency of Channels.....	6
1.3. Accessory and Auxiliary Equipment .....	6
1.4. Description of Test Facility .....	7
1.5. Measurement Uncertainty.....	7
<b>2. MEASURING DEVICE AND TEST EQUIPMENT .....</b>	<b>8</b>
<b>3. OPERATION OF EUT DURING TESTING .....</b>	<b>9</b>
3.1. Operating Mode.....	9
3.2. Configuration and peripherals .....	9
<b>4. TEST PROCEDURES AND RESULTS .....</b>	<b>10</b>
<b>5. POWER LINE CONDUCTED MEASUREMENT .....</b>	<b>11</b>
5.1. Block Diagram of Test Setup.....	11
5.2. Power Line Conducted Emission Measurement Limits.....	12
5.3. Configuration of EUT on Measurement .....	12
5.4. Operating Condition of EUT .....	12
5.5. Test Procedure .....	12
5.6. Data Sample.....	13
5.7. Power Line Conducted Emission Measurement Results .....	13
<b>6. DUTY CYCLE MEASUREMENT.....</b>	<b>16</b>
6.1. Block Diagram of Test Setup.....	16
6.2. EUT Configuration on Measurement .....	16
6.3. Operating Condition of EUT .....	16
6.4. Test Procedure .....	16
6.5. Test Result .....	17
<b>7. 6DB BANDWIDTH MEASUREMENT.....</b>	<b>20</b>
7.1. Block Diagram of Test Setup.....	20
7.2. The Requirement For Section 15.247(a)(2).....	20
7.3. EUT Configuration on Measurement .....	20
7.4. Operating Condition of EUT .....	20
7.5. Test Procedure .....	20
7.6. Test Result .....	21
<b>8. 99% OCCUPIED BANDWIDTH.....</b>	<b>27</b>
8.1. Block Diagram of Test Setup.....	27
8.2. The Requirement For ANSI C63.10: 2013 Section 6.9.3.....	27
8.3. EUT Configuration on Measurement .....	27
8.4. Operating Condition of EUT .....	27
8.5. Test Procedure .....	28
8.6. Measurement Result .....	29
<b>9. MAXIMUM CONDUCTED (AVERAGE) OUTPUT POWER .....</b>	<b>35</b>
9.1. Block Diagram of Test Setup.....	35
9.2. The Requirement For Section 15.247(b)(3).....	35

9.3.	EUT Configuration on Measurement .....	35
9.4.	Operating Condition of EUT .....	35
9.5.	Test Procedure .....	35
9.6.	Test Result .....	36
<b>10.</b>	<b>POWER SPECTRAL DENSITY MEASUREMENT.....</b>	<b>42</b>
10.1.	Block Diagram of Test Setup.....	42
10.2.	The Requirement For Section 15.247(e).....	42
10.3.	EUT Configuration on Measurement .....	42
10.4.	Operating Condition of EUT .....	42
10.5.	Test Procedure .....	43
10.6.	Test Result .....	44
<b>11.</b>	<b>BAND EDGE COMPLIANCE TEST .....</b>	<b>50</b>
11.1.	Block Diagram of Test Setup.....	50
11.2.	The Requirement For Section 15.247(d) .....	50
11.3.	EUT Configuration on Measurement .....	50
11.4.	Operating Condition of EUT .....	50
11.5.	Test Procedure .....	51
11.6.	Test Result .....	52
<b>12.</b>	<b>RADIATED SPURIOUS EMISSION TEST .....</b>	<b>69</b>
12.1.	Block Diagram of Test Setup.....	69
12.2.	The Limit For Section 15.247(d) .....	70
12.3.	Restricted bands of operation .....	71
12.4.	Configuration of EUT on Measurement .....	71
12.5.	Operating Condition of EUT .....	72
12.6.	Test Procedure .....	72
12.7.	Data Sample.....	73
12.8.	The Field Strength of Radiation Emission Measurement Results .....	73
<b>13.</b>	<b>ANTENNA REQUIREMENT.....</b>	<b>86</b>
13.1.	The Requirement .....	86
13.2.	Antenna Construction .....	86

## Test Report Certification

Applicant : Shenzhen Leshi Video Technology Co.,Ltd  
Address : 5th Floor, 2nd Block, Zhongyuntai Industrial Park, No.1 Road,  
Tangtou, Shiyuan Street, Bao'an District, Shenzhen, China  
Manufacturer : Shenzhen Leshi Video Technology Co.,Ltd  
Address : 5th Floor, 2nd Block, Zhongyuntai Industrial Park, No.1 Road,  
Tangtou, Shiyuan Street, Bao'an District, Shenzhen, China  
Product : Floodlight Camera  
Model No. : L820  
Trade Mark : Freecam

Measurement Procedure Used:

**FCC Rules and Regulations Part 15 Subpart C Section 15.247**  
**ANSI C63.10: 2013**

The EUT was tested according to DTS test procedure of Apr 05, 2017 KDB558074 v05r02 D01 DTS Meas Guidance v04 for compliance to FCC 47CFR 15.247 requirements

The device described above is tested by Shenzhen Accurate Technology Co., Ltd. to determine the maximum emission levels emanating from the device. The maximum emission levels are compared to the FCC Part 15 Subpart C Section 15.247 limits. The measurement results are contained in this test report and Shenzhen Accurate Technology Co., Ltd. is assumed full responsibility for the accuracy and completeness of these measurements. Also, this report shows that the Equipment Under Test (EUT) is to be technically compliant with the FCC requirements.

This report applies to above tested sample only. This report shall not be reproduced in part without written approval of Shenzhen Accurate Technology Co., Ltd.

Date of Test : May 7-15, 2019  
Date of Report : May 16, 2019

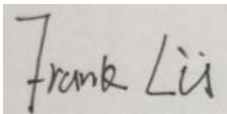
Test Engineer :   
(Frank Lü, Engineer)

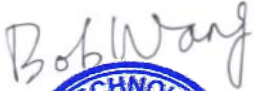
Prepared by :   
(Bob Wang, Engineer)

Approved & Authorized Signer :   
(Sean Liu, Manager)

## 1. GENERAL INFORMATION

### 1.1. Description of Device (EUT)

EUT	:	Floodlight Camera
Model Number	:	L820
Frequency Range	:	802.11b/g/n(20MHz): 2412-2462MHz
Number of Channels	:	802.11b/g/n (20MHz):11
Antenna Gain	:	3dBi
Type of Antenna	:	Integral Antenna
Power Supply	:	AC 120V; 60Hz
Data Rate	:	802.11b: 11, 5.5, 2, 1 Mbps 802.11g: 54, 48, 36, 24, 18, 12, 9, 6 Mbps 802.11n: 72.2~6.5Mbps
Modulation Type	:	DSSS, OFDM
Hardware version	:	V1.0
Software version	:	V1.0.04

## 1.2. Carrier Frequency of Channels

802.11b, 802.11g, 802.11n (20MHz)

Channel	Frequency(MHz)	Channel	Frequency(MHz)
01	2412	07	2442
02	2417	08	2447
03	2422	09	2452
04	2427	10	2457
05	2432	11	2462
06	2437	---	---

## 1.3. Accessory and Auxiliary Equipment

PC : Manufacturer: LENOVO  
(provided by laboratory) M/N: 4290-RT8  
S/N: R9-FW93G 11/08

#### 1.4. Description of Test Facility

- EMC Lab : Recognition of accreditation by Federal Communications Commission (FCC)  
The Designation Number is CN1189  
The Registration Number is 708358
- Listed by Innovation, Science and Economic Development Canada (ISED)  
The Registration Number is 5077A-2
- Accredited by China National Accreditation Service for Conformity Assessment (CNAS)  
The Registration Number is CNAS L3193
- Accredited by American Association for Laboratory Accreditation (A2LA)  
The Certificate Number is 4297.01
- Name of Firm : Shenzhen Accurate Technology Co., Ltd.  
Site Location : 1/F., Building A, Changyuan New Material Port, Science & Industry Park, Nanshan District, Shenzhen, Guangdong, P.R. China

#### 1.5. Measurement Uncertainty

- Conducted Emission Expanded Uncertainty = 2.23dB, k=2
- Radiated emission expanded uncertainty (9kHz-30MHz) = 3.08dB, k=2
- Radiated emission expanded uncertainty (30MHz-1000MHz) = 4.42dB, k=2
- Radiated emission expanded uncertainty (Above 1GHz) = 4.06dB, k=2

## 2. MEASURING DEVICE AND TEST EQUIPMENT

**Table 1: List of Test and Measurement Equipment**

Kind of equipment	Manufacturer	Type	S/N	Calibrated dates	Calibrated until
EMI Test Receiver	Rohde&Schwarz	ESCS30	100307	Jan. 05, 2019	1 Year
EMI Test Receiver	Rohde&Schwarz	ESR	101526/003	Jan. 05, 2019	1 Year
Spectrum Analyzer	Rohde&Schwarz	FSV-40	101495	Jan. 05, 2019	1 Year
Pre-Amplifier	Agilent	8447D	294A10619	Jan. 05, 2019	1 Year
Pre-Amplifier	Rohde&Schwarz	CBLU1183540-01	3791	Jan. 05, 2019	1 Year
Loop Antenna	Schwarzbeck	FMZB1516	1516131	Jan. 05, 2019	1 Year
Bilog Antenna	Schwarzbeck	VULB9163	9163-323	Jan. 05, 2019	1 Year
Horn Antenna	Schwarzbeck	BBHA9120D	9120D-655	Jan. 05, 2019	1 Year
Horn Antenna	Schwarzbeck	BBHA9170	9170-359	Jan. 05, 2019	1 Year
Open Switch and Control Unit	Rohde&Schwarz	OSP120 + OSP-B157	101244 + 100866	Jan. 05, 2019	1 Year
LISN	Schwarzbeck	NSLK8126	8126431	Jan. 05, 2019	1 Year
Highpass Filter	Wainwright Instruments	WHKX3.6/18G-10SS	N/A	Jan. 05, 2019	1 Year
Band Reject Filter	Wainwright Instruments	WRCG2400/2485-2375 /2510-60/11SS	N/A	Jan. 05, 2019	1 Year
Conducted Emission Test Software: ES-K1 V1.71					
Radiated Emission Test Software: EZ_EMV V1.1.4.2					



### 3. OPERATION OF EUT DURING TESTING

#### 3.1. Operating Mode

The mode is used: **1.802.11b Transmitting mode**

Low Channel: 2412MHz

Middle Channel: 2437MHz

High Channel: 2462MHz

**2.802.11g Transmitting mode**

Low Channel: 2412MHz

Middle Channel: 2437MHz

High Channel: 2462MHz

**3.802.11n (20MHz) Transmitting mode**

Low Channel: 2412MHz

Middle Channel: 2437MHz

High Channel: 2462MHz

The default power set by the software during WiFi test is 19dBm of 11b, 11dBm of 11g, 13dBm of 11n.

We tested 802.11b/g/n mode the all data rate and recorded the worst case data for this channel to be 1Mbps for 802.11b mode and 6Mbps for 802.11g mode and MCS0 for 802.11n mode.

#### 3.2. Configuration and peripherals

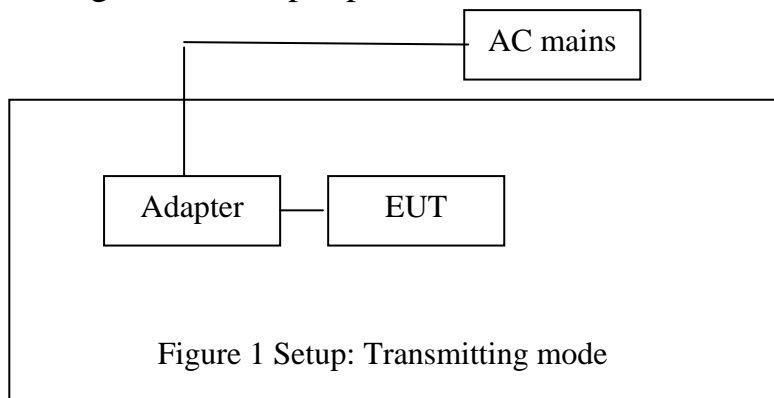

#### 4. TEST PROCEDURES AND RESULTS

<b>FCC Rules</b>	<b>Description of Test</b>	<b>Result</b>
Section 15.207	Power Line Conducted Emission	Compliant
KDB558074 v05r02 D01 DTS Meas Guidance v04	Duty cycle	Compliant
Section 15.247(a)(2)	6dB Bandwidth Test	Compliant
ANSI C63.10: 2013 Section 6.9.3	99% occupied Bandwidth	Compliant
Section 15.247(b)(3)	Maximum Peak Output Power Test	Compliant
Section 15.247(e)	Power Spectral Density Test	Compliant
Section 15.247(d)	Band Edge Compliance Test	Compliant
Section 15.247(d) Section 15.209	Radiated Spurious Emission Test	Compliant
Section 15.203	Antenna Requirement	Compliant

## 5. POWER LINE CONDUCTED MEASUREMENT

### 5.1. Block Diagram of Test Setup

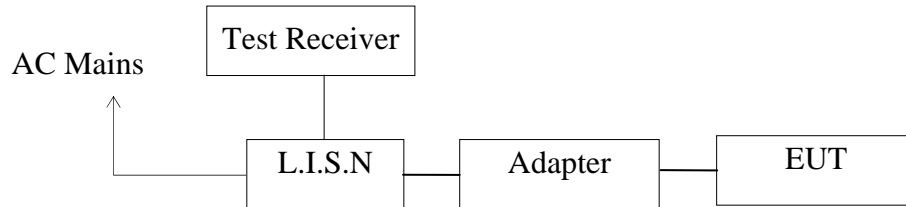

#### 5.1.1. Test System Setup

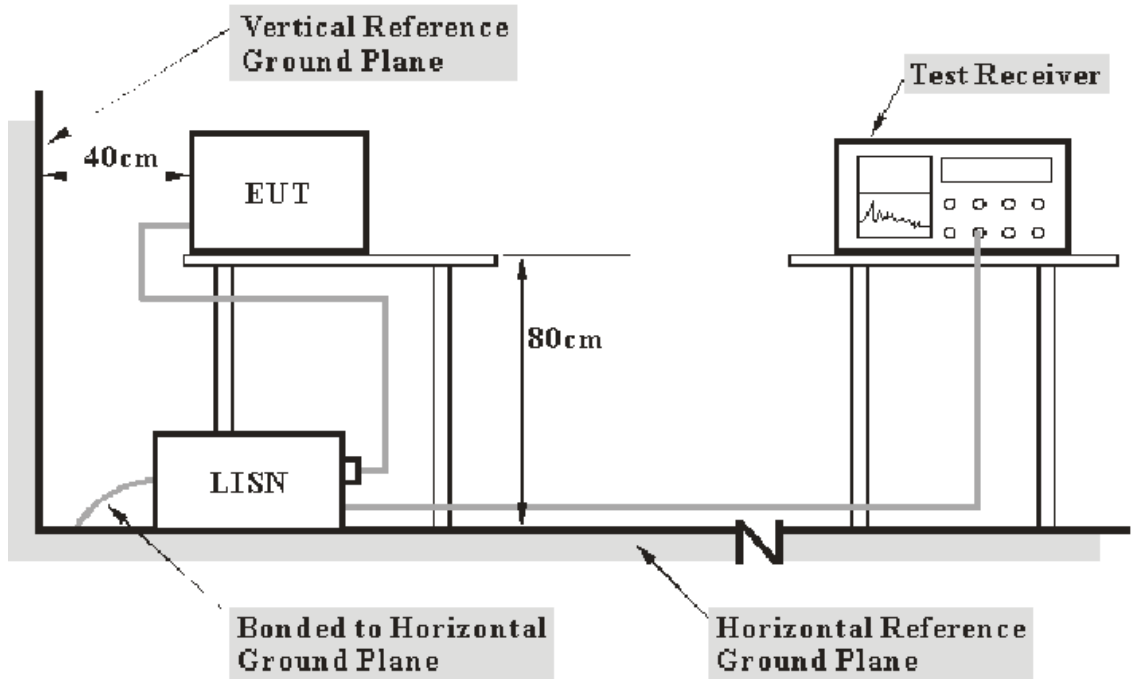

- Note:**
1. Support units were connected to second LISN.
  2. Both of LISNs (AMN) 80 cm from EUT and at the least 80 cm from other units and other metal planes support units.

### 5.2. Power Line Conducted Emission Measurement Limits

Frequency (MHz)	Limit dB(μV)	
	Quasi-peak Level	Average Level
0.15 - 0.50	66.0 – 56.0 *	56.0 – 46.0 *
0.50 - 5.00	56.0	46.0
5.00 - 30.00	60.0	50.0

NOTE1: The lower limit shall apply at the transition frequencies.  
 NOTE2: The limit decreases linearly with the logarithm of the frequency in the range 0.15MHz to 0.50MHz.

### 5.3. Configuration of EUT on Measurement

The equipments are installed on Power Line Conducted Emission Measurement to meet the commission requirement and operating regulations in a manner, which tends to maximize its emission characteristics in a normal application.

### 5.4. Operating Condition of EUT

- 5.4.1. Setup the EUT and simulator as shown as Section 5.1.
- 5.4.2. Turn on the power of all equipment.
- 5.4.3. Let the EUT work in test mode and measure it.

### 5.5. Test Procedure

The EUT is put on the plane 0.8 m high above the ground by insulating support and is connected to the power mains through a line impedance stabilization network (L.I.S.N.). This provides a 50ohm coupling impedance for the EUT system. Please refer the block diagram of the test setup and photographs. Both sides of AC lines are checked to find out the maximum conducted emission. In order to find the maximum emission levels, the relative positions of equipment and all of the interface cables shall be changed according to ANSI C63.10: 2013 on Conducted Emission Measurement.

The bandwidth of test receiver (R & S ESCS30) is set at 9kHz.

The frequency range from 150kHz to 30MHz is checked.

### 5.6.Data Sample

Frequency (MHz)	Transducer value (dB)	QuasiPeak Level (dBμV)	Average Level (dBμV)	QuasiPeak Limit (dBμV)	Average Limit (dBμV)	QuasiPeak Margin (dB)	Average Margin (dB)	Remark (Pass/Fail)
X.XX	10.5	51.1	34.2	56.0	46.0	4.9	11.8	Pass

Frequency(MHz) = Emission frequency in MHz  
 Transducer value(dB) = Insertion loss of LISN + Cable Loss  
 Level(dBμV) = Quasi-peak Reading/Average Reading + Transducer value  
 Limit (dBμV) = Limit stated in standard  
 Margin = Limit (dBμV) - Level (dBμV)

Calculation Formula:  
 Margin = Limit (dBμV) - Level (dBμV)

### 5.7.Power Line Conducted Emission Measurement Results

**PASS.**  
 Test Lab: Shielding room  
 Test Engineer: Frank

The frequency range from 150kHz to 30MHz is checked.

Maximizing procedure was performed on the six (6) highest emissions of the EUT. Emissions attenuated more than 20 dB below the permissible value are not reported.

All data was recorded in the Quasi-peak and average detection mode.

The spectral diagrams are attached as below.

**ACCURATE TECHNOLOGY CO.,LTD**

**CONDUCTED EMISSION STANDARD FCC PART 15 B**

EUT: Floodlight Camera M/N:L820  
 Manufacturer: Shenzhen Leshi Video Technology Co.,Ltd  
 Operating Condition: Wifi Communication  
 Test Site: 1#Shielding Room  
 Operator: Frank  
 Test Specification: L 120V/60Hz  
 Comment: Report NO.:ATE20190564  
 Start of Test: 5/7/2019 / 9:51:13AM

**SCAN TABLE: "V 9K-30MHz fin"**

Start Frequency	Stop Frequency	Step Width	Detector	Meas. Time	IF Bandw.	Transducer
9.0 kHz	150.0 kHz	100.0 Hz	QuasiPeak	1.0 s	200 Hz	NSLK8126 2008
150.0 kHz	30.0 MHz	5.0 kHz	QuasiPeak	1.0 s	9 kHz	NSLK8126 2008

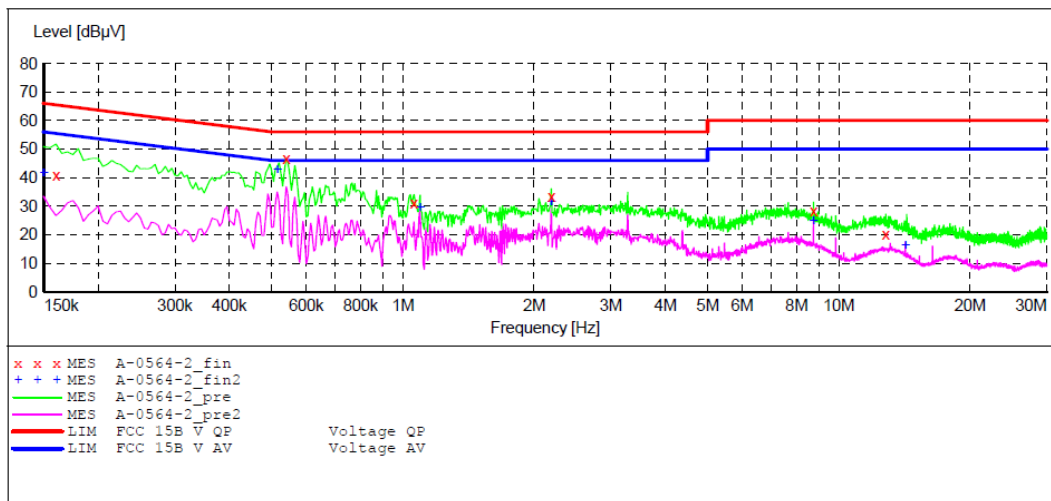

**MEASUREMENT RESULT: "A-0564-2\_fin"**

5/7/2019 9:52AM

Frequency MHz	Level dBµV	Transd dB	Limit dBµV	Margin dB	Detector	Line	PE
0.160000	40.90	10.5	66	24.6	QP	L1	GND
0.540000	46.70	10.7	56	9.3	QP	L1	GND
1.060000	31.20	10.9	56	24.8	QP	L1	GND
2.190000	33.50	11.0	56	22.5	QP	L1	GND
8.750000	28.30	11.3	60	31.7	QP	L1	GND
12.820000	20.00	11.3	60	40.0	QP	L1	GND

**MEASUREMENT RESULT: "A-0564-2\_fin2"**

5/7/2019 9:52AM

Frequency MHz	Level dBµV	Transd dB	Limit dBµV	Margin dB	Detector	Line	PE
0.150000	41.70	10.5	56	14.3	AV	L1	GND
0.515000	42.70	10.7	46	3.3	AV	L1	GND
1.095000	29.30	10.9	46	16.7	AV	L1	GND
2.190000	31.40	11.0	46	14.6	AV	L1	GND
8.750000	24.80	11.3	50	25.2	AV	L1	GND
14.215000	16.40	11.4	50	33.6	AV	L1	GND

ACCURATE TECHNOLOGY CO.,LTD

CONDUCTED EMISSION STANDARD FCC PART 15 B

EUT: Floodlight Camera M/N:L820  
 Manufacturer: Shenzhen Leshi Video Technology Co.,Ltd  
 Operating Condition: Wifi Communication  
 Test Site: 1#Shielding Room  
 Operator: Frank  
 Test Specification: N 120V/60Hz  
 Comment: Report NO.:ATE20190564  
 Start of Test: 5/7/2019 / 9:38:58AM

SCAN TABLE: "V 9K-30MHz fin"

Start Frequency	Stop Frequency	Step Width	Detector	Meas. Time	IF Bandw.	Transducer
9.0 kHz	150.0 kHz	100.0 Hz	QuasiPeak Average	1.0 s	200 Hz	NSLK8126 2008
150.0 kHz	30.0 MHz	5.0 kHz	QuasiPeak Average	1.0 s	9 kHz	NSLK8126 2008

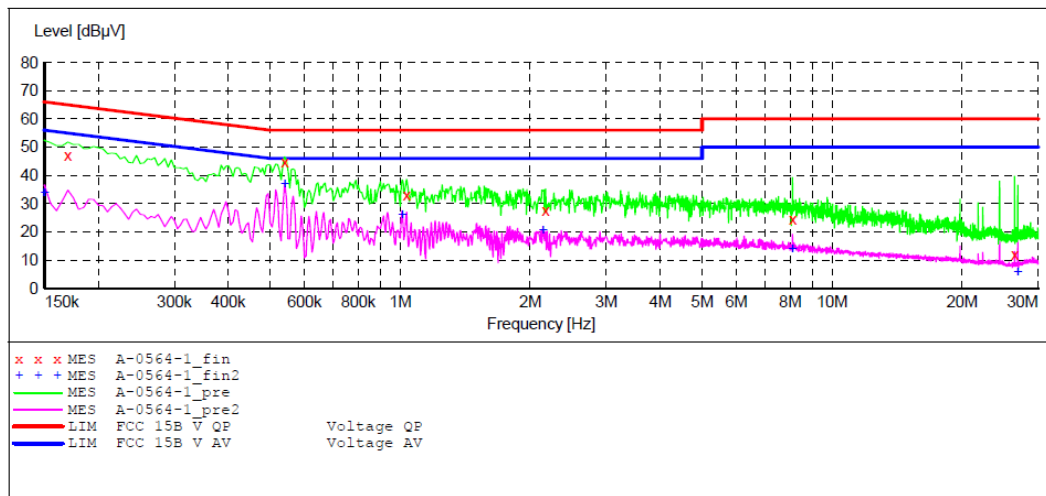

MEASUREMENT RESULT: "A-0564-1\_fin"

5/7/2019 9:42AM

Frequency MHz	Level dBµV	Transd dB	Limit dBµV	Margin dB	Detector	Line	PE
0.170000	47.10	10.5	65	17.9	QP	N	GND
0.540000	44.60	10.7	56	11.4	QP	N	GND
1.035000	33.10	10.9	56	22.9	QP	N	GND
2.170000	27.40	11.0	56	28.6	QP	N	GND
8.100000	24.30	11.2	60	35.7	QP	N	GND
26.470000	11.80	11.5	60	48.2	QP	N	GND

MEASUREMENT RESULT: "A-0564-1\_fin2"

5/7/2019 9:42AM

Frequency MHz	Level dBµV	Transd dB	Limit dBµV	Margin dB	Detector	Line	PE
0.150000	33.70	10.5	56	22.3	AV	N	GND
0.540000	36.80	10.7	46	9.2	AV	N	GND
1.010000	26.10	10.8	46	19.9	AV	N	GND
2.140000	20.50	11.0	46	25.5	AV	N	GND
8.100000	13.80	11.2	50	36.2	AV	N	GND
26.935000	5.70	11.5	50	44.3	AV	N	GND

## 6. DUTY CYCLE MEASUREMENT

### 6.1. Block Diagram of Test Setup

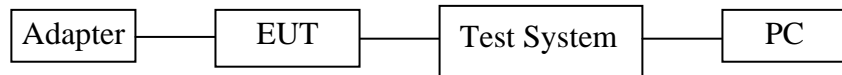

### 6.2. EUT Configuration on Measurement

The equipment are installed on the emission measurement to meet the commission requirements and operating regulations in a manner which tends to maximize its emission characteristics in normal application.

### 6.3. Operating Condition of EUT

6.3.1. Setup the EUT and simulator as shown as Section 6.1.

6.3.2. Turn on the power of all equipment.

6.3.3. Let the EUT work in TX modes measure it. The transmit frequency are 2412-2462 . We select 2412MHz, 2437MHz, 2462MHz frequency to transmit.

### 6.4. Test Procedure

Measurements of duty cycle and transmission duration shall be performed using one of the following techniques:

1. A diode detector and an oscilloscope that together have sufficiently short response time to permit accurate measurements of the on- and off-times of the transmitted signal.
2. The zero-span mode on a spectrum analyzer or EMI receiver if the response time and spacing between bins on the sweep are sufficient to permit accurate measurements of the on- and off-times of the transmitted signal
  - a. Set the center frequency of the instrument to the centre frequency of the transmission
  - b. Set  $RBW \geq OBW$  if possible; otherwise, set RBW to the largest available value(10MHz).
  - c. Set detector = Peak or average.
  - d. The zero-span measurement method shall not be used unless both RBW and VBW are  $> 50/T$  and the number of sweep points across duration T exceeds 100.  
(For example, if VBW and/or RBW are limited to 3MHz, then the zero-span method of measuring duty cycle shall not be used if  $T \leq 16.7$  microseconds.)



## 6.5. Test Result

Test Lab: Shielding room  
Test Engineer: Frank

The test was performed with 802.11b			
Channel	Frequency (MHz)	duty cycle(x)	10log(1/x)
Middle	2437	100%	0

The test was performed with 802.11g			
Channel	Frequency (MHz)	duty cycle(x)	10log(1/x)
Middle	2437	100%	0

The test was performed with 802.11n (Bandwidth: 20 MHz)			
Channel	Frequency (MHz)	duty cycle(x)	10log(1/x)
Middle	2437	100%	0

Note: We tested 802.11b/g/n mode the all data rate and recorded the worst case data for this channel to be 1Mbps for 802.11b mode and 6Mbps for 802.11g mode and MCS0 for 802.11n mode.

The spectrum analyzer plots are attached as below.

### 802.11b Channel Middle 2437MHz

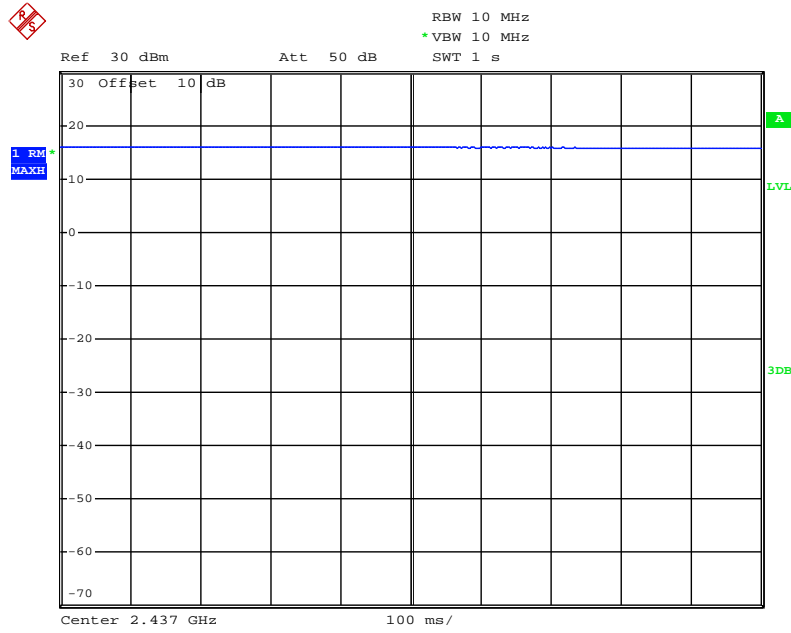

Date: 14.MAY.2019 16:40:46

### 802.11g Channel Middle 2437MHz

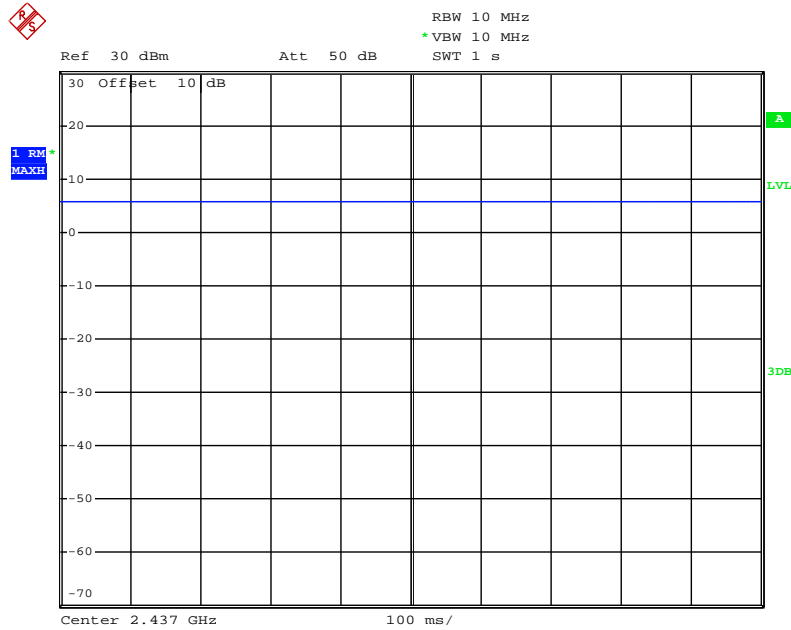

Date: 14.MAY.2019 16:42:12

802.11n Channel Middle 2437MHz(20MHz)

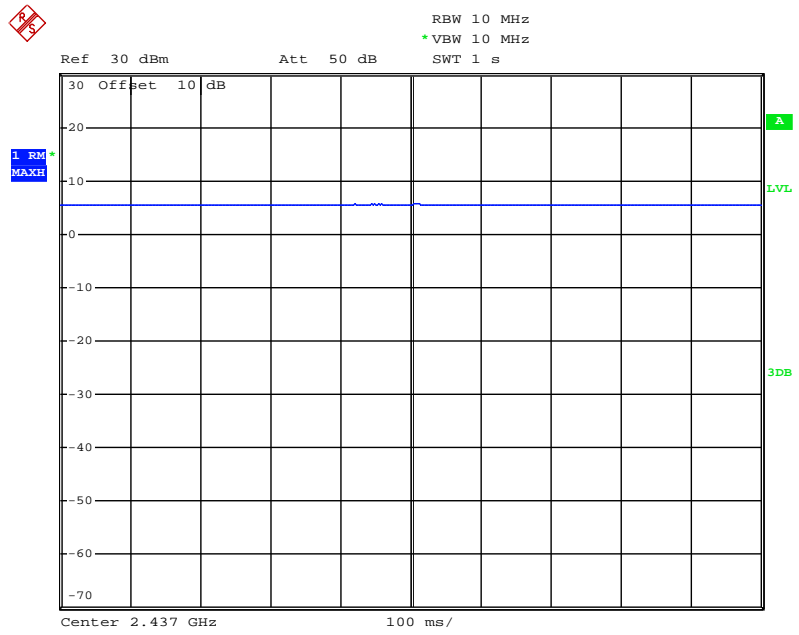

Date: 14.MAY.2019 16:43:11

## 7. 6DB BANDWIDTH MEASUREMENT

### 7.1. Block Diagram of Test Setup

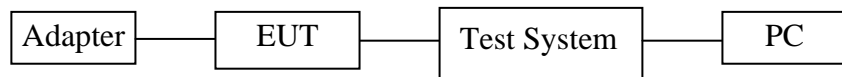

### 7.2. The Requirement For Section 15.247(a)(2)

Section 15.247(a)(2): Systems using digital modulation techniques may operate in the 902-928MHz, 2400-2483.5MHz, and 5725-5850MHz bands. The minimum 6 dB bandwidth shall be at least 500 kHz.

### 7.3. EUT Configuration on Measurement

The equipment are installed on the emission measurement to meet the commission requirements and operating regulations in a manner which tends to maximize its emission characteristics in normal application.

### 7.4. Operating Condition of EUT

7.4.1. Setup the EUT and simulator as shown as Section 7.1.

7.4.2. Turn on the power of all equipment.

7.4.3. Let the EUT work in TX modes measure it. The transmit frequency are 2412-2462 . We select 2412MHz, 2437MHz, 2462MHz frequency to transmit.

### 7.5. Test Procedure

1. Set resolution bandwidth (RBW) = 100 kHz.
2. Set the video bandwidth (VBW)  $\geq 3 \times$  RBW.
3. Detector = Peak.
4. Trace mode = max hold.
5. Sweep = auto couple.
6. Allow the trace to stabilize.
7. Measure the maximum width of the emission that is constrained by the frequencies associated with the two outermost amplitude points (upper and lower) that are attenuated by 6 dB relative to the maximum level measured in the fundamental emission.

### 7.6. Test Result

Test Lab: Shielding room

Test Engineer: Frank

The test was performed with 802.11b			
Channel	Frequency (MHz)	6dB Bandwidth (MHz)	Limit (MHz)
Low	2412	9.43	> 0.5MHz
Middle	2437	9.52	> 0.5MHz
High	2462	9.52	> 0.5MHz

The test was performed with 802.11g			
Channel	Frequency (MHz)	6dB Bandwidth (MHz)	Limit (MHz)
Low	2412	16.64	> 0.5MHz
Middle	2437	16.60	> 0.5MHz
High	2462	16.64	> 0.5MHz

The test was performed with 802.11n (Bandwidth: 20 MHz)			
Channel	Frequency (MHz)	6dB Bandwidth (MHz)	Limit (MHz)
Low	2412	17.84	> 0.5MHz
Middle	2437	17.84	> 0.5MHz
High	2462	17.84	> 0.5MHz

Note: We tested 802.11b/g/n mode the all data rate and recorded the worst case data for this channel to be 1Mbps for 802.11b mode and 6Mbps for 802.11g mode and MCS0 for 802.11n mode.

The spectrum analyzer plots are attached as below.

### 802.11b Channel Low 2412MHz

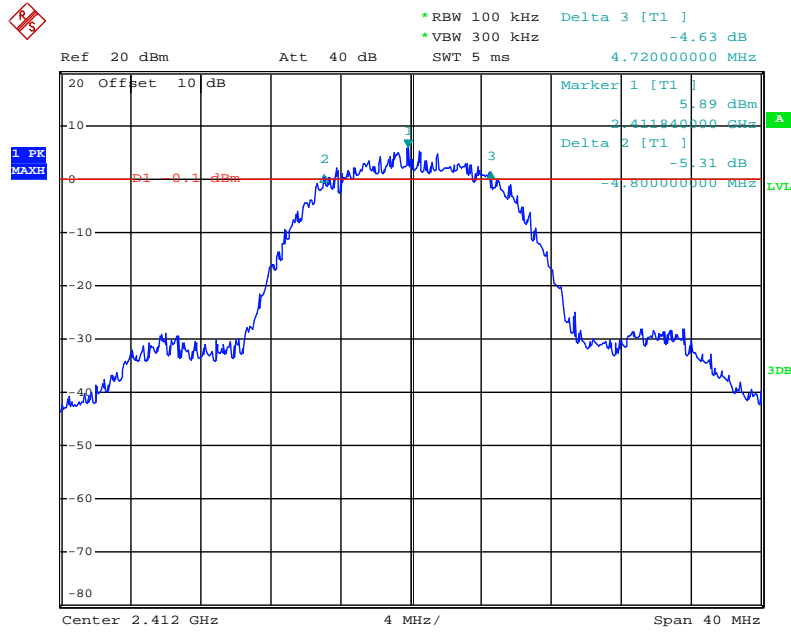

Date: 13.MAY.2019 17:11:43

### 802.11b Channel Middle 2437MHz

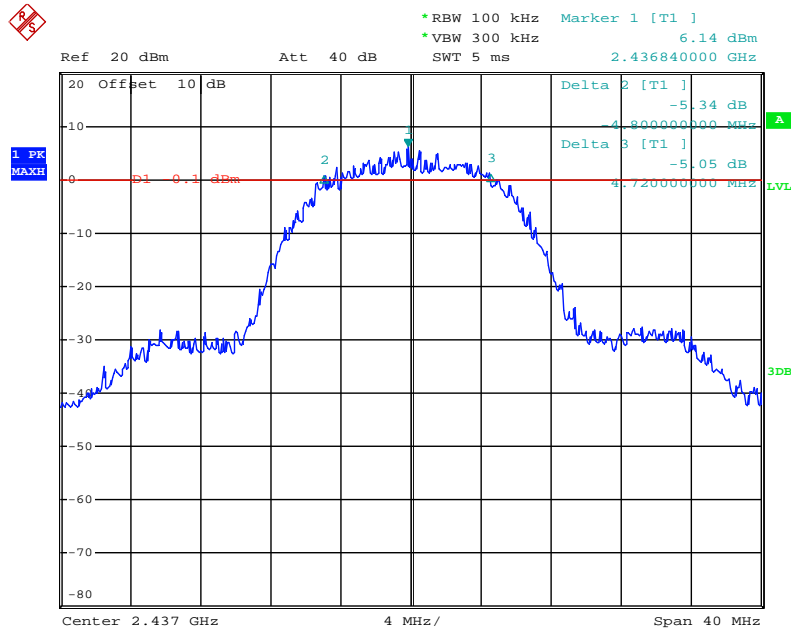

Date: 13.MAY.2019 17:12:54

### 802.11b Channel High 2462MHz

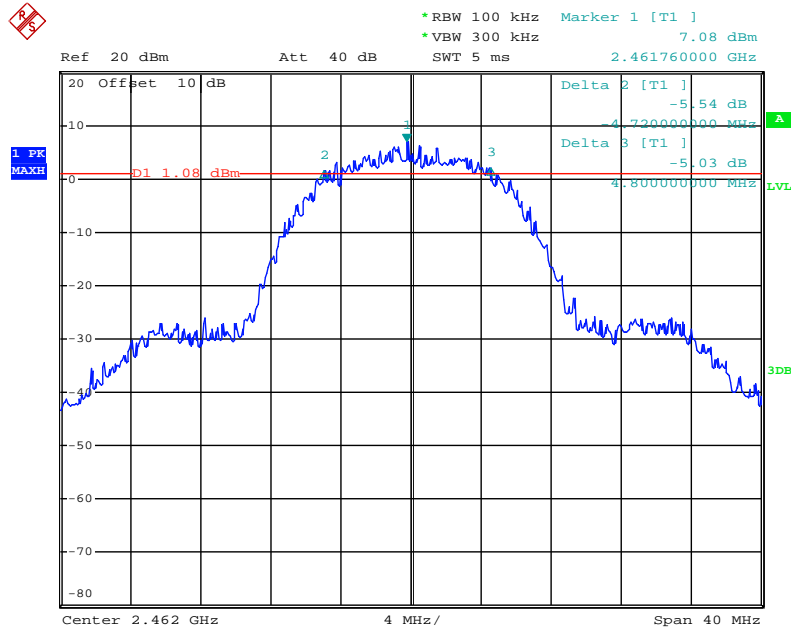

Date: 13.MAY.2019 17:14:01

### 802.11g Channel Low 2412MHz

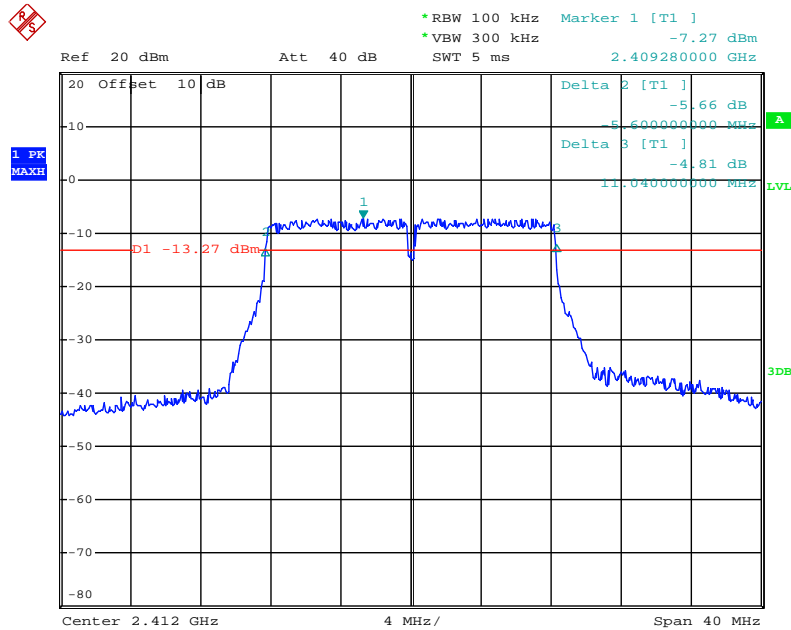

Date: 13.MAY.2019 17:18:52

### 802.11g Channel Middle 2437MHz

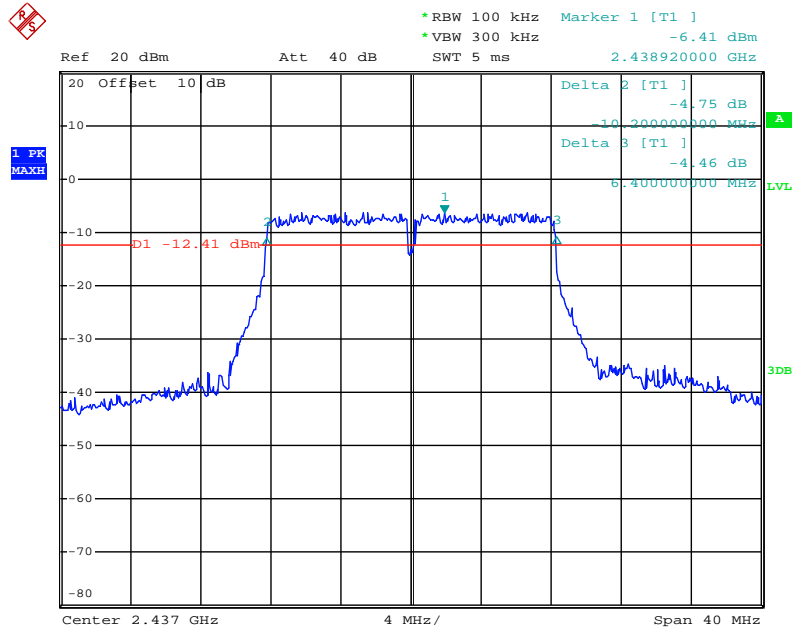

Date: 13.MAY.2019 17:17:33

### 802.11g Channel High 2462MHz

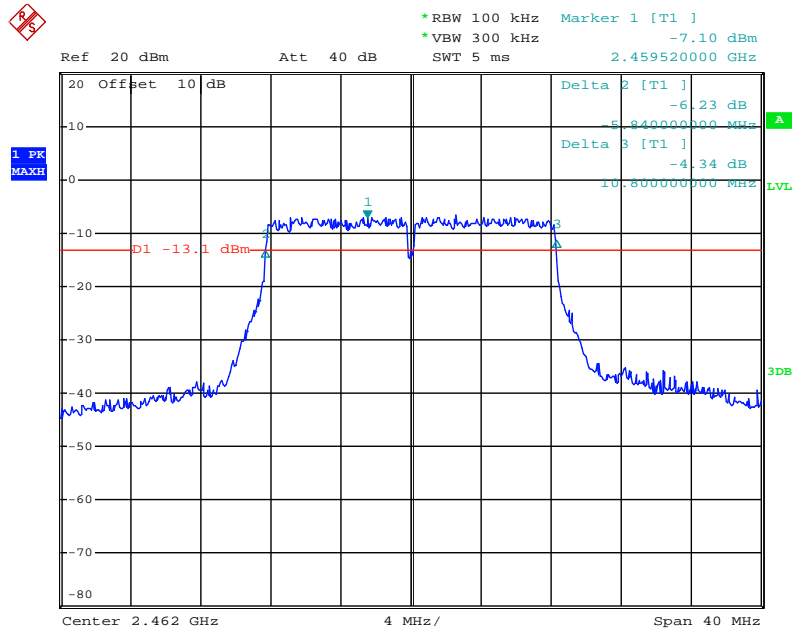

Date: 13.MAY.2019 17:15:40



### 802.11n Channel Low 2412MHz (20MHz)

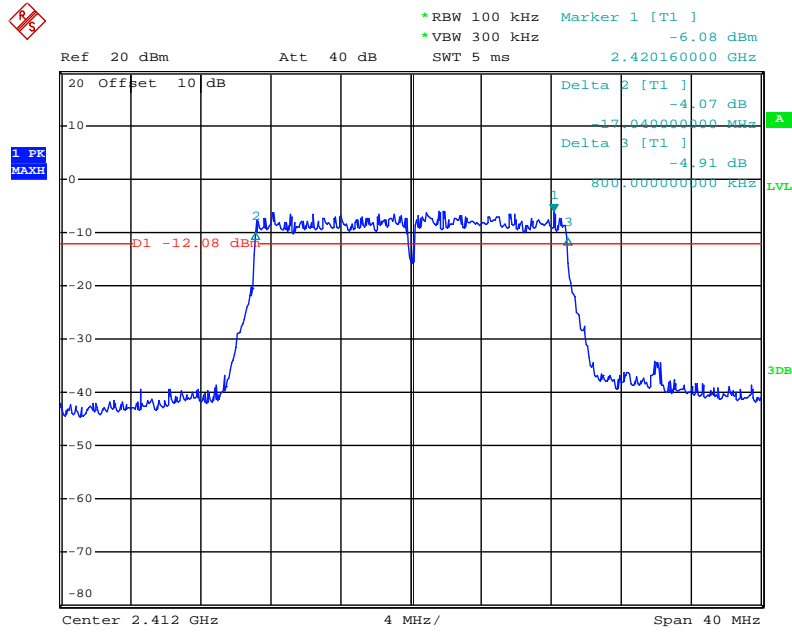

### 802.11n Channel Middle 2437MHz(20MHz)

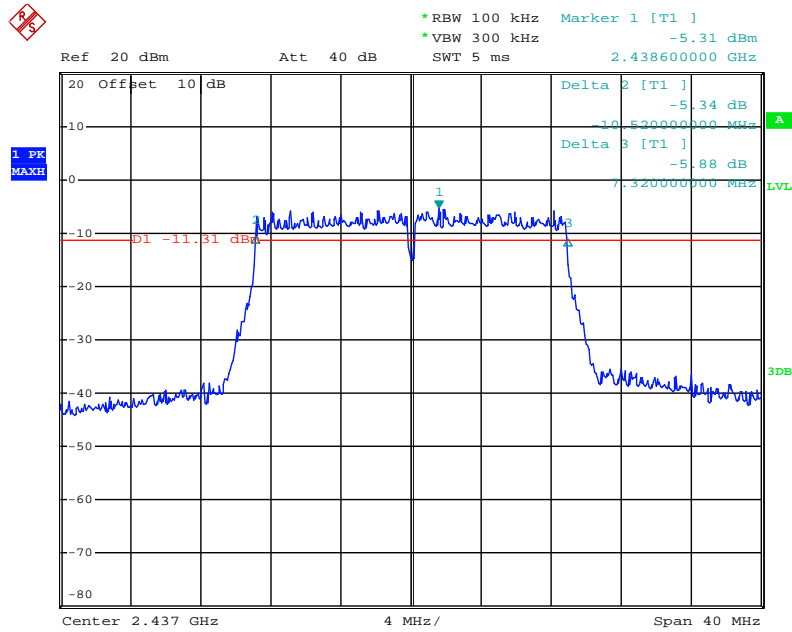

Date: 13.MAY.2019 17:21:12



## 8. 99% OCCUPIED BANDWIDTH

### 8.1. Block Diagram of Test Setup

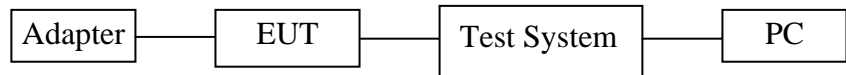

### 8.2. The Requirement For ANSI C63.10: 2013 Section 6.9.3

ANSI C63.10: 2013 Section 6.9.3: The occupied bandwidth is the frequency bandwidth such that, below its lower and above its upper frequency limits, the mean powers are each equal to 0.5% of the total mean power of the given emission.

### 8.3. EUT Configuration on Measurement

The following equipment is installed on the emission measurement to meet the commission requirements and operating regulations in a manner which tends to maximize its emission characteristics in normal application.

### 8.4. Operating Condition of EUT

8.4.1. Setup the EUT and simulator as shown as Section 8.1.

8.4.2. Turn on the power of all equipment.

8.4.3. Let the EUT work in TX modes measure it. The transmit frequency are 2412-2462 . We select 2412MHz, 2437MHz, 2462MHz frequency to transmit.

## 8.5. Test Procedure

- 8.5.1. The transmitter output was connected to the spectrum analyzer through a low loss cable. The transmitter shall be operated at its maximum carrier power measured under normal test conditions. The span of the analyzer shall be set to capture all products of the modulation process, including the emission skirts.
- 8.5.2. The resolution bandwidth (RBW) shall be in the range of 1% to 5% of the occupied bandwidth (OBW) and video bandwidth (VBW) shall be approximately 3x RBW.
- 8.5.3. A peak, or peak hold, may be used in place of the sampling detector as this may produce a wider bandwidth than the actual bandwidth (worst-case measurement). Use of a peak hold may be necessary to determine the occupied bandwidth if the device is not transmitting continuously.
- 8.5.4. Set SPA "Meas" function, Select "Occupied Bandwidth" function, Select "99% Power Bandwidth". The frequency of the upper and lower markers indicating the edges of the transmitters "99% Power" emission bandwidth shall be recorded to automate by SPA.

## 8.6.Measurement Result

Test Lab: Shielding room  
Test Engineer: Frank

The test was performed with 802.11b		
Channel	Frequency (MHz)	99% Occupied Bandwidth (MHz)
Low	2412	13.84
Middle	2437	13.84
High	2462	13.92

The test was performed with 802.11g		
Channel	Frequency (MHz)	99% Occupied Bandwidth (MHz)
Low	2412	16.96
Middle	2437	16.96
High	2462	16.96

The test was performed with 802.11n (Bandwidth: 20 MHz)		
Channel	Frequency (MHz)	99% Occupied Bandwidth (MHz)
Low	2412	17.92
Middle	2437	18.00
High	2462	17.92

Note: We tested 802.11b/g/n mode the all data rate and recorded the worst case data for this channel to be 1Mbps for 802.11b mode and 6Mbps for 802.11g mode and MCS0 for 802.11n mode.

The spectrum analyzer plots are attached as below.

### 802.11b Channel Low 2412MHz

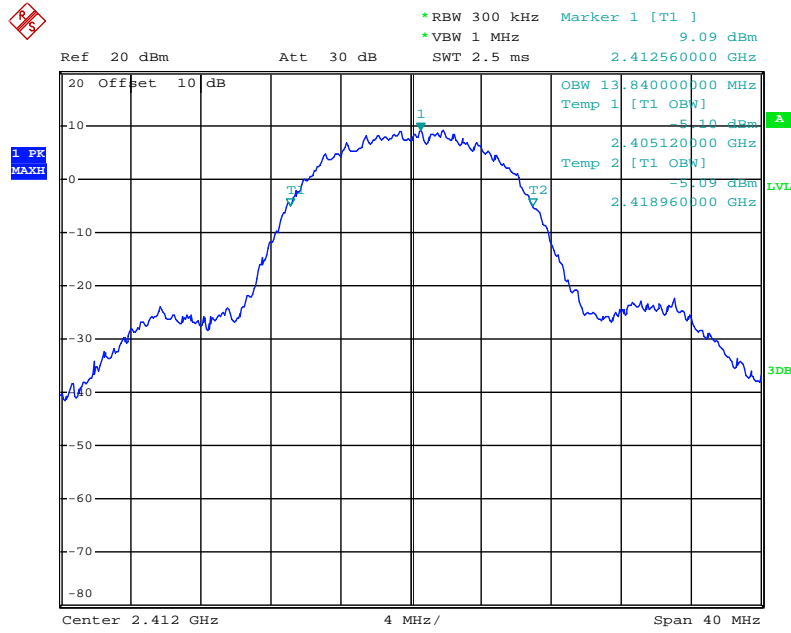

Date: 13.MAY.2019 17:30:25

### 802.11b Channel Middle 2437MHz

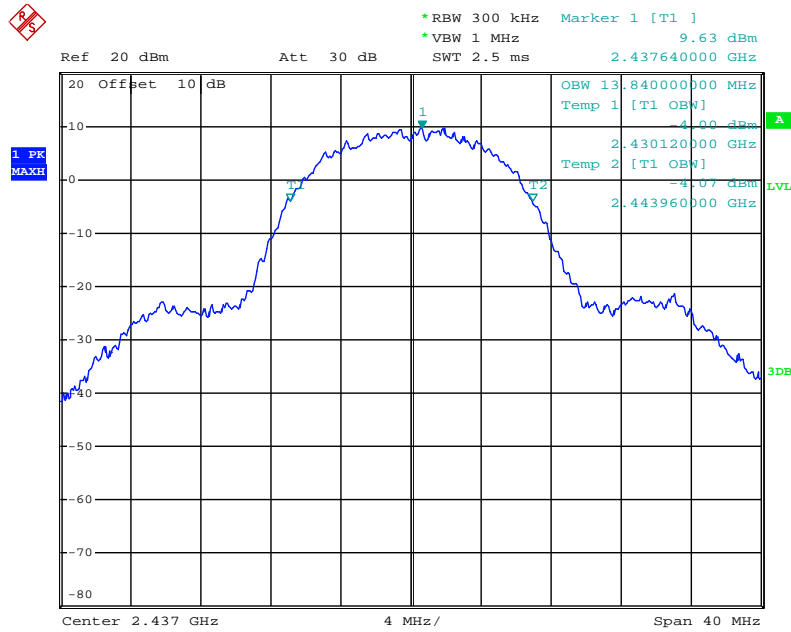

Date: 13.MAY.2019 17:29:48

### 802.11b Channel High 2462MHz

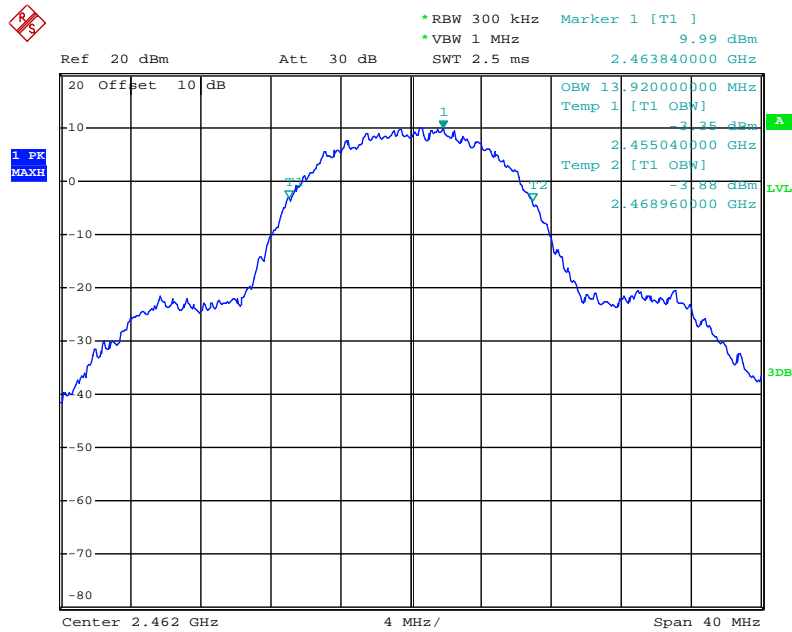

Date: 13.MAY.2019 17:29:15

### 802.11g Channel Low 2412MHz

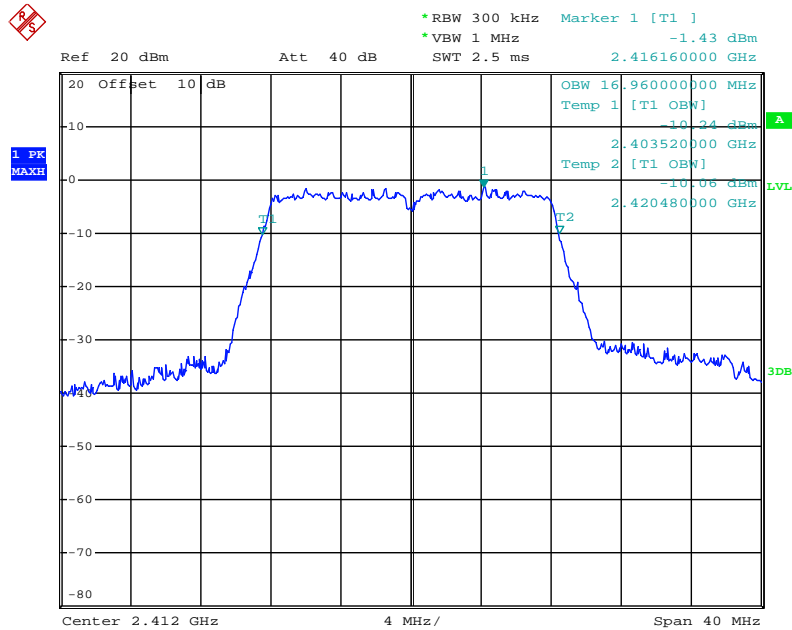

Date: 13.MAY.2019 17:27:09

### 802.11g Channel Middle 2437MHz

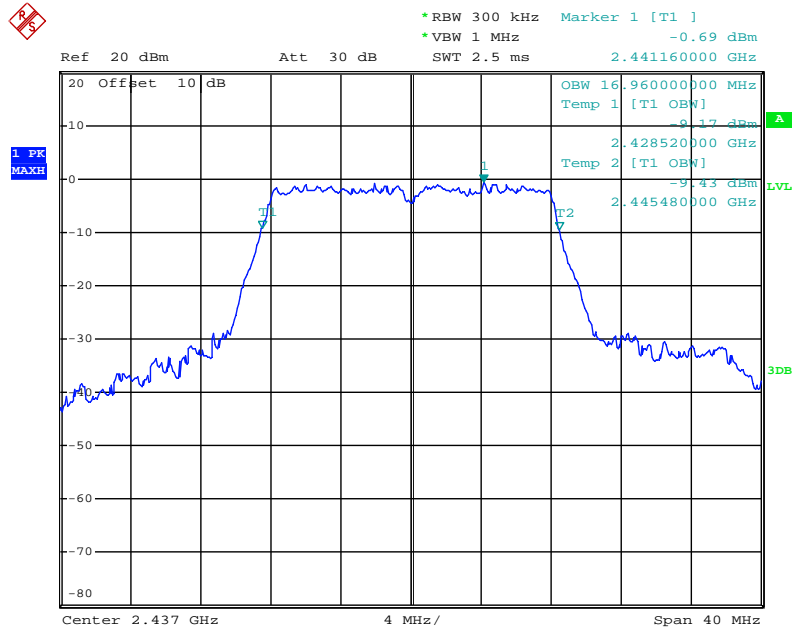

Date: 13.MAY.2019 17:27:55

### 802.11g Channel High 2462MHz

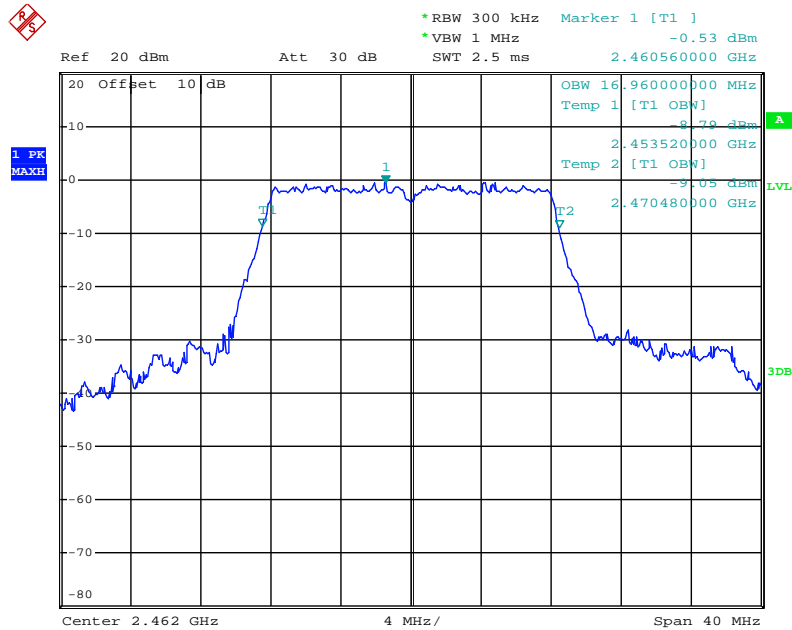

Date: 13.MAY.2019 17:28:33



### 802.11n Channel Low 2412MHz (20MHz)

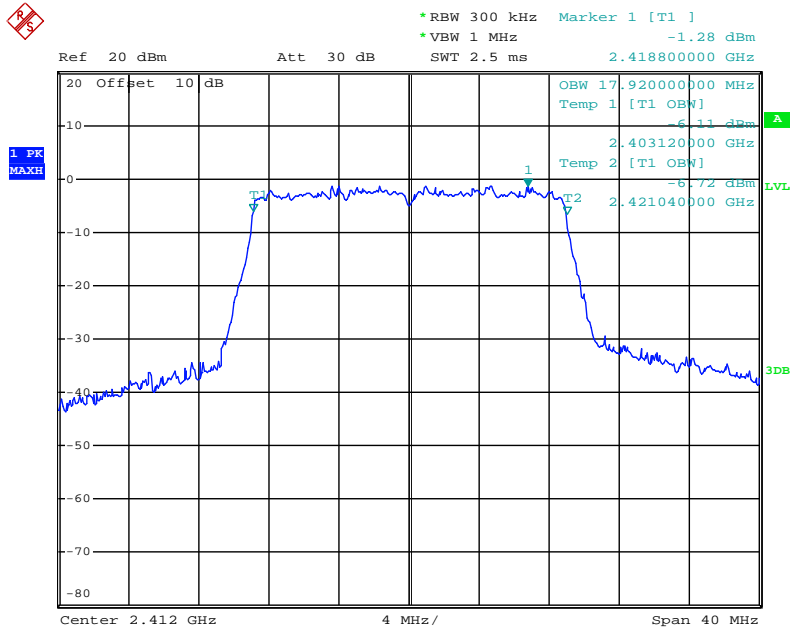

Date: 13.MAY.2019 17:26:29

### 802.11n Channel Middle 2437MHz(20MHz)

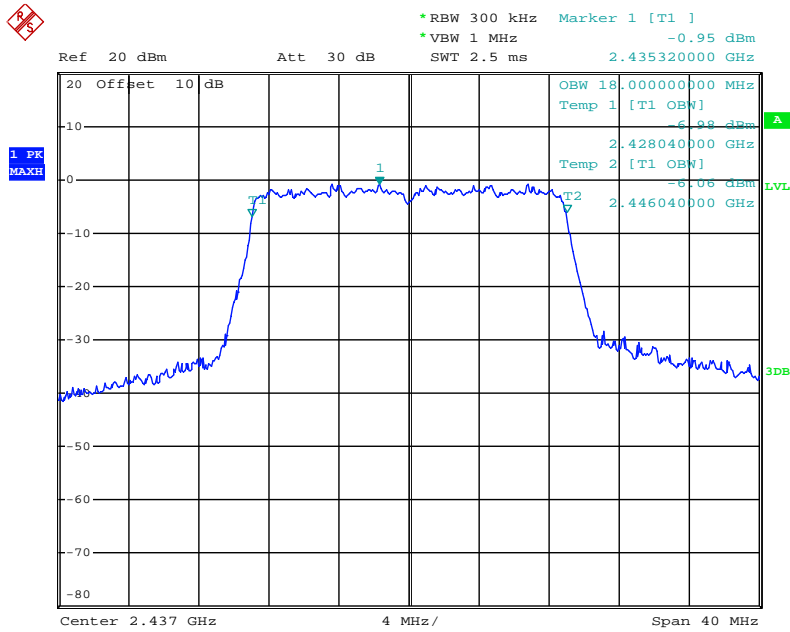

Date: 13.MAY.2019 17:25:52

### 802.11n Channel High 2462MHz(20MHz)

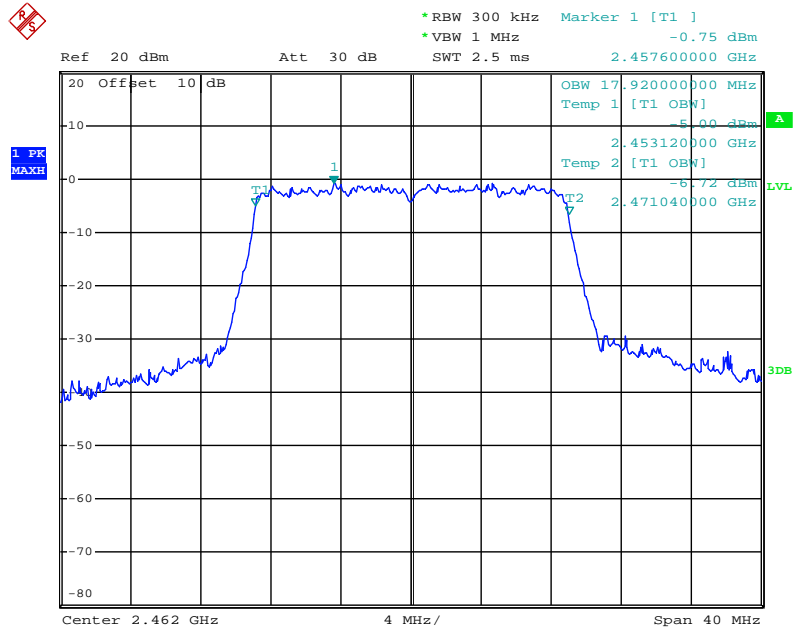

Date: 13.MAY.2019 17:23:11

## 9. MAXIMUM CONDUCTED (AVERAGE) OUTPUT POWER

### 9.1. Block Diagram of Test Setup

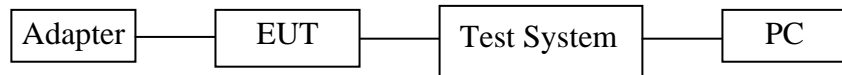

### 9.2. The Requirement For Section 15.247(b)(3)

Section 15.247(b)(3): For systems using digital modulation in the 902-928MHz, 2400-2483.5MHz, and 5725-5850MHz bands: 1 Watt.

### 9.3. EUT Configuration on Measurement

The equipment is installed on the emission Measurement to meet the commission requirements and operating regulations in a manner which tends to maximize its emission characteristics in normal application.

### 9.4. Operating Condition of EUT

9.4.1. Setup the EUT and simulator as shown as Section 9.1.

9.4.2. Turn on the power of all equipment.

9.4.3. Let the EUT work in TX modes measure it. The transmit frequency are 2412-2462 . We select 2412MHz, 2437MHz, 2462MHz frequency to transmit.

### 9.5. Test Procedure

9.5.1. The EUT was tested according to DTS test procedure of Apr 05, 2017 KDB5580 74 v05r02 D01 DTS Meas Guidance v04 for compliance to FCC 47CFR 15.247 requirements.

9.5.2. The transmitter output was connected to the spectrum analyzer through a low loss cable.

9.5.3. Set RBW = 1-5% of the OBW, not to exceed 1 MHz, VBW  $\geq$  3 x RBW, Sweep time = auto, Set span to at least 1.5 times the OBW, Detector = RMS.

9.5.4. Measurement the Maximum conducted (average) output power.

### 9.6. Test Result

Test Lab: Shielding room

Test Engineer: Frank

Final power= Ave output power+10log(1/ duty cycle)

The test was performed with 802.11b						
Channel	Frequency (MHz)	Ave output power (dBm)	10log(1/ duty cycle)	Final power (dBm)	Final power (W)	Limits dBm / W
Low	2412	19.38	0	19.38	0.0867	30 dBm / 1 W
Middle	2437	18.88	0	18.88	0.0773	30 dBm / 1 W
High	2462	19.77	0	19.77	0.0948	30 dBm / 1 W

The test was performed with 802.11g						
Channel	Frequency (MHz)	Ave output power (dBm)	10log(1/ duty cycle)	Final power (dBm)	Final power (W)	Limits dBm / W
Low	2412	10.45	0	10.45	0.0111	30 dBm / 1 W
Middle	2437	11.02	0	11.02	0.0126	30 dBm / 1 W
High	2462	11.19	0	11.19	0.0132	30 dBm / 1 W

The test was performed with 802.11n (20MHz)						
Channel	Frequency (MHz)	Ave output power (dBm)	10log(1/ duty cycle)	Final power (dBm)	Final power (W)	Limits dBm / W
Low	2412	10.60	0	10.60	0.0115	30 dBm / 1 W
Middle	2437	13.06	0	13.06	0.0202	30 dBm / 1 W
High	2462	12.05	0	12.05	0.0160	30 dBm / 1 W

Note: We tested 802.11b/g/n mode the all data rate and recorded the worst case data for this channel to be 1Mbps for 802.11b mode and 6Mbps for 802.11g mode and MCS0 for 802.11n mode.

The spectrum analyzer plots are attached as below.

### 802.11b Channel Low 2412MHz

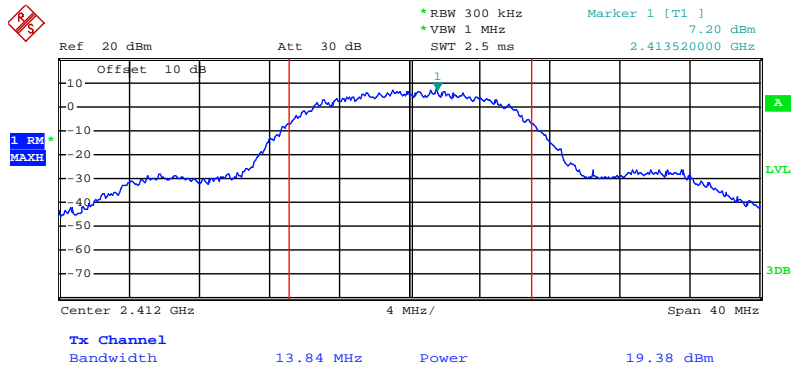

### 802.11b Channel Middle 2437MHz

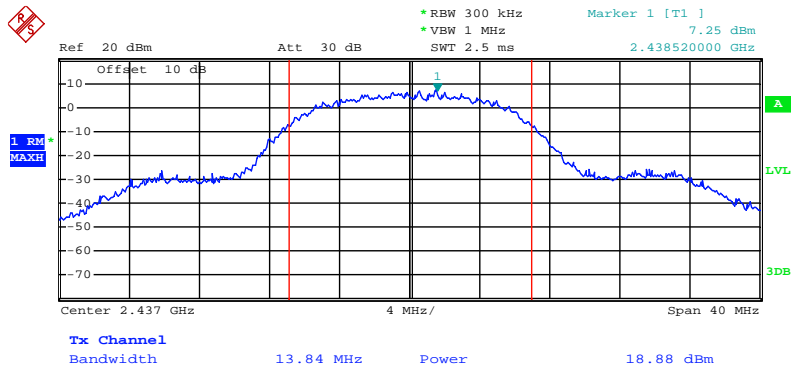

Date: 13.MAY.2019 17:57:11

### 802.11b Channel High 2462MHz

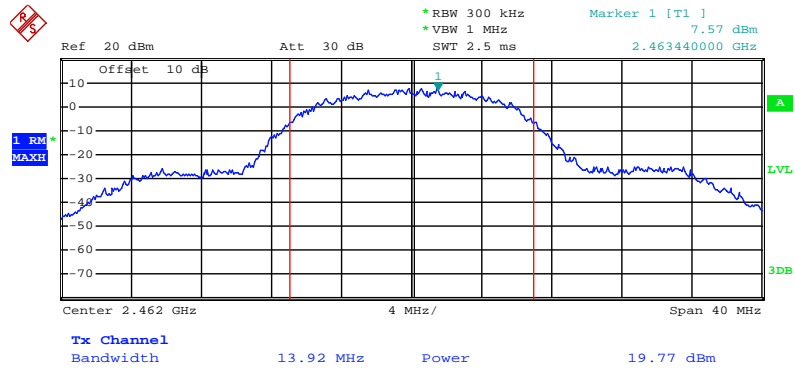

Date: 13.MAY.2019 17:57:53

### 802.11g Channel Low 2412MHz

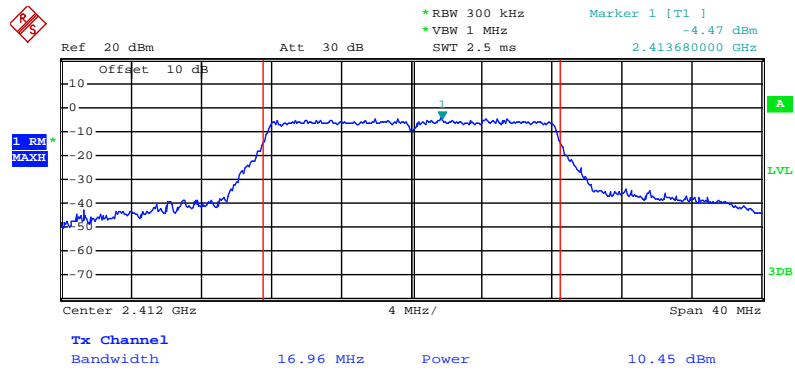

Date: 13.MAY.2019 18:02:02

### 802.11g Channel Middle 2437MHz

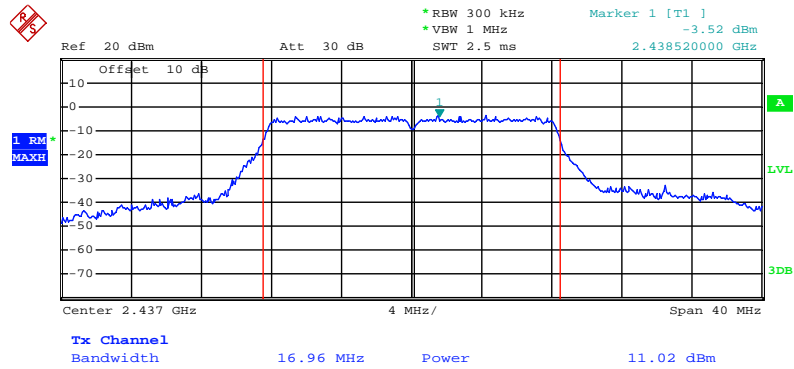

Date: 13.MAY.2019 18:00:51

### 802.11g Channel High 2462MHz

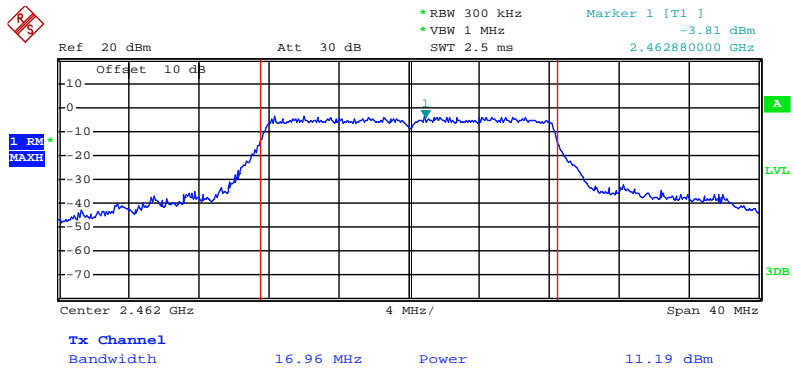

Date: 13.MAY.2019 17:59:17

### 802.11n Channel Low 2412MHz (20MHz)

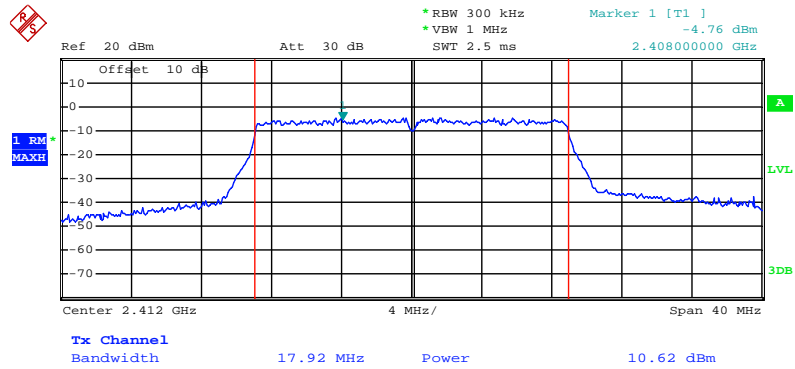

Date: 13.MAY.2019 18:02:54

### 802.11n Channel Middle 2437MHz (20MHz)

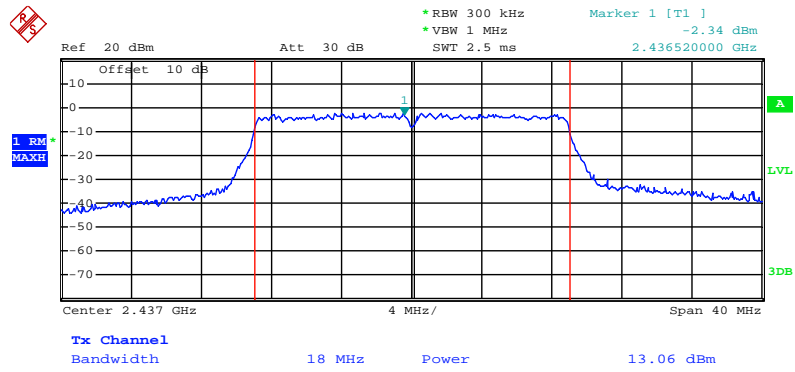

Date: 13.MAY.2019 18:03:39



### 802.11n Channel High 2462MHz (20MHz)

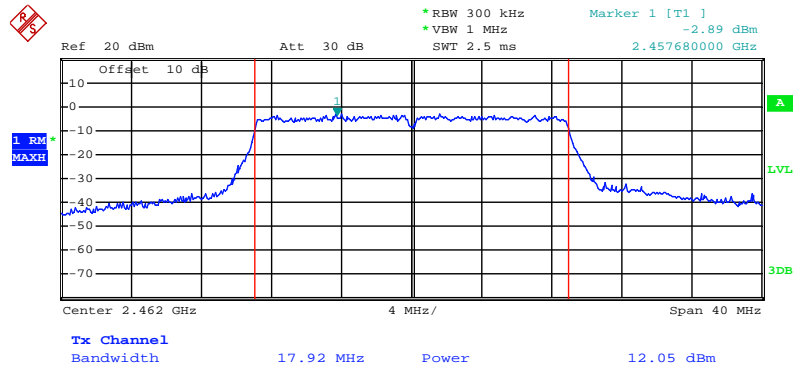

Date: 13.MAY.2019 18:04:26

## 10. POWER SPECTRAL DENSITY MEASUREMENT

### 10.1. Block Diagram of Test Setup



### 10.2. The Requirement For Section 15.247(e)

Section 15.247(e): For digitally modulated systems, the power spectral density conducted from the intentional radiator to the antenna shall not be greater than 8 dBm in any 3 kHz band during any time interval of continuous transmission.

### 10.3. EUT Configuration on Measurement

The equipment are installed on the emission Measurement to meet the commission requirements and operating regulations in a manner which tends to maximize its emission characteristics in normal application.

### 10.4. Operating Condition of EUT

10.4.1. Setup the EUT and simulator as shown as Section 10.1.

10.4.2. Turn on the power of all equipment.

10.4.3. Let the EUT work in TX modes measure it. The transmit frequency are 2412-2462 . We select 2412MHz, 2437MHz, 2462MHz frequency to transmit.

## 10.5. Test Procedure

10.5.1. The transmitter output was connected to the spectrum analyzer through a low loss cable.

### 10.5.2. Measurement Procedure AVGPSD-2:

This procedure is applicable when the EUT cannot be configured to transmit continuously (i.e., duty cycle < 98%), and when sweep triggering/signal gating cannot be used to measure only when the EUT is transmitting at its maximum power control level, and when the transmission duty is constant (i.e., duty cycle variations are less than  $\pm 2\%$ ):

Measure the duty cycle(x) of the transmitter output signal as described in Section 6.0.

Set instrument center frequency to DTS channel center frequency.

Set span to at least  $1.5 \times \text{OBW}$ .

Set RBW to:  $3\text{kHz} \leq \text{RBW} \leq 100\text{kHz}$ .

Set VBW  $\geq 3 \times \text{RBW}$

Detector = power averaging (RMS) or sample detector (when RMS not available).

Ensure that the number of measurement points in sweep  $\geq 2 \times \text{span/RBW}$ .

Sweep time = auto couple.

Do not use sweep triggering. Allow sweep to "free run".

Employ trace averaging (RMS) mode over a minimum of 100 traces.

Use the peak maker function to determine the maximum amplitude level.

Add  $10\log(1/x)$ , where x is the duty cycle measured in step (a), to the measured PSD to compute the average PSD during the actual transmission time.

If resultant value exceeds the limit, then reduce RBW (no less than 3kHz) and repeat (note that this may require zooming in on the emission of interest and reducing the span in order to meet the minimum measurement point requirement as the RBW is reduced).

### 10.6. Test Result

Test Lab: Shielding room

Test Engineer: Frank

The test was performed with 802.11b					
Channel	Frequency (MHz)	AVG Power Spectral Density (dBm/3KHz)	10log(1/ duty cycle)	Final Power Spectral Density (dBm/3KHz)	Limits (dBm/3KHz)
Low	2412	-16.35	0	-16.35	8 dBm
Middle	2437	-15.62	0	-15.62	8 dBm
High	2462	-16.33	0	-16.33	8 dBm

The test was performed with 802.11g					
Channel	Frequency (MHz)	AVG Power Spectral Density (dBm/3KHz)	10log(1/ duty cycle)	Final Power Spectral Density (dBm/3KHz)	Limits (dBm/3KHz)
Low	2412	-26.90	0	-26.90	8 dBm
Middle	2437	-27.34	0	-27.34	8 dBm
High	2462	-26.68	0	-26.68	8 dBm

The test was performed with 802.11n (20MHz)					
Channel	Frequency (MHz)	AVG Power Spectral Density (dBm/3KHz)	10log(1/ duty cycle)	Final Power Spectral Density (dBm/3KHz)	Limits (dBm/3KHz)
Low	2412	-27.27	0	-27.27	8 dBm
Middle	2437	-26.96	0	-26.96	8 dBm
High	2462	-25.46	0	-25.46	8 dBm

Note: We tested 802.11b/g/n mode the all data rate and recorded the worst case data for this channel to be 11Mbps for 802.11b mode and 54Mbps for 802.11g mode and MCS7 for 802.11n mode.

The spectrum analyzer plots are attached as below.

### 802.11b Channel Low 2412MHz

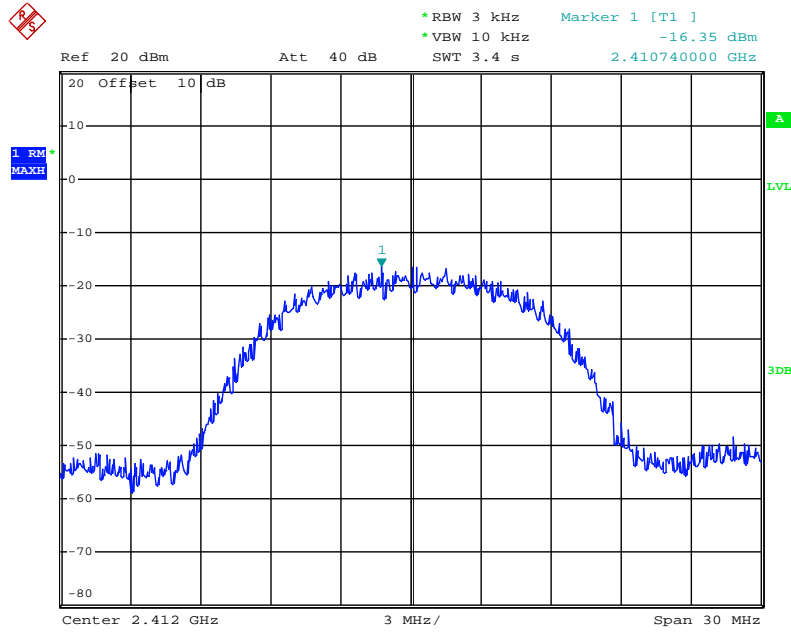

Date: 13.MAY.2019 17:33:23

### 802.11b Channel Middle 2437MHz

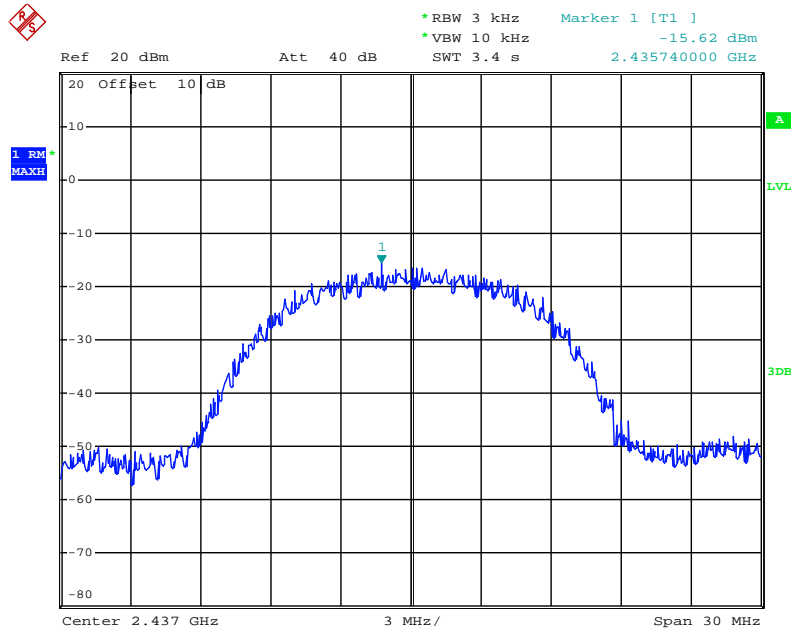

Date: 13.MAY.2019 17:34:27

### 802.11b Channel High 2462MHz

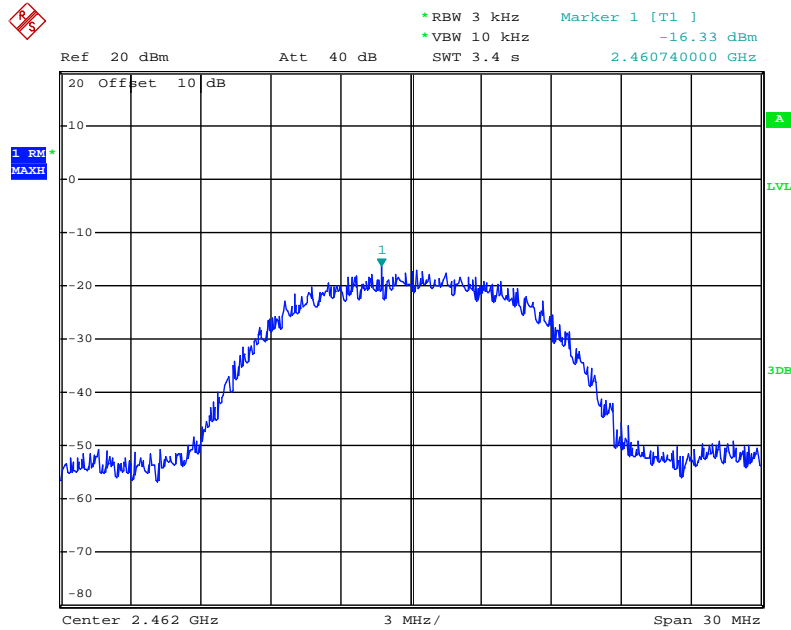

Date: 13.MAY.2019 17:34:58

### 802.11g Channel Low 2412MHz

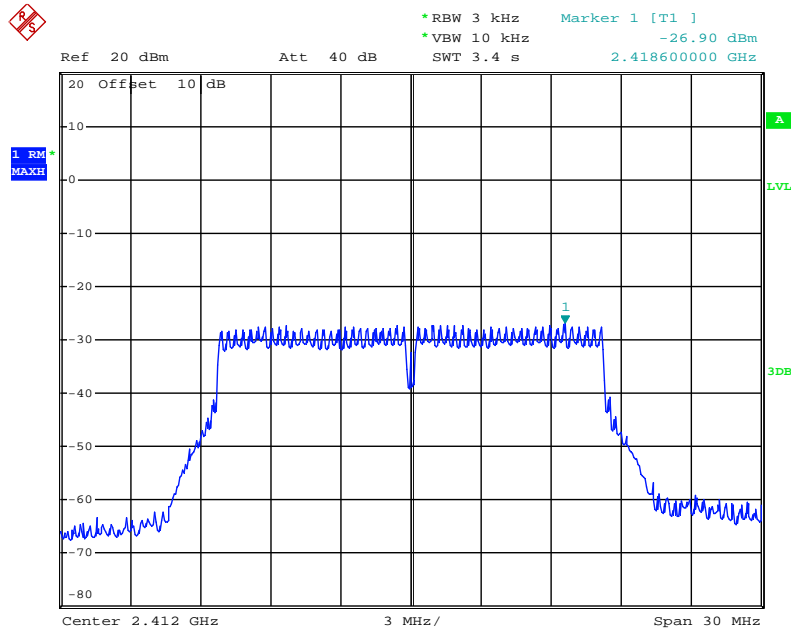

Date: 13.MAY.2019 17:36:46

### 802.11g Channel Middle 2437MHz

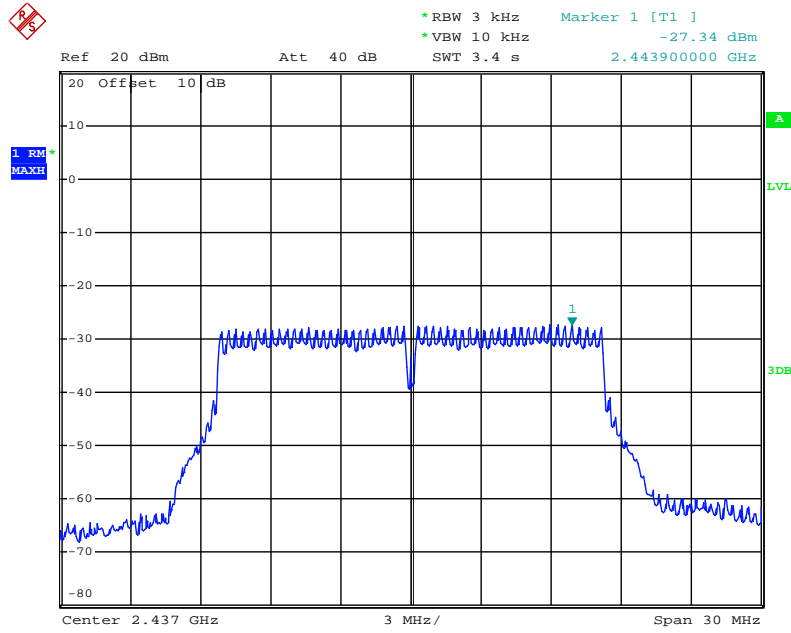

Date: 13.MAY.2019 17:36:14

### 802.11g Channel High 2462MHz

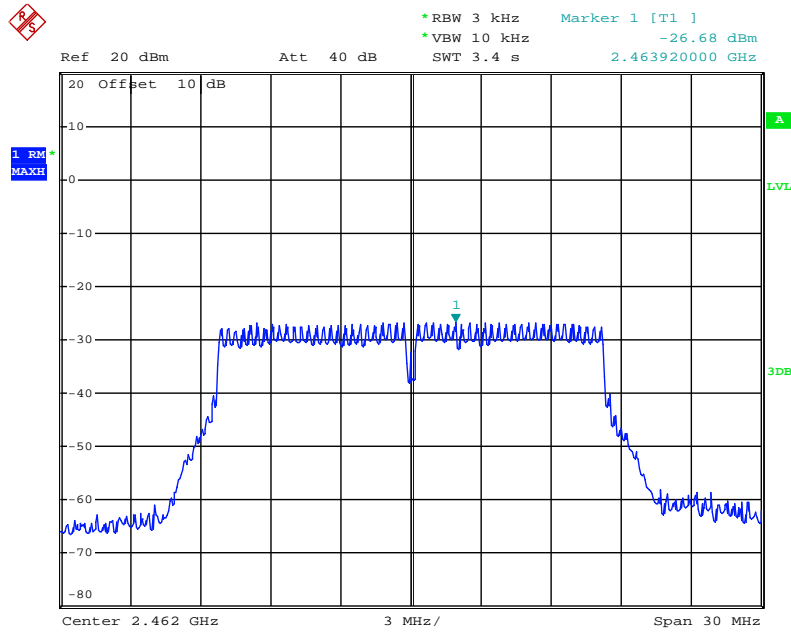

Date: 13.MAY.2019 17:35:42

### 802.11n Channel Low 2412MHz (20MHz)

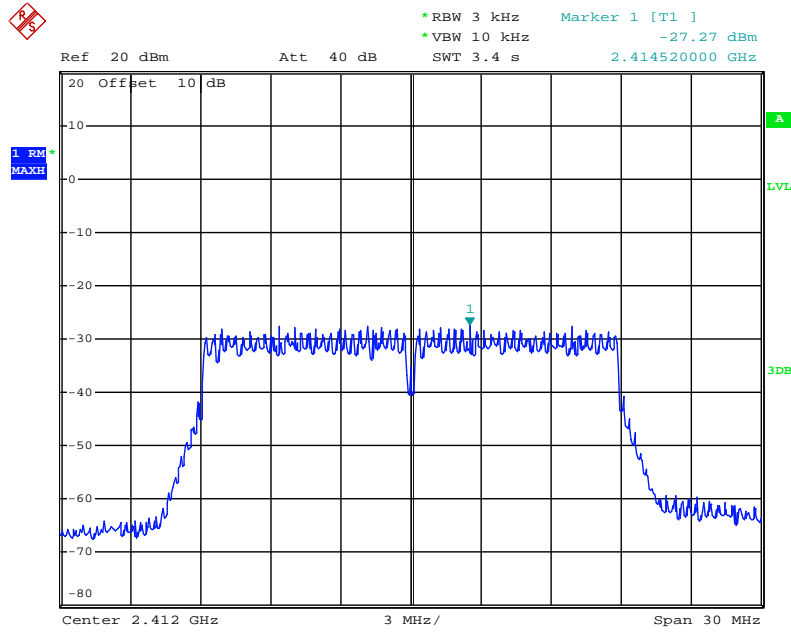

Date: 13.MAY.2019 17:37:36

### 802.11n Channel Middle 2437MHz (20MHz)

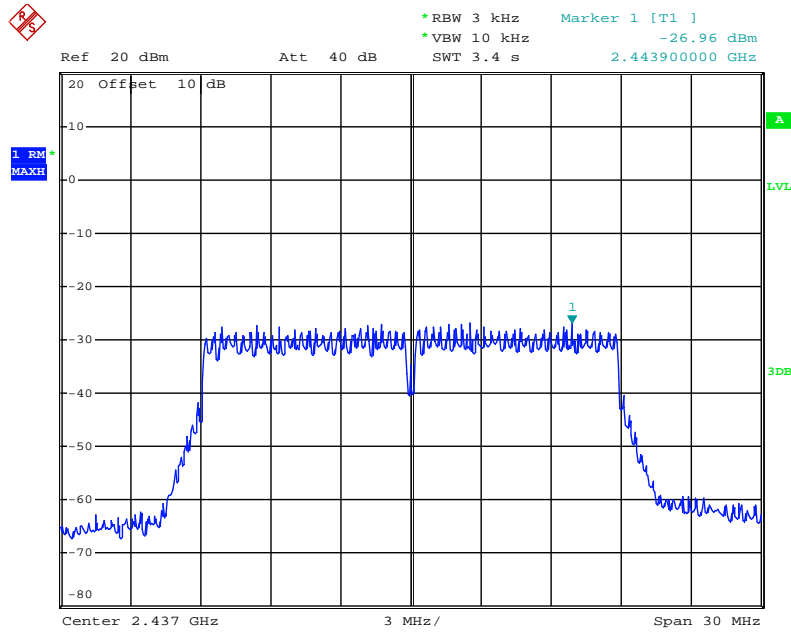

Date: 13.MAY.2019 17:38:31



802.11n Channel High 2462MHz(20MHz)

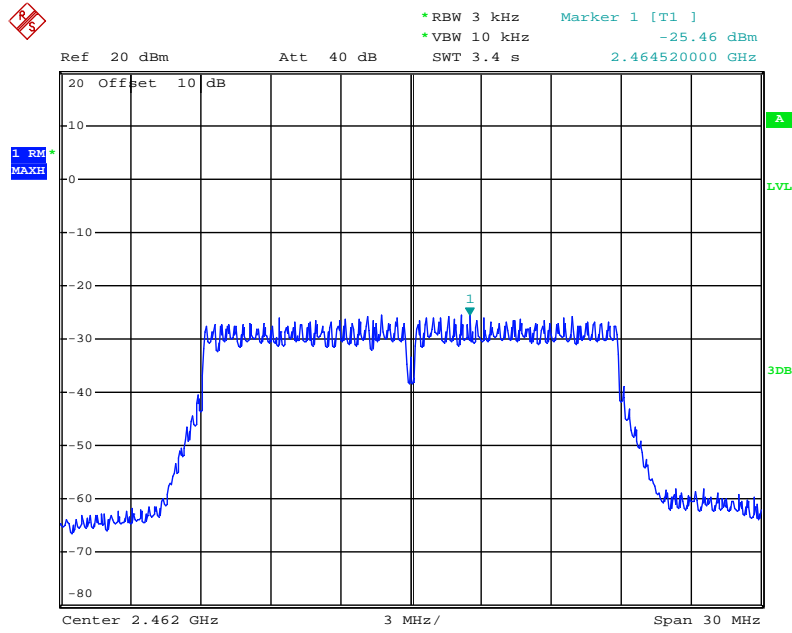

Date: 13.MAY.2019 17:39:01

## 11. BAND EDGE COMPLIANCE TEST

### 11.1. Block Diagram of Test Setup

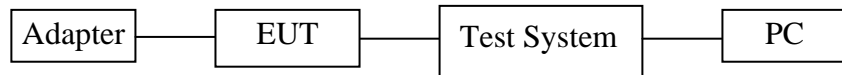

### 11.2. The Requirement For Section 15.247(d)

Section 15.247(d): In any 100 kHz bandwidth outside the frequency band in which the spread spectrum or digitally modulated intentional radiator is operating, the radio frequency power that is produced by the intentional radiator shall be at least 20 dB below that in the 100 kHz bandwidth within the band that contains the highest level of the desired power, based on either an RF conducted or a radiated measurement, provided the transmitter demonstrates compliance with the peak conducted power limits. If the transmitter complies with the conducted power limits based on the use of RMS averaging over a time interval, as permitted under paragraph (b)(3) of this section, the attenuation required under this paragraph shall be 30 dB instead of 20 dB. Attenuation below the general limits specified in Section 15.209(a) is not required. In addition, radiated emissions which fall in the restricted bands, as defined in Section 15.205(a), must also comply with the radiated emission limits specified in Section 15.209(a).

### 11.3. EUT Configuration on Measurement

The equipment are installed on the emission Measurement to meet the commission requirements and operating regulations in a manner which tends to maximize its emission characteristics in normal application.

### 11.4. Operating Condition of EUT

11.4.1. Setup the EUT and simulator as shown as Section 11.1.

11.4.2. Turn on the power of all equipment.

11.4.3. Let the EUT work in TX modes measure it. The transmit frequency are 2412-2462 MHz. We select 2412MHz, 2462MHz TX frequency to transmit.

## 11.5. Test Procedure

### **Conducted Band Edge:**

11.5.1. The transmitter output was connected to the spectrum analyzer via a low loss cable.

11.5.2. Set RBW of spectrum analyzer to 100kHz and VBW to 300kHz.

### **Radiate Band Edge:**

11.5.1. The EUT is placed on a turntable, which is 1.5m above the ground plane and worked at highest radiated power.

11.5.2. The turntable was rotated for 360 degrees to determine the position of maximum emission level.

11.5.3. EUT is set 3m away from the receiving antenna, which is varied from 1m to 4m to find out the highest emission.

11.5.4. Set the spectrum analyzer in the following setting in order to capture the lower and upper band-edges of the emission:

11.5.5. RBW=1MHz, VBW=1MHz

11.5.6. The band edges was measured and recorded.

### 11.6. Test Result

Test Lab: Shielding room

Test Engineer: Frank

The test was performed with 802.11b		
Frequency (MHz)	Result of Band Edge (dBc)	Limit of Band Edge (dBc)
2400	38.23	> 30dBc
2483.5	46.67	> 30dBc

The test was performed with 802.11g		
Frequency (MHz)	Result of Band Edge (dBc)	Limit of Band Edge (dBc)
2400	33.98	> 30dBc
2483.5	35.84	> 30dBc

The test was performed with 802.11n (20MHz)		
Frequency (MHz)	Result of Band Edge (dBc)	Limit of Band Edge (dBc)
2400	34.84	> 30dBc
2483.5	37.34	> 30dBc

Note: We tested 802.11b/g/n mode the all data rate and recorded the worst case data for this channel to be 1Mbps for 802.11b mode and 6Mbps for 802.11g mode and MCS0 for 802.11n mode.

The spectrum analyzer plots are attached as below.

### 802.11b Channel Low 2412MHz

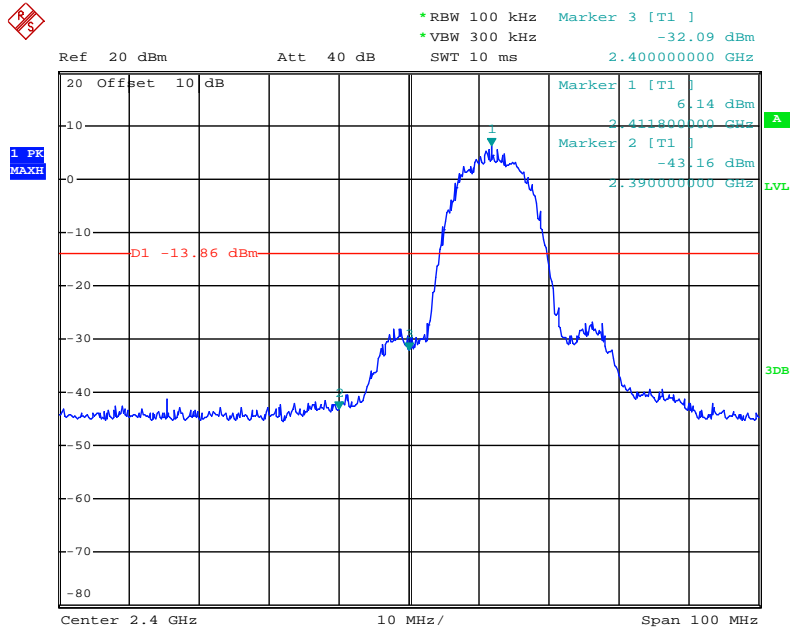

Date: 13.MAY.2019 17:47:30

### 802.11b Channel High 2462MHz

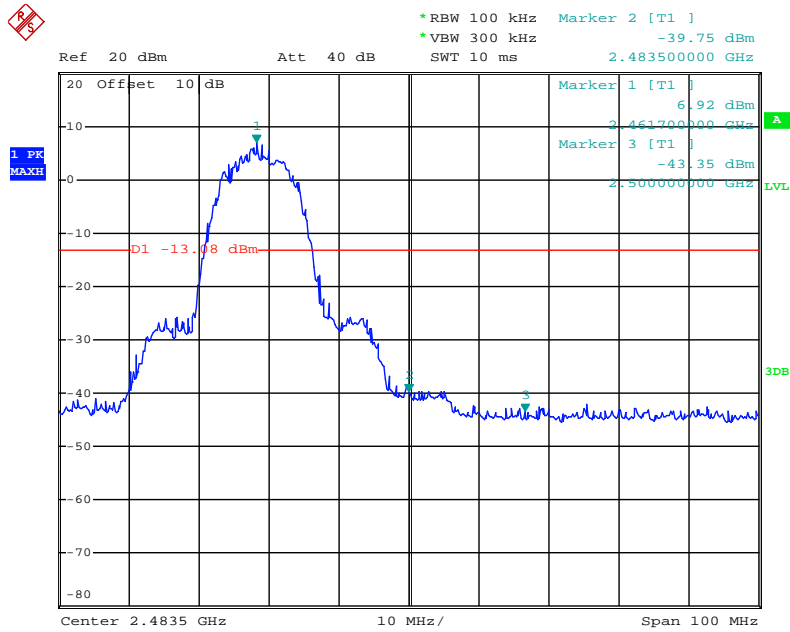

Date: 13.MAY.2019 17:46:36

### 802.11g Channel Low 2412MHz

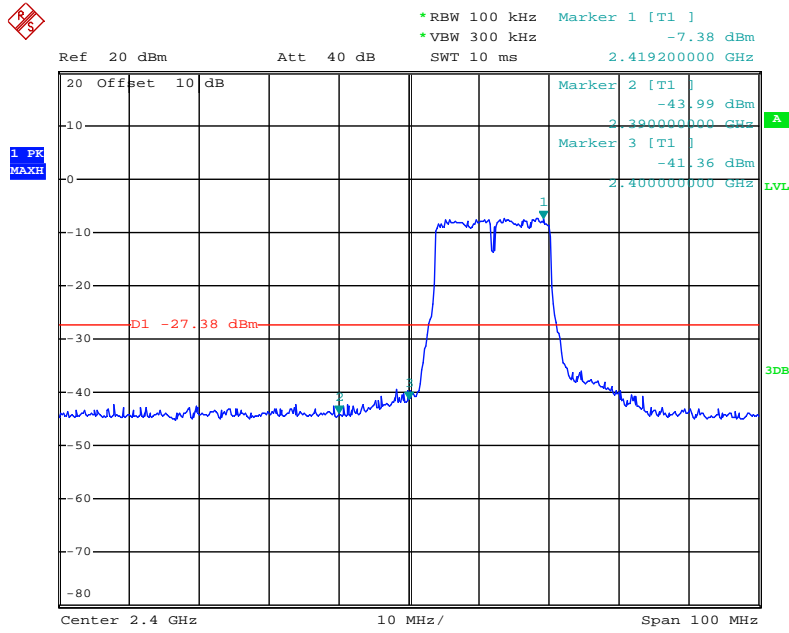

Date: 13.MAY.2019 17:44:26

### 802.11g Channel High 2462MHz

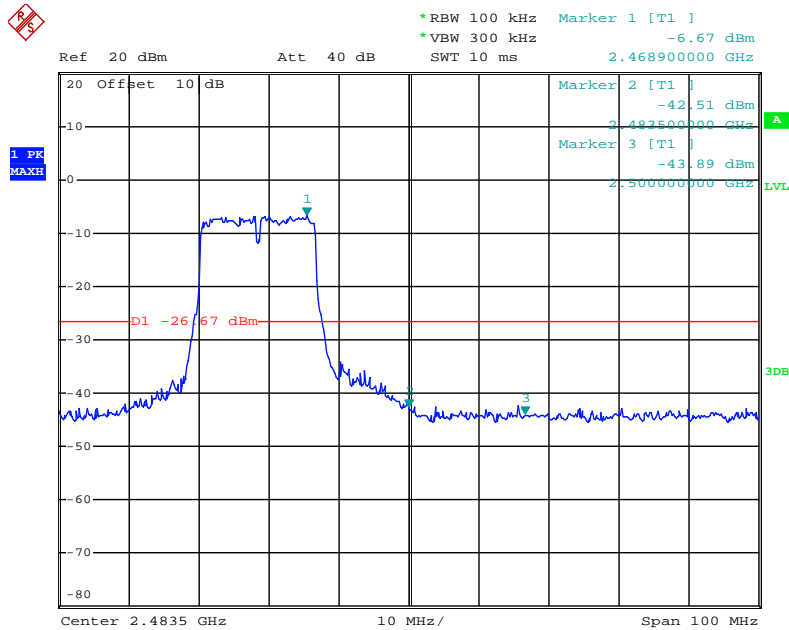

Date: 13.MAY.2019 17:45:31

### 802.11n Channel Low 2412MHz (20MHz)

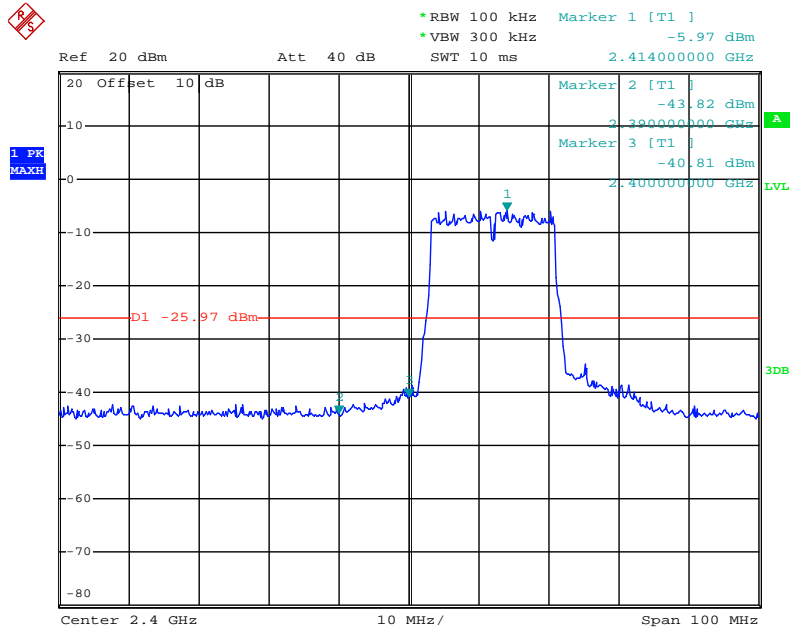

Date: 13.MAY.2019 17:43:01

### 802.11n Channel High 2462MHz (20MHz)

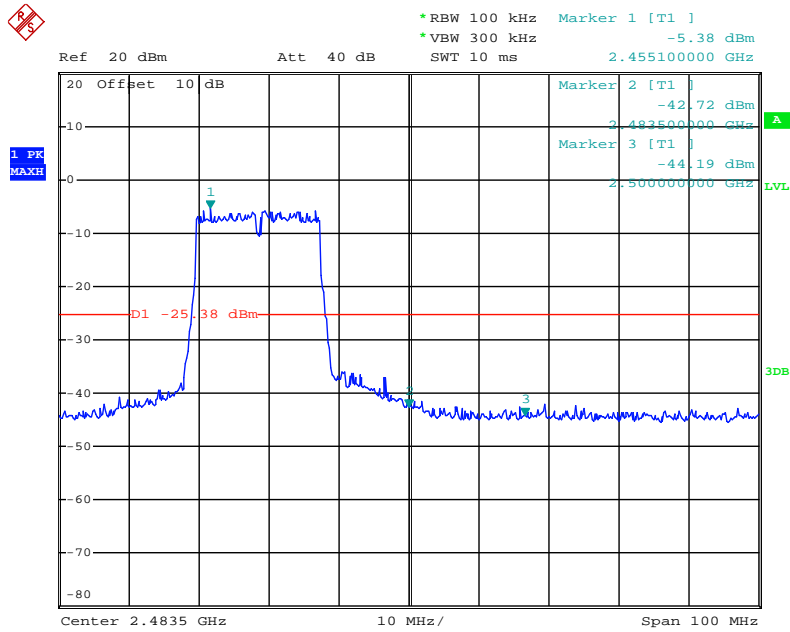

Date: 13.MAY.2019 17:41:15

## Radiated Band Edge Result

Note:

1. Emissions attenuated more than 20 dB below the permissible value are not reported.
2. The field strength is calculated by adding the antenna factor, high pass filter loss(if used) and cable loss, and subtracting the amplifier gain(if any)from the measured reading. The basic equation calculation is as follows:  
Result = Reading + Corrected Factor
3. Display the measurement of peak values.

Test Procedure:

The EUT and its simulators are placed on a turntable, which is 1.5 meter high above ground(Above 1GHz). The turntable can rotate 360 degrees to determine the position of the maximum emission level. EUT is set 3.0 meters away from the receiving antenna, which is mounted on an antenna tower. The antenna can be moved up and down between 1.0 meter and 4 meters to find out the maximum emission level. Broadband antenna (calibrated bi-log antenna) is used as receiving antenna. Both horizontal and vertical polarizations of the antenna are set on measurement. In order to find the maximum emission levels, all of the EUT location must be manipulated according to ANSI C63.10:2013 on radiated emission measurement. This EUT was tested in 3 orthogonal positions and the worst case position data was reported.

Let the EUT work in TX modes then measure it.

We select 2412MHz, 2462MHz TX frequency to transmit(802.11b/g/n20 mode).

During the radiated emission test, the spectrum analyzer was set with the following configurations:

- 1.The resolution bandwidth of test receiver/spectrum analyzer is 1MHz and video bandwidth is 3MHz for peak measurement with peak detector at frequency above 1GHz.
- 2.The resolution bandwidth of test receiver/spectrum analyzer is 1MHz and video bandwidth is 10Hz for Average measurement with peak detection at frequency above 1GHz.
- 3.We tested 802.11b/g/n mode the all and the worst-case emissions are reported.

Noto: We tested 802.11b/g/n mode the all data rate and recorded the worst case data for this channel to be 1Mbps for 802.11b mode and 6Mbps for 802.11g mode and MCS0 for 802.11n mode.

Test Lab: 3m Anechoic chamber

Test Engineer: Frank





**ACCURATE TECHNOLOGY CO., LTD.**  
F1,Bldg,A,Changyuan New Material Port Keyuan Rd,  
Science & Industry Park,Nanshan Shenzhen,P.R.China

Site: 1# Chamber  
Tel:+86-0755-26503290  
Fax:+86-0755-26503396

Job No.: FRANK2019 #1060  
Standard: FCC PK  
Test item: Radiation Test  
Temp.( C)/Hum.(%) 25 C / 55 %  
EUT: Floodlight Camera  
Mode: TX Channel 1(802.11b)  
Model: L820

Polarization: Horizontal  
Power Source: AC 120V; 60Hz  
Date: 19/05/15/  
Time: 9/41/36  
Engineer Signature: Frank  
Distance: 3m

Manufacturer: Shenzhen Leshi Video Technology Co.,Ltd

Note: Report NO.:ATE20190564

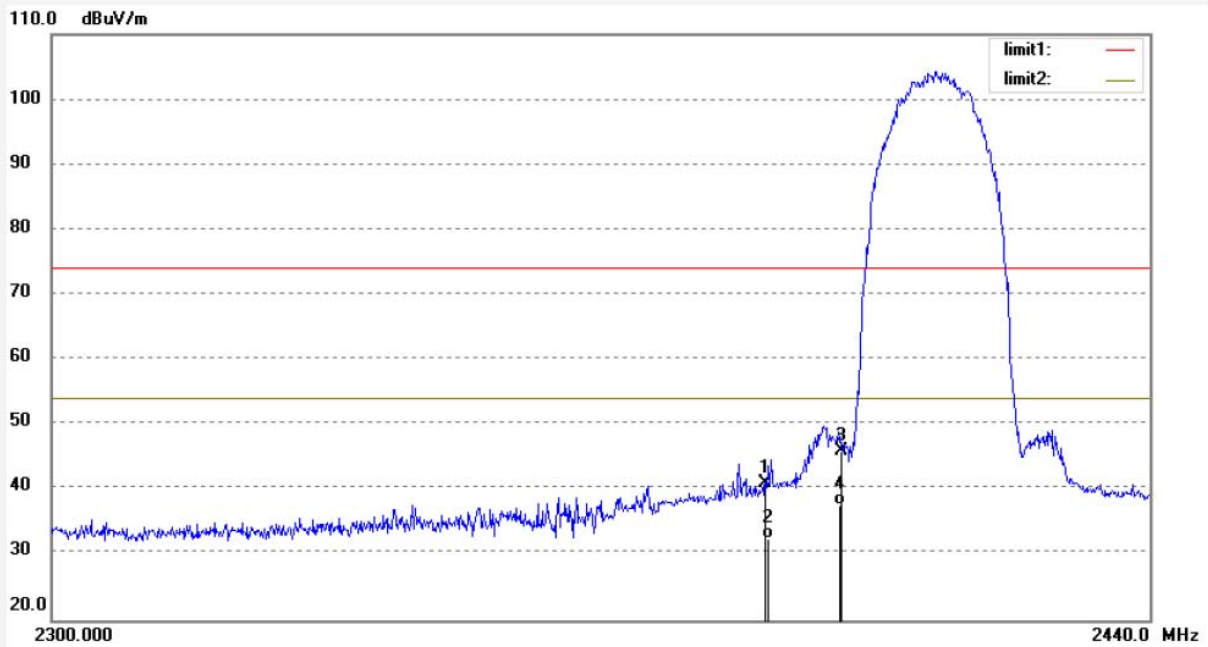

No.	Freq. (MHz)	Reading (dBuV/m)	Factor (dB)	Result (dBuV/m)	Limit (dBuV/m)	Margin (dB)	Detector	Height (cm)	Degree (deg.)	Remark
1	2390.000	47.39	-6.32	41.07	74.00	-32.93	peak	200	66	
2	2390.000	38.78	-6.32	32.46	54.00	-21.54	AVG	200	218	
3	2400.000	52.20	-6.27	45.93	74.00	-28.07	peak	200	93	
4	2400.000	43.97	-6.27	37.70	54.00	-16.30	AVG	200	103	



**ACCURATE TECHNOLOGY CO., LTD.**  
F1,Bldg,A,Changyuan New Material Port Keyuan Rd,  
Science & Industry Park,Nanshan Shenzhen,P.R.China

Site: 1# Chamber  
Tel:+86-0755-26503290  
Fax:+86-0755-26503396

Job No.: FRANK2019 #1061

Polarization: Vertical

Standard: FCC PK

Power Source: AC 120V; 60Hz

Test item: Radiation Test

Date: 19/05/15/

Temp.( C)/Hum.(%) 25 C / 55 %

Time: 9/42/31

EUT: Floodlight Camera

Engineer Signature: Frank

Mode: TX Channel 1(802.11b)

Distance: 3m

Model: L820

Manufacturer: Shenzhen Leshi Video Technology Co.,Ltd

Note: Report NO.:ATE20190564

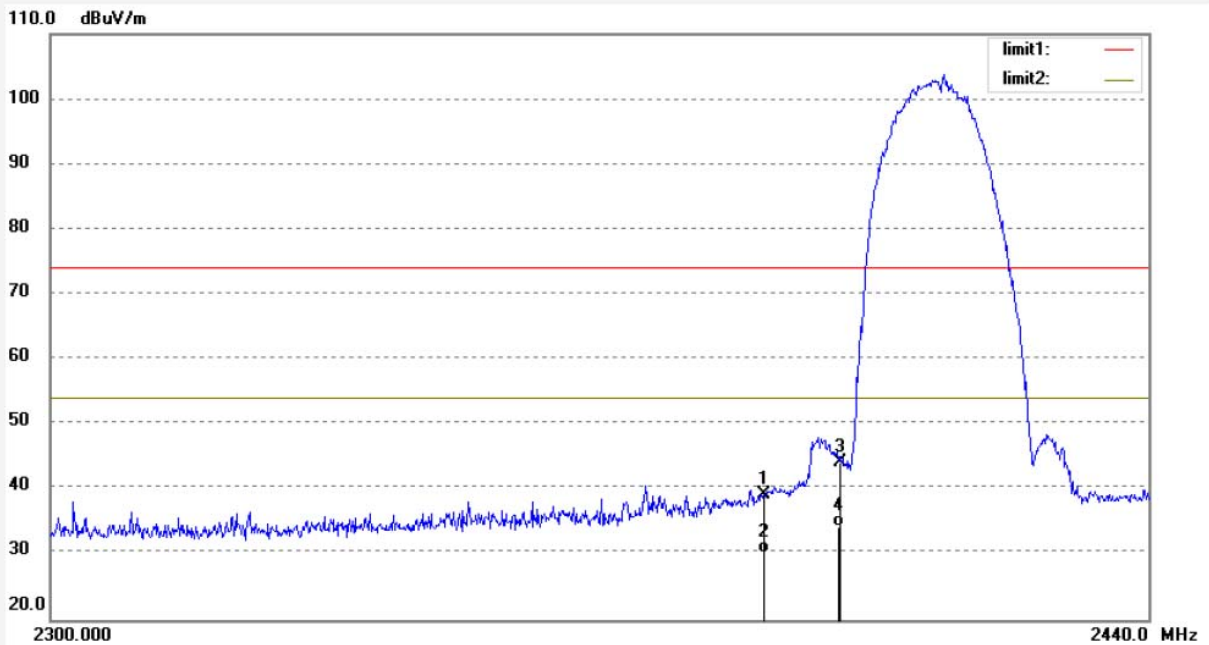

No.	Freq. (MHz)	Reading (dBuV/m)	Factor (dB)	Result (dBuV/m)	Limit (dBuV/m)	Margin (dB)	Detector	Height (cm)	Degree (deg.)	Remark
1	2390.000	45.66	-6.32	39.34	74.00	-34.66	peak	150	213	
2	2390.000	36.45	-6.32	30.13	54.00	-23.87	AVG	150	66	
3	2400.000	50.40	-6.27	44.13	74.00	-29.87	peak	150	193	
4	2400.000	40.54	-6.27	34.27	54.00	-19.73	AVG	150	102	



**ACCURATE TECHNOLOGY CO., LTD.**

F1,Bldg,A,Changyuan New Material Port Keyuan Rd,  
Science & Industry Park,Nanshan Shenzhen,P.R.China

Site: 1# Chamber  
Tel:+86-0755-26503290  
Fax:+86-0755-26503396

Job No.: FRANK2019 #1062	Polarization: Vertical
Standard: FCC PK	Power Source: AC 120V; 60Hz
Test item: Radiation Test	Date: 19/05/15/
Temp.( C)/Hum.(%) 25 C / 55 %	Time: 9/44/00
EUT: Floodlight Camera	Engineer Signature: Frank
Mode: TX Channel 11(802.11b)	Distance: 3m
Model: L820	
Manufacturer: Shenzhen Leshi Video Technology Co.,Ltd	

Note: Report NO.:ATE20190564

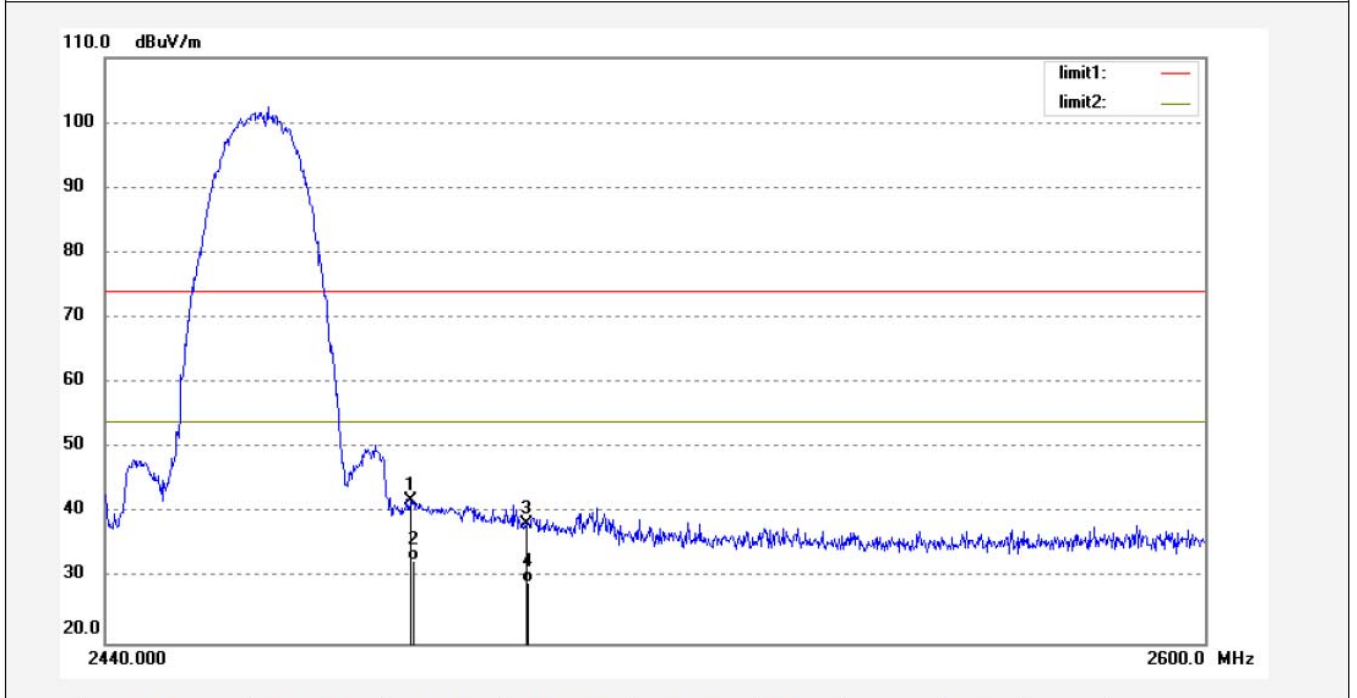

No.	Freq. (MHz)	Reading (dBuV/m)	Factor (dB)	Result (dBuV/m)	Limit (dBuV/m)	Margin (dB)	Detector	Height (cm)	Degree (deg.)	Remark
1	2483.500	47.74	-5.89	41.85	74.00	-32.15	peak	150	211	
2	2483.500	38.49	-5.89	32.60	54.00	-21.40	AVG	150	96	
3	2500.000	44.09	-5.81	38.28	74.00	-35.72	peak	150	229	
4	2500.000	35.15	-5.81	29.34	54.00	-24.66	AVG	150	103	



**ACCURATE TECHNOLOGY CO., LTD.**

F1,Bldg,A,Changyuan New Material Port Keyuan Rd,  
Science & Industry Park,Nanshan Shenzhen,P.R.China

Site: 1# Chamber  
Tel:+86-0755-26503290  
Fax:+86-0755-26503396

Job No.: FRANK2019 #1063	Polarization: Horizontal
Standard: FCC PK	Power Source: AC 120V; 60Hz
Test item: Radiation Test	Date: 19/05/15/
Temp.( C)/Hum.(%) 25 C / 55 %	Time: 9/44/57
EUT: Floodlight Camera	Engineer Signature: Frank
Mode: TX Channel 11(802.11b)	Distance: 3m
Model: L820	
Manufacturer: Shenzhen Leshi Video Technology Co.,Ltd	

Note: Report NO.:ATE20190564

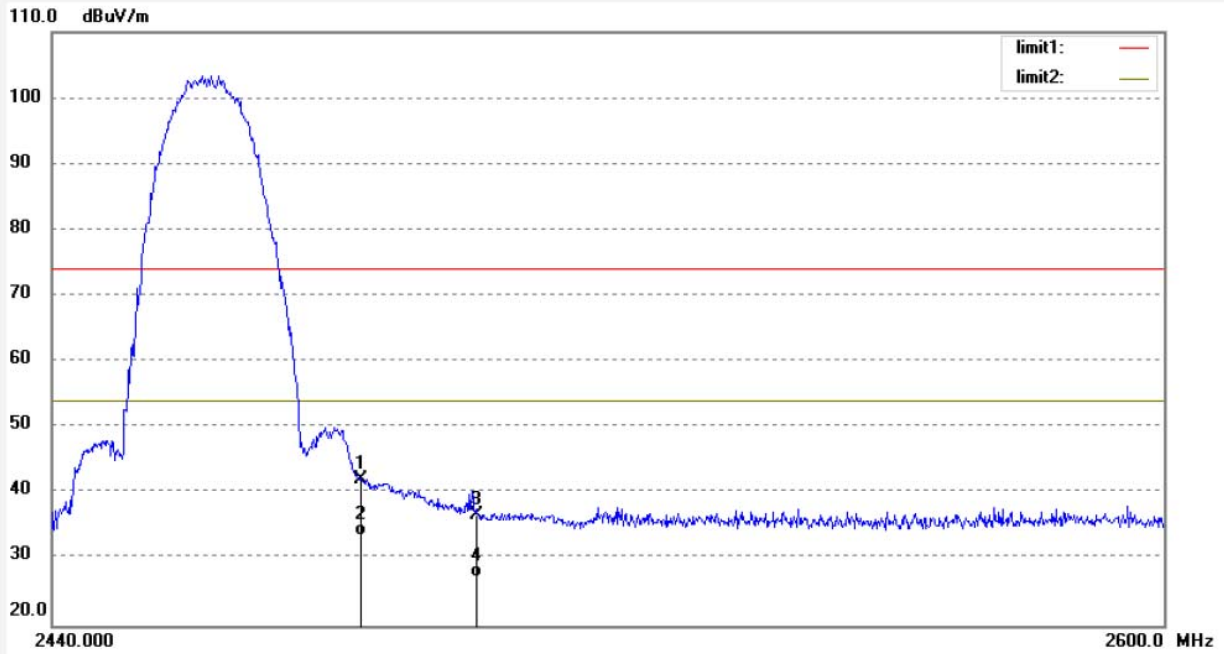

No.	Freq. (MHz)	Reading (dBuV/m)	Factor (dB)	Result (dBuV/m)	Limit (dBuV/m)	Margin (dB)	Detector	Height (cm)	Degree (deg.)	Remark
1	2483.500	48.07	-5.89	42.18	74.00	-31.82	peak	200	118	
2	2483.500	39.46	-5.89	33.57	54.00	-20.43	AVG	200	96	
3	2500.000	42.64	-5.81	36.83	74.00	-37.17	peak	200	259	
4	2500.000	33.15	-5.81	27.34	54.00	-26.66	AVG	200	103	



**ACCURATE TECHNOLOGY CO., LTD.**

F1,Bldg,A,Changyuan New Material Port Keyuan Rd,  
Science & Industry Park,Nanshan Shenzhen,P.R.China

Site: 1# Chamber  
Tel:+86-0755-26503290  
Fax:+86-0755-26503396

Job No.: FRANK2019 #1058  
Standard: FCC PK  
Test item: Radiation Test  
Temp.( C)/Hum.(%) 25 C / 55 %  
EUT: Floodlight Camera  
Mode: TX Channel 1(802.11g)  
Model: L820

Polarization: Vertical  
Power Source: AC 120V; 60Hz  
Date: 19/05/15/  
Time: 9/39/35  
Engineer Signature: Frank  
Distance: 3m

Manufacturer: Shenzhen Leshi Video Technology Co.,Ltd

Note: Report NO.:ATE20190564

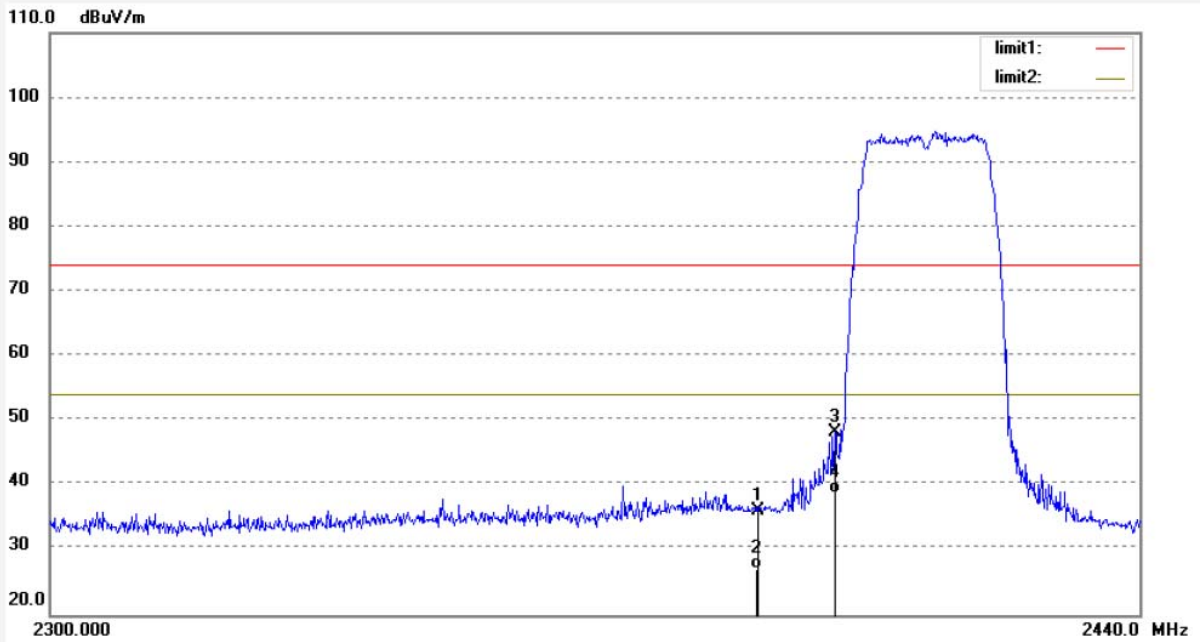

No.	Freq. (MHz)	Reading (dBuV/m)	Factor (dB)	Result (dBuV/m)	Limit (dBuV/m)	Margin (dB)	Detector	Height (cm)	Degree (deg.)	Remark
1	2390.000	42.37	-6.32	36.05	74.00	-37.95	peak	150	110	
2	2390.000	33.45	-6.32	27.13	54.00	-26.87	AVG	150	81	
3	2400.000	54.42	-6.27	48.15	74.00	-25.85	peak	150	63	
4	2400.000	44.99	-6.27	38.72	54.00	-15.28	AVG	150	109	



**ACCURATE TECHNOLOGY CO., LTD.**

F1,Bldg,A,Changyuan New Material Port Keyuan Rd,  
Science & Industry Park,Nanshan Shenzhen,P.R.China

Site: 1# Chamber  
Tel:+86-0755-26503290  
Fax:+86-0755-26503396

Job No.: FRANK2019 #1059	Polarization: Horizontal
Standard: FCC PK	Power Source: AC 120V; 60Hz
Test item: Radiation Test	Date: 19/05/15/
Temp.( C)/Hum.(%) 25 C / 55 %	Time: 9/40/17
EUT: Floodlight Camera	Engineer Signature: Frank
Mode: TX Channel 1(802.11g)	Distance: 3m
Model: L820	
Manufacturer: Shenzhen Leshi Video Technology Co.,Ltd	

Note: Report NO.:ATE20190564

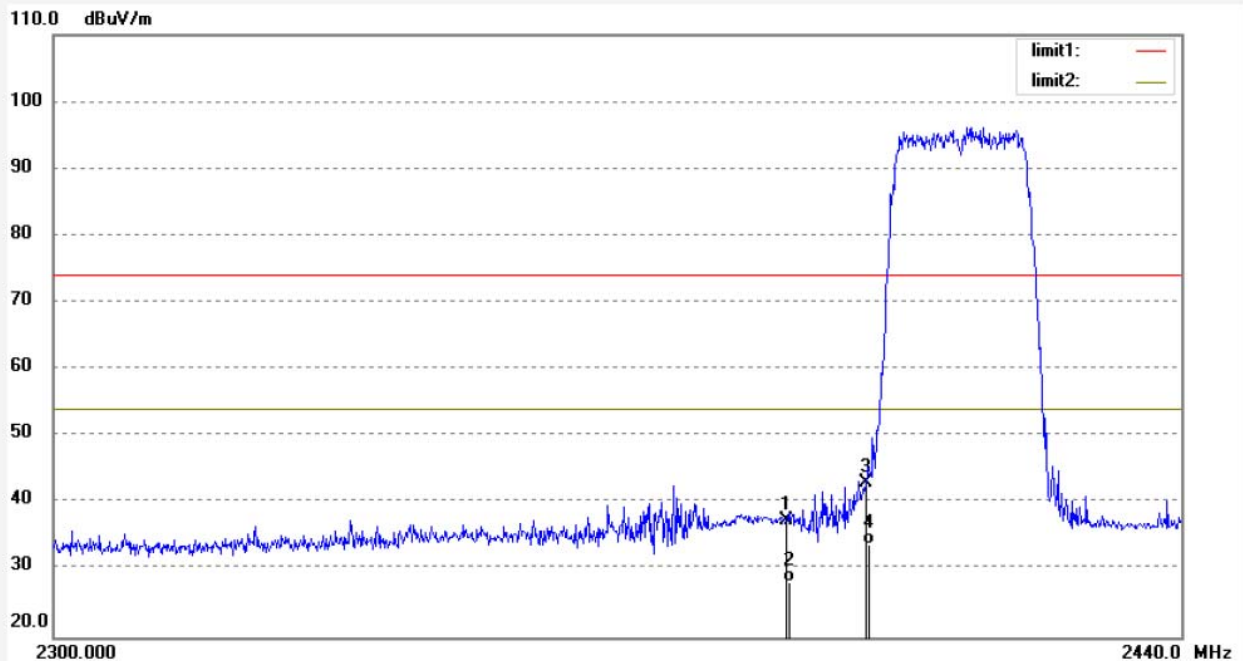

No.	Freq. (MHz)	Reading (dBuV/m)	Factor (dB)	Result (dBuV/m)	Limit (dBuV/m)	Margin (dB)	Detector	Height (cm)	Degree (deg.)	Remark
1	2390.000	43.74	-6.32	37.42	74.00	-36.58	peak	200	115	
2	2390.000	34.45	-6.32	28.13	54.00	-25.87	AVG	200	93	
3	2400.000	49.44	-6.27	43.17	74.00	-30.83	peak	200	221	
4	2400.000	40.12	-6.27	33.85	54.00	-20.15	AVG	200	103	



**ACCURATE TECHNOLOGY CO., LTD.**  
F1,Bldg,A,Changyuan New Material Port Keyuan Rd,  
Science & Industry Park,Nanshan Shenzhen,P.R.China

Site: 1# Chamber  
Tel:+86-0755-26503290  
Fax:+86-0755-26503396

Job No.: FRANK2019 #1064

Standard: FCC PK

Test item: Radiation Test

Temp.( C)/Hum.(%) 25 C / 55 %

EUT: Floodlight Camera

Mode: TX Channel 11(802.11g)

Model: L820

Manufacturer: Shenzhen Leshi Video Technology Co.,Ltd

Polarization: Horizontal

Power Source: AC 120V; 60Hz

Date: 19/05/15/

Time: 9/46/23

Engineer Signature: Frank

Distance: 3m

Note: Report NO.:ATE20190564

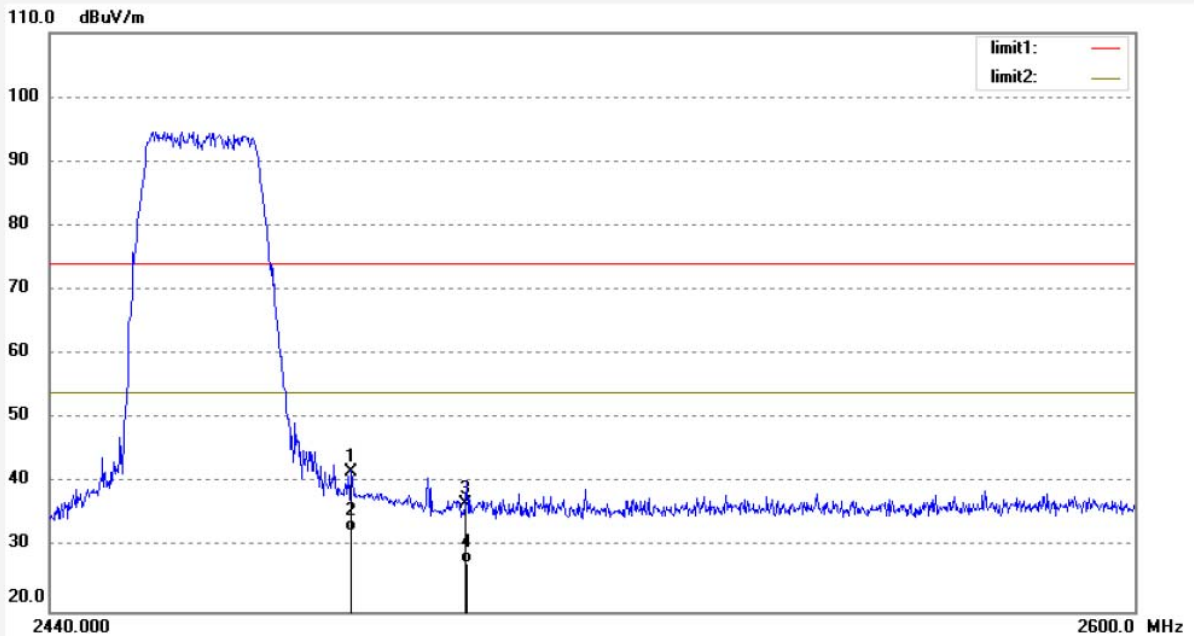

No.	Freq. (MHz)	Reading (dBuV/m)	Factor (dB)	Result (dBuV/m)	Limit (dBuV/m)	Margin (dB)	Detector	Height (cm)	Degree (deg.)	Remark
1	2483.500	47.51	-5.89	41.62	74.00	-32.38	peak	200	126	
2	2483.500	38.45	-5.89	32.56	54.00	-21.44	AVG	200	99	
3	2500.000	42.53	-5.81	36.72	74.00	-37.28	peak	200	25	
4	2500.000	33.45	-5.81	27.64	54.00	-26.36	AVG	200	103	



**ACCURATE TECHNOLOGY CO., LTD.**  
F1,Bldg,A,Changyuan New Material Port Keyuan Rd,  
Science & Industry Park,Nanshan Shenzhen,P.R.China

Site: 1# Chamber  
Tel:+86-0755-26503290  
Fax:+86-0755-26503396

Job No.: FRANK2019 #1065	Polarization: Vertical
Standard: FCC PK	Power Source: AC 120V; 60Hz
Test item: Radiation Test	Date: 19/05/15/
Temp.( C)/Hum.(%) 25 C / 55 %	Time: 9/47/26
EUT: Floodlight Camera	Engineer Signature: Frank
Mode: TX Channel 11(802.11g)	Distance: 3m
Model: L820	
Manufacturer: Shenzhen Leshi Video Technology Co.,Ltd	

Note: Report NO.:ATE20190564

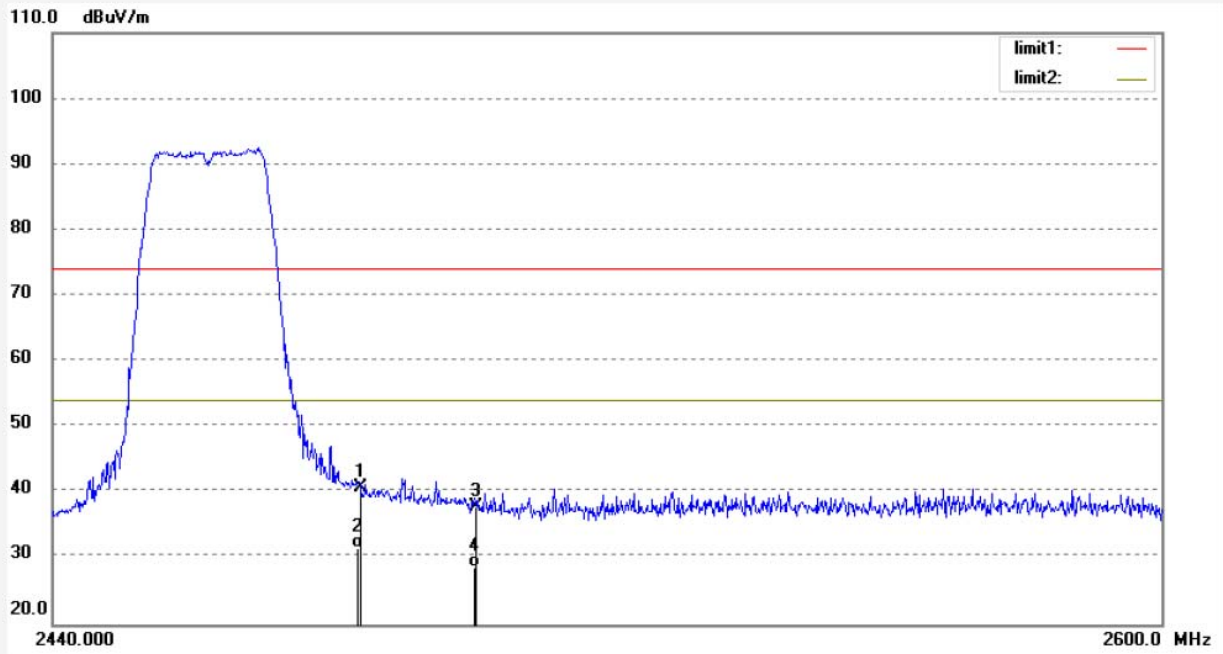

No.	Freq. (MHz)	Reading (dBuV/m)	Factor (dB)	Result (dBuV/m)	Limit (dBuV/m)	Margin (dB)	Detector	Height (cm)	Degree (deg.)	Remark
1	2483.500	46.75	-5.89	40.86	74.00	-33.14	peak	150	141	
2	2483.500	37.48	-5.89	31.59	54.00	-22.41	AVG	150	96	
3	2500.000	43.74	-5.81	37.93	74.00	-36.07	peak	150	329	
4	2500.000	34.45	-5.81	28.64	54.00	-25.36	AVG	150	109	





**ACCURATE TECHNOLOGY CO., LTD.**

F1,Bldg,A,Changyuan New Material Port Keyuan Rd,  
Science & Industry Park,Nanshan Shenzhen,P.R.China

Site: 1# Chamber  
Tel:+86-0755-26503290  
Fax:+86-0755-26503396

Job No.: FRANK2019 #1057

Standard: FCC PK

Test item: Radiation Test

Temp.( C)/Hum.(%) 25 C / 55 %

EUT: Floodlight Camera

Mode: TX Channel 1(802.11n20)

Model: L820

Manufacturer: Shenzhen Leshi Video Technology Co.,Ltd

Polarization: Vertical

Power Source: AC 120V; 60Hz

Date: 19/05/15/

Time: 9/38/31

Engineer Signature: Frank

Distance: 3m

Note: Report NO.:ATE20190564

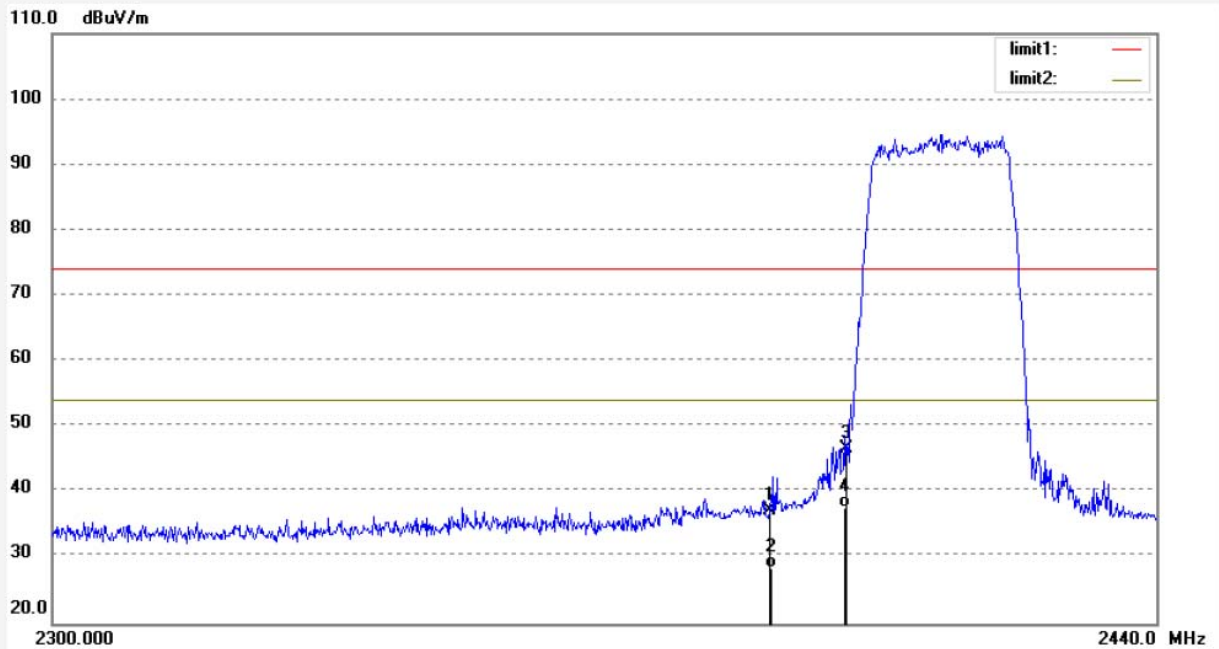

No.	Freq. (MHz)	Reading (dBuV/m)	Factor (dB)	Result (dBuV/m)	Limit (dBuV/m)	Margin (dB)	Detector	Height (cm)	Degree (deg.)	Remark
1	2390.000	43.43	-6.32	37.11	74.00	-36.89	peak	150	93	
2	2390.000	34.78	-6.32	28.46	54.00	-25.54	AVG	150	201	
3	2400.000	52.99	-6.27	46.72	74.00	-27.28	peak	150	321	
4	2400.000	43.99	-6.27	37.72	54.00	-16.28	AVG	150	196	



**ACCURATE TECHNOLOGY CO., LTD.**

F1,Bldg,A,Changyuan New Material Port Keyuan Rd,  
Science & Industry Park,Nanshan Shenzhen,P.R.China

Site: 1# Chamber  
Tel:+86-0755-26503290  
Fax:+86-0755-26503396

Job No.: FRANK2019 #1056  
Standard: FCC PK  
Test item: Radiation Test  
Temp.( C)/Hum.(%) 25 C / 55 %  
EUT: Floodlight Camera  
Mode: TX Channel 1(802.11n20)  
Model: L820

Polarization: Horizontal  
Power Source: AC 120V; 60Hz  
Date: 19/05/15/  
Time: 9/37/37  
Engineer Signature: Frank  
Distance: 3m

Manufacturer: Shenzhen Leshi Video Technology Co.,Ltd

Note: Report NO.:ATE20190564

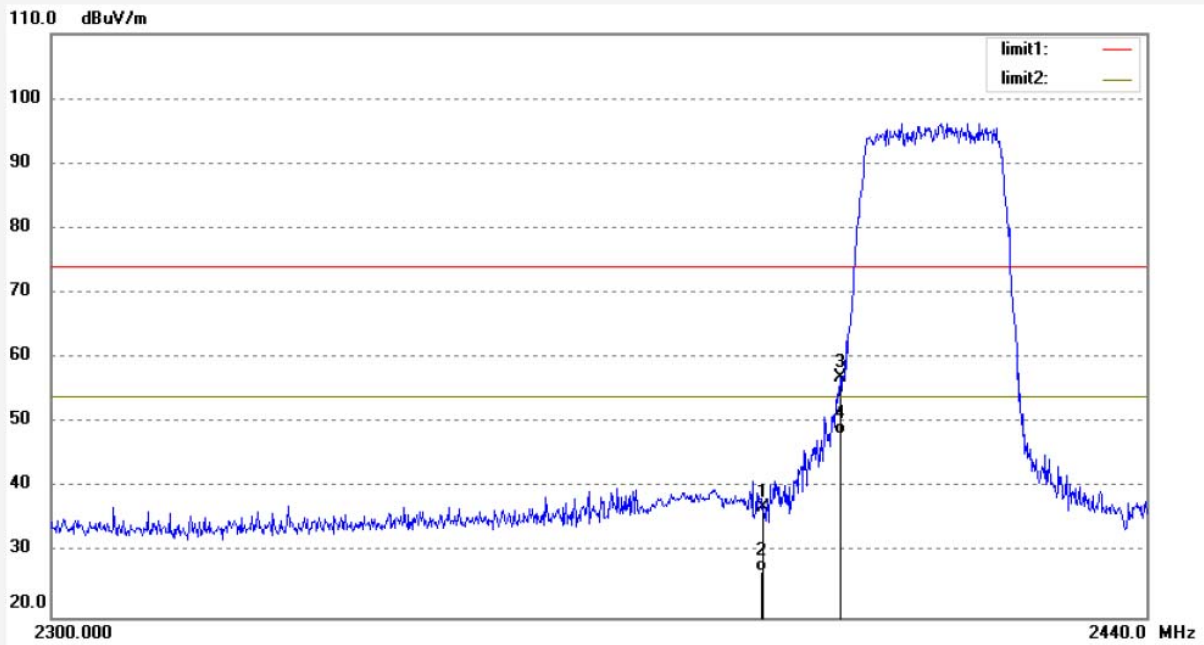

No.	Freq. (MHz)	Reading (dBuV/m)	Factor (dB)	Result (dBuV/m)	Limit (dBuV/m)	Margin (dB)	Detector	Height (cm)	Degree (deg.)	Remark
1	2390.000	43.34	-6.32	37.02	74.00	-36.98	peak	200	84	
2	2390.000	33.48	-6.32	27.16	54.00	-26.84	AVG	250	219	
3	2400.000	63.30	-6.27	57.03	74.00	-16.97	peak	200	63	
4	2400.000	54.46	-6.27	48.19	54.00	-5.81	AVG	200	109	



**ACCURATE TECHNOLOGY CO., LTD.**

F1,Bldg,A,Changyuan New Material Port Keyuan Rd,  
Science & Industry Park,Nanshan Shenzhen,P.R.China

Site: 1# Chamber  
Tel:+86-0755-26503290  
Fax:+86-0755-26503396

Job No.: FRANK2019 #1054

Polarization: Vertical

Standard: FCC PK

Power Source: AC 120V; 60Hz

Test item: Radiation Test

Date: 19/05/15/

Temp.( C)/Hum.(%) 25 C / 55 %

Time: 9/34/36

EUT: Floodlight Camera

Engineer Signature: Frank

Mode: TX Channel 11(802.11n20)

Distance: 3m

Model: L820

Manufacturer: Shenzhen Leshi Video Technology Co.,Ltd

Note: Report NO.:ATE20190564

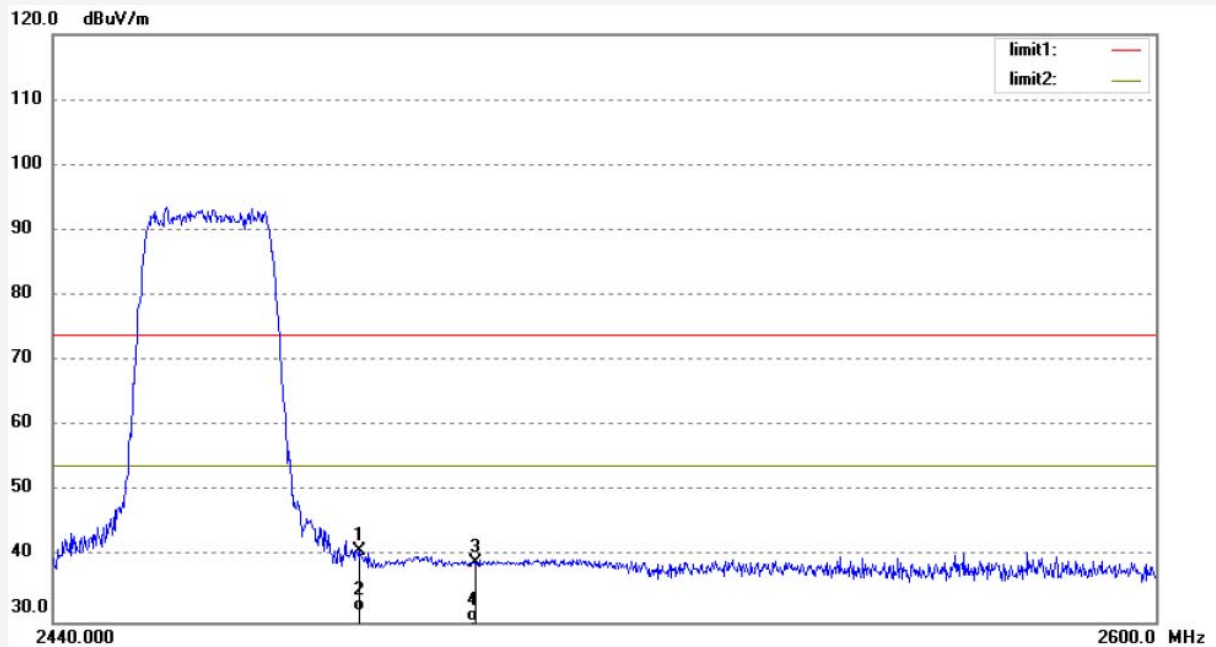

No.	Freq. (MHz)	Reading (dBuV/m)	Factor (dB)	Result (dBuV/m)	Limit (dBuV/m)	Margin (dB)	Detector	Height (cm)	Degree (deg.)	Remark
1	2483.500	46.70	-5.89	40.81	74.00	-33.19	peak	150	115	
2	2483.500	37.49	-5.89	31.60	54.00	-22.40	AVG	150	93	
3	2500.000	44.94	-5.81	39.13	74.00	-34.87	peak	150	45	
4	2500.000	35.87	-5.81	30.06	54.00	-23.94	AVG	150	108	



**ACCURATE TECHNOLOGY CO., LTD.**  
F1,Bldg,A,Changyuan New Material Port Keyuan Rd,  
Science & Industry Park,Nanshan Shenzhen,P.R.China

Site: 1# Chamber  
Tel:+86-0755-26503290  
Fax:+86-0755-26503396

Job No.: FRANK2019 #1055

Polarization: Horizontal

Standard: FCC PK

Power Source: AC 120V; 60Hz

Test item: Radiation Test

Date: 19/05/15/

Temp.( C)/Hum.(%) 25 C / 55 %

Time: 9/35/50

EUT: Floodlight Camera

Engineer Signature: Frank

Mode: TX Channel 11(802.11n20)

Distance: 3m

Model: L820

Manufacturer: Shenzhen Leshi Video Technology Co.,Ltd

Note: Report NO.:ATE20190564

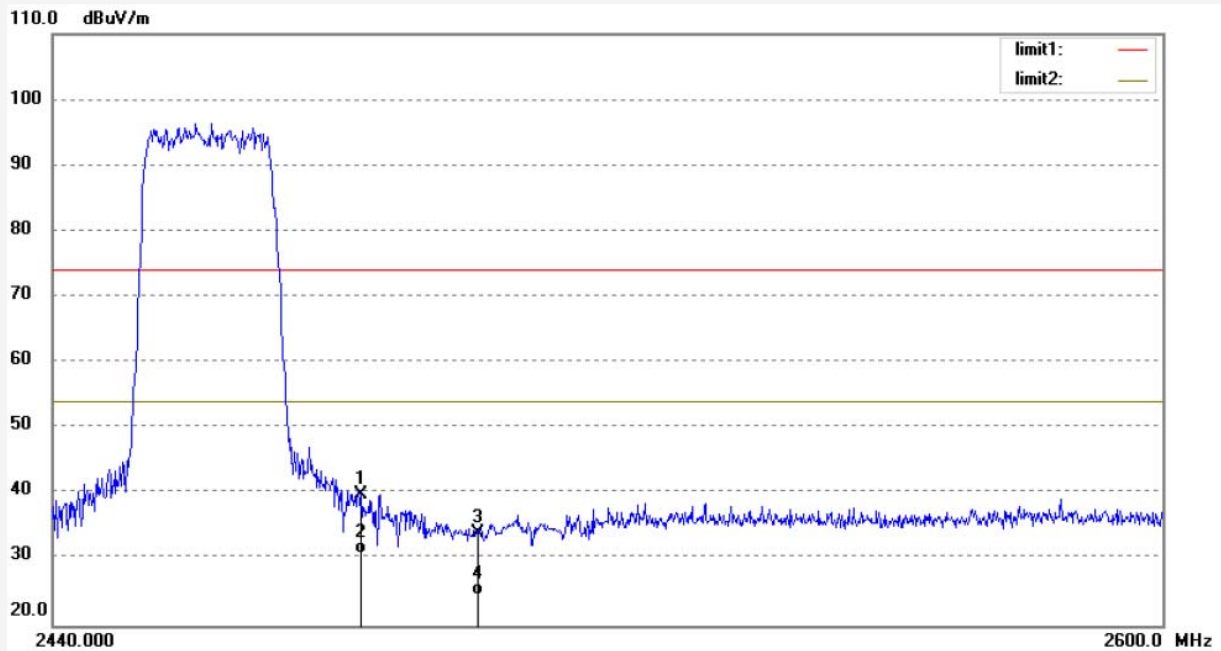

No.	Freq. (MHz)	Reading (dBuV/m)	Factor (dB)	Result (dBuV/m)	Limit (dBuV/m)	Margin (dB)	Detector	Height (cm)	Degree (deg.)	Remark
1	2483.500	45.88	-5.89	39.99	74.00	-34.01	peak	200	118	
2	2483.500	36.78	-5.89	30.89	54.00	-23.11	AVG	200	99	
3	2500.000	39.93	-5.81	34.12	74.00	-39.88	peak	200	259	
4	2500.000	30.45	-5.81	24.64	54.00	-29.36	AVG	200	103	

## 12. RADIATED SPURIOUS EMISSION TEST

### 12.1. Block Diagram of Test Setup

#### 12.1.1. Block diagram of connection between the EUT and peripherals

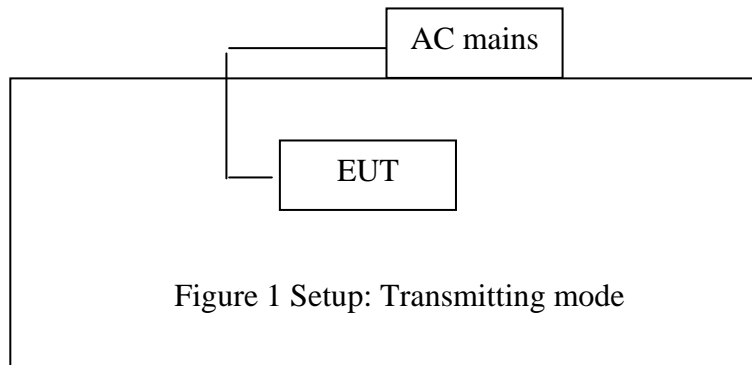

#### 12.1.2. Semi-Anechoic Chamber Test Setup Diagram

(A) Radiated Emission Test Set-Up, Frequency below 30MHz

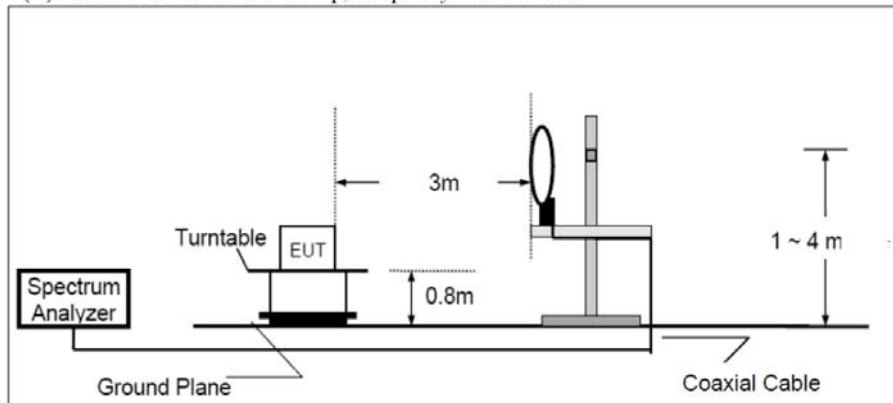

(B) Radiated Emission Test Set-Up, Frequency 30MHz-1GHz

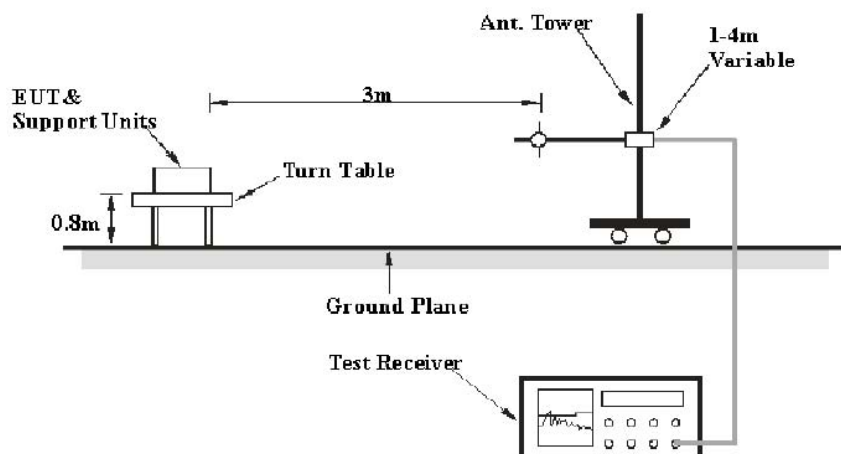

(C) Radiated Emission Test Set-Up, Frequency above 1GHz

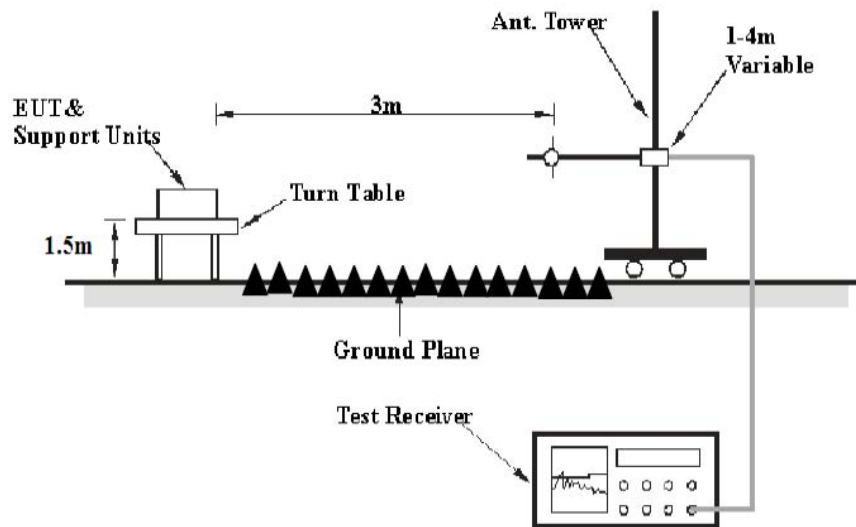

## 12.2. The Limit For Section 15.247(d)

Section 15.247(d): In any 100 kHz bandwidth outside the frequency band in which the spread spectrum or digitally modulated intentional radiator is operating, the radio frequency power that is produced by the intentional radiator shall be at least 20 dB below that in the 100 kHz bandwidth within the band that contains the highest level of the desired power, based on either an RF conducted or a radiated measurement, provided the transmitter demonstrates compliance with the peak conducted power limits. If the transmitter complies with the conducted power limits based on the use of RMS averaging over a time interval, as permitted under paragraph (b)(3) of this section, the attenuation required under this paragraph shall be 30 dB instead of 20 dB. Attenuation below the general limits specified in Section 15.209(a) is not required. In addition, radiated emissions which fall in the restricted bands, as defined in Section 15.205(a), must also comply with the radiated emission limits specified in Section 15.209(a).

### 12.3.Restricted bands of operation

#### 12.3.1.FCC Part 15.205 Restricted bands of operation

(a) Except as shown in paragraph (d) of this section, Only spurious emissions are permitted in any of the frequency bands listed below:

MHz	MHz	MHz	GHz
0.090-0.110	16.42-16.423	399.9-410	4.5-5.15
<sup>1</sup> 0.495-0.505	16.69475-16.69525	608-614	5.35-5.46
2.1735-2.1905	16.80425-16.80475	960-1240	7.25-7.75
4.125-4.128	25.5-25.67	1300-1427	8.025-8.5
4.17725-4.17775	37.5-38.25	1435-1626.5	9.0-9.2
4.20725-4.20775	73-74.6	1645.5-1646.5	9.3-9.5
6.215-6.218	74.8-75.2	1660-1710	10.6-12.7
6.26775-6.26825	108-121.94	1718.8-1722.2	13.25-13.4
6.31175-6.31225	123-138	2200-2300	14.47-14.5
8.291-8.294	149.9-150.05	2310-2390	15.35-16.2
8.362-8.366	156.52475-156.52525	2483.5-2500	17.7-21.4
8.37625-8.38675	156.7-156.9	2690-2900	22.01-23.12
8.41425-8.41475	162.0125-167.17	3260-3267	23.6-24.0
12.29-12.293	167.72-173.2	3332-3339	31.2-31.8
12.51975-12.52025	240-285	3345.8-3358	36.43-36.5
12.57675-12.57725	322-335.4	3600-4400	( <sup>2</sup> )
13.36-13.41			

<sup>1</sup>Until February 1, 1999, this restricted band shall be 0.490-0.510

<sup>2</sup>Above 38.6

(b) Except as provided in paragraphs (d) and (e), the field strength of emission appearing within these frequency bands shall not exceed the limits shown in Section 15.209. At frequencies equal to or less than 1000MHz, Compliance with the limits in Section 15.209 shall be demonstrated using measurement instrumentation employing a CISPR quasi-peak detector. Above 1000MHz, compliance with the emission limits in Section 15.209 shall be demonstrated based on the average value of the measured emissions. The provisions in Section 15.35 apply to these measurements.

### 12.4.Configuration of EUT on Measurement

The equipment are installed on Radiated Emission Measurement to meet the commission requirements and operating regulations in a manner which tends to maximize its emission characteristics in normal application.

## 12.5. Operating Condition of EUT

12.5.1. Setup the EUT and simulator as shown as Section 10.1.

12.5.2. Turn on the power of all equipment.

12.5.3. Let the EUT work in TX modes measure it. The transmit frequency are 2412-2462 MHz. We select 2412MHz, 2462MHz TX frequency to transmit.

## 12.6. Test Procedure

The EUT and its simulators are placed on a turntable, which is 0.8 meter high above ground (Below 1GHz). The EUT and its simulators are placed on a turntable, which is 1.5 meter high above ground (Above 1GHz). The turntable can rotate 360 degrees to determine the position of the maximum emission level. EUT is set 3.0 meters away from the receiving antenna, which is mounted on an antenna tower. The antenna can be moved up and down between 1.0 meter and 4 meters to find out the maximum emission level. Broadband antenna (calibrated bi-log antenna) is used as receiving antenna. Both horizontal and vertical polarizations of the antenna are set on measurement. In order to find the maximum emission levels, all of the EUT location must be manipulated according to ANSI C63.10:2013 on radiated emission measurement.

The frequency range from 30MHz to 26500MHz is checked.

Result = Reading + Corrected Factor

Where Corrected Factor = Antenna Factor + Cable Loss – Amplifier Gain

During the radiated emission test, the spectrum analyzer was set with the following configurations:

1. The resolution bandwidth and video bandwidth of test receiver/spectrum analyzer is 120kHz for Quasi-peak at frequency below 1GHz.
2. The resolution bandwidth of test receiver/spectrum analyzer is 1MHz and video bandwidth is 3MHz for peak measurement with peak detector at frequency above 1GHz.
3. The resolution bandwidth of test receiver/spectrum analyzer is 1MHz and video bandwidth is 10Hz for Average measurement with peak detection at frequency above 1GHz.
4. All modes of operation were investigated and the worst-case emissions are reported.



### 12.7.Data Sample

Frequency (MHz)	Reading (dB $\mu$ v)	Factor (dB/m)	Result (dB $\mu$ v/m)	Limit (dB $\mu$ v/m)	Margin (dB)	Remark
X.XX	48.69	-13.35	35.34	46	-10.66	QP

Frequency(MHz) = Emission frequency in MHz  
 Reading(dB $\mu$ v) = Uncorrected Analyzer/Receiver reading  
 Factor (dB/m) = Antenna factor + Cable Loss – Amplifier gain  
 Result(dB $\mu$ v/m) = Reading(dB $\mu$ v) + Factor(dB/m)  
 Limit (dB $\mu$ v/m) = Limit stated in standard  
 Margin (dB) = Result(dB $\mu$ v/m) - Limit (dB $\mu$ v/m)  
 QP = Quasi-peak Reading

Calculation Formula:  
 Margin(dB) = Result (dB $\mu$ V/m)–Limit(dB $\mu$ V/m)  
 Result(dB $\mu$ V/m)= Reading(dB $\mu$ V)+ Factor(dB/m)

The “Margin” column of the following data tables indicates the degree of compliance with the applicable limit. For example, a margin of -7dB means the emission is 7dB below the limit.

### 12.8.The Field Strength of Radiation Emission Measurement Results

Test Lab: 3m Anechoic chamber  
 Test Engineer: Frank

Note: 1. Emissions attenuated more than 20 dB below the permissible value are not reported.

2. The radiation emissions from 9KHz-30MHz and 18-26.5GHz are not reported, because the test values lower than the limits of 20dB.

3. We tested 802.11b/g/n mode the all data rate and the worst case data for this channel to be 11Mbps for 802.11b mode.

The spectrum analyzer plots are attached as below.

Below 1G



**ACCURATE TECHNOLOGY CO., LTD.**

F1,Bldg,A,Changyuan New Material Port Keyuan Rd,  
Science & Industry Park,Nanshan Shenzhen,P.R.China

Site: 1# Chamber  
Tel:+86-0755-26503290  
Fax:+86-0755-26503396

Job No.: FRANK2019 #1030	Polarization: Horizontal
Standard: FCC Class B 3M Radiated	Power Source: AC 120V; 60Hz
Test item: Radiation Test	Date: 19/05/15/
Temp.( C)/Hum.(%) 25 C / 55 %	Time: 8/28/48
EUT: Floodlight Camera	Engineer Signature: Frank
Mode: TX Channel 1(802.11b)	Distance: 3m
Model: L820	
Manufacturer: Shenzhen Leshi Video Technology Co.,Ltd	

Note: Report NO.:ATE20190564

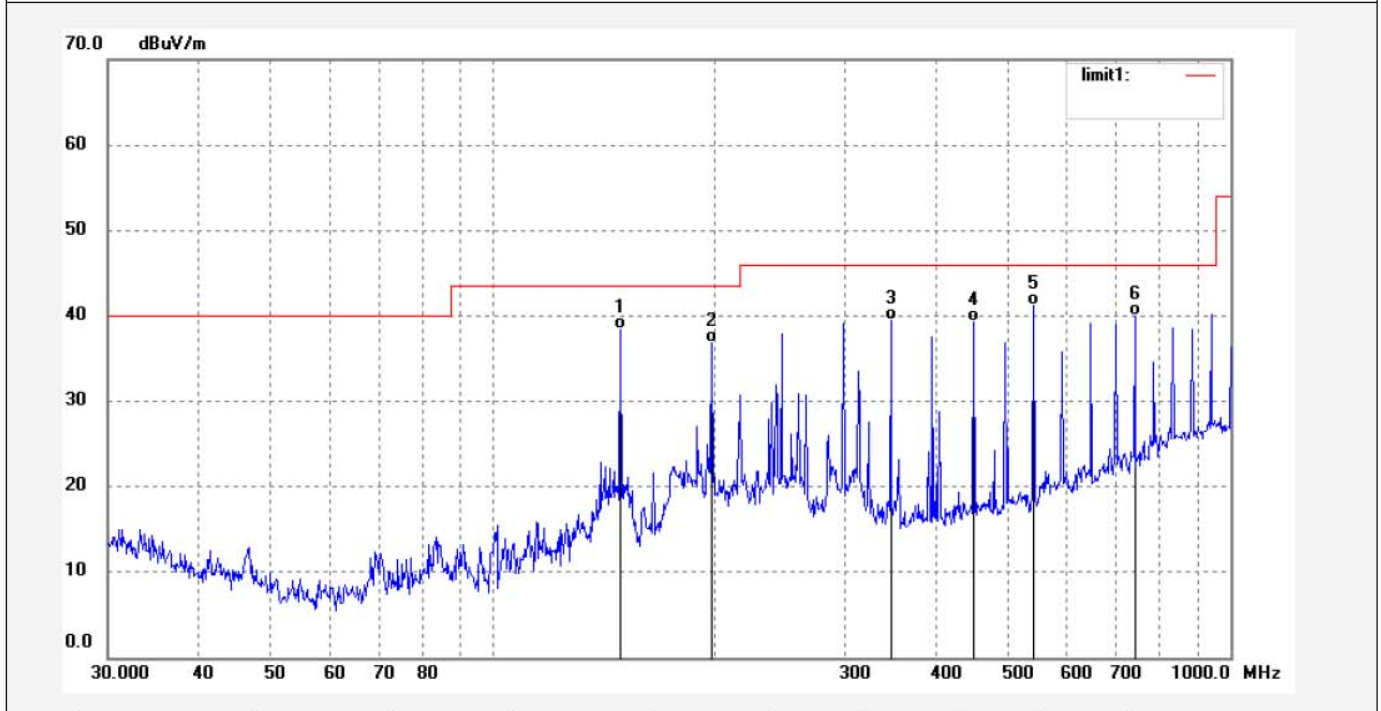

No.	Freq. (MHz)	Reading (dBuV/m)	Factor (dB)	Result (dBuV/m)	Limit (dBuV/m)	Margin (dB)	Detector	Height (cm)	Degree (deg.)	Remark
1	148.9173	66.39	-28.06	38.33	43.50	-5.17	QP	200	103	
2	197.9456	61.25	-24.48	36.77	43.50	-6.73	QP	200	92	
3	346.0740	59.01	-19.46	39.55	46.00	-6.45	QP	200	115	
4	448.8360	56.65	-17.28	39.37	46.00	-6.63	QP	200	329	
5	540.7068	56.22	-15.09	41.13	46.00	-4.87	QP	200	66	
6	741.8155	50.48	-10.51	39.97	46.00	-6.03	QP	200	196	



**ACCURATE TECHNOLOGY CO., LTD.**  
F1,Bldg,A,Changyuan New Material Port Keyuan Rd,  
Science & Industry Park,Nanshan Shenzhen,P.R.China

Site: 1# Chamber  
Tel:+86-0755-26503290  
Fax:+86-0755-26503396

Job No.: FRANK2019 #1031  
Standard: FCC Class B 3M Radiated  
Test item: Radiation Test  
Temp.( C)/Hum.(%) 25 C / 55 %  
EUT: Floodlight Camera  
Mode: TX Channel 1(802.11b)  
Model: L820  
Manufacturer: Shenzhen Leshi Video Technology Co.,Ltd

Polarization: Vertical  
Power Source: AC 120V; 60Hz  
Date: 19/05/15/  
Time: 8/29/30  
Engineer Signature: Frank  
Distance: 3m

Note: Report NO.:ATE20190564

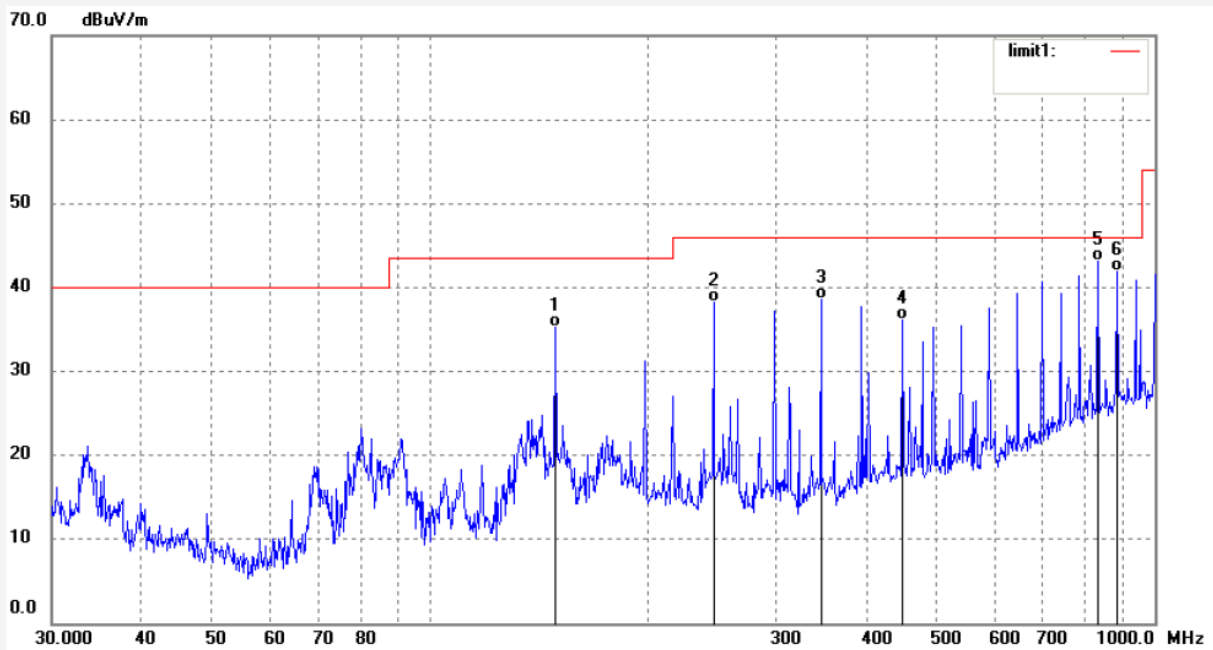

No.	Freq. (MHz)	Reading (dBuV/m)	Factor (dB)	Result (dBuV/m)	Limit (dBuV/m)	Margin (dB)	Detector	Height (cm)	Degree (deg.)	Remark
1	148.9173	63.27	-28.06	35.21	43.50	-8.29	QP	100	130	
2	246.1237	61.83	-23.67	38.16	46.00	-7.84	QP	100	52	
3	346.0740	58.07	-19.46	38.61	46.00	-7.39	QP	100	119	
4	448.8360	53.45	-17.28	36.17	46.00	-9.83	QP	100	66	
5	835.9447	51.46	-8.28	43.18	46.00	-2.82	QP	100	210	
6	887.3976	49.36	-7.41	41.95	46.00	-4.05	QP	100	33	



**ACCURATE TECHNOLOGY CO., LTD.**

F1,Bldg,A,Changyuan New Material Port Keyuan Rd,  
Science & Industry Park,Nanshan Shenzhen,P.R.China

Site: 1# Chamber  
Tel:+86-0755-26503290  
Fax:+86-0755-26503396

Job No.: FRANK2019 #1032	Polarization: Vertical
Standard: FCC Class B 3M Radiated	Power Source: AC 120V; 60Hz
Test item: Radiation Test	Date: 19/05/15/
Temp.( C)/Hum.(%) 25 C / 55 %	Time: 8/29/43
EUT: Floodlight Camera	Engineer Signature: Frank
Mode: TX Channel 6(802.11b)	Distance: 3m
Model: L820	
Manufacturer: Shenzhen Leshi Video Technology Co.,Ltd	

Note: Report NO.:ATE20190564

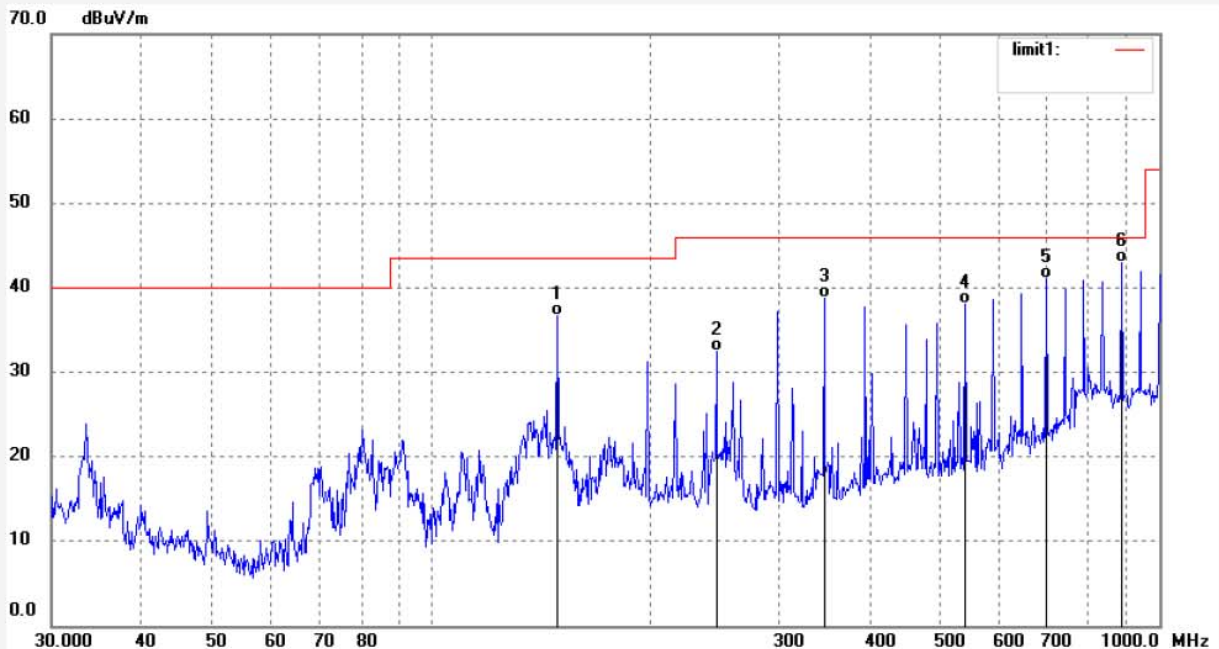

No.	Freq. (MHz)	Reading (dBuV/m)	Factor (dB)	Result (dBuV/m)	Limit (dBuV/m)	Margin (dB)	Detector	Height (cm)	Degree (deg.)	Remark
1	148.9173	64.77	-28.06	36.71	43.50	-6.79	QP	100	302	
2	246.1237	56.13	-23.67	32.46	46.00	-13.54	QP	100	110	
3	346.0740	58.29	-19.46	38.83	46.00	-7.17	QP	100	93	
4	540.7068	53.08	-15.09	37.99	46.00	-8.01	QP	100	146	
5	698.8034	52.61	-11.50	41.11	46.00	-4.89	QP	100	332	
6	887.3976	50.44	-7.41	43.03	46.00	-2.97	QP	100	201	



**ACCURATE TECHNOLOGY CO., LTD.**  
F1,Bldg,A,Changyuan New Material Port Keyuan Rd,  
Science & Industry Park,Nanshan Shenzhen,P.R.China

Site: 1# Chamber  
Tel:+86-0755-26503290  
Fax:+86-0755-26503396

Job No.: FRANK2019 #1033	Polarization: Horizontal
Standard: FCC Class B 3M Radiated	Power Source: AC 120V; 60Hz
Test item: Radiation Test	Date: 19/05/15/
Temp.( C)/Hum.(%) 25 C / 55 %	Time: 8/30/30
EUT: Floodlight Camera	Engineer Signature: Frank
Mode: TX Channel 6(802.11b)	Distance: 3m
Model: L820	
Manufacturer: Shenzhen Leshi Video Technology Co.,Ltd	

Note: Report NO.:ATE20190564

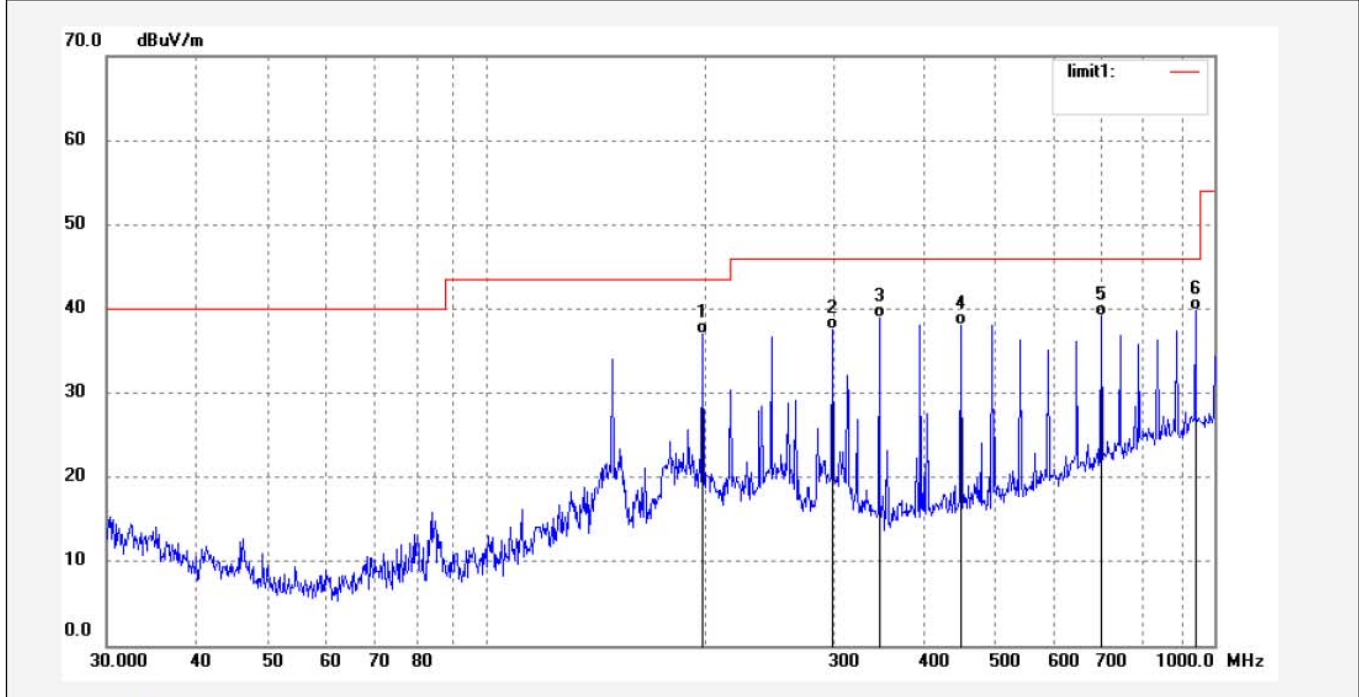

No.	Freq. (MHz)	Reading (dBuV/m)	Factor (dB)	Result (dBuV/m)	Limit (dBuV/m)	Margin (dB)	Detector	Height (cm)	Degree (deg.)	Remark
1	197.9456	61.54	-24.48	37.06	43.50	-6.44	QP	200	201	
2	298.5932	58.81	-21.28	37.53	46.00	-8.47	QP	200	66	
3	346.0740	58.48	-19.46	39.02	46.00	-6.98	QP	200	135	
4	448.8360	55.36	-17.28	38.08	46.00	-7.92	QP	200	41	
5	698.8034	50.62	-11.50	39.12	46.00	-6.88	QP	200	62	
6	942.0180	46.34	-6.47	39.87	46.00	-6.13	QP	200	132	



**ACCURATE TECHNOLOGY CO., LTD.**

F1,Bldg,A,Changyuan New Material Port Keyuan Rd,  
Science & Industry Park,Nanshan Shenzhen,P.R.China

Site: 1# Chamber  
Tel:+86-0755-26503290  
Fax:+86-0755-26503396

Job No.: FRANK2019 #1034	Polarization: Horizontal
Standard: FCC Class B 3M Radiated	Power Source: AC 120V; 60Hz
Test item: Radiation Test	Date: 19/05/15/
Temp.( C)/Hum.(%) 25 C / 55 %	Time: 8/30/49
EUT: Floodlight Camera	Engineer Signature: Frank
Mode: TX Channel 11(802.11b)	Distance: 3m
Model: L820	
Manufacturer: Shenzhen Leshi Video Technology Co.,Ltd	

Note: Report NO.:ATE20190564

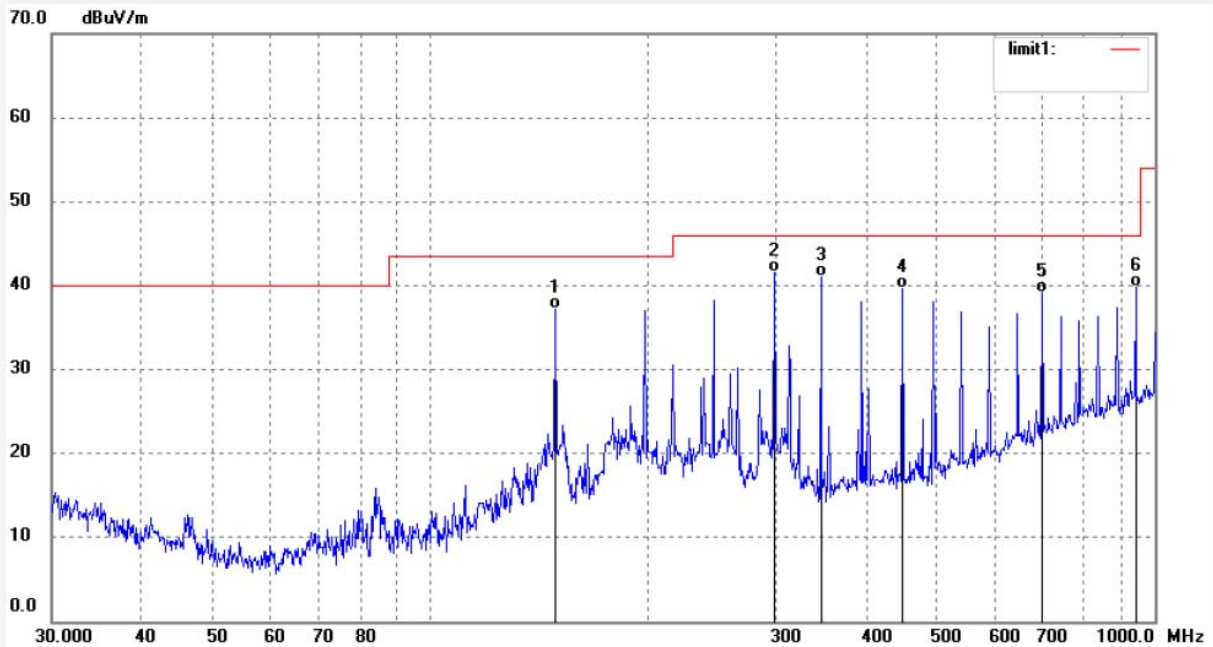

No.	Freq. (MHz)	Reading (dBuV/m)	Factor (dB)	Result (dBuV/m)	Limit (dBuV/m)	Margin (dB)	Detector	Height (cm)	Degree (deg.)	Remark
1	148.9173	65.17	-28.06	37.11	43.50	-6.39	QP	200	156	
2	298.5932	62.81	-21.28	41.53	46.00	-4.47	QP	200	64	
3	346.0740	60.48	-19.46	41.02	46.00	-4.98	QP	200	115	
4	448.8360	56.86	-17.28	39.58	46.00	-6.42	QP	200	96	
5	698.8034	50.62	-11.50	39.12	46.00	-6.88	QP	200	31	
6	942.0180	46.34	-6.47	39.87	46.00	-6.13	QP	200	196	



**ACCURATE TECHNOLOGY CO., LTD.**

F1,Bldg,A,Changyuan New Material Port Keyuan Rd,  
Science & Industry Park,Nanshan Shenzhen,P.R.China

Site: 1# Chamber  
Tel:+86-0755-26503290  
Fax:+86-0755-26503396

Job No.: FRANK2019 #1035	Polarization: Vertical
Standard: FCC Class B 3M Radiated	Power Source: AC 120V; 60Hz
Test item: Radiation Test	Date: 19/05/15/
Temp.( C)/Hum.(%) 25 C / 55 %	Time: 8/31/38
EUT: Floodlight Camera	Engineer Signature: Frank
Mode: TX Channel 11(802.11b)	Distance: 3m
Model: L820	
Manufacturer: Shenzhen Leshi Video Technology Co.,Ltd	

Note: Report NO.:ATE20190564

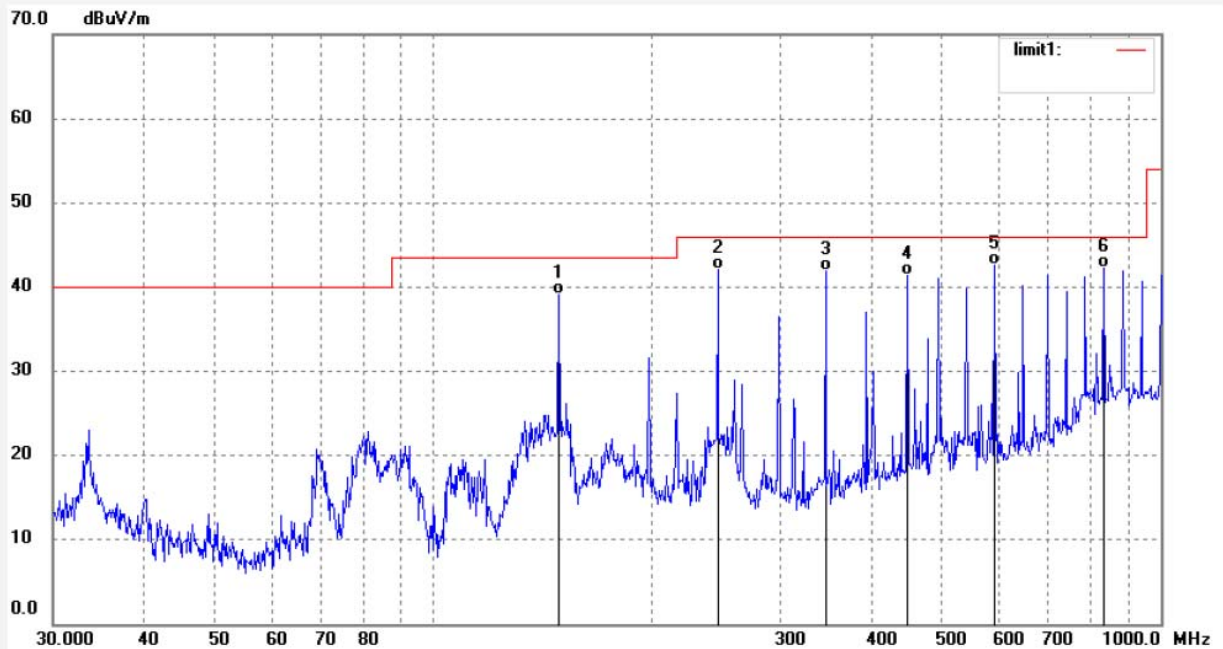

No.	Freq. (MHz)	Reading (dBuV/m)	Factor (dB)	Result (dBuV/m)	Limit (dBuV/m)	Margin (dB)	Detector	Height (cm)	Degree (deg.)	Remark
1	148.9173	67.18	-28.06	39.12	43.50	-4.38	QP	100	44	
2	246.1237	65.70	-23.67	42.03	46.00	-3.97	QP	100	52	
3	346.0740	61.43	-19.46	41.97	46.00	-4.03	QP	100	211	
4	448.8360	58.74	-17.28	41.46	46.00	-4.54	QP	100	96	
5	590.3509	56.55	-13.88	42.67	46.00	-3.33	QP	100	226	
6	835.9447	50.59	-8.28	42.31	46.00	-3.69	QP	100	103	

Above 1G



**ACCURATE TECHNOLOGY CO., LTD.**

F1,Bldg,A,Changyuan New Material Port Keyuan Rd,  
Science & Industry Park,Nanshan Shenzhen,P.R.China

Site: 1# Chamber  
Tel:+86-0755-26503290  
Fax:+86-0755-26503396

Job No.: FRANK2019 #1036	Polarization: Horizontal
Standard: FCC PK	Power Source: AC 120V; 60Hz
Test item: Radiation Test	Date: 19/05/15/
Temp.( C)/Hum.(%) 25 C / 55 %	Time: 9/14/22
EUT: Floodlight Camera	Engineer Signature: Frank
Mode: TX Channel 1(802.11b)	Distance: 3m
Model: L820	
Manufacturer: Shenzhen Leshi Video Technology Co.,Ltd	

Note: Report NO.:ATE20190564

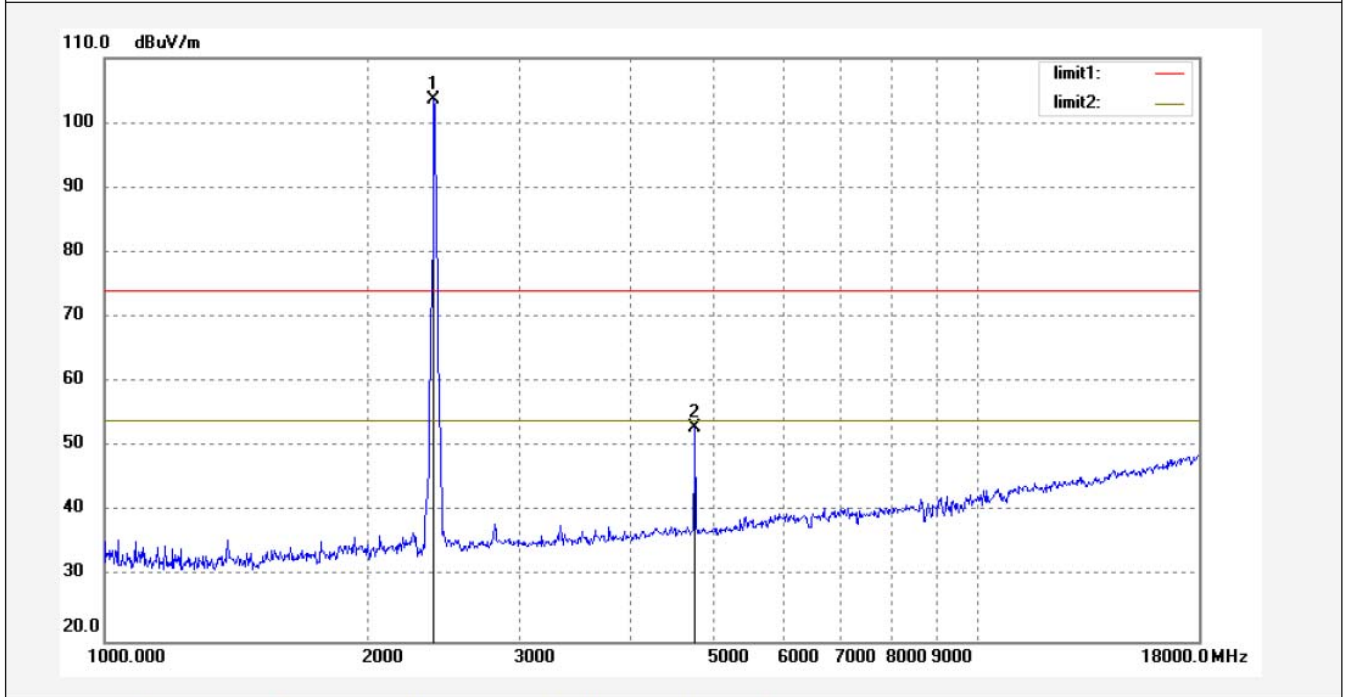

No.	Freq. (MHz)	Reading (dBuV/m)	Factor (dB)	Result (dBuV/m)	Limit (dBuV/m)	Margin (dB)	Detector	Height (cm)	Degree (deg.)	Remark
1	2412.000	109.95	-6.33	103.62			peak	200	85	
2	4824.000	52.19	0.82	53.01	74.00	-20.99	peak	200	101	





**ACCURATE TECHNOLOGY CO., LTD.**  
F1,Bldg,A,Changyuan New Material Port Keyuan Rd,  
Science & Industry Park,Nanshan Shenzhen,P.R.China

Site: 1# Chamber  
Tel:+86-0755-26503290  
Fax:+86-0755-26503396

Job No.: FRANK2019 #1037	Polarization: Vertical
Standard: FCC PK	Power Source: AC 120V; 60Hz
Test item: Radiation Test	Date: 19/05/15/
Temp.( C)/Hum.(%) 25 C / 55 %	Time: 9/15/02
EUT: Floodlight Camera	Engineer Signature: Frank
Mode: TX Channel 1(802.11b)	Distance: 3m
Model: L820	
Manufacturer: Shenzhen Leshi Video Technology Co.,Ltd	

Note: Report NO.:ATE20190564

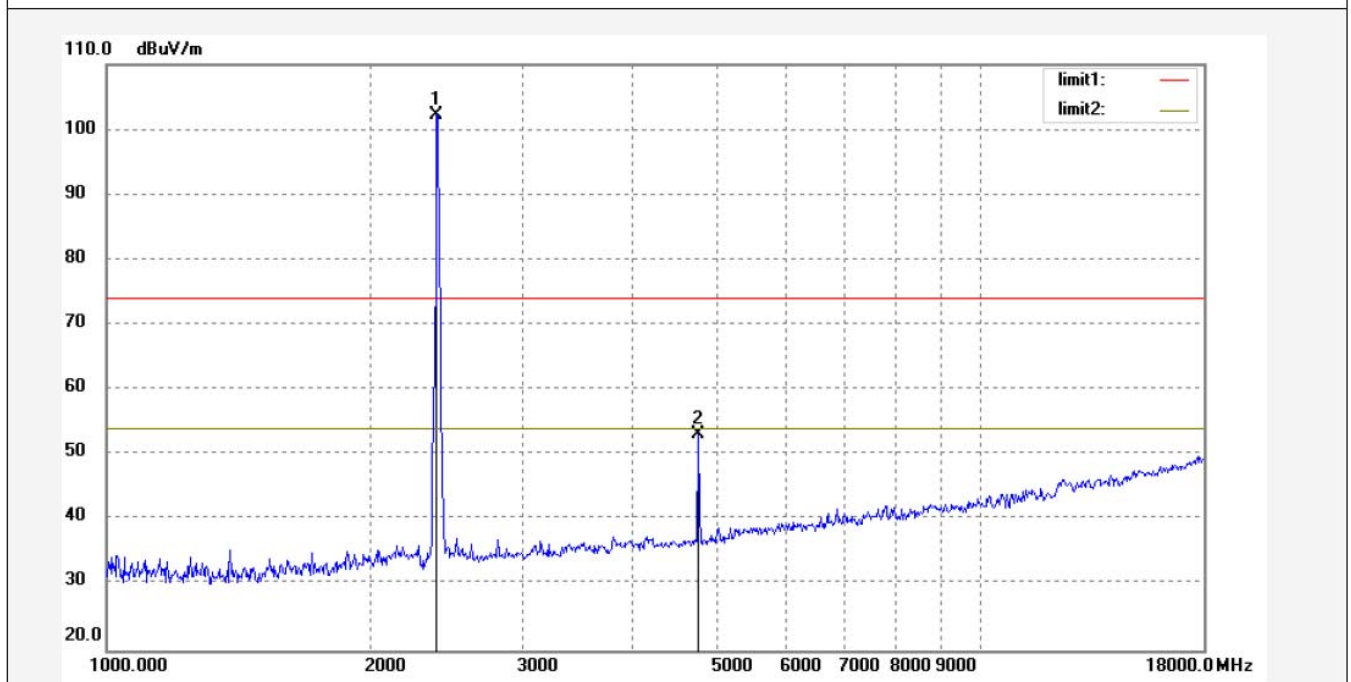

No.	Freq. (MHz)	Reading (dBuV/m)	Factor (dB)	Result (dBuV/m)	Limit (dBuV/m)	Margin (dB)	Detector	Height (cm)	Degree (deg.)	Remark
1	2412.000	108.63	-6.33	102.30			peak	150	98	
2	4824.000	52.37	0.82	53.19	74.00	-20.81	peak	150	101	



**ACCURATE TECHNOLOGY CO., LTD.**

F1,Bldg,A,Changyuan New Material Port Keyuan Rd,  
Science & Industry Park,Nanshan Shenzhen,P.R.China

Site: 1# Chamber  
Tel:+86-0755-26503290  
Fax:+86-0755-26503396

Job No.: FRANK2019 #1038	Polarization: Vertical
Standard: FCC PK	Power Source: AC 120V; 60Hz
Test item: Radiation Test	Date: 19/05/15/
Temp.( C)/Hum.(%) 25 C / 55 %	Time: 9/16/15
EUT: Floodlight Camera	Engineer Signature: Frank
Mode: TX Channel 6(802.11b)	Distance: 3m
Model: L820	
Manufacturer: Shenzhen Leshi Video Technology Co.,Ltd	

Note: Report NO.:ATE20190564

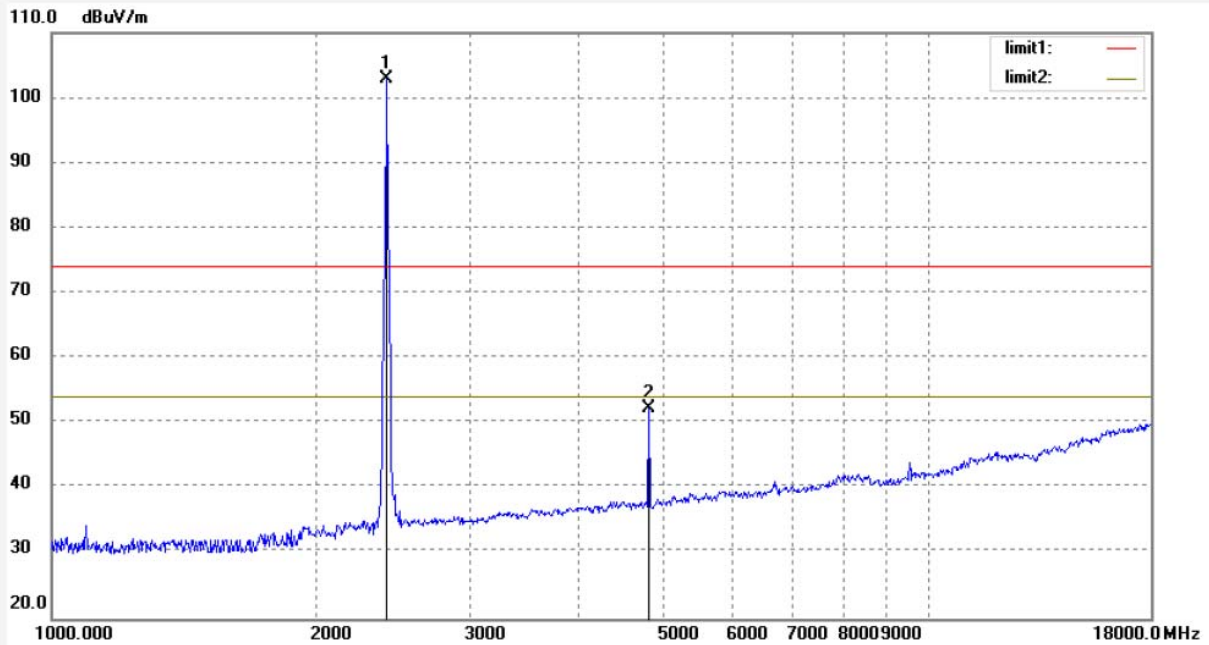

No.	Freq. (MHz)	Reading (dBuV/m)	Factor (dB)	Result (dBuV/m)	Limit (dBuV/m)	Margin (dB)	Detector	Height (cm)	Degree (deg.)	Remark
1	2437.000	109.12	-6.20	102.92			peak	150	305	
2	4874.000	51.11	1.07	52.18	74.00	-21.82	peak	150	106	



**ACCURATE TECHNOLOGY CO., LTD.**  
F1,Bldg.A,Changyuan New Material Port Keyuan Rd,  
Science & Industry Park,Nanshan Shenzhen,P.R.China

Site: 1# Chamber  
Tel:+86-0755-26503290  
Fax:+86-0755-26503396

Job No.: FRANK2019 #1039

Polarization: Horizontal

Standard: FCC PK

Power Source: AC 120V; 60Hz

Test item: Radiation Test

Date: 19/05/15/

Temp.( C)/Hum.(%) 25 C / 55 %

Time: 9/17/12

EUT: Floodlight Camera

Engineer Signature: Frank

Mode: TX Channel 6(802.11b)

Distance: 3m

Model: L820

Manufacturer: Shenzhen Leshi Video Technology Co.,Ltd

Note: Report NO.:ATE20190564

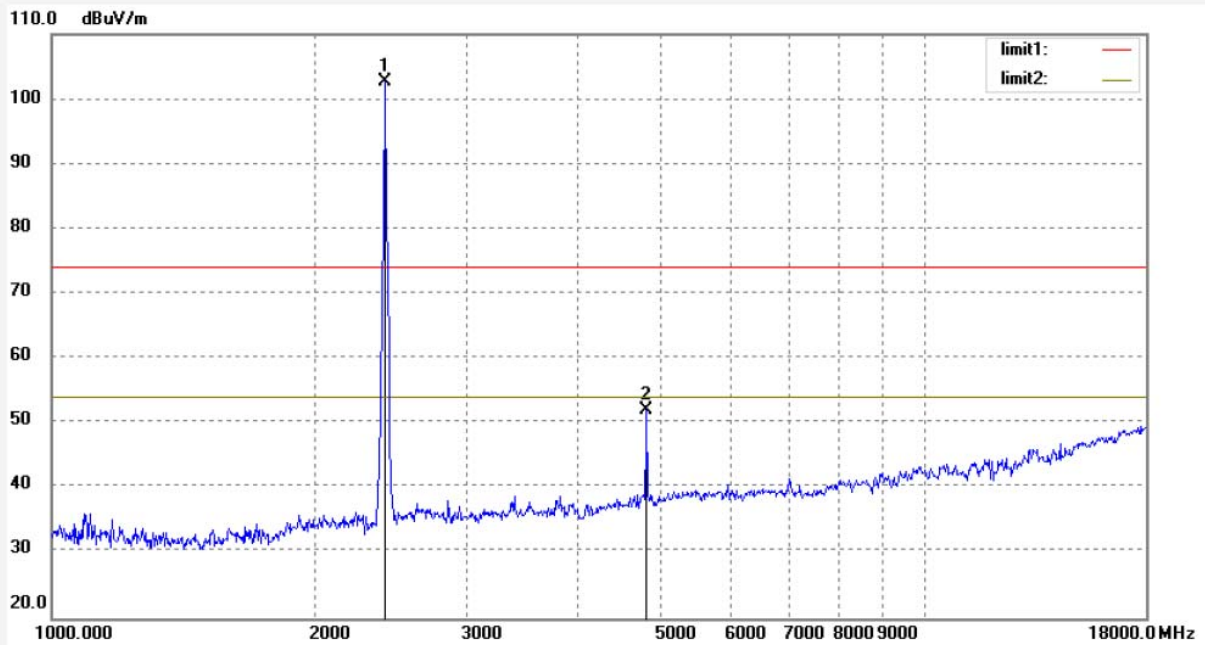

No.	Freq. (MHz)	Reading (dBuV/m)	Factor (dB)	Result (dBuV/m)	Limit (dBuV/m)	Margin (dB)	Detector	Height (cm)	Degree (deg.)	Remark
1	2437.000	108.94	-6.20	102.74			peak	200	71	
2	4874.000	50.99	1.07	52.06	74.00	-21.94	peak	200	198	



**ACCURATE TECHNOLOGY CO., LTD.**  
F1,Bldg,A,Changyuan New Material Port Keyuan Rd,  
Science & Industry Park,Nanshan Shenzhen,P.R.China

Site: 1# Chamber  
Tel:+86-0755-26503290  
Fax:+86-0755-26503396

Job No.: FRANK2019 #1040

Standard: FCC PK

Test item: Radiation Test

Temp.( C)/Hum.(%) 25 C / 55 %

EUT: Floodlight Camera

Mode: TX Channel 11(802.11b)

Model: L820

Manufacturer: Shenzhen Leshi Video Technology Co.,Ltd

Polarization: Horizontal

Power Source: AC 120V; 60Hz

Date: 19/05/15/

Time: 9/18/23

Engineer Signature: Frank

Distance: 3m

Note: Report NO.:ATE20190564

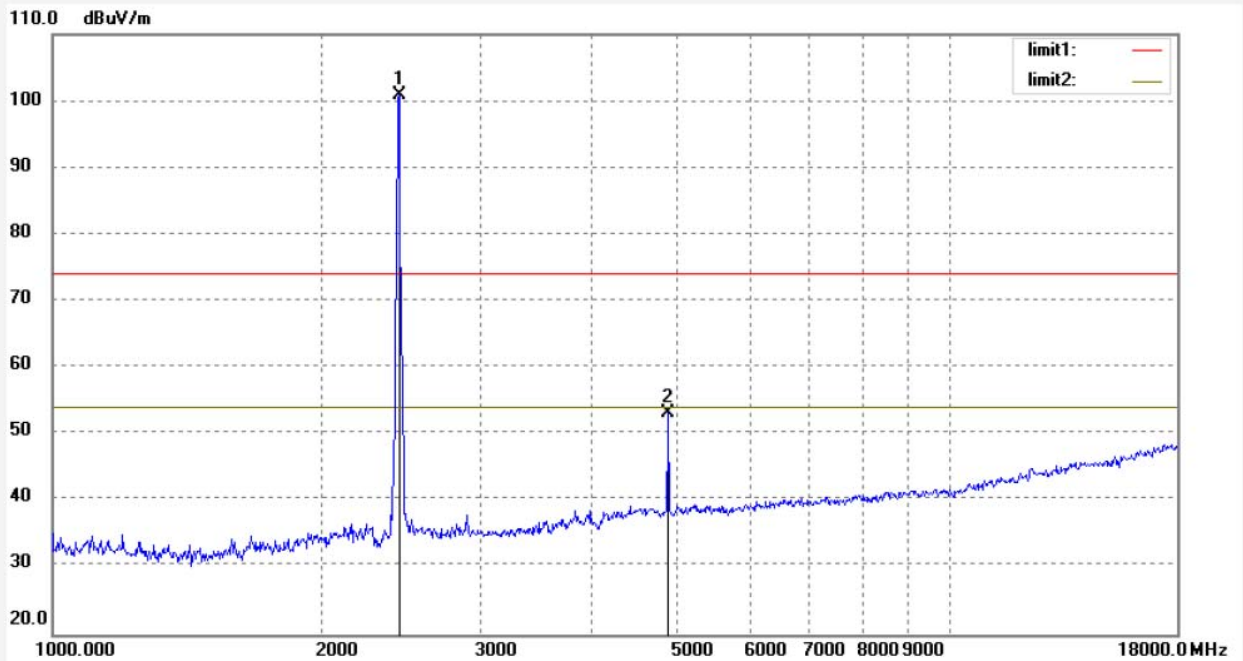

No.	Freq. (MHz)	Reading (dBuV/m)	Factor (dB)	Result (dBuV/m)	Limit (dBuV/m)	Margin (dB)	Detector	Height (cm)	Degree (deg.)	Remark
1	2462.000	107.02	-6.10	100.92			peak	200	312	
2	4924.000	51.84	1.32	53.16	74.00	-20.84	peak	200	51	



**ACCURATE TECHNOLOGY CO., LTD.**

F1,Bldg,A,Changyuan New Material Port Keyuan Rd,  
Science & Industry Park,Nanshan Shenzhen,P.R.China

Site: 1# Chamber  
Tel:+86-0755-26503290  
Fax:+86-0755-26503396

Job No.: FRANK2019 #1041	Polarization: Vertical
Standard: FCC PK	Power Source: AC 120V; 60Hz
Test item: Radiation Test	Date: 19/05/15/
Temp.( C)/Hum.(%) 25 C / 55 %	Time: 9/19/14
EUT: Floodlight Camera	Engineer Signature: Frank
Mode: TX Channel 11(802.11b)	Distance: 3m
Model: L820	
Manufacturer: Shenzhen Leshi Video Technology Co.,Ltd	

Note: Report NO.:ATE20190564

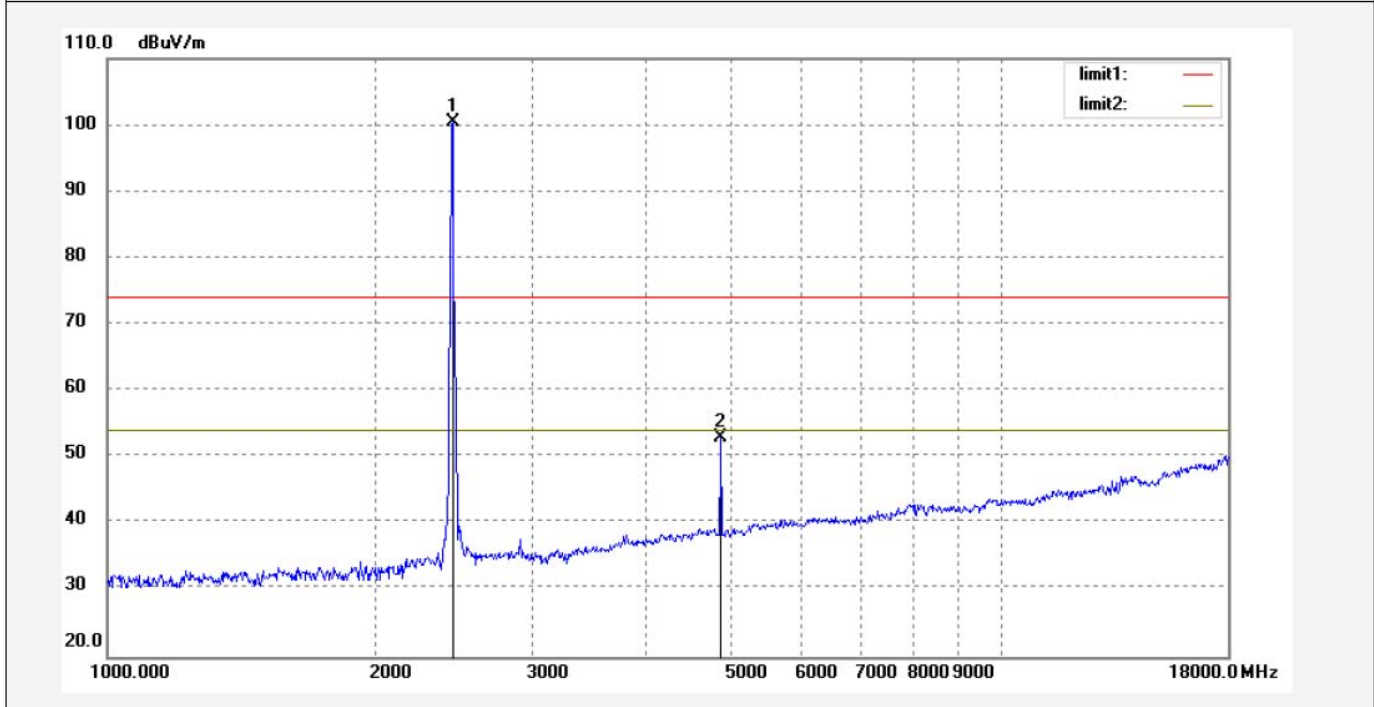

No.	Freq. (MHz)	Reading (dBuV/m)	Factor (dB)	Result (dBuV/m)	Limit (dBuV/m)	Margin (dB)	Detector	Height (cm)	Degree (deg.)	Remark
1	2462.000	106.57	-6.10	100.47			peak	150	316	
2	4924.000	51.64	1.32	52.96	74.00	-21.04	peak	150	102	

## 13.ANTENNA REQUIREMENT

### 13.1.The Requirement

According to Section 15.203, an intentional radiator shall be designed to ensure that no antenna other than that furnished by the responsible party shall be used with the device.

### 13.2.Antenna Construction

Device is equipped with Integral Antenna, which isn't displaced by other antenna. The Antenna gain of EUT is 3dBi. Therefore, the equipment complies with the antenna requirement of Section 15.203.

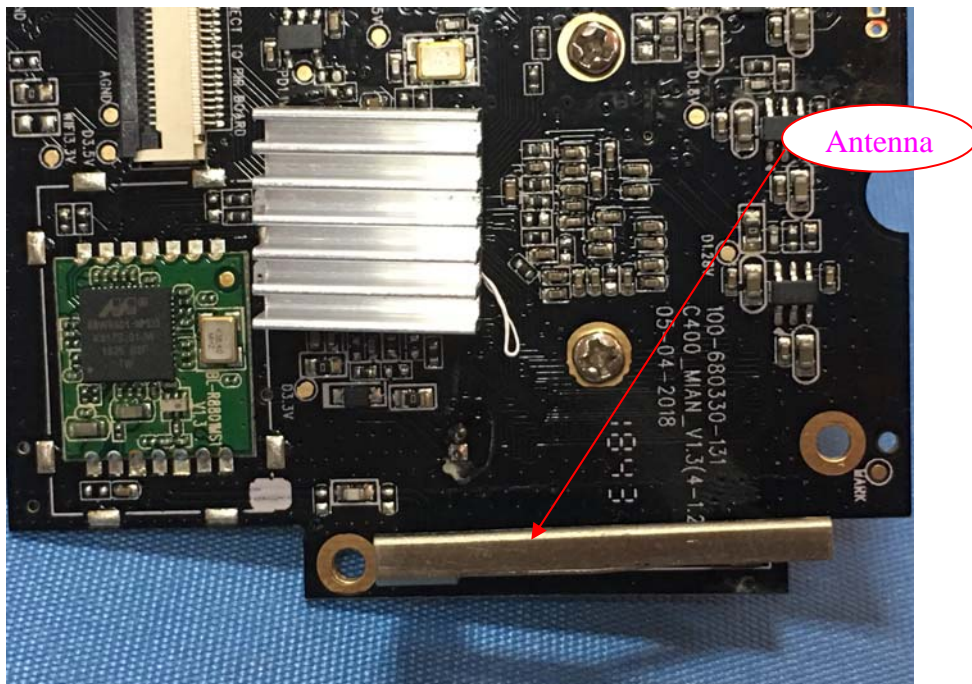

----- THE END OF TEST REPORT -----