



RF TEST REPORT

Product Name: Veho MR-8 Bluetooth speaker

Model Name: VSS-501-MR8, MR-Series

FCC ID: 2AJP3VSS-501-MR8

Issued For : Shenzhen Betnew Technology Co.,Ltd

Room 313, Building C, Hongwan Business center, Gushu,
Xixiang, Baoan Dist., Shenzhen, China

Issued By : Shenzhen LGT Test Service Co., Ltd.

Room 205, Building 13, Zone B, Zhenxiong Industrial Park,
No.177, Renmin West Road, Jinsha, Kengzi Street, Pingshan
District, Shenzhen, Guangdong, China

Report Number: LGT23H085RF03

Sample Received Date: Sep. 04, 2023

Date of Test: Sep. 04, 2023 – Sep. 19, 2023

Date of Issue: Sep. 19, 2023

The test report is effective only with both signature and specialized stamp. This report shall not be reproduced except in full without the written approval of the Laboratory. The results in this report only apply to the tested sample.



TEST REPORT CERTIFICATION

Applicant: Shenzhen Betnew Technology Co.,Ltd
Address: Room 313, Building C, Hongwan Business center, Gushu, Xixiang, Baoan Dist., Shenzhen, China

Manufacturer: Shenzhen Betnew Technology Co.,Ltd
Address: Room 313, Building C, Hongwan Business center, Gushu, Xixiang, Baoan Dist., Shenzhen, China

Product Name: Veho MR-8 Bluetooth speaker

Trademark: Veho

Model Name: VSS-501-MR8, MR-Series

Sample Status: Normal

| APPLICABLE STANDARDS | |
|--|--------------|
| STANDARD | TEST RESULTS |
| FCC Part 15.247, Subpart C ANSI C63.10-2013 | PASS |

Prepared by:

Zane Shan

Zane Shan
Engineer

Approved by:

Vita Li

Vita Li
Technical Director





| Table of Contents | Page |
|--|-------------|
| 1. SUMMARY OF TEST RESULTS | 6 |
| 1.1 TEST FACTORY | 7 |
| 1.2 MEASUREMENT UNCERTAINTY | 7 |
| 2. GENERAL INFORMATION | 8 |
| 2.1 GENERAL DESCRIPTION OF THE EUT | 8 |
| 2.2 DESCRIPTION OF THE TEST MODES | 10 |
| 2.3 FREQUENCY HOPPING SYSTEM REQUIREMENTS | 10 |
| 2.4 TABLE OF PARAMETERS OF TEST SOFTWARE SETTING | 12 |
| 2.5 DESCRIPTION OF NECESSARY ACCESSORIES AND SUPPORT UNITS | 12 |
| 2.6 EQUIPMENTS LIST | 13 |
| 3. EMC EMISSION TEST | 14 |
| 3.1 CONDUCTED EMISSION MEASUREMENT | 14 |
| 3.2 RADIATED EMISSION MEASUREMENT | 18 |
| 4. CONDUCTED SPURIOUS & BAND EDGE EMISSION | 30 |
| 4.1 LIMIT | 30 |
| 4.2 TEST PROCEDURE | 30 |
| 4.3 TEST SETUP | 31 |
| 4.4 EUT OPERATION CONDITIONS | 31 |
| 4.5 TEST RESULTS | 31 |
| 5. NUMBER OF HOPPING CHANNEL | 32 |
| 5.1 LIMIT | 32 |
| 5.2 TEST PROCEDURE | 32 |
| 5.3 TEST SETUP | 32 |
| 5.4 EUT OPERATION CONDITIONS | 32 |
| 5.5 TEST RESULTS | 32 |
| 6. AVERAGE TIME OF OCCUPANCY | 33 |
| 6.1 LIMIT | 33 |
| 6.2 TEST PROCEDURE | 33 |
| 6.3 TEST SETUP | 33 |
| 6.4 EUT OPERATION CONDITIONS | 33 |
| 6.5 TEST RESULTS | 33 |
| 7. HOPPING CHANNEL SEPARATION MEASUREMENT | 34 |
| 7.1 LIMIT | 34 |
| 7.2 TEST PROCEDURE | 34 |



| Table of Contents | Page |
|-------------------------------------|-------------|
| 7.3 TEST SETUP | 34 |
| 7.4 EUT OPERATION CONDITIONS | 34 |
| 7.5 TEST RESULTS | 34 |
| 8. BANDWIDTH TEST | 35 |
| 8.1 LIMIT | 35 |
| 8.2 TEST PROCEDURE | 35 |
| 8.3 TEST SETUP | 35 |
| 8.4 EUT OPERATION CONDITIONS | 35 |
| 8.5 TEST RESULTS | 35 |
| 9. OUTPUT POWER TEST | 36 |
| 9.1 LIMIT | 36 |
| 9.2 TEST PROCEDURE | 36 |
| 9.3 TEST SETUP | 36 |
| 9.4 EUT OPERATION CONDITIONS | 36 |
| 9.5 TEST RESULTS | 36 |
| 10. ANTENNA REQUIREMENT | 37 |
| 10.1 STANDARD REQUIREMENT | 37 |
| 10.2 EUT ANTENNA | 37 |
| APPENDIX I: TEST RESULTS | 38 |
| DUTY CYCLE | 38 |
| MAXIMUM PEAK CONDUCTED OUTPUT POWER | 42 |
| -20DB BANDWIDTH | 43 |
| OCCUPIED CHANNEL BANDWIDTH | 47 |
| CARRIER FREQUENCIES SEPARATION | 51 |
| BAND EDGE | 55 |
| BAND EDGE(HOPPING) | 60 |
| CONDUCTED RF SPURIOUS EMISSION | 65 |
| NUMBER OF HOPPING CHANNEL | 72 |
| DWELL TIME | 74 |



Revision History

| Rev. | Issue Date | Contents |
|------|---------------|---------------|
| 00 | Sep. 19, 2023 | Initial Issue |
| | | |



1. SUMMARY OF TEST RESULTS

Test procedures according to the technical standards:
KDB 558074 D01 15.247 Meas Guidance v05r02.

| FCC Part 15.247, Subpart C | | | |
|-----------------------------------|---|----------|--------|
| Standard Section | Test Item | Judgment | Remark |
| 15.207 | Conducted Emission | PASS | -- |
| 15.247(a)(1) | Hopping Channel Separation | PASS | -- |
| 15.247(a)(1)&(b)(1) | Output Power | PASS | -- |
| 15.209 | Radiated Spurious Emission | PASS | -- |
| 15.247(d) | Conducted Spurious & Band Edge Emission | PASS | -- |
| 15.247(a)(1)(iii) | Number of Hopping Frequency | PASS | -- |
| 15.247(a)(1)(iii) | Dwell Time | PASS | -- |
| 15.247(a)(1) | Bandwidth | PASS | -- |
| 15.205 | Restricted bands of operation | PASS | -- |
| Part 15.247(d)/part 15.209(a) | Band Edge Emission | PASS | -- |
| 15.203 | Antenna Requirement | PASS | -- |

NOTE:

(1) 'N/A' denotes test is not applicable in this Test Report.

(2) All tests are according to ANSI C63.10-2013.



1.1 TEST FACTORY

| | |
|---------------------------|--|
| Company Name: | Shenzhen LGT Test Service Co., Ltd. |
| Address: | Room 205, Building 13, Zone B, Zhenxiong Industrial Park, No.177, Renmin West Road, Jinsha, Kengzi Street, Pingshan District, Shenzhen, Guangdong, China |
| Accreditation Certificate | A2LA Certificate No.: 6727.01 |
| | FCC Registration No.: 746540 |
| | CAB ID: CN0136 |

1.2 MEASUREMENT UNCERTAINTY

The reported uncertainty of measurement $y \pm U$, where expanded uncertainty U is based on a standard uncertainty multiplied by a coverage factor of $k=2$, providing a level of confidence of approximately **95** %.

| No. | Item | Uncertainty |
|-----|-----------------------------------|----------------------|
| 1 | RF output power, conducted | $\pm 0.68\text{dB}$ |
| 2 | Unwanted Emissions, conducted | $\pm 2.988\text{dB}$ |
| 3 | All emissions, radiated 9K-30MHz | $\pm 2.84\text{dB}$ |
| 4 | All emissions, radiated 30M-1GHz | $\pm 4.39\text{dB}$ |
| 5 | All emissions, radiated 1G-6GHz | $\pm 5.10\text{dB}$ |
| 6 | All emissions, radiated >6G | $\pm 5.48\text{dB}$ |
| 7 | Conducted Emission (9KHz-150KHz) | $\pm 2.79\text{dB}$ |
| 8 | Conducted Emission (150KHz-30MHz) | $\pm 2.80\text{dB}$ |

Note: The measurement uncertainty is not included in the test result.



2. GENERAL INFORMATION

2.1 GENERAL DESCRIPTION OF THE EUT

| | |
|-------------------------|---|
| Product Name: | Veho MR-8 Bluetooth speaker |
| Trademark: | Veho |
| Model Name: | VSS-501-MR8 |
| Series Model: | MR-Series |
| Model Difference: | Only model differences. |
| Channel List: | Please refer to the Note 3. |
| Bluetooth: | Frequency:2402 – 2480 MHz Modulation: GFSK(1Mbps), $\pi/4$ -DQPSK(2Mbps), 8DPSK(3Mbps) |
| Antenna Type: | PCB |
| Antenna Gain: | -0.58dBi |
| Rating: | DC 5V 2A |
| Battery: | Capacity: 4000mAh Rated Voltage: 3.7 V |
| Hardware Version: | V1.3 |
| Software Version: | V2.22 |
| Connecting I/O Port(s): | Please refer to the Note 1. |

Note:

1. For a more detailed features description, please refer to the manufacturer's specifications or the User Manual.
2. The antenna information refers to the manufacturer provide report, applicable only to the tested sample identified in the report. Due to the incorrect antenna information, a series of problems such as the accuracy of the test results will be borne by the customer.



3.

| Channel List | | | | | |
|--------------|-----------------|---------|-----------------|---------|-----------------|
| Channel | Frequency (MHz) | Channel | Frequency (MHz) | Channel | Frequency (MHz) |
| 00 | 2402 | 27 | 2429 | 54 | 2456 |
| 01 | 2403 | 28 | 2430 | 55 | 2457 |
| 02 | 2404 | 29 | 2431 | 56 | 2458 |
| 03 | 2405 | 30 | 2432 | 57 | 2459 |
| 04 | 2406 | 31 | 2433 | 58 | 2460 |
| 05 | 2407 | 32 | 2434 | 59 | 2461 |
| 06 | 2408 | 33 | 2435 | 60 | 2462 |
| 07 | 2409 | 34 | 2436 | 61 | 2463 |
| 08 | 2410 | 35 | 2437 | 62 | 2464 |
| 09 | 2411 | 36 | 2438 | 63 | 2465 |
| 10 | 2412 | 37 | 2439 | 64 | 2466 |
| 11 | 2413 | 38 | 2440 | 65 | 2467 |
| 12 | 2414 | 39 | 2441 | 66 | 2468 |
| 13 | 2415 | 40 | 2442 | 67 | 2469 |
| 14 | 2416 | 41 | 2443 | 68 | 2470 |
| 15 | 2417 | 42 | 2444 | 69 | 2471 |
| 16 | 2418 | 43 | 2445 | 70 | 2472 |
| 17 | 2419 | 44 | 2446 | 71 | 2473 |
| 18 | 2420 | 45 | 2447 | 72 | 2474 |
| 19 | 2421 | 46 | 2448 | 73 | 2475 |
| 20 | 2422 | 47 | 2449 | 74 | 2476 |
| 21 | 2423 | 48 | 2450 | 75 | 2477 |
| 22 | 2424 | 49 | 2451 | 76 | 2478 |
| 23 | 2425 | 50 | 2452 | 77 | 2479 |
| 24 | 2426 | 51 | 2453 | 78 | 2480 |
| 25 | 2427 | 52 | 2454 | | |
| 26 | 2428 | 53 | 2455 | | |



2.2 DESCRIPTION OF THE TEST MODES

To investigate the maximum EMI emission characteristics generated from EUT, the test system was pre-scanning tested based on the consideration of following EUT operation mode or test configuration mode which possibly have effect on EMI emission level. Each of these EUT operation mode(s) or test configuration mode(s) mentioned above was evaluated respectively.

| Worst Mode | Description | Data Rate/Modulation |
|------------|-------------|------------------------|
| Mode 1 | TX CH00 | 1Mbps/GFSK |
| Mode 2 | TX CH39 | 1Mbps/GFSK |
| Mode 3 | TX CH78 | 1Mbps/GFSK |
| Mode 4 | TX CH00 | 2 Mbps/ $\pi/4$ -DQPSK |
| Mode 5 | TX CH39 | 2 Mbps/ $\pi/4$ -DQPSK |
| Mode 6 | TX CH78 | 2 Mbps/ $\pi/4$ -DQPSK |
| Mode 7 | TX CH00 | 3 Mbps/8DPSK |
| Mode 8 | TX CH39 | 3 Mbps/8DPSK |
| Mode 9 | TX CH78 | 3 Mbps/8DPSK |
| Mode 10 | Hopping | GFSK |
| Mode 11 | Hopping | $\pi/4$ -DQPSK |
| Mode 12 | Hopping | 8DPSK |

Note:

(1) The measurements are performed at all Bit Rate of Transmitter, the worst data was reported.

(2) We tested for all available U.S. voltage and frequencies (For 120V, 50/60Hz and 240V, 50/60Hz) for which the device is capable of operation, and the worst case of 120V/ 60Hz is shown in the report.

(3) The battery is fully charged during the radiated and RF conducted test.

For AC Conducted Emission

| Test Case | |
|-----------------------|------------------------|
| AC Conducted Emission | Mode 13: Keeping BT TX |

2.3 FREQUENCY HOPPING SYSTEM REQUIREMENTS

(1) Standard and Limit

According to FCC Part 15.247(a)(1), The system shall hop to channel frequencies that are selected at the system hopping rate from a pseudo randomly ordered list of hopping frequencies. Each frequency must be used equally on the average by each transmitter. The system receivers shall have input bandwidths that match the hopping channel bandwidths of their corresponding transmitters and shall shift frequencies in synchronization with the transmitted signals.

Frequency hopping spread spectrum systems are not required to employ all available hopping channels during each transmission. However, the system, consisting of both the transmitter and the receiver, must be designed to comply with all of the regulations in this section should the transmitter be presented with a continuous data (or information) stream. In addition, a system employing short transmission bursts must comply with the definition of a frequency hopping system and must distribute its transmissions over the minimum number of hopping channels specified in this section.

The incorporation of intelligence within a frequency hopping spread spectrum system that permits the system to recognize other users within the spectrum band so that it individually and independently chooses and adapts its hop sets to avoid hopping on occupied channels is permitted. The coordination of frequency hopping systems in any other manner for the express purpose of avoiding the simultaneous occupancy of individual hopping frequencies by multiple transmitters is not permitted.



(2) The Pseudorandom sequence may be generated in a nine-stage shift register whose 5th and 9th stage outputs are added in a modulo-two addition stage. And the result is fed back to the input of the first stage. The sequence begins with the first one of 9 consecutive ones: i.e. the shift register is initialized with nine ones.

Number of shift register stages: 9

Length of pseudo-random sequence: $2^9 - 1 = 511$ bits

Longest sequence of zeros: 8 (non-inverted signal)

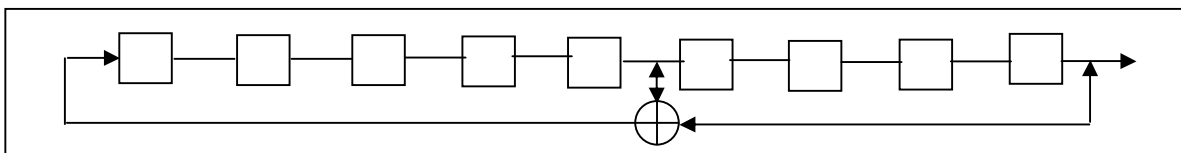

Linear Feedback Shift Register for Generator of the PRBS sequence

An example of Pseudorandom Frequency Hopping Sequence as follow:

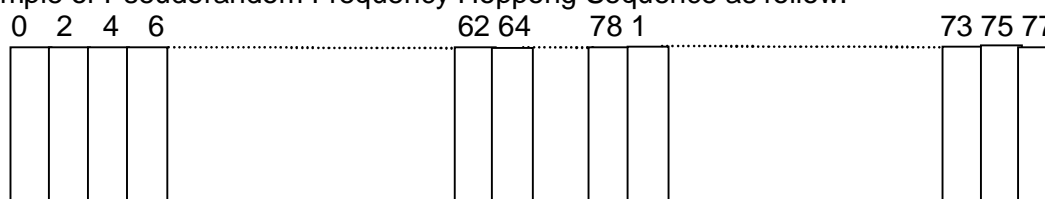

Each frequency used equally on the average by each transmitter.

The system receivers have input bandwidths that match the hopping channel bandwidths of their corresponding transmitters and shift frequencies in synchronization with the transmitted signals.

(3) Frequency Hopping System

This transmitter device is frequency hopping device and complies with FCC part 15.247 rule.

This device uses Bluetooth radio which operates in 2400-2483.5 MHz band. Bluetooth uses a radio technology called frequency-hopping spread spectrum, which chops up the data being sent and transmits chunks of it on up to 79 bands (1 MHz each; centred from 2402 to 2480 MHz) in the range 2,400-2,483.5MHz. The transmitter switches hop frequencies 1,600 times per second to assure a high degree of data security. All Bluetooth devices participating in a given piconet are synchronized to the frequency-hopping channel for the piconet. The frequency hopping sequence is determined by the master's device address and the phase of the hopping sequence (the frequency to hop at a specific time) is determined by the master's internal clock. Therefore, all slaves in a piconet must know the master's device address and must synchronize their clocks with the master's clock.

Adaptive Frequency Hopping (AFH) was introduced in the Bluetooth specification to provide an effective way for a Bluetooth radio to counteract normal interference. AFH identifies "bad" channels, where either other wireless device are interfering with the Bluetooth signal or the Bluetooth signal is interfering with another device. The AFH-enabled Bluetooth device will then communicate with other devices within its piconet to share details of any identified bad channels. The devices will then switch to alternative available "good" channels, away from the areas of interference, thus having no impact on the bandwidth used.

This device was tested with a bluetooth system receiver to check that the device maintained hopping synchronization, and the device complied with these requirements FCC Part 15.247 rule.



2.4 TABLE OF PARAMETERS OF TEST SOFTWARE SETTING

During testing channel & power controlling software provided by the customer was used to control the operating channel as well as the output power level. The RF output power selection is for the setting of RF output power expected by the customer and is going to be fixed on the firmware of the final end product power parameters of FHSS.

| Test software Version | Test program: Bluetooth | |
|-----------------------|-------------------------|---------------|
| FCC_1.0.1708.29002 | Mode Or Modulation type | Power setting |
| | 1M | Default |
| | 2M | Default |
| | 3M | Default |

2.5 DESCRIPTION OF NECESSARY ACCESSORIES AND SUPPORT UNITS

The EUT has been tested as an independent unit together with other necessary accessories or support units. The following support units or accessories were used to form a representative test configuration during the tests.

Accessories Equipment

| Description | Manufacturer | Model | S/N | Rating |
|-------------|--------------|-------|-----|--------|
| | | | | |
| | | | | |
| | | | | |

Auxiliary Equipment

| Description | Manufacturer | Model | S/N | Rating |
|-------------|--------------|--------|-----|--------|
| Laptop | HUAWEI | HKF-16 | N/A | N/A |
| | | | | |
| | | | | |

Note:

- (1) For detachable type I/O cable should be specified the length in cm in 『Length』 column.
- (2) “YES” is means “with core”; “NO” is means “without core”.



2.6 EQUIPMENTS LIST

| Conducted Emission | | | | | |
|---------------------------|---------------------|------------------|-------------------|------------------|-------------------|
| Equipment | Manufacturer | Model No. | Serial No. | Cal. Date | Cal. Until |
| EMI Test Receiver | R&S | ESU8 | 100372 | 2023.04.13 | 2024.04.12 |
| LISN | COM-POWER | LI-115 | 02032 | 2023.04.07 | 2024.04.06 |
| LISN | SCHWARZBECK | NNLK 8121 | 00847 | 2023.04.07 | 2024.04.06 |
| LISN | SCHWARZBECK | NNLK 8122 | 00160 | 2023.04.07 | 2024.04.06 |
| Transient Limiter | CYBERTEK | EM5010A | E225010004 9 | 2023.04.07 | 2024.04.06 |
| Temperature & Humidity | KTJ | TA218B | N.A | 2023.04.24 | 2024.04.23 |
| Testing Software | EMC-I_V1.4.0.3_SKET | | | | |

| Radiated Test equipment | | | | | |
|-------------------------------------|---------------------|-------------------|-------------------|------------------|-------------------|
| Equipment | Manufacturer | Model No. | Serial No. | Cal. Date | Cal. Until |
| EMI Test Receiver | R&S | ESU8 | 100372 | 2023.04.13 | 2024.04.12 |
| Active loop Antenna | ETS | 6502 | 00049544 | 2022.06.02 | 2025.06.01 |
| Spectrum Analyzer | Keysight | N9010B | MY60242508 | 2023.04.10 | 2024.04.09 |
| Bilog Antenna(30M-1G) | SCHWARZBECK | VULB 9168 | 2705 | 2022.06.05 | 2025.06.04 |
| Horn Antenna(1-18G) | SCHWARZBECK | 3115 | 10SL0060 | 2022.06.02 | 2025.06.01 |
| Horn Antenna(18-40G) | A-INFO | LB-180400-KF | J211060273 | 2022.06.08 | 2025.06.07 |
| Pre-amplifier(30M-1G) | EMtrace | RP01A | 02019 | 2023.04.07 | 2024.04.06 |
| Pre-amplifier(1-26.5G) | Agilent | 8449B | 3008A4722 | 2023.04.07 | 2024.04.06 |
| Pre-amplifier(18-40G) | com-mw | LNPA_18-40-0 1 | 18050003 | 2023.04.07 | 2024.04.06 |
| Wireless Communications Test Set | R&S | CMW 500 | 137737 | 2023.04.13 | 2024.04.12 |
| Temperature & Humidity | KTJ | TA218B | N.A | 2023.04.24 | 2024.04.23 |
| Testing Software | EMC-I_V1.4.0.3_SKET | | | | |

| Conducted Test equipment | | | | | |
|--|---------------------|------------------|-------------------|------------------|-------------------|
| Equipment | Manufacturer | Model No. | Serial No. | Cal. Date | Cal. Until |
| Signal Analyzer | Keysight | N9010B | MY60242508 | 2023.04.10 | 2024.04.09 |
| Wireless Communications Test Set | R&S | CMW 500 | 137737 | 2023.04.13 | 2024.04.12 |
| MXG Vector Signal Generator | Keysight | N5182B | MY59100717 | 2023.04.07 | 2024.04.06 |
| Power Sensor | MW | MW100-RFCB | MW220324L G-33 | 2023.04.13 | 2024.04.12 |
| Temperature & Humidity | KTJ | TA218B | N.A | 2023.04.24 | 2024.04.23 |
| Temperature & Humidity test chamber | AISRY | LX-1000L | 171200018 | 2023.05.10 | 2024.05.09 |
| Attenuator | eastsheep | 90db | N.A | 2023.04.10 | 2024.04.09 |
| Testing Software | MTS8200_V2.0.0.0_MW | | | | |



3. EMC EMISSION TEST

3.1 CONDUCTED EMISSION MEASUREMENT

3.1.1 POWER LINE CONDUCTED EMISSION LIMITS

The radio frequency voltage that is conducted back onto the AC power line on any frequency or frequencies, within the band 150 kHz to 30 MHz, shall not exceed the limits in the following table.

| FREQUENCY (MHz) | Conducted Emissionlimit (dBuV) | |
|-----------------|--------------------------------|-----------|
| | Quasi-peak | Average |
| 0.15 -0.5 | 66 - 56 * | 56 - 46 * |
| 0.50 -5.0 | 56.00 | 46.00 |
| 5.0 -30.0 | 60.00 | 50.00 |

Note:

- (1) The tighter limit applies at the band edges.
- (2) The limit of “ * ” marked band means the limitation decreases linearly with the logarithm of the frequency in the range.

The following table is the setting of the receiver

| Receiver Parameters | Setting |
|---------------------|----------|
| Attenuation | 10 dB |
| Start Frequency | 0.15 MHz |
| Stop Frequency | 30 MHz |
| IF Bandwidth | 9 kHz |



3.1.2 TEST PROCEDURE

- a. The EUT is 0.8 m from the horizontal ground plane and 0.4 m from the vertical ground plane with EUT being connected to the power mains through a line impedance stabilization network (LISN). All other support equipments are powered from additional LISN(s). The LISN provides 50 Ohm/ 50uH of coupling impedance for the measuring instrument.
- b. Interconnecting cables that hang closer than 40 cm to the ground plane shall be folded back and forth in the center forming a bundle 30 to 40 cm long.
- c. I/O cables that are not connected to a peripheral shall be bundled in the center. The end of the cable may be terminated, if required, using the correct terminating impedance. The overall length shall not exceed 1 m.
- d. LISN is at least 80 cm from the nearest part of EUT chassis.
- e. For the actual test configuration, please refer to the related Item –EUT Test Photos.

3.1.3 TEST SETUP

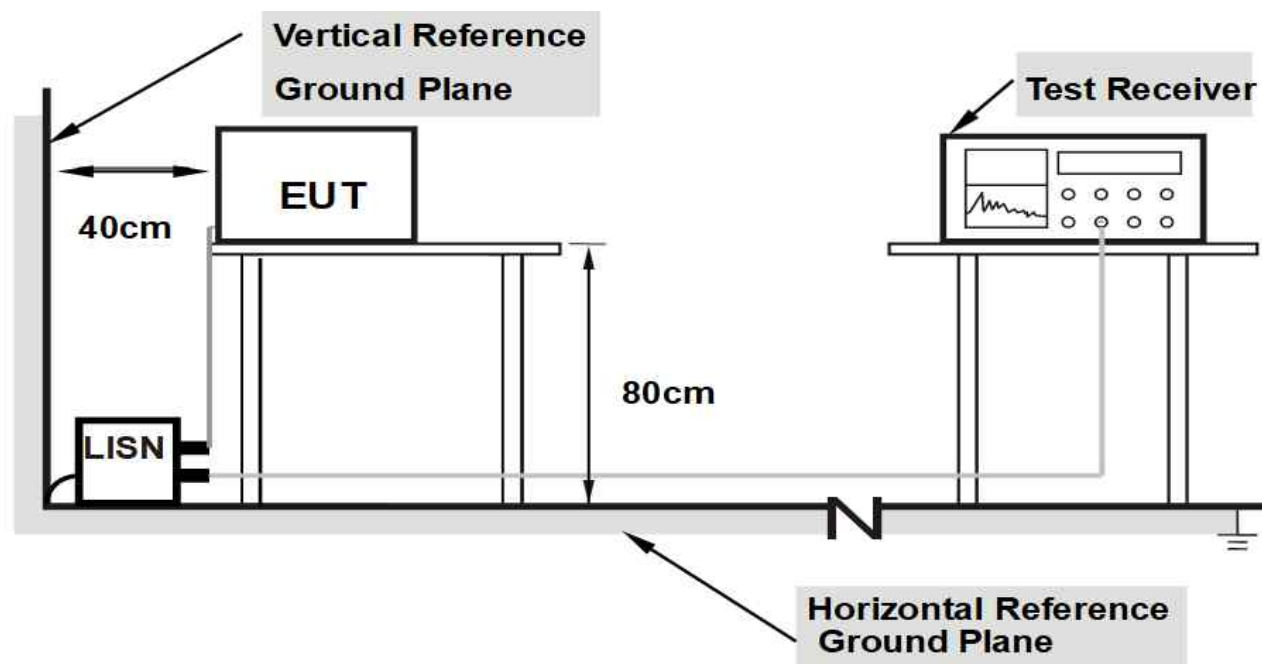

Note: 1. Support units were connected to second LISN.

2. Both of LISNs (AMN) are 80 cm from EUT and at least 80 cm from other units and other metal planes support units.

3.1.4 EUT OPERATING CONDITIONS

The EUT was configured for testing in a typical fashion (as a customer would normally use it). The EUT has been programmed to continuously transmit during test. This operating condition was tested and used to collect the included data.



3.1.5 TEST RESULT

| | |
|----------------------------------|-----------------------|
| Project: LGT23H085 | Test Engineer: LiuH |
| EUT: Veho MR-8 Bluetooth speaker | Temperature: 26.0°C |
| M/N: VSS-501-MR8 | Humidity: 45%RH |
| Test Voltage: AC 120V/60Hz | Test Data: 2023-09-05 |
| Test Mode: TX DH5 2402 | |
| Note: Worst Case | |

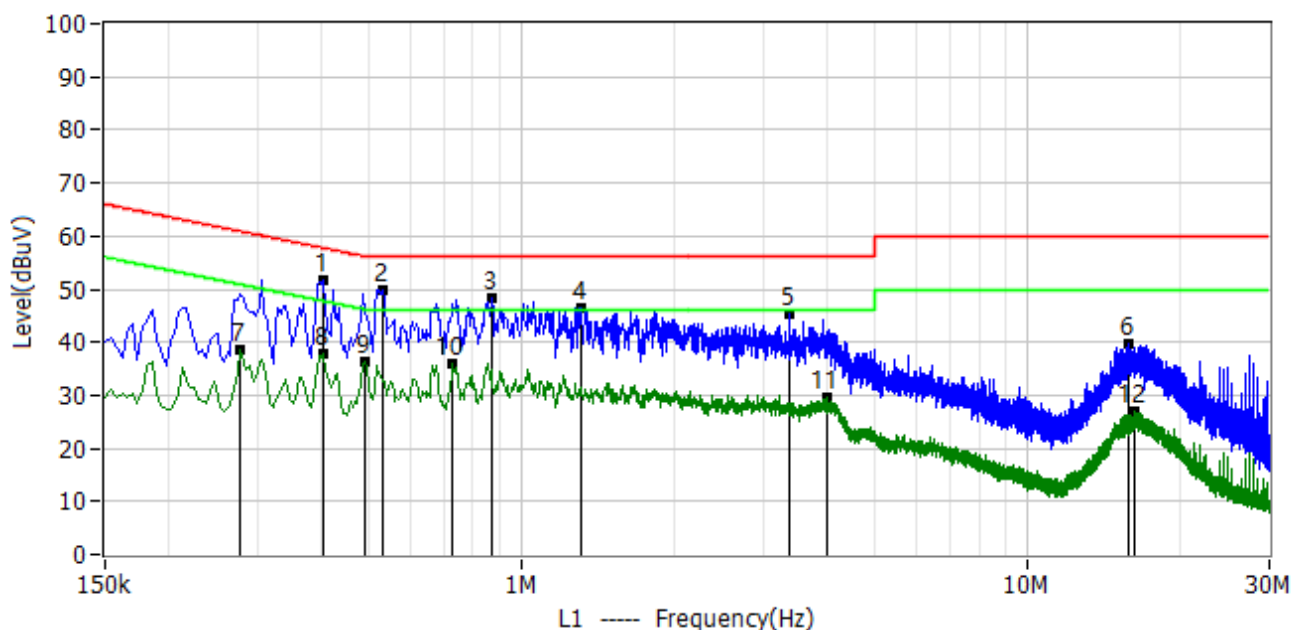

| No. | Frequency MHz | Reading dBuV | Factor dB | Level dBuV | Limit dBuV | Margin dB | Detector | Polar |
|-----|---------------|--------------|-----------|------------|------------|-----------|----------|-------|
| 1* | 0.406 | 41.08 | 10.58 | 51.66 | 57.73 | -6.07 | QP | L1 |
| 2* | 0.530 | 39.34 | 10.58 | 49.92 | 56.00 | -6.08 | QP | L1 |
| 3* | 0.874 | 37.88 | 10.58 | 48.46 | 56.00 | -7.54 | QP | L1 |
| 4* | 1.310 | 35.92 | 10.64 | 46.56 | 56.00 | -9.44 | QP | L1 |
| 5* | 3.378 | 34.52 | 10.73 | 45.25 | 56.00 | -10.75 | QP | L1 |
| 6* | 15.794 | 28.69 | 11.13 | 39.82 | 60.00 | -20.18 | QP | L1 |
| 7* | 0.278 | 28.02 | 10.59 | 38.61 | 50.88 | -12.26 | AV | L1 |
| 8* | 0.406 | 27.33 | 10.58 | 37.91 | 47.73 | -9.82 | AV | L1 |
| 9* | 0.490 | 25.93 | 10.58 | 36.51 | 46.17 | -9.66 | AV | L1 |
| 10* | 0.730 | 25.52 | 10.58 | 36.10 | 46.00 | -9.90 | AV | L1 |
| 11* | 4.010 | 18.70 | 10.72 | 29.42 | 46.00 | -16.58 | AV | L1 |
| 12* | 16.294 | 15.67 | 11.15 | 26.82 | 50.00 | -23.18 | AV | L1 |



| | |
|----------------------------------|-----------------------|
| Project: LGT23H085 | Test Engineer: LiuH |
| EUT: Veho MR-8 Bluetooth speaker | Temperature: 26.0°C |
| M/N: VSS-501-MR8 | Humidity: 45%RH |
| Test Voltage: AC 120V/60Hz | Test Data: 2023-09-05 |
| Test Mode: TX DH5 2402 | |
| Note: Worst Case | |

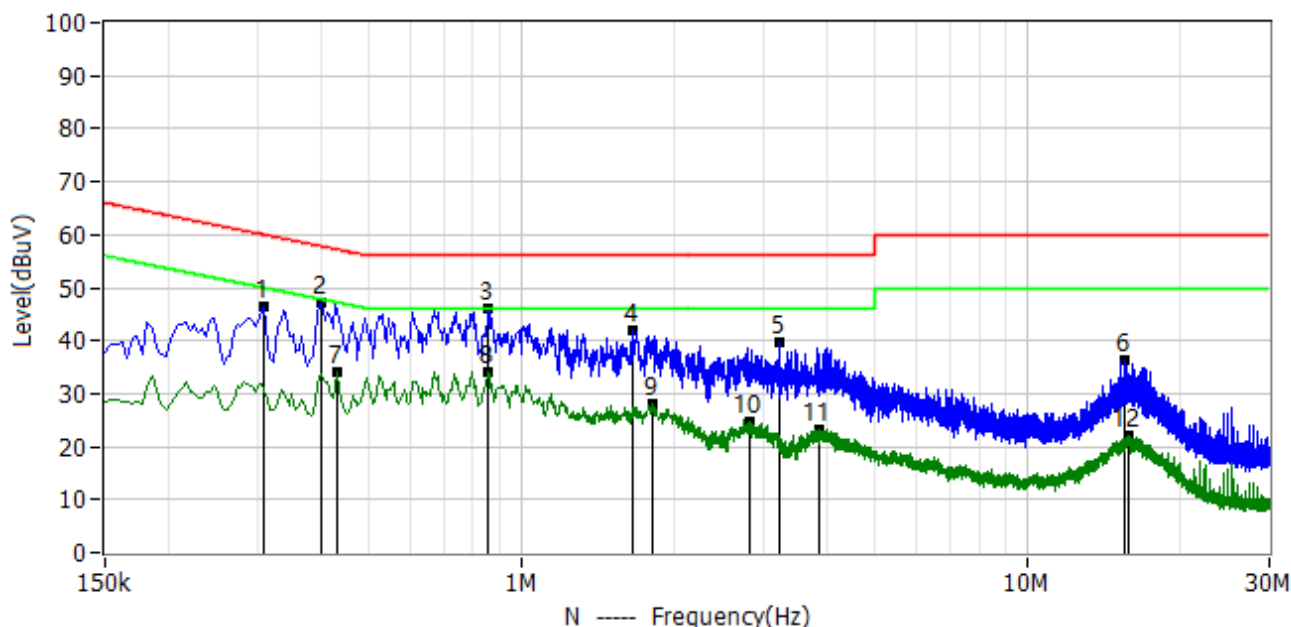

| No. | Frequency MHz | Reading dBuV | Factor dB | Level dBuV | Limit dBuV | Margin dB | Detector | Polar |
|-----|---------------|--------------|-----------|------------|------------|-----------|----------|-------|
| 1* | 0.310 | 35.73 | 10.59 | 46.32 | 59.97 | -13.65 | QP | N |
| 2* | 0.402 | 36.59 | 10.58 | 47.17 | 57.81 | -10.64 | QP | N |
| 3* | 0.858 | 35.35 | 10.58 | 45.93 | 56.00 | -10.07 | QP | N |
| 4* | 1.658 | 31.09 | 10.69 | 41.78 | 56.00 | -14.22 | QP | N |
| 5* | 3.222 | 28.91 | 10.73 | 39.64 | 56.00 | -16.36 | QP | N |
| 6* | 15.506 | 25.09 | 11.17 | 36.26 | 60.00 | -23.74 | QP | N |
| 7* | 0.430 | 23.43 | 10.58 | 34.01 | 47.25 | -13.24 | AV | N |
| 8* | 0.858 | 23.40 | 10.58 | 33.98 | 46.00 | -12.02 | AV | N |
| 9* | 1.814 | 17.49 | 10.72 | 28.21 | 46.00 | -17.79 | AV | N |
| 10* | 2.818 | 13.88 | 10.74 | 24.62 | 46.00 | -21.38 | AV | N |
| 11* | 3.850 | 12.55 | 10.72 | 23.27 | 46.00 | -22.73 | AV | N |
| 12* | 15.770 | 10.81 | 11.18 | 21.99 | 50.00 | -28.01 | AV | N |



3.2 RADIATED EMISSION MEASUREMENT

3.2.1 RADIATED EMISSION LIMITS

In any 100 kHz bandwidth outside the operating frequency band. In case the emission fall within the Restricted band specified on Part15.205 (a)&209(a) limit in the table and according to ANSI C63.10-2013 below has to be followed.

LIMITS OF RADIATED EMISSION MEASUREMENT (0.009MHz - 1000MHz)

| Frequencies (MHz) | Field Strength (micorvolts/meter) | Measurement Distance (meters) |
|-------------------|-----------------------------------|-------------------------------|
| 0.009~0.490 | 2400/F(KHz) | 300 |
| 0.490~1.705 | 24000/F(KHz) | 30 |
| 1.705~30.0 | 30 | 30 |
| 30~88 | 100 | 3 |
| 88~216 | 150 | 3 |
| 216~960 | 200 | 3 |
| Above 960 | 500 | 3 |

LIMITS OF RADIATED EMISSION MEASUREMENT (1GHz-25 GHz)

| FREQUENCY (MHz) | (dBuV/m) (at 3M) | |
|-----------------|------------------|---------|
| | PEAK | AVERAGE |
| Above 1000 | 74 | 54 |

Notes:

- (1) The limit for radiated test was performed according to FCC PART 15C.
- (2) The tighter limit applies at the band edges.
- (3) Emission level (dBuV/m)=20log Emission level (uV/m).

LIMITS OF RESTRICTED FREQUENCY BANDS

| FREQUENCY (MHz) | FREQUENCY (MHz) | FREQUENCY (MHz) | FREQUENCY (GHz) |
|-------------------|---------------------|-----------------|-----------------|
| 0.090-0.110 | 16.42-16.423 | 399.9-410 | 4.5-5.15 |
| 0.495-0.505 | 16.69475-16.69525 | 608-614 | 5.35-5.46 |
| 2.1735-2.1905 | 16.80425-16.80475 | 960-1240 | 7.25-7.75 |
| 4.125-4.128 | 25.5-25.67 | 1300-1427 | 8.025-8.5 |
| 4.17725-4.17775 | 37.5-38.25 | 1435-1626.5 | 9.0-9.2 |
| 4.20725-4.20775 | 73-74.6 | 1645.5-1646.5 | 9.3-9.5 |
| 6.215-6.218 | 74.8-75.2 | 1660-1710 | 10.6-12.7 |
| 6.26775-6.26825 | 108-121.94 | 1718.8-1722.2 | 13.25-13.4 |
| 6.31175-6.31225 | 123-138 | 2200-2300 | 14.47-14.5 |
| 8.291-8.294 | 149.9-150.05 | 2310-2390 | 15.35-16.2 |
| 8.362-8.366 | 156.52475-156.52525 | 2483.5-2500 | 17.7-21.4 |
| 8.37625-8.38675 | 156.7-156.9 | 2690-2900 | 22.01-23.12 |
| 8.41425-8.41475 | 162.0125-167.17 | 3260-3267 | 23.6-24.0 |
| 12.29-12.293 | 167.72-173.2 | 3332-3339 | 31.2-31.8 |
| 12.51975-12.52025 | 240-285 | 3345.8-3358 | 36.43-36.5 |
| 12.57675-12.57725 | 322-335.4 | 3600-4400 | Above 38.6 |
| 13.36-13.41 | | | |



For Radiated Emission

| Spectrum Parameter | Setting |
|---------------------------------------|---|
| Attenuation | Auto |
| Detector | Peak/QP/AV |
| Start Frequency | 9 KHz/150KHz (Peak/QP/AV) |
| Stop Frequency | 150KHz/30MHz (Peak/QP/AV) |
| RB / VB (emission in restricted band) | 200Hz (From 9kHz to 0.15MHz)/ 9KHz (From 0.15MHz to 30MHz); 200Hz (From 9kHz to 0.15MHz)/ 9KHz (From 0.15MHz to 30MHz) |

| Spectrum Parameter | Setting |
|---------------------------------------|--------------------|
| Attenuation | Auto |
| Detector | Peak/QP |
| Start Frequency | 30 MHz (Peak/QP) |
| Stop Frequency | 1000 MHz (Peak/QP) |
| RB / VB (emission in restricted band) | 120 KHz / 300 KHz |

| Spectrum Parameter | Setting |
|---------------------------------------|---|
| Attenuation | Auto |
| Detector | Peak |
| Start Frequency | 1000 MHz (Peak/AV) |
| Stop Frequency | 10th carrier hamonic (Peak/AV) |
| RB / VB (emission in restricted band) | 1 MHz / 3 MHz(Peak) 1 MHz/1/T MHz(AVG) |

For Restricted band

| Spectrum Parameter | Setting |
|----------------------|--|
| Detector | Peak |
| Start/Stop Frequency | Lower Band Edge: 2310 to 2410 MHz Upper Band Edge: 2476 to 2500 MHz |
| RB / VB | 1 MHz / 3 MHz(Peak) 1 MHz/1/T MHz(AVG) |

| Receiver Parameter | Setting |
|------------------------|--------------------------------------|
| Attenuation | Auto |
| Start ~ Stop Frequency | 9kHz~90kHz / RB 200Hz for PK & AV |
| Start ~ Stop Frequency | 90kHz~110kHz / RB 200Hz for QP |
| Start ~ Stop Frequency | 110kHz~490kHz / RB 200Hz for PK & AV |
| Start ~ Stop Frequency | 490kHz~30MHz / RB 9kHz for QP |
| Start ~ Stop Frequency | 30MHz~1000MHz / RB 120kHz for QP |



3.2.2 TEST PROCEDURE

- a. The measuring distance at 3 m shall be used for measurements at frequency 0.009MHz up to 1GHz, and above 1GHz.
- b. The EUT was placed on the top of a rotating table 0.8 m (above 1GHz is 1.5 m) above the ground at a 3 m anechoic chamber test site. The table was rotated 360 degree to determine the position of the highest radiation.
- c. The height of the equipment shall be 0.8 m (above 1GHz is 1.5 m); the height of the test antenna shall vary between 1 m to 4 m. Horizontal and vertical polarization of the antenna are set to make the measurement.
- d. The initial step in collecting conducted emission data is a spectrum analyzer peak detector mode pre-scanning the measurement frequency range. Significant peaks are then marked and QuasiPeak detector mode will be re-measured.
- e. If the Peak Mode measured value is compliance with and lower than Quasi Peak Mode Limit, the EUT shall be deemed to meet QP Limits and no additional QP Mode measurement was performed.
- f. For the actual test configuration, please refer to the related Item –EUT Test Photos.

Note:

Both horizontal and vertical antenna polarities were tested and performed pretest to three orthogonal axis. The worst case emissions were reported.

3.2.3 DEVIATION FROM TEST STANDARD

No deviation.

3.2.4 TESTSETUP

(A) Radiated Emission Test-Up Frequency Below 30MHz

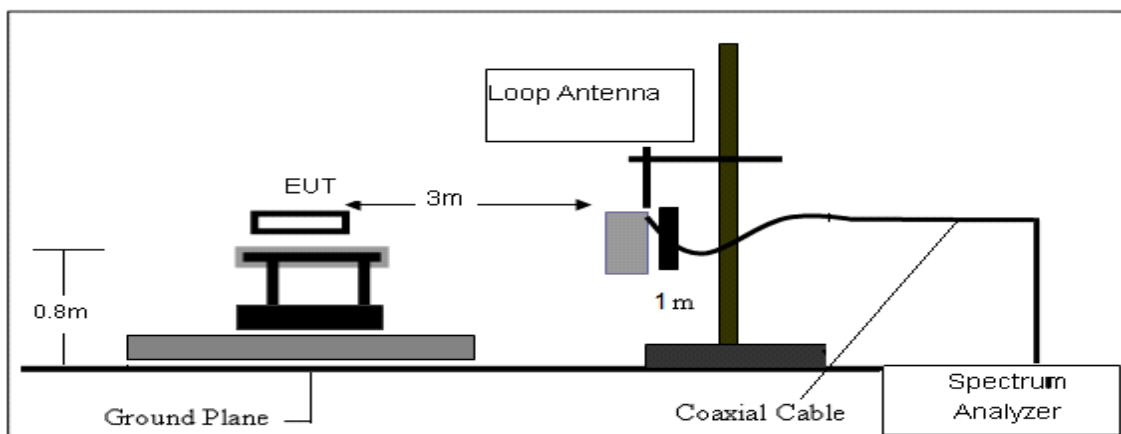

(B) Radiated Emission Test-Up Frequency 30MHz~1GHz

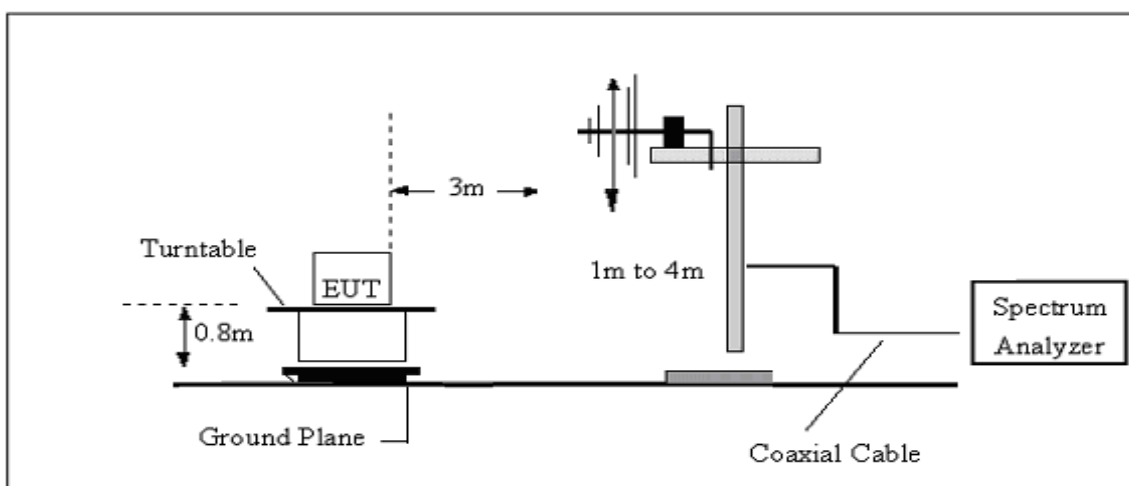

(C) Radiated Emission Test-Up Frequency Above 1GHz

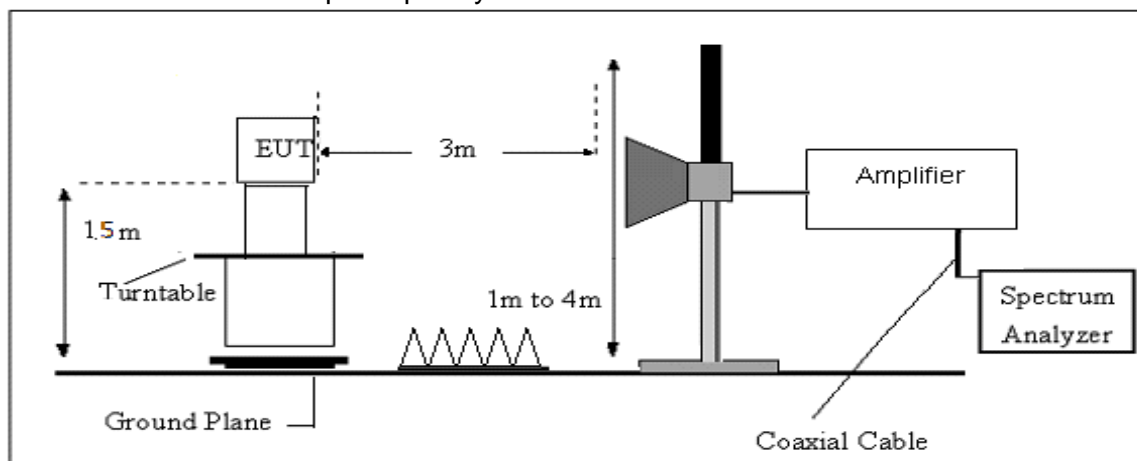

3.2.5 EUT OPERATING CONDITIONS

Please refer to section 3.1.4 of this report.



3.2.6 FIELD STRENGTH CALCULATION

The field strength is calculated by adding the Antenna Factor and Cable Factor and subtracting the Amplifier Gain and Duty Cycle Correction Factor (if any) from the measured reading. The basic equation with a sample calculation is as follows:

$$FS = RA + AF + CL - AG$$

Where

FS = Field Strength

CL = Cable Attenuation Factor (Cable Loss)

RA = Reading Amplitude

AG = Amplifier Gain

AF = Antenna Factor

For example

| Frequency (MHz) | FS (dB μ V/m) | RA (dB μ V/m) | AF (dB) | CL (dB) | AG (dB) | Factor (dB) |
|--------------------|----------------------|----------------------|------------|------------|------------|----------------|
| 300 | 40 | 58.1 | 12.2 | 1.6 | 31.9 | -18.1 |

$$\text{Factor} = \text{AF} + \text{CL} - \text{AG}$$



3.2.7 TEST RESULTS

Results of Radiated Emissions (9 KHz~30MHz)

| No. | Frequency | Reading dBuV | Factor dB/m | Level dBuV/m | Limit dBuV/m | Margin dB | Detector | Remark |
|-----|-----------|-----------------|----------------|-----------------|-----------------|--------------|----------|-------------|
| 1* | - | - | - | - | - | - | - | See Note |

Note:

The emission from 9 kHz to 30MHz was pre-tested and found the result was 20dB lower than the limit, and the permissible value has no need to be reported.

Distance extrapolation factor = $40 \log (\text{specific distance} / \text{test distance})$ (dB);

Limit line = specific limits (dBuV) + distance extrapolation factor.



Results of Radiated Emissions (30MHz~1000MHz)

Note: All the modes have been tested, found worst case at GFSK(1Mbps), recorded the worst case results in this report.

| | |
|----------------------------------|-----------------------------|
| Project: LGT23H085 | Test Engineer: Xiangdong Ma |
| EUT: Veho MR-8 Bluetooth speaker | Temperature: 25.8°C |
| M/N: VSS-501-MR8 | Humidity: 50%RH |
| Test Voltage: Battery | Test Data: 2023-09-06 |
| Test Mode: TX DH5 2402 | |
| Note: Worst Case | |

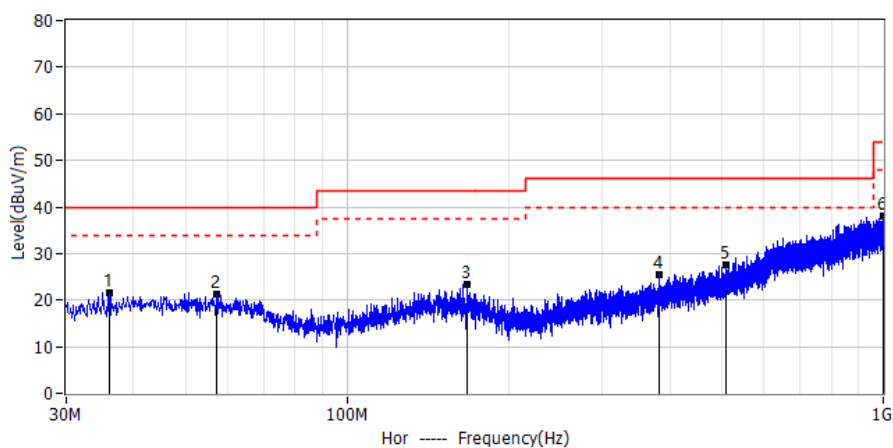

| No. | Frequency | Reading dBuV | Factor dB/m | Level dBuV/m | Limit dBuV/m | Margin dB | Detector | Polar |
|-----|------------|--------------|-------------|--------------|--------------|-----------|----------|-------|
| 1* | 36.063MHz | 2.92 | 18.72 | 21.64 | 40.00 | -18.36 | QP | Hor |
| 2* | 57.039MHz | 2.39 | 18.85 | 21.24 | 40.00 | -18.76 | QP | Hor |
| 3* | 167.255MHz | 3.69 | 19.80 | 23.49 | 43.50 | -20.01 | QP | Hor |
| 4* | 382.595MHz | 3.27 | 22.31 | 25.58 | 46.00 | -20.42 | QP | Hor |
| 5* | 508.938MHz | 2.46 | 25.09 | 27.55 | 46.00 | -18.45 | QP | Hor |
| 6* | 997.818MHz | 3.48 | 34.56 | 38.04 | 54.00 | -15.96 | QP | Hor |

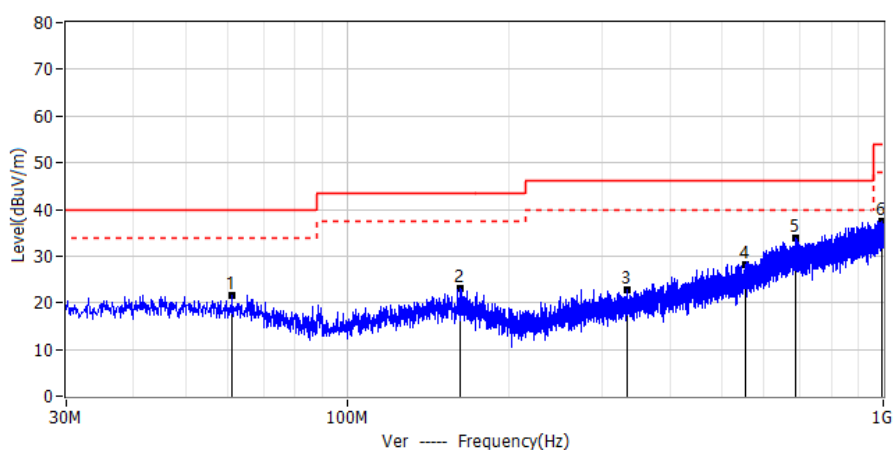

| No. | Frequency | Reading dBuV | Factor dB/m | Level dBuV/m | Limit dBuV/m | Margin dB | Detector | Polar |
|-----|------------|--------------|-------------|--------------|--------------|-----------|----------|-------|
| 1* | 61.040MHz | 3.07 | 18.58 | 21.65 | 40.00 | -18.35 | QP | Ver |
| 2* | 163.133MHz | 3.12 | 19.82 | 22.94 | 43.50 | -20.56 | QP | Ver |
| 3* | 333.368MHz | 1.93 | 20.87 | 22.80 | 46.00 | -23.20 | QP | Ver |
| 4* | 553.073MHz | 2.00 | 26.26 | 28.26 | 46.00 | -17.74 | QP | Ver |
| 5* | 687.539MHz | 4.23 | 29.69 | 33.92 | 46.00 | -12.08 | QP | Ver |
| 6* | 993.210MHz | 2.98 | 34.54 | 37.52 | 54.00 | -16.48 | QP | Ver |



Results of Radiated Emissions (Above 1000MHz)

Note: All the modes have been tested, found worst case at GFSK(1Mbps), recorded the worst case results in this report.

| | |
|----------------------------------|-----------------------------|
| Project: LGT23H085 | Test Engineer: Xiangdong Ma |
| EUT: Veho MR-8 Bluetooth speaker | Temperature: 26.5°C |
| M/N: VSS-501-MR8 | Humidity: 56%RH |
| Test Voltage: Battery | Test Data: 2023-09-07 |
| Test Mode: DH5 2402 | |
| Note: Worst Case | |

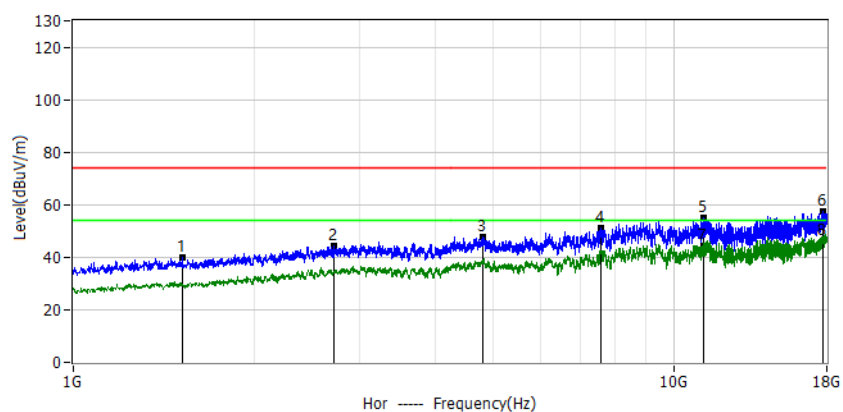

| No. | Frequency MHz | Reading dBuV | Factor dB/m | Level dBuV/m | Limit dBuV/m | Margin dB | Detector | Polar |
|-----|---------------|--------------|-------------|--------------|--------------|-----------|----------|-------|
| 1* | 1516.4000 | 60.84 | -20.73 | 40.11 | 74.00 | -33.89 | PK | Hor |
| 2* | 2721.2000 | 54.22 | -9.81 | 44.41 | 74.00 | -29.59 | PK | Hor |
| 3* | 4818.6000 | 53.63 | -6.00 | 47.63 | 74.00 | -26.37 | PK | Hor |
| 4* | 7568.4000 | 55.29 | -4.25 | 51.04 | 74.00 | -22.96 | PK | Hor |
| 5* | 11242.5000 | 53.24 | 1.77 | 55.01 | 74.00 | -18.99 | PK | Hor |
| 6* | 17747.1000 | 49.20 | 8.34 | 57.54 | 74.00 | -16.46 | PK | Hor |
| 7* | 11242.5000 | 42.73 | 1.77 | 44.50 | 54.00 | -9.50 | AV | Hor |
| 8* | 17747.1000 | 38.06 | 8.34 | 46.40 | 54.00 | -7.60 | AV | Hor |

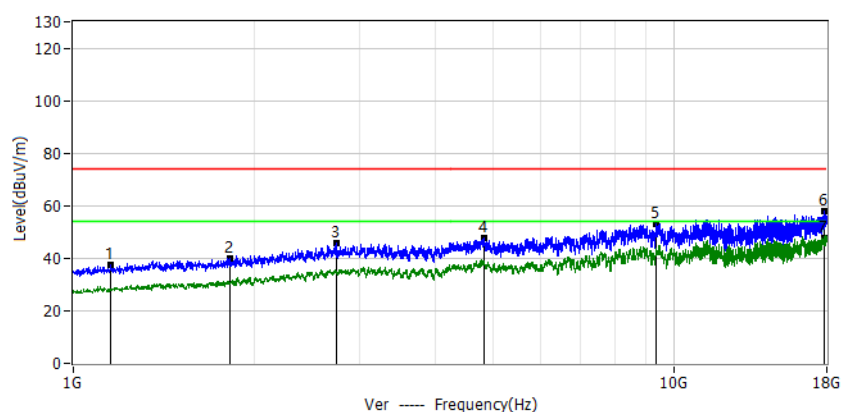

| No. | Frequency MHz | Reading dBuV | Factor dB/m | Level dBuV/m | Limit dBuV/m | Margin dB | Detector | Polar |
|-----|---------------|--------------|-------------|--------------|--------------|-----------|----------|-------|
| 1* | 1155.1000 | 60.79 | -23.37 | 37.42 | 74.00 | -36.58 | PK | Ver |
| 2* | 1824.5000 | 58.02 | -18.01 | 40.01 | 74.00 | -33.99 | PK | Ver |
| 3* | 2748.9000 | 55.20 | -9.67 | 45.53 | 74.00 | -28.47 | PK | Ver |
| 4* | 4829.2000 | 53.86 | -6.01 | 47.85 | 74.00 | -26.15 | PK | Ver |
| 5* | 9342.7000 | 54.43 | -1.17 | 53.26 | 74.00 | -20.74 | PK | Ver |
| 6* | 17844.9000 | 49.35 | 8.41 | 57.76 | 74.00 | -16.24 | PK | Ver |
| 7* | 17844.9000 | 39.09 | 8.41 | 47.50 | 54.00 | -6.50 | AV | Ver |



| | |
|----------------------------------|-----------------------------|
| Project: LGT23H085 | Test Engineer: Xiangdong Ma |
| EUT: Veho MR-8 Bluetooth speaker | Temperature: 26.5°C |
| M/N: VSS-501-MR8 | Humidity: 56%RH |
| Test Voltage: Battery | Test Data: 2023-09-07 |
| Test Mode: DH5 2441 | |
| Note: Worst Case | |

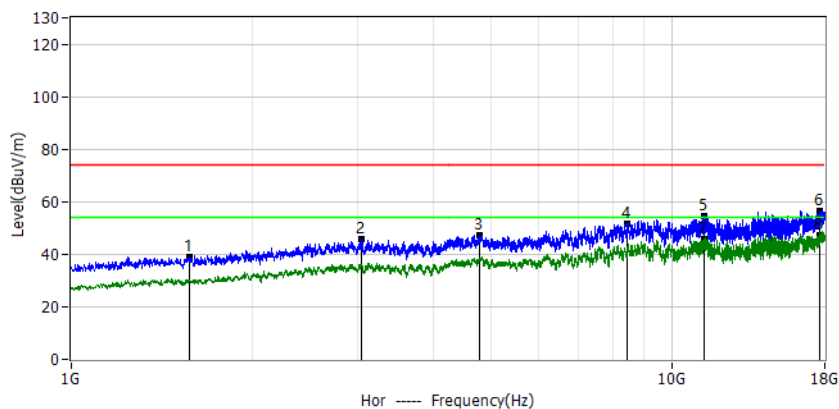

| No. | Frequency MHz | Reading dBuV | Factor dB/m | Level dBuV/m | Limit dBuV/m | Margin dB | Detector | Polar |
|-----|---------------|--------------|-------------|--------------|--------------|-----------|----------|-------|
| 1* | 1575.9000 | 59.14 | -20.34 | 38.80 | 74.00 | -35.20 | PK | Hor |
| 2* | 3035.7000 | 54.07 | -8.35 | 45.72 | 74.00 | -28.28 | PK | Hor |
| 3* | 4797.4000 | 53.22 | -5.98 | 47.24 | 74.00 | -26.76 | PK | Hor |
| 4* | 8429.0000 | 54.64 | -2.79 | 51.85 | 74.00 | -22.15 | PK | Hor |
| 5* | 11353.0000 | 52.86 | 1.84 | 54.70 | 74.00 | -19.30 | PK | Hor |
| 6* | 17617.5000 | 48.40 | 8.25 | 56.65 | 74.00 | -17.35 | PK | Hor |
| 7* | 11353.0000 | 43.96 | 1.84 | 45.80 | 54.00 | -8.20 | AV | Hor |
| 8* | 17617.5000 | 38.85 | 8.25 | 47.10 | 54.00 | -6.90 | AV | Hor |

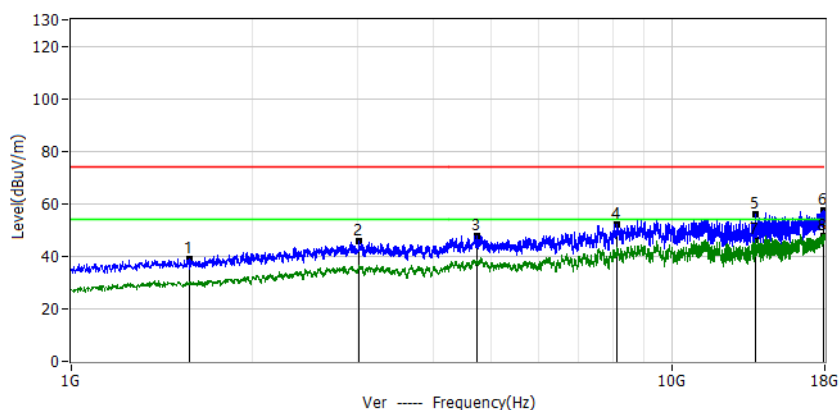

| No. | Frequency MHz | Reading dBuV | Factor dB/m | Level dBuV/m | Limit dBuV/m | Margin dB | Detector | Polar |
|-----|---------------|--------------|-------------|--------------|--------------|-----------|----------|-------|
| 1* | 1569.5000 | 59.52 | -20.38 | 39.14 | 74.00 | -34.86 | PK | Ver |
| 2* | 3016.6000 | 54.09 | -8.35 | 45.74 | 74.00 | -28.26 | PK | Ver |
| 3* | 4748.5000 | 53.81 | -5.95 | 47.86 | 74.00 | -26.14 | PK | Ver |
| 4* | 8125.1000 | 55.92 | -3.65 | 52.27 | 74.00 | -21.73 | PK | Ver |
| 5* | 13815.9000 | 50.67 | 5.24 | 55.91 | 74.00 | -18.09 | PK | Ver |
| 6* | 17944.7000 | 48.82 | 8.48 | 57.30 | 74.00 | -16.70 | PK | Ver |
| 7* | 13815.9000 | 41.06 | 5.24 | 46.30 | 54.00 | -7.70 | AV | Ver |
| 8* | 17944.7000 | 39.42 | 8.48 | 47.90 | 54.00 | -6.10 | AV | Ver |



| | |
|----------------------------------|-----------------------------|
| Project: LGT23H085 | Test Engineer: Xiangdong Ma |
| EUT: Veho MR-8 Bluetooth speaker | Temperature: 26.5°C |
| M/N: VSS-501-MR8 | Humidity: 56%RH |
| Test Voltage: Battery | Test Data: 2023-09-07 |
| Test Mode: DH5 2480 | |
| Note: Worst Case | |

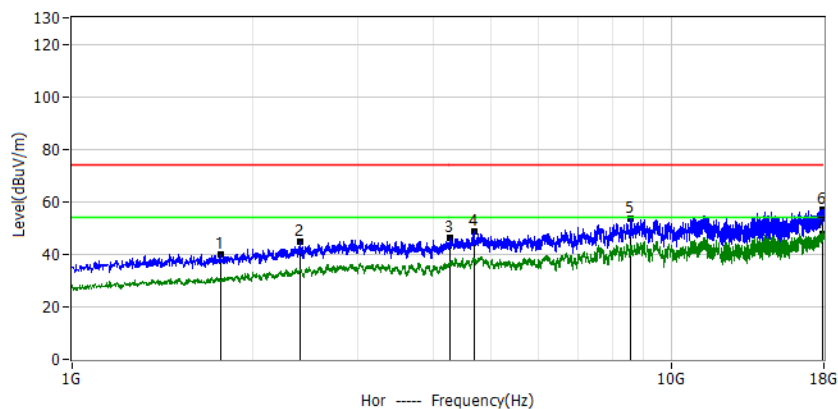

| No. | Frequency MHz | Reading dBuV | Factor dB/m | Level dBuV/m | Limit dBuV/m | Margin dB | Detector | Polar |
|-----|---------------|--------------|-------------|--------------|--------------|-----------|----------|-------|
| 1* | 1773.5000 | 58.42 | -18.51 | 39.91 | 74.00 | -34.09 | PK | Hor |
| 2* | 2406.7000 | 56.56 | -11.96 | 44.60 | 74.00 | -29.40 | PK | Hor |
| 3* | 4283.1000 | 52.93 | -6.67 | 46.26 | 74.00 | -27.74 | PK | Hor |
| 4* | 4697.5000 | 54.45 | -5.91 | 48.54 | 74.00 | -25.46 | PK | Hor |
| 5* | 8569.2000 | 56.10 | -2.39 | 53.71 | 74.00 | -20.29 | PK | Hor |
| 6* | 17949.0000 | 48.55 | 8.48 | 57.03 | 74.00 | -16.97 | PK | Hor |
| 7* | 17949.0000 | 39.12 | 8.48 | 47.60 | 54.00 | -6.40 | AV | Hor |

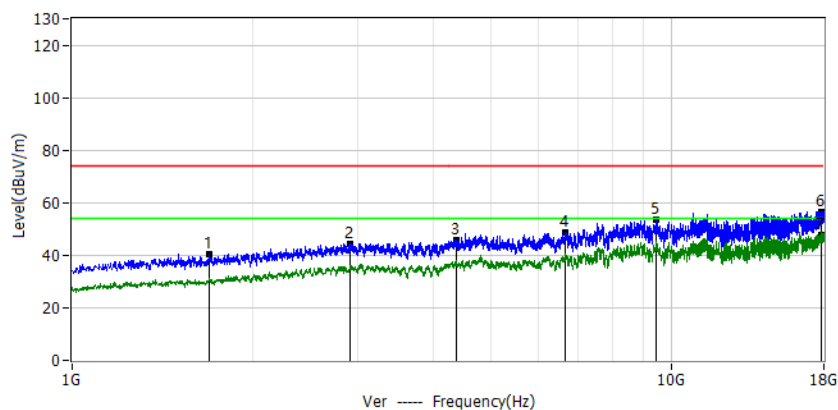

| No. | Frequency MHz | Reading dBuV | Factor dB/m | Level dBuV/m | Limit dBuV/m | Margin dB | Detector | Polar |
|-----|---------------|--------------|-------------|--------------|--------------|-----------|----------|-------|
| 1* | 1692.7000 | 59.82 | -19.29 | 40.53 | 74.00 | -33.47 | PK | Ver |
| 2* | 2906.1000 | 53.09 | -8.84 | 44.25 | 74.00 | -29.75 | PK | Ver |
| 3* | 4374.5000 | 52.05 | -6.29 | 45.76 | 74.00 | -28.24 | PK | Ver |
| 4* | 6661.0000 | 54.78 | -6.28 | 48.50 | 74.00 | -25.50 | PK | Ver |
| 5* | 9463.9000 | 54.51 | -1.17 | 53.34 | 74.00 | -20.66 | PK | Ver |
| 6* | 17821.5000 | 48.31 | 8.40 | 56.71 | 74.00 | -17.29 | PK | Ver |
| 7* | 17821.5000 | 39.20 | 8.40 | 47.60 | 54.00 | -6.40 | AV | Ver |

Remark:

In frequency ranges 18~25GHz no any other harmonic emissions detected which are tested to compliance with the limit. No recording in the test report. No any other emissions level which are attenuated less than 20dB below the limit. No recording in the test report.



3.2.8 TEST RESULTS (BAND EDGE REQUIREMENTS)

Note: All the modes have been tested, found worst case at GFSK(1Mbps), recorded the worst case results in this report.

| | |
|----------------------------------|-----------------------------|
| Project: LGT23H085 | Test Engineer: Xiangdong Ma |
| EUT: Veho MR-8 Bluetooth speaker | Temperature: 27.6°C |
| M/N: VSS-501-MR8 | Humidity: 44%RH |
| Test Voltage: Battery | Test Data: 2023-09-18 |
| Test Mode: DH5 2402 | |
| Note: | |

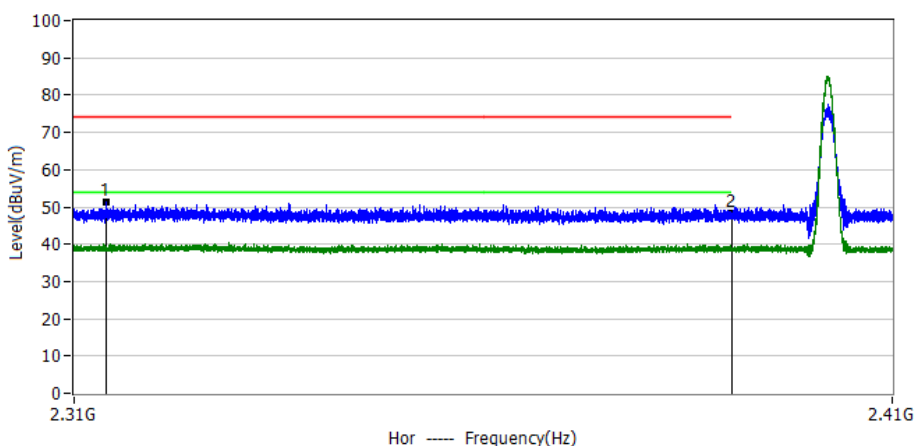

| No. | Frequency | Reading dBuV | Factor dB/m | Level dBuV/m | Limit dBuV/m | Margin dB | Detector | Polar |
|-----|-----------|--------------|-------------|--------------|--------------|-----------|----------|-------|
| 1* | 2.3138GHz | 17.09 | 34.13 | 51.22 | 74.00 | -22.78 | PK | Hor |
| 2* | 2.3900GHz | 14.45 | 33.95 | 48.40 | 74.00 | -25.60 | PK | Hor |

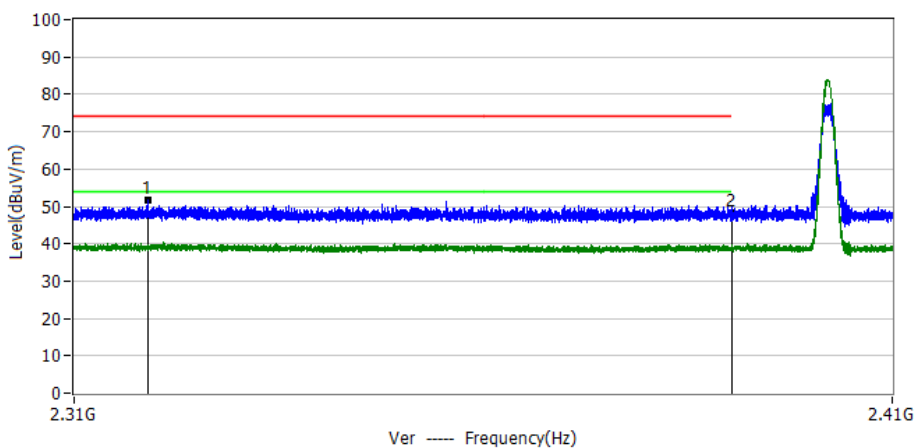

| No. | Frequency | Reading dBuV | Factor dB/m | Level dBuV/m | Limit dBuV/m | Margin dB | Detector | Polar |
|-----|-----------|--------------|-------------|--------------|--------------|-----------|----------|-------|
| 1* | 2.3188GHz | 17.39 | 34.12 | 51.51 | 74.00 | -22.49 | PK | Ver |
| 2* | 2.3900GHz | 14.55 | 33.95 | 48.50 | 74.00 | -25.50 | PK | Ver |



| | |
|----------------------------------|-----------------------------|
| Project: LGT23H085 | Test Engineer: Xiangdong Ma |
| EUT: Veho MR-8 Bluetooth speaker | Temperature: 27.6°C |
| M/N: VSS-501-MR8 | Humidity: 44%RH |
| Test Voltage: Battery | Test Data: 2023-09-18 |
| Test Mode: DH5 2480 | |
| Note: | |

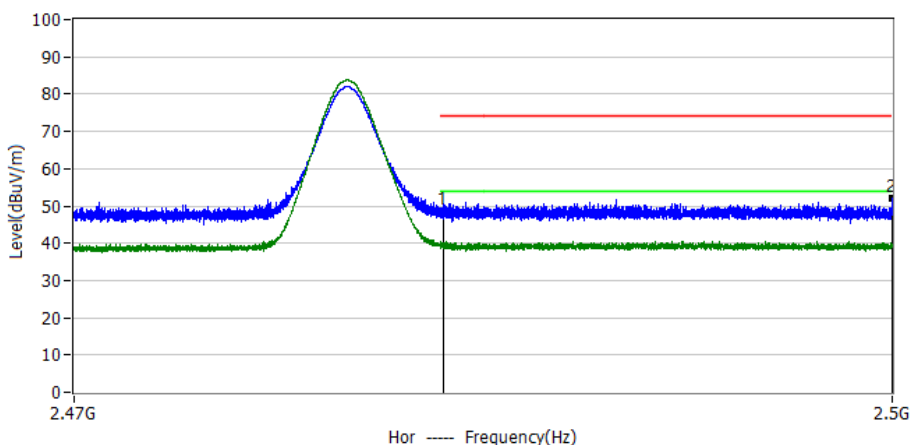

| No. | Frequency | Reading dBuV | Factor dB/m | Level dBuV/m | Limit dBuV/m | Margin dB | Detector | Polar |
|-----|-----------|--------------|-------------|--------------|--------------|-----------|----------|-------|
| 1* | 2.4835GHz | 14.57 | 34.13 | 48.70 | 74.00 | -25.30 | PK | Hor |
| 2* | 2.5000GHz | 17.72 | 34.16 | 51.88 | 74.00 | -22.12 | PK | Hor |

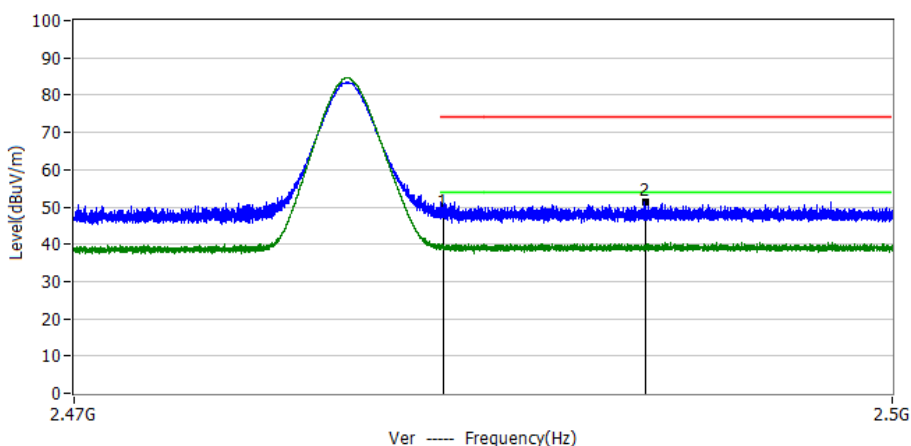

| No. | Frequency | Reading dBuV | Factor dB/m | Level dBuV/m | Limit dBuV/m | Margin dB | Detector | Polar |
|-----|-----------|--------------|-------------|--------------|--------------|-----------|----------|-------|
| 1* | 2.4835GHz | 14.27 | 34.13 | 48.40 | 74.00 | -25.60 | PK | Ver |
| 2* | 2.4909GHz | 17.34 | 34.14 | 51.48 | 74.00 | -22.52 | PK | Ver |



4. CONDUCTED SPURIOUS & BAND EDGE EMISSION

4.1 LIMIT

According to FCC section 15.247(d), in any 100kHz bandwidth outside the frequency band in which the spread spectrum or digitally modulated intentional radiator is operating, the radio frequency power that is produced by the intentional radiator shall be at least 20dB below that in the 100kHz bandwidth within the band that contains the highest level of the desired power, based on either an RF conducted or a radiated measurement.

4.2 TEST PROCEDURE

| Spectrum Parameter | Setting |
|---------------------------------------|---------------------------------|
| Detector | Peak |
| Start/Stop Frequency | 30 MHz to 10th carrier harmonic |
| RB / VB (emission in restricted band) | 100 KHz/300 KHz |
| Trace-Mode: | Max hold |

For Band edge

| Spectrum Parameter | Setting |
|---------------------------------------|--|
| Detector | Peak |
| Start/Stop Frequency | Lower Band Edge: 2300 – 2407 MHz Upper Band Edge: 2475 – 2500 MHz |
| RB / VB (emission in restricted band) | 100 KHz/300 KHz |
| Trace-Mode: | Max hold |

For Hopping Band edge

| Spectrum Parameter | Setting |
|---------------------------------------|---|
| Detector | Peak |
| Start/Stop Frequency | Lower Band Edge: 2300– 2403 MHz Upper Band Edge: 2479 – 2500 MHz |
| RB / VB (emission in restricted band) | 100 KHz/300 KHz |
| Trace-Mode: | Max hold |



4.3 TEST SETUP



The EUT is connected to the Spectrum Analyzer; the RF load attached to the EUT antenna terminal is 50Ohm; the path loss as the factor is calibrated to correct the reading. Tune the measurement with the spectrum analyzer's resolution bandwidth (RBW) = 100 kHz. In order to make an accurate measurement, the span is set to be greater than RBW.

4.4 EUT OPERATION CONDITIONS

Please refer to section 3.1.4 of this report.

4.5 TEST RESULTS

For the measurement records, refer to the appendix I.



5. NUMBER OF HOPPING CHANNEL

5.1 LIMIT

| FCC Part 15.247, Subpart C | | | | |
|----------------------------|---------------------------|-------|----------------------|--------|
| Section | Test Item | Limit | FrequencyRange (MHz) | Result |
| 15.247 (a)(1)(iii) | Number of Hopping Channel | ≥15 | 2400-2483.5 | PASS |

| Spectrum Parameters | Setting |
|---------------------|----------------------------|
| Attenuation | Auto |
| Span Frequency | > Operating FrequencyRange |
| RB | 300KHz |
| VB | 300KHz |
| Detector | Peak |
| Trace | Max Hold |
| Sweep Time | Auto |

5.2 TEST PROCEDURE

- a. The EUT was directly connected to the spectrum analyzer and antenna output port as show in the block diagram below.
- b. Spectrum Setting: RBW= 300KHz, VBW=300KHz, Sweep time = Auto.

5.3 TEST SETUP



5.4 EUT OPERATION CONDITIONS

Please refer to section 3.1.4 of this report.

5.5 TEST RESULTS

For the measurement records, refer to the appendix I.



6. AVERAGE TIME OF OCCUPANCY

6.1 LIMIT

| FCC Part 15.247, Subpart C | | | | |
|----------------------------|---------------------------|--------|----------------------|--------|
| Section | Test Item | Limit | FrequencyRange (MHz) | Result |
| 15.247 (a)(1)(iii) | Average Time of Occupancy | 0.4sec | 2400-2483.5 | PASS |

6.2 TEST PROCEDURE

- a. The transmitter output (antenna port) was connected to the spectrum analyzer.
- b. Set RBW =1MHz/VBW =3MHz.
- c. Use a video trigger with the trigger level set to enable triggering only on full pulses.
- d. Sweep Time is more than once pulse time.
- e. Set the center frequency on any frequency would be measure and set the frequency span to zero span.
- f. Measure the maximum time duration of one single pulse.
- g. Set the EUT for DH5, DH3 and DH1 packet transmitting.
- h. Measure the maximum time duration of one single pulse.
- i. DH5 Packet permit maximum $1600 / 79 / 6 = 3.37$ hops per second in each channel (5 time slots RX, 1 time slot TX). So the number of pulses in the observation period of 31.6 seconds is $3.37 \times 31.6 = 106.6$.
- j. DH3 Packet permit maximum $1600 / 79 / 4 = 5.06$ hops per second in each channel (3 time slots RX, 1 time slot TX). So the number of pulses in the observation period of 31.6 seconds is $5.06 \times 31.6 = 160$.
- k. DH1 Packet permit maximum $1600 / 79 / 2 = 10.12$ hops per second in each channel (1 time slot RX, 1 time slot TX). So the number of pulses in the observation period of 31.6 seconds is $10.12 \times 31.6 = 320$.

6.3 TEST SETUP



6.4 EUT OPERATION CONDITIONS

Please refer to section 3.1.4 of this report.

6.5 TEST RESULTS

For the measurement records, refer to the appendix I.



7. HOPPING CHANNEL SEPARATION MEASUREMENT

7.1 LIMIT

Frequency hopping systems shall have hopping channel carrier frequencies separated by a minimum of 25 kHz or the 20 dB bandwidth of the hopping channel, whichever is greater. Alternatively, frequency hopping systems operating in the 2400-2483.5 MHz band may have hopping channel carrier frequencies that are separated by 25 kHz or two-thirds of the 20 dB bandwidth of the hopping channel, whichever is greater, provided the systems operate with an output power no greater than 125 mW.

| Spectrum Parameter | Setting |
|--------------------|---|
| Attenuation | Auto |
| Span Frequency | > 20 dB Bandwidth or Channel Separation |
| RB | 30 kHz (20dB Bandwidth) / 30 kHz (Channel Separation) |
| VB | 100 kHz (20dB Bandwidth) / 100 kHz (Channel Separation) |
| Detector | Peak |
| Trace | Max Hold |
| Sweep Time | Auto |

7.2 TEST PROCEDURE

- The transmitter output (antenna port) was connected to the spectrum analyser in peak hold mode.
- The resolution bandwidth of 30 kHz and the video bandwidth of 100 kHz were utilised for 20 dB bandwidth measurement.
- The resolution bandwidth of 30 kHz and the video bandwidth of 100 kHz were utilised for channel separation measurement.

7.3 TEST SETUP



7.4 EUT OPERATION CONDITIONS

The EUT was programmed to be in continuously transmitting mode.

7.5 TEST RESULTS

For the measurement records, refer to the appendix I.



8. BANDWIDTH TEST

8.1 LIMIT

| FCC Part15 15.247, Subpart C | | | | |
|------------------------------|-----------|-------|----------------------|--------|
| Section | Test Item | Limit | FrequencyRange (MHz) | Result |
| 15.247 (a)(1) | Bandwidth | N/A | 2400-2483.5 | PASS |

| Spectrum Parameter | Setting |
|--------------------|---|
| Attenuation | Auto |
| Span Frequency | > Measurement Bandwidth or Channel Separation |
| RB | 30 kHz (20dB Bandwidth) / 30 kHz (Channel Separation) |
| VB | 100 kHz (20dB Bandwidth) / 100 kHz (Channel Separation) |
| Detector | Peak |
| Trace | Max Hold |
| Sweep Time | Auto |

8.2 TEST PROCEDURE

- a. The EUT was directly connected to the spectrum analyzer and antenna output port as show in the block diagram below.
- b. Spectrum Setting: RBW= 30KHz, VBW=100KHz, Sweep time = Auto.

8.3 TEST SETUP



8.4 EUT OPERATION CONDITIONS

Please refer to section 3.1.4 of this report.

8.5 TEST RESULTS

For the measurement records, refer to the appendix I.



9. OUTPUT POWER TEST

9.1 LIMIT

| FCC Part 15.247, Subpart C | | | | |
|----------------------------|--------------|---|-----------------------|--------|
| Section | Test Item | Limit | Frequency Range (MHz) | Result |
| 15.247 (a)(1)&(b)(1) | Output Power | 1 W or 0.125W | 2400-2483.5 | PASS |
| | | if channel separation > 2/3 bandwidth provided the systems operate with an output power no greater than 125 mW (20.97dBm) | | |

9.2 TEST PROCEDURE

This is an RF-conducted test to evaluate maximum peak output power. Use a direct connection between the antenna port of the unlicensed wireless device and the spectrum analyzer, through suitable attenuation. The hopping shall be disabled for this test:

a) Use the following spectrum analyzer settings:

- 1) Span: Approximately five times the 20 dB bandwidth, centered on a hopping channel.
- 2) RBW > 20 dB bandwidth of the emission being measured.
- 3) VBW \geq RBW.
- 4) Sweep: Auto.
- 5) Detector function: Peak.
- 6) Trace: Max hold.

b) Allow trace to stabilize.

c) Use the marker-to-peak function to set the marker to the peak of the emission.

d) The indicated level is the peak output power, after any corrections for external attenuators and cables.

e) A plot of the test results and setup description shall be included in the test report.

NOTE—A peak responding power meter may be used, where the power meter and sensor system video bandwidth is greater than the occupied bandwidth of the unlicensed wireless device, rather than a spectrum analyzer.

PKPM1 Peak power meter method:

The maximum peak conducted output power may be measured using a broadband peak RF power meter. The power meter shall have a video bandwidth that is greater than or equal to the DSS bandwidth and shall use a fast-responding diode detector.

9.3 TEST SETUP

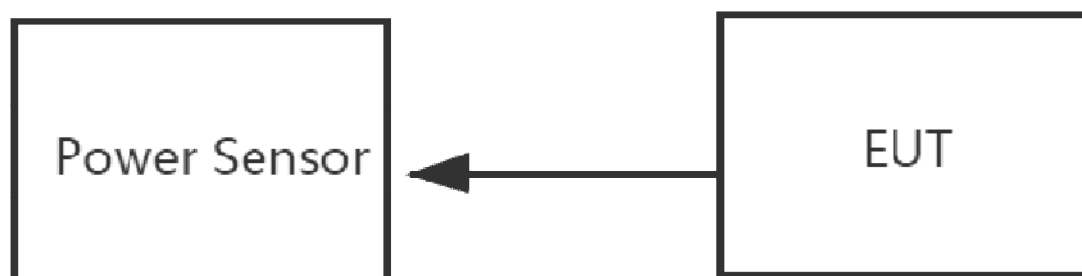

9.4 EUT OPERATION CONDITIONS

Please refer to section 3.1.4 of this report.

9.5 TEST RESULTS

For the measurement records, refer to the appendix I.



10. ANTENNA REQUIREMENT

10.1 STANDARD REQUIREMENT

15.203 requirement: For intentional device, according to 15.203: an intentional radiator shall be designed to ensure that no antenna other than that furnished by the responsible party shall be used with the device.

10.2 EUT ANTENNA

The EUT antenna is PCB Antenna. It comply with the standard requirement.



APPENDIX I: TEST RESULTS

Duty Cycle

| Condition | Mode | Frequency (MHz) | Antenna | Duty Cycle (%) | Correction Factor (dB) | 1/T (kHz) |
|-----------|-------|-----------------|---------|----------------|------------------------|-----------|
| NVNT | 1-DH5 | 2402 | Ant1 | 76.89 | 1.14 | 0.35 |
| NVNT | 1-DH5 | 2441 | Ant1 | 76.89 | 1.14 | 0.35 |
| NVNT | 1-DH5 | 2480 | Ant1 | 76.91 | 1.14 | 0.35 |
| NVNT | 2-DH5 | 2402 | Ant1 | 76.98 | 1.14 | 0.35 |
| NVNT | 2-DH5 | 2441 | Ant1 | 76.96 | 1.14 | 0.35 |
| NVNT | 2-DH5 | 2480 | Ant1 | 76.96 | 1.14 | 0.35 |
| NVNT | 3-DH5 | 2402 | Ant1 | 77.03 | 1.13 | 0.35 |
| NVNT | 3-DH5 | 2441 | Ant1 | 77.03 | 1.13 | 0.35 |
| NVNT | 3-DH5 | 2480 | Ant1 | 77.03 | 1.13 | 0.35 |



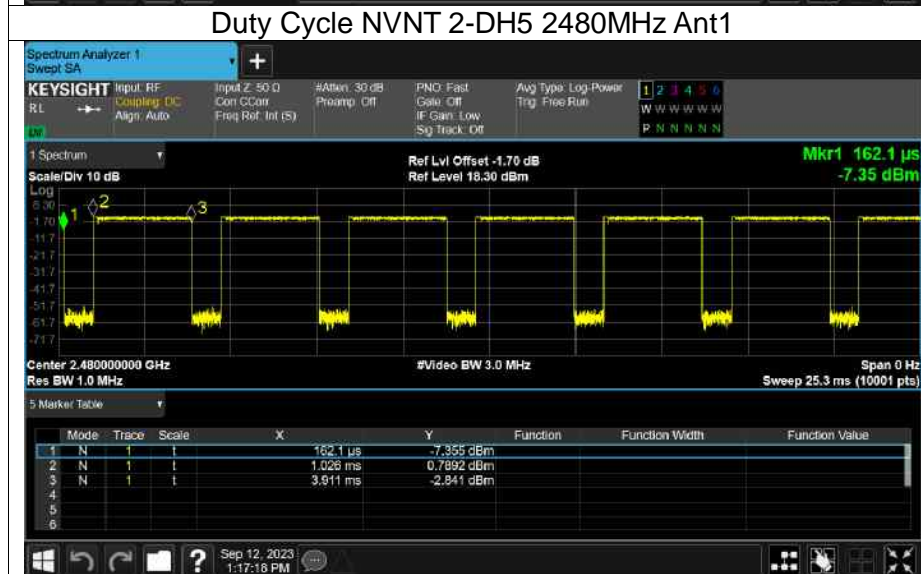
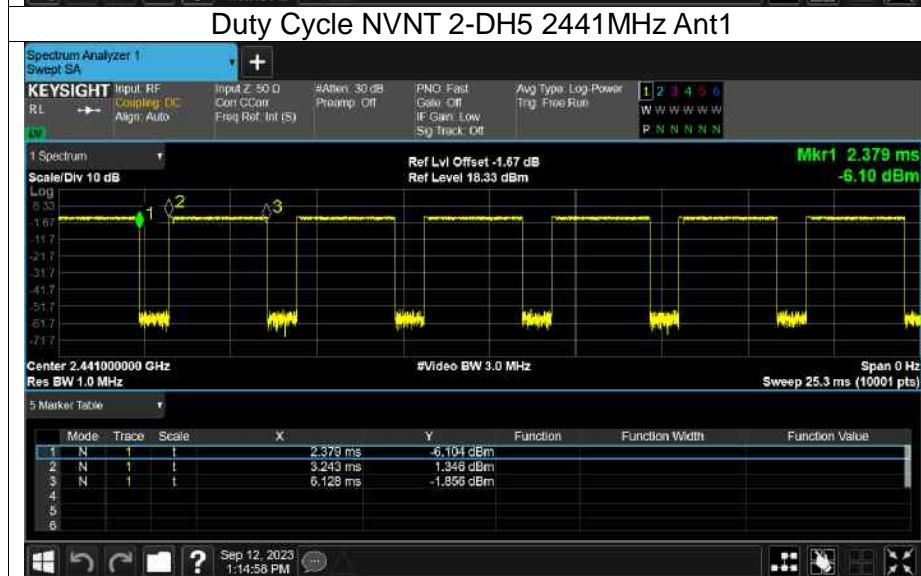
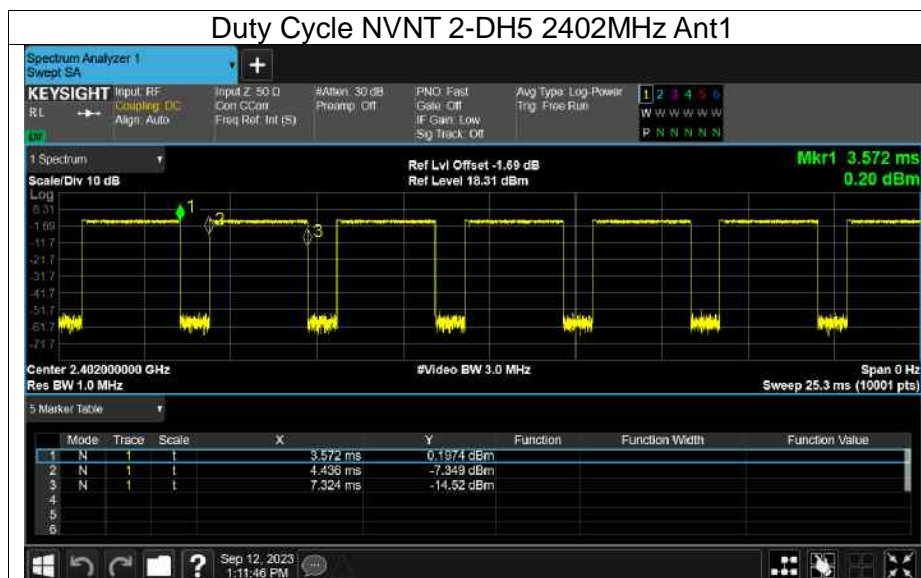

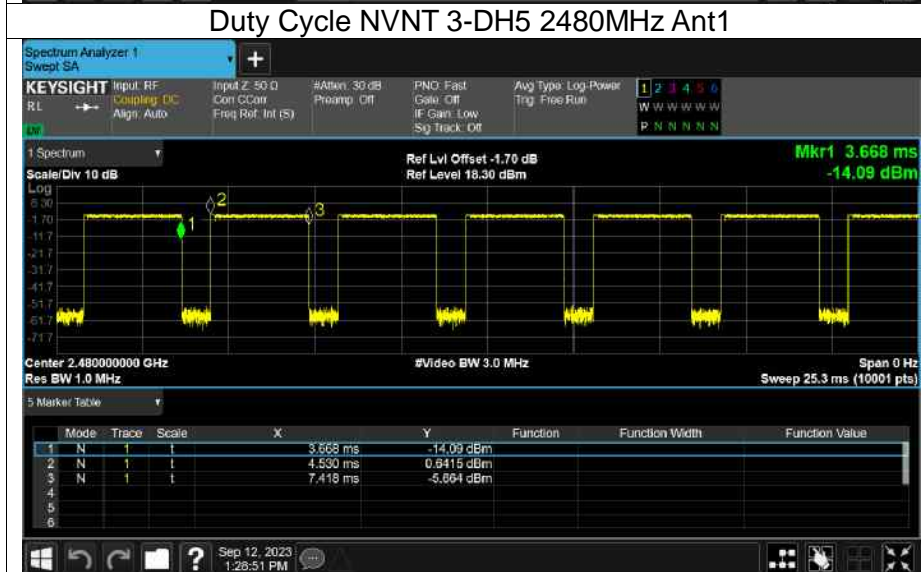
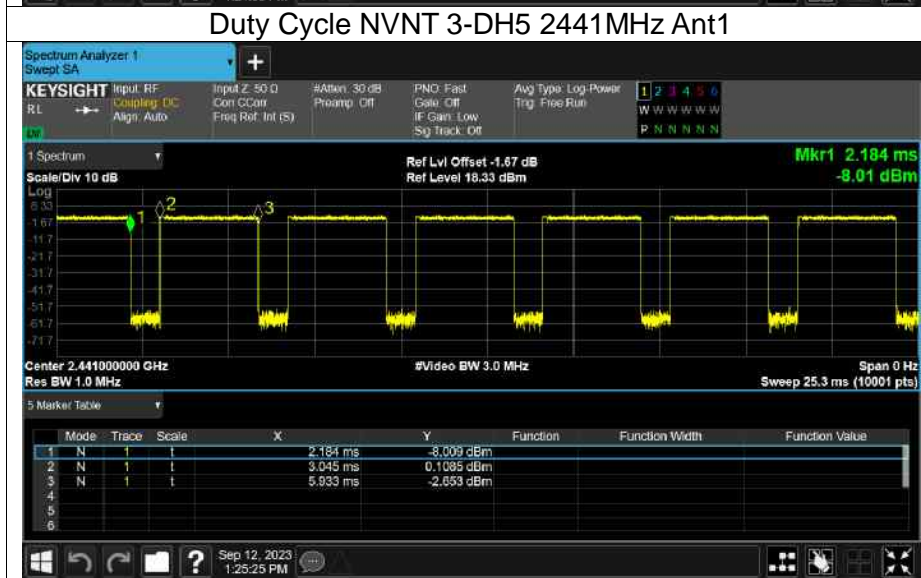
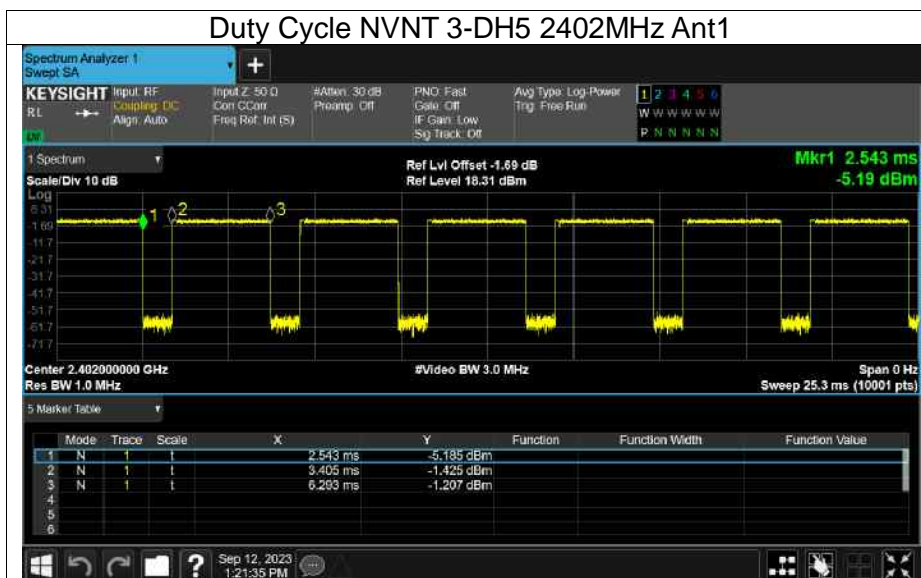



Maximum Peak Conducted Output Power

| Condition | Mode | Frequency (MHz) | Antenna | Conducted Power (dBm) | Limit (dBm) | Verdict |
|-----------|-------|-----------------|---------|-----------------------|-------------|---------|
| NVNT | 1-DH5 | 2402 | Ant1 | 3.5 | 21 | Pass |
| NVNT | 1-DH5 | 2441 | Ant1 | 3.5 | 21 | Pass |
| NVNT | 1-DH5 | 2480 | Ant1 | 2.62 | 21 | Pass |
| NVNT | 2-DH5 | 2402 | Ant1 | 2.69 | 21 | Pass |
| NVNT | 2-DH5 | 2441 | Ant1 | 2.7 | 21 | Pass |
| NVNT | 2-DH5 | 2480 | Ant1 | 1.93 | 21 | Pass |
| NVNT | 3-DH5 | 2402 | Ant1 | 2.85 | 21 | Pass |
| NVNT | 3-DH5 | 2441 | Ant1 | 2.83 | 21 | Pass |
| NVNT | 3-DH5 | 2480 | Ant1 | 2.08 | 21 | Pass |



-20dB Bandwidth

| Condition | Mode | Frequency (MHz) | Antenna | -20 dB Bandwidth (MHz) | Verdict |
|-----------|-------|-----------------|---------|------------------------|---------|
| NVNT | 1-DH5 | 2402 | Ant1 | 1.03 | Pass |
| NVNT | 1-DH5 | 2441 | Ant1 | 0.95 | Pass |
| NVNT | 1-DH5 | 2480 | Ant1 | 1.016 | Pass |
| NVNT | 2-DH5 | 2402 | Ant1 | 1.32 | Pass |
| NVNT | 2-DH5 | 2441 | Ant1 | 1.311 | Pass |
| NVNT | 2-DH5 | 2480 | Ant1 | 1.284 | Pass |
| NVNT | 3-DH5 | 2402 | Ant1 | 1.295 | Pass |
| NVNT | 3-DH5 | 2441 | Ant1 | 1.311 | Pass |
| NVNT | 3-DH5 | 2480 | Ant1 | 1.311 | Pass |



Test Graphs

-20dB Bandwidth NVNT 1-DH5 2402MHz Ant1



-20dB Bandwidth NVNT 1-DH5 2441MHz Ant1



-20dB Bandwidth NVNT 1-DH5 2480MHz Ant1



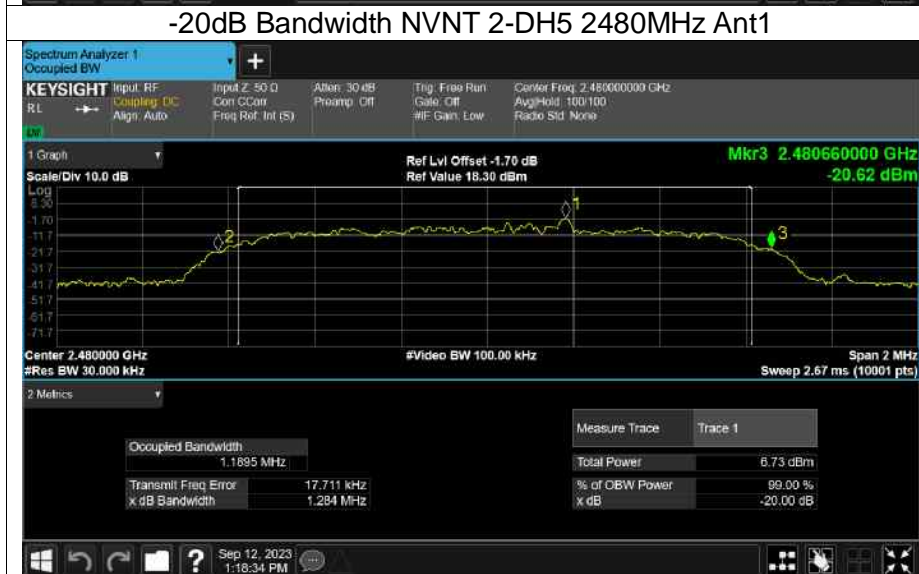
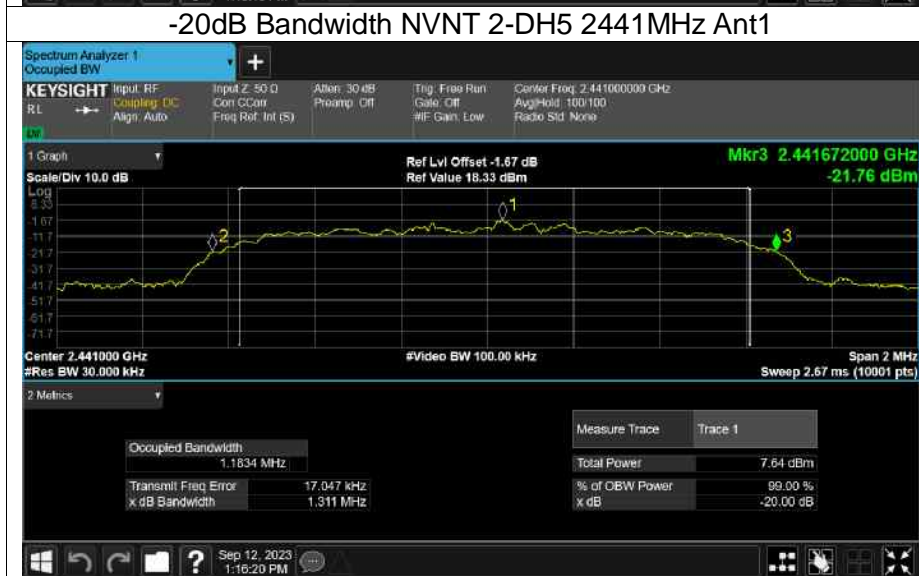
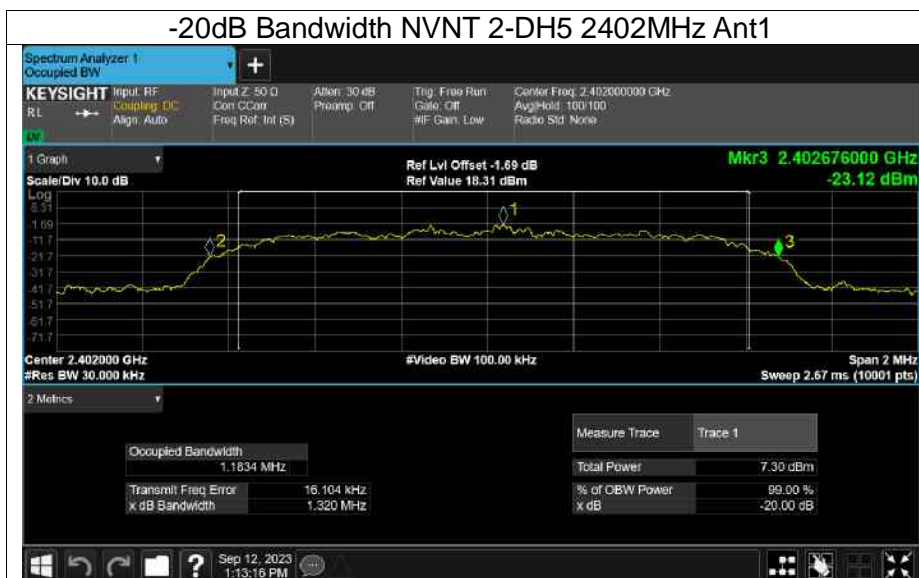

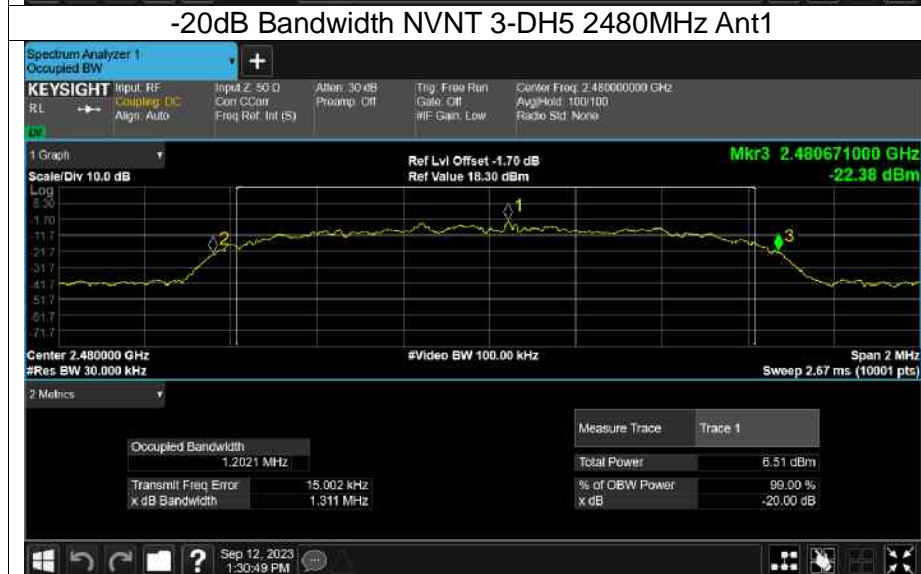
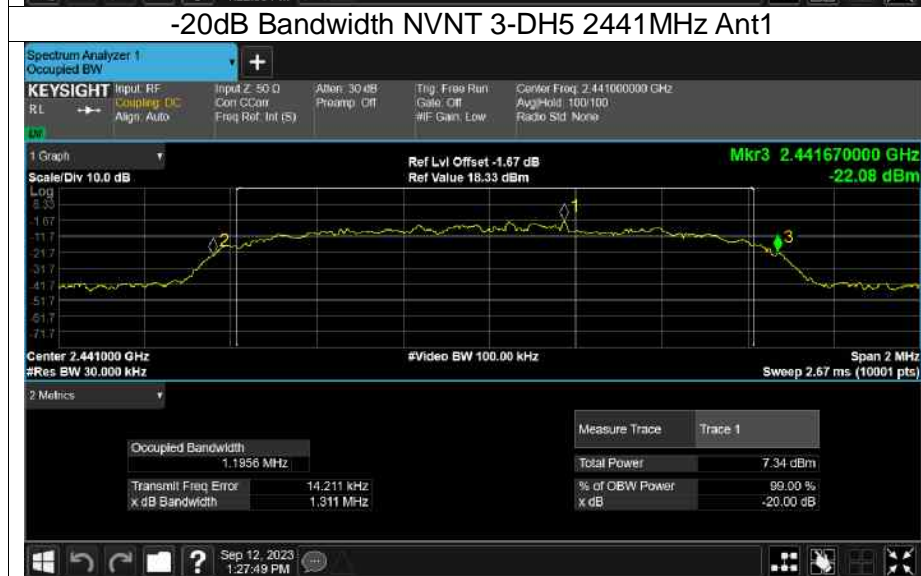
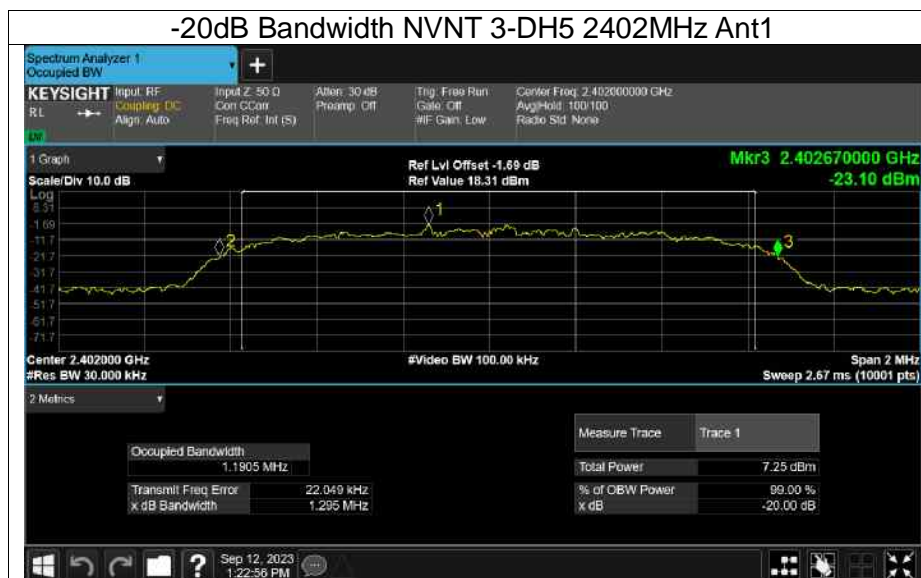



Occupied Channel Bandwidth

| Condition | Mode | Frequency (MHz) | Antenna | 99% OBW (MHz) |
|------------------|-------------|------------------------|----------------|----------------------|
| NVNT | 1-DH5 | 2402 | Ant1 | 0.907 |
| NVNT | 1-DH5 | 2441 | Ant1 | 0.888 |
| NVNT | 1-DH5 | 2480 | Ant1 | 0.889 |
| NVNT | 2-DH5 | 2402 | Ant1 | 1.175 |
| NVNT | 2-DH5 | 2441 | Ant1 | 1.18 |
| NVNT | 2-DH5 | 2480 | Ant1 | 1.187 |
| NVNT | 3-DH5 | 2402 | Ant1 | 1.195 |
| NVNT | 3-DH5 | 2441 | Ant1 | 1.203 |
| NVNT | 3-DH5 | 2480 | Ant1 | 1.203 |



Test Graphs

OBW NVNT 1-DH5 2402MHz Ant1



OBW NVNT 1-DH5 2441MHz Ant1



OBW NVNT 1-DH5 2480MHz Ant1



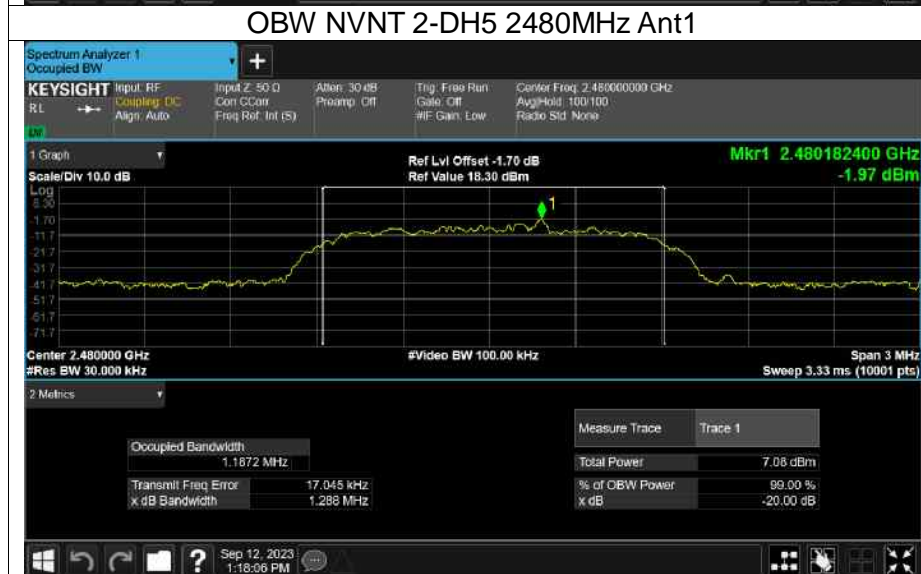
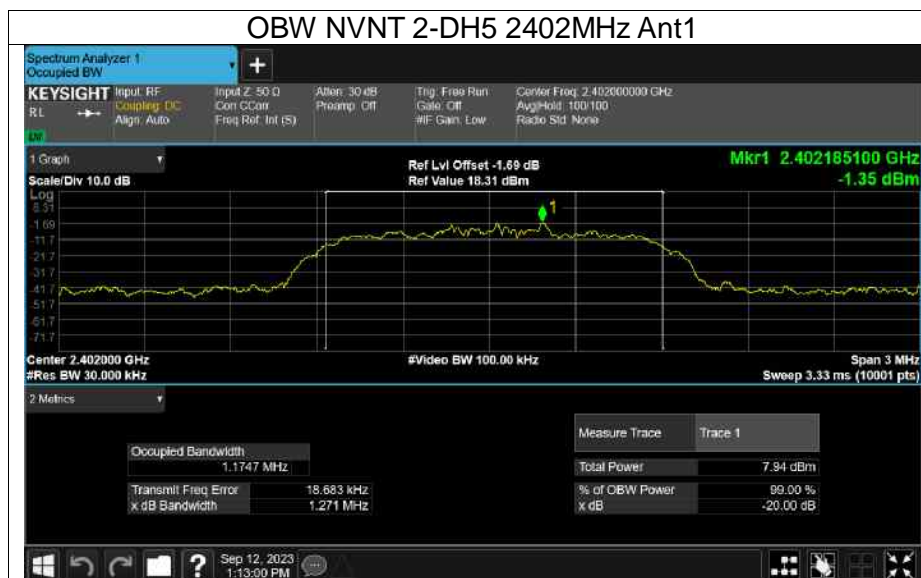

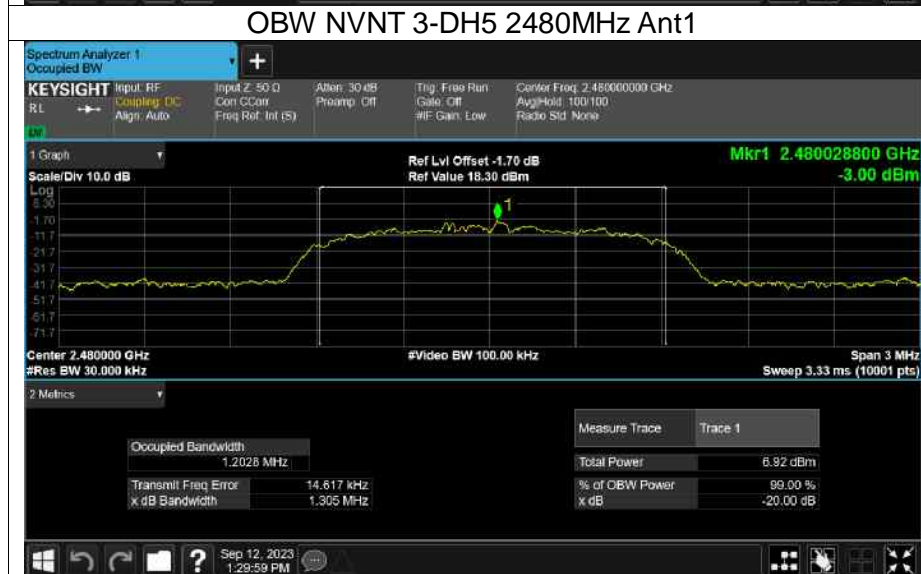
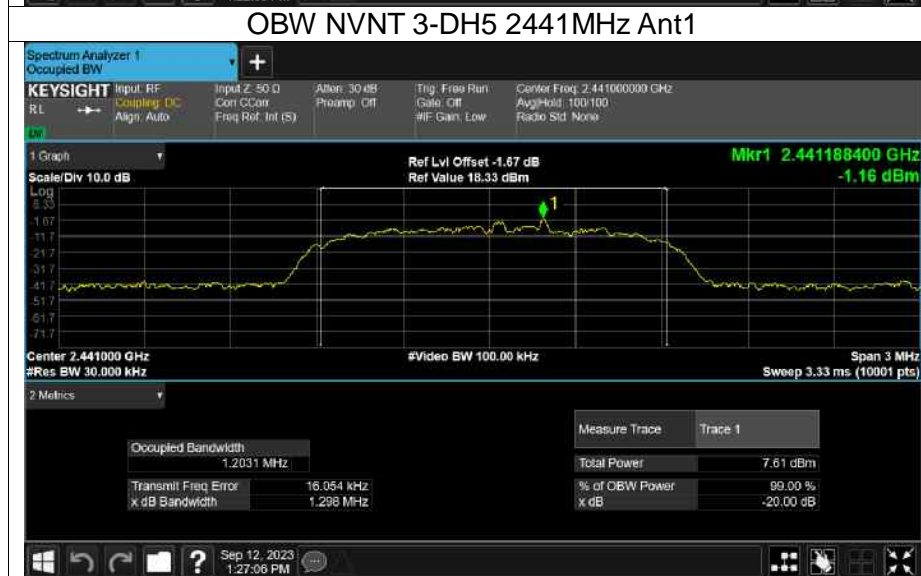
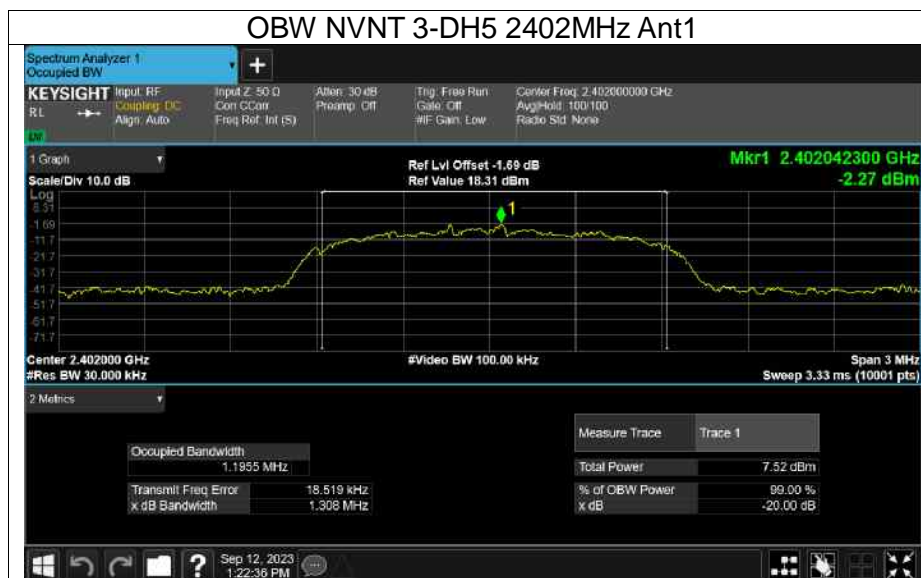



Carrier Frequencies Separation

| Condition | Mode | Antenna | Hopping Freq1 (MHz) | Hopping Freq2 (MHz) | HFS (MHz) | Limit (MHz) | Verdict |
|-----------|-------|---------|---------------------|---------------------|-----------|-------------|---------|
| NVNT | 1-DH5 | Ant1 | 2402.008 | 2403.034 | 1.026 | 0.687 | Pass |
| NVNT | 1-DH5 | Ant1 | 2441.028 | 2442.03 | 1.002 | 0.633 | Pass |
| NVNT | 1-DH5 | Ant1 | 2478.992 | 2479.93 | 0.938 | 0.677 | Pass |
| NVNT | 2-DH5 | Ant1 | 2401.94 | 2403.038 | 1.098 | 0.88 | Pass |
| NVNT | 2-DH5 | Ant1 | 2441.04 | 2442.038 | 0.998 | 0.874 | Pass |
| NVNT | 2-DH5 | Ant1 | 2478.97 | 2480.02 | 1.05 | 0.856 | Pass |
| NVNT | 3-DH5 | Ant1 | 2401.962 | 2403.036 | 1.074 | 0.863 | Pass |
| NVNT | 3-DH5 | Ant1 | 2440.932 | 2442.048 | 1.116 | 0.874 | Pass |
| NVNT | 3-DH5 | Ant1 | 2478.918 | 2480.046 | 1.128 | 0.874 | Pass |



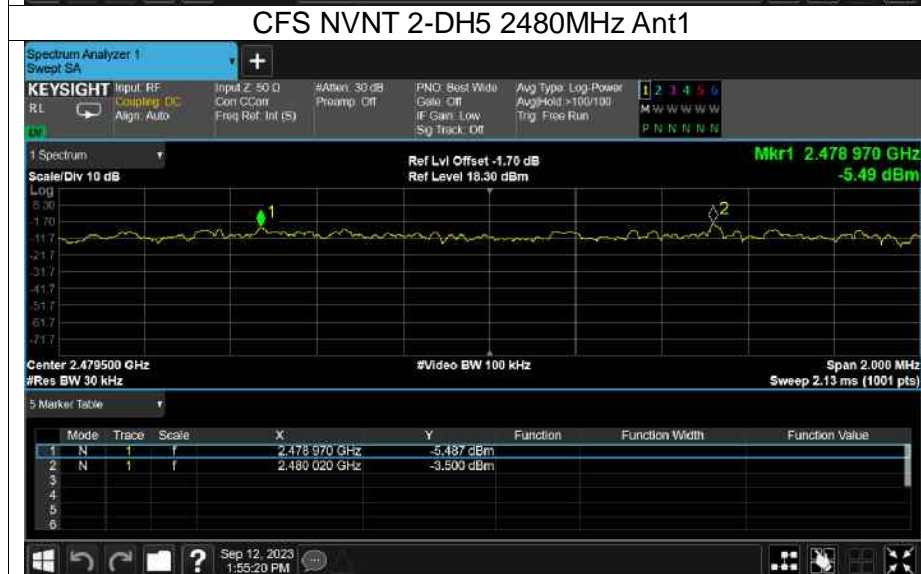
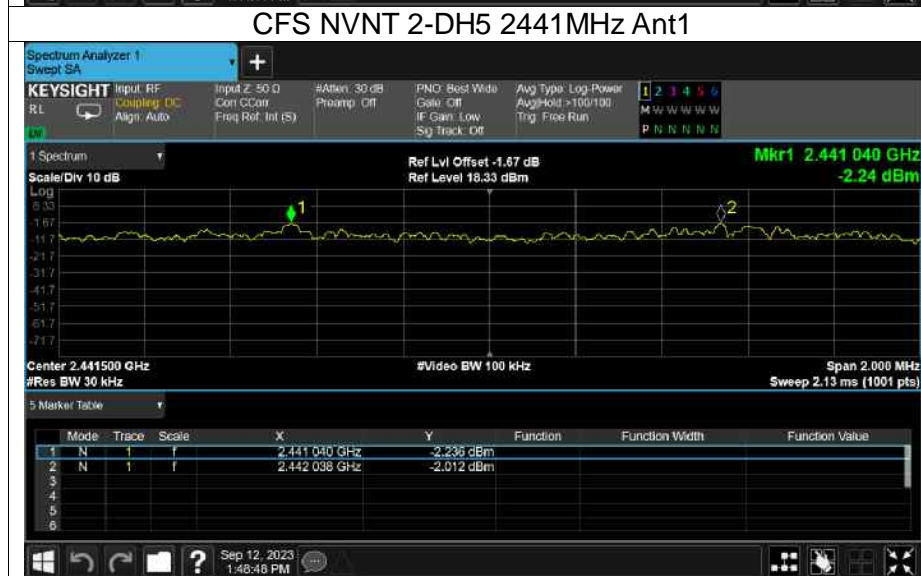
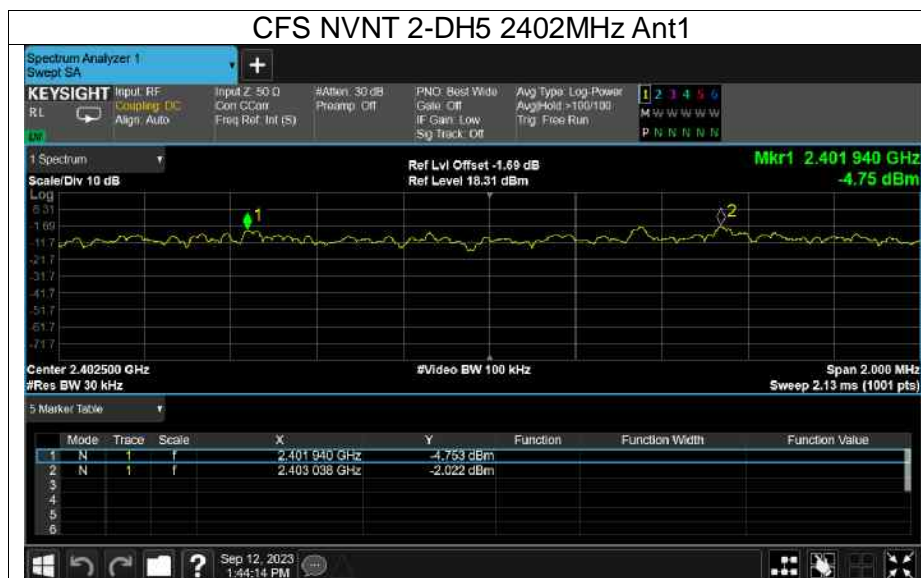

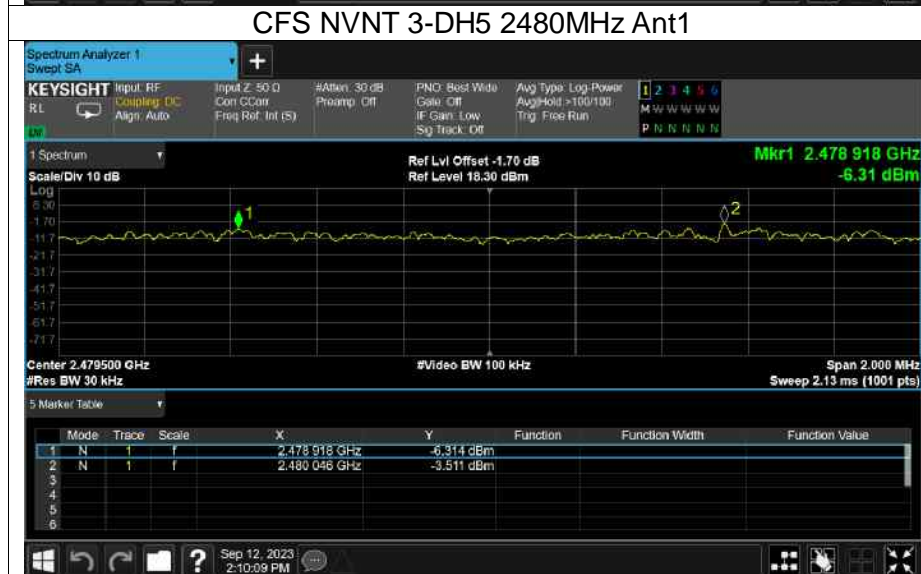
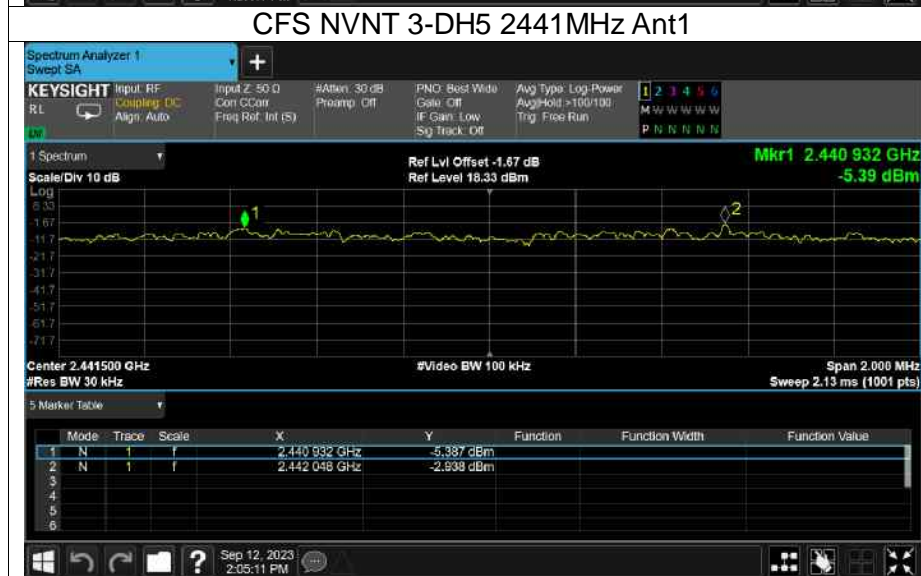
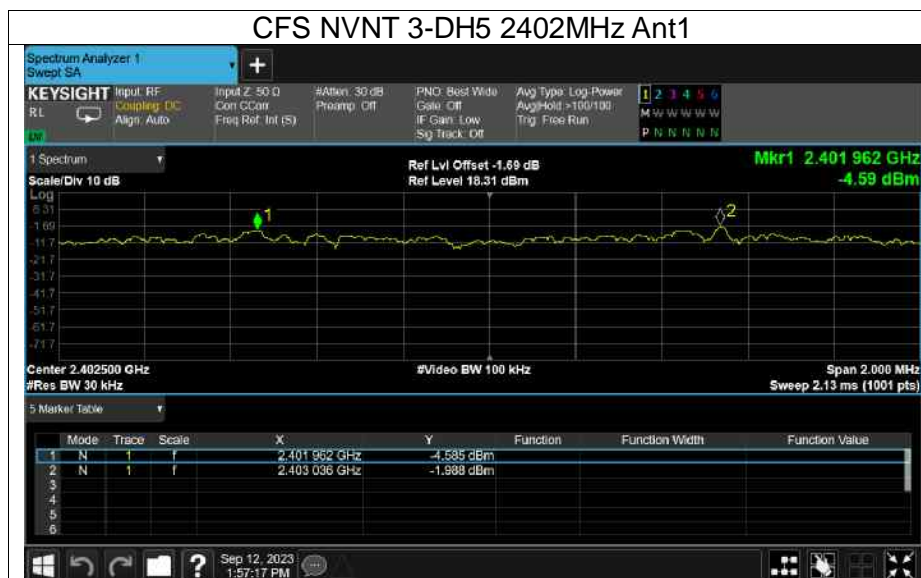



Band Edge

| Condition | Mode | Frequency (MHz) | Antenna | Hopping Mode | Max Value (dBc) | Limit (dBc) | Verdict |
|-----------|-------|-----------------|---------|--------------|-----------------|-------------|---------|
| NVNT | 1-DH5 | 2402 | Ant1 | No-Hopping | -59.68 | -20 | Pass |
| NVNT | 1-DH5 | 2480 | Ant1 | No-Hopping | -62.51 | -20 | Pass |
| NVNT | 2-DH5 | 2402 | Ant1 | No-Hopping | -56.54 | -20 | Pass |
| NVNT | 2-DH5 | 2480 | Ant1 | No-Hopping | -61.86 | -20 | Pass |
| NVNT | 3-DH5 | 2402 | Ant1 | No-Hopping | -54.61 | -20 | Pass |
| NVNT | 3-DH5 | 2480 | Ant1 | No-Hopping | -58.01 | -20 | Pass |



Test Graphs

Band Edge NVNT 1-DH5 2402MHz Ant1 No-Hopping Ref



Band Edge NVNT 1-DH5 2402MHz Ant1 No-Hopping Emission

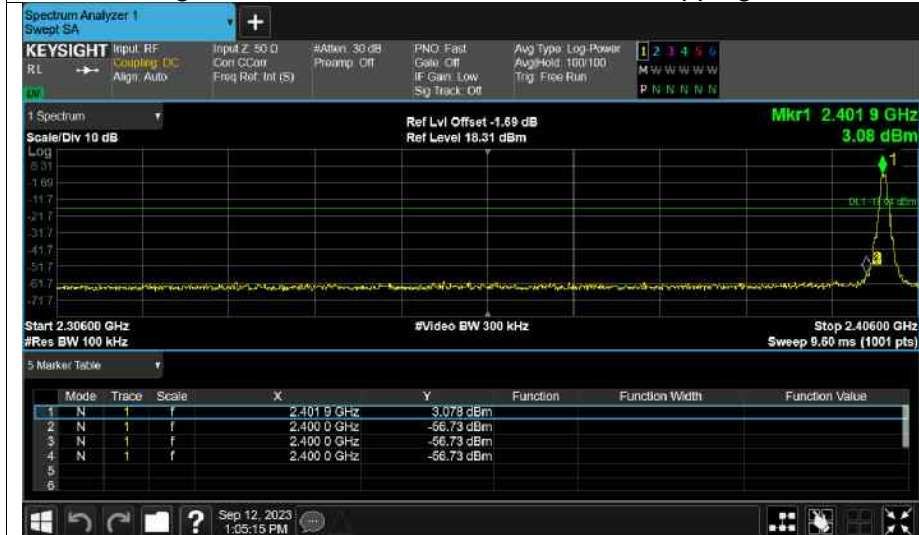

Band Edge NVNT 1-DH5 2480MHz Ant1 No-Hopping Ref

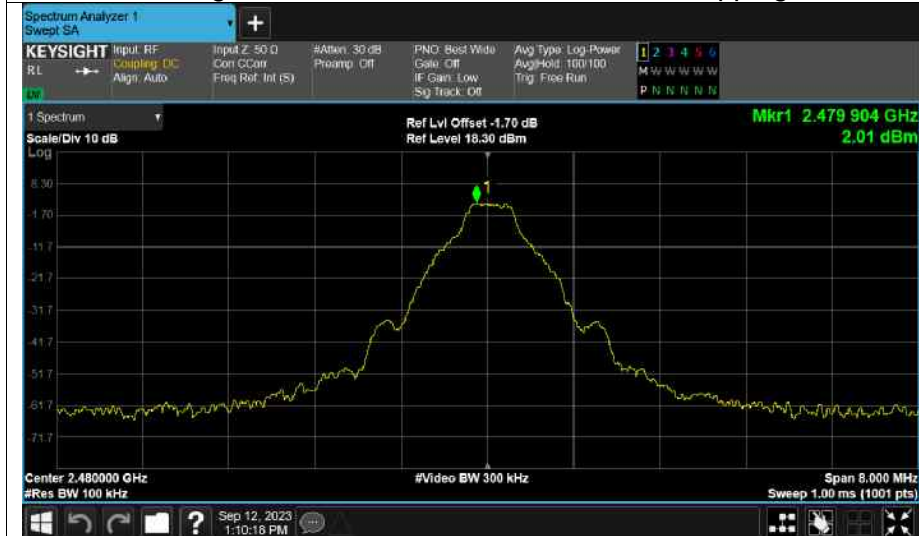



Band Edge NVNT 1-DH5 2480MHz Ant1 No-Hopping Emission

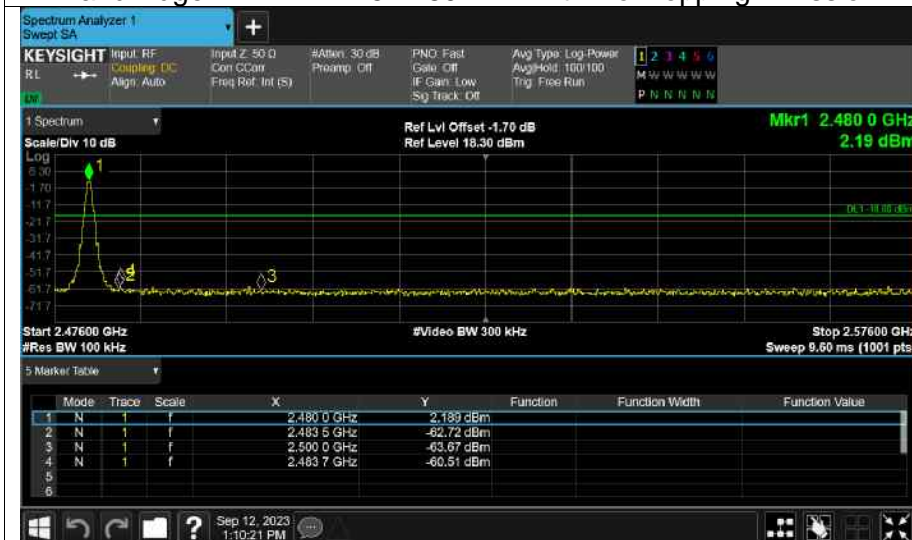

Band Edge NVNT 2-DH5 2402MHz Ant1 No-Hopping Ref



Band Edge NVNT 2-DH5 2402MHz Ant1 No-Hopping Emission

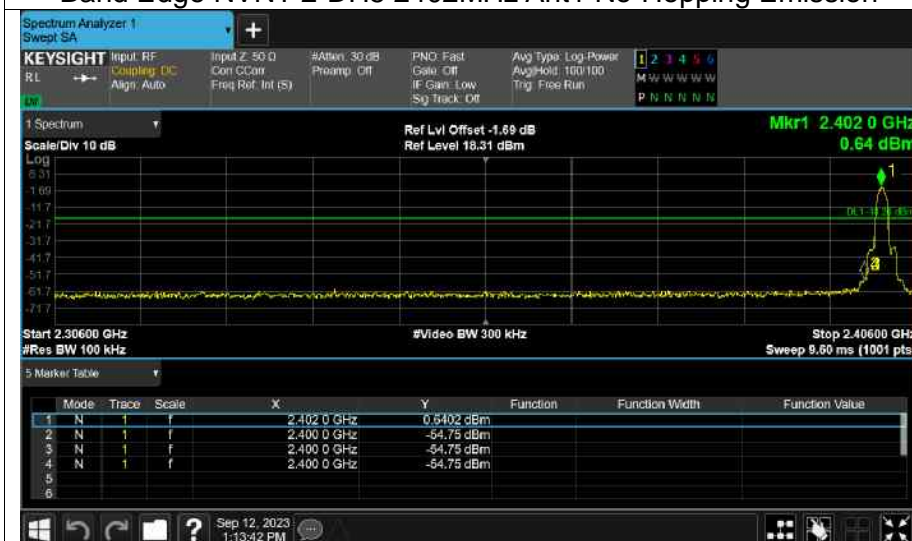

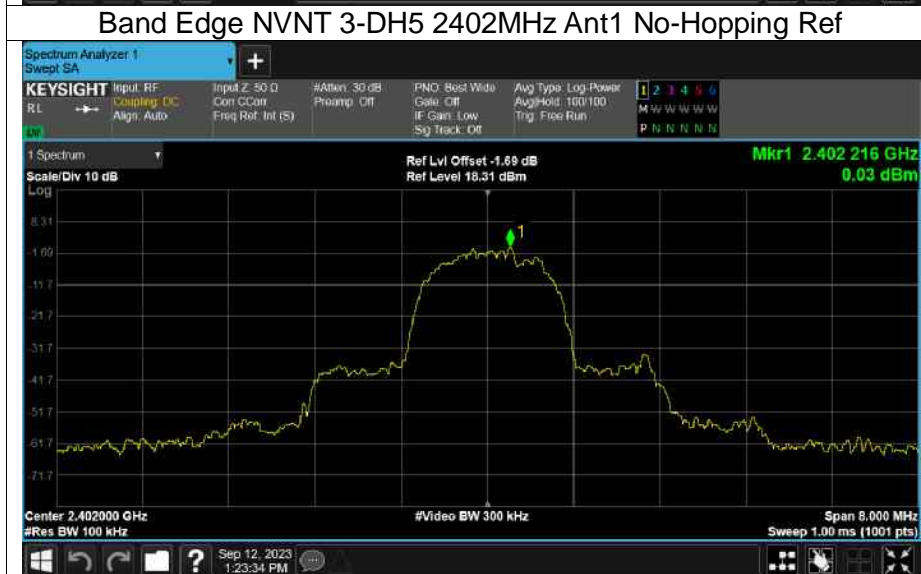
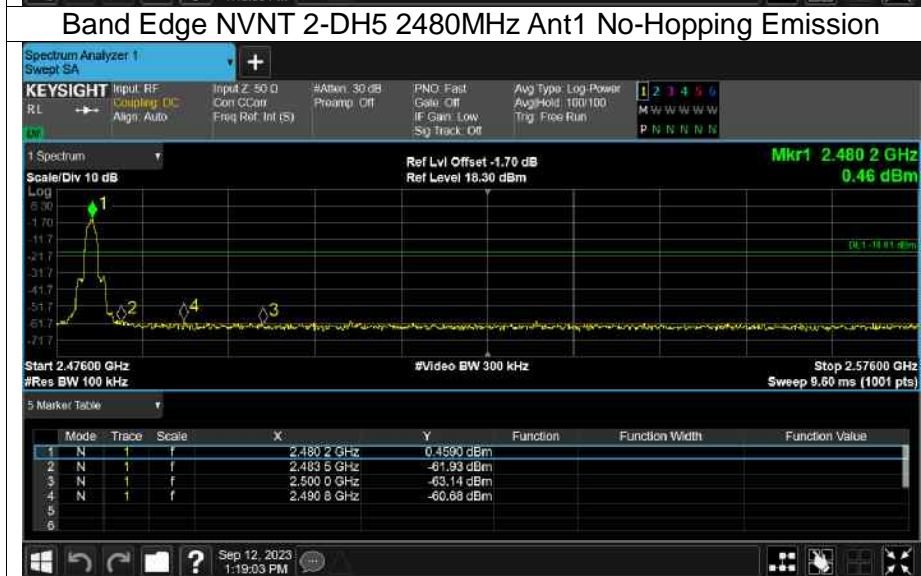
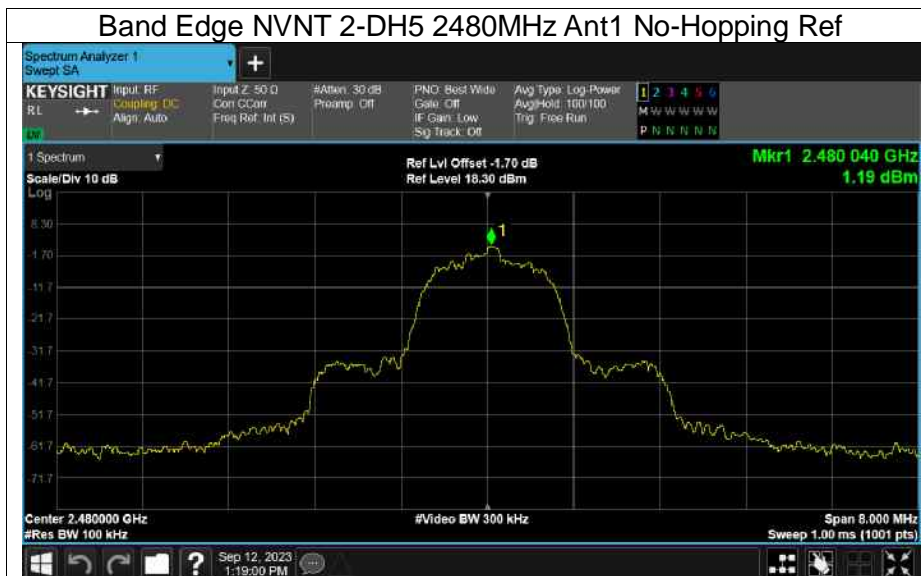



Band Edge NVNT 3-DH5 2402MHz Ant1 No-Hopping Emission



Band Edge NVNT 3-DH5 2480MHz Ant1 No-Hopping Ref



Band Edge NVNT 3-DH5 2480MHz Ant1 No-Hopping Emission

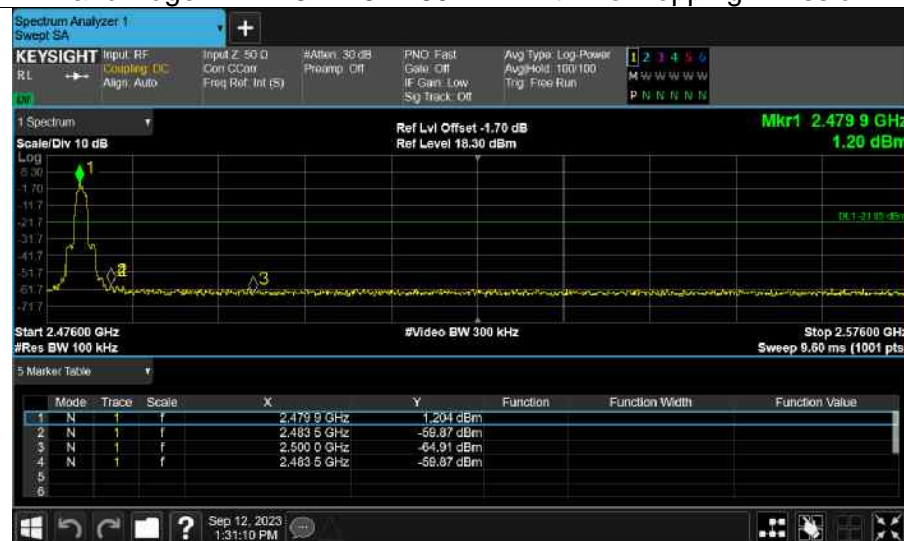



Band Edge(Hopping)

| Condition | Mode | Frequency (MHz) | Antenna | Hopping Mode | Max Value (dBc) | Limit (dBc) | Verdict |
|-----------|-------|-----------------|---------|--------------|-----------------|-------------|---------|
| NVNT | 1-DH5 | 2402 | Ant1 | Hopping | -62.74 | -20 | Pass |
| NVNT | 1-DH5 | 2480 | Ant1 | Hopping | -62.33 | -20 | Pass |
| NVNT | 2-DH5 | 2402 | Ant1 | Hopping | -59.33 | -20 | Pass |
| NVNT | 2-DH5 | 2480 | Ant1 | Hopping | -60.26 | -20 | Pass |
| NVNT | 3-DH5 | 2402 | Ant1 | Hopping | -61.11 | -20 | Pass |
| NVNT | 3-DH5 | 2480 | Ant1 | Hopping | -60.95 | -20 | Pass |

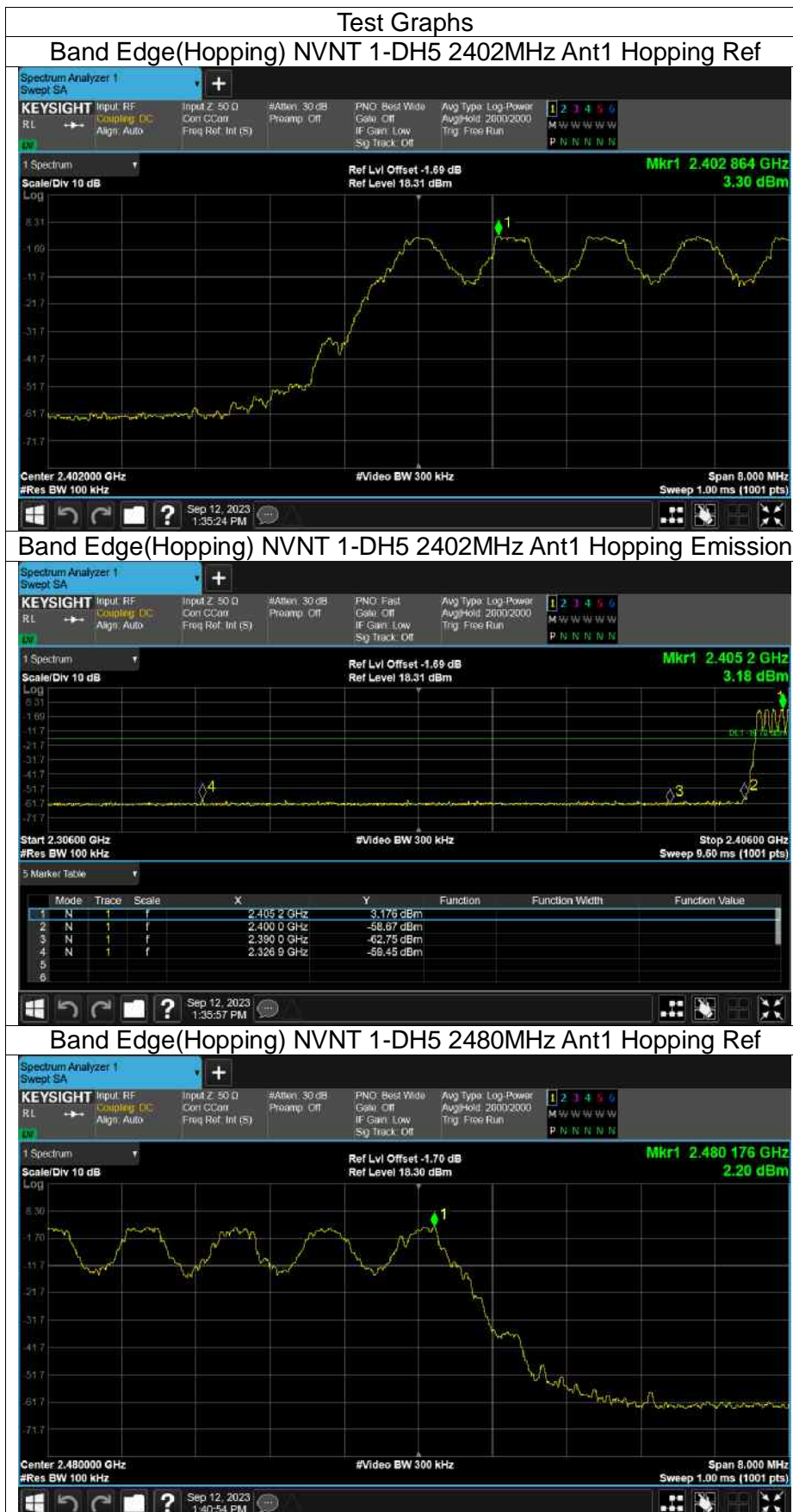



Band Edge(Hopping) NVNT 1-DH5 2480MHz Ant1 Hopping Emission

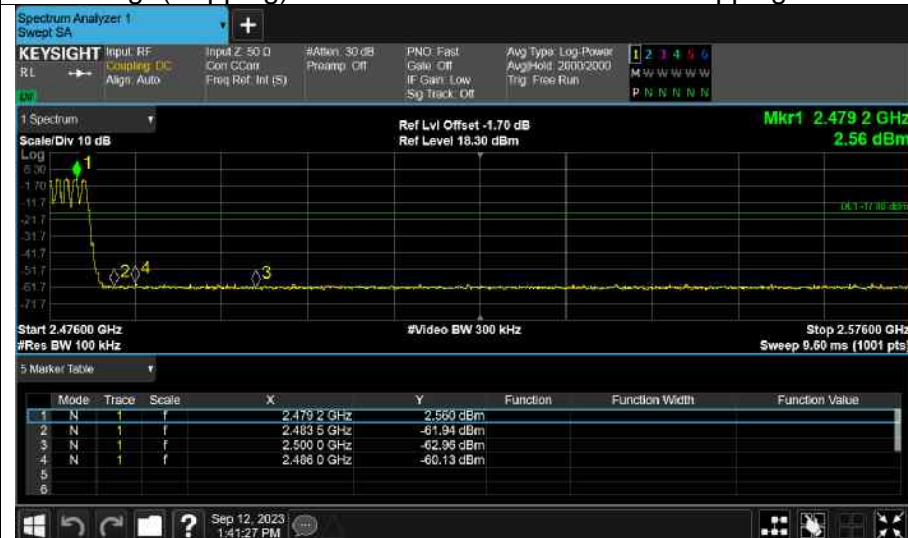

Band Edge(Hopping) NVNT 2-DH5 2402MHz Ant1 Hopping Ref



Band Edge(Hopping) NVNT 2-DH5 2402MHz Ant1 Hopping Emission

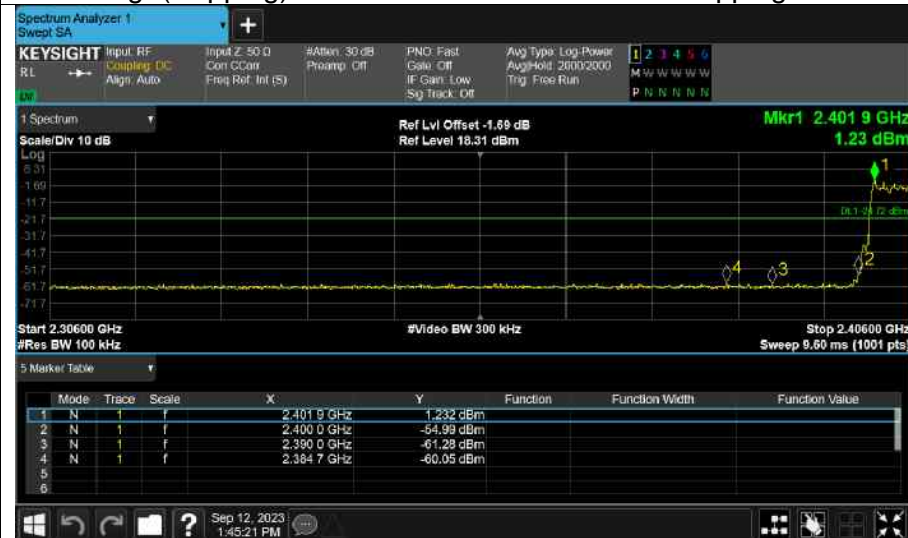



Band Edge(Hopping) NVNT 2-DH5 2480MHz Ant1 Hopping Ref



Band Edge(Hopping) NVNT 2-DH5 2480MHz Ant1 Hopping Emission

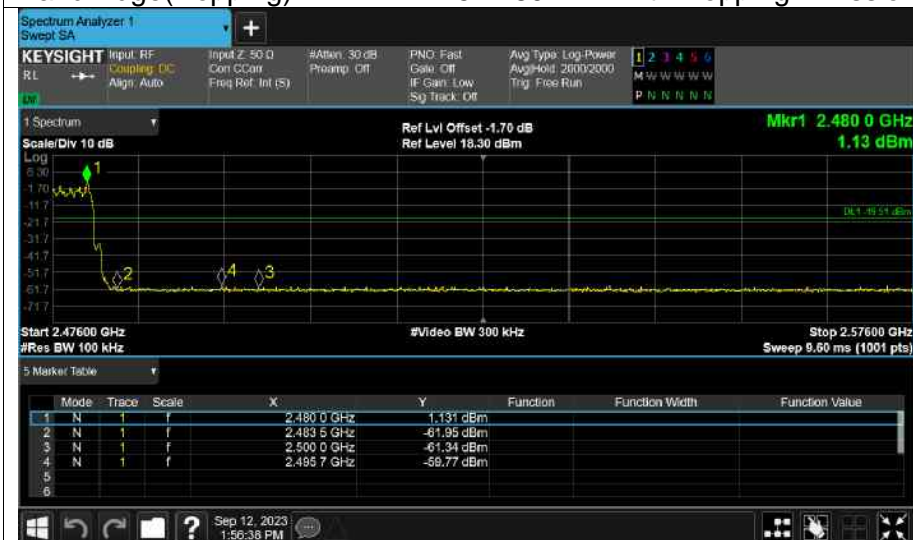

Band Edge(Hopping) NVNT 3-DH5 2402MHz Ant1 Hopping Ref





Band Edge(Hopping) NVNT 3-DH5 2402MHz Ant1 Hopping Emission

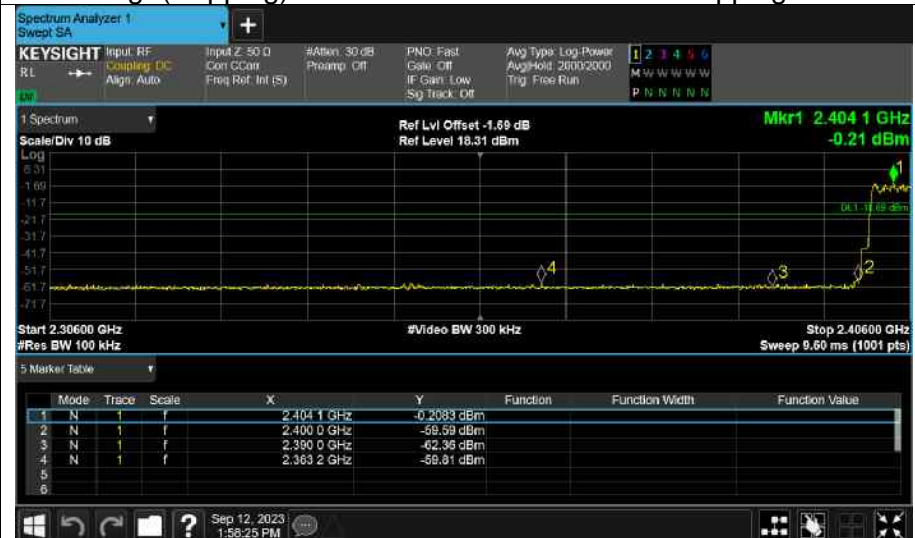

Band Edge(Hopping) NVNT 3-DH5 2480MHz Ant1 Hopping Ref



Band Edge(Hopping) NVNT 3-DH5 2480MHz Ant1 Hopping Emission

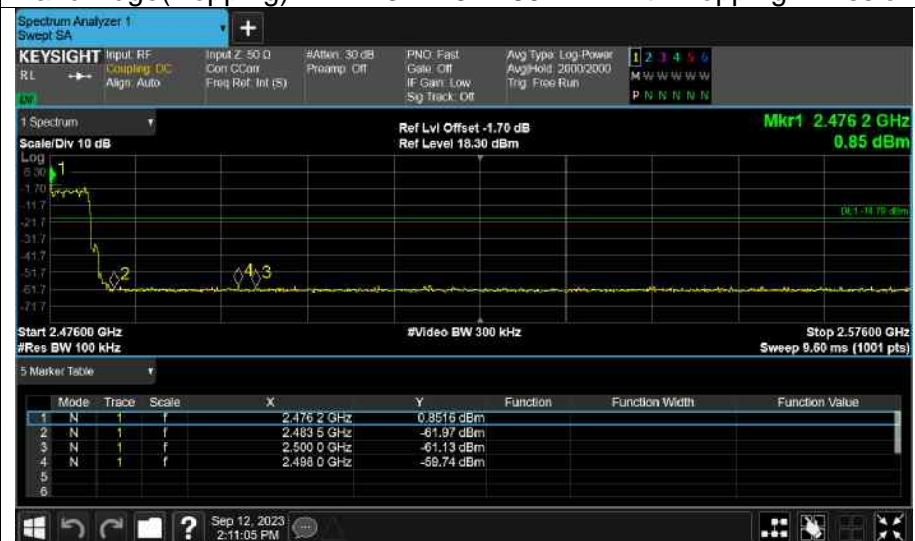



Conducted RF Spurious Emission

| Condition | Mode | Frequency (MHz) | Antenna | Max Value (dBc) | Limit (dBc) | Verdict |
|-----------|-------|-----------------|---------|-----------------|-------------|---------|
| NVNT | 1-DH5 | 2402 | Ant1 | -57.69 | -20 | Pass |
| NVNT | 1-DH5 | 2441 | Ant1 | -59.01 | -20 | Pass |
| NVNT | 1-DH5 | 2480 | Ant1 | -63.85 | -20 | Pass |
| NVNT | 2-DH5 | 2402 | Ant1 | -60.17 | -20 | Pass |
| NVNT | 2-DH5 | 2441 | Ant1 | -60.42 | -20 | Pass |
| NVNT | 2-DH5 | 2480 | Ant1 | -63.66 | -20 | Pass |
| NVNT | 3-DH5 | 2402 | Ant1 | -61.05 | -20 | Pass |
| NVNT | 3-DH5 | 2441 | Ant1 | -62.02 | -20 | Pass |
| NVNT | 3-DH5 | 2480 | Ant1 | -63.87 | -20 | Pass |



Test Graphs

Tx. Spurious NVNT 1-DH5 2402MHz Ant1 Ref



Tx. Spurious NVNT 1-DH5 2402MHz Ant1 Emission

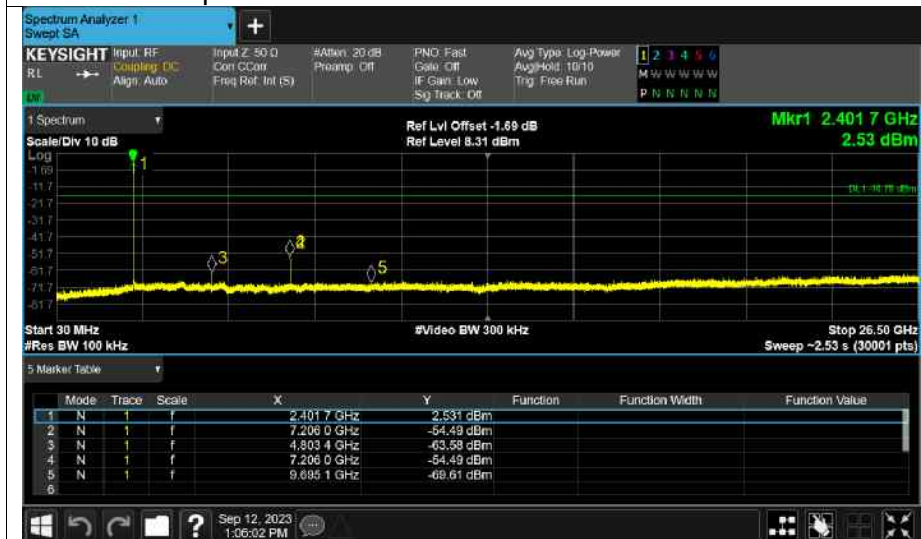

Tx. Spurious NVNT 1-DH5 2441MHz Ant1 Ref



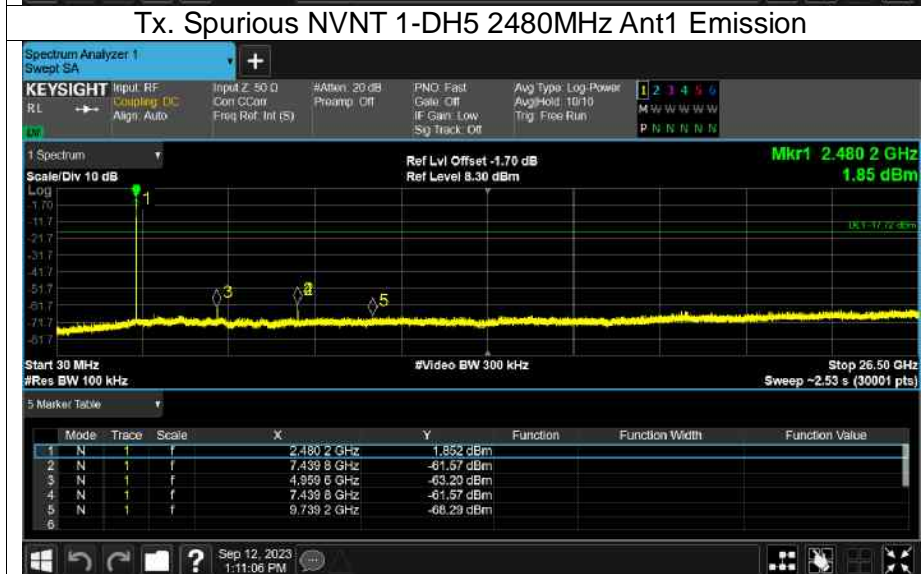
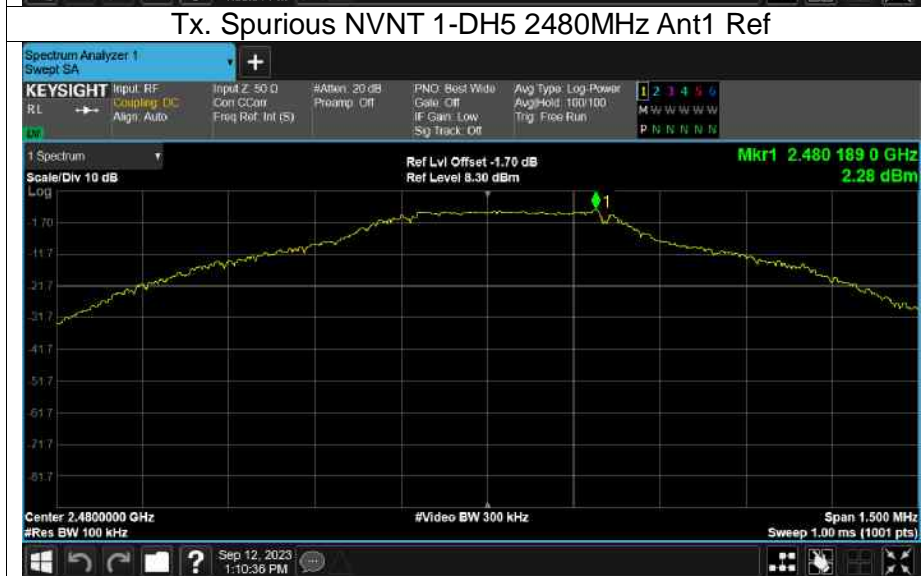
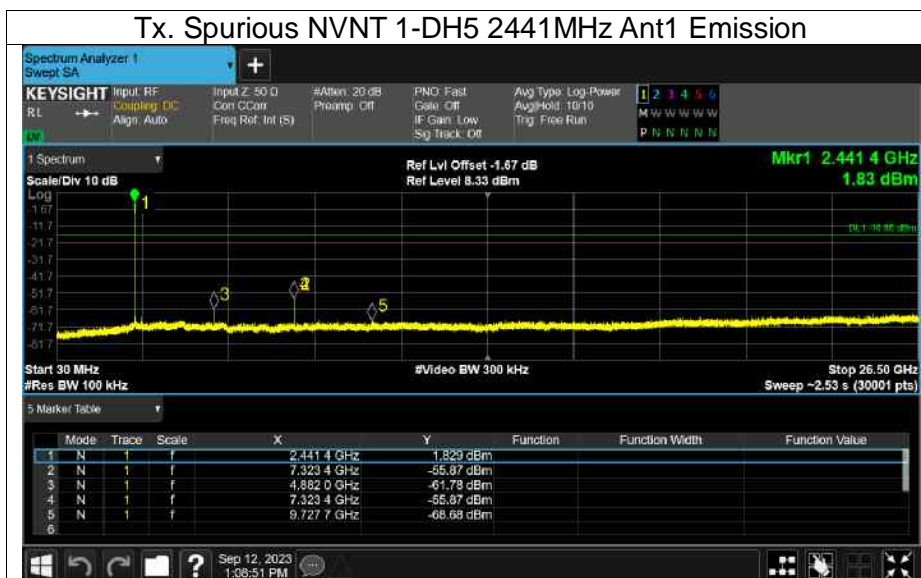

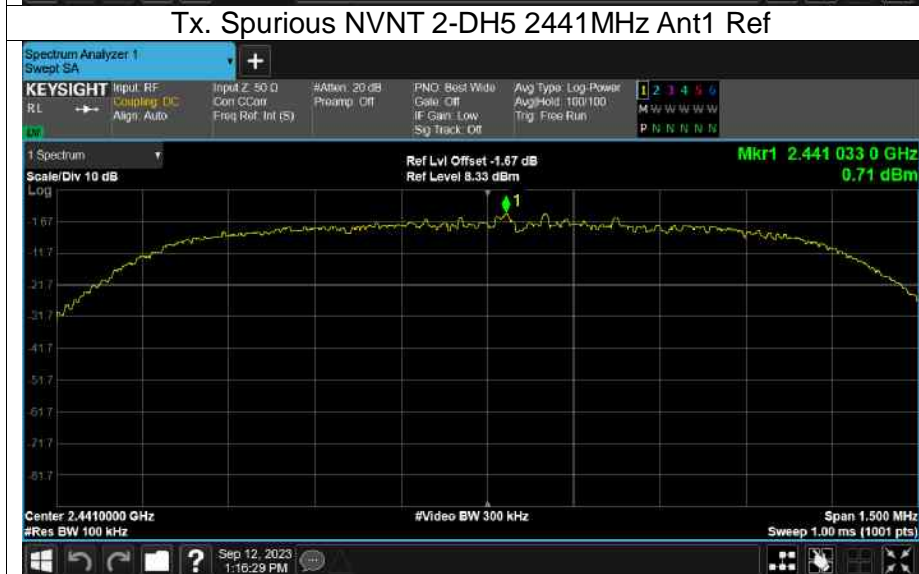
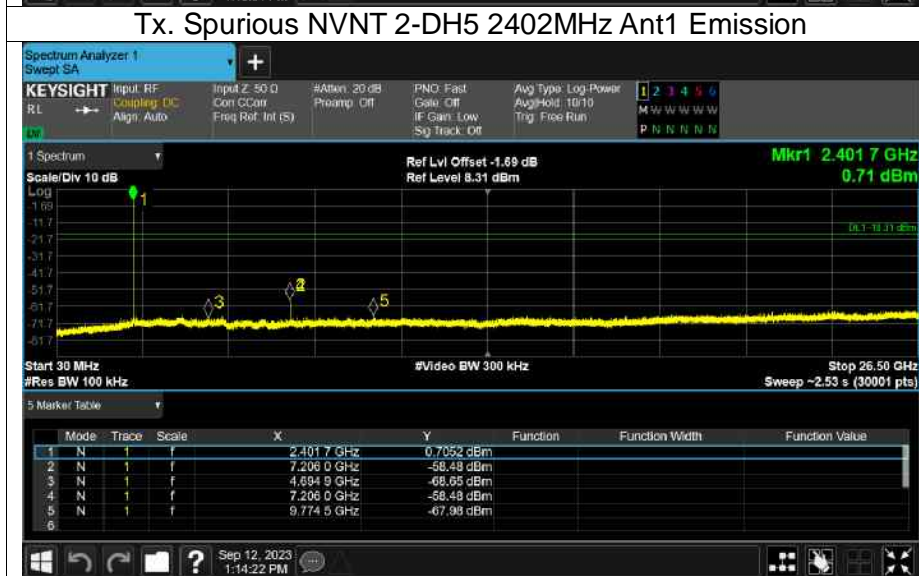
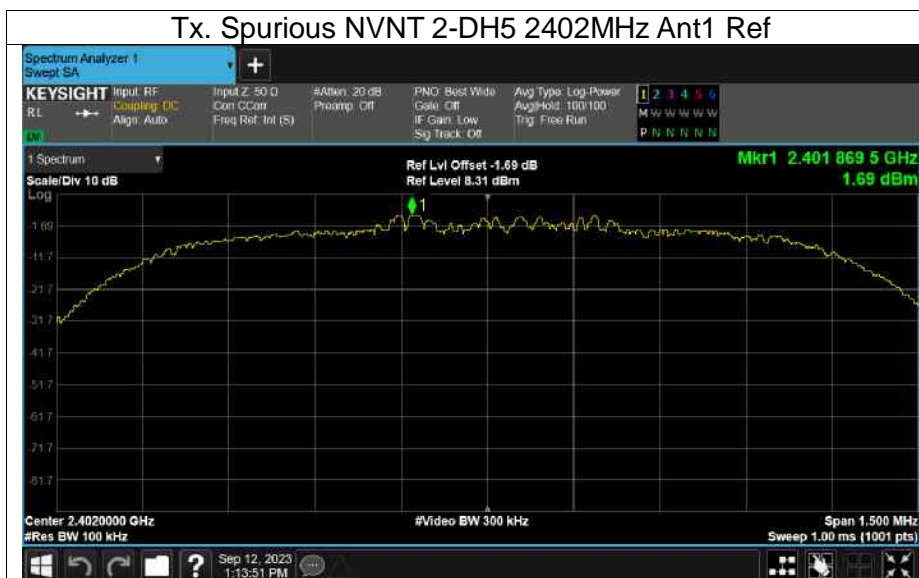

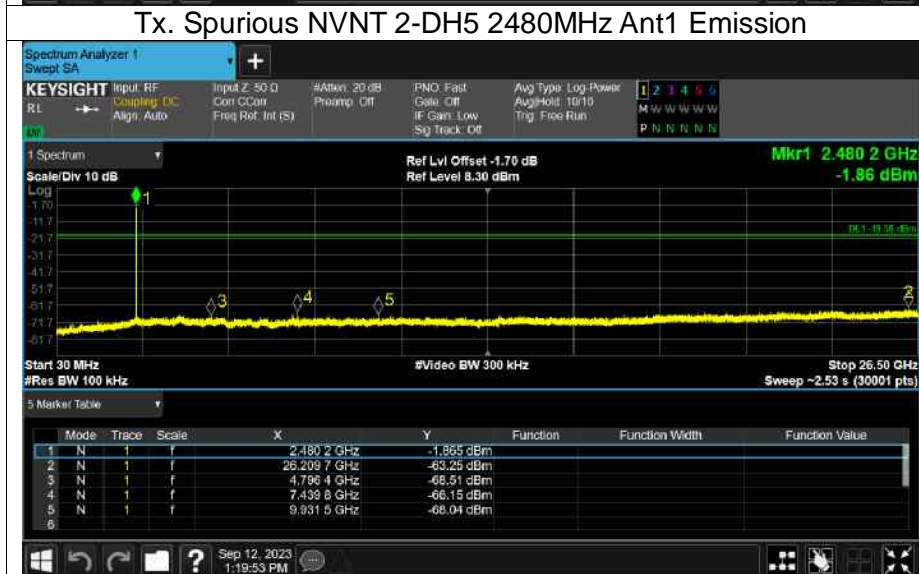
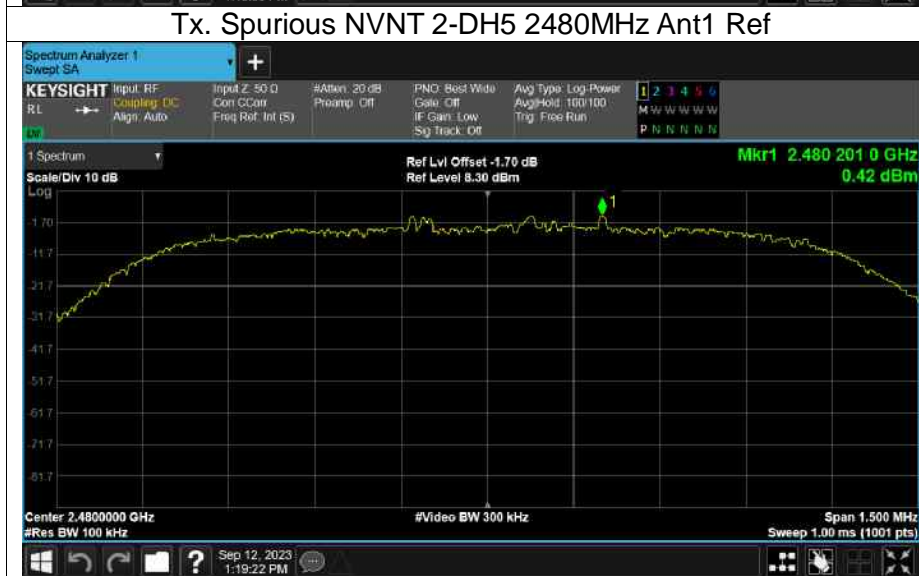
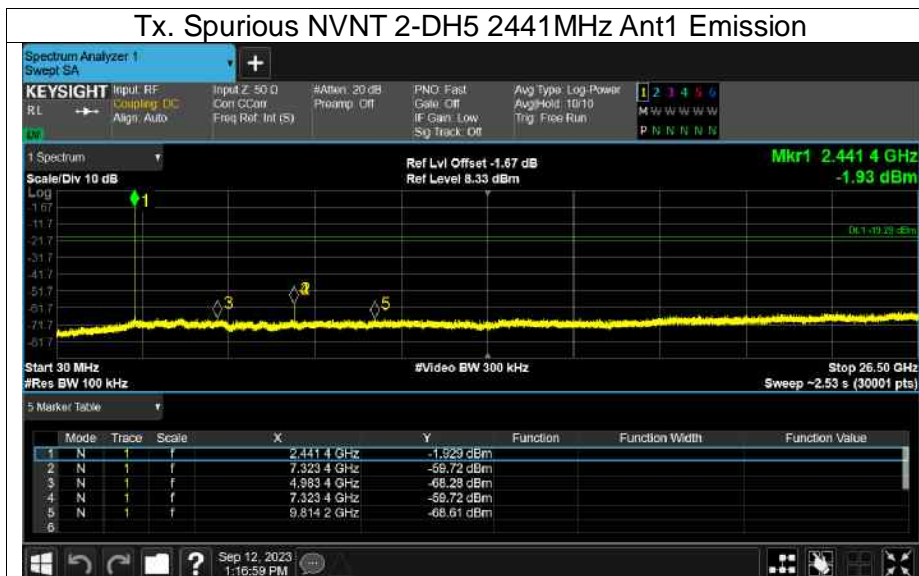

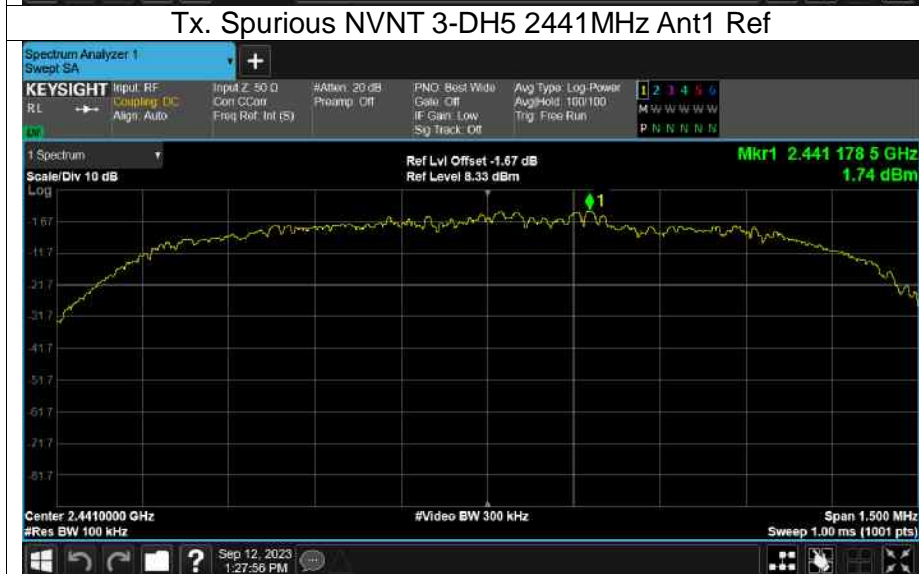
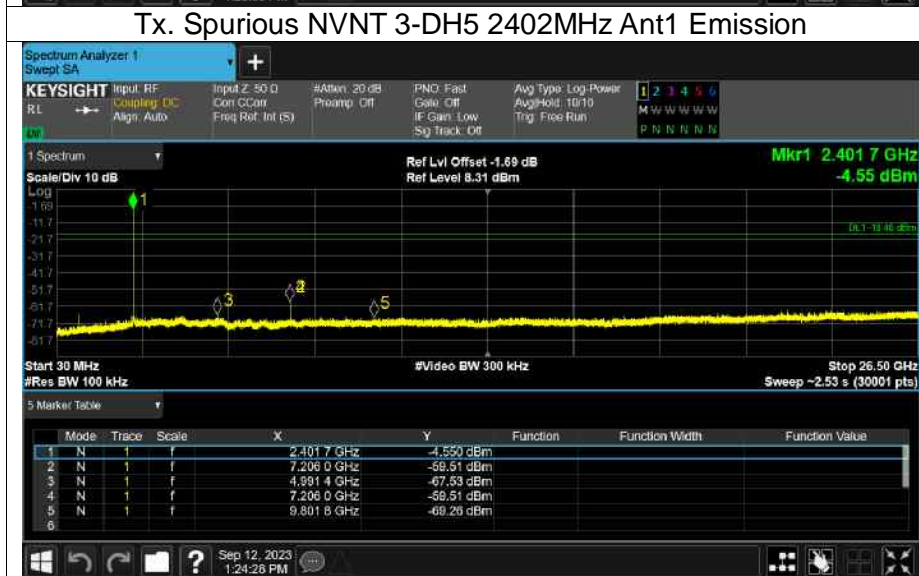
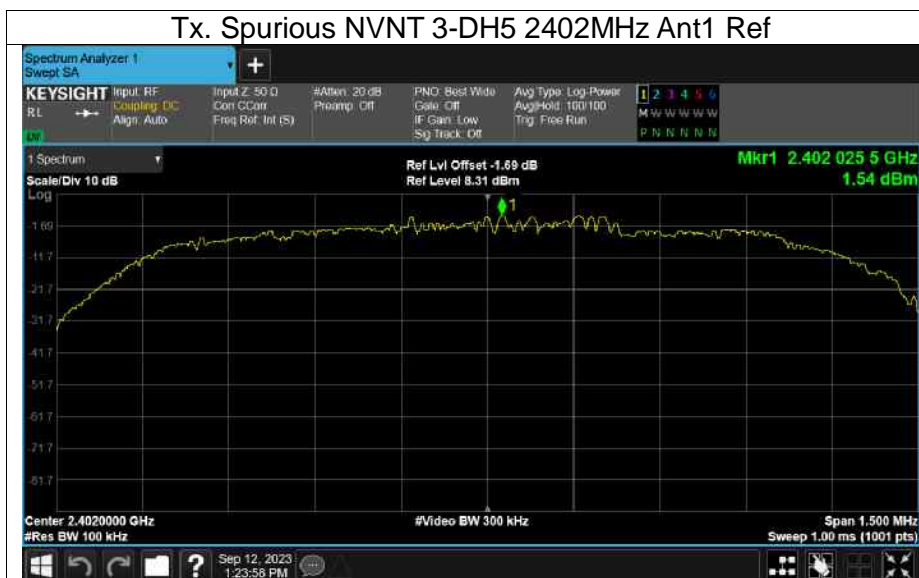

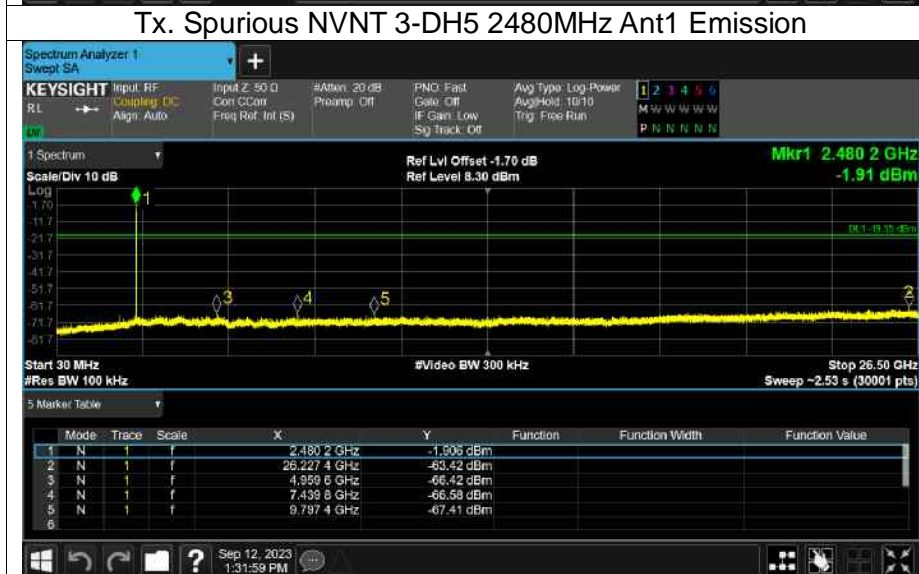
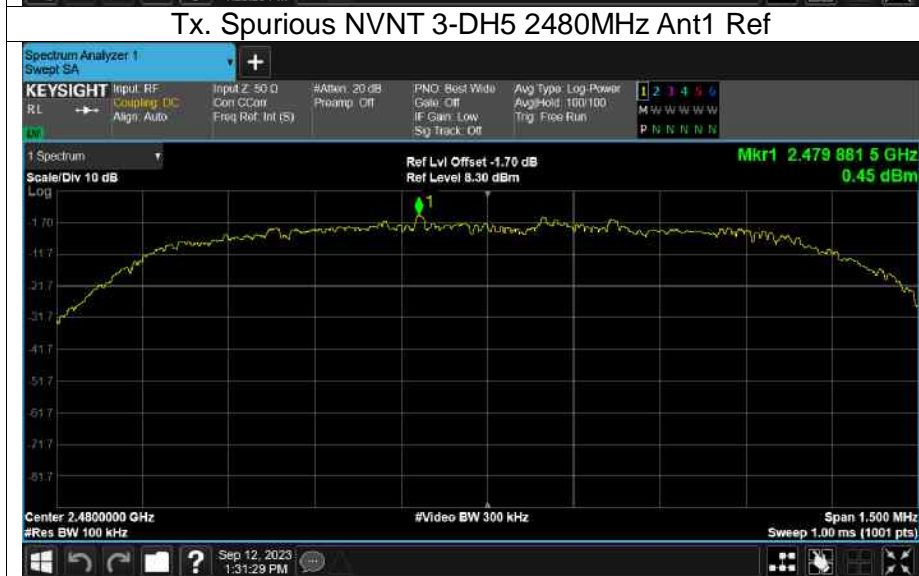
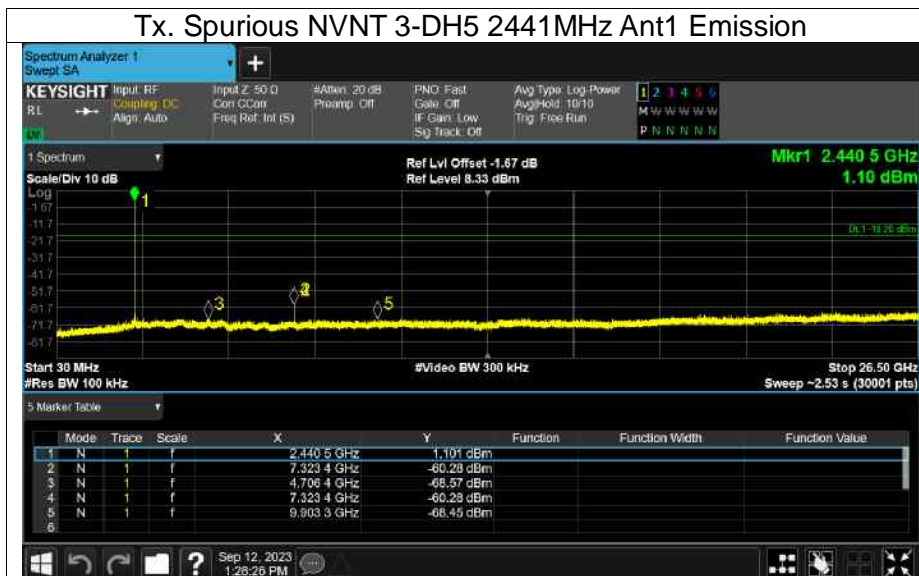



Number of Hopping Channel

| Condition | Mode | Antenna | Hopping Number | Limit | Verdict |
|-----------|-------|---------|----------------|-------|---------|
| NVNT | 1-DH5 | Ant1 | 79 | 15 | Pass |
| NVNT | 2-DH5 | Ant1 | 79 | 15 | Pass |
| NVNT | 3-DH5 | Ant1 | 79 | 15 | Pass |



Test Graphs

Hopping No. NVNT 1-DH5 2441MHz Ant1

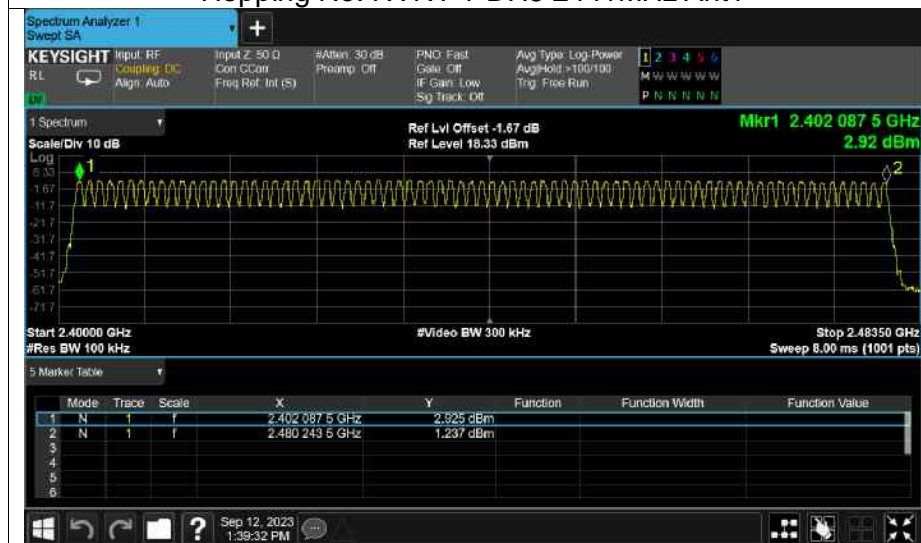

Hopping No. NVNT 2-DH5 2441MHz Ant1

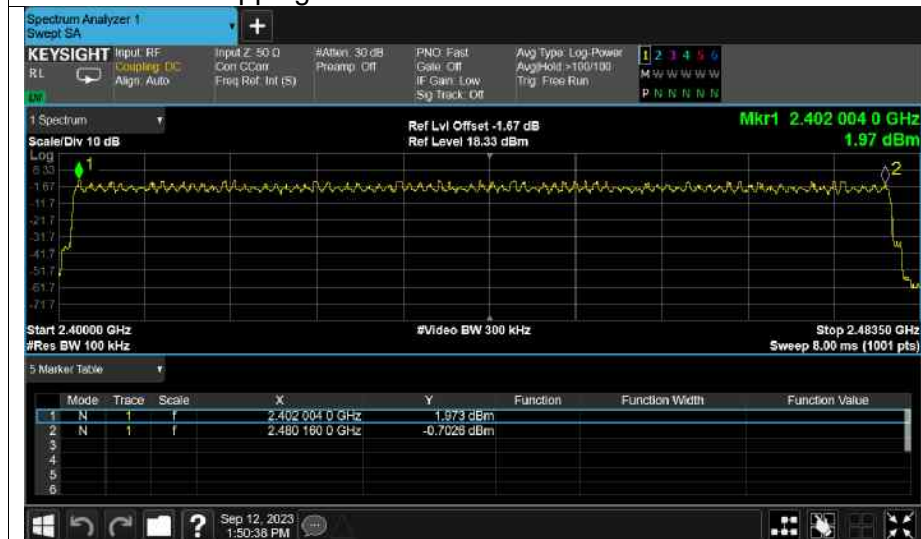

Hopping No. NVNT 3-DH5 2441MHz Ant1

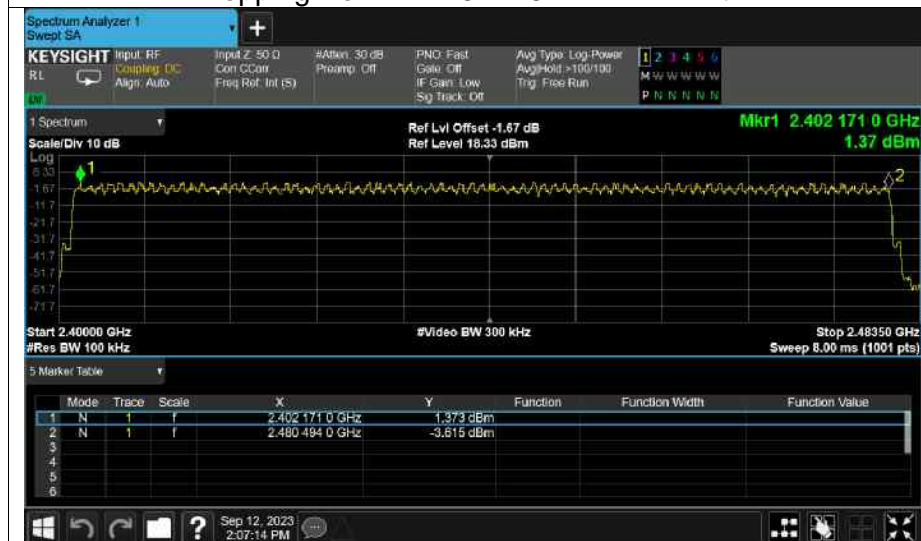



Dwell Time

| Condition | Mode | Frequency (MHz) | Antenna | Pulse Time (ms) | Total Dwell Time (ms) | Burst Count | Period Time (ms) | Limit (ms) | Verdict |
|-----------|-------|-----------------|---------|-----------------|-----------------------|-------------|------------------|------------|---------|
| NVNT | 1-DH5 | 2441 | Ant1 | 2.88 | 279.36 | 97 | 31600 | 400 | Pass |
| NVNT | 2-DH5 | 2441 | Ant1 | 2.333 | 240.299 | 103 | 31600 | 400 | Pass |
| NVNT | 3-DH5 | 2441 | Ant1 | 2.887 | 311.796 | 108 | 31600 | 400 | Pass |



Test Graphs

Dwell NVNT 1-DH5 2441MHz Ant1 One Burst

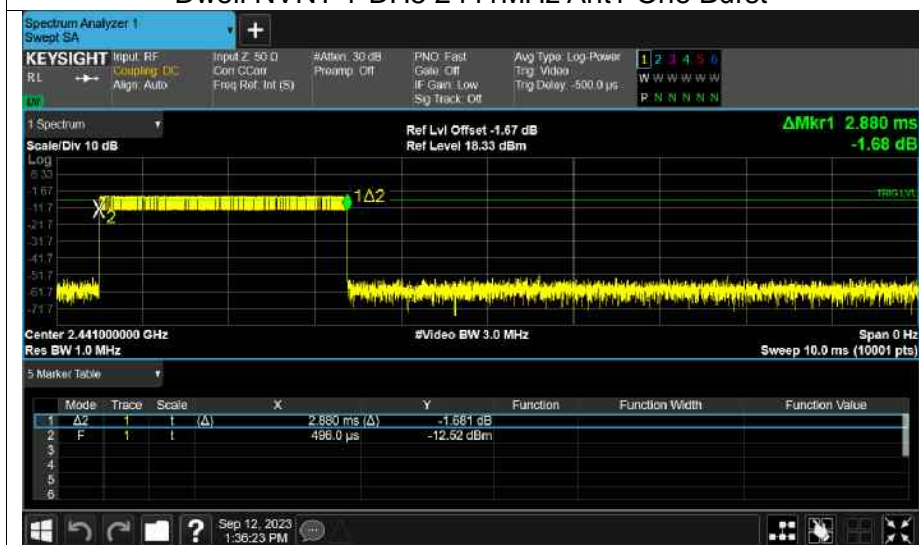

Dwell NVNT 1-DH5 2441MHz Ant1 Accumulated



Dwell NVNT 2-DH5 2441MHz Ant1 One Burst



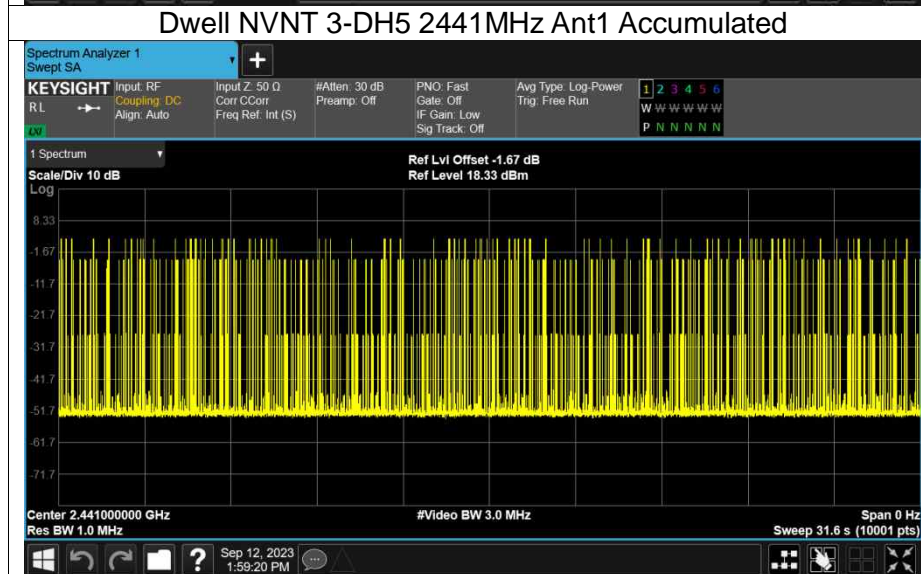
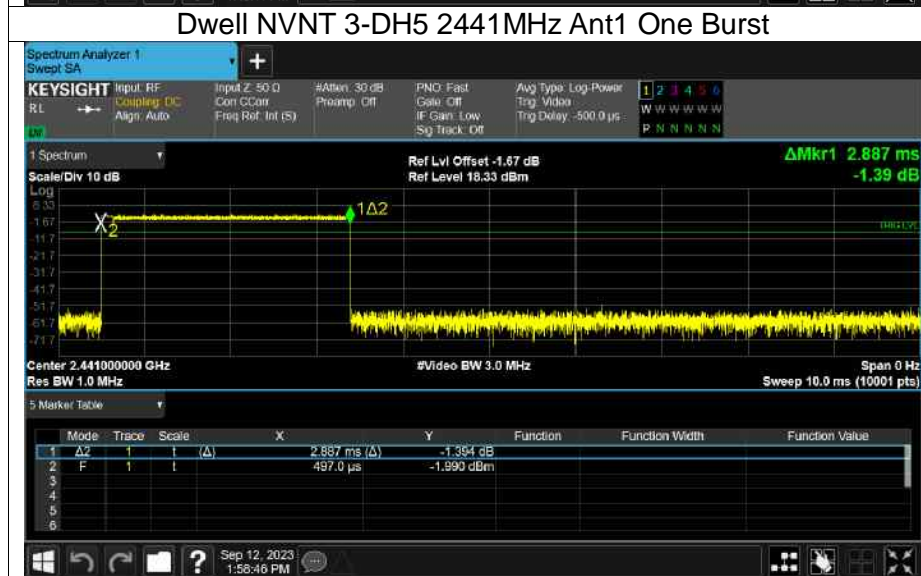
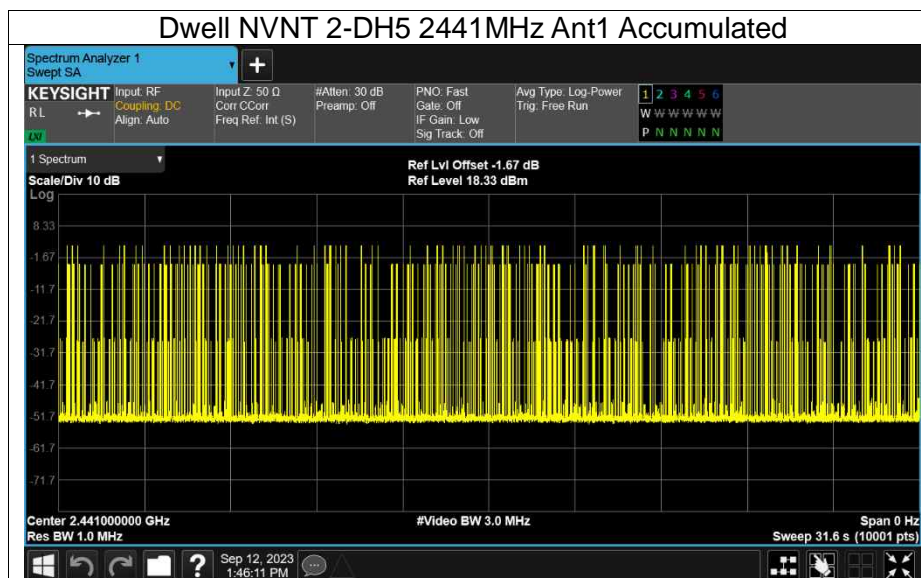

*****END OF THE REPORT*****