

FCC 47 CFR PART 22H and 24E

Product Type : 2G/3G Module

Applicant : Telit Communications S.p.A.

Address : Via Stazione di Prosecco, 5/B, Sgonico, TS 34010, Italy

Trade Name : Telit

Model Number : HE910

Test Specification : FCC 47 CFR PART 22H: Oct, 2009
FCC 47 CFR PART 24E: Oct, 2009
CANADA RSS-132 ISSUE 2: Sep., 2005
CANADA RSS-133 ISSUE 5: Feb., 2009
Canada RSS-Gen ISSUE 3: Dec., 2010
ANSI/TIA-603-C-2004

Receive Date : Nov. 30, 2011

Issue Date : Feb. 03, 2012

Issue by

A Test Lab Techno Corp.
No. 140-1, Changan Street, Bade City,
Taoyuan County 334, Taiwan R.O.C.
Tel : +886-3-2710188 / Fax : +886-3-2710190



Taiwan Accreditation Foundation accreditation number: 1330

Note: This report shall not be reproduced except in full, without the written approval of A Test Lab Techno Corp. This document may be altered or revised by A Test Lab Techno Corp. personnel only, and shall be noted in the revision section of the document. The client should not use it to claim product endorsement by TAF, or any government agencies. The test results in the report only apply to the tested sample.

Revision History

Rev.	Issue Date	Revisions	Revised By
00	Dec. 20, 2011	Initial Issue	
01	Jan. 30, 2012	Revised software version.	Joyce Liao
02	Feb. 03, 2012	Add IC standard and RX of field strength of spurious radiation test data	Linda Su

Verification of Compliance

Issued Date: 02/03/2012

Product Type : 2G/3G Module
Applicant : Telit Communications S.p.A.
Address : Via Stazione di Prosecco, 5/B, Sgonico, TS 34010, Italy
Trade Name : Telit
Model Number : HE910
FCC ID : RI7HE910
IC : 5131A-HE910
EUT Rated Voltage : DC 3.8V
Test Voltage : DC 3.4 / 3.8 / 4.2V
Applicable Standard : FCC 47 CFR PART 22H: Oct, 2009
FCC 47 CFR PART 24E: Oct, 2009
CANADA RSS-132 ISSUE 2: Sep., 2005
CANADA RSS-133 ISSUE 5: Feb., 2009
Canada RSS-Gen ISSUE 3: Dec., 2010
ANSI/TIA-603-C-2004

Test Result : Complied

Performing Lab. : A Test Lab Techno Corp.
No. 140-1, Changan Street, Bade City
Taoyuan County 334, Taiwan R.O.C.
Tel : +886-3-2710188 / Fax : +886-3-2710190

Taiwan Accreditation Foundation accreditation number:
1330
<http://www.atl-lab.com.tw/e-index.htm>

The above equipment was tested by A Test Lab Techno Corp. The test data, data evaluation, test procedures, and equipment configurations shown in this report were made in accordance with the procedures given in ANSI C63.4: 2009 and the energy emitted by the sample tested as described in this report is in compliance with the requirements of FCC Rules Part 22H, Part 24E. The test results of this report relate only to the tested sample identified in this report.

Approved By :  Reviewed By : 
(Manager) (Murphy Wang) (Testing Engineer) (Fly Lu)

TABLE OF CONTENTS

1	General Information	6
1.1.	EUT Description	6
1.2.	Mode of Operation	7
1.3.	EUT Exercise Software	7
1.4.	Configuration of Test System Details	8
1.5.	Test Site Environment	9
1.6.	Summary of Test Result	9
2	RF Output Power Test.....	10
2.1.	Limit.....	10
2.2.	Test Instruments.....	10
2.3.	Test Setup	10
2.4.	Test Procedure	10
2.5.	Uncertainty	11
2.6.	Test Result	11
3	Effective Radiated Power / Equivalent Isotropic Radiated Power Test	14
3.1.	Limit.....	14
3.2.	Test Instruments.....	14
3.3.	Setup.....	15
3.4.	Test Procedure	16
3.5.	Uncertainty	16
3.6.	Test Result	17
4	Occupied Bandwidth Test	19
4.1.	Limit.....	19
4.2.	Test Instruments.....	19
4.3.	Setup.....	19
4.4.	Test Procedure	20
4.5.	Uncertainty	20
4.6.	Test Result	21
5	Conducted Emission Test	37
5.1.	Limit.....	37
5.2.	Test Instruments.....	37
5.3.	Setup.....	37
5.4.	Test Procedure	38
5.5.	Uncertainty	38
5.6.	Test Result	38

6	Field Strength of Spurious Radiation Test	93
6.1.	Limit.....	93
6.2.	Test Instruments.....	93
6.3.	Setup.....	94
6.4.	Test Procedure.....	94
6.5.	Uncertainty.....	95
6.6.	Test Result.....	96
7	Frequency Stability (Temperature Variation) Test.....	109
7.1.	Limit.....	109
7.2.	Test Instruments.....	109
7.3.	Setup.....	109
7.4.	Test Procedure.....	110
7.5.	Uncertainty.....	110
7.6.	Test Result.....	111
8	Frequency Stability (Voltage Variation) Test.....	113
8.1.	Limit.....	113
8.2.	Test Instruments.....	113
8.3.	Setup.....	113
8.4.	Test Procedure.....	113
8.5.	Uncertainty.....	114
8.6.	Test Result.....	114

1 General Information

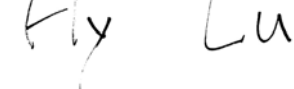
1.1. EUT Description

Applicant		Telit Communications S.p.A.			
Applicant Address		Via Stazione di Prosecco, 5/B, Sgonico, TS 34010, Italy			
Manufacturer		Telit Communications S.p.A.			
Manufacturer Address		Via Stazione di Prosecco, 5/B, Sgonico, TS 34010, Italy			
Product Type		2G/3G Module			
Trade Name		Telit			
Model Number		HE910			
FCC ID		R17HE910			
IC		5131A-HE910			
Hardware Version		0			
Software Version		12.00.002			
Mode	GSM/GPRS/ EGPRS	Band	UL Frequency (MHz)	DL Frequency (MHz)	Modulation
		850	824.2 ~ 848.8	869.2 ~ 893.8	GMSK/8PSK
	1900	1850.2 ~ 1909.8	1930.2 ~ 1989.8	GMSK/8PSK	
	WCDMA	Band	UL Frequency (MHz)	DL Frequency (MHz)	Modulation
		II	1852.4 ~ 1907.6	1932.4 ~ 1987.6	QPSK
V	826.4 ~ 846.6	871.4 ~ 891.6	QPSK		
Channel Control		Auto			
Max. RF Output power		GSM/GPRS 850: 33.00 dBm / 1.995 W, EGPRS 850: 29.90 dBm / 0.977 W GSM/GPRS 1900: 29.90 dBm / 0.977 W, EGPRS 1900: 28.60 dBm / 0.724 W WCDMA Band II: 26.39 dBm / 0.436 W WCDMA Band V: 26.63 dBm / 0.460 W			
Max. ERP/EIRP		GSM/GPRS 850: 25.87 dBm / 0.386 W, EGPRS 850: 25.58 dBm / 0.361 W GSM/GPRS 1900: 25.34 dBm / 0.342 W, EGPRS 1900: 23.14 dBm / 0.206 W WCDMA Band II: 21.95 dBm / 0.157 W WCDMA Band V: 17.71 dBm / 0.059 W			
Emission Designator		GSM/GPRS 850: 240KGXW, EGPRS 850: 248KG7W GSM/GPRS 1900: 241KGXW, EGPRS 1900: 252KG7W WCDMA Band II: 4M10F9W WCDMA Band V: 4M08F9W			

1.2. Mode of Operation

ATL has verified the construction and function in typical operation. All the test modes were carried out with the EUT in normal operation, which was shown in this test report and defined as:

Test Mode
Mode 1: GSM 850 Link
Mode 2: GSM 1900 Link
Mode 3: WCDMA Band II Link
Mode 4: WCDMA Band V Link
Mode 5: EGPRS 850 Link
Mode 6: EGPRS 1900 Link
Mode 7: Receive Mode

Note: Regards to the frequency band operation: the lowest, middle and highest frequency of channel were selected to perform the test, then shown on this report.

Tested System Details

The types for all equipments, plus descriptions of all cables used in the tested system (including inserted cards) are:

	Product	Manufacturer	Model Number	Serial Number	Power Cord
1.	Universal Radio Communication Tester	R&S	CMU200	109369	N/A

1.3. EUT Exercise Software

1.	Setup the EUT and Base Station (CMU200) as shown on 1.4.
2.	Turn on the power of all equipment.

1.4. Configuration of Test System Details

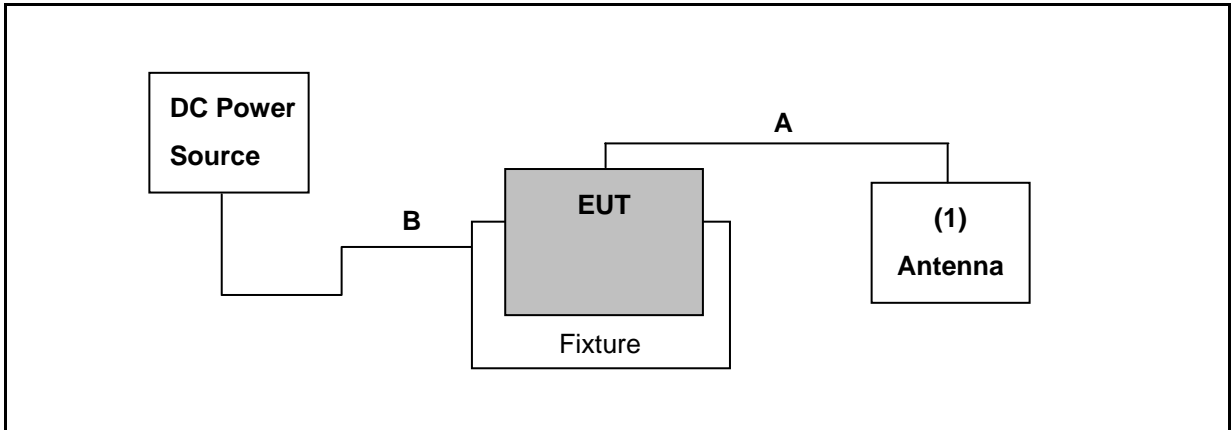

Signal Cable Type		Signal Cable Description
A	Signal Cable	Non-Shielded, 1.8m
B	DC Power Cable	Non-Shielded, 1.3m

Devices Description				
Product	Manufacturer	Model Number	Serial Number	Power Cord
1. Antenna (Max Gain: 2.14 dBi)	Tel Cab	T-AT314	N/A	N/A

1.5. Test Site Environment

Items	Required (IEC 68-1)	Actual
Temperature (°C)	15-35	26
Humidity (%RH)	25-75	60
Barometric pressure (mbar)	860-1060	950

1.6. Summary of Test Result

Description	FCC Rule	IC Rule	Limit	Result
Conducted Output Power	§2.1046	N/A	N/A	Pass
Effective Radiated Power	§22.913(a)(2)	RSS-132(4.4) SRSP-503(5.1.3)	< 7 Watts for FCC (<6.3 Watts for IC)	Pass
Equivalent Isotropic Radiated Power	§24.232(c)	RSS-133 (6.4) SRSP-510(5.1.2)	< 2 Watts	Pass
Occupied Bandwidth	§2.1049 §22.917(a) §24.238(a)	RSS-Gen (4.6.1)	N/A	Pass
Band Edge Measurement	§2.1051 §22.917(a) §24.238(a)	RSS-132 (4.5.1)RSS-133 (6.5.1)	< 43+10log ₁₀ (P[Watts])	Pass
Conducted Emission	§2.1051 §22.917(a) §24.238(a)	RSS-132 (4.5.1) RSS-133 (6.5.1)	< 43+10log ₁₀ (P[Watts])	Pass
Field Strength of Spurious Radiation	§2.1053 §22.917(a) §24.238(a)	RSS-132 (4.5.1) RSS-133 (6.5.1) RSS-Gen (4.10)	< 43+10log ₁₀ (P[Watts])	Pass
Frequency Stability for Temperature & Voltage	§2.1055 §22.355 §24.235	RSS-132(4.3) RSS-133(6.3)	< 2.5 ppm	Pass

2 RF Output Power Test

2.1. Limit

N/A

2.2. Test Instruments

Describe	Manufacturer	Model No.	Serial No.	Cal. Date	Remark
Universal Radio Communication Tester	ROHDE & SCHWARZ	CMU200	109369	08/10/2010	(2)
Single Channel PK Power Sensor	Agilent	N1911A	MY45101619	07/19/2010	(2)
Wideband Power Meter	Agilent	N1921A	MY45241957	07/19/2010	(2)
Test Site	ATL	TE02	TE02	N.C.R.	-----

Remark: ⁽¹⁾ Calibration period 1 year. ⁽²⁾ Calibration period 2 years.

NOTE: N.C.R. = No Calibration Request.

2.3. Test Setup

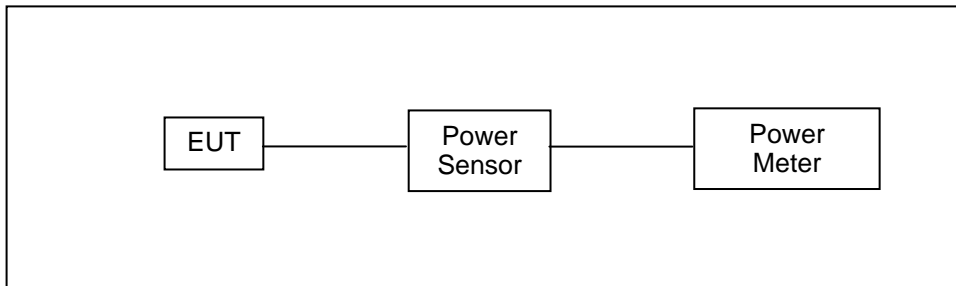

2.4. Test Procedure

The measurement is made according to ANSI/TIA-603-C-2004 as follows:

1. The transmitter output was connected to power meter and base station through power divider.
2. Set base station for EUT at GSM 850: PCL=5 and PCS 1900: PCL=0.
3. Set base station for EUT at WCDMA Band V and WCDMA Band II, power level was set to maximum.
4. Select lowest, middle, and highest channels for each band.

2.5. Uncertainty

The measurement uncertainty is defined as for RF output power measurement is 1.2 dB.

2.6. Test Result

Model Number	HE910					
Test Item	RF Output Power					
Date of Test	12/01/2011			Test Site	TE02	
Bands	Data Rate	Frequency (MHz)	Burst Average Power		Peak Power	
			(dBm)	(W)	(dBm)	(W)
GSM 850	-----	824.2	32.50	1.778	32.70	1.862
		836.4	32.40	1.738	32.60	1.820
		848.8	32.40	1.738	32.60	1.820
GRRS 850	4Down1Up	824.2	32.80	1.905	33.00	1.995
		836.4	32.70	1.862	32.90	1.950
		848.8	32.70	1.862	32.90	1.950
	3Down2Up	824.2	32.20	1.660	32.40	1.738
		836.4	32.20	1.660	32.40	1.738
		848.8	32.30	1.698	32.40	1.738
	2Down3Up	824.2	31.70	1.479	31.90	1.549
		836.4	31.70	1.479	31.80	1.514
		848.8	31.70	1.479	31.90	1.549
	1Down4Up	824.2	30.60	1.148	30.80	1.202
		836.4	30.60	1.148	30.70	1.175
		848.8	30.60	1.148	30.80	1.202
EGPRS 850	4Down1Up	824.2	27.40	0.550	29.90	0.977
		836.4	27.20	0.525	29.80	0.955
		848.8	27.20	0.525	29.80	0.955
	3Down2Up	824.2	26.90	0.490	29.50	0.891
		836.4	26.90	0.490	29.70	0.933
		848.8	26.90	0.490	29.70	0.933
	2Down3Up	824.2	26.00	0.398	28.90	0.776
		836.4	26.10	0.407	28.90	0.776
		848.8	26.20	0.417	29.00	0.794
	1Down4Up	824.2	25.40	0.347	28.40	0.692
		836.4	25.40	0.347	28.40	0.692
		848.8	25.50	0.355	28.50	0.708

Note: The peak power testing result was used peak detector.

Model Number	HE910					
Test Item	RF Output Power					
Date of Test	12/01/2011			Test Site	TE02	
Bands	Data Rate	Frequency (MHz)	Burst Average Power		Peak Power	
			(dBm)	(W)	(dBm)	(W)
GSM 1900	-----	1850.20	29.50	0.891	29.70	0.933
		1880.00	29.40	0.871	29.60	0.912
		1909.80	29.20	0.832	29.30	0.851
GRRS 1900	4Down1Up	1850.20	29.70	0.933	29.90	0.977
		1880.00	29.60	0.912	29.80	0.955
		1909.80	29.30	0.851	29.50	0.891
	3Down2Up	1850.20	29.20	0.832	29.40	0.871
		1880.00	29.20	0.832	29.40	0.871
		1909.80	29.00	0.794	29.20	0.832
	2Down3Up	1850.20	28.80	0.759	29.00	0.794
		1880.00	28.60	0.724	28.80	0.759
		1909.80	28.40	0.692	28.60	0.724
	1Down4Up	1850.20	27.70	0.589	27.80	0.603
		1880.00	27.40	0.550	27.50	0.562
		1909.80	27.20	0.525	27.30	0.537
EGPRS 1900	4Down1Up	1850.20	25.80	0.380	28.60	0.724
		1880.00	25.60	0.363	28.40	0.692
		1909.80	25.40	0.347	28.30	0.676
	3Down2Up	1850.20	25.60	0.363	28.40	0.692
		1880.00	25.40	0.347	28.10	0.646
		1909.80	25.20	0.331	28.10	0.646
	2Down3Up	1850.20	25.00	0.316	27.50	0.562
		1880.00	24.70	0.295	27.40	0.550
		1909.80	24.50	0.282	27.20	0.525
	1Down4Up	1850.20	24.40	0.275	27.20	0.525
		1880.00	24.30	0.269	27.00	0.501
		1909.80	24.10	0.257	27.00	0.501

Model Number	HE910					
Test Item	RF Output Power					
Date of Test	12/01/2011			Test Site	TE02	
Bands	Sub-Test	Frequency (MHz)	Burst Average Power		Peak Power	
			(dBm)	(W)	(dBm)	(W)
WCDMA Band II	-----	1852.4	23.85	0.243	26.39	0.436
		1880.0	23.57	0.228	25.93	0.392
		1907.6	23.49	0.223	25.59	0.362
WCDMA Band V	-----	826.4	23.82	0.241	26.63	0.460
		836.4	23.70	0.234	26.43	0.440
		846.4	23.61	0.230	26.47	0.444

Note: The peak power testing result was used peak detector.

3 Effective Radiated Power / Equivalent Isotropic Radiated Power Test

3.1. Limit

For FCC Part 22.913(a)(2): The ERP of mobile transmitters and auxiliary test transmitters must not exceed 7 Watts.

For FCC Part 24.232(b): The EIRP of mobile transmitters and auxiliary test transmitters must not exceed 2 Watts.

3.2. Test Instruments

3 Meter Chamber					
Equipment	Manufacturer	Model Number	Serial Number	Cal. Date	Remark
RF Pre-selector	Agilent	N9039A	MY46520256	01/18/2011	(2)
Spectrum Analyzer	Agilent	E4446A	MY46180578	01/18/2011	(1)
Pre Amplifier	Agilent	8449B	3008A02237	02/23/2011	(1)
Pre Amplifier	Agilent	8447D	2944A10961	02/23/2011	(1)
Broadband Antenna (30MHz~1GHz)	SCHWARZBECK MESS-ELEKTRONIK	VULB9163	9163-270	07/29/2011	(1)
Horn Antenna (1~18GHz)	SCHWARZBECK MESS-ELEKTRONIK	BBHA9120D	9120D-550	06/29/2011	(1)
Horn Antenna (18~40GHz)	SCHWARZBECK MESS-ELEKTRONIK	BBHA9170	9170-320	06/28/2011	(1)
Test Site	ATL	TE01	888001	12/24/2010	(1)

Remark: ⁽¹⁾ Calibration period 1 year. ⁽²⁾ Calibration period 2 years.

NOTE: N.C.R. = No Calibration Request.

3.3. Setup

Below 1 GHz

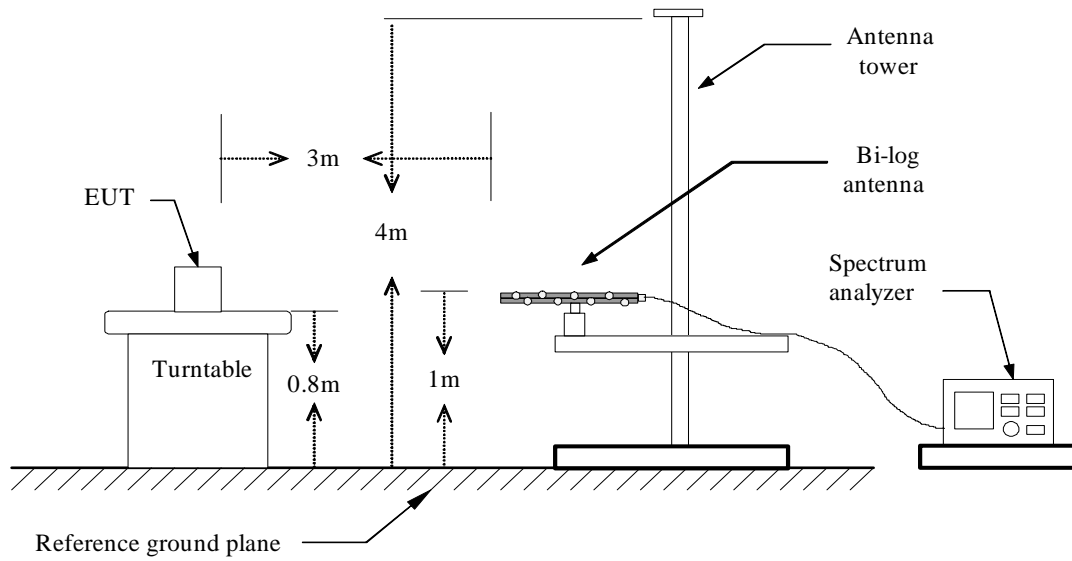

Above 1 GHz

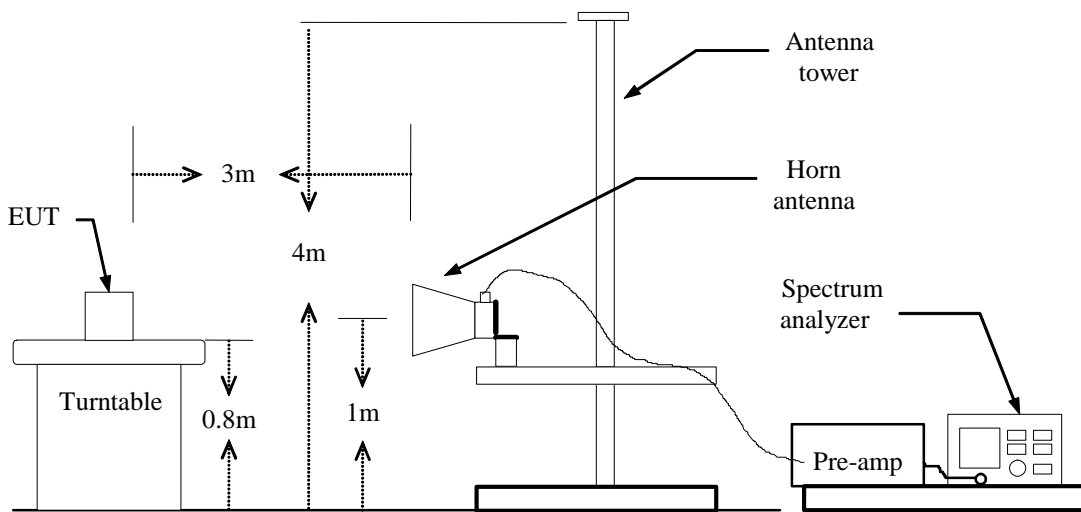

For Substituted Method Test Set-UP

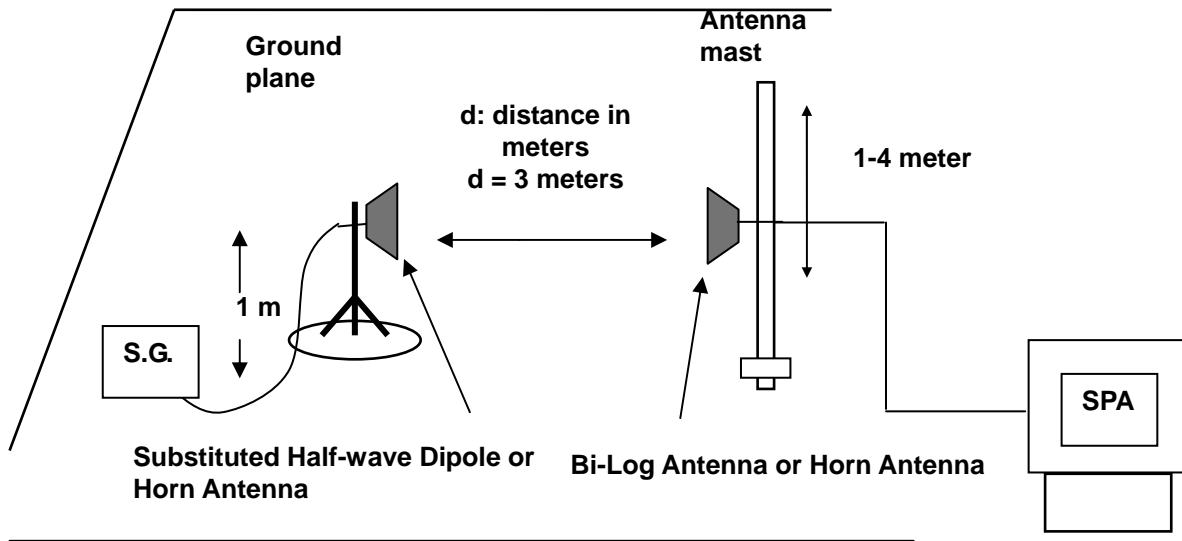

3.4. Test Procedure

The measurement is made according to ANSI/TIA-603-C-2004 as follows:

The EUT was placed on a non-conductive turntable using a non-conductive support. The radiated emission at the fundamental frequency was measured at 3 m with a test antenna and EMI spectrum analyzer.

During the measurement of the EUT, the resolution bandwidth was set to 3MHz and the average bandwidth was set to 3MHz. The highest emission was recorded with the rotation of the turntable and the lowering of the test antenna. The reading was recorded and the field strength (E in dBuV/m) was calculated.

ERP in frequency band 824-849MHz, and EIRP in frequency band 1851.25 –1910MHz were measured using a substitution method. The EUT was replaced by half-wave dipole (824-849MHz) or horn antenna (1851.25-1910MHz) connected to a signal generator. The spectrum analyzer reading was recorded and ERP/EIRP was calculated as follows:

$$\text{ERP} = \text{S.G. output (dBm)} + \text{Antenna Gain (dBd)} - \text{Cable (dB)}$$

$$\text{EIRP} = \text{S.G. output (dBm)} + \text{Antenna Gain (dBi)} - \text{Cable (dB)}$$

3.5. Uncertainty

The measurement uncertainty is defined as for Field Strength of Spurious Radiation measurement is ± 3.072 dB.

3.6. Test Result

Model Number	HE910						
Test Item	ERP/EIRP						
Test Mode	Mode 1: GSM 850 Link						
Date of Test	12/06/2011				Test Site	TE01	
Bands	Frequency (MHz)	Ant. Polar.	Read Level (dBm)	Correction factor (dBm)	ERP		Limit
					(dBm)	(W)	
GSM 850	824.2	H	13.91	11.96	25.87	0.386	< 7W
		V	9.30	11.29	20.59	0.115	< 7W
	836.4	H	13.27	12.07	25.34	0.342	< 7W
		V	9.67	11.34	21.01	0.126	< 7W
	848.8	H	11.85	12.50	24.35	0.272	< 7W
		V	9.65	11.47	21.12	0.129	< 7W
EGPRS 850	824.2	H	13.63	11.95	25.58	0.361	< 7W
		V	9.26	11.29	20.55	0.114	< 7W
	836.4	H	13.07	12.07	25.14	0.327	< 7W
		V	9.60	11.34	20.94	0.124	< 7W
	848.8	H	11.65	12.51	24.16	0.261	< 7W
		V	9.50	11.47	20.97	0.125	< 7W

Model Number	HE910						
Test Item	ERP/EIRP						
Test Mode	Mode 2: GSM 1900 Link						
Date of Test	12/06/2011				Test Site	TE01	
Bands	Frequency (MHz)	Ant. Polar.	Read Level (dBm)	Correction factor (dBm)	EIRP		Limit
					(dBm)	(W)	
GSM 1900	1850.20	H	11.54	10.49	22.03	0.160	< 2W
		V	16.14	8.33	24.47	0.280	< 2W
	1880.00	H	10.33	10.51	20.84	0.121	< 2W
		V	16.36	8.57	24.93	0.311	< 2W
	1909.80	H	9.39	10.51	19.90	0.098	< 2W
		V	16.53	8.81	25.34	0.342	< 2W
EGPRS 1900	1850.20	H	8.18	10.49	18.67	0.074	< 2W
		V	13.56	8.33	21.89	0.155	< 2W
	1880.00	H	6.90	10.51	17.41	0.055	< 2W
		V	13.88	8.57	22.45	0.176	< 2W
	1909.80	H	5.89	10.52	16.41	0.044	< 2W
		V	14.33	8.81	23.14	0.206	< 2W

Note: 1. ERP/EIRP = Read Level + Correction factor.

2. For WCDMA signals, a peak detector is used with RBW = VBW = 5MHz.

3. For AMPS, GSM, and NADC TDMA signals, a peak detector is used, with RBW = VBW= 1 MHz.

Model Number	HE910						
Test Item	ERP/EIRP						
Test Mode	Mode 3: WCDMA Band II Link						
Date of Test	12/06/2011				Test Site	TE01	
Bands	Frequency (MHz)	Ant. Polar.	Read Level (dBm)	Correction factor (dBm)	EIRP		Limit
					(dBm)	(W)	
WCDMA Band II	1852.4	H	6.91	10.50	17.41	0.055	< 2W
		V	13.59	8.36	21.95	0.157	< 2W
	1880.0	H	5.42	10.51	15.93	0.039	< 2W
		V	12.59	8.57	21.16	0.131	< 2W
	1907.6	H	4.60	10.52	15.12	0.033	< 2W
		V	12.87	8.80	21.67	0.147	< 2W

Model Number	HE910						
Test Item	ERP/EIRP						
Test Mode	Mode 4: WCDMA Band V Link						
Date of Test	12/06/2011				Test Site	TE01	
Bands	Frequency (MHz)	Ant. Polar.	Read Level (dBm)	Correction factor (dBm)	ERP		Limit
					(dBm)	(W)	
WCDMA Band V	826.4	H	5.74	11.97	17.71	0.059	< 7W
		V	1.26	11.30	12.56	0.018	< 7W
	836.4	H	5.42	12.07	17.49	0.056	< 7W
		V	1.94	11.34	13.28	0.021	< 7W
	846.4	H	4.58	12.36	16.94	0.049	< 7W
		V	1.98	11.42	13.40	0.022	< 7W

Note: 1. ERP/EIRP = Read Level + Correction factor.

2. For WCDMA signals, a peak detector is used with RBW = VBW = 5MHz.

3. For AMPS, GSM, and NADC TDMA signals, a peak detector is used, with RBW = VBW= 1 MHz.

4 Occupied Bandwidth Test

4.1. Limit

The Occupied Bandwidth Limit:

N/A.

The Band Edge Limit:

The power of any emission outside of the authorized operating frequency ranges must be attenuated below the transmitting power (P) by a factor of at least $43 + 10\log(P)$ dB.

4.2. Test Instruments

Describe	Manufacturer	Model No.	Serial No.	Cal. Date	Remark
Spectrum Analyzer	Agilent	E4445A	MY46181986	05/16/2011	(2)
Universal Radio Communication Tester	ROHDE & SCHWARZ	CMU200	109369	08/10/2010	(2)
Attenuator	RADIALL	R41572000	0603033073	N.C.R.	-----
Power divider	Agilent	87302C	3239A00760	N.C.R.	-----
Test Site	ATL	TE02	TE02	N.C.R.	-----

Remark: ⁽¹⁾ Calibration period 1 year. ⁽²⁾ Calibration period 2 years.

NOTE: N.C.R. = No Calibration Request.

4.3. Setup

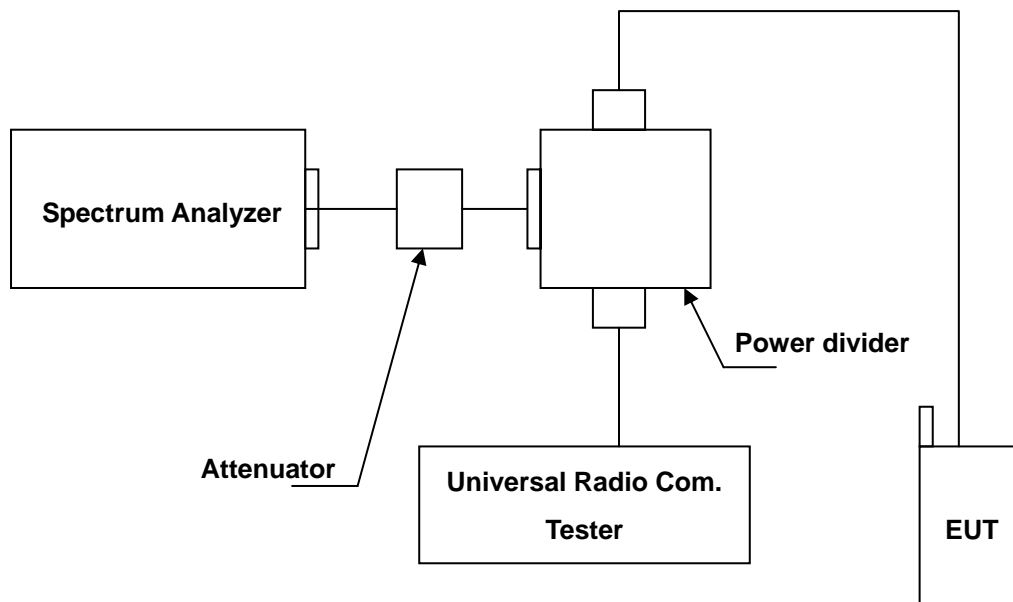

4.4. Test Procedure

The measurement is made according to FCC rules part 22 and 24:

1. The EUT was connected to Spectrum Analyzer and Base Station via power divider.
2. The occupied bandwidth of middle channel for the highest and lowest RF powers was measured.
3. The band edge of low and high channels for the highest RF powers within the transmitting frequency band were measured. Setting RBW as roughly BW/100.
4. The band edge setting:
 - a. RB=10 kHz; VB=30 kHz for GSM 850 and PCS 1900.
 - b. RB=100 kHz; VB=300 kHz for WCDMA Band V and WCDMA Band II.

4.5. Uncertainty

The measurement uncertainty is defined as $\pm 10\text{Hz}$

4.6. Test Result
99% Occupied Bandwidth

Model Number	HE910		
Test Item	Occupied Bandwidth		
Test Mode	Mode 1: GSM 850 Link		
Date of Test	12/02/2011	Test Site	TE02
Channel No.	Frequency (MHz)	99% Bandwidth (kHz)	Note
128	824.2	238.7280	RBW:10KHz , VBW:30KHz
190	836.4	237.7705	RBW:10KHz , VBW:30KHz
251	848.8	240.1195	RBW:10KHz , VBW:30KHz

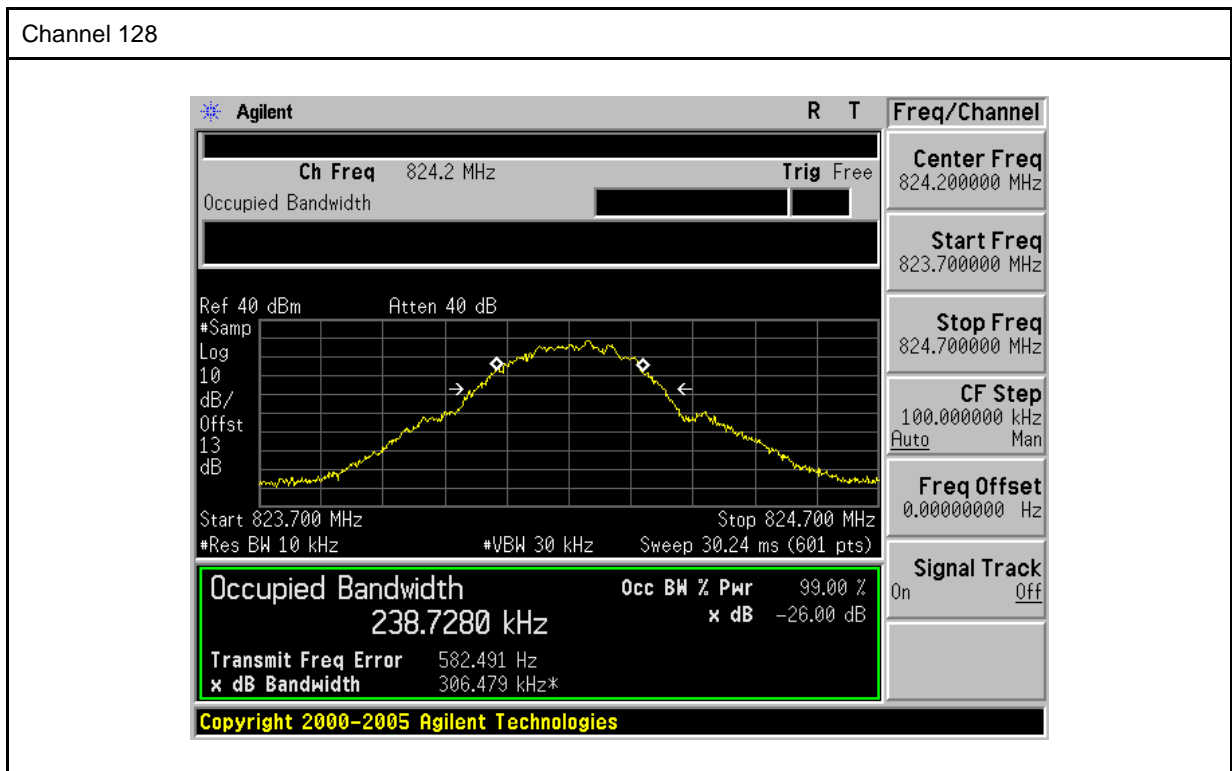

Channel 190

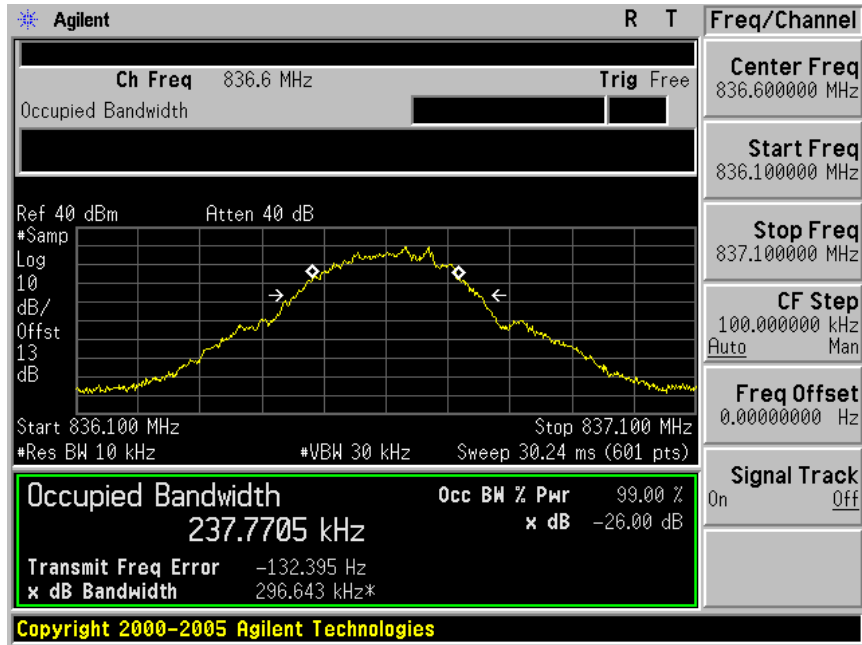

Channel 251

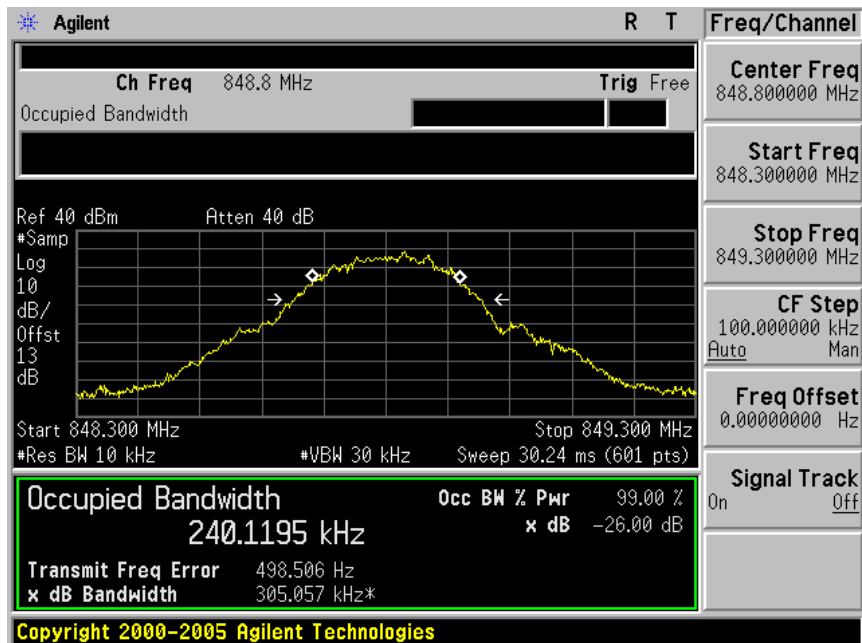

Model Number	HE910		
Test Item	Occupied Bandwidth		
Test Mode	Mode 2: GSM 1900 Link		
Date of Test	12/02/2011	Test Site	TE02
Channel No.	Frequency (MHz)	99% Bandwidth (kHz)	Note
512	1850.20	241.0364	RBW:10KHz , VBW:30KHz
661	1880.00	240.2580	RBW:10KHz , VBW:30KHz
810	1909.80	240.3112	RBW:10KHz , VBW:30KHz

Channel 512

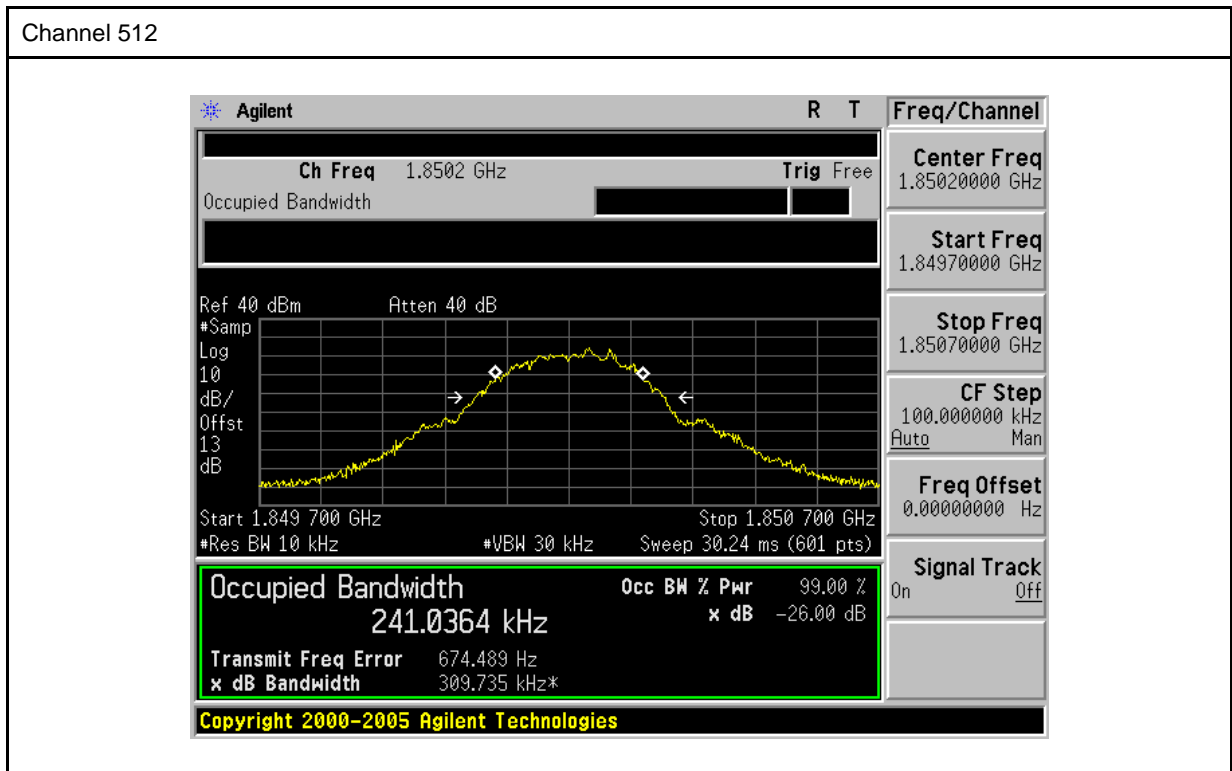

Channel 661

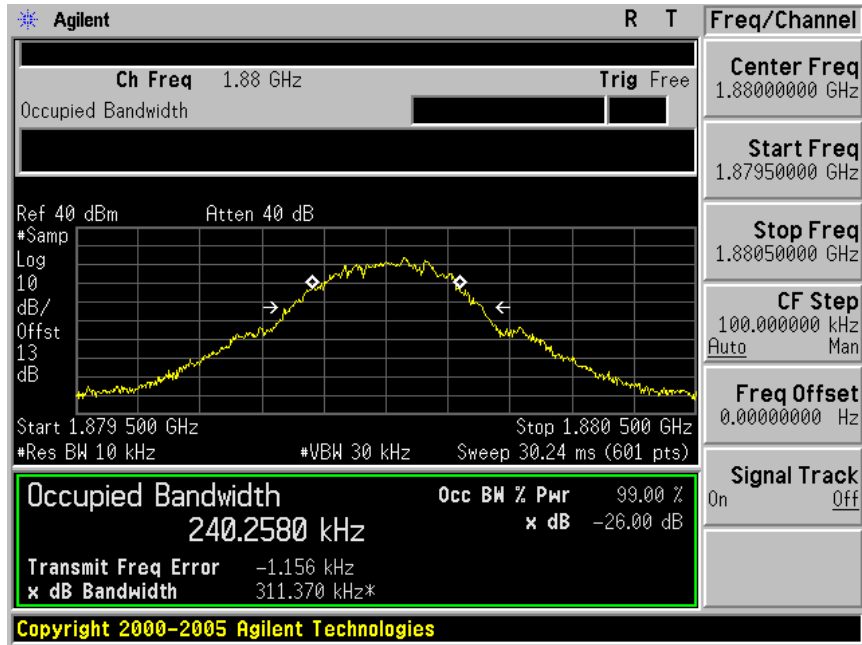

Channel 810

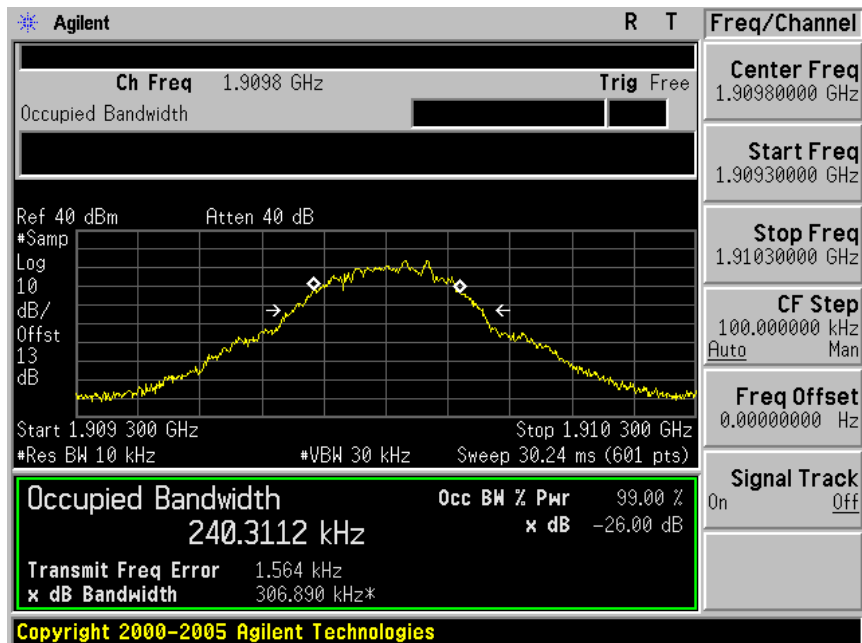

Model Number	HE910		
Test Item	Occupied Bandwidth		
Test Mode	Mode 3: WCDMA Band II Link		
Date of Test	12/02/2011	Test Site	TE02
Channel No.	Frequency (MHz)	99% Bandwidth (MHz)	Note
9262	1852.4	4.0647	RBW:100KHz , VBW:300KHz
9400	1880.0	4.0834	RBW:100KHz , VBW:300KHz
9538	1907.6	4.0964	RBW:100KHz , VBW:300KHz

Channel 9262

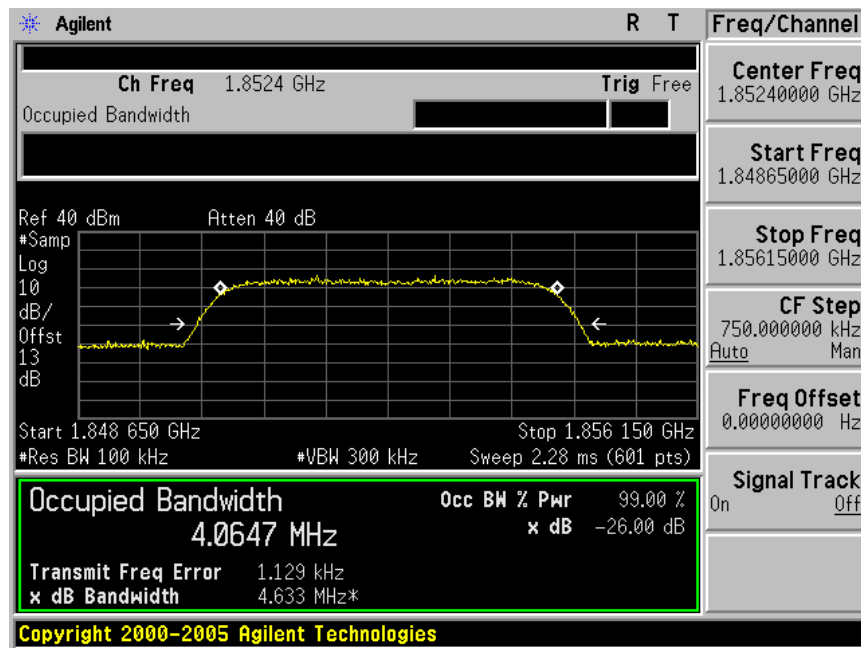

Channel 9400

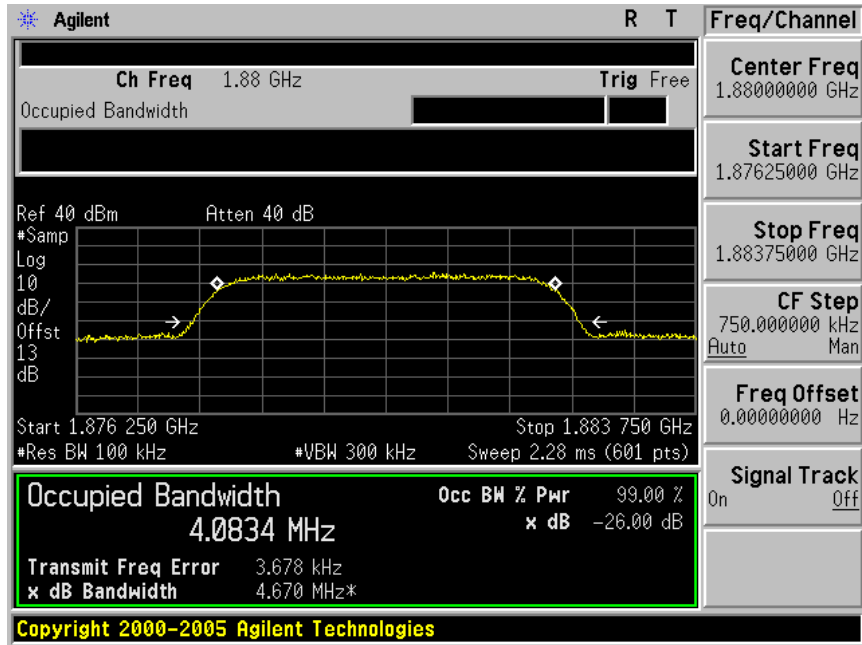

Channel 9538

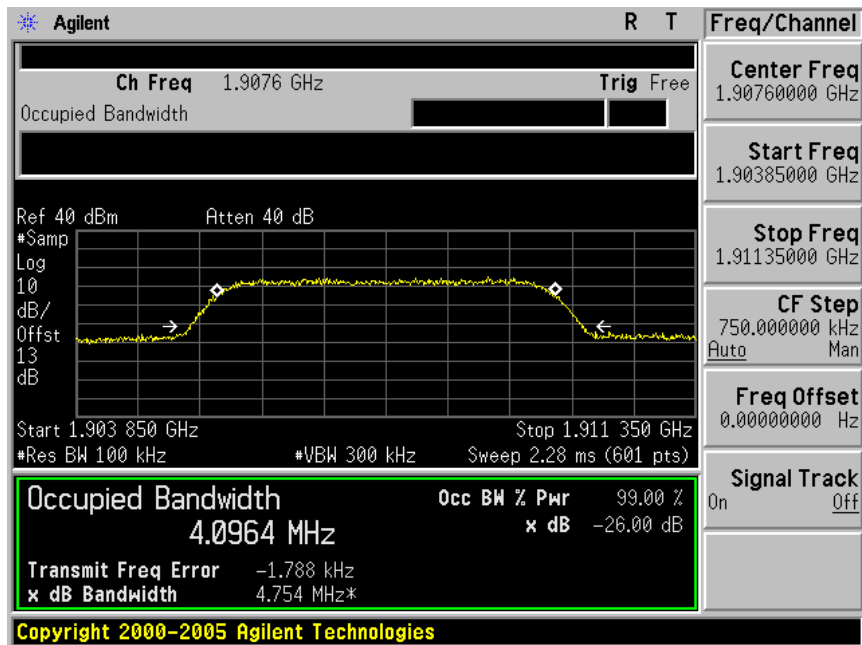

Model Number	HE910		
Test Item	Occupied Bandwidth		
Test Mode	Mode 4: WCDMA Band V Link		
Date of Test	12/02/2011	Test Site	TE02
Channel No.	Frequency (MHz)	99% Bandwidth (kHz)	Note
4132	826.4	4.0714	RBW:100KHz , VBW:300KHz
4182	836.4	4.0752	RBW:100KHz , VBW:300KHz
4233	846.4	4.0651	RBW:100KHz , VBW:300KHz

Channel 4132

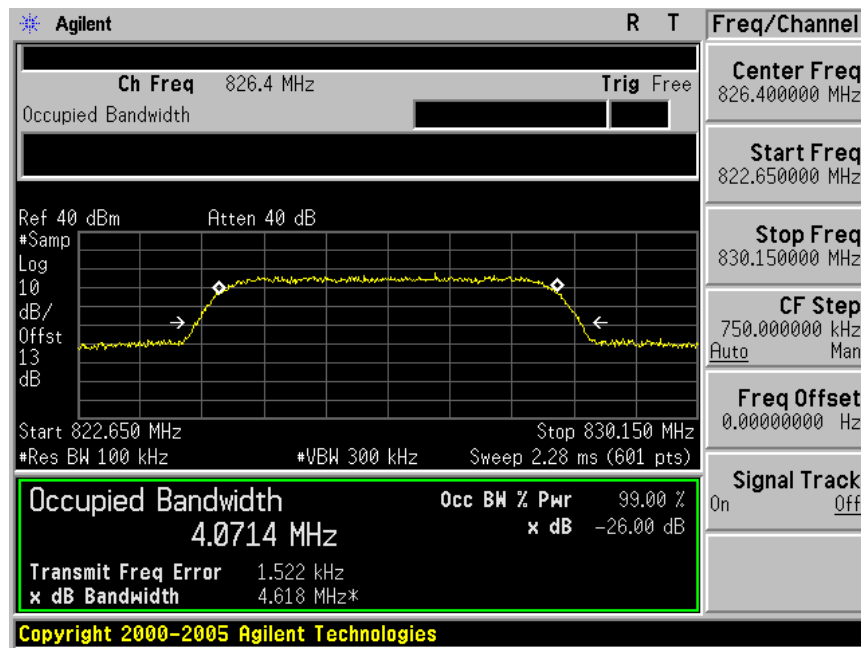

Channel 4182

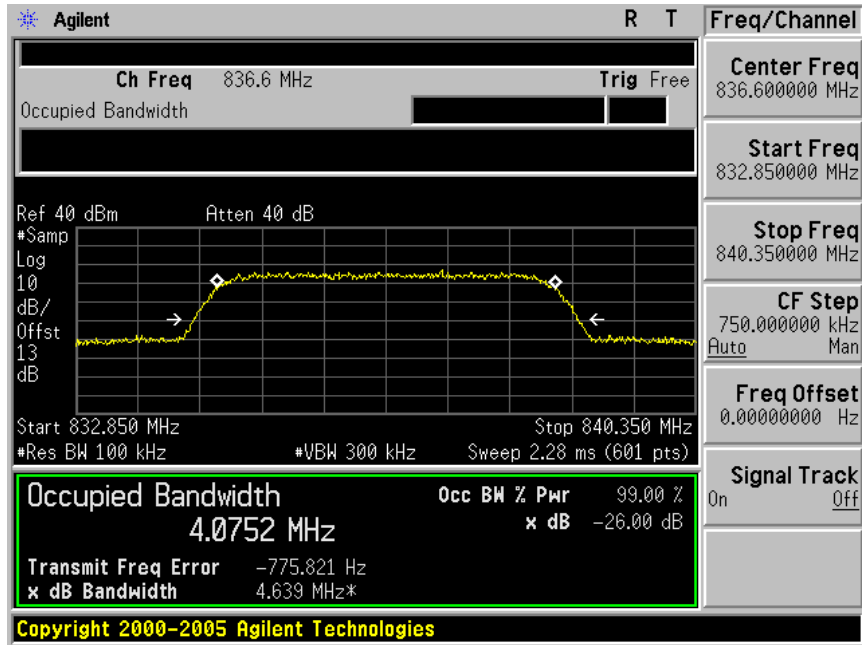

Channel 4233

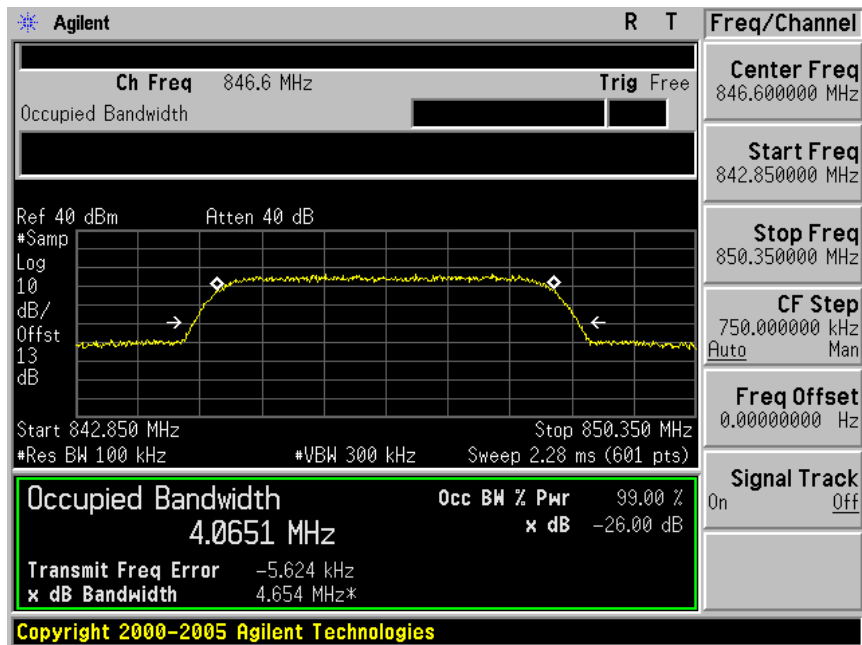

Model Number	HE910		
Test Item	Occupied Bandwidth		
Test Mode	Mode 5: EGPRS 850 Link		
Date of Test	12/02/2011	Test Site	TE02
Channel No.	Frequency (MHz)	99% Bandwidth (kHz)	Note
128	824.2	248.3860	RBW:10KHz , VBW:30KHz
190	836.4	243.3037	RBW:10KHz , VBW:30KHz
251	848.8	242.7454	RBW:10KHz , VBW:30KHz

Channel 128

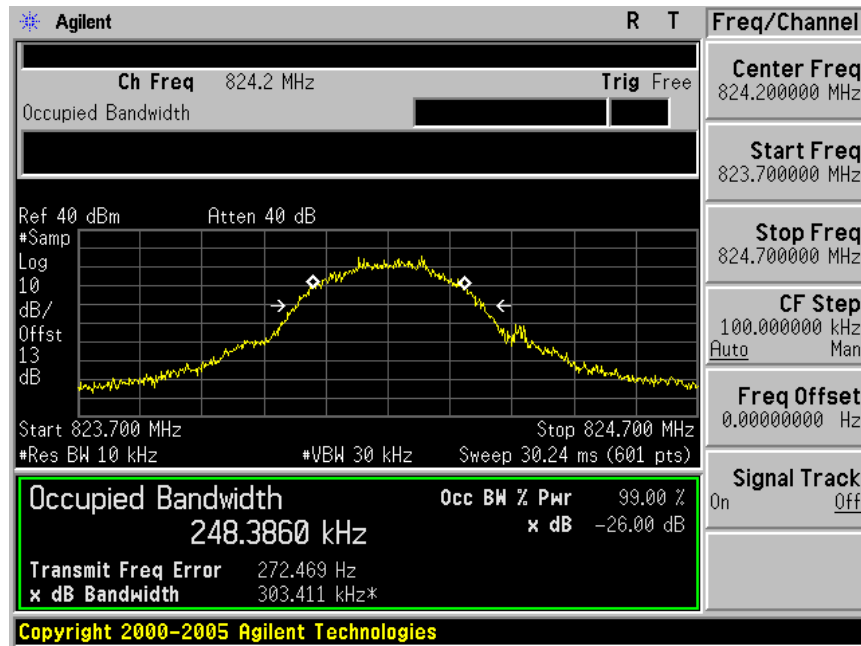

Channel 190

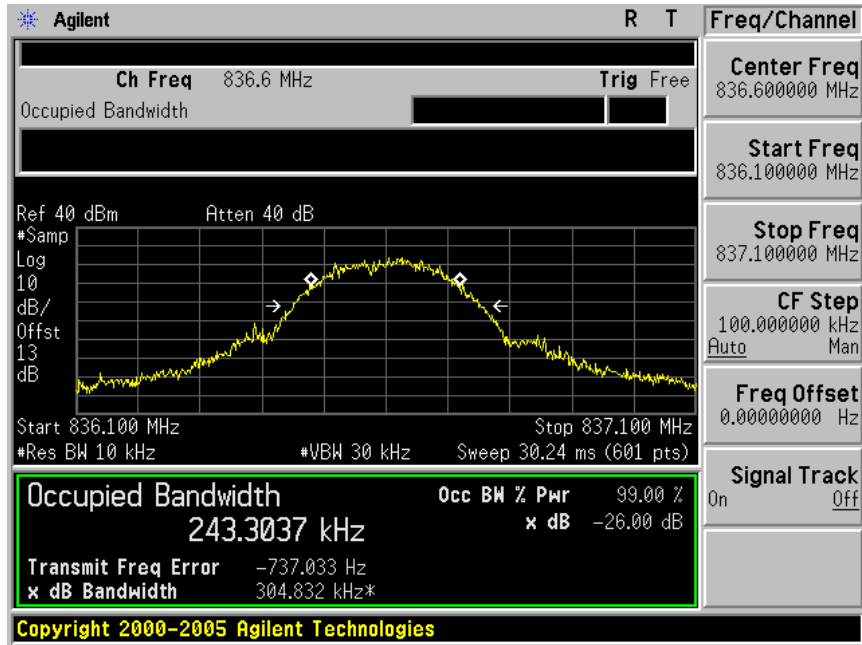

Channel 251



Model Number	HE910		
Test Item	Occupied Bandwidth		
Test Mode	Mode 6: EGPRS 1900 Link		
Date of Test	12/02/2011	Test Site	TE02
Channel No.	Frequency (MHz)	99% Bandwidth (kHz)	Note
512	1850.20	249.2778	RBW:10KHz , VBW:30KHz
661	1880.00	248.9375	RBW:10KHz , VBW:30KHz
810	1909.80	252.0391	RBW:10KHz , VBW:30KHz

Channel 512

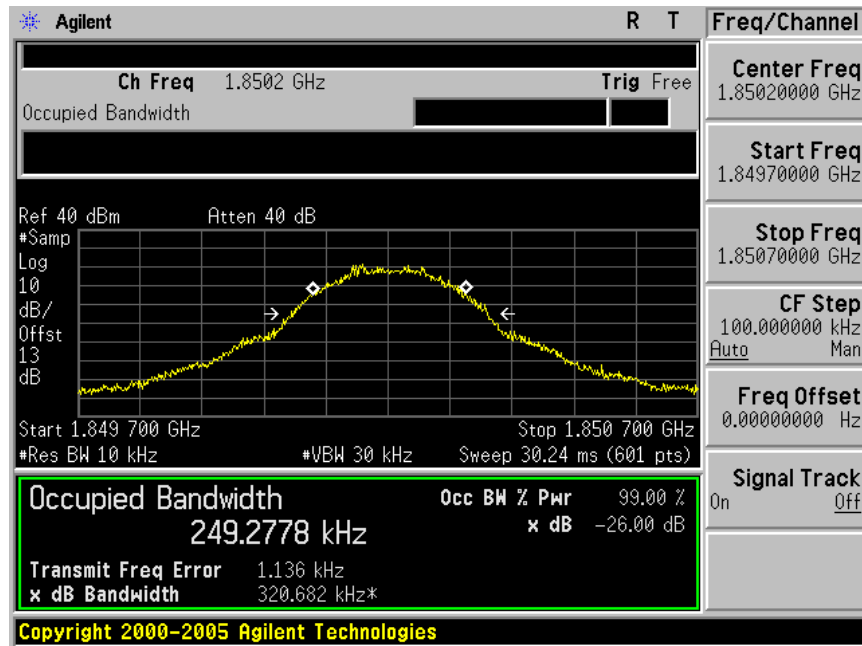

Channel 661



Channel 810

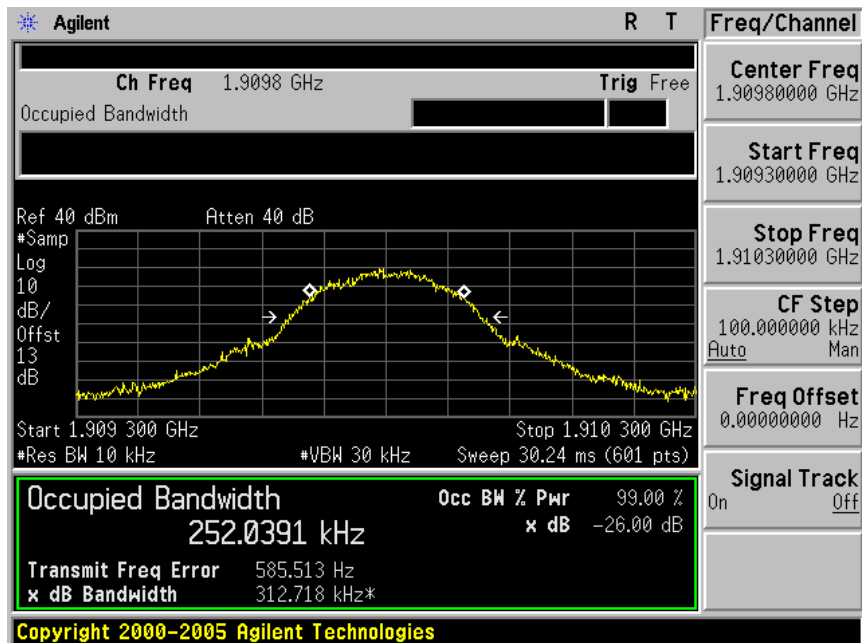

Band Edge

Model Number	HE910				
Test Item	Band Edge				
Test Mode	Mode 1: GSM 850 Link				
Date of Test	12/02/2011		Test Site	TE02	
Band	Channel	Frequency (MHz)	Bandwidth (dBm)	Limit (dBm)	Result
Lower	128	824.0000	-15.20	-13	Pass
Higher	251	849.0000	-21.77	-13	Pass

Lower Band

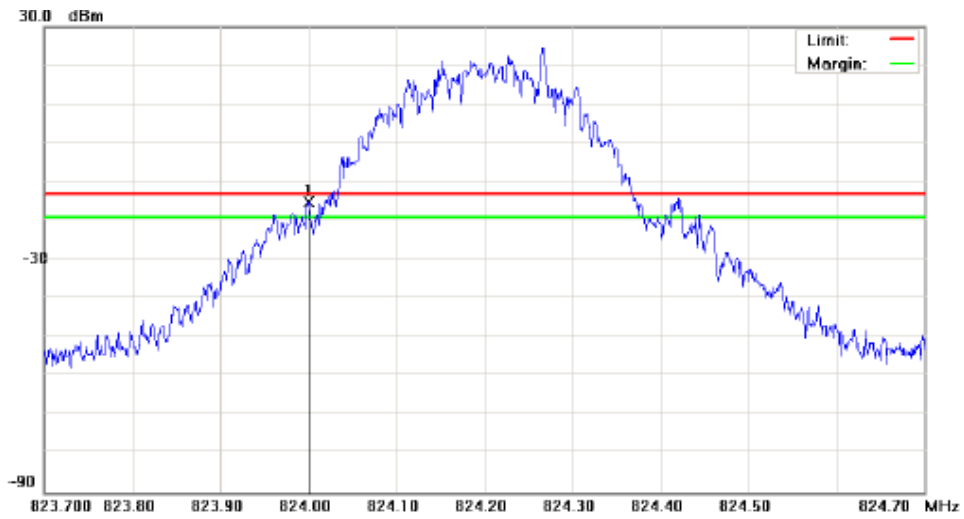

Higher Band

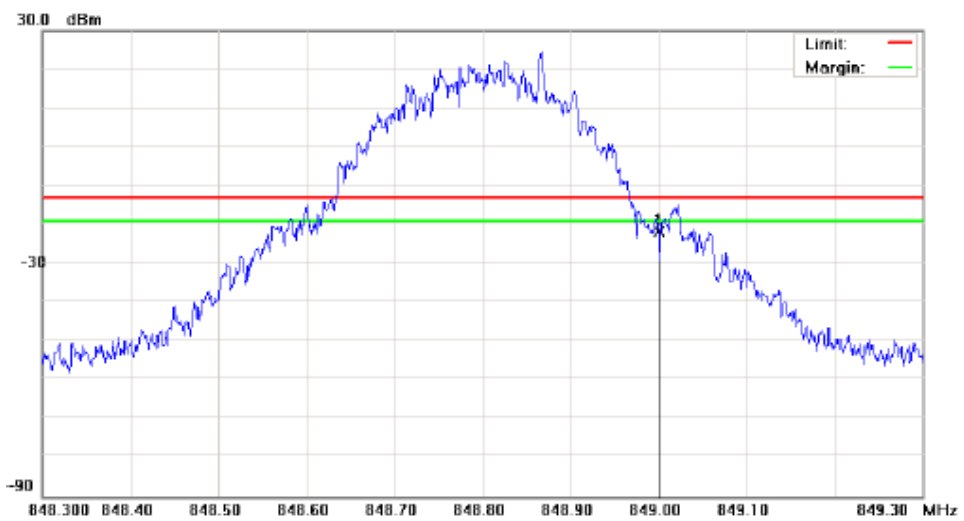

Model Number	HE910				
Test Item	Band Edge				
Test Mode	Mode 2: GSM 1900 Link				
Date of Test	12/02/2011		Test Site	TE02	
Band	Channel	Frequency (MHz)	Bandwidth (dBm)	Limit (dBm)	Result
Lower	512	1850.000	-27.83	-13	Pass
Higher	810	1910.000	-34.04	-13	Pass

Lower Band



Higher Band

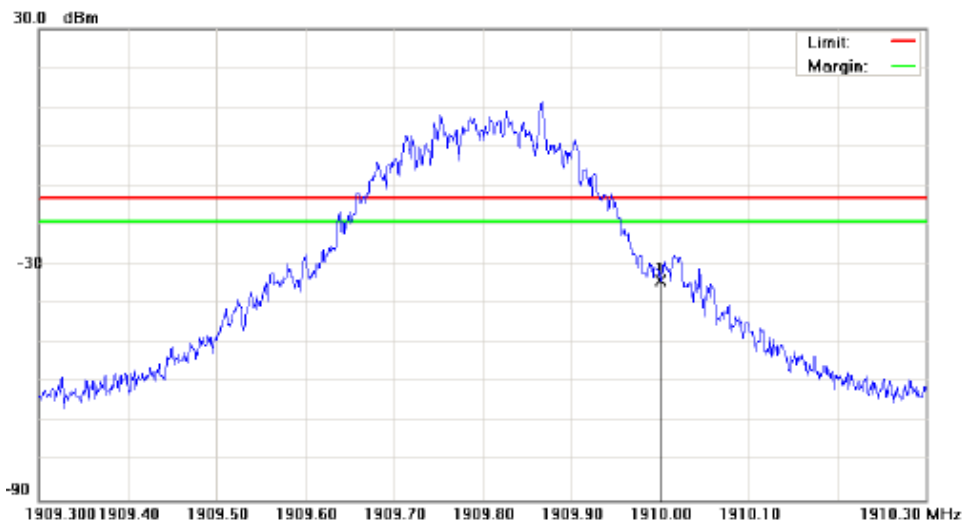

Model Number	HE910				
Test Item	Band Edge				
Test Mode	Mode 3: WCDMA Band II Link				
Date of Test	12/02/2011		Test Site	TE02	
Band	Channel	Frequency (MHz)	Bandwidth (dBm)	Limit (dBm)	Result
Lower	9262	1850.000	-26.53	-13	Pass
Higher	9538	1910.000	-22.12	-13	Pass

Lower Band

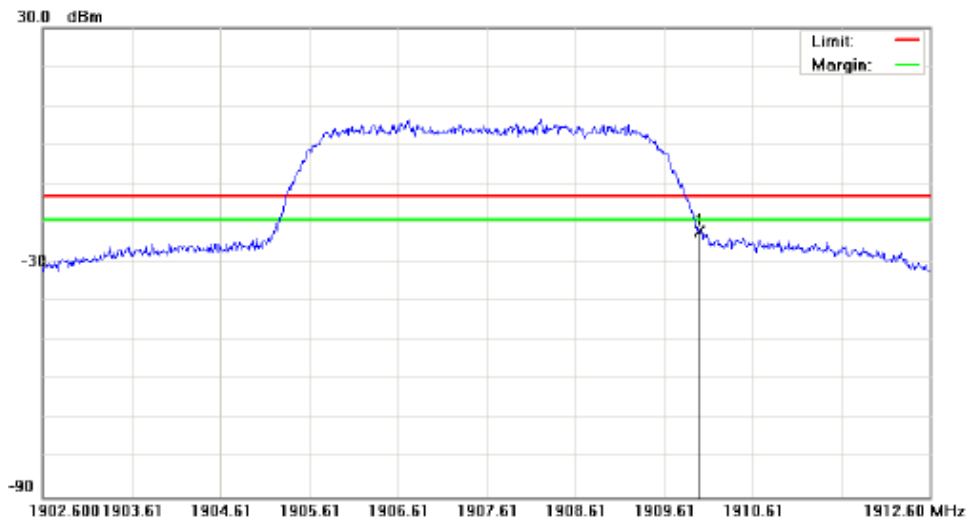

Higher Band

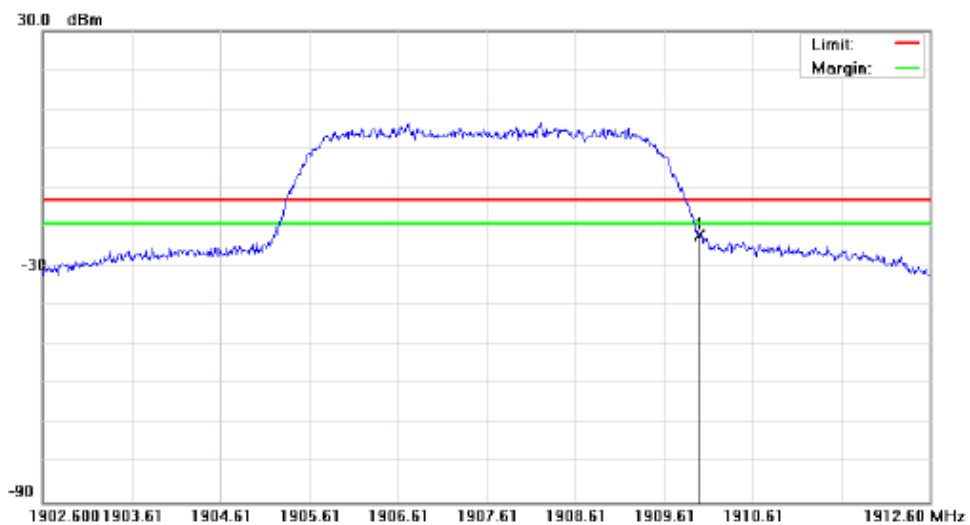

Model Number	HE910				
Test Item	Band Edge				
Test Mode	Mode 4: WCDMA Band V Link				
Date of Test	12/02/2011		Test Site	TE02	
Band	Channel	Frequency (MHz)	Bandwidth (dBm)	Limit (dBm)	Result
Lower	4132	824.0000	-17.75	-13	Pass
Higher	4233	849.0000	-18.52	-13	Pass

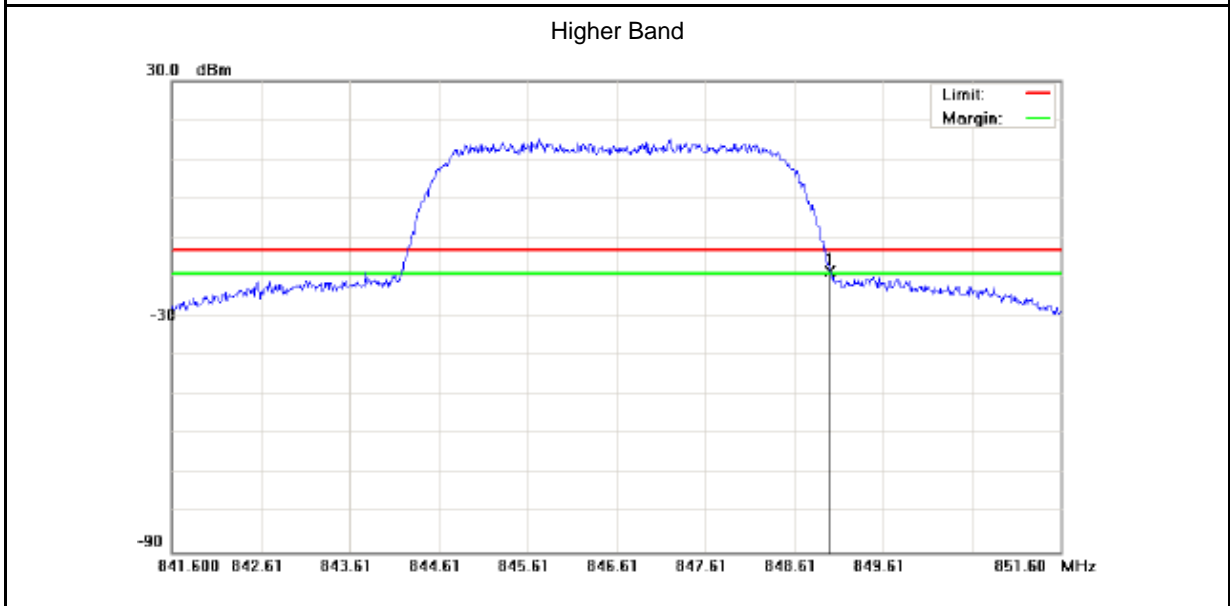
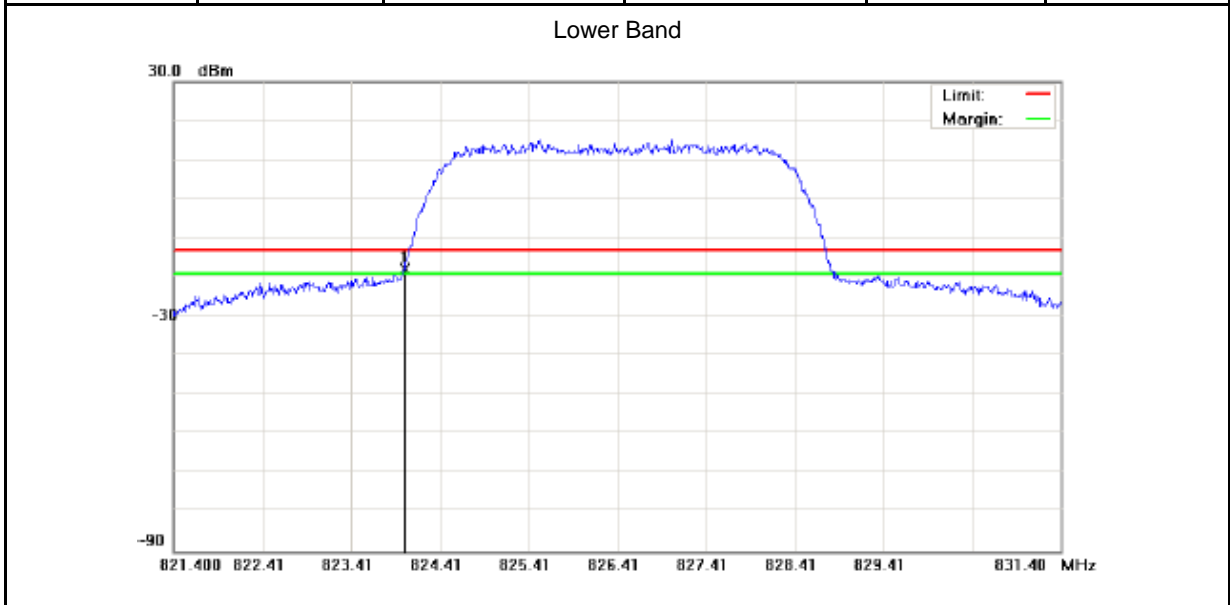

5 Conducted Emission Test

5.1. Limit

The power of any emission outside of the authorized operating frequency ranges must be attenuated below the transmitting power (P) by a factor of at least $43 + 10\log(P)$ dB.

5.2. Test Instruments

Describe	Manufacturer	Model No.	Serial No.	Cal. Date	Remark
Spectrum Analyzer	Agilent	E4445A	MY46181986	05/16/2011	(2)
Universal Radio Communication Tester	ROHDE & SCHWARZ	CMU200	109369	08/10/2010	(2)
Attenuator	RADIALL	R41572000	0603033073	N.C.R.	-----
Power divider	Agilent	87302C	3239A00760	N.C.R.	-----
Test Site	ATL	TE02	TE02	N.C.R.	-----

Remark: ⁽¹⁾ Calibration period 1 year. ⁽²⁾ Calibration period 2 years.

NOTE: N.C.R. = No Calibration Request.

5.3. Setup

Below 2.8GHz

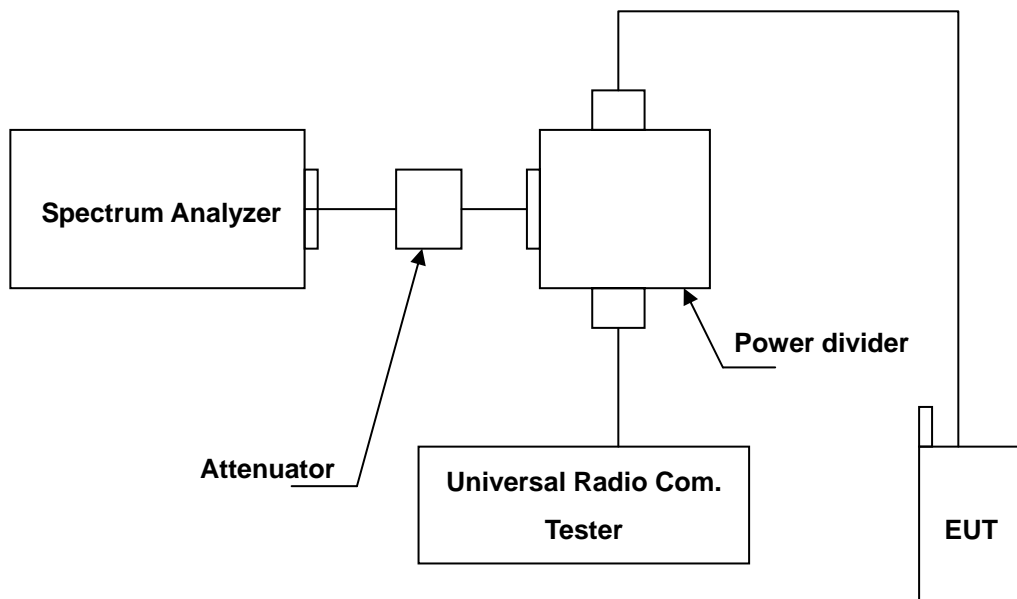

Above 2.8GHz

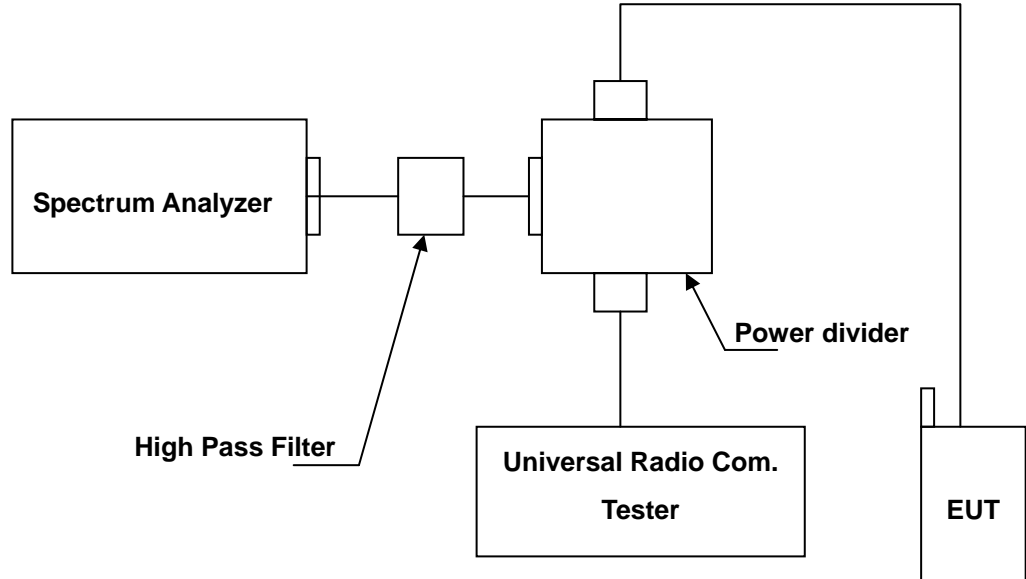

5.4. Test Procedure

1. The EUT was connected to Spectrum Analyzer and Base Station via power divider.
2. The middle channel for the highest RF power within the transmitting frequency was measured.
3. The conducted spurious emission for the whole frequency range was taken.
4. Test setting at GSM 850 RB>100 kHz, VB>100 kHz; PCS 1900 RB>1MHz, VB>1MHz.

5.5. Uncertainty

The measurement uncertainty is evaluated as ± 2.24 dB.

5.6. Test Result

Model Number	HE910		
Test Item	Conducted Emission		
Mode	Mode 1: GSM 850 Link Mode 2: GSM 1900 Link Mode 3: WCDMA Band II Link Mode 4: WCDMA Band V Link		
Date of Test	12/02/2011	Test Site	TE02

File :HE910(CH128)

Data :#1

Date: 2011/12/1

Time: 下午 05:03:00

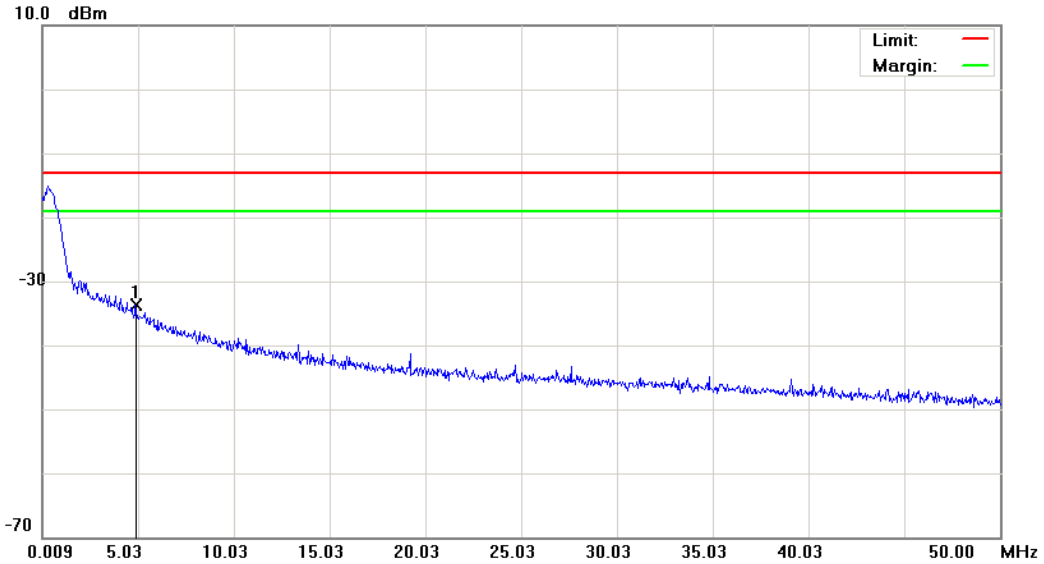

Site: : RF Conducted	Polarization: Conducted po	Temperature: 23 °C
Limit: FCC Part 22 conducted(9k-12.75G)	Power: DC 3.8V	Humidity: 55.2 %
EUT: 2G/3G Module	Distance:	RBW: 1000 kHz VBW: 1000 kHz
M/N: HE910		
Mode: 1		
Note:		

No.	Mk.	Freq.	Reading Level	Correct Factor	Measurement	Limit	Over	Antenna Height	Table Degree	
		MHz	dBm	dB	dBm	dBm	dB	cm	degree	Comment
1	*	4.8830	-62.17	28.39	-33.78	-13.00	-20.78			peak

*:Maximum data x:Over limit !:over margin

File :HE910(CH128)

Data :#2

Date: 2011/12/1

Time: 下午 05:03:24

20.0 dBm

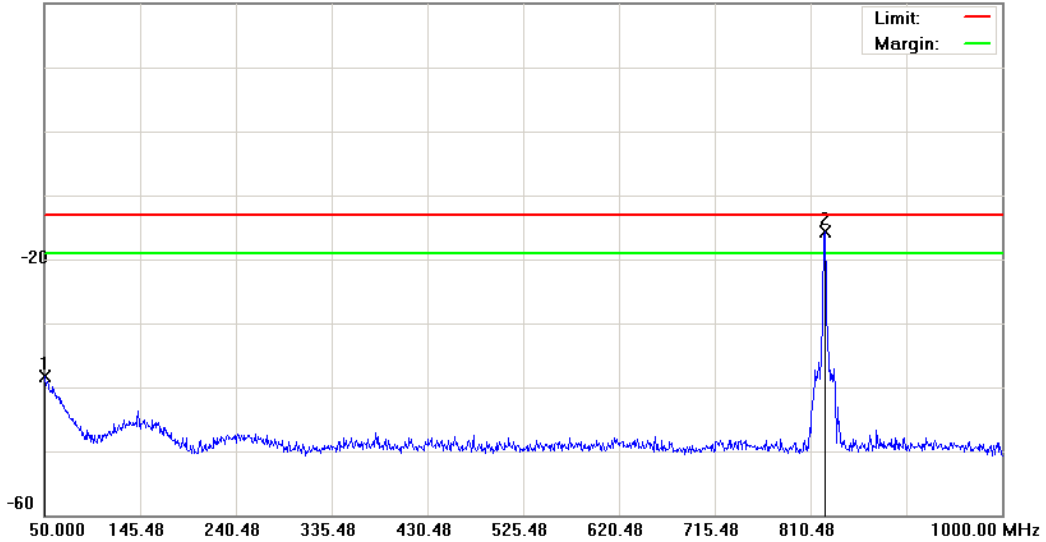

Site : RF Conducted	Polarization: Conducted po	Temperature: 23 °C
Limit: FCC Part 22 conducted(9k-12.75G)	Power: DC 3.8V	Humidity: 55.2 %
EUT: 2G/3G Module	Distance:	RBW: 1000 kHz VBW: 1000 kHz
M/N: HE910		
Mode: 1		
Note:		

No.	Mk.	Freq. MHz	Reading Level dBm	Correct Factor dB	Measure- ment dBm	Limit dBm	Over dB	Detector	Antenna Height cm	Table Degree degree	Comment
1		50.4750	-52.99	14.61	-38.38	-13.00	-25.38	peak			
2	*	824.2500	-19.62	3.84	-15.78	-13.00	-2.78	peak			Tx

*:Maximum data x:Over limit !:over margin

File :HE910(CH128)

Data :#3

Date: 2011/12/1

Time: 下午 05:09:22

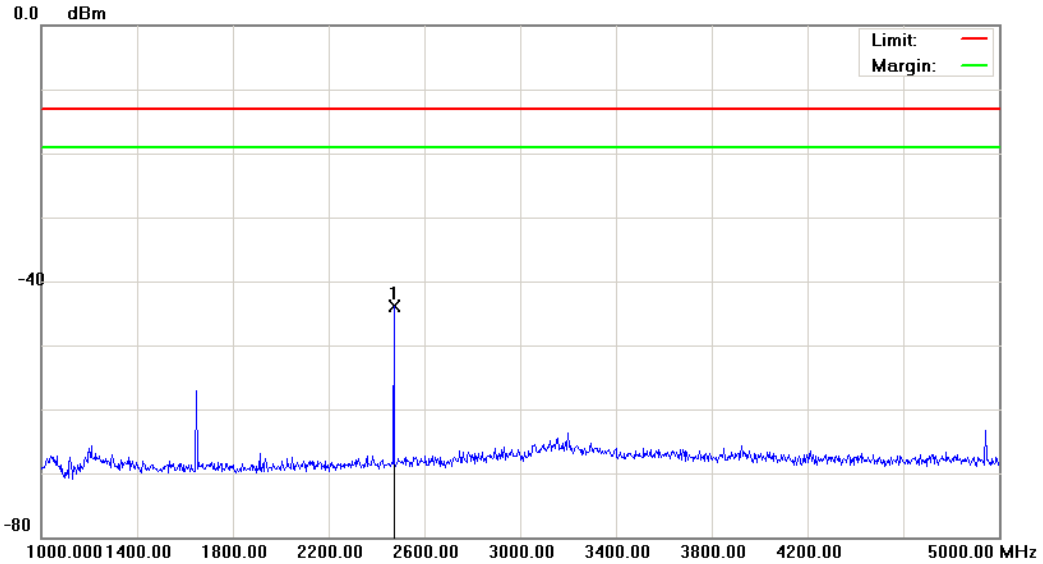

Site : RF Conducted	Polarization: Conducted po	Temperature: 23 °C
Limit: FCC Part 22 conducted(9k-12.75G)	Power: DC 3.8V	Humidity: 55.2 %
EUT: 2G/3G Module	Distance:	RBW: 1000 kHz VBW: 1000 kHz
M/N: HE910		
Mode: 1		
Note:		

No.	Mk.	Freq.	Reading Level	Correct Factor	Measurement	Limit	Over	Antenna Height	Table Degree
		MHz	dBm	dB	dBm	dBm	dB	cm	degree
1	*	2472.000	-48.40	4.45	-43.95	-13.00	-30.95	peak	

*:Maximum data x:Over limit !:over margin

File :HE910(CH128)

Data :#4

Date: 2011/12/1

Time: 下午 05:09:46

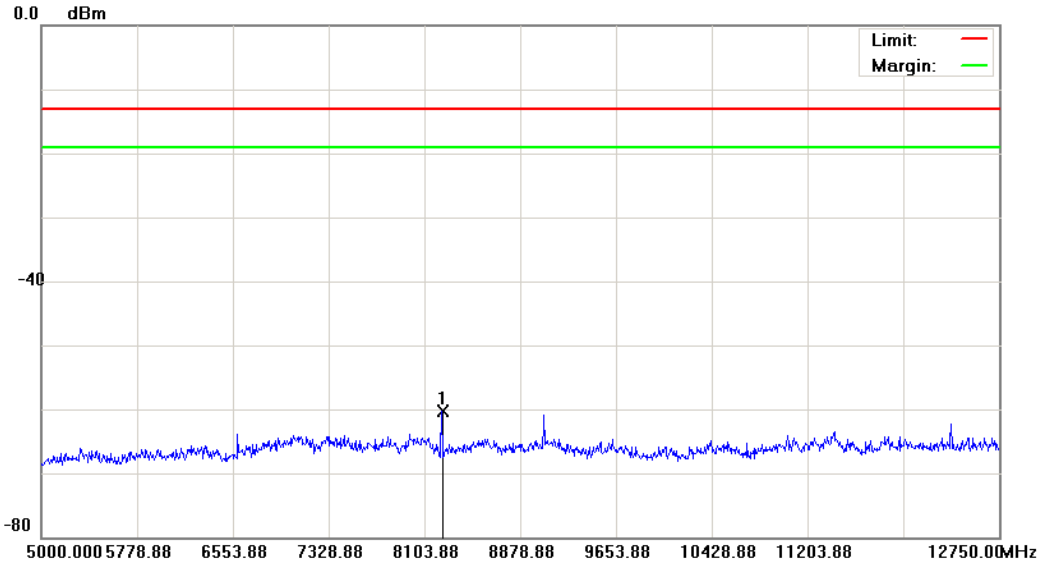

Site: : RF Conducted	Polarization: Conducted po	Temperature: 23 °C
Limit: FCC Part 22 conducted(9k-12.75G)	Power: DC 3.8V	Humidity: 55.2 %
EUT: 2G/3G Module	Distance:	RBW: 1000 kHz VBW: 1000 kHz
M/N: HE910		
Mode: 1		
Note:		

No.	Mk.	Freq.	Reading Level	Correct Factor	Measurement	Limit	Over	Antenna Height	Table Degree	
		MHz	dBm	dB	dBm	dBm	dB	cm	degree	Comment
1	*	8243.375	-64.99	4.68	-60.31	-13.00	-47.31			peak

*:Maximum data x:Over limit !:over margin

File :HE910(CH190)

Data :#1

Date: 2011/12/1

Time: 下午 05:05:24

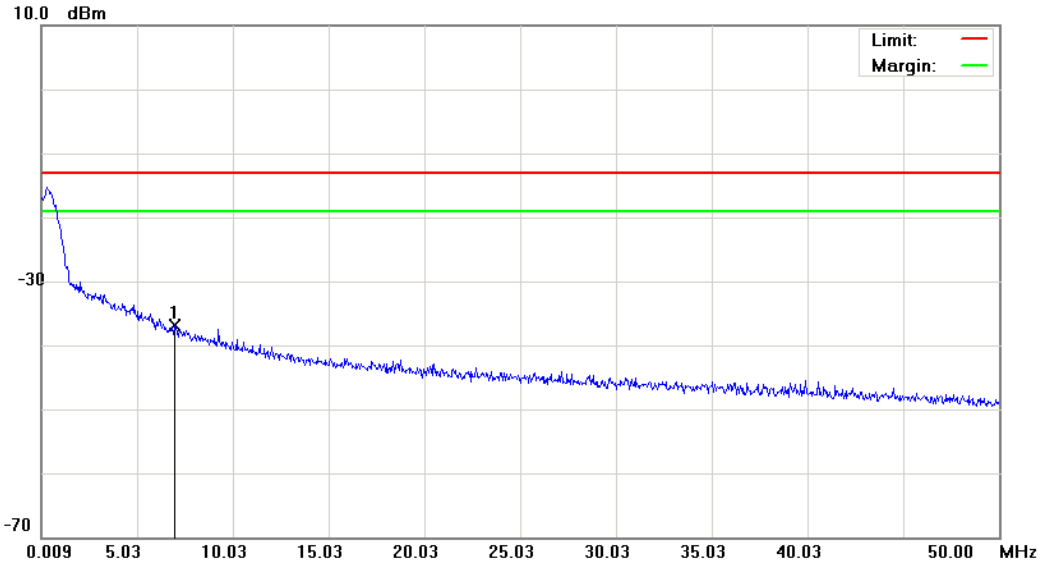

Site: : RF Conducted	Polarization: Conducted po	Temperature: 23 °C
Limit: FCC Part 22 conducted(9k-12.75G)	Power: DC 3.8V	Humidity: 55.2 %
EUT: 2G/3G Module	Distance:	RBW: 1000 kHz VBW: 1000 kHz
M/N: HE910		
Mode: 1		
Note:		

No.	Mk.	Freq.	Reading Level	Correct Factor	Measurement	Limit	Over	Antenna Height	Table Degree	
		MHz	dBm	dB	dBm	dBm	dB	cm	degree	Comment
1	*	6.9576	-62.80	25.98	-36.82	-13.00	-23.82			peak

*:Maximum data x:Over limit !:over margin

File :HE910(CH190)

Data :#2

Date: 2011/12/1

Time: 下午 05:05:48

20.0 dBm

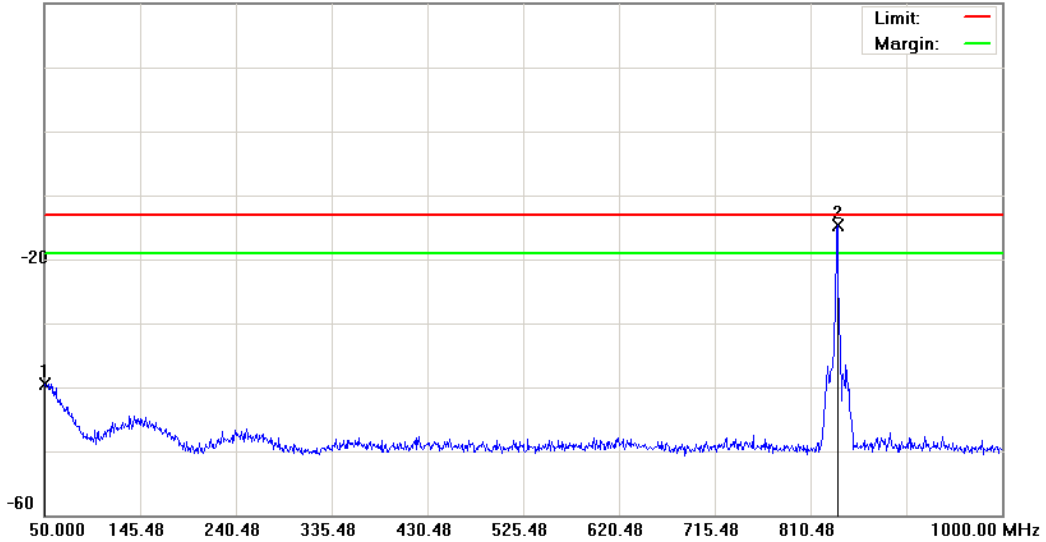

Site: : RF Conducted	Polarization: Conducted po	Temperature: 23 °C
Limit: FCC Part 22 conducted(9k-12.75G)	Power: DC 3.8V	Humidity: 55.2 %
EUT: 2G/3G Module	Distance:	RBW: 1000 kHz VBW: 1000 kHz
M/N: HE910		
Mode: 1		
Note:		

No.	Mk.	Freq. MHz	Reading Level dBm	Correct Factor dB	Measure- ment dBm	Limit dBm	Over dB	Detector	Antenna Height cm	Table Degree degree	Comment
1		50.4750	-54.09	14.61	-39.48	-13.00	-26.48	peak			
2	*	836.6000	-18.69	3.96	-14.73	-13.00	-1.73	peak			Tx

*:Maximum data x:Over limit !:over margin

File :HE910(CH190)

Data :#3

Date: 2011/12/1

Time: 下午 05:10:25

20.0 dBm

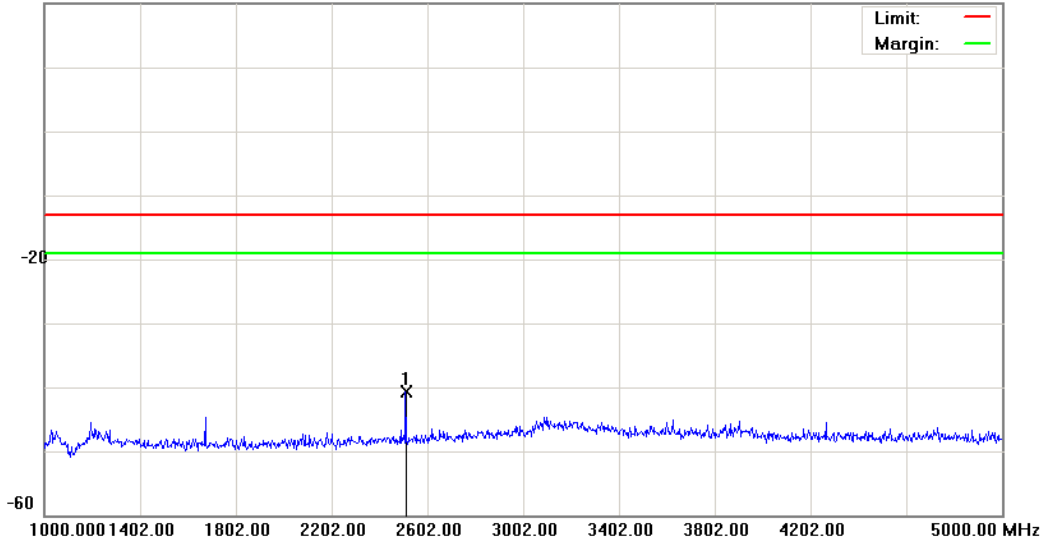

Site : RF Conducted

 Polarization: *Conducted po*

Temperature: 23 °C

Limit: FCC Part 22 conducted(9k-12.75G)

Power: DC 3.8V

Humidity: 55.2 %

EUT: 2G/3G Module

Distance:

RBW: 1000 kHz VBW: 1000 kHz

M/N: HE910

Mode: 1

Note:

No.	Mk.	Freq.	Reading Level	Correct Factor	Measurement	Limit	Over	Antenna Height	Table Degree	
		MHz	dBm	dB	dBm	dBm	dB	cm	degree	Comment
1	*	2510.000	-45.09	4.36	-40.73	-13.00	-27.73			peak

*:Maximum data x:Over limit !:over margin

File :HE910(CH190)

Data :#4

Date: 2011/12/1

Time: 下午 05:10:49

20.0 dBm

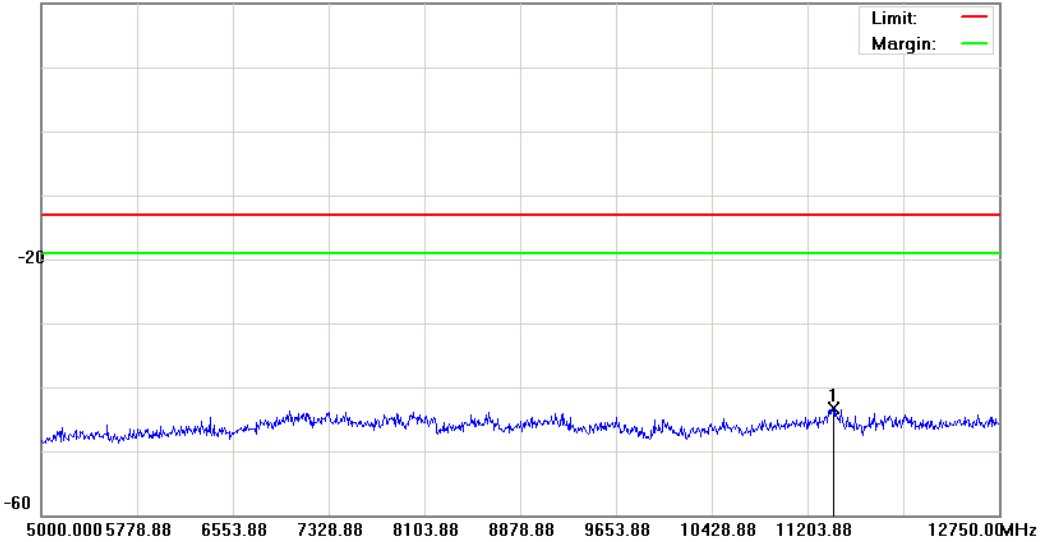

Site: : RF Conducted	Polarization: Conducted po	Temperature: 23 °C
Limit: FCC Part 22 conducted(9k-12.75G)	Power: DC 3.8V	Humidity: 55.2 %
EUT: 2G/3G Module	Distance:	RBW: 1000 kHz VBW: 1000 kHz
M/N: HE910		
Mode: 1		
Note:		

No.	Mk.	Freq.	Reading Level	Correct Factor	Measurement	Limit	Over	Antenna Height	Table Degree	
		MHz	dBm	dB	dBm	dBm	dB	cm	degree	Comment
1	*	11405.375	-48.94	5.56	-43.38	-13.00	-30.38			peak

*:Maximum data x:Over limit !:over margin

File :HE910(CH251)

Data :#1

Date: 2011/12/1

Time: 下午 05:07:28

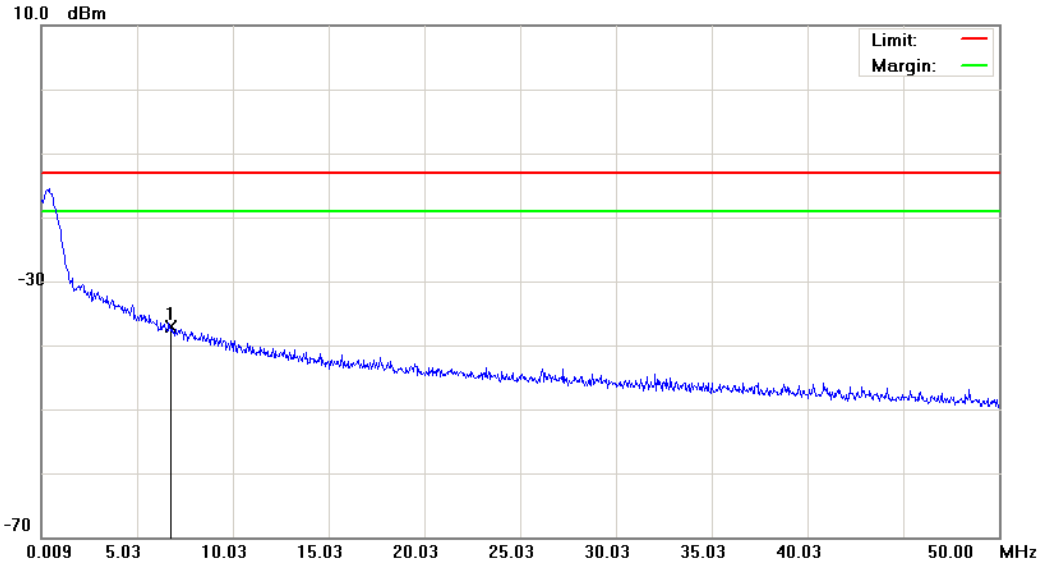

Site : RF Conducted	Polarization: Conducted po	Temperature: 23 °C
Limit: FCC Part 22 conducted(9k-12.75G)	Power: DC 3.8V	Humidity: 55.2 %
EUT: 2G/3G Module	Distance:	RBW: 1000 kHz VBW: 1000 kHz
M/N: HE910		
Mode: 1		
Note:		

No.	Mk.	Freq.	Reading Level	Correct Factor	Measurement	Limit	Over	Antenna Height	Table Degree	
		MHz	dBm	dB	dBm	dBm	dB	cm	degree	Comment
1	*	6.7328	-63.30	26.16	-37.14	-13.00	-24.14			peak

*:Maximum data x:Over limit !:over margin

File :HE910(CH251)

Data :#2

Date: 2011/12/1

Time: 下午 05:07:53

20.0 dBm

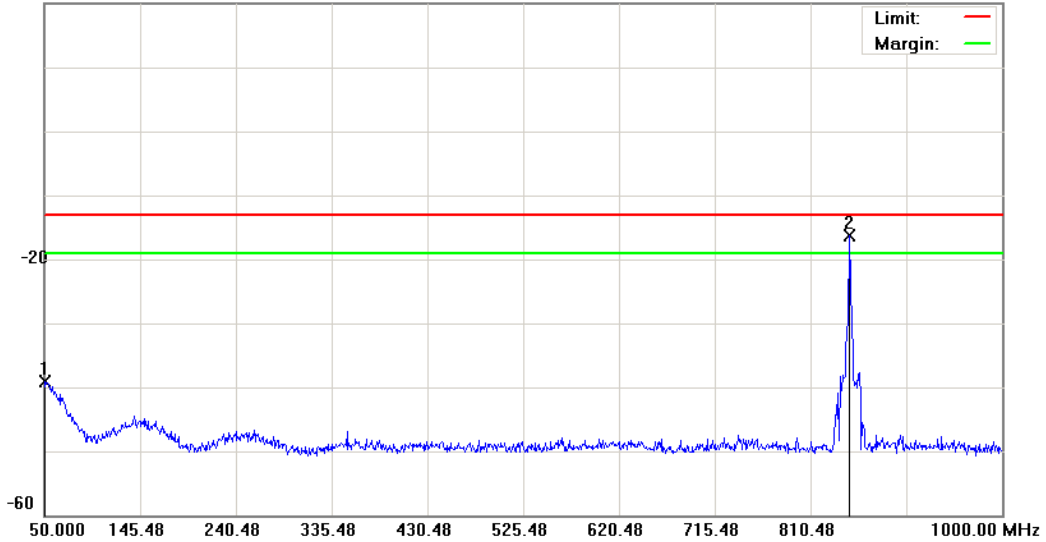

Site: : RF Conducted	Polarization: Conducted po	Temperature: 23 °C
Limit: FCC Part 22 conducted(9k-12.75G)	Power: DC 3.8V	Humidity: 55.2 %
EUT: 2G/3G Module	Distance:	RBW: 1000 kHz VBW: 1000 kHz
M/N: HE910		
Mode: 1		
Note:		

No.	Mk.	Freq. MHz	Reading Level dBm	Correct Factor dB	Measure- ment dBm	Limit dBm	Over dB	Detector	Antenna Height cm	Table Degree degree	Comment
1		50.4750	-53.77	14.61	-39.16	-13.00	-26.16	peak			
2	*	848.9500	-20.25	3.98	-16.27	-13.00	-3.27	peak			Tx

*:Maximum data x:Over limit !:over margin

File :HE910(CH251)

Data :#3

Date: 2011/12/1

Time: 下午 05:11:34

20.0 dBm

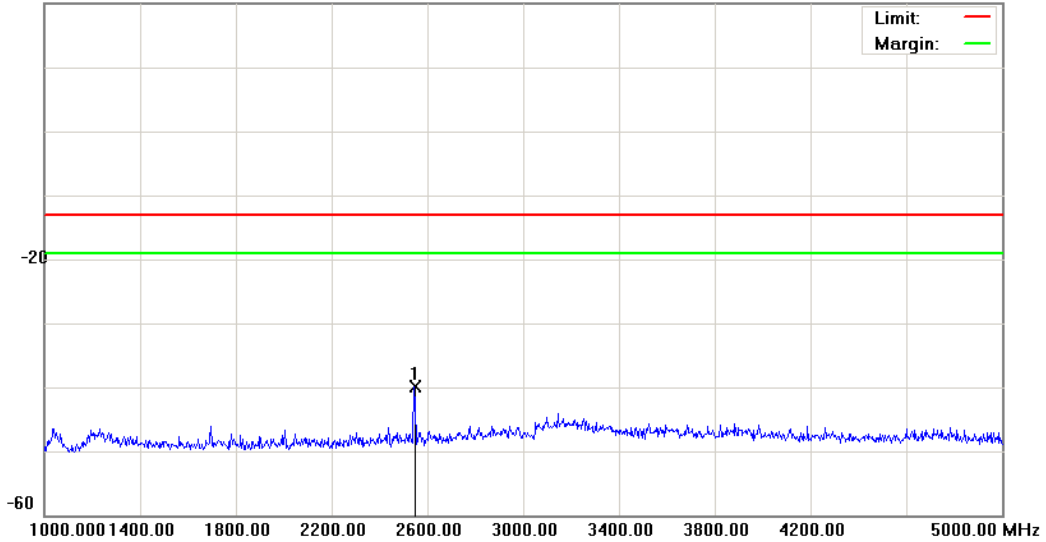

Site : RF Conducted	Polarization: Conducted po	Temperature: 23 °C
Limit: FCC Part 22 conducted(9k-12.75G)	Power: DC 3.8V	Humidity: 55.2 %
EUT: 2G/3G Module	Distance:	RBW: 1000 kHz VBW: 1000 kHz
M/N: HE910		
Mode: 1		
Note:		

No.	Mk.	Freq.	Reading Level	Correct Factor	Measurement	Limit	Over	Antenna Height	Table Degree
		MHz	dBm	dB	dBm	dBm	dB	cm	degree
1	*	2546.000	-44.28	4.45	-39.83	-13.00	-26.83	peak	

*:Maximum data x:Over limit !:over margin

File :HE910(CH251)

Data :#4

Date: 2011/12/1

Time: 下午 05:11:58

20.0 dBm

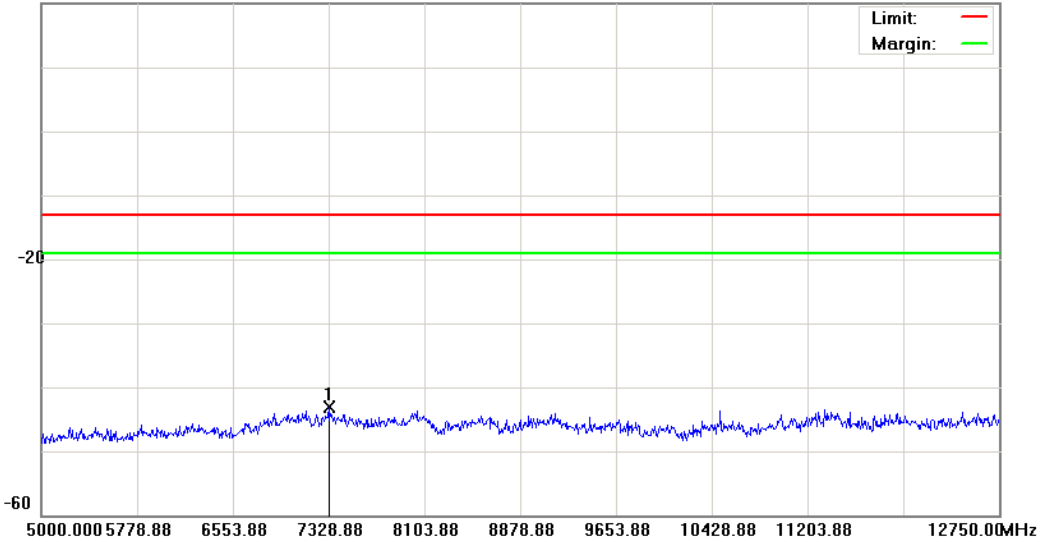

Site : RF Conducted

 Polarization: **Conducted po**

Temperature: 23 °C

Limit: FCC Part 22 conducted(9k-12.75G)

Power: DC 3.8V

Humidity: 55.2 %

EUT: 2G/3G Module

Distance:

RBW: 1000 kHz VBW: 1000 kHz

M/N: HE910

Mode: 1

Note:

No.	Mk.	Freq.	Reading Level	Correct Factor	Measurement	Limit	Over	Antenna Height	Table Degree	
		MHz	dBm	dB	dBm	dBm	dB	cm	degree	Comment
1	*	7328.875	-48.17	5.08	-43.09	-13.00	-30.09			peak

*:Maximum data x:Over limit !:over margin

File :HE910(CH512)

Data :#1

Date: 2011/12/1

Time: 下午 05:24:49

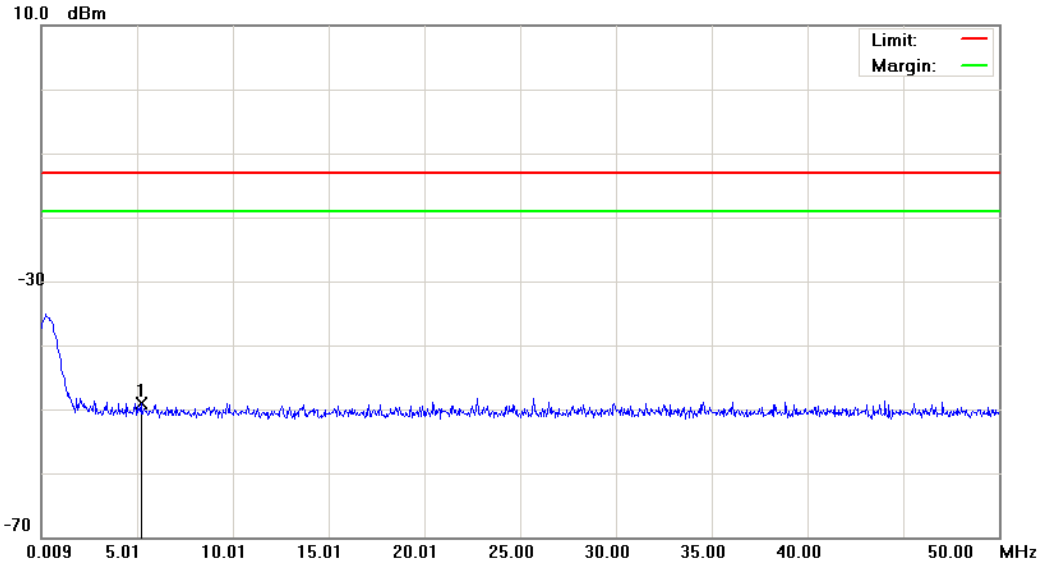

Site: : RF Conducted	Polarization: <i>Conducted po</i>	Temperature: 23 °C
Limit: FCC Part 24 conducted(9k-12.75G)	Power: DC 3.8V	Humidity: 55.2 %
EUT: 2G/3G Module	Distance:	RBW: 1000 kHz VBW: 1000 kHz
M/N: HE910		
Mode: 2		
Note:		

No.	Mk.	Freq.	Reading Level	Correct Factor	Measurement	Limit	Over	Antenna Height	Table Degree	
		MHz	dBm	dB	dBm	dBm	dB	cm	degree	Comment
1	*	5.2080	-62.28	13.26	-49.02	-13.00	-36.02			peak

*:Maximum data x:Over limit !:over margin

File :HE910(CH512)

Data :#2

Date: 2011/12/1

Time: 下午 05:25:13

20.0 dBm

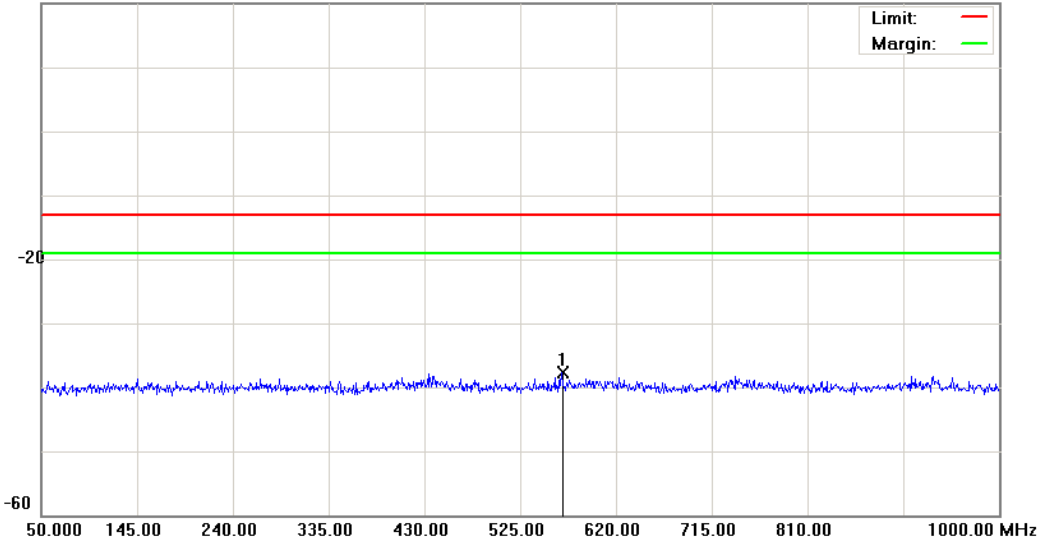

Site : RF Conducted

 Polarization: *Conducted po*

Temperature: 23 °C

Limit: FCC Part 24 conducted(9k-12.75G)

Power: DC 3.8V

Humidity: 55.2 %

EUT: 2G/3G Module

Distance:

RBW: 1000 kHz VBW: 1000 kHz

M/N: HE910

Mode: 2

Note:

No.	Mk.	Freq. MHz	Reading Level dBm	Correct Factor dB	Measure- ment dBm	Limit dBm	Over dB	Detector	Antenna Height cm	Table Degree degree	Comment
1	*	566.3250	-50.76	13.12	-37.64	-13.00	-24.64	peak			

*:Maximum data x:Over limit !:over margin

File :HE910(CH512)

Data :#3

Date: 2011/12/1

Time: 下午 05:51:51

20.0 dBm

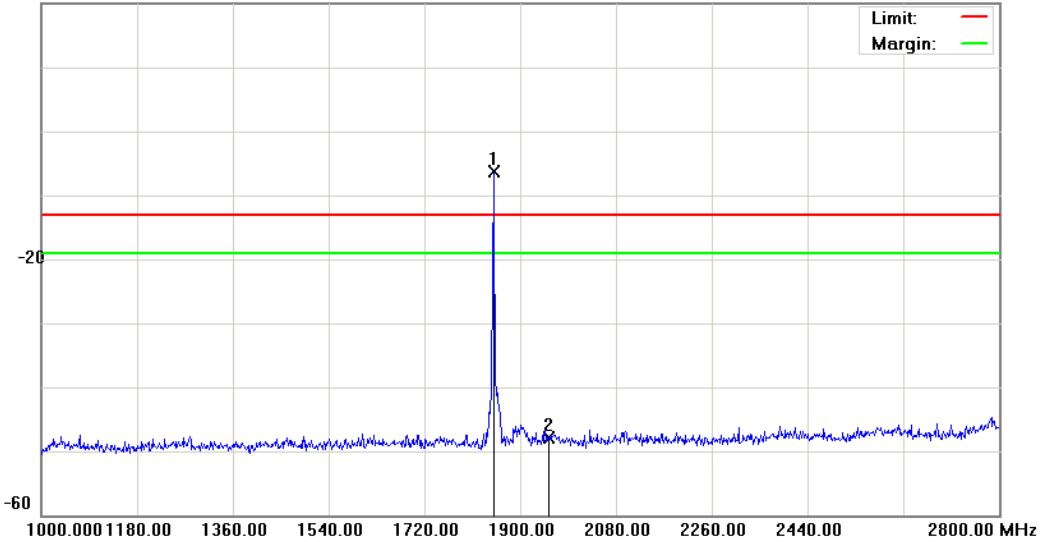

Site: : RF Conducted	Polarization: Conducted po	Temperature: 23 °C
Limit: FCC Part 24 conducted(9k-12.75G)	Power: DC 3.8V	Humidity: 55.2 %
EUT: 2G/3G Module	Distance:	RBW: 1000 kHz VBW: 1000 kHz
M/N: HE910		
Mode: 2		
Note:		

No.	Mk.	Freq. MHz	Reading Level dBm	Correct Factor dB	Measure- ment dBm	Limit dBm	Over dB	Detector	Antenna Height cm	Table Degree degree	Comment
1	*	1850.500	-10.63	4.26	-6.37	-13.00	6.63	peak			Tx
2		1954.000	-52.62	4.69	-47.93	-13.00	-34.93	peak			

*:Maximum data x:Over limit !:over margin

File :HE910(CH512)

Data :#4

Date: 2011/12/2

Time: 上午 09:23:23

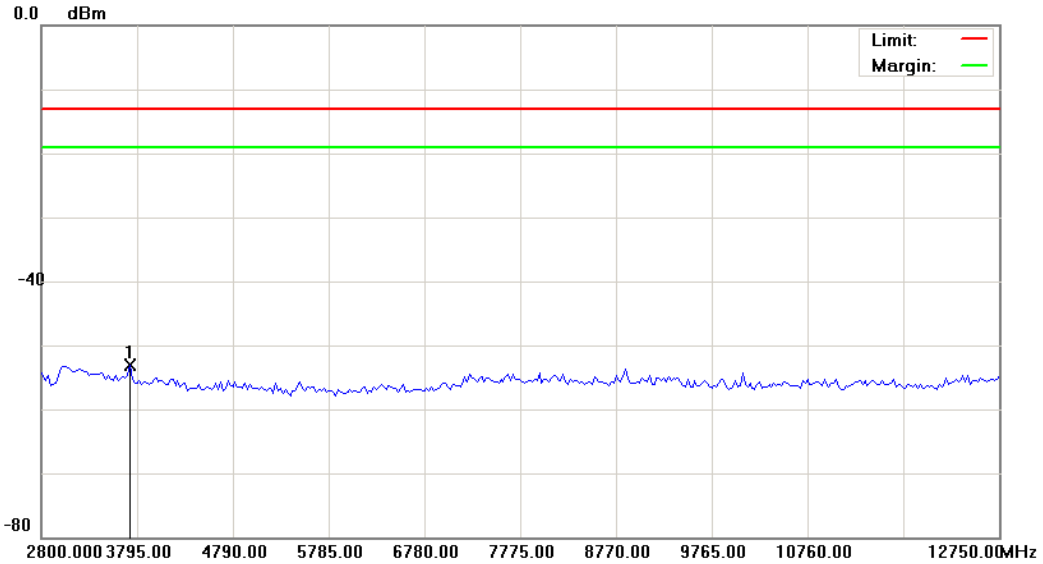

Site: : RF Conducted	Polarization: Conducted po	Temperature: 23 °C
Limit: FCC Part 24 conducted(9k-12.75G)	Power: DC 3.8V	Humidity: 55.2 %
EUT: 2G/3G Module	Distance:	RBW: 1000 kHz VBW: 1000 kHz
M/N: HE910		
Mode: 2		
Note:		

No.	Mk.	Freq. MHz	Reading Level dBm	Correct Factor dB	Measure- ment dBm	Limit dBm	Over dB	Antenna Height cm	Table Degree degree	Comment
1	*	3720.375	-58.01	4.88	-53.13	-13.00	-40.13	peak		

*:Maximum data x:Over limit !:over margin

File :HE910(CH512)

Data :#5

Date: 2011/12/2

Time: 上午 09:23:45

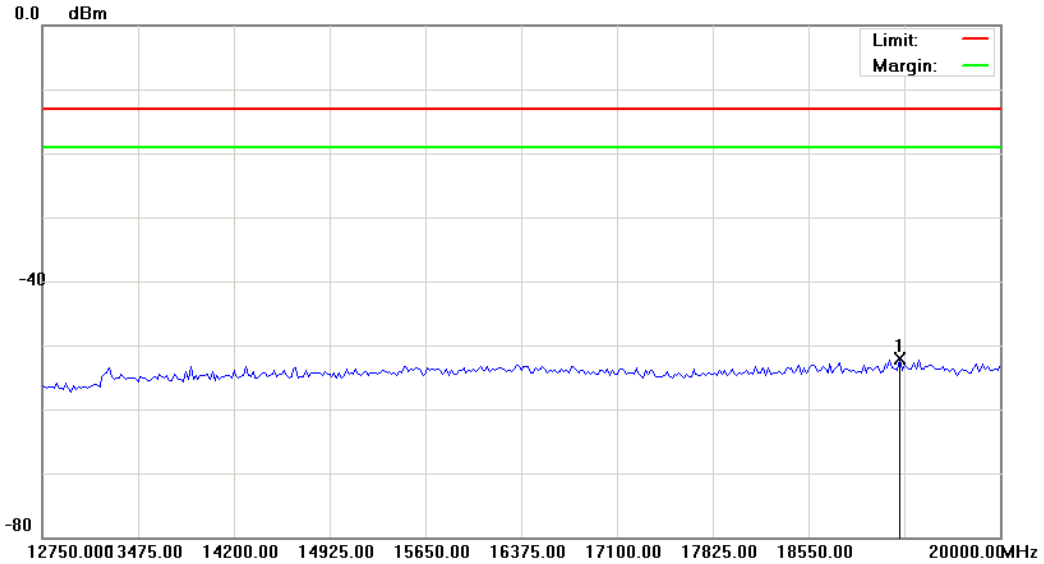

Site: : RF Conducted	Polarization: Conducted po	Temperature: 23 °C
Limit: FCC Part 24 conducted(9k-12.75G)	Power: DC 3.8V	Humidity: 55.2 %
EUT: 2G/3G Module	Distance:	RBW: 1000 kHz VBW: 1000 kHz
M/N: HE910		
Mode: 2		
Note:		

No.	Mk.	Freq.	Reading Level	Correct Factor	Measurement	Limit	Over	Antenna Height	Table Degree	
		MHz	dBm	dB	dBm	dBm	dB	cm	degree	Comment
1	*	19238.750	-59.28	7.22	-52.06	-13.00	-39.06			peak

*:Maximum data x:Over limit !:over margin

File :HE910(CH661)

Data :#1

Date: 2011/12/1

Time: 下午 05:26:17

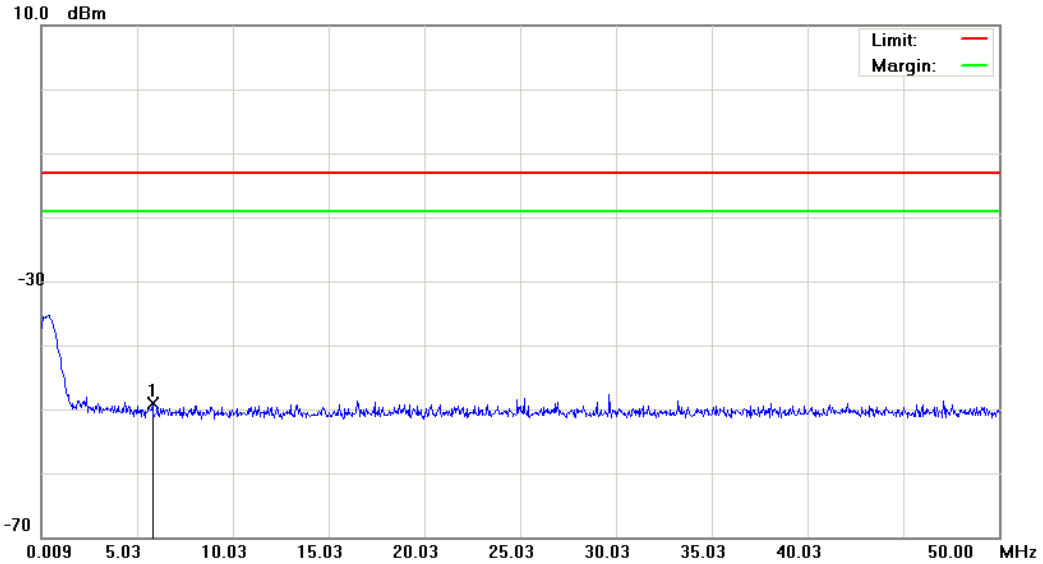

Site: : RF Conducted	Polarization: Conducted po	Temperature: 23 °C
Limit: FCC Part 24 conducted(9k-12.75G)	Power: DC 3.8V	Humidity: 55.2 %
EUT: 2G/3G Module	Distance:	RBW: 1000 kHz VBW: 1000 kHz
M/N: HE910		
Mode: 2		
Note:		

No.	Mk.	Freq.	Reading Level	Correct Factor	Measurement	Limit	Over	Antenna Height	Table Degree	
		MHz	dBm	dB	dBm	dBm	dB	cm	degree	Comment
1	*	5.8330	-62.29	13.24	-49.05	-13.00	-36.05			peak

*:Maximum data x:Over limit !:over margin

File :HE910(CH661)

Data :#2

Date: 2011/12/1

Time: 下午 05:26:41

20.0 dBm

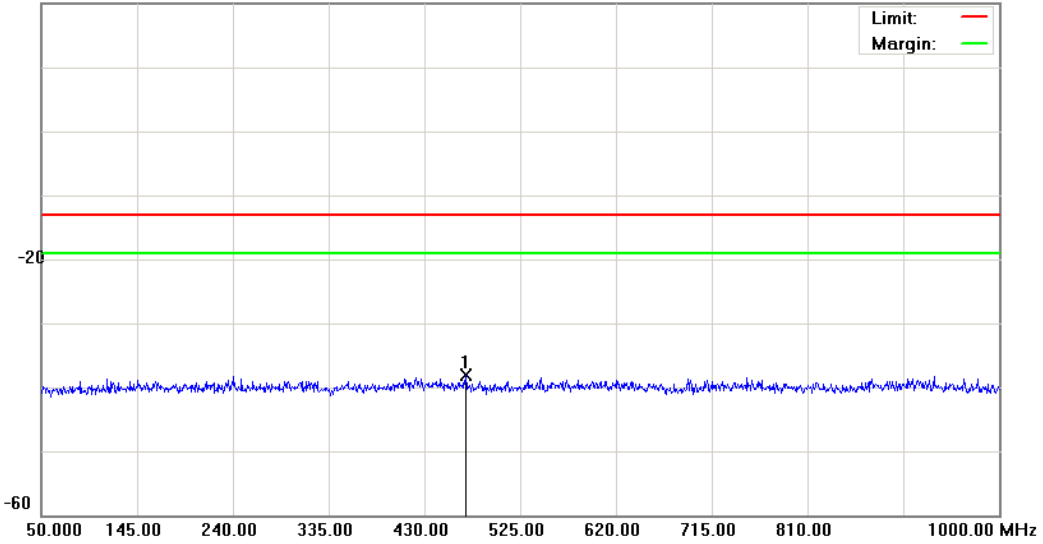

Site : RF Conducted

 Polarization: *Conducted po*

Temperature: 23 °C

Limit: FCC Part 24 conducted(9k-12.75G)

Power: DC 3.8V

Humidity: 55.2 %

EUT: 2G/3G Module

Distance:

RBW: 1000 kHz VBW: 1000 kHz

M/N: HE910

Mode: 2

Note:

No.	Mk.	Freq. MHz	Reading Level dBm	Correct Factor dB	Measure- ment dBm	Limit dBm	Over dB	Antenna Height cm	Table Degree degree	Comment
1	*	470.8500	-51.22	13.20	-38.02	-13.00	-25.02	peak		

*:Maximum data x:Over limit !:over margin

File :HE910(CH661)

Data :#3

Date: 2011/12/1

Time: 下午 05:53:23

20.0 dBm

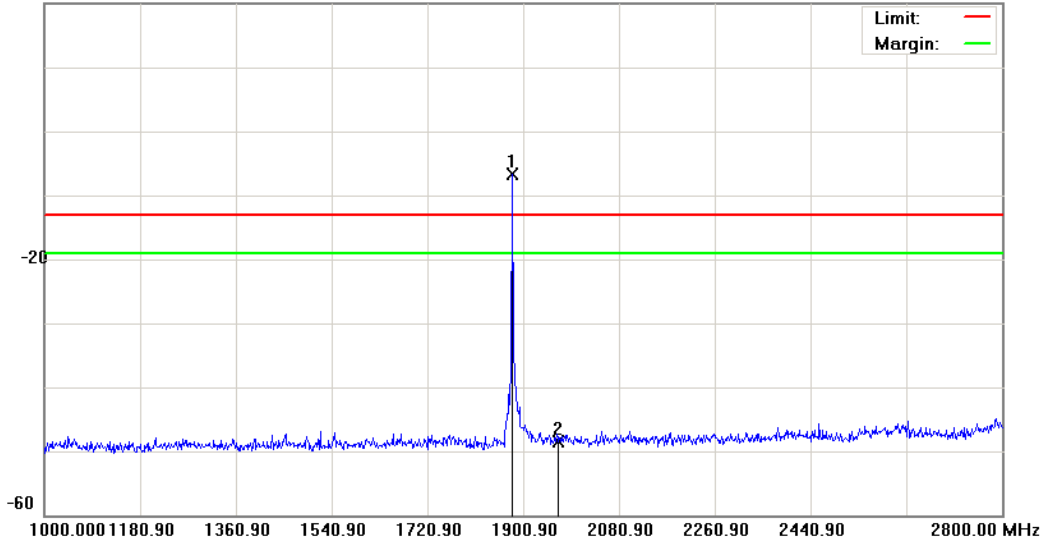

Site : RF Conducted

 Polarization: **Conducted po**

Temperature: 23 °C

Limit: FCC Part 24 conducted(9k-12.75G)

Power: DC 3.8V

Humidity: 55.2 %

EUT: 2G/3G Module

Distance:

RBW: 1000 kHz VBW: 1000 kHz

M/N: HE910

Mode: 2

Note:

No.	Mk.	Freq. MHz	Reading Level dBm	Correct Factor dB	Measure- ment dBm	Limit dBm	Over dB	Detector	Antenna Height cm	Table Degree degree	Comment
1	*	1880.200	-11.38	4.65	-6.73	-13.00	6.27	peak			Tx
2		1966.600	-53.18	4.75	-48.43	-13.00	-35.43	peak			

*:Maximum data x:Over limit !:over margin

File :HE910(CH661)

Data :#4

Date: 2011/12/2

Time: 上午 09:24:35

20.0 dBm

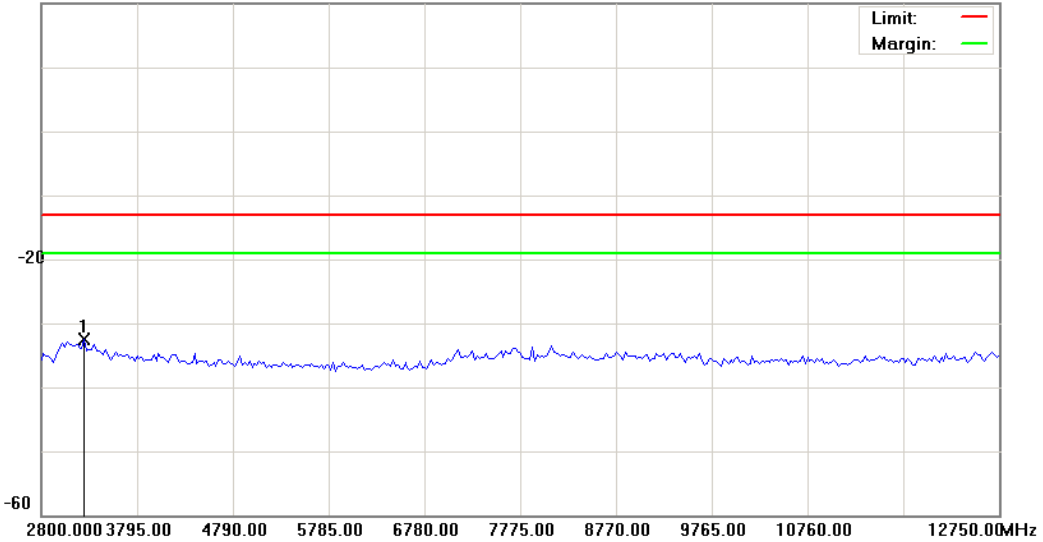

Site: : RF Conducted	Polarization: Conducted po	Temperature: 23 °C
Limit: FCC Part 24 conducted(9k-12.75G)	Power: DC 3.8V	Humidity: 55.2 %
EUT: 2G/3G Module	Distance:	RBW: 1000 kHz VBW: 1000 kHz
M/N: HE910		
Mode: 2		
Note:		

No.	Mk.	Freq. MHz	Reading Level dBm	Correct Factor dB	Measure- ment dBm	Limit dBm	Over dB	Antenna Height cm	Table Degree degree	Comment
1	*	3247.750	-37.63	5.11	-32.52	-13.00	-19.52	peak		

*:Maximum data x:Over limit !:over margin

File :HE910(CH661)

Data :#5

Date: 2011/12/2

Time: 上午 09:24:56

20.0 dBm

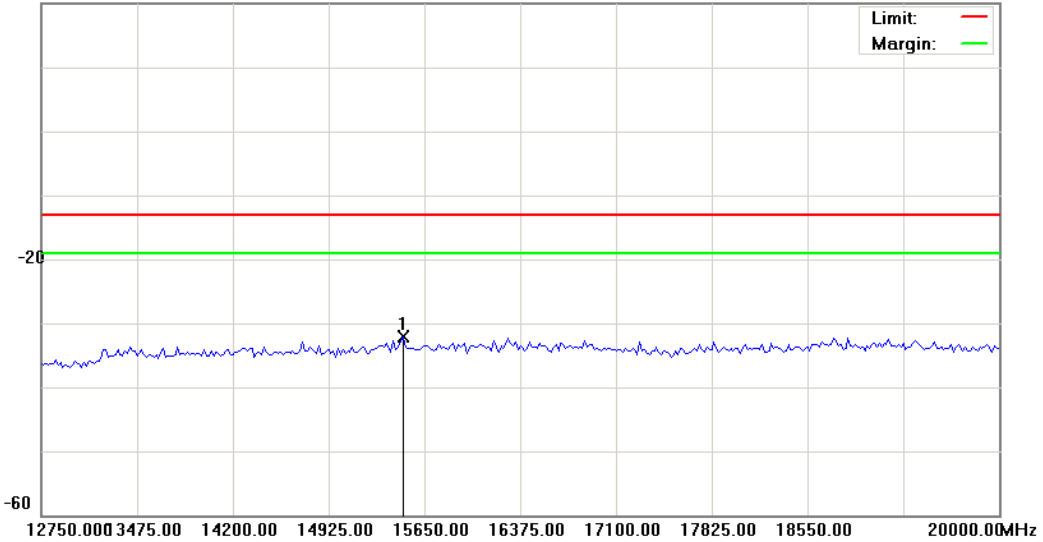

Site: : RF Conducted	Polarization: Conducted po	Temperature: 23 °C
Limit: FCC Part 24 conducted(9k-12.75G)	Power: DC 3.8V	Humidity: 55.2 %
EUT: 2G/3G Module	Distance:	RBW: 1000 kHz VBW: 1000 kHz
M/N: HE910		
Mode: 2		
Note:		

No.	Mk.	Freq. MHz	Reading Level dBm	Correct Factor dB	Measure- ment dBm	Limit dBm	Over dB	Antenna Height cm	Table Degree degree	Comment
1	*	15486.875	-38.34	6.15	-32.19	-13.00	-19.19	peak		

*:Maximum data x:Over limit !:over margin

File :HE910(CH810)

Data :#1

Date: 2011/12/1

Time: 下午 05:27:23

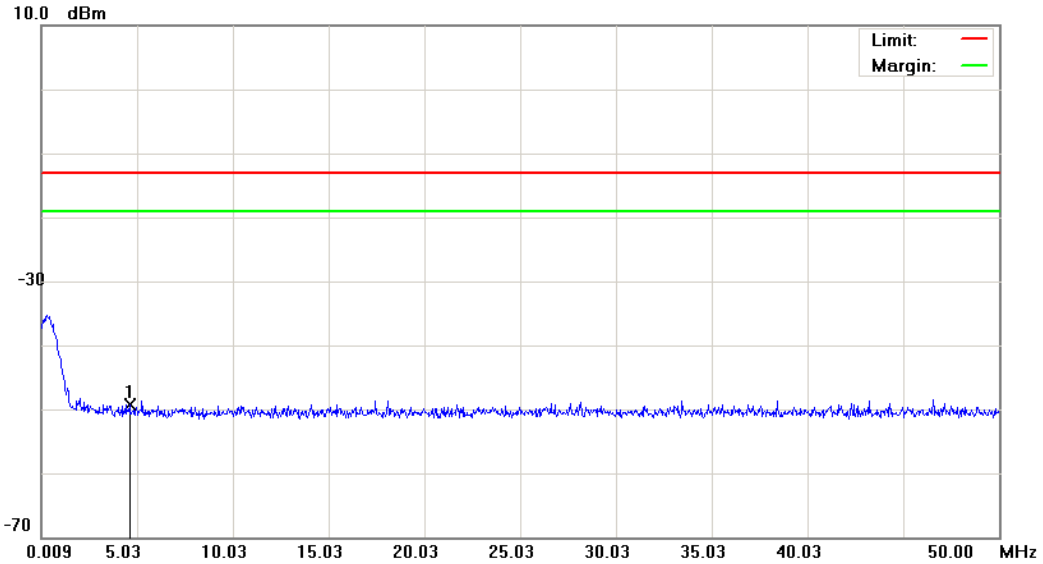

Site: : RF Conducted	Polarization: Conducted po	Temperature: 23 °C
Limit: FCC Part 24 conducted(9k-12.75G)	Power: DC 3.8V	Humidity: 55.2 %
EUT: 2G/3G Module	Distance:	RBW: 1000 kHz VBW: 1000 kHz
M/N: HE910		
Mode: 2		
Note:		

No.	Mk.	Freq.	Reading Level	Correct Factor	Measurement	Limit	Over	Antenna Height	Table Degree	
		MHz	dBm	dB	dBm	dBm	dB	cm	degree	Comment
1	*	4.6332	-62.54	13.22	-49.32	-13.00	-36.32			peak

*:Maximum data x:Over limit !:over margin

File :HE910(CH810)

Data :#2

Date: 2011/12/1

Time: 下午 05:27:47

20.0 dBm

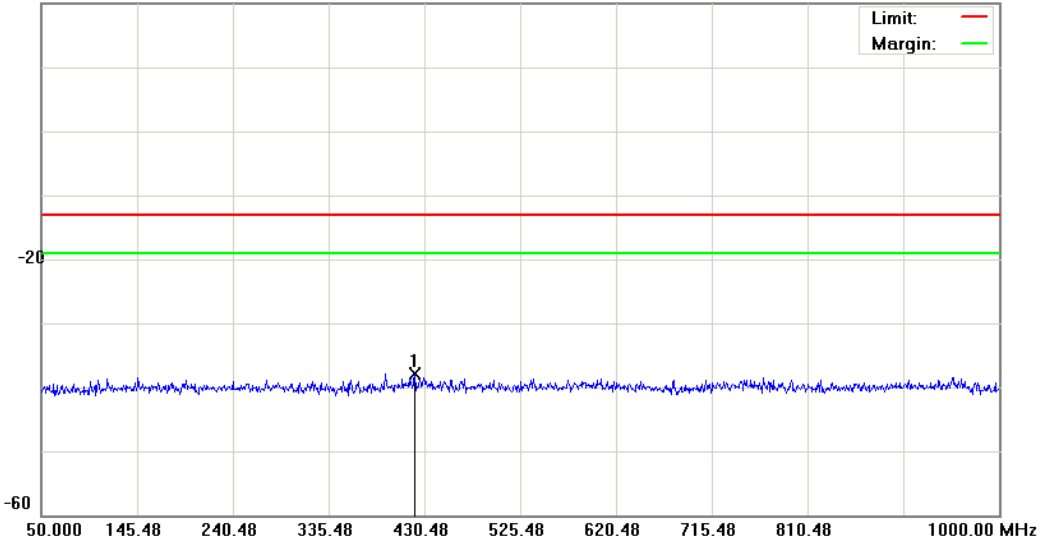

Site: : RF Conducted	Polarization: Conducted po	Temperature: 23 °C
Limit: FCC Part 24 conducted(9k-12.75G)	Power: DC 3.8V	Humidity: 55.2 %
EUT: 2G/3G Module	Distance:	RBW: 1000 kHz VBW: 1000 kHz
M/N: HE910		
Mode: 2		
Note:		

No.	Mk.	Freq.	Reading Level	Correct Factor	Measurement	Limit	Over	Antenna Height	Table Degree	
		MHz	dBm	dB	dBm	dBm	dB	cm	degree	Comment
1	*	420.5000	-51.14	13.24	-37.90	-13.00	-24.90			peak

*:Maximum data x:Over limit !:over margin

File :HE910(CH810)

Data :#3

Date: 2011/12/1

Time: 下午 05:54:58

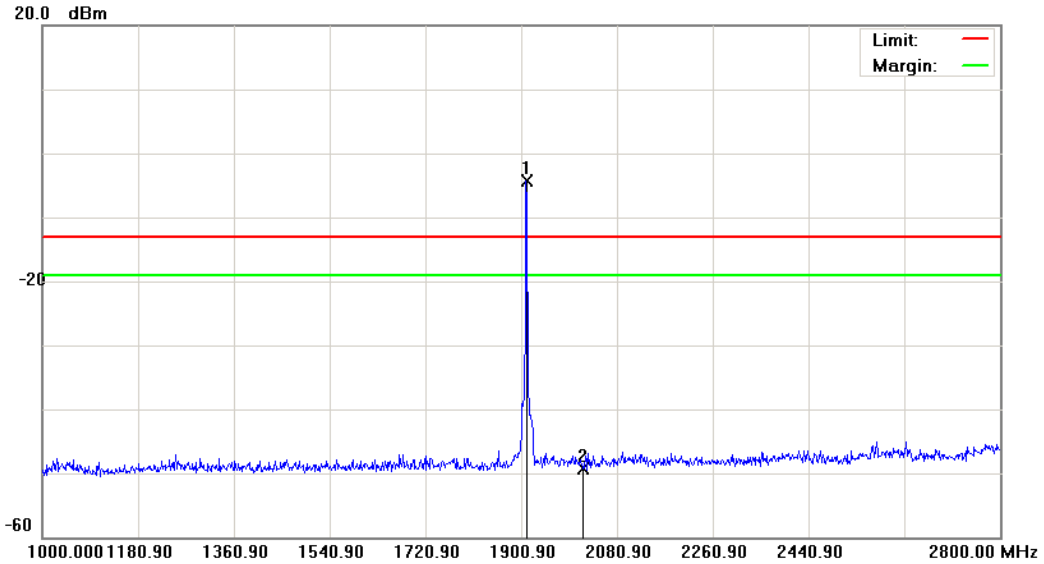

Site : RF Conducted

 Polarization: **Conducted po**

Temperature: 23 °C

Limit: FCC Part 24 conducted(9k-12.75G)

Power: DC 3.8V

Humidity: 55.2 %

EUT: 2G/3G Module

Distance:

RBW: 1000 kHz VBW: 1000 kHz

M/N: HE910

Mode: 2

Note:

No.	Mk.	Freq. MHz	Reading Level dBm	Correct Factor dB	Measure- ment dBm	Limit dBm	Over dB	Detector	Antenna Height cm	Table Degree degree	Comment
1	*	1909.900	-10.01	5.71	-4.30	-13.00	8.70	peak			Tx
2		2017.000	-53.72	4.41	-49.31	-13.00	-36.31	peak			

*:Maximum data x:Over limit !:over margin

File :HE910(CH810)

Data :#4

Date: 2011/12/2

Time: 上午 09:25:38

20.0 dBm

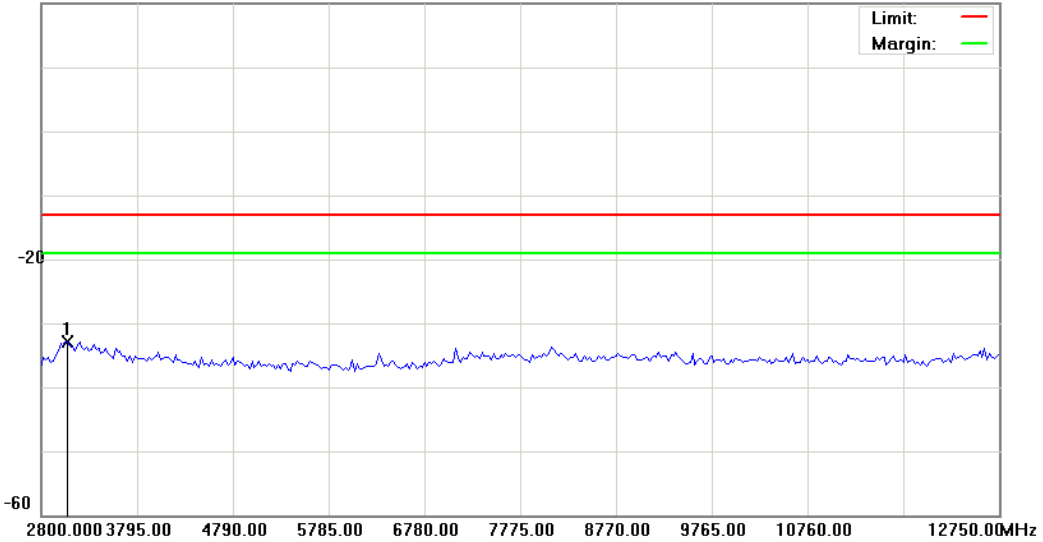

Site: : RF Conducted	Polarization: Conducted po	Temperature: 23 °C
Limit: FCC Part 24 conducted(9k-12.75G)	Power: DC 3.8V	Humidity: 55.2 %
EUT: 2G/3G Module	Distance:	RBW: 1000 kHz VBW: 1000 kHz
M/N: HE910		
Mode: 2		
Note:		

No.	Mk.	Freq. MHz	Reading Level dBm	Correct Factor dB	Measure- ment dBm	Limit dBm	Over dB	Detector	Antenna Height cm	Table Degree degree	Comment
1	*	3073.625	-38.22	5.40	-32.82	-13.00	-19.82	peak			

*:Maximum data x:Over limit !:over margin

File :HE910(CH810)

Data :#5

Date: 2011/12/2

Time: 上午 09:26:00

20.0 dBm

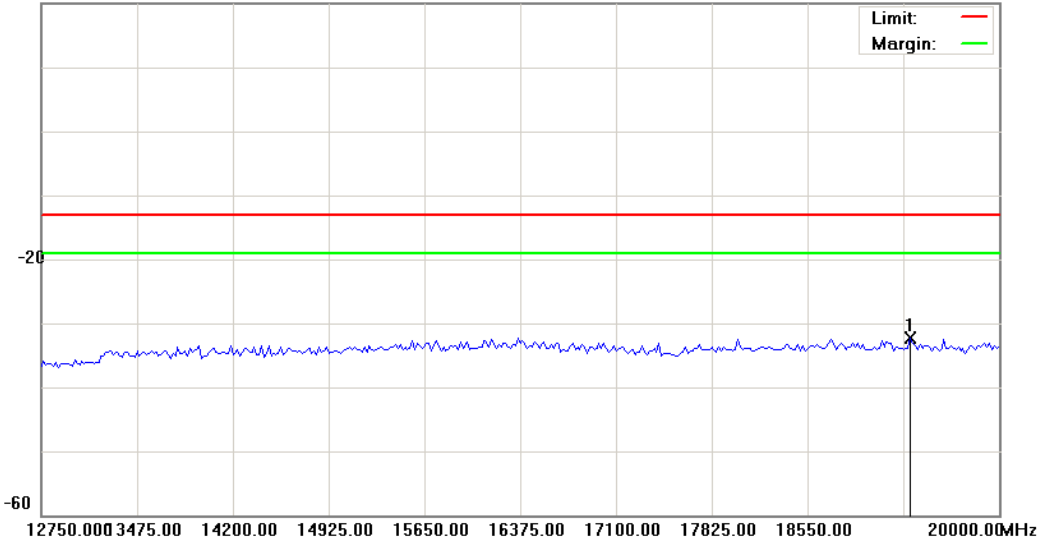

Site: : RF Conducted	Polarization: Conducted po	Temperature: 23 °C
Limit: FCC Part 24 conducted(9k-12.75G)	Power: DC 3.8V	Humidity: 55.2 %
EUT: 2G/3G Module	Distance:	RBW: 1000 kHz VBW: 1000 kHz
M/N: HE910		
Mode: 2		
Note:		

No.	Mk.	Freq. MHz	Reading Level dBm	Correct Factor dB	Measure- ment dBm	Limit dBm	Over dB	Antenna Height cm	Table Degree degree	Comment
1	*	19329.375	-39.52	7.25	-32.27	-13.00	-19.27	peak		

*:Maximum data x:Over limit !:over margin

File :HE910(CH9262)

Data :#1

Date: 2011/12/2

Time: 上午 09:40:22

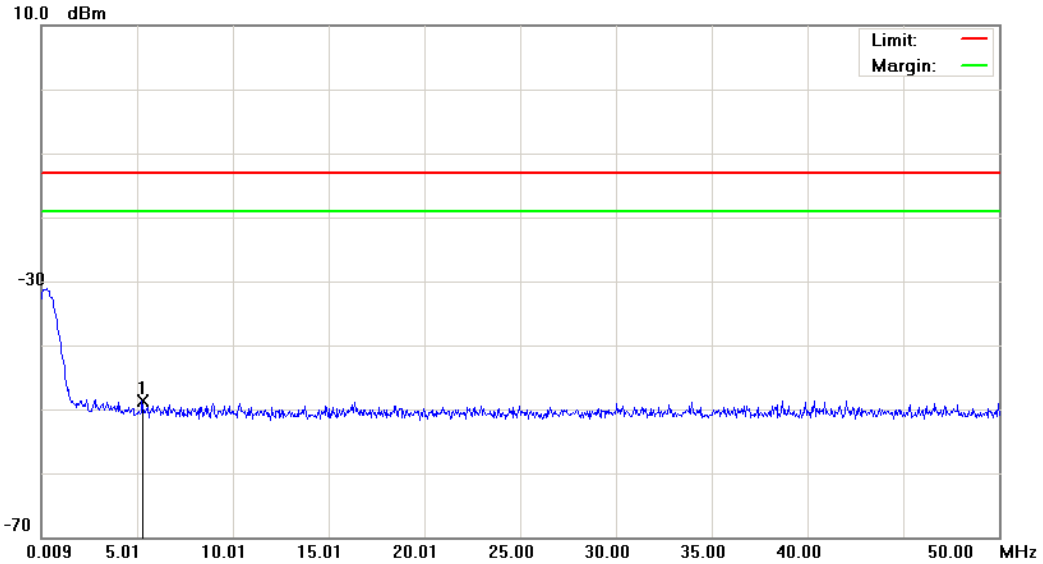

Site : RF Conducted

 Polarization: Conducted po

Temperature: 23 °C

Limit: FCC Part 24 conducted(9k-12.75G)

Power: DC 3.8V

Humidity: 55.2 %

EUT: 2G/3G Module

Distance:

RBW: 1000 kHz VBW: 1000 kHz

M/N: HE910

Mode: 3

Note:

No.	Mk.	Freq.	Reading Level	Correct Factor	Measurement	Limit	Over	Antenna Height	Table Degree	
		MHz	dBm	dB	dBm	dBm	dB	cm	degree	Comment
1	*	5.2831	-62.06	13.27	-48.79	-13.00	-35.79			peak

*:Maximum data x:Over limit !:over margin

File :HE910(CH9262)

Data :#2

Date: 2011/12/2

Time: 上午 09:40:47

20.0 dBm

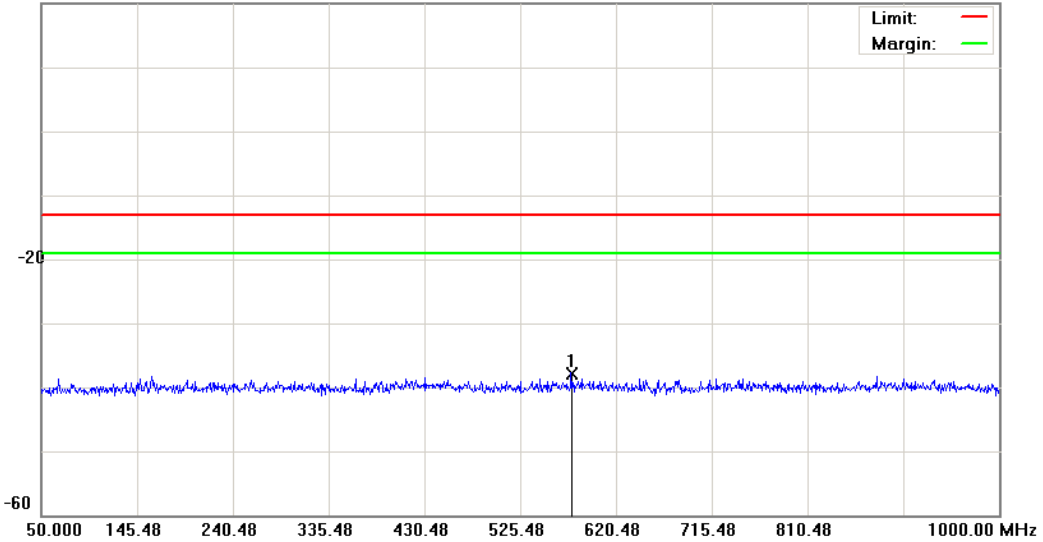

Site : RF Conducted	Polarization: Conducted po	Temperature: 23 °C
Limit: FCC Part 24 conducted(9k-12.75G)	Power: DC 3.8V	Humidity: 55.2 %
EUT: 2G/3G Module	Distance:	RBW: 1000 kHz VBW: 1000 kHz
M/N: HE910		
Mode: 3		
Note:		

No.	Mk.	Freq. MHz	Reading Level dBm	Correct Factor dB	Measure- ment dBm	Limit dBm	Over dB	Antenna Height cm	Table Degree degree	Comment
1	*	575.8250	-50.98	13.18	-37.80	-13.00	-24.80	peak		

*:Maximum data x:Over limit !:over margin

File :HE910(CH9262)

Data :#3

Date: 2011/12/2

Time: 上午 09:46:50

20.0 dBm

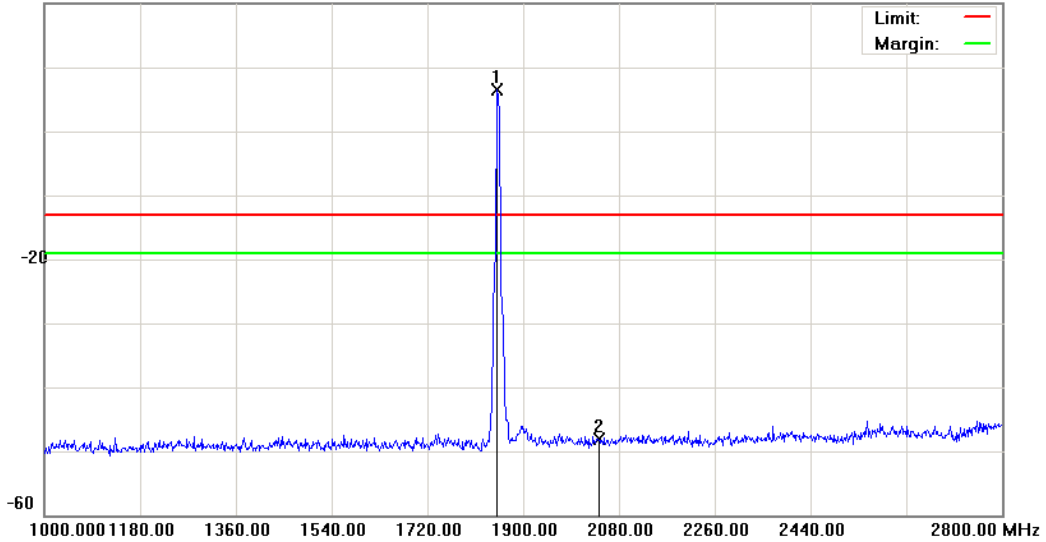

Site : RF Conducted

 Polarization: **Conducted po**

Temperature: 23 °C

Limit: FCC Part 24 conducted(9k-12.75G)

Power: DC 3.8V

Humidity: 55.2 %

EUT: 2G/3G Module

Distance:

RBW: 1000 kHz VBW: 1000 kHz

M/N: HE910

Mode: 3

Note:

No.	Mk.	Freq. MHz	Reading Level dBm	Correct Factor dB	Measure- ment dBm	Limit dBm	Over dB	Detector	Antenna Height cm	Table Degree degree	Comment
1	*	1850.500	2.34	4.26	6.60	-13.00	19.60	peak			Tx
2		2041.300	-52.68	4.50	-48.18	-13.00	-35.18	peak			

*:Maximum data x:Over limit !:over margin

File :HE910(CH9262)

Data :#4

Date: 2011/12/2

Time: 上午 09:55:15

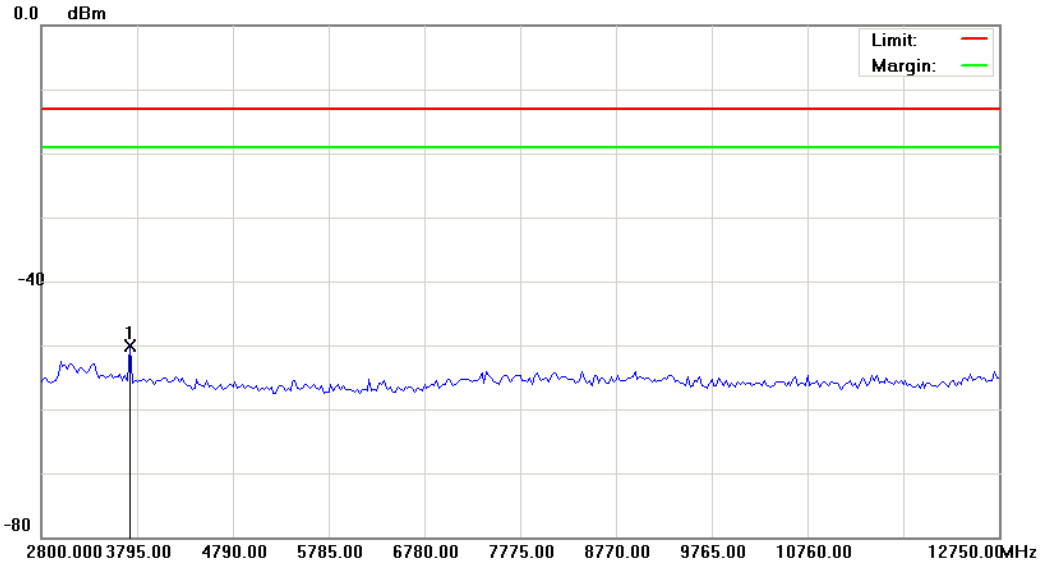

Site : RF Conducted

 Polarization: **Conducted po**

Temperature: 23 °C

Limit: FCC Part 24 conducted(9k-12.75G)

Power: DC 3.8V

Humidity: 55.2 %

EUT: 2G/3G Module

Distance:

RBW: 1000 kHz VBW: 1000 kHz

M/N: HE910

Mode: 3

Note:

No.	Mk.	Freq. MHz	Reading Level dBm	Correct Factor dB	Measure- ment dBm	Limit dBm	Over dB	Antenna Height cm	Table Degree degree	Comment
1	*	3720.375	-54.97	4.88	-50.09	-13.00	-37.09	peak		

*:Maximum data x:Over limit !:over margin

File :HE910(CH9262)

Data :#5

Date: 2011/12/2

Time: 上午 09:55:37

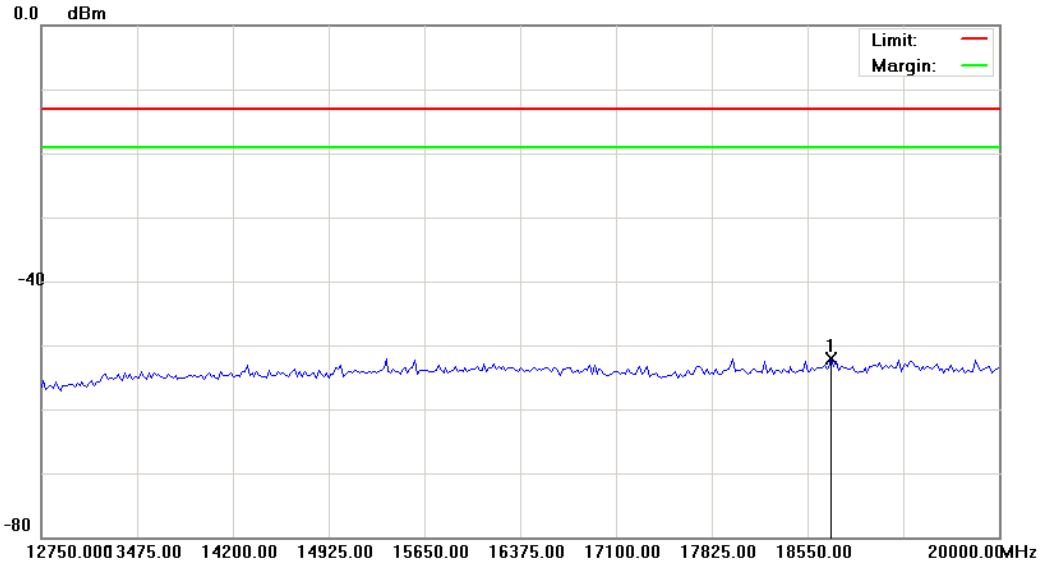

Site : RF Conducted

 Polarization: **Conducted po**

Temperature: 23 °C

Limit: FCC Part 24 conducted(9k-12.75G)

Power: DC 3.8V

Humidity: 55.2 %

EUT: 2G/3G Module

Distance:

RBW: 1000 kHz VBW: 1000 kHz

M/N: HE910

Mode: 3

Note:

No.	Mk.	Freq. MHz	Reading Level dBm	Correct Factor dB	Measure- ment dBm	Limit dBm	Over dB	Antenna Height cm	Table Degree degree	Comment
1	*	18731.250	-59.15	7.08	-52.07	-13.00	-39.07	peak		

*:Maximum data x:Over limit !:over margin

File :HE910(CH9400)

Data :#1

Date: 2011/12/2

Time: 上午 09:41:49

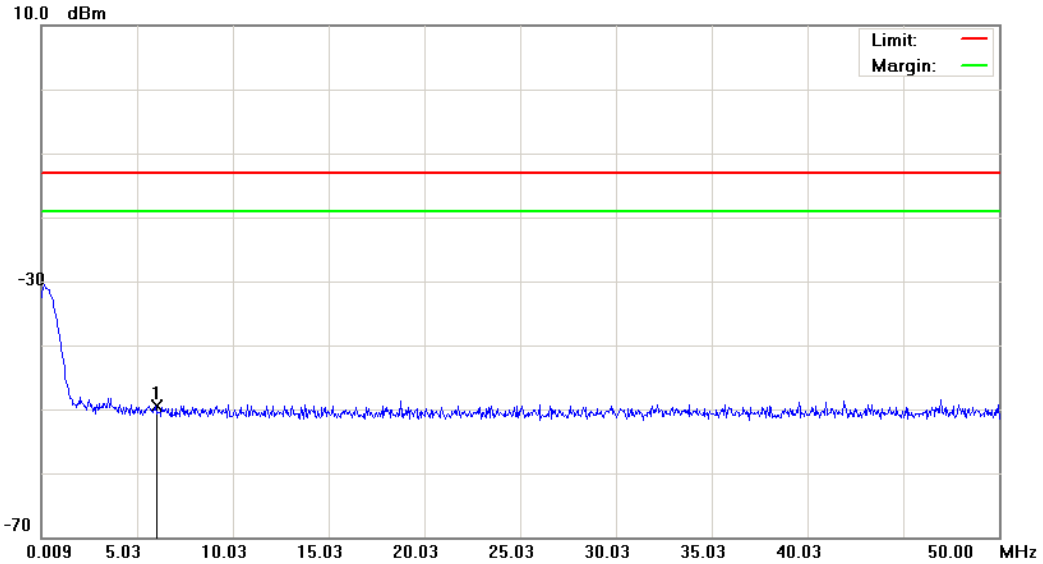

Site : RF Conducted

 Polarization: *Conducted po*

Temperature: 23 °C

Limit: FCC Part 24 conducted(9k-12.75G)

Power: DC 3.8V

Humidity: 55.2 %

EUT: 2G/3G Module

Distance:

RBW: 1000 kHz VBW: 1000 kHz

M/N: HE910

Mode: 3

Note:

No.	Mk.	Freq.	Reading Level	Correct Factor	Measurement	Limit	Over	Antenna Height	Table Degree	
		MHz	dBm	dB	dBm	dBm	dB	cm	degree	Comment
1	*	5.9828	-62.70	13.27	-49.43	-13.00	-36.43			peak

*:Maximum data x:Over limit !:over margin

File :HE910(CH9400)

Data :#2

Date: 2011/12/2

Time: 上午 09:42:13

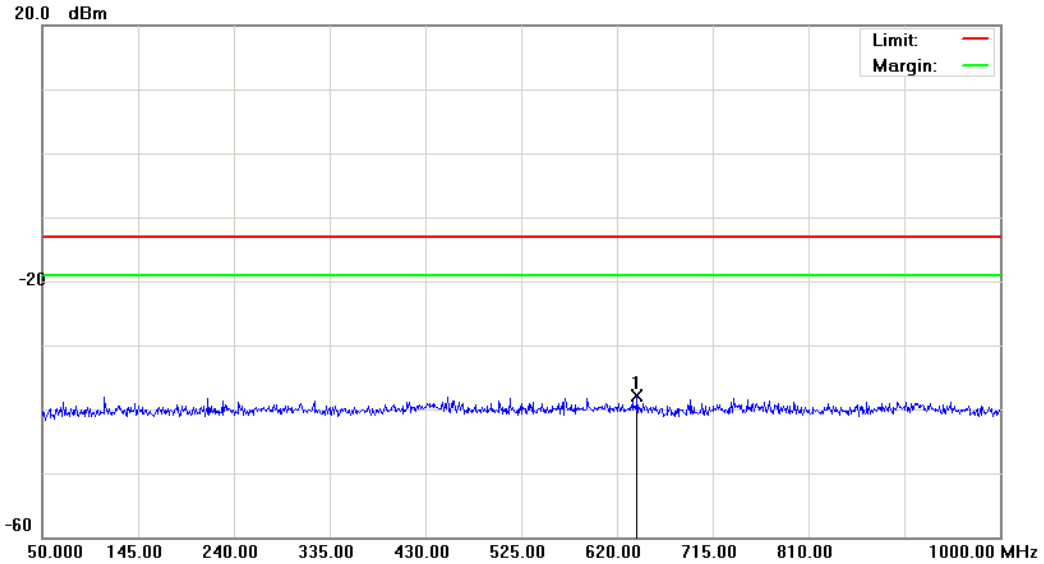

Site: : RF Conducted

 Polarization: **Conducted po**

Temperature: 23 °C

Limit: FCC Part 24 conducted(9k-12.75G)

Power: DC 3.8V

Humidity: 55.2 %

EUT: 2G/3G Module

Distance:

RBW: 1000 kHz VBW: 1000 kHz

M/N: HE910

Mode: 3

Note:

No.	Mk.	Freq.	Reading Level	Correct Factor	Measurement	Limit	Over	Antenna Height	Table Degree
		MHz	dBm	dB	dBm	dBm	dB	cm	degree
1	*	639.9500	-51.09	13.11	-37.98	-13.00	-24.98	peak	

*:Maximum data x:Over limit !:over margin

File :HE910(CH9400)

Data :#3

Date: 2011/12/2

Time: 上午 09:49:14

20.0 dBm

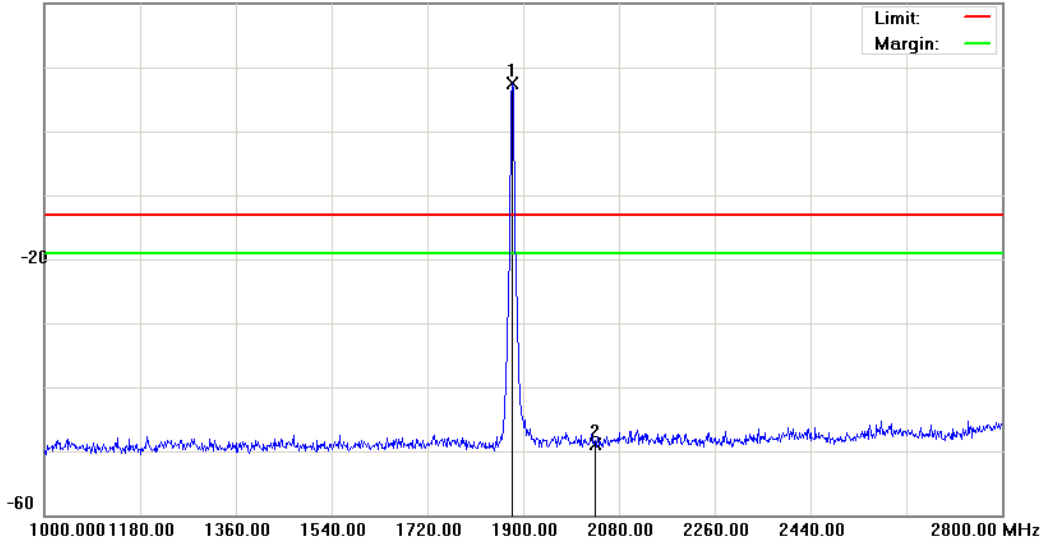

Site : RF Conducted

 Polarization: **Conducted po**

Temperature: 23 °C

Limit: FCC Part 24 conducted(9k-12.75G)

Power: DC 3.8V

Humidity: 55.2 %

EUT: 2G/3G Module

Distance:

RBW: 1000 kHz VBW: 1000 kHz

M/N: HE910

Mode: 3

Note:

No.	Mk.	Freq. MHz	Reading Level dBm	Correct Factor dB	Measure- ment dBm	Limit dBm	Over dB	Detector	Antenna Height cm	Table Degree degree	Comment
1	*	1878.400	2.80	4.61	7.41	-13.00	20.41	peak			Tx
2		2034.100	-53.44	4.48	-48.96	-13.00	-35.96	peak			

*:Maximum data x:Over limit !:over margin

File :HE910(CH9400)

Data :#4

Date: 2011/12/2

Time: 上午 09:56:14

20.0 dBm

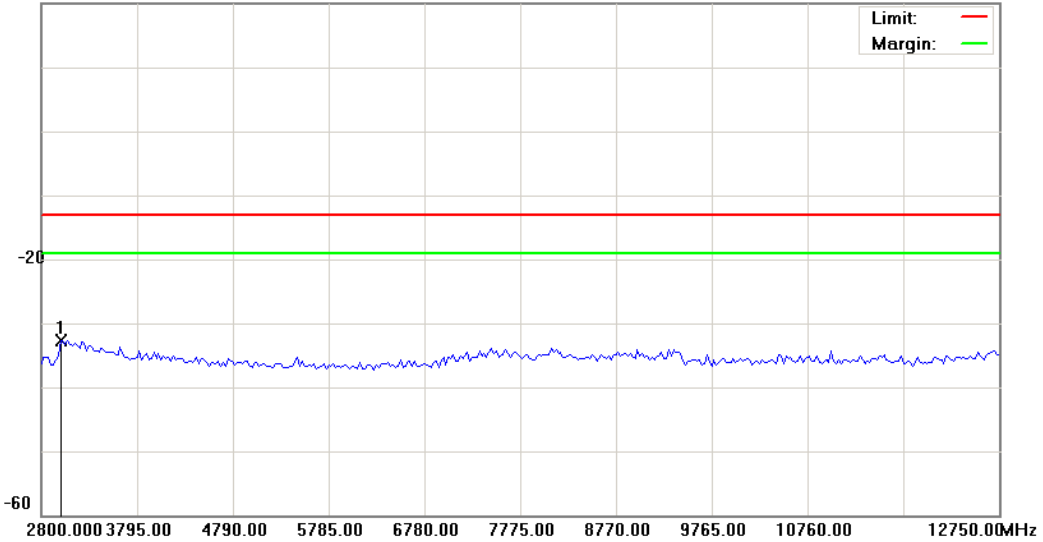

Site: : RF Conducted

 Polarization: **Conducted po**

Temperature: 23 °C

Limit: FCC Part 24 conducted(9k-12.75G)

Power: DC 3.8V

Humidity: 55.2 %

EUT: 2G/3G Module

Distance:

RBW: 1000 kHz VBW: 1000 kHz

M/N: HE910

Mode: 3

Note:

No.	Mk.	Freq. MHz	Reading Level dBm	Correct Factor dB	Measure- ment dBm	Limit dBm	Over dB	Detector	Antenna Height cm	Table Degree degree	Comment
1	*	2999.000	-38.13	5.48	-32.65	-13.00	-19.65	peak			

*:Maximum data x:Over limit !:over margin

File :HE910(CH9400)

Data :#5

Date: 2011/12/2

Time: 上午 09:56:36

20.0 dBm

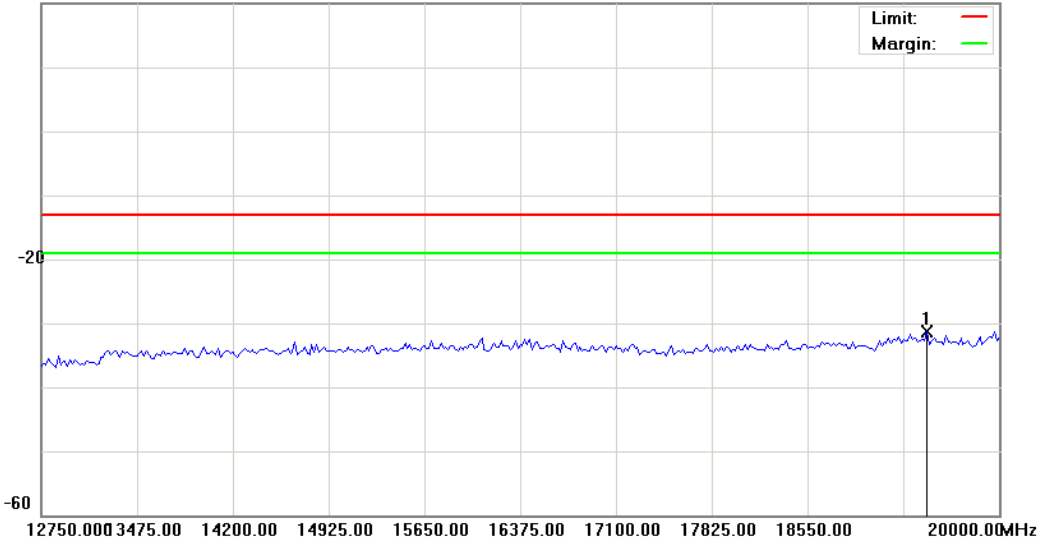

Site: : RF Conducted	Polarization: Conducted po	Temperature: 23 °C
Limit: FCC Part 24 conducted(9k-12.75G)	Power: DC 3.8V	Humidity: 55.2 %
EUT: 2G/3G Module	Distance:	RBW: 1000 kHz VBW: 1000 kHz
M/N: HE910		
Mode: 3		
Note:		

No.	Mk.	Freq. MHz	Reading Level dBm	Correct Factor dB	Measure- ment dBm	Limit dBm	Over dB	Antenna Height cm	Table Degree degree	Comment
1	*	19456.250	-38.52	7.28	-31.24	-13.00	-18.24	peak		

*:Maximum data x:Over limit !:over margin

File :HE910(CH9538)

Data :#1

Date: 2011/12/2

Time: 上午 09:43:35

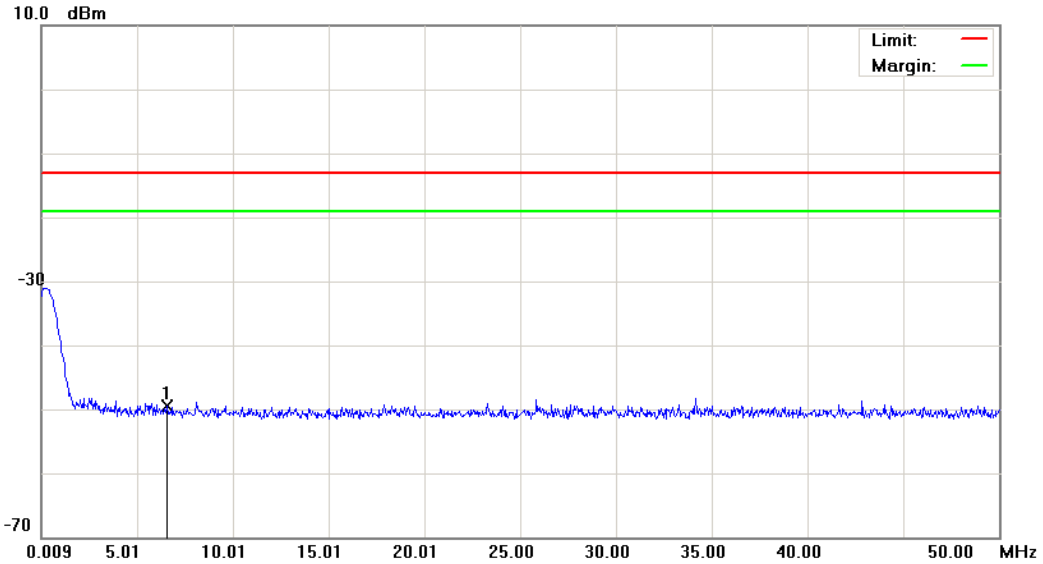

Site : RF Conducted

 Polarization: *Conducted po*

Temperature: 23 °C

Limit: FCC Part 24 conducted(9k-12.75G)

Power: DC 3.8V

Humidity: 55.2 %

EUT: 2G/3G Module

Distance:

RBW: 1000 kHz VBW: 1000 kHz

M/N: HE910

Mode: 3

Note:

No.	Mk.	Freq.	Reading Level	Correct Factor	Measurement	Limit	Over	Antenna Height	Table Degree	
		MHz	dBm	dB	dBm	dBm	dB	cm	degree	Comment
1	*	6.5578	-62.78	13.26	-49.52	-13.00	-36.52	peak		

*:Maximum data x:Over limit !:over margin

File :HE910(CH9538)

Data :#2

Date: 2011/12/2

Time: 上午 09:44:00

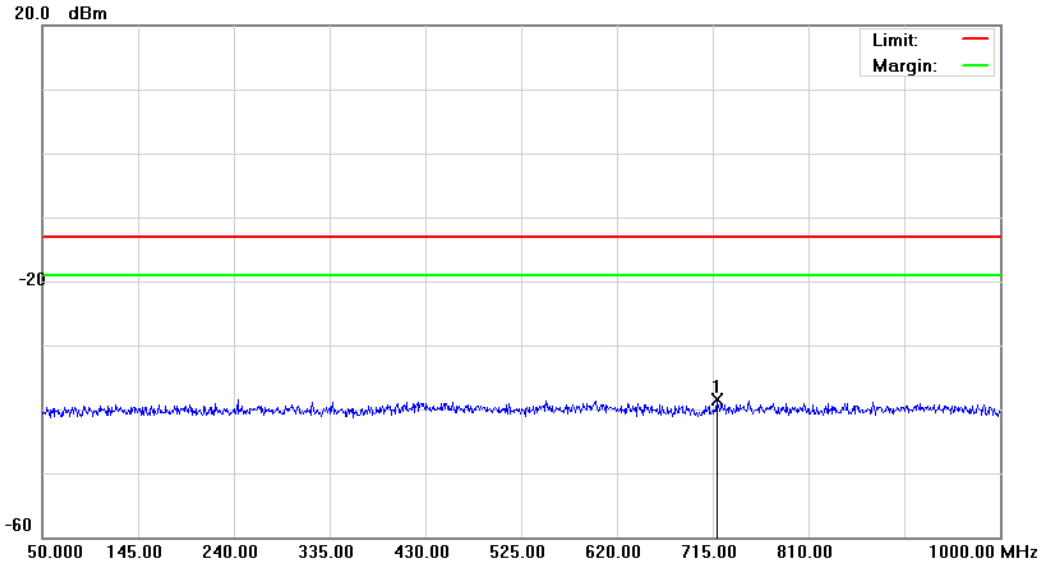

Site : RF Conducted

 Polarization: *Conducted po*

Temperature: 23 °C

Limit: FCC Part 24 conducted(9k-12.75G)

Power: DC 3.8V

Humidity: 55.2 %

EUT: 2G/3G Module

Distance:

RBW: 1000 kHz VBW: 1000 kHz

M/N: HE910

Mode: 3

Note:

No.	Mk.	Freq.	Reading Level	Correct Factor	Measurement	Limit	Over	Antenna Height	Table Degree	
		MHz	dBm	dB	dBm	dBm	dB	cm	degree	Comment
1	*	718.8000	-51.56	13.13	-38.43	-13.00	-25.43			peak

*:Maximum data x:Over limit !:over margin

File :HE910(CH9538)

Data :#3

Date: 2011/12/2

Time: 上午 09:51:03

20.0 dBm

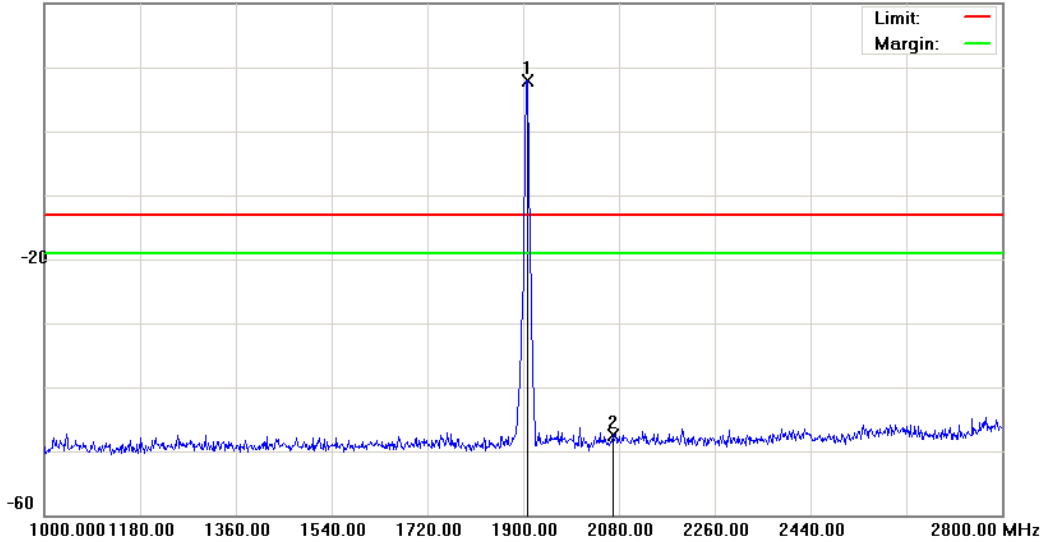

Site : RF Conducted

 Polarization: **Conducted po**

Temperature: 23 °C

Limit: FCC Part 24 conducted(9k-12.75G)

Power: DC 3.8V

Humidity: 55.2 %

EUT: 2G/3G Module

Distance:

RBW: 1000 kHz VBW: 1000 kHz

M/N: HE910

Mode: 3

Note:

No.	Mk.	Freq. MHz	Reading Level dBm	Correct Factor dB	Measure- ment dBm	Limit dBm	Over dB	Detector	Antenna Height cm	Table Degree degree	Comment
1	*	1909.000	2.14	5.80	7.94	-13.00	20.94	peak			Tx
2		2069.200	-51.95	4.41	-47.54	-13.00	-34.54	peak			

*:Maximum data x:Over limit !:over margin

File :HE910(CH9538)

Data :#4

Date: 2011/12/2

Time: 上午 09:57:12

20.0 dBm

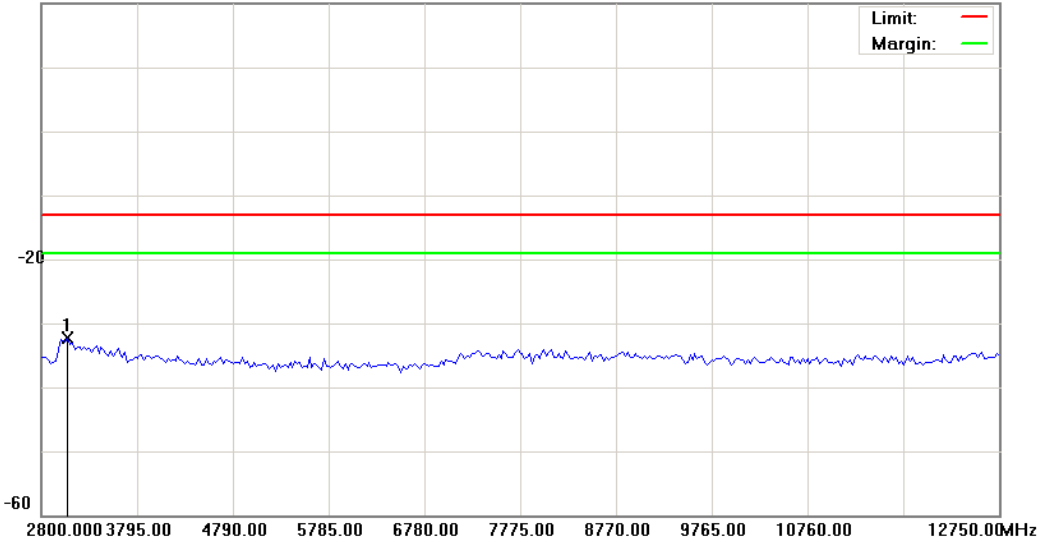

Site: : RF Conducted	Polarization: Conducted po	Temperature: 23 °C
Limit: FCC Part 24 conducted(9k-12.75G)	Power: DC 3.8V	Humidity: 55.2 %
EUT: 2G/3G Module	Distance:	RBW: 1000 kHz VBW: 1000 kHz
M/N: HE910		
Mode: 3		
Note:		

No.	Mk.	Freq. MHz	Reading Level dBm	Correct Factor dB	Measure- ment dBm	Limit dBm	Over dB	Detector	Antenna Height cm	Table Degree degree	Comment
1	*	3073.625	-37.74	5.40	-32.34	-13.00	-19.34	peak			

*:Maximum data x:Over limit !:over margin

File :HE910(CH9538)

Data :#5

Date: 2011/12/2

Time: 上午 09:57:33

20.0 dBm

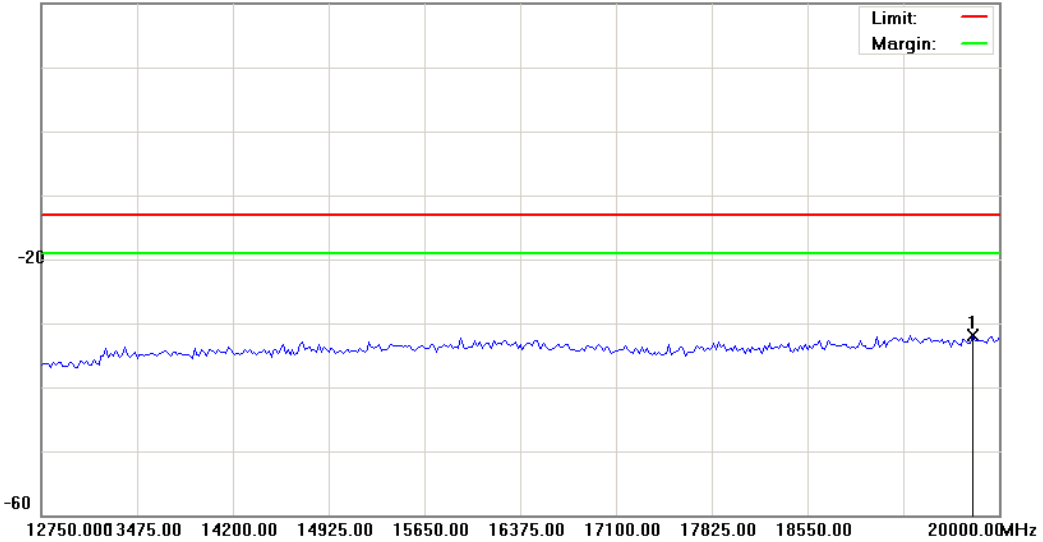

Site: : RF Conducted	Polarization: Conducted po	Temperature: 23 °C
Limit: FCC Part 24 conducted(9k-12.75G)	Power: DC 3.8V	Humidity: 55.2 %
EUT: 2G/3G Module	Distance:	RBW: 1000 kHz VBW: 1000 kHz
M/N: HE910		
Mode: 3		
Note:		

No.	Mk.	Freq. MHz	Reading Level dBm	Correct Factor dB	Measure- ment dBm	Limit dBm	Over dB	Antenna Height cm	Table Degree degree	Comment
1	*	19800.625	-39.21	7.38	-31.83	-13.00	-18.83	peak		

*:Maximum data x:Over limit !:over margin

File :HE910(CH4132)

Data :#1

Date: 2011/12/2

Time: 上午 10:05:45

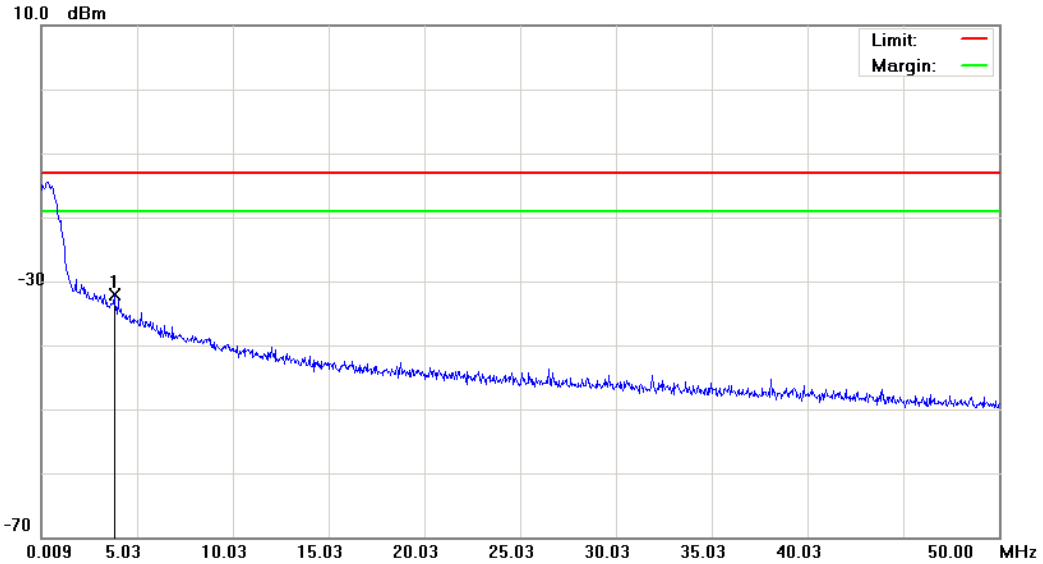

Site : RF Conducted

 Polarization: *Conducted po*

Temperature: 23 °C

Limit: FCC Part 22 conducted(9k-12.75G)

Power: DC 3.8V

Humidity: 55.2 %

EUT: 2G/3G Module

Distance:

RBW: 1000 kHz VBW: 1000 kHz

M/N: HE910

Mode: 4

Note:

No.	Mk.	Freq.	Reading Level	Correct Factor	Measurement	Limit	Over	Antenna Height	Table Degree	
		MHz	dBm	dB	dBm	dBm	dB	cm	degree	Comment
1	*	3.8083	-61.96	29.79	-32.17	-13.00	-19.17			peak

*:Maximum data x:Over limit !:over margin

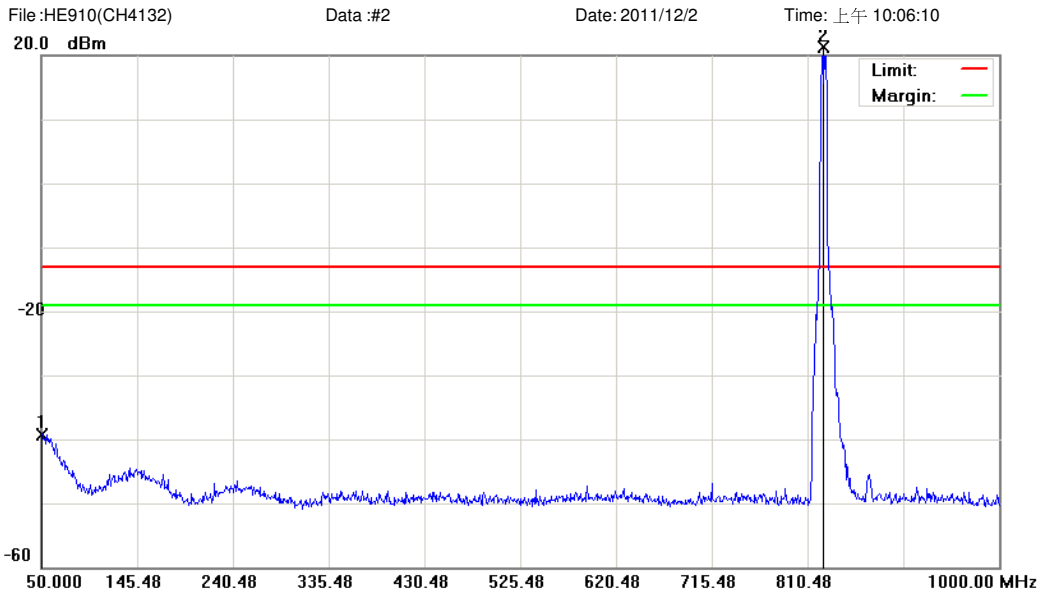

Site: : RF Conducted	Polarization: Conducted po	Temperature: 23 °C
Limit: FCC Part 22 conducted(9k-12.75G)	Power: DC 3.8V	Humidity: 55.2 %
EUT: 2G/3G Module	Distance:	RBW: 1000 kHz VBW: 1000 kHz
M/N: HE910		
Mode: 4		
Note:		

No.	Mk.	Freq. MHz	Reading Level dBm	Correct Factor dB	Measure- ment dBm	Limit dBm	Over dB	Detector	Antenna Height cm	Table Degree degree	Comment
1		50.4750	-53.86	14.61	-39.25	-13.00	-26.25	peak			
2	*	825.2000	17.45	3.84	21.29	-13.00	34.29	peak			Tx

*:Maximum data x:Over limit !:over margin

File :HE910(CH4132)

Data :#3

Date: 2011/12/2

Time: 上午 10:14:30

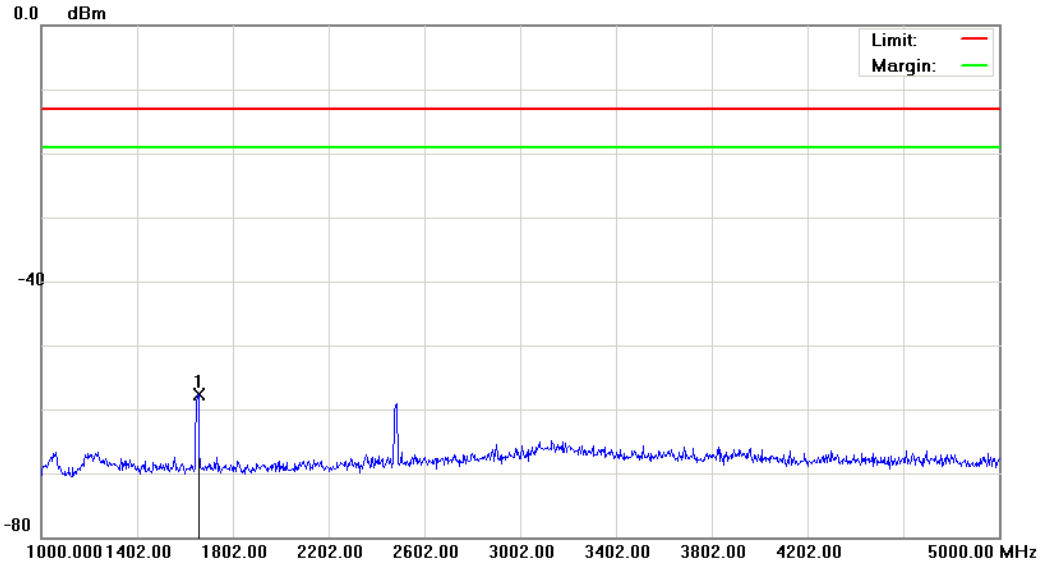

Site : RF Conducted

 Polarization: **Conducted po**

Temperature: 23 °C

Limit: FCC Part 22 conducted(9k-12.75G)

Power: DC 3.8V

Humidity: 55.2 %

EUT: 2G/3G Module

Distance:

RBW: 1000 kHz VBW: 1000 kHz

M/N: HE910

Mode: 4

Note:

No.	Mk.	Freq.	Reading Level	Correct Factor	Measurement	Limit	Over	Antenna Height	Table Degree		
		MHz	dBm	dB	dBm	dBm	dB	cm	degree	Detector	Comment
1	*	1654.000	-62.18	4.45	-57.73	-13.00	-44.73			peak	

*:Maximum data x:Over limit !:over margin

File :HE910(CH4132)

Data :#4

Date: 2011/12/2

Time: 上午 10:14:53

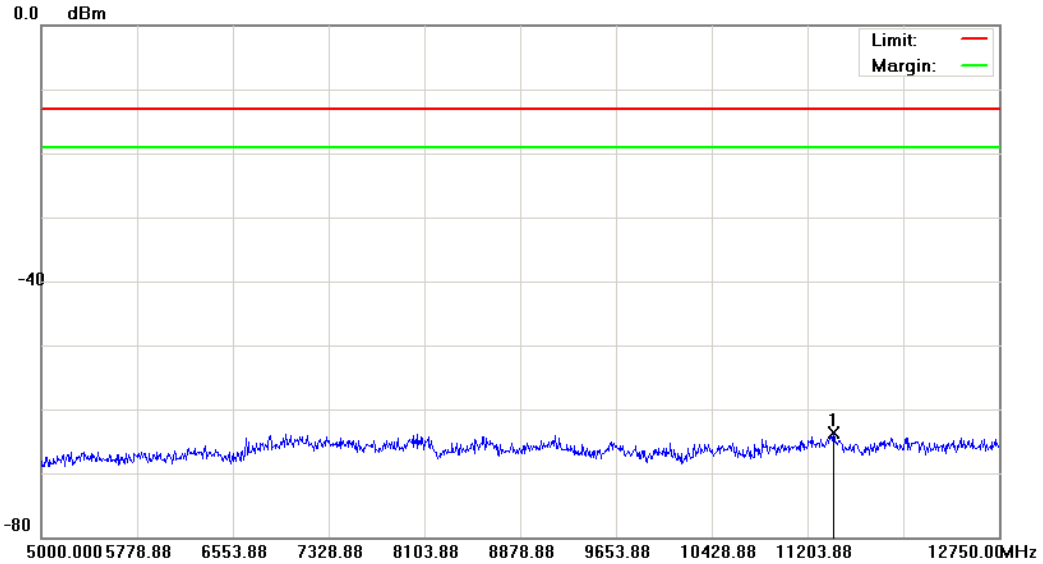

Site : RF Conducted

 Polarization: **Conducted po**

Temperature: 23 °C

Limit: FCC Part 22 conducted(9k-12.75G)

Power: DC 3.8V

Humidity: 55.2 %

EUT: 2G/3G Module

Distance:

RBW: 1000 kHz VBW: 1000 kHz

M/N: HE910

Mode: 4

Note:

No.	Mk.	Freq.	Reading Level	Correct Factor	Measurement	Limit	Over	Antenna Height	Table Degree	
		MHz	dBm	dB	dBm	dBm	dB	cm	degree	Comment
1	*	11409.250	-69.26	5.56	-63.70	-13.00	-50.70	peak		

*:Maximum data x:Over limit !:over margin

File :HE910(CH4183)

Data :#1

Date: 2011/12/2

Time: 上午 10:08:50

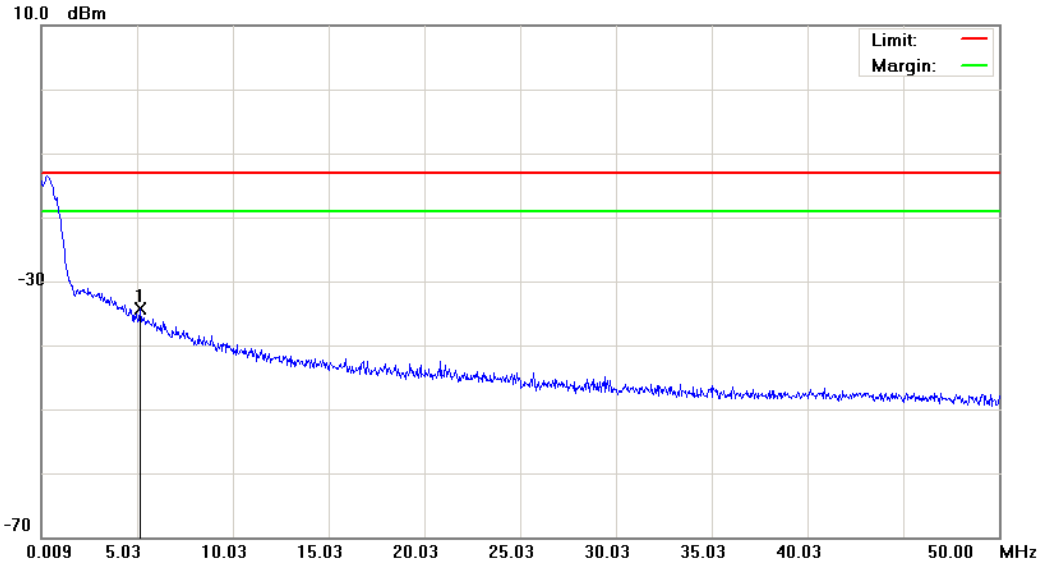

Site : RF Conducted	Polarization: Conducted po	Temperature: 23 °C
Limit: FCC Part 22 conducted(9k-12.75G)	Power: DC 3.8V	Humidity: 55.2 %
EUT: 2G/3G Module	Distance:	RBW: 1000 kHz VBW: 1000 kHz
M/N: HE910		
Mode: 4		
Note:		

No.	Mk.	Freq.	Reading Level	Correct Factor	Measurement	Limit	Over	Antenna Height	Table Degree	
		MHz	dBm	dB	dBm	dBm	dB	cm	degree	Comment
1	*	5.1581	-62.25	27.89	-34.36	-13.00	-21.36			peak

*:Maximum data x:Over limit !:over margin

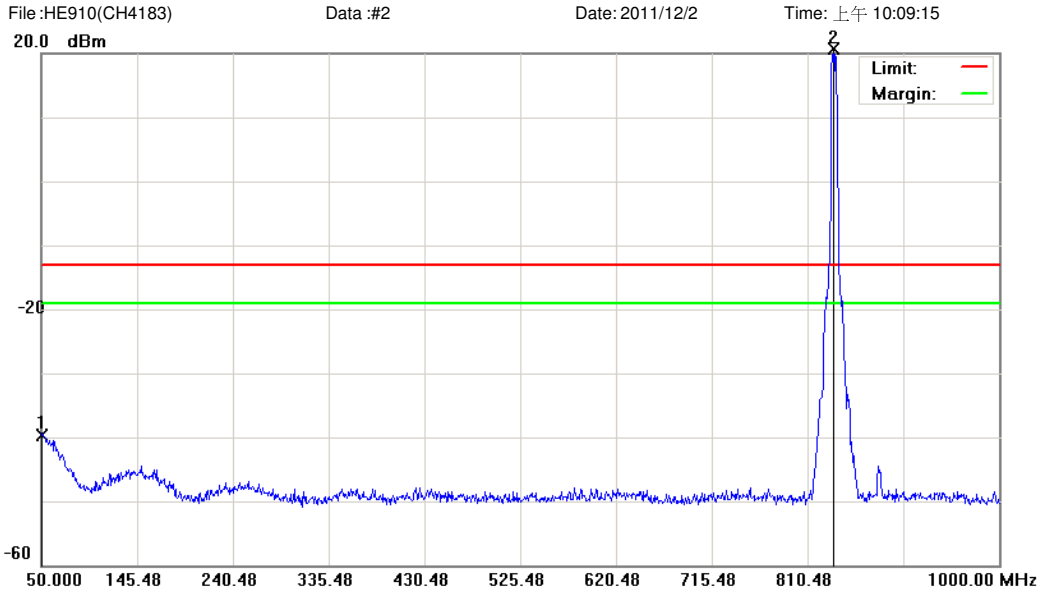

Site: : RF Conducted	Polarization: Conducted po	Temperature: 23 °C
Limit: FCC Part 22 conducted(9k-12.75G)	Power: DC 3.8V	Humidity: 55.2 %
EUT: 2G/3G Module	Distance:	RBW: 1000 kHz VBW: 1000 kHz
M/N: HE910		
Mode: 4		
Note:		

No.	Mk.	Freq. MHz	Reading Level dBm	Correct Factor dB	Measure- ment dBm	Limit dBm	Over dB	Detector	Antenna Height cm	Table Degree degree	Comment
1		50.4750	-54.25	14.61	-39.64	-13.00	-26.64	peak			
2	*	835.6500	16.80	3.95	20.75	-13.00	33.75	peak			Tx

*:Maximum data x:Over limit !:over margin

File :HE910(CH4183)

Data :#3

Date: 2011/12/2

Time: 上午 10:18:22

20.0 dBm

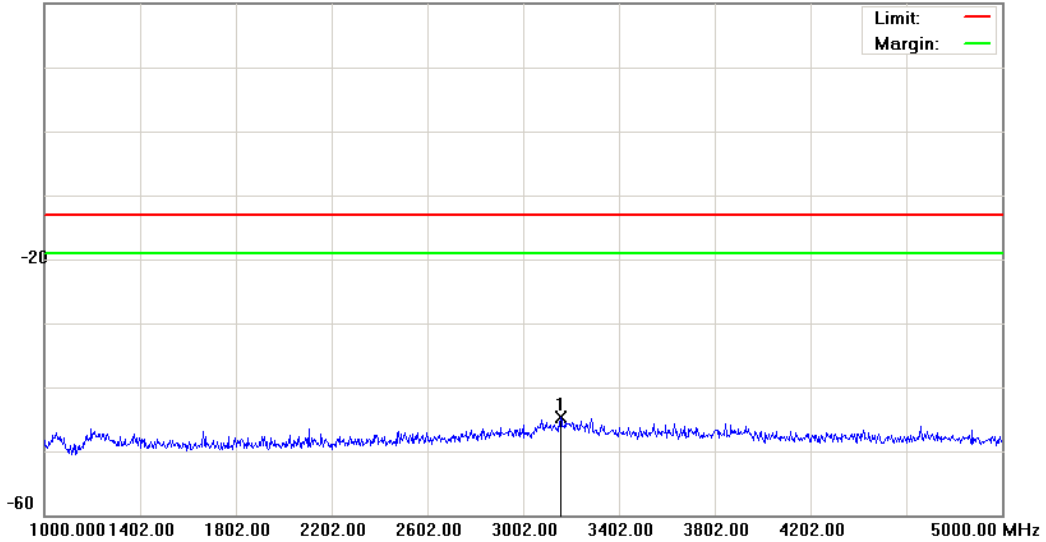

Site : RF Conducted

 Polarization: **Conducted po**

Temperature: 23 °C

Limit: FCC Part 22 conducted(9k-12.75G)

Power: DC 3.8V

Humidity: 55.2 %

EUT: 2G/3G Module

Distance:

RBW: 1000 kHz VBW: 1000 kHz

M/N: HE910

Mode: 4

Note:

No.	Mk.	Freq.	Reading Level	Correct Factor	Measurement	Limit	Over	Antenna Height	Table Degree	
		MHz	dBm	dB	dBm	dBm	dB	cm	degree	Comment
1	*	3156.000	-49.29	4.57	-44.72	-13.00	-31.72			peak

*:Maximum data x:Over limit !:over margin

File: HE910(CH4183)

Data :#4

Date: 2011/12/2

Time: 上午 10:18:45

20.0 dBm

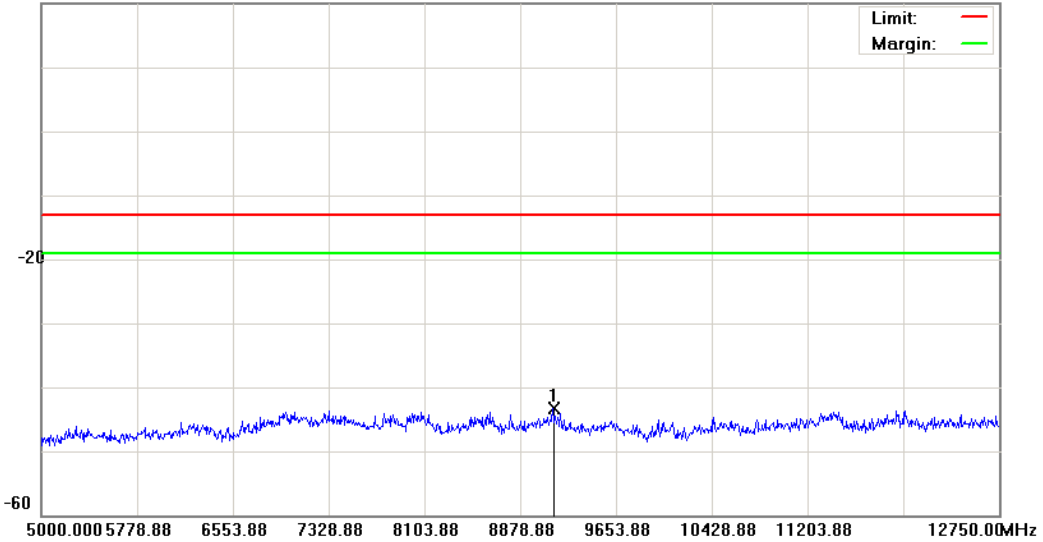

Site: : RF Conducted	Polarization: Conducted po	Temperature: 23 °C
Limit: FCC Part 22 conducted(9k-12.75G)	Power: DC 3.8V	Humidity: 55.2 %
EUT: 2G/3G Module	Distance:	RBW: 1000 kHz VBW: 1000 kHz
M/N: HE910		
Mode: 4		
Note:		

No.	Mk.	Freq.	Reading Level	Correct Factor	Measurement	Limit	Over	Antenna Height	Table Degree	Detector	Comment
		MHz	dBm	dB	dBm	dBm	dB	cm	degree		
1	*	9142.375	-49.20	5.99	-43.21	-13.00	-30.21			peak	

*:Maximum data x:Over limit !:over margin

File :HE910(CH4233)

Data :#1

Date: 2011/12/2

Time: 上午 10:11:54

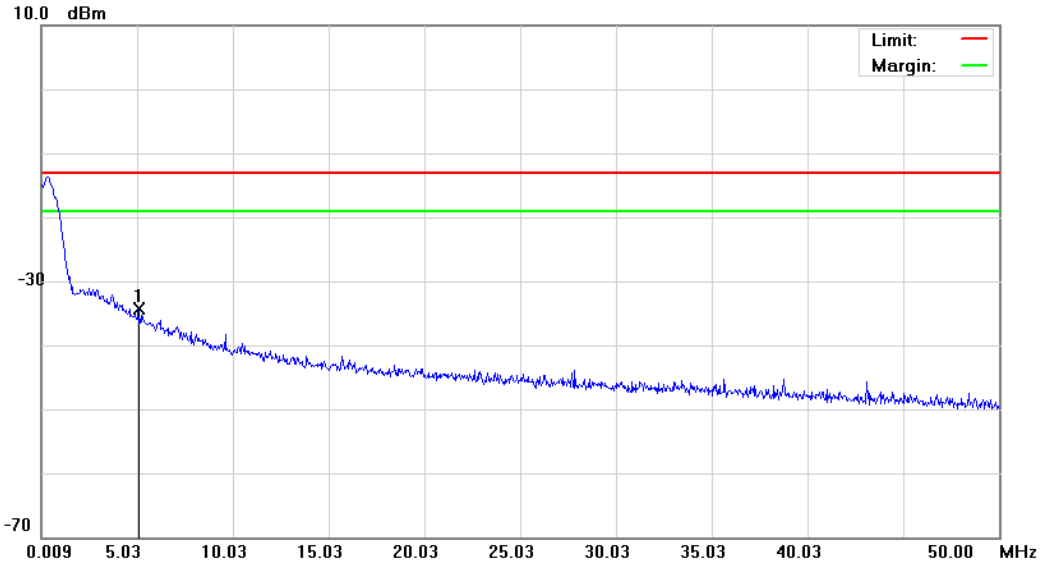

Site : RF Conducted

 Polarization: *Conducted po*

Temperature: 23 °C

Limit: FCC Part 22 conducted(9k-12.75G)

Power: DC 3.8V

Humidity: 55.2 %

EUT: 2G/3G Module

Distance:

RBW: 1000 kHz VBW: 1000 kHz

M/N: HE910

Mode: 4

Note:

No.	Mk.	Freq.	Reading Level	Correct Factor	Measurement	Limit	Over	Antenna Height	Table Degree	
		MHz	dBm	dB	dBm	dBm	dB	cm	degree	Comment
1	*	5.0830	-62.35	27.96	-34.39	-13.00	-21.39			peak

*:Maximum data x:Over limit !:over margin

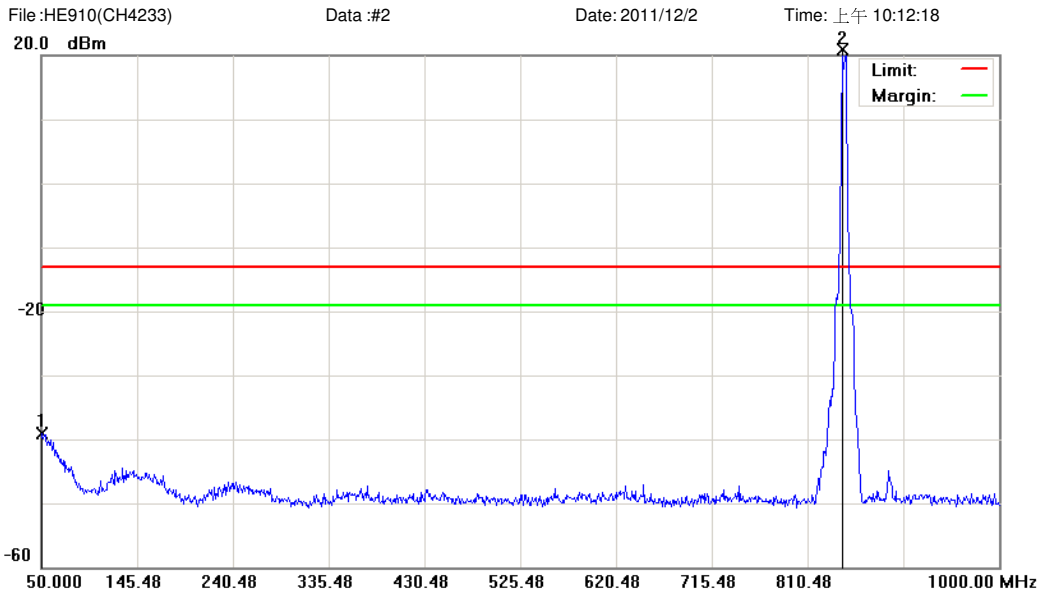

Site: : RF Conducted	Polarization: Conducted po	Temperature: 23 °C
Limit: FCC Part 22 conducted(9k-12.75G)	Power: DC 3.8V	Humidity: 55.2 %
EUT: 2G/3G Module	Distance:	RBW: 1000 kHz VBW: 1000 kHz
M/N: HE910		
Mode: 4		
Note:		

No.	Mk.	Freq. MHz	Reading Level dBm	Correct Factor dB	Measure- ment dBm	Limit dBm	Over dB	Detector	Antenna Height cm	Table Degree degree	Comment
1		50.4750	-53.78	14.61	-39.17	-13.00	-26.17	peak			
2	*	845.1500	16.95	3.99	20.94	-13.00	33.94	peak			Tx

*:Maximum data x:Over limit !:over margin

File :HE910(CH4233)

Data :#3

Date: 2011/12/2

Time: 上午 10:19:50

20.0 dBm

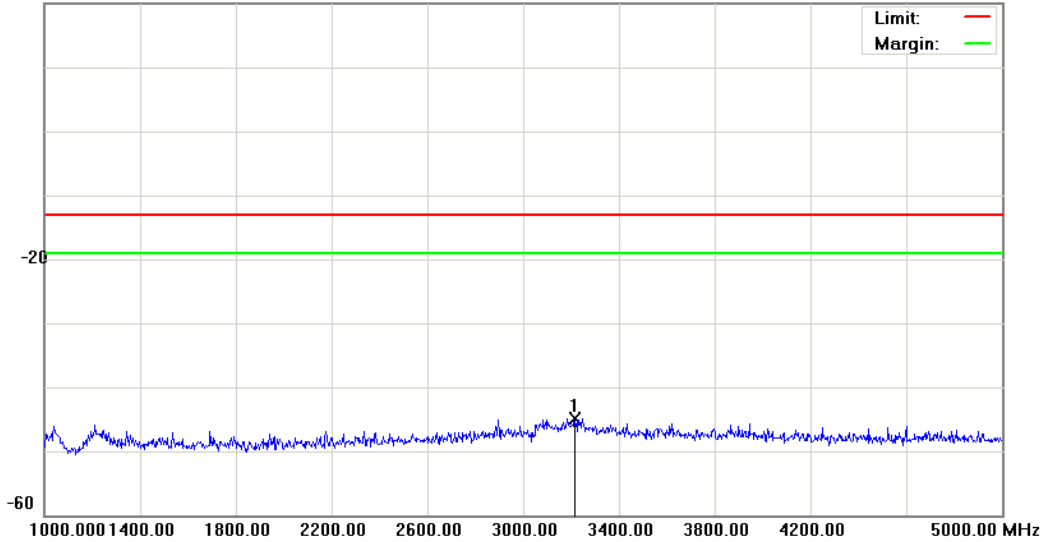

Site : RF Conducted

 Polarization: **Conducted po**

Temperature: 23 °C

Limit: FCC Part 22 conducted(9k-12.75G)

Power: DC 3.8V

Humidity: 55.2 %

EUT: 2G/3G Module

Distance:

RBW: 1000 kHz VBW: 1000 kHz

M/N: HE910

Mode: 4

Note:

No.	Mk.	Freq.	Reading Level	Correct Factor	Measurement	Limit	Over	Antenna Height	Table Degree
		MHz	dBm	dB	dBm	dBm	dB	cm	degree
1	*	3214.000	-49.60	4.67	-44.93	-13.00	-31.93	peak	

*:Maximum data x:Over limit !:over margin

File :HE910(CH4233)

Data :#4

Date: 2011/12/2

Time: 上午 10:20:13

20.0 dBm

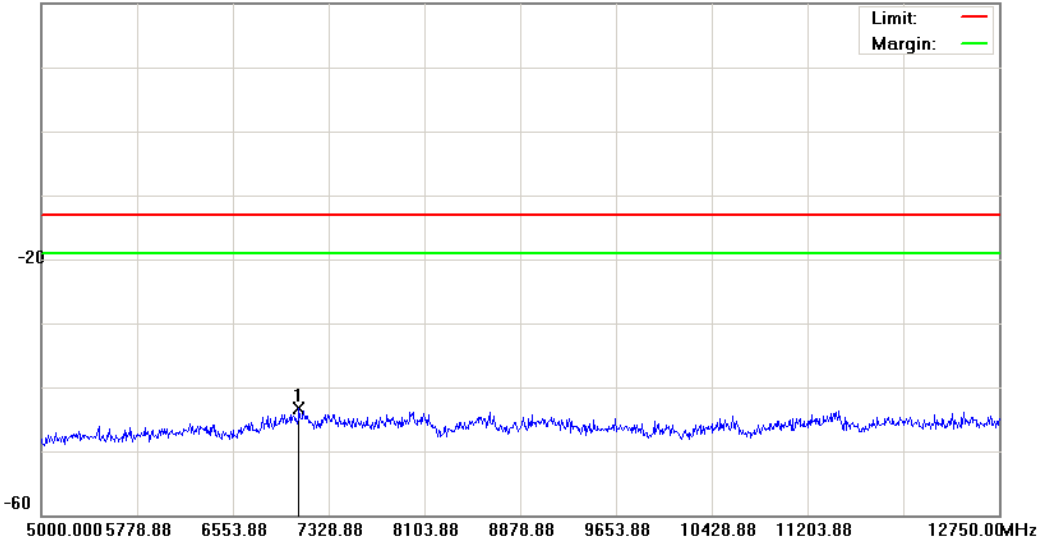

Site : RF Conducted

 Polarization: **Conducted po**

Temperature: 23 °C

Limit: FCC Part 22 conducted(9k-12.75G)

Power: DC 3.8V

Humidity: 55.2 %

EUT: 2G/3G Module

Distance:

RBW: 1000 kHz VBW: 1000 kHz

M/N: HE910

Mode: 4

Note:

No.	Mk.	Freq. MHz	Reading Level dBm	Correct Factor dB	Measure- ment dBm	Limit dBm	Over dB	Antenna Height cm	Table Degree degree	Comment
1	*	7084.750	-48.32	5.00	-43.32	-13.00	-30.32	peak		

*:Maximum data x:Over limit !:over margin

6 Field Strength of Spurious Radiation Test

6.1. Limit

The power of any emission outside of the authorized operating frequency ranges must be attenuated below the transmitting power (P) by a factor of at least $43 + 10\log(P)$ dB.

It is measured by means of a calibrated spectrum analyzer and scanned from 30 MHz up to a frequency including its 10th harmonic.

6.2. Test Instruments

3 Meter Chamber					
Equipment	Manufacturer	Model Number	Serial Number	Cal. Date	Remark
RF Pre-selector	Agilent	N9039A	MY46520256	01/18/2011	(2)
Spectrum Analyzer	Agilent	E4446A	MY46180578	01/18/2011	(1)
Pre Amplifier	Agilent	8449B	3008A02237	02/23/2011	(1)
Pre Amplifier	Agilent	8447D	2944A10961	02/23/2011	(1)
Broadband Antenna (30MHz~1GHz)	SCHWARZBECK MESS-ELEKTRONIK	VULB9163	9163-270	07/29/2011	(1)
Horn Antenna (1~18GHz)	SCHWARZBECK MESS-ELEKTRONIK	BBHA9120D	9120D-550	06/29/2011	(1)
Horn Antenna (18~40GHz)	SCHWARZBECK MESS-ELEKTRONIK	BBHA9170	9170-320	06/28/2011	(1)
Test Site	ATL	TE01	888001	12/24/2010	(1)

Remark: ⁽¹⁾ Calibration period 1 year. ⁽²⁾ Calibration period 2 years.

NOTE: N.C.R. = No Calibration Request.

6.3. Setup

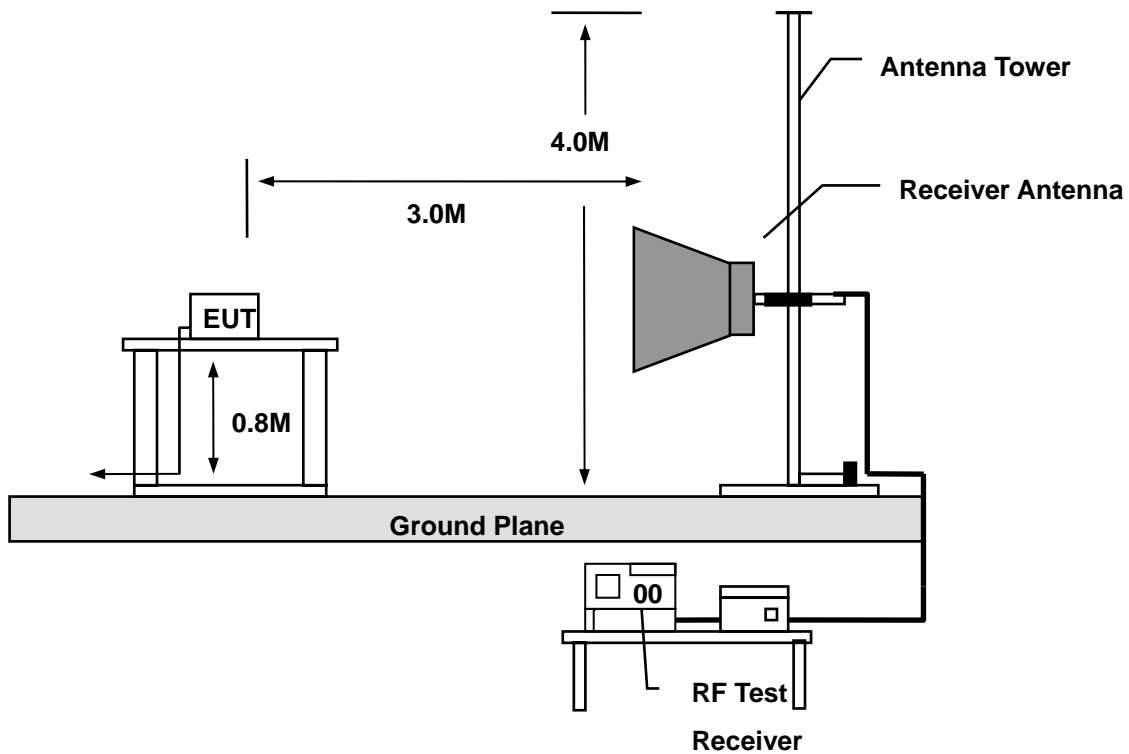

6.4. Test Procedure

Final radiation measurements were made on a three-meter, Semi Anechoic Chamber. The EUT system was placed on a nonconductive turntable which is 0.8 meters height, top surface 1.0 x 1.5 meter. The spectrum was examined from 250 MHz to 2.5 GHz in order to cover the whole spectrum below 10th harmonic which could generate from the EUT. During the test, EUT was set to transmit continuously & Measurements spectrum range from 30 MHz to 26.5 GHz is investigated.

For measurements below 1 GHz the resolution bandwidth is set to 100 kHz for peak detection measurements or 120 kHz for quasi-peak detection measurements. Peak detection is used unless otherwise noted as quasi-peak.

For measurements above 1 GHz the resolution bandwidth is set to 1 MHz, and then the video bandwidth is set to 1 MHz for peak measurements and 10 Hz for average measurements.

A nonconductive material surrounded the EUT to supporting the EUT for standing on three orthogonal planes. At each condition, the EUT was rotated 360 degrees, and the antenna was raised and lowered from one to four meters to find the maximum emission levels. Measurements were taken using both horizontal and vertical antenna polarization.

SCHWARZBECK MESS-ELEKTRONIK Biconilog Antenna (model VULB9163) at 3 Meter and the SCHWARZBECK Double Ridged Guide Antenna (model BBHA9120D&9170) was used in frequencies 1 – 26.5 GHz at a distance of 1 meter. All test results were extrapolated to equivalent signal at 3 meters utilizing an inverse linear distance extrapolation Factor (20dB/decade).

For testing above 1GHz, the emission level of the EUT in peak mode was 20dB lower than average limit (that means the emission level in peak mode also complies with the limit in average mode), then testing will be stopped and peak values of EUT will be reported, otherwise, the emissions will be measured in average mode again and reported.

Appropriate preamplifiers were used for improving sensitivity and precautions were taken to avoid overloading or desensitizing the spectrum analyzer. No post – detector video filters were used in the test.

The spectrum analyzer's 6 dB bandwidth was set to 1 MHz, and the analyzer was operated in the peak detection mode, for frequencies both below and up 1 GHz. The average levels were obtained by subtracting the duty cycle correction factor from the peak readings.

The following procedures were used to convert the emission levels measured in decibels referenced to 1 microvolt (dBuV) into field intensity in micro volts per meter (uV/m).

The actual field intensity in decibels referenced to 1 microvolt in to field intensity in micro volts per meter (dBuV/m).

The actual field intensity in decibels referenced to 1 microvolt per meter (dBuV/m) is determined by algebraically adding the measured reading in dBuV, the antenna factor (dB), and cable loss (dB) and Subtracting the gain of preamplifier (dB) is auto calculate in spectrum analyzer.

$$(1) \text{ Amplitude (dBuV/m) = FI (dBuV) +AF (dBuV) +CL (dBuV)-Gain (dB)}$$

FI= Reading of the field intensity.

AF= Antenna factor.

CL= Cable loss.

P.S Amplitude is auto calculate in spectrum analyzer.

$$(2) \text{ Actual Amplitude (dBuV/m) = Amplitude (dBuV)-Dis(dB)}$$

The FCC specified emission limits were calculated according the EUT operating frequency and by following linear interpolation equations:

(a) For fundamental frequency : Transmitter Output < +30dBm

(b) For spurious frequency : Spurious emission limits = fundamental emission limit /10

6.5. Uncertainty

The measurement uncertainty is defined as for Field Strength of Spurious Radiation measurement is ± 3.072 dB.

6.6. Test Result

Standard:	FCC Part 22	Test Distance:	3m
Test item:	Radiated Emission	Power:	DC 3.8V
Model:	HE910	Temp.(°C)/Hum.(%RH):	26(°C)/60%RH
Mode:	Mode 1	Date:	2011/12/06
Frequency:	824.2 MHz	Test By:	Fly Lu

No.	Frequency (MHz)	Reading (dBm)	Correct Factor(dB)	Result (dBm)	Limit (dBm)	Margin (dB)	Remark	Ant.Polar. H / V
1	45.0000	-50.63	8.77	-41.86	-13.00	-28.86	peak	H
2	84.5000	-79.80	-1.89	-81.69	-13.00	-68.69	peak	H
3	199.5000	-70.78	2.50	-68.28	-13.00	-55.28	peak	H
4	291.5000	-62.68	-3.19	-65.87	-13.00	-52.87	peak	H
5	497.5000	-78.64	6.82	-71.82	-13.00	-58.82	peak	H
6	684.5000	-79.38	7.01	-72.37	-13.00	-59.37	peak	H
7	5428.000	-71.26	21.47	-49.79	-13.00	-36.79	peak	H
8	7708.000	-70.79	29.36	-41.43	-13.00	-28.43	peak	H
9	11080.000	-72.83	36.50	-36.33	-13.00	-23.33	peak	H
1	45.0000	-57.68	-6.91	-64.59	-13.00	-51.59	peak	V
2	92.5000	-64.58	-4.73	-69.31	-13.00	-56.31	peak	V
3	137.5000	-79.79	10.31	-69.48	-13.00	-56.48	peak	V
4	251.0000	-80.18	-0.98	-81.16	-13.00	-68.16	peak	V
5	448.5000	-81.08	1.56	-79.52	-13.00	-66.52	peak	V
6	716.0000	-80.45	10.72	-69.73	-13.00	-56.73	peak	V
7	2836.000	-67.71	15.08	-52.63	-13.00	-39.63	peak	V
8	6184.000	-71.80	23.54	-48.26	-13.00	-35.26	peak	V
9	9940.000	-73.17	30.27	-42.90	-13.00	-29.90	peak	V

Standard:	FCC Part 22	Test Distance:	3m
Test item:	Radiated Emission	Power:	DC 3.8V
Model:	HE910	Temp.(°C)/Hum.(%RH):	26(°C)/60%RH
Mode:	Mode 1	Date:	2011/12/06
Frequency:	836.4 MHz	Test By:	Fly Lu

No.	Frequency (MHz)	Reading (dBm)	Correct Factor(dB)	Result (dBm)	Limit (dBm)	Margin (dB)	Remark	Ant.Polar. H / V
1	45.0000	-63.69	8.77	-54.92	-13.00	-41.92	peak	H
2	92.5000	-65.18	-0.43	-65.61	-13.00	-52.61	peak	H
3	324.5000	-72.85	-0.84	-73.69	-13.00	-60.69	peak	H
4	529.0000	-80.44	7.94	-72.50	-13.00	-59.50	peak	H
5	860.0000	-80.98	13.02	-67.96	-13.00	-54.96	peak	H
6	932.5000	-81.25	14.81	-66.44	-13.00	-53.44	peak	H
7	4540.000	-69.57	17.30	-52.27	-13.00	-39.27	peak	H
8	6220.000	-70.96	24.41	-46.55	-13.00	-33.55	peak	H
9	8572.000	-72.13	28.40	-43.73	-13.00	-30.73	peak	H
1	45.0000	-55.03	-6.91	-61.94	-13.00	-48.94	peak	V
2	133.5000	-80.02	12.47	-67.55	-13.00	-54.55	peak	V
3	201.0000	-76.85	10.04	-66.81	-13.00	-53.81	peak	V
4	289.5000	-71.29	1.77	-69.52	-13.00	-56.52	peak	V
5	524.0000	-76.25	3.34	-72.91	-13.00	-59.91	peak	V
6	744.0000	-74.92	10.59	-64.33	-13.00	-51.33	peak	V
7	3112.000	-68.08	17.11	-50.97	-13.00	-37.97	peak	V
8	7084.000	-70.53	25.66	-44.87	-13.00	-31.87	peak	V
9	11608.000	-73.66	38.26	-35.40	-13.00	-22.40	peak	V

Standard:	FCC Part 22	Test Distance:	3m
Test item:	Radiated Emission	Power:	DC 3.8V
Model:	HE910	Temp.(°C)/Hum.(%RH):	26(°C)/60%RH
Mode:	Mode 1	Date:	2011/12/06
Frequency:	848.8 MHz	Test By:	Fly Lu

No.	Frequency (MHz)	Reading (dBm)	Correct Factor(dB)	Result (dBm)	Limit (dBm)	Margin (dB)	Remark	Ant.Polar. H / V
1	92.5000	-64.54	-0.43	-64.97	-13.00	-51.97	peak	H
2	181.0000	-72.68	-6.76	-79.44	-13.00	-66.44	peak	H
3	216.0000	-73.76	-0.05	-73.81	-13.00	-60.81	peak	H
4	357.0000	-75.98	-0.04	-76.02	-13.00	-63.02	peak	H
5	545.0000	-72.46	8.15	-64.31	-13.00	-51.31	peak	H
6	756.0000	-74.13	8.91	-65.22	-13.00	-52.22	peak	H
7	4960.000	-70.77	19.85	-50.92	-13.00	-37.92	peak	H
8	7672.000	-71.66	29.35	-42.31	-13.00	-29.31	peak	H
9	9820.000	-73.70	31.61	-42.09	-13.00	-29.09	peak	H
1	130.5000	-79.54	14.10	-65.44	-13.00	-52.44	peak	V
2	302.0000	-70.17	2.55	-67.62	-13.00	-54.62	peak	V
3	493.5000	-80.54	2.63	-77.91	-13.00	-64.91	peak	V
4	662.5000	-80.79	9.41	-71.38	-13.00	-58.38	peak	V
5	756.0000	-73.44	10.86	-62.58	-13.00	-49.58	peak	V
6	804.0000	-69.94	11.76	-58.18	-13.00	-45.18	peak	V
7	4816.000	-69.79	22.98	-46.81	-13.00	-33.81	peak	V
8	9472.000	-72.43	28.25	-44.18	-13.00	-31.18	peak	V
9	11032.000	-74.04	36.76	-37.28	-13.00	-24.28	peak	V

Standard:	FCC Part 24	Test Distance:	3m
Test item:	Radiated Emission	Power:	DC 3.8V
Model:	HE910	Temp.(°C)/Hum.(%RH):	26(°C)/60%RH
Mode:	Mode 2	Date:	2011/12/06
Frequency:	1850.2 MHz	Test By:	Fly Lu

No.	Frequency (MHz)	Reading (dBm)	Correct Factor(dB)	Result (dBm)	Limit (dBm)	Margin (dB)	Remark	Ant.Polar. H / V
1	92.5000	-63.86	-0.43	-64.29	-13.00	-51.29	peak	H
2	162.5000	-76.89	-0.48	-77.37	-13.00	-64.37	peak	H
3	198.5000	-70.02	1.56	-68.46	-13.00	-55.46	peak	H
4	390.0000	-78.58	1.66	-76.92	-13.00	-63.92	peak	H
5	754.5000	-80.28	8.85	-71.43	-13.00	-58.43	peak	H
6	898.0000	-80.60	13.97	-66.63	-13.00	-53.63	peak	H
7	4660.000	-69.98	18.03	-51.95	-13.00	-38.95	peak	H
8	7144.000	-71.16	28.04	-43.12	-13.00	-30.12	peak	H
9	10240.000	-73.89	33.20	-40.69	-13.00	-27.69	peak	H
1	60.5000	-79.01	-5.27	-84.28	-13.00	-71.28	peak	V
2	130.5000	-81.04	14.10	-66.94	-13.00	-53.94	peak	V
3	160.0000	-81.97	12.68	-69.29	-13.00	-56.29	peak	V
4	280.0000	-78.83	0.91	-77.92	-13.00	-64.92	peak	V
5	579.5000	-80.50	5.89	-74.61	-13.00	-61.61	peak	V
6	805.0000	-80.57	11.72	-68.85	-13.00	-55.85	peak	V
7	4108.000	-68.90	20.94	-47.96	-13.00	-34.96	peak	V
8	5536.000	-71.46	23.44	-48.02	-13.00	-35.02	peak	V
9	9376.000	-72.23	27.42	-44.81	-13.00	-31.81	peak	V

Standard:	FCC Part 24	Test Distance:	3m
Test item:	Radiated Emission	Power:	DC 3.8V
Model:	HE910	Temp.(°C)/Hum.(%RH):	26(°C)/60%RH
Mode:	Mode 2	Date:	2011/12/06
Frequency:	1880.0 MHz	Test By:	Fly Lu

No.	Frequency (MHz)	Reading (dBm)	Correct Factor(dB)	Result (dBm)	Limit (dBm)	Margin (dB)	Remark	Ant.Polar. H / V
1	37.0000	-75.58	8.74	-66.84	-13.00	-53.84	peak	H
2	159.0000	-80.63	1.13	-79.50	-13.00	-66.50	peak	H
3	239.0000	-79.30	-1.97	-81.27	-13.00	-68.27	peak	H
4	427.0000	-80.75	3.59	-77.16	-13.00	-64.16	peak	H
5	600.5000	-79.47	7.93	-71.54	-13.00	-58.54	peak	H
6	813.0000	-80.84	11.68	-69.16	-13.00	-56.16	peak	H
7	4492.000	-69.86	17.04	-52.82	-13.00	-39.82	peak	H
8	7504.000	-71.70	29.20	-42.50	-13.00	-29.50	peak	H
9	11176.000	-74.12	36.58	-37.54	-13.00	-24.54	peak	H
1	132.0000	-80.86	13.29	-67.57	-13.00	-54.57	peak	V
2	160.5000	-78.93	12.20	-66.73	-13.00	-53.73	peak	V
3	213.5000	-80.68	7.67	-73.01	-13.00	-60.01	peak	V
4	287.5000	-77.34	1.58	-75.76	-13.00	-62.76	peak	V
5	476.5000	-78.47	2.26	-76.21	-13.00	-63.21	peak	V
6	775.0000	-79.89	11.20	-68.69	-13.00	-55.69	peak	V
7	4468.000	-70.10	22.08	-48.02	-13.00	-35.02	peak	V
8	7024.000	-71.37	25.54	-45.83	-13.00	-32.83	peak	V
9	9448.000	-73.32	28.06	-45.26	-13.00	-32.26	peak	V

Standard:	FCC Part 24	Test Distance:	3m
Test item:	Radiated Emission	Power:	DC 3.8V
Model:	HE910	Temp.(°C)/Hum.(%RH):	26(°C)/60%RH
Mode:	Mode 2	Date:	2011/12/06
Frequency:	1909.8 MHz	Test By:	Fly Lu

No.	Frequency (MHz)	Reading (dBm)	Correct Factor(dB)	Result (dBm)	Limit (dBm)	Margin (dB)	Remark	Ant.Polar. H / V
1	37.0000	-75.28	8.74	-66.54	-13.00	-53.54	peak	H
2	198.0000	-72.54	1.11	-71.43	-13.00	-58.43	peak	H
3	374.5000	-79.54	0.57	-78.97	-13.00	-65.97	peak	H
4	613.0000	-79.38	7.78	-71.60	-13.00	-58.60	peak	H
5	820.5000	-79.85	11.92	-67.93	-13.00	-54.93	peak	H
6	931.5000	-81.08	14.81	-66.27	-13.00	-53.27	peak	H
7	4036.000	-69.03	16.49	-52.54	-13.00	-39.54	peak	H
8	6472.000	-71.86	25.98	-45.88	-13.00	-32.88	peak	H
9	10108.000	-72.63	32.75	-39.88	-13.00	-26.88	peak	H
1	92.5000	-63.58	-4.73	-68.31	-13.00	-55.31	peak	V
2	131.0000	-79.99	13.83	-66.16	-13.00	-53.16	peak	V
3	160.0000	-81.24	12.68	-68.56	-13.00	-55.56	peak	V
4	201.0000	-78.30	10.04	-68.26	-13.00	-55.26	peak	V
5	218.0000	-81.47	6.02	-75.45	-13.00	-62.45	peak	V
6	390.0000	-74.07	1.49	-72.58	-13.00	-59.58	peak	V
7	4816.000	-70.89	22.98	-47.91	-13.00	-34.91	peak	V
8	8452.000	-72.04	26.11	-45.93	-13.00	-32.93	peak	V
9	9820.000	-72.96	29.79	-43.17	-13.00	-30.17	peak	V

Standard:	FCC Part 24	Test Distance:	3m
Test item:	Radiated Emission	Power:	DC 3.8V
Model:	HE910	Temp.(°C)/Hum.(%RH):	26(°C)/60%RH
Mode:	Mode 3	Date:	2011/12/06
Frequency:	1852.4 MHz	Test By:	Fly Lu

No.	Frequency (MHz)	Reading (dBm)	Correct Factor(dB)	Result (dBm)	Limit (dBm)	Margin (dB)	Remark	Ant.Polar. H / V
1	41.0000	-79.97	9.47	-70.50	-13.00	-57.50	peak	H
2	238.0000	-79.01	-1.85	-80.86	-13.00	-67.86	peak	H
3	287.5000	-74.60	-3.60	-78.20	-13.00	-65.20	peak	H
4	514.5000	-80.07	7.47	-72.60	-13.00	-59.60	peak	H
5	773.0000	-80.78	9.81	-70.97	-13.00	-57.97	peak	H
6	930.5000	-80.58	14.81	-65.77	-13.00	-52.77	peak	H
7	4912.000	-70.08	19.57	-50.51	-13.00	-37.51	peak	H
8	8332.000	-71.50	29.05	-42.45	-13.00	-29.45	peak	H
9	10348.000	-72.66	33.56	-39.10	-13.00	-26.10	peak	H
1	201.0000	-76.49	10.04	-66.45	-13.00	-53.45	peak	V
2	284.5000	-76.29	1.31	-74.98	-13.00	-61.98	peak	V
3	488.5000	-79.41	2.54	-76.87	-13.00	-63.87	peak	V
4	624.0000	-79.05	8.83	-70.22	-13.00	-57.22	peak	V
5	751.5000	-64.52	10.76	-53.76	-13.00	-40.76	peak	V
6	872.0000	-80.16	11.18	-68.98	-13.00	-55.98	peak	V
7	3772.000	-68.86	20.10	-48.76	-13.00	-35.76	peak	V
8	7636.000	-71.83	26.46	-45.37	-13.00	-32.37	peak	V
9	10444.000	-73.87	32.93	-40.94	-13.00	-27.94	peak	V

Standard:	FCC Part 24	Test Distance:	3m
Test item:	Radiated Emission	Power:	DC 3.8V
Model:	HE910	Temp.(°C)/Hum.(%RH):	26(°C)/60%RH
Mode:	Mode 3	Date:	2011/12/06
Frequency:	1880.0 MHz	Test By:	Fly Lu

No.	Frequency (MHz)	Reading (dBm)	Correct Factor(dB)	Result (dBm)	Limit (dBm)	Margin (dB)	Remark	Ant.Polar. H / V
1	41.0000	-80.03	9.47	-70.56	-13.00	-57.56	peak	H
2	200.0000	-73.43	2.95	-70.48	-13.00	-57.48	peak	H
3	289.0000	-74.76	-3.45	-78.21	-13.00	-65.21	peak	H
4	542.0000	-79.59	8.22	-71.37	-13.00	-58.37	peak	H
5	685.0000	-80.26	7.02	-73.24	-13.00	-60.24	peak	H
6	780.0000	-77.93	10.19	-67.74	-13.00	-54.74	peak	H
7	5632.000	-71.06	22.05	-49.01	-13.00	-36.01	peak	H
8	8020.000	-71.67	29.57	-42.10	-13.00	-29.10	peak	H
9	9496.000	-72.90	30.17	-42.73	-13.00	-29.73	peak	H
1	92.5000	-63.89	-4.73	-68.62	-13.00	-55.62	peak	V
2	160.0000	-80.42	12.68	-67.74	-13.00	-54.74	peak	V
3	228.0000	-81.50	2.82	-78.68	-13.00	-65.68	peak	V
4	390.0000	-72.70	1.49	-71.21	-13.00	-58.21	peak	V
5	571.0000	-79.60	5.22	-74.38	-13.00	-61.38	peak	V
6	768.0000	-79.96	11.09	-68.87	-13.00	-55.87	peak	V
7	5260.000	-70.47	23.47	-47.00	-13.00	-34.00	peak	V
8	8440.000	-71.73	26.11	-45.62	-13.00	-32.62	peak	V
9	11380.000	-72.98	37.74	-35.24	-13.00	-22.24	peak	V

Standard:	FCC Part 24	Test Distance:	3m
Test item:	Radiated Emission	Power:	DC 3.8V
Model:	HE910	Temp.(°C)/Hum.(%RH):	26(°C)/60%RH
Mode:	Mode 3	Date:	2011/12/06
Frequency:	1907.6 MHz	Test By:	Fly Lu

No.	Frequency (MHz)	Reading (dBm)	Correct Factor(dB)	Result (dBm)	Limit (dBm)	Margin (dB)	Remark	Ant.Polar. H / V
1	37.0000	-76.08	8.74	-67.34	-13.00	-54.34	peak	H
2	155.5000	-77.12	0.01	-77.11	-13.00	-64.11	peak	H
3	201.5000	-74.25	2.61	-71.64	-13.00	-58.64	peak	H
4	430.5000	-80.26	3.68	-76.58	-13.00	-63.58	peak	H
5	611.0000	-80.14	7.80	-72.34	-13.00	-59.34	peak	H
6	773.0000	-80.79	9.81	-70.98	-13.00	-57.98	peak	H
7	6628.000	-70.90	26.51	-44.39	-13.00	-31.39	peak	H
8	8632.000	-71.64	28.09	-43.55	-13.00	-30.55	peak	H
9	10756.000	-73.46	35.29	-38.17	-13.00	-25.17	peak	H
1	130.5000	-81.04	14.10	-66.94	-13.00	-53.94	peak	V
2	200.0000	-79.20	10.15	-69.05	-13.00	-56.05	peak	V
3	444.0000	-79.70	1.50	-78.20	-13.00	-65.20	peak	V
4	539.5000	-78.82	4.23	-74.59	-13.00	-61.59	peak	V
5	780.0000	-77.79	11.28	-66.51	-13.00	-53.51	peak	V
6	942.5000	-81.03	12.69	-68.34	-13.00	-55.34	peak	V
7	4576.000	-70.53	22.37	-48.16	-13.00	-35.16	peak	V
8	7876.000	-70.35	26.39	-43.96	-13.00	-30.96	peak	V
9	10408.000	-73.31	32.73	-40.58	-13.00	-27.58	peak	V

Standard:	FCC Part 22	Test Distance:	3m
Test item:	Radiated Emission	Power:	DC 3.8V
Model:	HE910	Temp.(°C)/Hum.(%RH):	26(°C)/60%RH
Mode:	Mode 4	Date:	2011/12/06
Frequency:	826.4 MHz	Test By:	Fly Lu

No.	Frequency (MHz)	Reading (dBm)	Correct Factor(dB)	Result (dBm)	Limit (dBm)	Margin (dB)	Remark	Ant.Polar. H / V
1	36.5000	-77.95	8.59	-69.36	-13.00	-56.36	peak	H
2	92.5000	-66.37	-0.43	-66.80	-13.00	-53.80	peak	H
3	199.0000	-74.72	2.02	-72.70	-13.00	-59.70	peak	H
4	314.5000	-80.35	-1.31	-81.66	-13.00	-68.66	peak	H
5	567.0000	-80.90	7.74	-73.16	-13.00	-60.16	peak	H
6	604.5000	-77.26	7.89	-69.37	-13.00	-56.37	peak	H
7	4672.000	-69.71	18.11	-51.60	-13.00	-38.60	peak	H
8	7024.000	-69.82	27.65	-42.17	-13.00	-29.17	peak	H
9	9904.000	-72.38	31.97	-40.41	-13.00	-27.41	peak	H
1	92.5000	-65.21	-4.73	-69.94	-13.00	-56.94	peak	V
2	130.5000	-80.57	14.10	-66.47	-13.00	-53.47	peak	V
3	160.0000	-78.10	12.68	-65.42	-13.00	-52.42	peak	V
4	217.5000	-79.51	6.20	-73.31	-13.00	-60.31	peak	V
5	386.5000	-80.68	1.53	-79.15	-13.00	-66.15	peak	V
6	594.0000	-80.90	7.00	-73.90	-13.00	-60.90	peak	V
7	3784.000	-68.80	20.12	-48.68	-13.00	-35.68	peak	V
8	7216.000	-70.84	25.93	-44.91	-13.00	-31.91	peak	V
9	11680.000	-73.11	38.40	-34.71	-13.00	-21.71	peak	V

Standard:	FCC Part 22	Test Distance:	3m
Test item:	Radiated Emission	Power:	DC 3.8V
Model:	HE910	Temp.(°C)/Hum.(%RH):	26(°C)/60%RH
Mode:	Mode 4	Date:	2011/12/06
Frequency:	836.4 MHz	Test By:	Fly Lu

No.	Frequency (MHz)	Reading (dBm)	Correct Factor(dB)	Result (dBm)	Limit (dBm)	Margin (dB)	Remark	Ant.Polar. H / V
1	36.5000	-78.32	8.59	-69.73	-13.00	-56.73	peak	H
2	54.0000	-79.53	6.59	-72.94	-13.00	-59.94	peak	H
3	92.5000	-65.88	-0.43	-66.31	-13.00	-53.31	peak	H
4	198.0000	-74.86	1.11	-73.75	-13.00	-60.75	peak	H
5	378.0000	-82.02	0.70	-81.32	-13.00	-68.32	peak	H
6	610.0000	-80.56	7.82	-72.74	-13.00	-59.74	peak	H
7	4828.000	-70.55	19.04	-51.51	-13.00	-38.51	peak	H
8	6904.000	-71.61	27.30	-44.31	-13.00	-31.31	peak	H
9	9844.000	-73.22	31.71	-41.51	-13.00	-28.51	peak	H
1	92.5000	-66.47	-4.73	-71.20	-13.00	-58.20	peak	V
2	130.0000	-81.24	14.37	-66.87	-13.00	-53.87	peak	V
3	160.5000	-79.42	12.20	-67.22	-13.00	-54.22	peak	V
4	195.5000	-78.89	5.92	-72.97	-13.00	-59.97	peak	V
5	281.0000	-82.08	1.00	-81.08	-13.00	-68.08	peak	V
6	574.5000	-81.66	5.50	-76.16	-13.00	-63.16	peak	V
7	4960.000	-69.81	23.34	-46.47	-13.00	-33.47	peak	V
8	8356.000	-71.47	26.16	-45.31	-13.00	-32.31	peak	V
9	10504.000	-74.23	33.25	-40.98	-13.00	-27.98	peak	V

Standard:	FCC Part 22	Test Distance:	3m
Test item:	Radiated Emission	Power:	DC 3.8V
Model:	HE910	Temp.(°C)/Hum.(%RH):	26(°C)/60%RH
Mode:	Mode 4	Date:	2011/12/06
Frequency:	846.4 MHz	Test By:	Fly Lu

No.	Frequency (MHz)	Reading (dBm)	Correct Factor(dB)	Result (dBm)	Limit (dBm)	Margin (dB)	Remark	Ant.Polar. H / V
1	37.0000	-78.08	8.74	-69.34	-13.00	-56.34	peak	H
2	92.5000	-65.93	-0.43	-66.36	-13.00	-53.36	peak	H
3	200.0000	-75.24	2.95	-72.29	-13.00	-59.29	peak	H
4	403.0000	-81.29	2.67	-78.62	-13.00	-65.62	peak	H
5	633.0000	-78.98	7.13	-71.85	-13.00	-58.85	peak	H
6	976.0000	-81.57	14.44	-67.13	-13.00	-54.13	peak	H
7	3292.000	-67.94	14.85	-53.09	-13.00	-40.09	peak	H
8	7636.000	-71.16	29.31	-41.85	-13.00	-28.85	peak	H
9	11104.000	-73.75	36.53	-37.22	-13.00	-24.22	peak	H
1	159.5000	-78.68	12.45	-66.23	-13.00	-53.23	peak	V
2	200.5000	-76.13	10.08	-66.05	-13.00	-53.05	peak	V
3	371.5000	-82.13	1.98	-80.15	-13.00	-67.15	peak	V
4	436.5000	-81.47	1.43	-80.04	-13.00	-67.04	peak	V
5	649.5000	-80.89	8.98	-71.91	-13.00	-58.91	peak	V
6	950.0000	-86.12	12.57	-73.55	-13.00	-60.55	peak	V
7	6136.000	-72.11	23.33	-48.78	-13.00	-35.78	peak	V
8	8248.000	-71.66	26.21	-45.45	-13.00	-32.45	peak	V
9	10864.000	-73.86	35.74	-38.12	-13.00	-25.12	peak	V

Standard:	FCC Part 22	Test Distance:	3m
Test item:	Radiated Emission	Power:	DC 3.8V
Model:	HE910	Temp.(°C)/Hum.(%RH):	26(°C)/60%RH
Mode:	Mode 7	Date:	2011/12/06
		Test By:	Fly Lu

No.	Frequency (MHz)	Reading (dBm)	Correct Factor(dB)	Result (dBm)	Peak Limit (dBm)	AVG. Limit (dBm)	Margin (dB)	Remark	Ant.Polar. H / V
1	3569.000	38.03	3.67	41.70	74.00	54.00	-32.30	peak	H
2	5473.000	35.05	9.91	44.96	74.00	54.00	-29.04	peak	H
3	6425.000	35.93	12.58	48.51	74.00	54.00	-25.49	peak	H
1	2862.000	37.09	1.73	38.82	74.00	54.00	-35.18	peak	V
2	4199.000	36.35	5.93	42.28	74.00	54.00	-31.72	peak	V
3	5557.000	35.05	10.08	45.13	74.00	54.00	-28.87	peak	V

7 Frequency Stability (Temperature Variation) Test

7.1. Limit

The frequency stability shall be measured by variation of ambient temperature and variation of primary supply voltage to ensure that the fundamental emission stays within the authorized frequency block. The frequency stability of the transmitter shall be maintained within $\pm 0.00025\%$ ($\pm 2.5\text{ppm}$) of the center frequency.

7.2. Test Instruments

Describe	Manufacturer	Model No.	Serial No.	Cal. Date	Remark
Universal Radio Communication Tester	ROHDE & SCHWARZ	CMU200	109369	08/10/2010	(2)
Temperature & Humidity Chamber	TAICHY	MHU-225LA	980729	08/24/2011	(1)
Test Site	ATL	TE02	TE02	N.C.R.	-----

Remark: ⁽¹⁾ Calibration period 1 year. ⁽²⁾ Calibration period 2 years.

NOTE: N.C.R. = No Calibration Request.

7.3. Setup

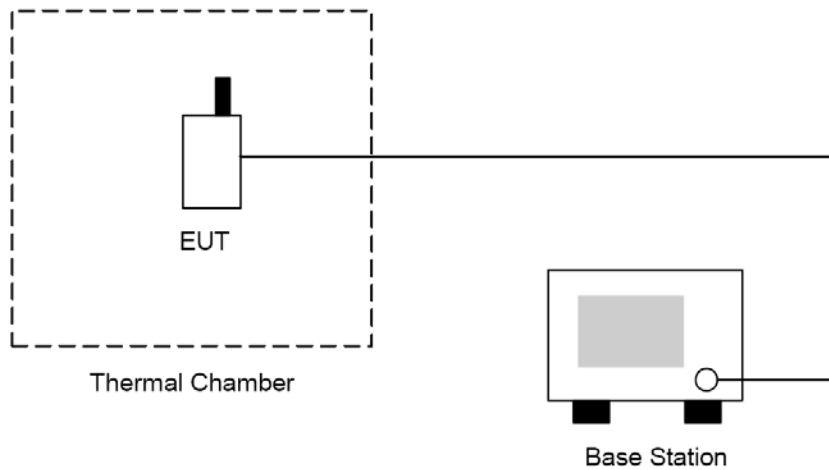

7.4. Test Procedure

The measurement is made according to FCC rules part 22 and 24:

1. The EUT and test equipment were set up as shown on the following section.
2. With all power removed, the temperature was decreased to -30°C and permitted to stabilize for three hours. Power was applied and the maximum change in frequency was note within one minute.
3. With power OFF, the temperature was raised in 10°C steps. The sample was permitted to stabilize at each step for at least one-half hour. Power was applied and the maximum frequency change was noted within one minute.
4. The temperature tests were performed for the worst case.
5. Test data was recorded.

7.5. Uncertainty

The measurement uncertainty is defined as for Frequency Stability (Temperature Variation) measurement is $\pm 10\text{Hz}$.

7.6. Test Result

Model Number	HE910			
Test Item	Frequency Stability (Temperature Variation)			
Test Mode	Mode 1: GSM 850 Link			
Date of Test	12/02/2011		Test Site	TE02
Temperature (°C)	Deviation (Hz)	Deviation (ppm)	Limit (ppm)	Result
-30	14	0.017	±2.5	Pass
-20	12	0.014	±2.5	Pass
-10	13	0.016	±2.5	Pass
0	13	0.016	±2.5	Pass
10	13	0.016	±2.5	Pass
20	14	0.017	±2.5	Pass
30	15	0.018	±2.5	Pass
40	14	0.017	±2.5	Pass
50	13	0.016	±2.5	Pass

Model Number	HE910			
Test Item	Frequency Stability (Temperature Variation)			
Test Mode	Mode 2: GSM 1900 Link			
Date of Test	12/02/2011		Test Site	TE02
Temperature (°C)	Deviation (Hz)	Deviation (ppm)	Limit (ppm)	Result
-30	-18	-0.010	±2.5	Pass
-20	-17	-0.009	±2.5	Pass
-10	-18	-0.010	±2.5	Pass
0	-15	-0.008	±2.5	Pass
10	-16	-0.009	±2.5	Pass
20	-19	-0.010	±2.5	Pass
30	18	0.010	±2.5	Pass
40	17	0.009	±2.5	Pass
50	-15	-0.008	±2.5	Pass

Model Number	HE910			
Test Item	Frequency Stability (Temperature Variation)			
Test Mode	Mode 3: WCDMA Band II Link			
Date of Test	12/02/2011		Test Site	TE02
Temperature (°C)	Deviation (Hz)	Deviation (ppm)	Limit (ppm)	Result
-30	-14	-0.007	±2.5	Pass
-20	-14	-0.007	±2.5	Pass
-10	-13	-0.007	±2.5	Pass
0	-13	-0.007	±2.5	Pass
10	-15	-0.008	±2.5	Pass
20	-14	-0.007	±2.5	Pass
30	-14	-0.007	±2.5	Pass
40	-16	-0.009	±2.5	Pass
50	-15	-0.008	±2.5	Pass

Model Number	HE910			
Test Item	Frequency Stability (Temperature Variation)			
Test Mode	Mode 4: WCDMA Band V Link			
Date of Test	12/02/2011		Test Site	TE02
Temperature (°C)	Deviation (Hz)	Deviation (ppm)	Limit (ppm)	Result
-30	-9	-0.011	±2.5	Pass
-20	-10	-0.012	±2.5	Pass
-10	-8	-0.010	±2.5	Pass
0	-8	-0.010	±2.5	Pass
10	-7	-0.008	±2.5	Pass
20	-9	-0.011	±2.5	Pass
30	-9	-0.011	±2.5	Pass
40	-10	-0.012	±2.5	Pass
50	-9	-0.011	±2.5	Pass

8 Frequency Stability (Voltage Variation) Test

8.1. Limit

The frequency stability shall be measured by variation of ambient temperature and variation of primary supply voltage to ensure that the fundamental emission stays within the authorized frequency block. The frequency stability of the transmitter shall be maintained within $\pm 0.00025\%$ ($\pm 2.5\text{ppm}$) of the center frequency.

8.2. Test Instruments

Describe	Manufacturer	Model No.	Serial No.	Cal. Date	Remark
Universal Radio Communication Tester	ROHDE & SCHWARZ	CMU200	109369	08/10/2010	(2)
Temperature & Humidity Chamber	TAICHY	MHU-225LA	980729	08/24/2011	(1)
Test Site	ATL	TE02	TE02	N.C.R.	-----

Remark: ⁽¹⁾ Calibration period 1 year. ⁽²⁾ Calibration period 2 years.

NOTE: N.C.R. = No Calibration Request.

8.3. Setup

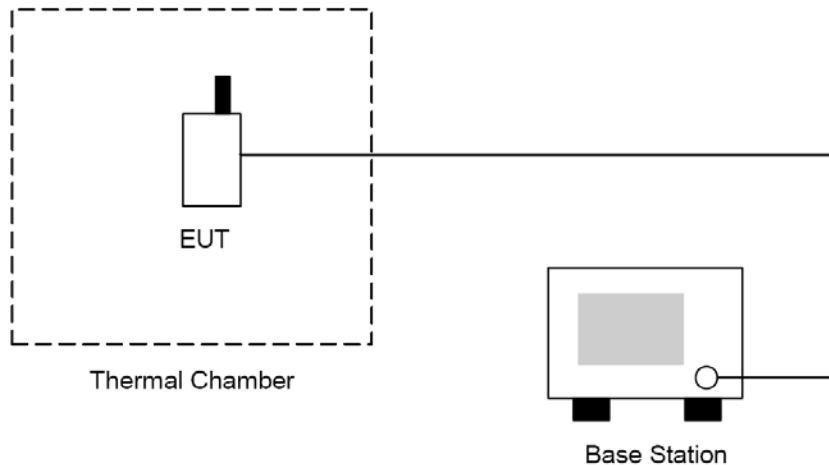

8.4. Test Procedure

1. The EUT was placed in a temperature chamber at $25 \pm 5^\circ\text{C}$ and connected as the following section.
2. The power supply voltage to the EUT was varied from BEP to 115% of the nominal value measured at the input to the EUT.
3. The variation in frequency was measured for the worst case.

8.5. Uncertainty

The measurement uncertainty is defined as for Frequency Stability (Voltage Variation) measurement is $\pm 10\text{Hz}$.

8.6. Test Result

Model Number	HE910				
Test Item	Frequency Stability (Voltage Variation)				
Test Mode	Mode 1: GSM 850 Link				
Date of Test	12/02/2011		Test Site	TE02	
Level	Voltage [V]	Deviation [Hz]	Deviation [ppm]	Limit [ppm]	Result
High voltage	4.20	14	0.017	± 2.5	Pass
Normal voltage	3.80	13	0.016	± 2.5	Pass
Low voltage	3.40	12	0.014	± 2.5	Pass

Model Number	HE910				
Test Item	Frequency Stability (Voltage Variation)				
Test Mode	Mode 2: GSM 1900 Link				
Date of Test	12/02/2011		Test Site	TE02	
Level	Voltage [V]	Deviation [Hz]	Deviation [ppm]	Limit [ppm]	Result
High voltage	4.20	-20	-0.011	± 2.5	Pass
Normal voltage	3.80	-18	-0.010	± 2.5	Pass
Low voltage	3.40	-23	-0.012	± 2.5	Pass

Model Number	HE910				
Test Item	Frequency Stability (Voltage Variation)				
Test Mode	Mode 3: WCDMA Band II Link				
Date of Test	12/02/2011		Test Site	TE02	
Level	Voltage [V]	Deviation [Hz]	Deviation [ppm]	Limit [ppm]	Result
High voltage	4.20	10	0.005	± 2.5	Pass
Normal voltage	3.80	-12	-0.006	± 2.5	Pass
Low voltage	3.40	-15	-0.008	± 2.5	Pass

Model Number	HE910				
Test Item	Frequency Stability (Voltage Variation)				
Test Mode	Mode 4: WCDMA Band V Link				
Date of Test	12/02/2011		Test Site	TE02	
Level	Voltage [V]	Deviation [Hz]	Deviation [ppm]	Limit [ppm]	Result
High voltage	4.20	-9	-0.011	±2.5	Pass
Normal voltage	3.80	-8	-0.010	±2.5	Pass
Low voltage	3.40	-6	-0.007	±2.5	Pass