



# HAC RF TEST REPORT

No. I22Z60845-SEM07

For

**HMD Global Oy**

**Smart Phone**

**Model Name: TA-1481**

With

**Hardware Version: V1.0**

**Software Version: 00WW\_0\_043**

**FCC ID: 2AJOTTA-1481**

**Results Summary: M Category = M3**

**Issued Date: 2022-07-14**

**Note:**

The test results in this test report relate only to the devices specified in this report. This report shall not be reproduced except in full without the written approval of CTTL.

**Test Laboratory:**

**CTTL, Telecommunication Technology Labs, CAICT**

No. 51, Xueyuan Road, Haidian District, Beijing, P. R. China 100191.

Tel:+86(0)10-62304633-2512, Fax:+86(0)10-62304633-2504

Email: [ctl\\_terminals@caict.ac.cn](mailto:ctl_terminals@caict.ac.cn), website: [www.caict.ac.cn](http://www.caict.ac.cn)



No.I22Z60845-SEM07

## **REPORT HISTORY**

| <b>Report Number</b> | <b>Revision</b> | <b>Issue Date</b> | <b>Description</b>              |
|----------------------|-----------------|-------------------|---------------------------------|
| I22Z60845-SEM07      | Rev.0           | 2022-07-14        | Initial creation of test report |

## TABLE OF CONTENT

|  |           |
|--|-----------|
| <b>1 TEST LABORATORY</b> .....   | <b>5</b>  |
| 1.1 TESTING LOCATION.....  | 5         |
| 1.2 TESTING ENVIRONMENT.....   | 5         |
| 1.3 PROJECT DATA .....   | 5         |
| 1.4 SIGNATURE.....   | 5         |
| <b>2 CLIENT INFORMATION</b> .....                                      | <b>6</b>  |
| 2.1 APPLICANT INFORMATION.....   | 6         |
| 2.2 MANUFACTURER INFORMATION .....                                     | 6         |
| <b>3 EQUIPMENT UNDER TEST (EUT) AND ANCILLARY EQUIPMENT (AE) .....</b> | <b>7</b>  |
| 3.1 ABOUT EUT.....   | 7         |
| 3.2 INTERNAL IDENTIFICATION OF EUT USED DURING THE TEST .....          | 7         |
| 3.3 INTERNAL IDENTIFICATION OF AE USED DURING THE TEST .....           | 7         |
| 3.4 AIR INTERFACES / BANDS INDICATING OPERATING MODES.....             | 8         |
| <b>4 MAXIMUM OUTPUT POWER</b> .....                                    | <b>9</b>  |
| <b>5 REFERENCE DOCUMENTS .....</b>                                     | <b>11</b> |
| 5.1 REFERENCE DOCUMENTS FOR TESTING .....                              | 11        |
| <b>6 OPERATIONAL CONDITIONS DURING TEST .....</b>                      | <b>12</b> |
| 6.1 HAC MEASUREMENT SET-UP.....  | 12        |
| 6.2 PROBE SPECIFICATION .....  | 13        |
| 6.3 TEST ARCH PHANTOM & PHONE POSITIONER .....                         | 14        |
| 6.4 ROBOTIC SYSTEM SPECIFICATIONS.....                                 | 14        |
| <b>7 EUT ARRANGEMENT .....</b>   | <b>15</b> |
| 7.1 WD RF EMISSION MEASUREMENTS REFERENCE AND PLANE .....              | 15        |
| <b>8 SYSTEM VALIDATION.....</b>  | <b>16</b> |
| 8.1 VALIDATION PROCEDURE.....  | 16        |
| 8.2 VALIDATION RESULT .....  | 16        |
| <b>9 EVALUATION OF MIF .....</b>                                       | <b>17</b> |
| 9.1 INTRODUCTION.....  | 17        |
| 9.2 MIF MEASUREMENT WITH THE AIA .....                                 | 18        |
| 9.3 TEST EQUIPMENT FOR THE MIF MEASUREMENT .....                       | 18        |
| 9.4 DUT MIF RESULTS.....   | 18        |
| <b>10 EVALUATION FOR LOW-POWER EXEMPTION .....</b>                     | <b>20</b> |
| 10.1 PRODUCT TESTING THRESHOLD .....                                   | 20        |
| 10.2 CONDUCTED POWER.....  | 20        |
| 10.3 CONCLUSION .....  | 21        |
| <b>11 RF TEST PROCEDURES .....</b>                                     | <b>22</b> |



12 MEASUREMENT RESULTS (E-FIELD).....23

13 ANSIC 63.19-2011 LIMITS .....24

14 MEASUREMENT UNCERTAINTY .....25

15 MAIN TEST INSTRUMENTS .....26

16 CONCLUSION.....26

ANNEX A TEST LAYOUT.....27

ANNEX B TEST PLOTS.....28

ANNEX C SYSTEM VALIDATION RESULT .....38

ANNEX D PROBE CALIBRATION CERTIFICATE .....42

ANNEX E DIPOLE CALIBRATION CERTIFICATE .....65

## 1 Test Laboratory

### 1.1 Testing Location

|              |   |
|--------------|---|
| CompanyName: | CTTL(Shouxiang)   |
| Address:     | No. 51 Shouxiang Science Building, Xueyuan Road, Haidian District, Beijing, P. R. China100191 |

### 1.2 Testing Environment

|  |            |
|--|------------|
| Temperature:   | 18°C~25°C, |
| Relative humidity:   | 30%~ 70%   |
| Ground system resistance:  | < 0.5 Ω    |
| Ambient noise is checked and found very low and in compliance with requirement of standards.<br>Reflection of surrounding objects is minimized and in compliance with requirement of standards |            |

### 1.3 Project Data

|                     |               |
|---------------------|---------------|
| Project Leader:     | Qi Dianyuan   |
| Test Engineer:      | Lin Xiaojun   |
| Testing Start Date: | June 17, 2022 |
| Testing End Date:   | July 07, 2022 |

### 1.4 Signature



Lin Xiaojun  
(Prepared this test report)



Qi Dianyuan  
(Reviewed this test report)



Lu Bingsong  
Deputy Director of the laboratory  
(Approved this test report)



## 2 Client Information

### 2.1 Applicant Information

|                 |   |
|-----------------|---|
| HMD Global Oy   | HMD Global Oy                           |
| Address/Post:   | Bertel Jungin aukio 9, 02600 Espoo, Fin |
| Contact Person: | Eric Su                                 |
| Contact Email:  | Eric Su eric.su@hmdglobal.com           |
| Telephone:      | +886931279274                           |
| Fax             | \                                       |

### 2.2 Manufacturer Information

|                 |   |
|-----------------|---|
| Company Name:   | HMD Global Oy                           |
| Address/Post:   | Bertel Jungin aukio 9, 02600 Espoo, Fin |
| Contact Person: | Eric Su                                 |
| Contact Email:  | Eric Su eric.su@hmdglobal.com           |
| Telephone:      | +886931279274                           |
| Fax             | \                                       |

### 3 Equipment Under Test (EUT) and Ancillary Equipment (AE)

#### 3.1 About EUT

|                    |   |
|--------------------|---|
| Description:       | Smart Phone   |
| Model name:        | TA-1481   |
| Operating mode(s): | GSM850/GSM900/GSM1800/GSM1900<br>WCDMAB1/B2/B4/B5/B8,<br>5G NR n1/n2/n3/n5/n7/n28/n38/n40/n41/n66/n78, BT, Wi-Fi,<br>LTE Band 1/2/3/4/5/7/8/12/13/17/20/28/38/39/40/41/66 |

#### 3.2 Internal Identification of EUT used during the test

| EUT ID* | IMEI            | HW Version | SW Version |
|---------|-----------------|------------|------------|
| EUT     | 351816950004196 | V1.0       | 00WW_0_043 |
| EUT     | 351816950004329 | V1.0       | 00WW_0_043 |

\*EUT ID: is used to identify the test sample in the lab internally.

#### 3.3 Internal Identification of AE used during the test

| AE ID* | Description | Model | SN | Manufacturer                       |
|--------|-------------|-------|----|------------------------------------|
| AE1    | Battery     | CN450 | \  | HUNAN GAOYUAN BATTERY<br>Co., Ltd. |

\*AE ID: is used to identify the test sample in the lab internally.

### 3.4 Air Interfaces / Bands Indicating Operating Modes

| Air-interface | Band(MHz)            | Type | C63.19/tested     | Simultaneous Transmissions | Name of Voice Service |
|---------------|----------------------|------|-------------------|----------------------------|-----------------------|
| GSM           | 850                  | VO   | Yes               | BT, WLAN                   | CMRS Voice            |
|               | 1900                 |      |                   |                            |                       |
| GPRS/EDGE     | 850                  | DT   | Yes               |                            | Google duo            |
|               | 1900                 |      |                   |                            |                       |
| WCDMA (UMTS)  | 850                  | VO   | NO <sup>(1)</sup> | BT, WLAN                   | CMRS Voice            |
|               | 1700                 |      |                   |                            |                       |
|               | 1900                 | DT   | NO <sup>(1)</sup> |                            | Google duo            |
| LTE TDD       | Band41               | V/D  | Yes               | BT, WLAN                   | VoLTE, Google duo     |
| LTE FDD       | Band2/5/7/12/13/66   | V/D  | NO <sup>(1)</sup> | BT, WLAN                   | VoLTE, Google duo     |
| NR            | n2/n5/n7/n41/n66/n78 | V/D  | NO <sup>(1)</sup> | BT, WLAN                   | VoNR, Google duo      |
| BT            | 2450                 | DT   | NA                | GSM,WCDMA ,LTE,NR          | NA                    |
| WLAN          | 2450                 | V/D  | Yes               | GSM,WCDMA ,LTE,NR          | VoWiFi, Google duo    |
| WLAN          | 5G                   | V/D  | NO <sup>(1)</sup> | GSM,WCDMA ,LTE,NR          | VoWiFi, Google duo    |

NA: Not Applicable VO: Voice Only V/D: CMRS and IP Voice Service over Digital Transport

DT: Digital Transport

\* HAC Rating was not based on concurrent voice and data modes, Non current mode was found to represent worst case rating for both M and T rating

Note1 = The air interface is exempted from testing by low power exemption that its average antenna input power plus its MIF is  $\leq 17$  dBm, and is rated as M4.

Note2= The device have similar frequency in some LTE bands : 12/17,4/66 since the supported frequency spans for the smaller LTE bands are completely cover by the larger LTE bands, therefore, only larger LTE bands were required to be tested for hearing-aid compliance.



#### 4 Maximum Output Power.

|                                |                                |                                |                                |
|--------------------------------|--------------------------------|--------------------------------|--------------------------------|
| <b>GSM<br/>850MHz</b>          | <b>Conducted Power (dBm)</b>   |                                |                                |
|                                | <b>Channel 251(848.8MHz)</b>   | <b>Channel 190(836.6MHz)</b>   | <b>Channel 128(824.2MHz)</b>   |
| Voice                          | 33                             | 33                             | 33                             |
| EDGE                           | 27                             | 27                             | 27                             |
| <b>GSM<br/>1900MHz</b>         | <b>Conducted Power(dBm)</b>    |                                |                                |
|                                | <b>Channel 810(1909.8MHz)</b>  | <b>Channel 661(1880MHz)</b>    | <b>Channel 512(1850.2MHz)</b>  |
| Voice                          | 30                             | 30                             | 30                             |
| EDGE                           | 27                             | 27                             | 27                             |
| <b>WCDMA<br/>850MHz</b>        | <b>Conducted Power (dBm)</b>   |                                |                                |
|                                | <b>Channel 4233(846.6MHz)</b>  | <b>Channel 4182(836.4MHz)</b>  | <b>Channel 4132(826.4MHz)</b>  |
| RMC                            | 24.5                           | 24.5                           | 24.5                           |
| HSPA                           | 23.5                           | 23.5                           | 23.5                           |
| <b>WCDMA<br/>1700MHz</b>       | <b>Conducted Power (dBm)</b>   |                                |                                |
|                                | <b>Channel1513(1752.6MHz)</b>  | <b>Channel1412(1732.4MHz)</b>  | <b>Channel1312(1712.4MHz)</b>  |
| RMC                            | 24                             | 24                             | 24                             |
| HSPA                           | 23                             | 23                             | 23                             |
| <b>WCDMA<br/>1900MHz</b>       | <b>Conducted Power (dBm)</b>   |                                |                                |
|                                | <b>Channel 9538(1907.6MHz)</b> | <b>Channel 9400(1880MHz)</b>   | <b>Channel 9262(1852.4MHz)</b> |
| RMC                            | 24                             | 24                             | 24                             |
| HSPA                           | 23                             | 23                             | 23                             |
| <b>LTE Band2<br/>QPSK</b>      | <b>Conducted Power (dBm)</b>   |                                |                                |
|                                | <b>Channel 19100(1900MHz)</b>  | <b>Channel 18900(1880MHz)</b>  | <b>Channel18700(1860MHz)</b>   |
|                                | 23.5                           | 23.5                           | 23.5                           |
| <b>LTE Band5<br/>QPSK</b>      | <b>Conducted Power (dBm)</b>   |                                |                                |
|                                | <b>Channel 20600(844MHz)</b>   | <b>Channel 20525(836.5MHz)</b> | <b>Channel20450(829MHz)</b>    |
|                                | 24                             | 24                             | 24                             |
| <b>LTE Band7<br/>QPSK</b>      | <b>Conducted Power (dBm)</b>   |                                |                                |
|                                | <b>Channel 21350(2560MHz)</b>  | <b>Channel 21100(2535MHz)</b>  | <b>Channel20850(2510MHz)</b>   |
|                                | 24                             | 24                             | 24                             |
| <b>LTE Band12<br/>QPSK</b>     | <b>Conducted Power (dBm)</b>   |                                |                                |
|                                | <b>Channel 23130(711MHz)</b>   | <b>Channel 23095(707.5MHz)</b> | <b>Channel23060(704MHz)</b>    |
|                                | 25                             | 25                             | 25                             |
| <b>LTE Band13<br/>QPSK</b>     | <b>Conducted Power (dBm)</b>   |                                |                                |
|                                | <b>Channel 23230(782MHz)</b>   |                                |                                |
|                                | 25                             |                                |                                |
| <b>LTE Band41<br/>QPSK PC2</b> | <b>Conducted Power (dBm)</b>   |                                |                                |
|                                | <b>Channel 41490(2680MHz)</b>  | <b>Channel 40620(2593MHz)</b>  | <b>Channel 39750(2506MHz)</b>  |
|                                | 27                             | 27                             | 27                             |
| <b>LTE Band41<br/>QPSK PC3</b> | <b>Conducted Power (dBm)</b>   |                                |                                |
|                                | <b>Channel 41490(2680MHz)</b>  | <b>Channel 40620(2593MHz)</b>  | <b>Channel 39750(2506MHz)</b>  |

|                              |                                      |  |                                       |
|------------------------------|--------------------------------------|--|---------------------------------------|
|                              | 24                                   | 24                                     | 24                                    |
| <b>LTE Band66<br/>QPSK</b>   | <b>Conducted Power (dBm)</b>         |  |                                       |
|                              | <b>Channel 132572(1770MHz)</b>       | <b>Channel 132322(1745MHz)</b>         | <b>Channel 132072(1720MHz)</b>        |
|                              | 24                                   | 24                                     | 24                                    |
| <b>2.4GHz<br/>802.11b</b>    | <b>Conducted Power (dBm)</b>         |  |                                       |
|                              | <b>Channel 11 (2462MHz)</b>          | <b>Channel 6 (2437MHz)</b>             | <b>Channel 1 (2412MHz)</b>            |
|                              | 21                                   | 21                                     | 21                                    |
| <b>5GHz<br/>802.11a</b>      | <b>Tune up (dBm)</b>                 |  |                                       |
|                              | <b>Channel 60 (5300MHz)</b>          | <b>Channel 124 (5620MHz)</b>           | <b>Channel 157 (5785MHz)</b>          |
|                              | 19.5                                 | 19.5                                   | 19.5                                  |
| <b>5G NR<br/>N2</b>          | <b>Conducted Power (dBm)</b>         |  |                                       |
|                              | <b>Channel381500<br/>(1907.5MHz)</b> | <b>Channel376000<br/>(1880MHz)</b>     | <b>Channel370500<br/>(1852.5MHz)</b>  |
|                              | 23                                   | 23                                     | 23                                    |
| <b>5G NR<br/>N5</b>          | <b>Conducted Power (dBm)</b>         |  |                                       |
|                              | <b>Channel169300 (846.5MHz)</b>      | <b>Channel167300(836.5MHz)</b>         | <b>Channel165300(826.5MHz)</b>        |
|                              | 24                                   | 24                                     | 24                                    |
| <b>5G NR<br/>N7</b>          | <b>Conducted Power (dBm)</b>         |  |                                       |
|                              | <b>Channel513500 (2567.5MHz)</b>     | <b>Channel507000(2535MHz)</b>          | <b>Channel500500(2502.5MHz)</b>       |
|                              | 23                                   | 23                                     | 23                                    |
| <b>5G NR<br/>N41<br/>PC2</b> | <b>Conducted Power (dBm)</b>         |  |                                       |
|                              | <b>Channel 528000(2640MHz)</b>       | <b>Channel518598(2593MHz)</b>          | <b>Channel 509202(2546MHz)</b>        |
|                              | 27                                   | 27                                     | 27                                    |
| <b>5G NR<br/>N41<br/>PC3</b> | <b>Conducted Power (dBm)</b>         |  |                                       |
|                              | <b>Channel 528000(2640MHz)</b>       | <b>Channel518598(2593MHz)</b>          | <b>Channel 509202(2546MHz)</b>        |
|                              | 25                                   | 25                                     | 25                                    |
| <b>5G NR<br/>N66</b>         | <b>Conducted Power (dBm)</b>         |  |                                       |
|                              | <b>Channel354000 (1770MHz)</b>       | <b>Channel 136100 (680.5MHz)</b>       | <b>Channel354000 (1770MHz)</b>        |
|                              | 23                                   | 23                                     | 23                                    |
| <b>5G NR<br/>N78<br/>PC2</b> | <b>Conducted Power (dBm)</b>         |  |                                       |
|                              | <b>Channel653000<br/>(3795MHz)</b>   | <b>Channel 636666<br/>(3549.99MHz)</b> | <b>Channel620334<br/>(3305.01MHz)</b> |
|                              | 27                                   | 27                                     | 27                                    |
| <b>5G NR<br/>N78<br/>PC3</b> | <b>Conducted Power (dBm)</b>         |  |                                       |
|                              | <b>Channel653000<br/>(3795MHz)</b>   | <b>Channel 636666<br/>(3549.99MHz)</b> | <b>Channel620334<br/>(3305.01MHz)</b> |
|                              | 25                                   | 25                                     | 25                                    |

## 5 Reference Documents

### 5.1 Reference Documents for testing

The following document listed in this section is referred for testing.

| Reference         | Title  | Version      |
|-------------------|--|--------------|
| ANSI C63.19-2011  | American National Standard for Methods of Measurement of Compatibility between Wireless Communication Devices and Hearing Aids | 2011 Edition |
| FCC 47 CFR §20.19 | Hearing Aid Compatible Mobile Headsets   | 2015 Edition |
| KDB 285076 D01    | Equipment Authorization Guidance for Hearing Aid Compatibility   | v06          |

## 6 OPERATIONAL CONDITIONS DURING TEST

### 6.1 HAC MEASUREMENT SET-UP

These measurements are performed using the DASY5 NEO automated dosimetric assessment system. It is made by Schmid & Partner Engineering AG (SPEAG) in Zurich, Switzerland. It consists of high precision robotics system (Stäubli), robot controller, Intel Core2 computer, near-field probe, probe alignment sensor. The robot is a six-axis industrial robot performing precise movements. A cell controller system contains the power supply, robot controller, teach pendant (Joystick), and remote control, is used to drive the robot motors. The PC consists of the HP Intel Core2 1.86 GHz computer with Windows XP system and HAC Measurement Software DASY5 NEO, A/D interface card, monitor, mouse, and keyboard. The Stäubli Robot is connected to the cell controller to allow software manipulation of the robot. A data acquisition electronic (DAE) circuit performs the signal amplification, signal multiplexing, AD-conversion, offset measurements, mechanical surface detection, collision detection, etc. is connected to the Electro-optical coupler (EOC). The EOC performs the conversion from the optical into digital electric signal of the DAE and transfers data to the PC plug-in card.

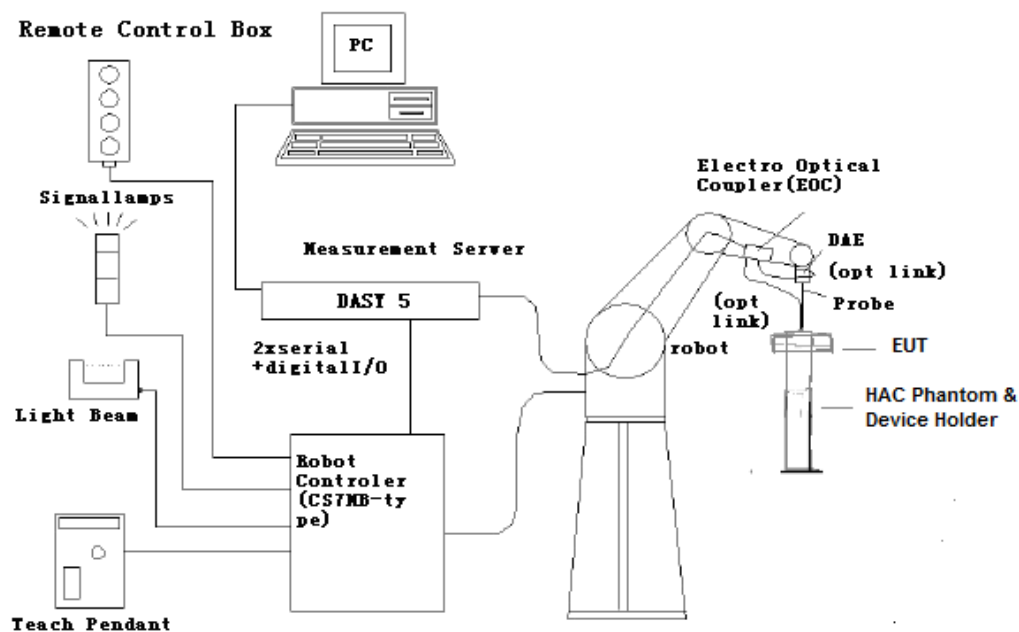

**Fig. 1 HAC Test Measurement Set-up**

The DAE4 consists of a highly sensitive electrometer-grade preamplifier with auto-zeroing, a channel and gain-switching multiplexer, a fast 16 bit AD-converter and a command decoder and control logic unit. Transmission to the PC-card is accomplished through an optical downlink for data and status information and an optical uplink for commands and clock lines. The mechanical probe mounting device includes two different sensor systems for frontal and sidewise probe contacts. They are also used for mechanical surface detection and probe collision detection. The robot uses its own controller with a built in VME-bus computer.

## 6.2 Probe Specification

### E-Field Probe Description

|               |  |
|---------------|--|
| Construction  | <p>One dipole parallel, two dipoles normal to probe axis</p> <p>Built-in shielding against static charges</p> <p>PEEK enclosure material</p> |
| Calibration   | <p>In air from 100 MHz to 3.0 GHz (absolute accuracy <math>\pm 6.0\%</math>, <math>k=2</math>)</p>   |
| Frequency     | <p>40 MHz to &gt; 6 GHz (can be extended to &lt; 20 MHz)</p> <p>Linearity: <math>\pm 0.2</math> dB (100 MHz to 3 GHz)</p>                    |
| Directivity   | <p><math>\pm 0.2</math> dB in air (rotation around probe axis)</p> <p><math>\pm 0.4</math> dB in air (rotation normal to probe axis)</p>     |
| Dynamic Range | <p>2 V/m to &gt; 1000 V/m; Linearity: <math>\pm 0.2</math> dB</p>  |
| Dimensions    | <p>Overall length: 330 mm (Tip: 16 mm)</p> <p>Tip diameter: 8 mm (Body: 12 mm)</p> <p>Distance from probe tip to dipole centers: 2.5 mm</p>  |
| Application   | <p>General near-field measurements up to 6 GHz</p> <p>Field component measurements</p> <p>Fast automatic scanning in phantoms</p>            |



**[ER3DV6]**

### 6.3 Test Arch Phantom & Phone Positioner

The Test Arch phantom should be positioned horizontally on a stable surface. Reference markings on the Phantom allow the complete setup of all predefined phantom positions and measurement grids by manually teaching three points in the robot. It enables easy and well defined positioning of the phone and validation dipoles as well as simple teaching of the robot (Dimensions: 370 x 370 x 370 mm).

The Phone Positioner supports accurate and reliable positioning of any phone with effect on near field  $< \pm 0.5$  dB.

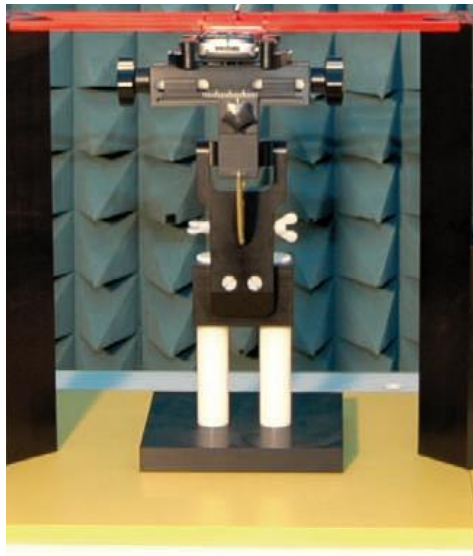

Fig. 2 HAC Phantom & Device Holder

### 6.4 Robotic System Specifications

#### Specifications

**Positioner:** Stäubli Unimation Corp. Robot Model: RX160L

**Repeatability:**  $\pm 0.02$  mm

**No. of Axis:** 6

#### Data Acquisition Electronic (DAE) System

##### Cell Controller

**Processor:** Intel Core2

**Clock Speed:** 1.86GHz

**Operating System:** Windows XP

##### Data Converter

**Features:** Signal Amplifier, multiplexer, A/D converter, and control logic

**Software:** DASY5 software

**Connecting Lines:** Optical downlink for data and status info.

Optical uplink for commands and clock

## 7 EUT ARRANGEMENT

### 7.1 WD RF Emission Measurements Reference and Plane

Figure 4 illustrates the references and reference plane that shall be used in the WD emissions measurement.

- The grid is 5 cm by 5 cm area that is divided into 9 evenly sized blocks or sub-grids.
- The grid is centered on the audio frequency output transducer of the WD (speaker or T-coil).
- The grid is located by reference to a reference plane. This reference plane is the planar area that contains the highest point in the area of the WD that normally rests against the user's ear
- The measurement plane is located parallel to the reference plane and 15 mm from it, out from the phone. The grid is located in the measurement plane.

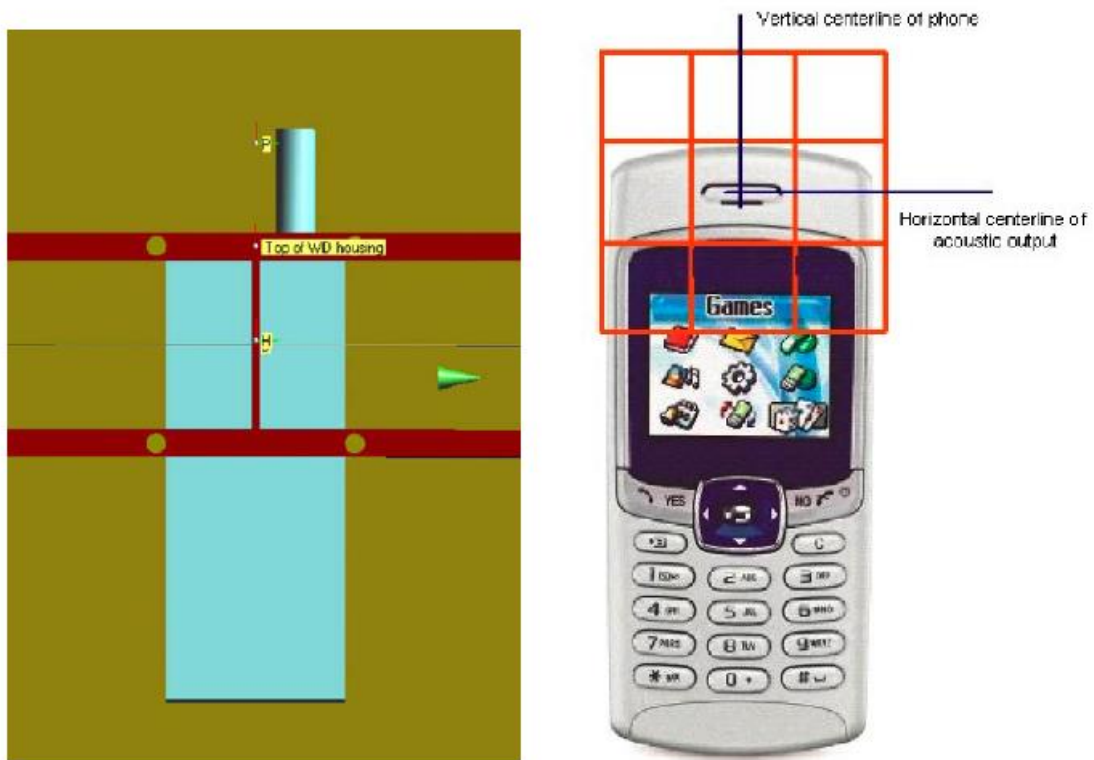

Fig. 3 WD reference and plane for RF emission measurements

## 8 SYSTEM VALIDATION

### 8.1 Validation Procedure

Place a dipole antenna meeting the requirements given in ANSI C63.19 in the position normally occupied by the WD. The dipole antenna serves as a known source for an electrical output. Position the E-field probes so that:

- The probes and their cables are parallel to the coaxial feed of the dipole antenna
- The probe cables and the coaxial feed of the dipole antenna approach the measurement area from opposite directions
- The center point of the probe element(s) are 15 mm from the closest surface of the dipole elements.

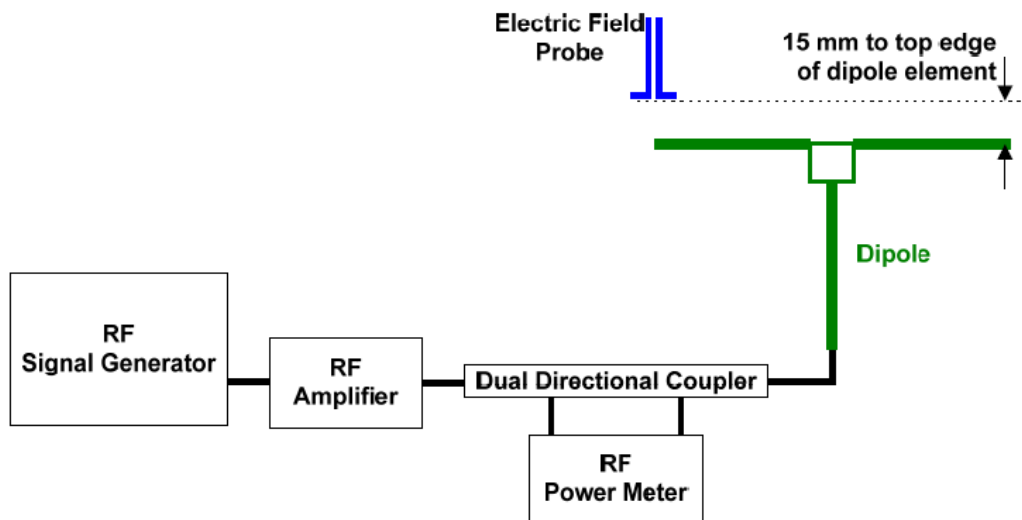

Fig. 4 Dipole Validation Setup

### 8.2 Validation Result

| E-Field Scan |                 |                  |                                    |                                  |                            |                        |
|--------------|-----------------|------------------|------------------------------------|----------------------------------|----------------------------|------------------------|
| Mode         | Frequency (MHz) | Input Power (mW) | Measured <sup>1</sup> Value(dBV/m) | Target <sup>2</sup> Value(dBV/m) | Deviation <sup>3</sup> (%) | Limit <sup>4</sup> (%) |
| CW           | 835             | 100              | 40.67                              | 41                               | -3.73                      | ± 25                   |
| CW           | 1880            | 100              | 38.35                              | 38.8                             | -5.05                      | ± 25                   |
| CW           | 2450            | 100              | 38.25                              | 38.68                            | -4.83                      | ± 25                   |
| CW           | 2600            | 100              | 38.34                              | 38.64                            | -3.39                      | ± 25                   |

Notes:

1. Please refer to the attachment for detailed measurement data and plot.
2. Target value is provided by SPEAD in the calibration certificate of specific dipoles.
3. Deviation (%) =  $100 * (\text{Measured value minus Target value})$  divided by Target value.
4. ANSI C63.19 requires values within  $\pm 25\%$  are acceptable, of which 12% is deviation and 13% is measurement uncertainty. Values independently validated for the dipole actually used in the measurements should be used, when available.



## 9 Evaluation of MIF

### 9.1 Introduction

The MIF (Modulation Interference Factor) is used to classify E-field emission to determine Hearing Aid Compatibility (HAC). It scales the power-averaged signal to the RF audio interference level and is characteristic to a modulation scheme. The HAC standard preferred "indirect" measurement method is based on average field measurement with separate scaling by the MIF. With an Audio Interference Analyzer (AIA) designed by SPEAG specifically for the MIF measurement, these values have been verified by practical measurements on an RF signal modulated with each of the waveforms. The resulting deviations from the simulated values are within the requirements of the HAC standard.

The AIA (Audio Interference Analyzer) is a USB powered electronic sensor to evaluate signals in the frequency range 698MHz - 6 GHz. It contains RMS detector and audio frequency circuits for sampling of the RF envelope.

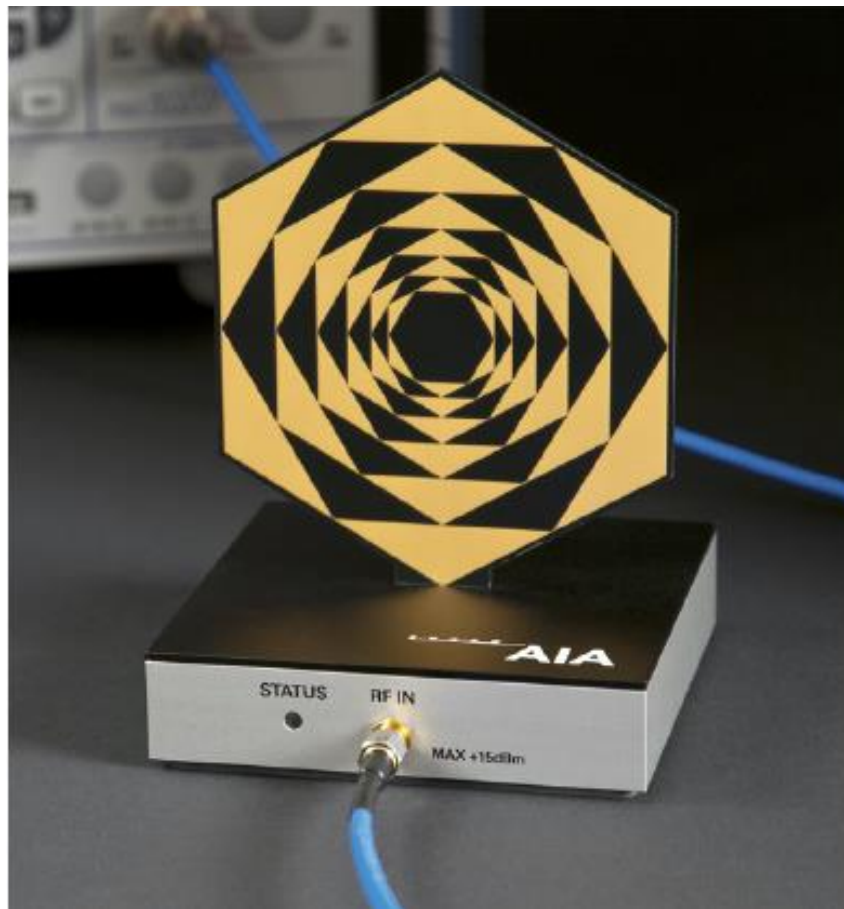

Fig. 5 AIA Front View

## 9.2 MIF measurement with the AIA

The MIF is measured with the AIA as follows:

1. Connect the AIA via USB to the DASY5 PC and verify the configuration settings.
2. Couple the RF signal to be evaluated to an AIA via cable or antenna.
3. Generate a MIF measurement job for the unknown signal and select the measurement port and timing settings.
4. Document the results via the post processor in a report.

## 9.3 Test equipment for the MIF measurement

| No. | Name             | Type          | Serial Number | Manufacturer |
|-----|------------------|---------------|---------------|--------------|
| 01  | Signal Generator | E4438C        | MY49071430    | Agilent      |
| 02  | AIA              | SE UMS 170 CB | 1029          | SPEAG        |
| 03  | BTS              | CMW500        | 166370        | R&S          |

## 9.4 DUT MIF results

Based on the KDB285076D01v05, the handset can also use the MIF values predetermined by the test equipment manufacturer. MIF values applied in this test report were provided by the HAC equipment provider of SPEAG, and the worst values for all air interface are listed below to be determine the Low-power Exemption.

| Typical MIF levels in ANSI C63.19-2011                      |                                |
|---|--------------------------------|
| Transmission protocol                                       | Modulation interference factor |
| GSM-FDD (TDMA, GMSK)  | +3.63 dB                       |
| EDGE-FDD (TDMA, 8PSK, TN 0-1)                               | +1.23dB                        |
| EDGE-FDD (TDMA, 8PSK, TN 0-1-2)                             | -0.52dB                        |
| EDGE-FDD (TDMA, 8PSK, TN 0-1-2-3)                           | -1.82dB                        |
| UMTS-FDD(WCDMA, AMR)  | -25.43dB                       |
| UMTS-FDD (HSPA)   | -20.75dB                       |
| LTE-FDD (SC-FDMA, 1RB, 20MHz, QPSK)                         | -15.63 dB                      |
| LTE-FDD (SC-FDMA, 1RB, 20MHz, 16QAM)                        | -9.76 dB                       |
| LTE-FDD (SC-FDMA, 1RB, 20MHz, 64QAM)                        | -9.93 dB                       |
| LTE-TDD (SC-FDMA, 1RB, 20MHz, QPSK)                         | -1.62 dB                       |
| LTE-TDD (SC-FDMA, 1RB, 20MHz, 16QAM)                        | -1.44 dB                       |
| LTE-TDD (SC-FDMA, 1RB, 20MHz, 64QAM)                        | -1.54 dB                       |
| LTE-TDD(SC-FDMA,1RB,20MHz,QPSK,UL<br>Subframe=2,3,4,7,8,9)  | -3.41 dB                       |
| LTE-TDD(SC-FDMA,1RB,20MHz,16QAM,UL<br>Subframe=2,3,4,7,8,9) | -3.17 dB                       |
| LTE-TDD(SC-FDMA,1RB,20MHz,64QAM,UL<br>Subframe=2,3,4,7,8,9) | -3.31 dB                       |
| IEEE 802.11b WiFi 2.4 GHz (DSSS, 1 Mbps)                    | -5.90 dB                       |
| IEEE 802.11b WiFi 2.4 GHz (DSSS, 2 Mbps)                    | -5.17 dB                       |

|   |           |
|---|-----------|
| IEEE 802.11b WiFi 2.4 GHz (DSSS, 5.5 Mbps)        | -3.37 dB  |
| IEEE 802.11b WiFi 2.4 GHz (DSSS, 11 Mbps)         | -2.02 dB  |
| IEEE 802.11g WiFi 2.4 GHz (DSSS-OFDM, 6 Mbps)     | -0.36dB   |
| IEEE 802.11n (HT Greenfield, 6.5 Mbps, BPSK)      | -15.80 dB |
| IEEE 802.11a/h WiFi 5 GHz (OFDM, 6 Mbps)          | -5.82 dB  |
| IEEE 802.11ac WiFi (20MHz, MCS0, 99pc duty cycle) | -12.23dB  |
| 5G NR (DFT-s-OFDM, 1 RB, 20 MHz, QPSK, 15 kHz)    | -15.06dB  |
| 5G NR (CP-OFDM, 1 RB, 5 MHz, QPSK, 15 kHz)        | -12.18dB  |
| 5G NR (CP-OFDM, 1 RB, 10 MHz, QPSK, 15 kHz)       | -12.26dB  |
| 5G NR (CP-OFDM, 1 RB, 15 MHz, QPSK, 15 kHz)       | -12.08dB  |
| 5G NR (CP-OFDM, 1 RB, 20 MHz, QPSK, 15 kHz)       | -12.20dB  |
| 5G NR (CP-OFDM, 1 RB, 5 MHz, QPSK, 30 kHz)        | -14.39dB  |
| 5G NR (CP-OFDM, 1 RB, 10 MHz, QPSK, 30 kHz)       | -14.47dB  |
| 5G NR (CP-OFDM, 1 RB, 15 MHz, QPSK, 30 kHz)       | -14.33dB  |
| 5G NR (CP-OFDM, 1 RB, 20 MHz, QPSK, 30 kHz)       | -14.46dB  |
| 5G NR (CP-OFDM, 1 RB, 25 MHz, QPSK, 30 kHz)       | -14.35dB  |
| 5G NR (CP-OFDM, 1 RB, 30 MHz, QPSK, 30 kHz)       | -14.32dB  |
| 5G NR (CP-OFDM, 1 RB, 40 MHz, QPSK, 30 kHz)       | -14.32dB  |
| 5G NR (CP-OFDM, 1 RB, 50 MHz, QPSK, 30 kHz)       | -14.55dB  |
| 5G NR (CP-OFDM, 1 RB, 60 MHz, QPSK, 30 kHz)       | -14.45dB  |
| 5G NR (CP-OFDM, 1 RB, 80 MHz, QPSK, 30 kHz)       | -14.47dB  |
| 5G NR (CP-OFDM, 1 RB, 90 MHz, QPSK, 30 kHz)       | -14.43dB  |
| 5G NR (CP-OFDM, 1 RB, 100 MHz, QPSK, 30 kHz)      | -14.38dB  |
| 5G NR (DFT-s-OFDM, 1 RB, 5 MHz, QPSK, 15 kHz)     | -15.06dB  |
| 5G NR (DFT-s-OFDM, 1 RB, 10 MHz, QPSK, 15 kHz)    | -15.06dB  |
| 5G NR (DFT-s-OFDM, 1 RB, 15 MHz, QPSK, 15 kHz)    | -15.06dB  |
| 5G NR (DFT-s-OFDM, 1 RB, 20 MHz, QPSK, 15 kHz)    | -15.06dB  |

## 10 Evaluation for low-power exemption

### 10.1 Product testing threshold

There are two methods for exempting an RF air interface technology from testing. The first method requires evaluation of the MIF for the worst-case operating mode. An RF air interface technology of a device is exempt from testing when its average antenna input power plus its MIF is  $\leq 17$  dBm for any of its operating modes. The second method does not require determination of the MIF. The RF emissions testing exemption shall be applied to an RF air interface technology in a device whose peak antenna input power, averaged over intervals  $\leq 50 \mu s$ , is  $\leq 23$  dBm. An RF air interface technology that is exempted from testing by either method shall be rated as M4.

The first method is used to be exempt from testing for the RF air interface technology in this report.

### 10.2 Conducted power

| Band                 | Average power (dBm) | MIF (dB) | Sum (dBm) | C63.19 Tested |
|----------------------|---------------------|----------|-----------|---------------|
| GSM 850 - Voice      | 33                  | 3.63     | 36.63     | Yes           |
| GSM 850 - EDGE       | 27                  | -1.82    | 25.18     | Yes*          |
| GSM 1900 - Voice     | 30                  | 3.63     | 33.63     | Yes           |
| GSM 1900 - EDGE      | 27                  | -1.82    | 25.18     | Yes*          |
| WCDMA 850 - RMC      | 24.5                | -25.43   | -0.93     | No            |
| WCDMA 850 - HSPA     | 23.5                | -20.75   | 2.75      | No            |
| WCDMA 1700 - RMC     | 24                  | -25.43   | -1.43     | No            |
| WCDMA 1700 - HSPA    | 23                  | -20.75   | 2.25      | No            |
| WCDMA 1900 - RMC     | 24                  | -25.43   | -1.43     | No            |
| WCDMA 1900 - HSPA    | 23                  | -20.75   | 2.25      | No            |
| LTE Band 2 QPSK      | 23.5                | -15.63   | 7.87      | No            |
| LTE Band 5 QPSK      | 24                  | -15.63   | 8.37      | No            |
| LTE Band 7 QPSK      | 24                  | -15.63   | 8.37      | No            |
| LTE Band 12 QPSK     | 25                  | -15.63   | 9.37      | No            |
| LTE Band 13 QPSK     | 25                  | -15.63   | 9.37      | No            |
| LTE Band 66 QPSK     | 24                  | -15.63   | 8.37      | No            |
| LTE Band 41 QPSK PC2 | 27                  | -3.41    | 23.59     | Yes           |
| LTE Band 41 QPSK PC3 | 25                  | -3.41    | 21.59     | Yes           |
| NR n2                | 23                  | -12.08   | 10.92     | No            |
| NR n5                | 24                  | -12.08   | 11.92     | No            |
| NR n7                | 23                  | -12.08   | 10.92     | No            |
| NR n66               | 23                  | -12.08   | 10.92     | No            |
| NR n41 PC2           | 27                  | -12.08   | 14.92     | No            |
| NR n41 PC3           | 25                  | -12.08   | 12.92     | No            |
| NR n78 PC2           | 27                  | -12.08   | 14.92     | No            |

|            |      |        |       |     |
|------------|------|--------|-------|-----|
| NR n78 PC3 | 25   | -12.08 | 12.92 | No  |
| WiFi-2.4G  | 21   | -2.02  | 18.98 | Yes |
| WiFi-5G    | 19.5 | -5.82  | 13.68 | No  |

### 10.3 Conclusion

According to the above table, the sums of average power and MIF for WCDMA, LTE FDD WIFI 5G and NR are less than 17dBm. So it is measured for GSM and LTE TDD bands and WIFI2.4G. The WCDMA, LTE FDD WiFi 5G and NR are exempt from testing and rated as M4.

## 11 RF TEST PROCEDURES

**The evaluation was performed with the following procedure:**

- 1) Confirm proper operation of the field probe, probe measurement system and other instrumentation and the positioning system.
- 2) Position the WD in its intended test position. The gauge block can simplify this positioning.
- 3) Configure the WD normal operation for maximum rated RF output power, at the desired channel and other operating parameters (e.g., test mode), as intended for the test.
- 4) The center sub-grid shall be centered on the center of the T-Coil mode axial measurement point or the acoustic output, as appropriate. Locate the field probe at the initial test position in the 50 mm by 50 mm grid, which is contained in the measurement plane. If the field alignment method is used, align the probe for maximum field reception.
- 5) Record the reading.
- 6) Scan the entire 50 mm by 50 mm region in equally spaced increments and record the reading at each measurement point. The distance between measurement points shall be sufficient to assure the identification of the maximum reading.
- 7) Identify the five contiguous sub-grids around the center sub-grid whose maximum reading is the lowest of all available choices. This eliminates the three sub-grids with the maximum readings. Thus, the six areas to be used to determine the WD's highest emissions are identified.
- 8) Identify the maximum field reading within the non-excluded sub-grids identified in Step 7)
- 9) Evaluate the MIF and add to the maximum steady-state rms field-strength reading to obtain the RF audio interference level..
- 10) Compare this RF audio interference level with the categories and record the resulting WD category rating.

## 12 Measurement Results (E-Field)

| Frequency                    |         | Measured Value(dBV/m) | Power Drift (dB) | Category               |
|------------------------------|---------|-----------------------|------------------|------------------------|
| MHz                          | Channel |                       |                  |                        |
| <b>GSM 850</b>               |         |                       |                  |                        |
| 848.8                        | 251     | 34.61                 | -0.00            | <b>M4</b>              |
| 836.6                        | 190     | 35.31                 | -0.01            | <b>M4(see Fig B.1)</b> |
| 824.2                        | 128     | 34.57                 | -0.04            | <b>M4</b>              |
| <b>GSM 1900</b>              |         |                       |                  |                        |
| 1909.8                       | 810     | 28.53                 | 0.03             | <b>M4(see Fig B.2)</b> |
| 1880                         | 661     | 28.10                 | -0.13            | <b>M4</b>              |
| 1850.2                       | 512     | 26.82                 | -0.05            | <b>M4</b>              |
| <b>LTE Band 41 PC2 QPSK</b>  |         |                       |                  |                        |
| 2680                         | 41490   | 33.05                 | 0.01             | <b>M3(see Fig B.3)</b> |
| 2636.5                       | 41055   | 31.62                 | 0.04             | <b>M3</b>              |
| 2593                         | 40620   | 31.21                 | 0.01             | <b>M3</b>              |
| 2549.5                       | 40185   | 31.39                 | -0.01            | <b>M3</b>              |
| 2506                         | 39750   | 31.52                 | 0.01             | <b>M3</b>              |
| <b>LTE Band 41 PC2 16QAM</b> |         |                       |                  |                        |
| 2680                         | 41490   | 32.15                 | -0.00            | <b>M3</b>              |
| 2636.5                       | 41055   | 30.81                 | 0.07             | <b>M3</b>              |
| 2593                         | 40620   | 30.41                 | 0.01             | <b>M3</b>              |
| 2549.5                       | 40185   | 30.56                 | -0.02            | <b>M3</b>              |
| 2506                         | 39750   | 30.65                 | -0.02            | <b>M3</b>              |
| <b>LTE Band 41 PC2 64QAM</b> |         |                       |                  |                        |
| 2680                         | 41490   | 30.92                 | -0.01            | <b>M3</b>              |
| 2636.5                       | 41055   | 29.49                 | 0.01             | <b>M4</b>              |
| 2593                         | 40620   | 29.15                 | 0.02             | <b>M4</b>              |
| 2549.5                       | 40185   | 29.47                 | 0.03             | <b>M4</b>              |
| 2506                         | 39750   | 29.39                 | 0.01             | <b>M4</b>              |
| <b>LTE Band 41 PC3 QPSK</b>  |         |                       |                  |                        |
| 2680                         | 41490   | 30.26                 | 0.01             | <b>M3(see Fig B.4)</b> |
| 2636.5                       | 41055   | 28.87                 | -0.03            | <b>M4</b>              |
| 2593                         | 40620   | 28.56                 | -0.02            | <b>M4</b>              |
| 2549.5                       | 40185   | 28.50                 | 0.02             | <b>M4</b>              |
| 2506                         | 39750   | 28.78                 | -0.03            | <b>M4</b>              |
| <b>LTE Band 41 PC3 16QAM</b> |         |                       |                  |                        |
| 2680                         | 41490   | 29.52                 | 0.02             | <b>M4</b>              |
| 2636.5                       | 41055   | 28.24                 | 0.01             | <b>M4</b>              |
| 2593                         | 40620   | 27.70                 | 0.04             | <b>M4</b>              |
| 2549.5                       | 40185   | 27.80                 | 0.01             | <b>M4</b>              |
| 2506                         | 39750   | 27.76                 | -0.04            | <b>M4</b>              |
| <b>LTE Band 41 PC3 64QAM</b> |         |                       |                  |                        |

|                     |       |       |       |                         |
|---------------------|-------|-------|-------|-------------------------|
| 2680                | 41490 | 28.10 | 0.02  | <b>M4</b>               |
| 2636.5              | 41055 | 26.65 | -0.04 | <b>M4</b>               |
| 2593                | 40620 | 26.35 | -0.02 | <b>M4</b>               |
| 2549.5              | 40185 | 26.61 | 0.00  | <b>M4</b>               |
| 2506                | 39750 | 26.46 | -0.03 | <b>M4</b>               |
| <b>WiFi2.4G 11b</b> |       |       |       |                         |
| 2462                | 11    | 20.37 | 0.06  | <b>M4</b>               |
| 2437                | 6     | 22.49 | 0.04  | <b>M4</b> (see Fig B.5) |
| 2412                | 1     | 21.40 | 0.03  | <b>M4</b>               |

Note: For LTE Band 41, UL-DL Configuration 1 was used to evaluate Power Class 2 and UL-DL Configuration 1 was used to evaluate Power Class 3.

### 13 ANSIC 63.19-2011 LIMITS

#### WD RF audio interference level categories in logarithmic units

| <b>Emission categories</b> | <b>&lt; 960 MHz</b> | <b>E-field emissions</b> |
|----------------------------|---------------------|--------------------------|
| Category M1                | 50 to 55            | dB (V/m)                 |
| Category M2                | 45 to 50            | dB (V/m)                 |
| Category M3                | 40 to 45            | dB (V/m)                 |
| Category M4                | < 40                | dB (V/m)                 |
| <b>Emission categories</b> | <b>&gt; 960 MHz</b> | <b>E-field emissions</b> |
| Category M1                | 40 to 45            | dB (V/m)                 |
| Category M2                | 35 to 40            | dB (V/m)                 |
| Category M3                | 30 to 35            | dB (V/m)                 |
| Category M4                | < 30                | dB (V/m)                 |



## 14 MEASUREMENT UNCERTAINTY

| No.                        | Error source                   | Type | Uncertainty Value(%) | Prob. Dist. | k          | c <sub>i</sub> E | Standard Uncertainty (%) $u_i$ ; (%)E | Degree of freedom $V_{eff}$ or $V_i$ |
|----------------------------|--------------------------------|------|----------------------|-------------|------------|------------------|---------------------------------------|--------------------------------------|
| <b>Measurement System</b>  |                                |      |                      |             |            |                  |                                       |                                      |
| 1                          | Probe Calibration              | B    | 5.                   | N           | 1          | 1                | 5.1                                   | ∞                                    |
| 2                          | Axial Isotropy                 | B    | 4.7                  | R           | $\sqrt{3}$ | 1                | 2.7                                   | ∞                                    |
| 3                          | Sensor Displacement            | B    | 16.5                 | R           | $\sqrt{3}$ | 1                | 9.5                                   | ∞                                    |
| 4                          | Boundary Effects               | B    | 2.4                  | R           | $\sqrt{3}$ | 1                | 1.4                                   | ∞                                    |
| 5                          | Linearity                      | B    | 4.7                  | R           | $\sqrt{3}$ | 1                | 2.7                                   | ∞                                    |
| 6                          | Scaling to Peak Envelope Power | B    | 2.0                  | R           | $\sqrt{3}$ | 1                | 1.2                                   | ∞                                    |
| 7                          | System Detection Limit         | B    | 1.0                  | R           | $\sqrt{3}$ | 1                | 0.6                                   | ∞                                    |
| 8                          | Readout Electronics            | B    | 0.3                  | N           | 1          | 1                | 0.3                                   | ∞                                    |
| 9                          | Response Time                  | B    | 0.8                  | R           | $\sqrt{3}$ | 1                | 0.5                                   | ∞                                    |
| 10                         | Integration Time               | B    | 2.6                  | R           | $\sqrt{3}$ | 1                | 1.5                                   | ∞                                    |
| 11                         | RF Ambient Conditions          | B    | 3.0                  | R           | $\sqrt{3}$ | 1                | 1.7                                   | ∞                                    |
| 12                         | RF Reflections                 | B    | 12.0                 | R           | $\sqrt{3}$ | 1                | 6.9                                   | ∞                                    |
| 13                         | Probe Positioner               | B    | 1.2                  | R           | $\sqrt{3}$ | 1                | 0.7                                   | ∞                                    |
| 14                         | Probe Positioning              | A    | 4.7                  | R           | $\sqrt{3}$ | 1                | 2.7                                   | ∞                                    |
| 15                         | Extra. And Interpolation       | B    | 1.0                  | R           | $\sqrt{3}$ | 1                | 0.6                                   | ∞                                    |
| <b>Test Sample Related</b> |                                |      |                      |             |            |                  |                                       |                                      |
| 16                         | Device Positioning Vertical    | B    | 4.7                  | R           | $\sqrt{3}$ | 1                | 2.7                                   | ∞                                    |
| 17                         | Device Positioning Lateral     | B    | 1.0                  | R           | $\sqrt{3}$ | 1                | 0.6                                   | ∞                                    |
| 18                         | Device Holder and Phantom      | B    | 2.4                  | R           | $\sqrt{3}$ | 1                | 1.4                                   | ∞                                    |
| 19                         | Power Drift                    | B    | 5.0                  | R           | $\sqrt{3}$ | 1                | 2.9                                   | ∞                                    |

|   |                   |              |     |   |            |   |      |          |
|---|-------------------|--------------|-----|---|------------|---|------|----------|
| 20  | AIA measurement   | B            | 12  | R | $\sqrt{3}$ | 1 | 6.9  | $\infty$ |
| <b>Phantom and Setup related</b>                      |                   |              |     |   |            |   |      |          |
| 21  | Phantom Thickness | B            | 2.4 | R | $\sqrt{3}$ | 1 | 1.4  | $\infty$ |
| Combined standard uncertainty(%)                      |                   |              |     |   |            |   | 16.2 |          |
| Expanded uncertainty<br>(confidence interval of 95 %) |                   | $u_e = 2u_c$ |     | N | k=2        |   | 32.4 |          |

## 15 MAIN TEST INSTRUMENTS

**Table 1: List of Main Instruments**

| No. | Name             | Type          | Serial Number | Calibration Date         | Valid Period |
|-----|------------------|---------------|---------------|--------------------------|--------------|
| 01  | Signal Generator | E4483C        | MY49071430    | January 13, 2022         | One Year     |
| 02  | Power meter      | NRP2          | 106277        | September 24, 2021       | One year     |
| 03  | Power sensor     | NRP8S         | 104291        |                          |              |
| 04  | Amplifier        | 60S1G4        | 0331848       | No Calibration Requested |              |
| 05  | E-Field Probe    | EF3DV3        | 4060          | May 13, 2022             | One year     |
| 06  | DAE              | SPEAG DAE4    | 1524          | October 08, 2021         | One year     |
| 07  | HAC Dipole       | CD835V3       | 1023          | August 24, 2021          | One year     |
| 08  | HAC Dipole       | CD1880V3      | 1018          | August 24, 2021          | One year     |
| 09  | HAC Dipole       | CD2450V3      | 1021          | August 24, 2021          | One year     |
| 10  | HAC Dipole       | CD2600V3      | 1017          | August 24, 2021          | One year     |
| 11  | BTS              | CMW500        | 166370        | June 28,2022             | One year     |
| 12  | AIA              | SE UMS 170 CB | 1029          | No Calibration Requested |              |

## 16 CONCLUSION

The HAC measurement indicates that the EUT complies with the HAC limits of the ANSIC63.19-2011. The total M-rating is **M3**.

\*\*\*END OF REPORT BODY\*\*\*

## ANNEX A TEST LAYOUT

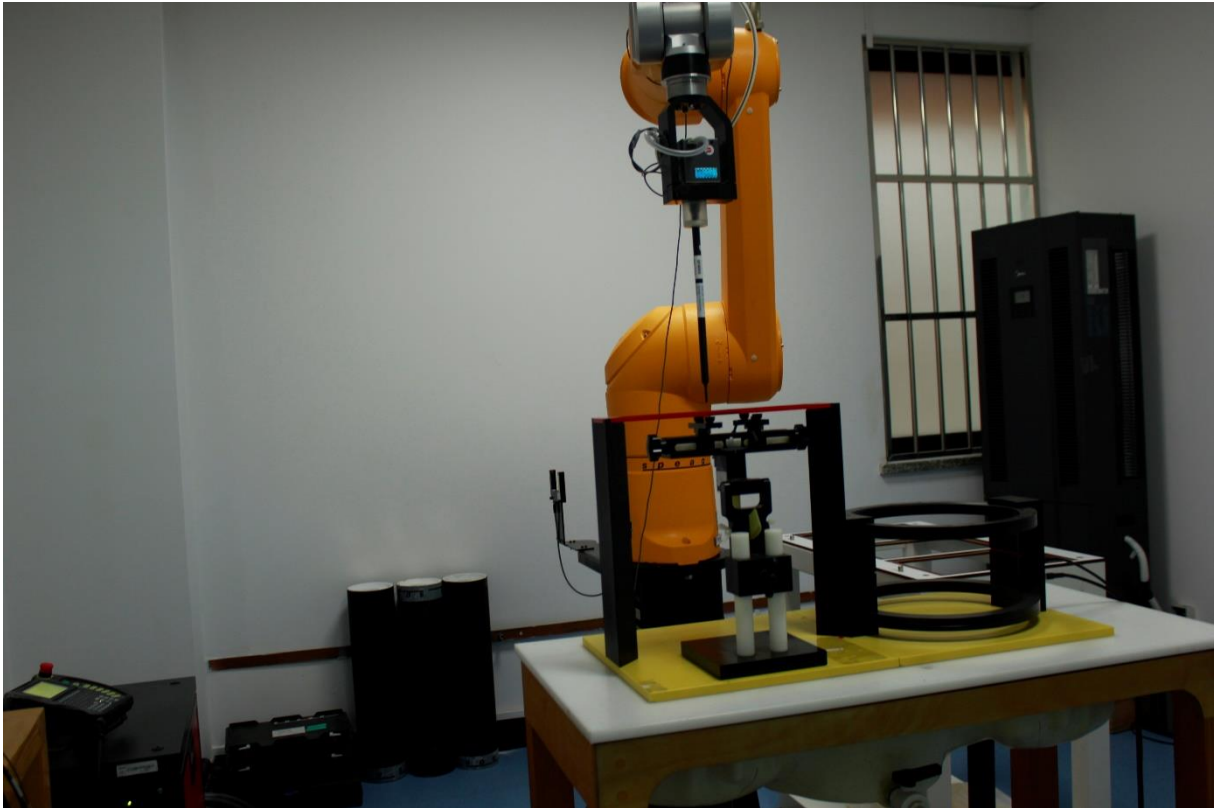

Picture A1:HAC RF System Layout

## ANNEX B TEST PLOTS

### HAC RF E-Field GSM 850

Date/Time: 2022-06-17

Electronics: DAE4 Sn1524

Medium: Air

Medium parameters used:  $\sigma = 0$  S/m,  $\epsilon_r = 1$ ;  $\rho = 1000$  kg/m<sup>3</sup>

Ambient Temperature: 23.3°C      Liquid Temperature: 22.5°C

Communication System: UID 0, 1GSM 850 (0) Frequency: 836.6 MHz Duty Cycle: 1:8.3

Probe: EF3DV3 - SN4060

E Scan - ER3DV6 - 2011: 15 mm from Probe Center to the Device

2/Hearing Aid Compatibility Test (101x101x1): Interpolated grid:

dx=0.5000 mm, dy=0.5000 mm

Device Reference Point: 0, 0, -6.3 mm

Reference Value = 44.78 V/m; Power Drift = -0.01 dB

Applied MIF = 3.60 dB

RF audio interference level = 35.31 dBV/m

Emission category: **M4**

MIF scaled E-field

|                                 |                                 |                                 |
|---------------------------------|---------------------------------|---------------------------------|
| Grid 1 <b>M4</b><br>35.23 dBV/m | Grid 2 <b>M4</b><br>35.23 dBV/m | Grid 3 <b>M4</b><br>33.35 dBV/m |
| Grid 4 <b>M4</b><br>35.32 dBV/m | Grid 5 <b>M4</b><br>35.31 dBV/m | Grid 6 <b>M4</b><br>33.77 dBV/m |
| Grid 7 <b>M4</b><br>35.26 dBV/m | Grid 8 <b>M4</b><br>35.26 dBV/m | Grid 9 <b>M4</b><br>33.91 dBV/m |

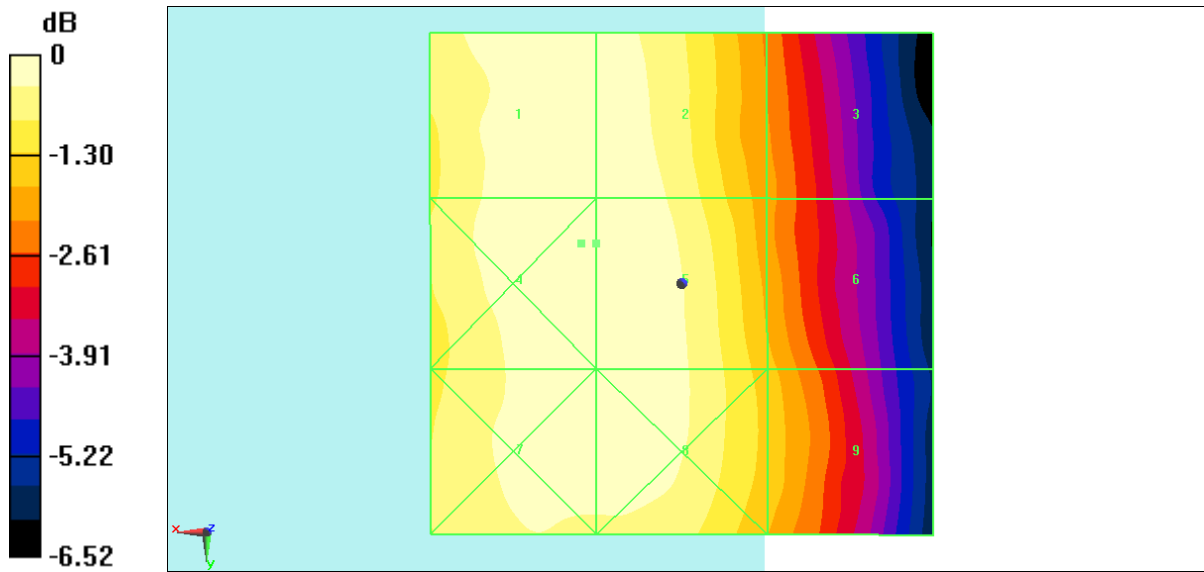

0 dB = 58.37 V/m = 35.32 dBV/m

**Fig B.1 HAC RF E-Field GSM 850**

**HAC RF E-Field GSM 1900**

Date: 2022-06-17

Electronics: DAE4 Sn1524

Medium: Air

Medium parameters used:  $\sigma = 0$  mho/m,  $\epsilon_r = 1$ ;  $\rho = 1000$  kg/m<sup>3</sup>

Ambient Temperature: 22.0°C

Communication System:GSM1900; Frequency: 1909.8 MHz; Duty Cycle: 1:8.3

Probe: EF3DV3 - SN4060;ConvF(1, 1, 1)

E Scan - ER3DV6 - 2011: 15 mm from Probe Center to the Device 2

2/Hearing Aid Compatibility Test (101x101x1): Interpolated grid:

dx=0.5000 mm, dy=0.5000 mm

Device Reference Point: 0, 0, -6.3 mm

Reference Value = 17.21 V/m; Power Drift = 0.03 dB

Applied MIF = 3.53 dB

RF audio interference level = 28.53 dBV/m

Emission category: **M4**

MIF scaled E-field

|                          |                          |                          |
|--------------------------|--------------------------|--------------------------|
| Grid 1 M4<br>27.09 dBV/m | Grid 2 M4<br>28.53 dBV/m | Grid 3 M4<br>28.31 dBV/m |
| Grid 4 M4<br>26.76 dBV/m | Grid 5 M4<br>27.71 dBV/m | Grid 6 M4<br>27.63 dBV/m |
| Grid 7 M4<br>28.06 dBV/m | Grid 8 M4<br>28.95 dBV/m | Grid 9 M4<br>28.67 dBV/m |

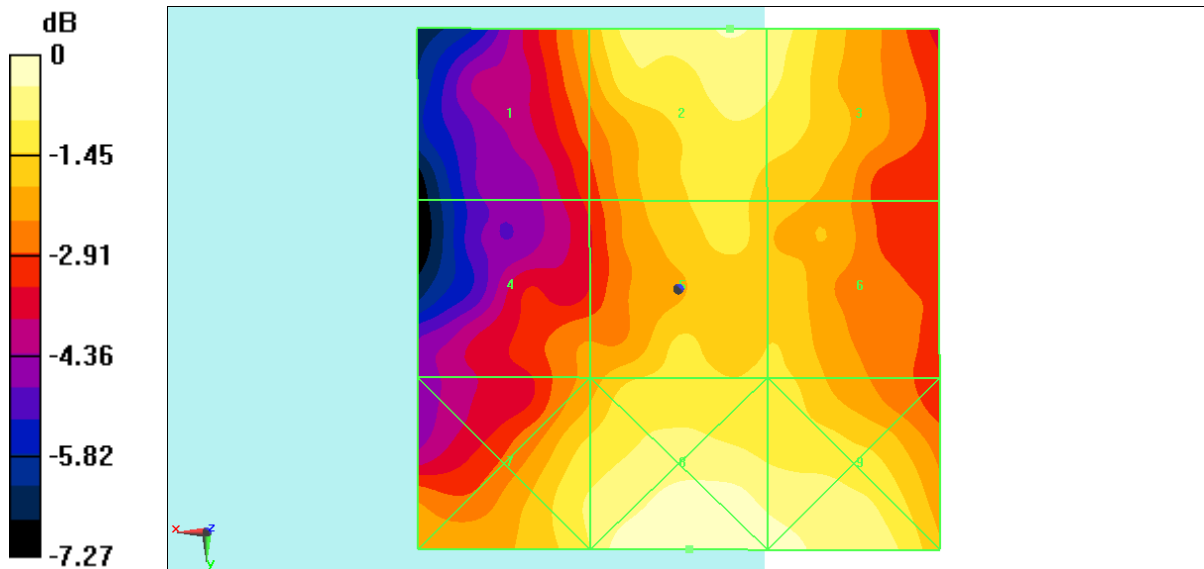

0 dB = 28.01 V/m = 28.95 dBV/m

**Fig B.2 HAC RF E-Field GSM1900**

**HAC RF E-Field LTE Band41 PC2 QPSK**

Date: 2022-06-17

Electronics: DAE4 Sn1524

Medium: Air

Medium parameters used:  $\sigma = 0$  mho/m,  $\epsilon_r = 1$ ;  $\rho = 1000$  kg/m<sup>3</sup>

Ambient Temperature: 22.0°C

Communication System: LTE Band41; Frequency: 2680MHz; Duty Cycle: 1:1.58

Probe: EF3DV3 - SN4060;ConvF(1, 1, 1)

E Scan - ER3DV6 - 2011: 15 mm from Probe Center to the

Device/Hearing Aid Compatibility Test (101x101x1): Interpolated

grid: dx=0.5000 mm, dy=0.5000 mm

Device Reference Point: 0, 0, -6.3 mm

Reference Value = 61.41 V/m; Power Drift = 0.01 dB

Applied MIF = -1.65 dB

RF audio interference level = 33.05 dBV/m

Emission category: **M3**

MIF scaled E-field

|                                 |                                 |                                 |
|---------------------------------|---------------------------------|---------------------------------|
| Grid 1 <b>M3</b><br>31.29 dBV/m | Grid 2 <b>M3</b><br>31.32 dBV/m | Grid 3 <b>M3</b><br>30.12 dBV/m |
| Grid 4 <b>M3</b><br>33.04 dBV/m | Grid 5 <b>M3</b><br>33.05 dBV/m | Grid 6 <b>M3</b><br>31.81 dBV/m |
| Grid 7 <b>M3</b><br>34.63 dBV/m | Grid 8 <b>M3</b><br>34.91 dBV/m | Grid 9 <b>M3</b><br>32.99 dBV/m |



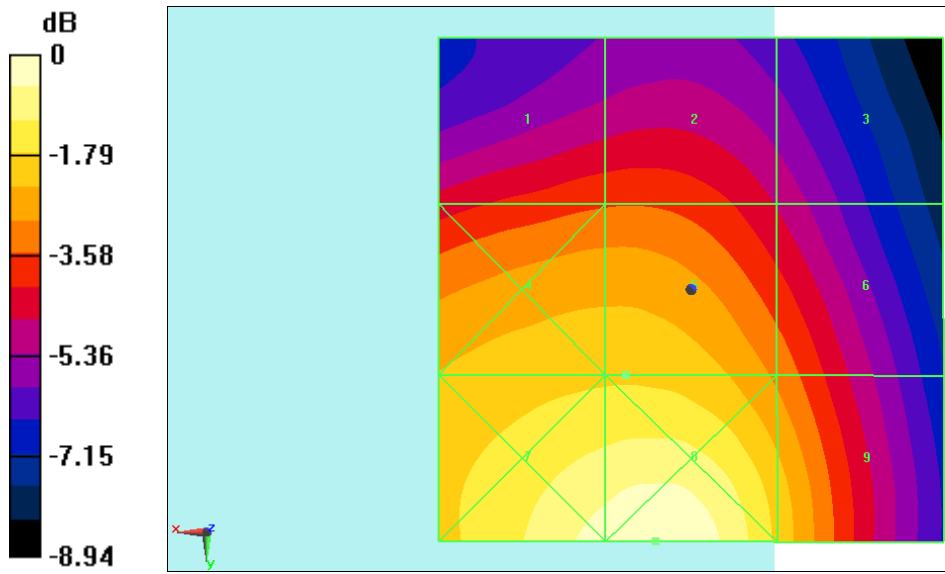

0 dB = 55.67 V/m = 34.91 dBV/m

**Fig B.3 HAC RF E-Field LTE Band41 PC2 QPSK**

**HAC RF E-Field LTE Band41 PC3 QPSK**

Date: 2022-06-17

Electronics: DAE4 Sn1524

Medium: Air

Medium parameters used:  $\sigma = 0$  mho/m,  $\epsilon_r = 1$ ;  $\rho = 1000$  kg/m<sup>3</sup>

Ambient Temperature: 22.0°C

Communication System: LTE Band41; Frequency: 2680 MHz; Duty Cycle: 1:1.58

Probe: EF3DV3 - SN4060;ConvF(1, 1, 1)

E Scan - ER3DV6 - 2011: 15 mm from Probe Center to the

Device/Hearing Aid Compatibility Test (101x101x1): Interpolated

grid: dx=0.5000 mm, dy=0.5000 mm

Device Reference Point: 0, 0, -6.3 mm

Reference Value = 54.44 V/m; Power Drift = 0.01 dB

Applied MIF = -3.31 dB

RF audio interference level = 30.26 dBV/m

Emission category: **M3**

MIF scaled E-field

|                                 |                                 |                                 |
|---------------------------------|---------------------------------|---------------------------------|
| Grid 1 <b>M4</b><br>28.52 dBV/m | Grid 2 <b>M4</b><br>28.57 dBV/m | Grid 3 <b>M4</b><br>27.42 dBV/m |
| Grid 4 <b>M3</b><br>30.26 dBV/m | Grid 5 <b>M3</b><br>30.26 dBV/m | Grid 6 <b>M4</b><br>29 dBV/m    |
| Grid 7 <b>M3</b><br>31.84 dBV/m | Grid 8 <b>M3</b><br>32.11 dBV/m | Grid 9 <b>M3</b><br>30.13 dBV/m |

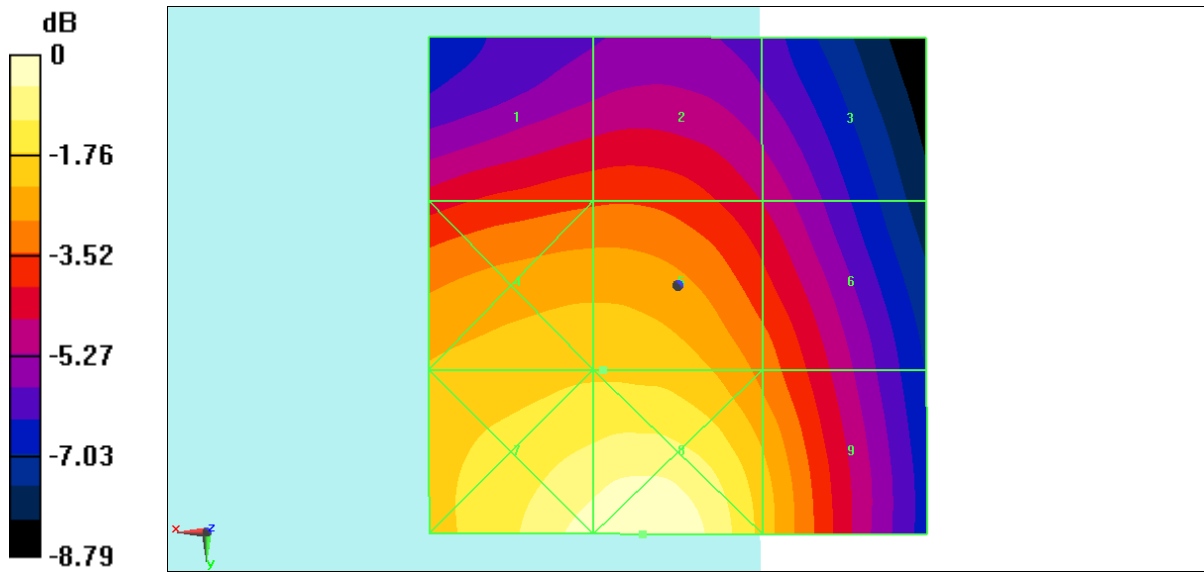

$0 \text{ dB} = 40.32 \text{ V/m} = 32.11 \text{ dBV/m}$

**Fig B.4 HAC RF E-Field LTE Band41 PC3 QPSK**

**HAC RF E-Field WIFI2.4G**

Date: 2022-07-07

Electronics: DAE4 Sn1524

Medium: Air

Medium parameters used:  $\sigma = 0$  mho/m,  $\epsilon_r = 1$ ;  $\rho = 1000$  kg/m<sup>3</sup>

Ambient Temperature: 22.0°C

Communication System: WIFI2.4G; Frequency: 2437 MHz; Duty Cycle: 1:1

Probe: EF3DV3 - SN4060

E Scan - ER3DV6 - 2011: 15 mm from Probe Center to the

Device/Hearing Aid Compatibility Test (101x101x1): Interpolated

grid: dx=0.5000 mm, dy=0.5000 mm

Device Reference Point: 0, 0, -6.3 mm

Reference Value = 37.55 V/m; Power Drift = 0.04 dB

Applied MIF = -7.71 dB

RF audio interference level = 22.49 dBV/m

Emission category: **M4**

MIF scaled E-field

|                                 |                                 |                                 |
|---------------------------------|---------------------------------|---------------------------------|
| Grid 1 <b>M4</b><br>20.85 dBV/m | Grid 2 <b>M4</b><br>21.29 dBV/m | Grid 3 <b>M4</b><br>20.69 dBV/m |
| Grid 4 <b>M4</b><br>21.96 dBV/m | Grid 5 <b>M4</b><br>22.49 dBV/m | Grid 6 <b>M4</b><br>21.82 dBV/m |
| Grid 7 <b>M4</b><br>22.32 dBV/m | Grid 8 <b>M4</b><br>22.92 dBV/m | Grid 9 <b>M4</b><br>22.1 dBV/m  |

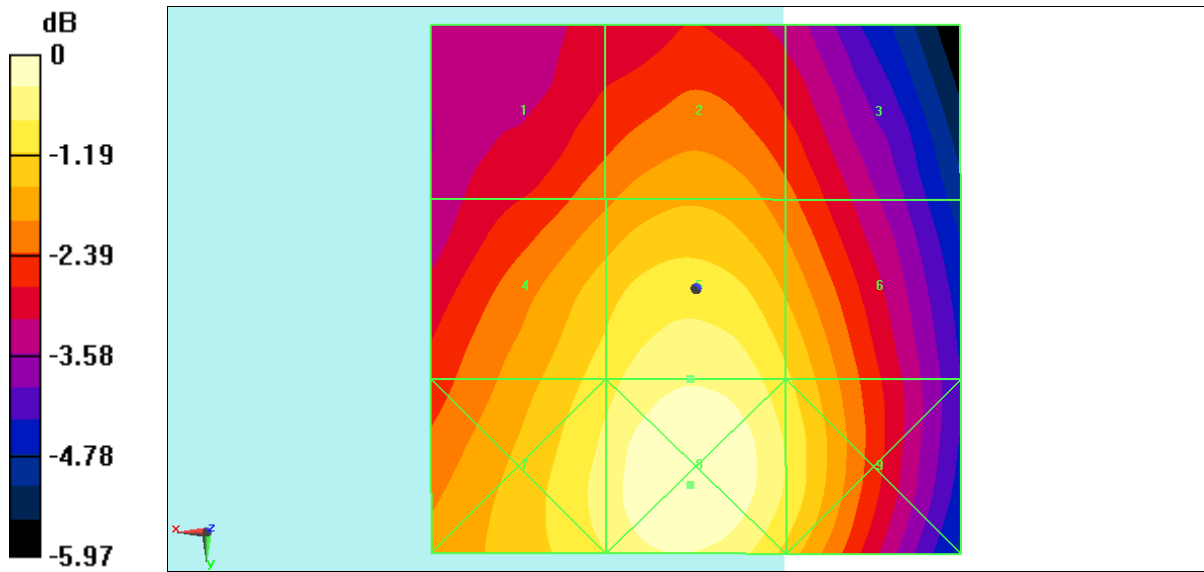

**Fig B.5 HAC RF E-Field WIFI2.4G**

## ANNEX C SYSTEM VALIDATION RESULT

### E SCAN of Dipole 835 MHz

Date: 2022-06-17

Electronics: DAE4 Sn1524

Medium: Air

Medium parameters used:  $\sigma = 0$  mho/m,  $\epsilon_r = 1$ ;  $\rho = 1000$  kg/m<sup>3</sup>

Communication System: CW; Frequency: 835 MHz; Duty Cycle: 1:1

Probe: EF3DV3 - SN4060

**E Scan - measurement distance from the probe sensor center to CD835 = 15mm/Hearing Aid Compatibility Test at 15mm distance (41x361x1):** Interpolated

grid: dx=0.5000 mm, dy=0.5000 mm

Device Reference Point: 0, 0, -6.3 mm

Reference Value = 126.8 V/m; Power Drift = 0.02 dB

Applied MIF = 0.00 dB

RF audio interference level = 40.67 dBV/m

Emission category: **M3**

MIF scaled E-field

|                                 |                                 |                                 |
|---------------------------------|---------------------------------|---------------------------------|
| Grid 1 <b>M3</b><br>40.85 dBV/m | Grid 2 <b>M3</b><br>40.95 dBV/m | Grid 3 <b>M3</b><br>40.76 dBV/m |
| Grid 4 <b>M4</b><br>36.05 dBV/m | Grid 5 <b>M4</b><br>36.19 dBV/m | Grid 6 <b>M4</b><br>36.09 dBV/m |
| Grid 7 <b>M3</b><br>40.5 dBV/m  | Grid 8 <b>M3</b><br>40.67 dBV/m | Grid 9 <b>M3</b><br>40.52 dBV/m |

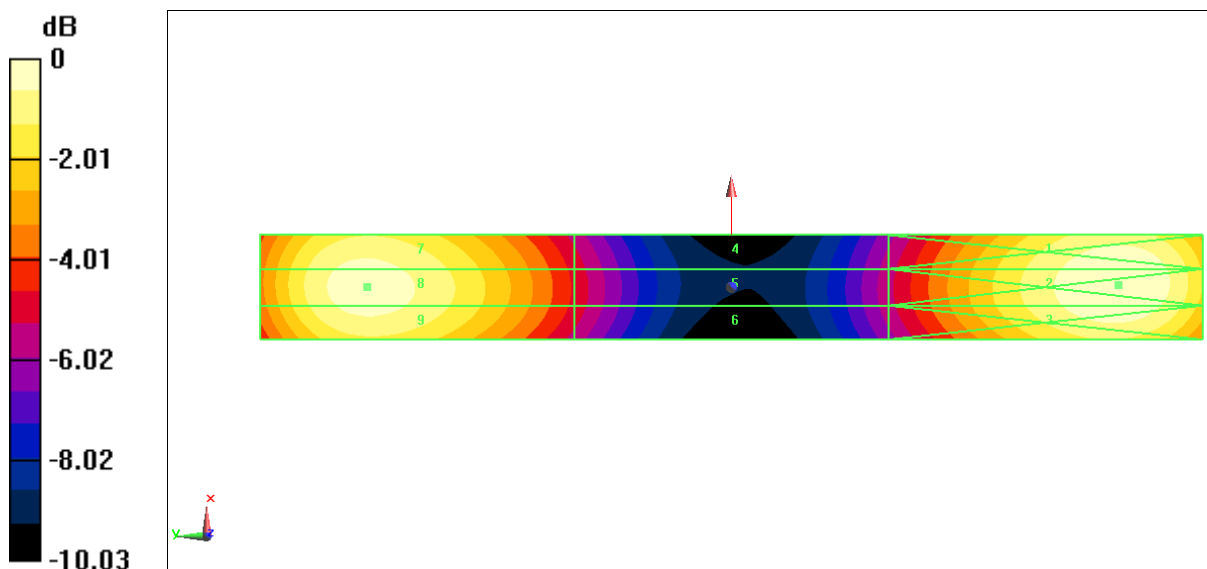

$$0 \text{ dB} = 111.6 \text{ V/m} = 40.95 \text{ dBV/m}$$

**E SCAN of Dipole 1800 MHz**
**Date: 2022-06-17**

Electronics: DAE4 Sn1524

Medium: Air

 Medium parameters used:  $\sigma = 0$  mho/m,  $\epsilon_r = 1$ ;  $\rho = 1000$  kg/m<sup>3</sup>

Communication System: CW; Frequency: 1880 MHz; Duty Cycle: 1:1

Probe: EF3DV3 - SN4060

**E Scan - measurement distance from the probe sensor center to CD1880 = 15mm**
**2/Hearing Aid Compatibility Test at 15mm distance (41x181x1):** Interpolated grid:

dx=0.5000 mm, dy=0.5000 mm

Device Reference Point: 0, 0, -6.3 mm

Reference Value = 119.3 V/m; Power Drift = 0.03 dB

Applied MIF = 0.00 dB

RF audio interference level = 38.35 dBV/m

**Emission category: M2**

MIF scaled E-field

|  |  |  |
|--|--|--|
| Grid 1 <b>M2</b><br><b>39.05 dBV/m</b> | Grid 2 <b>M2</b><br><b>39.11 dBV/m</b> | Grid 3 <b>M2</b><br><b>38.83 dBV/m</b> |
| Grid 4 <b>M2</b><br><b>36.56 dBV/m</b> | Grid 5 <b>M2</b><br><b>36.65 dBV/m</b> | Grid 6 <b>M2</b><br><b>36.58 dBV/m</b> |
| Grid 7 <b>M2</b><br><b>38.2 dBV/m</b>  | Grid 8 <b>M2</b><br><b>38.35 dBV/m</b> | Grid 9 <b>M2</b><br><b>38.23 dBV/m</b> |

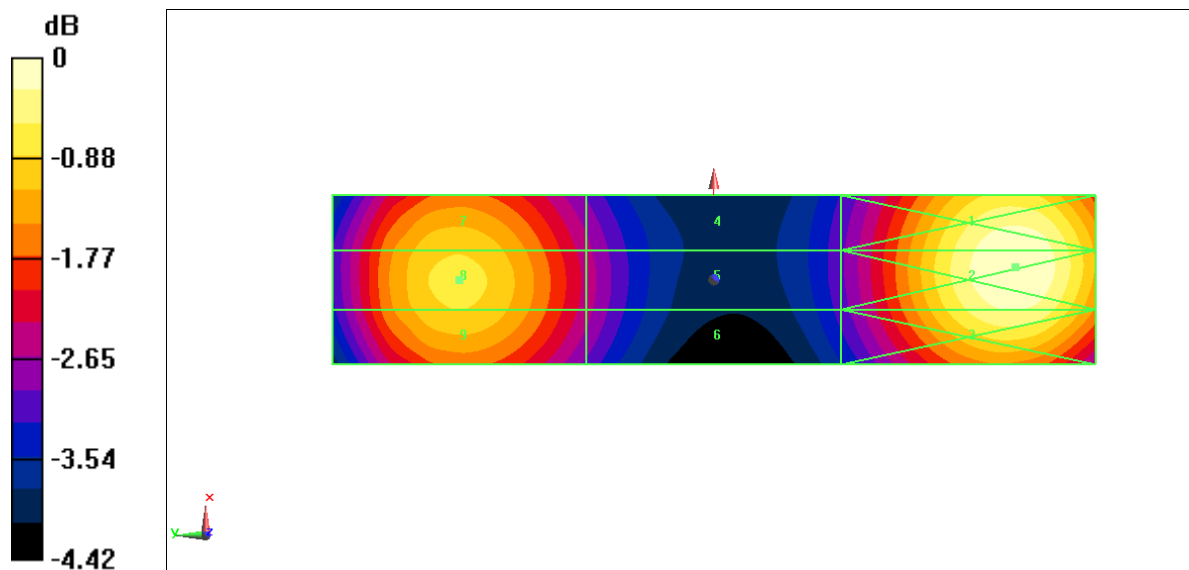

$$0 \text{ dB} = 90.21 \text{ V/m} = 39.11 \text{ dBV/m}$$

**E SCAN of Dipole 2450 MHz**
**Date: 2022-07-17**

Electronics: DAE4 Sn1524

Medium: Air

 Medium parameters used:  $\sigma = 0$  mho/m,  $\epsilon_r = 1$ ;  $\rho = 1000$  kg/m<sup>3</sup>

Communication System: CW; Frequency: 2450 MHz; Duty Cycle: 1:1

Probe: EF3DV3 - SN4060

**E Scan - measurement distance from the probe sensor center to CD2450 = 15mm/Hearing Aid Compatibility Test at 15mm distance (41x181x1):** Interpolated grid: dx=0.5000 mm, dy=0.5000 mm

Device Reference Point: 0, 0, -6.3 mm

Reference Value = 66.49 V/m; Power Drift = 0.03 dB

Applied MIF = 0.00 dB

RF audio interference level = 38.25 dBV/m

**Emission category: M2**

MIF scaled E-field

|  |  |  |
|--|--|--|
| Grid 1 <b>M2</b><br><b>38.43 dBV/m</b> | Grid 2 <b>M2</b><br><b>38.53 dBV/m</b> | Grid 3 <b>M2</b><br><b>38.34 dBV/m</b> |
| Grid 4 <b>M2</b><br><b>37.73 dBV/m</b> | Grid 5 <b>M2</b><br><b>37.83 dBV/m</b> | Grid 6 <b>M2</b><br><b>37.7 dBV/m</b>  |
| Grid 7 <b>M2</b><br><b>38.14 dBV/m</b> | Grid 8 <b>M2</b><br><b>38.25 dBV/m</b> | Grid 9 <b>M2</b><br><b>38.09 dBV/m</b> |

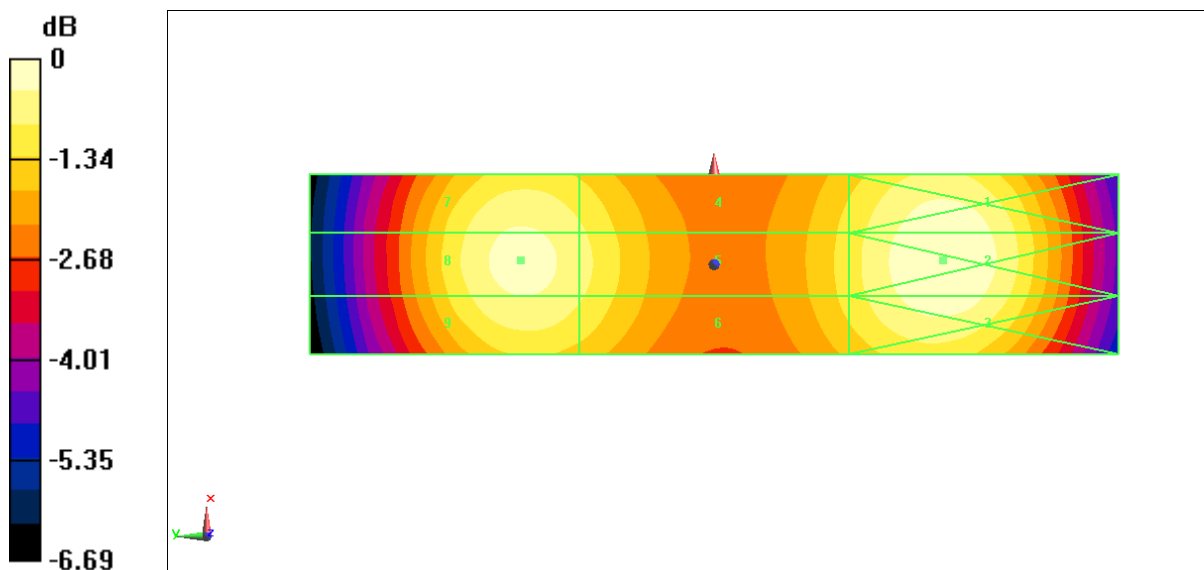

$$0 \text{ dB} = 84.43 \text{ V/m} = 38.53 \text{ dBV/m}$$



**E SCAN of Dipole 2600 MHz**

**Date: 2022-06-17**

Electronics: DAE4 Sn1524

Medium: Air

Medium parameters used:  $\sigma = 0$  mho/m,  $\epsilon_r = 1$ ;  $\rho = 1000$  kg/m<sup>3</sup>

Communication System: CW; Frequency: 2600 MHz; Duty Cycle: 1:1

Probe: EF3DV3 - SN4060

**E Scan - measurement distance from the probe sensor center to CD2600 = 15mm/Hearing Aid Compatibility Test at 15mm distance (41x141x1):** Interpolated grid: dx=0.5000 mm, dy=0.5000 mm

Device Reference Point: 0, 0, -6.3 mm

Reference Value = 60.03 V/m; Power Drift = 0.09 dB

Applied MIF = 0.00 dB

RF audio interference level = 38.34 dBV/m

**Emission category: M2**

MIF scaled E-field

|  |  |  |
|--|--|--|
| Grid 1 <b>M2</b><br><b>38.44 dBV/m</b> | Grid 2 <b>M2</b><br><b>38.54 dBV/m</b> | Grid 3 <b>M2</b><br><b>38.38 dBV/m</b> |
| Grid 4 <b>M2</b><br><b>37.72 dBV/m</b> | Grid 5 <b>M2</b><br><b>37.78 dBV/m</b> | Grid 6 <b>M2</b><br><b>37.67 dBV/m</b> |
| Grid 7 <b>M2</b><br><b>38.22 dBV/m</b> | Grid 8 <b>M2</b><br><b>38.34 dBV/m</b> | Grid 9 <b>M2</b><br><b>38.15 dBV/m</b> |

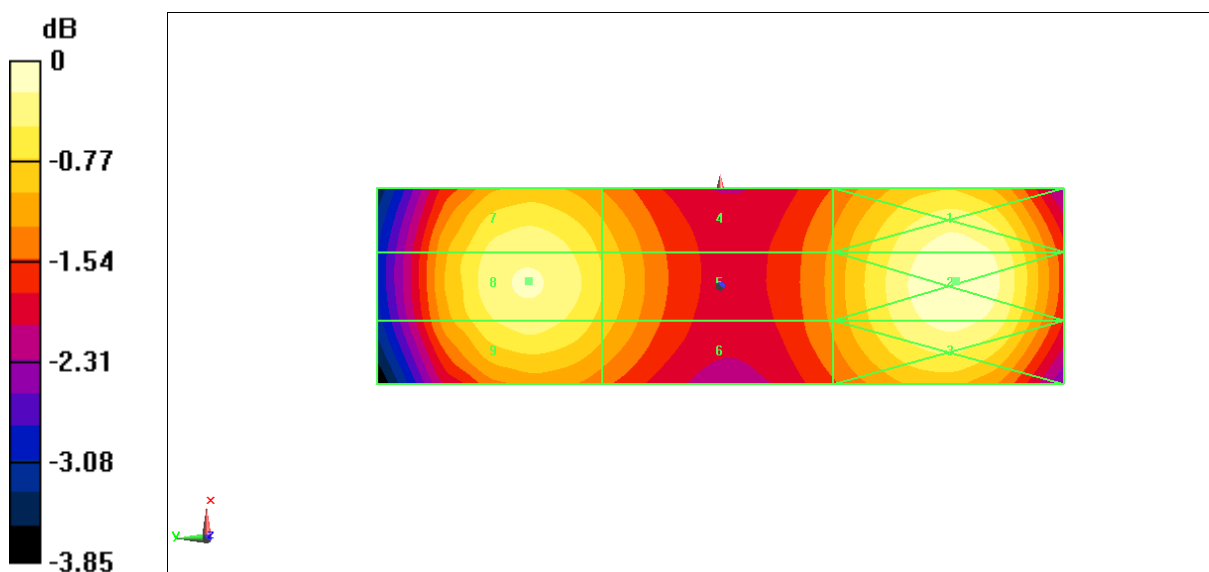

$$0 \text{ dB} = 84.54 \text{ V/m} = 38.54 \text{ dBV/m}$$

# ANNEX D PROBE CALIBRATION CERTIFICATE

**Calibration Laboratory of**  
**Schmid & Partner**  
**Engineering AG**  
 Zeughausstrasse 43, 8004 Zurich, Switzerland



**S** Schweizerischer Kalibrierdienst  
**C** Service suisse d'étalonnage  
**S** Servizio svizzero di taratura  
 Swiss Calibration Service

Accredited by the Swiss Accreditation Service (SAS)  
 The Swiss Accreditation Service is one of the signatories to the EA  
 Multilateral Agreement for the recognition of calibration certificates

Accreditation No.: SCS 0108

Client **CTTL (Auden)**

Certificate No: **EF3-4060\_May22**

## CALIBRATION CERTIFICATE

Object: **EF3DV3- SN:4060**

Calibration procedure(s): **QA CAL-02.v9, QA CAL-25.v7**  
 Calibration procedure for E-field probes optimized for close near field evaluations in air

Calibration date: **May 13, 2022**

This calibration certificate documents the traceability to national standards, which realize the physical units of measurements (SI).  
 The measurements and the uncertainties with confidence probability are given on the following pages and are part of the certificate.

All calibrations have been conducted in the closed laboratory facility: environment temperature (22 ± 3)°C and humidity < 70%.

Calibration Equipment used (M&TE critical for calibration)

| Primary Standards          | ID               | Cal Date (Certificate No.)        | Scheduled Calibration  |
|----------------------------|------------------|-----------------------------------|------------------------|
| Power meter NRP            | SN: 104778       | 04-Apr-22 (No. 217-03525/03524)   | Apr-23                 |
| Power sensor NRP-Z91       | SN: 103244       | 04-Apr-22 (No. 217-03524)         | Apr-23                 |
| Power sensor NRP-Z91       | SN: 103245       | 04-Apr-22 (No. 217-03525)         | Apr-23                 |
| Reference 20 dB Attenuator | SN: CC2552 (20x) | 04-Apr-22 (No. 217-03527)         | Apr-23                 |
| DAE4                       | SN: 789          | 24-Dec-21 (No. DAE4-789_Dec21)    | Dec-22                 |
| Reference Probe ER3DV6     | SN: 2328         | 08-Oct-21 (No. ER3-2328_Oct21)    | Oct-22                 |
| Secondary Standards        | ID               | Check Date (in house)             | Scheduled Check        |
| Power meter E4419B         | SN: GB41293874   | 06-Apr-16 (in house check Jun-20) | In house check: Jun-22 |
| Power sensor E4412A        | SN: MY41498087   | 06-Apr-16 (in house check Jun-20) | In house check: Jun-22 |
| Power sensor E4412A        | SN: 000110210    | 06-Apr-16 (in house check Jun-20) | In house check: Jun-22 |
| RF generator HP 8648C      | SN: US3642U01700 | 04-Aug-99 (in house check Jun-20) | In house check: Jun-22 |
| Network Analyzer E8358A    | SN: US41080477   | 31-Mar-14 (in house check Oct-20) | In house check: Oct-22 |

|                |                         |                                   |               |
|----------------|-------------------------|-----------------------------------|---------------|
| Calibrated by: | Name<br>Jeffrey Katzman | Function<br>Laboratory Technician | Signature<br> |
| Approved by:   | Sven Kühn               | Technical Manager                 |               |

Issued: May 13, 2022

This calibration certificate shall not be reproduced except in full without written approval of the laboratory.

**Calibration Laboratory of**  
Schmid & Partner  
Engineering AG  
Zeughausstrasse 43, 8004 Zurich, Switzerland



**S** Schweizerischer Kalibrierdienst  
**C** Service suisse d'étalonnage  
**S** Servizio svizzero di taratura  
**S** Swiss Calibration Service

Accredited by the Swiss Accreditation Service (SAS)

Accreditation No.: **SCS 0108**

The Swiss Accreditation Service is one of the signatories to the EA  
Multilateral Agreement for the recognition of calibration certificates

#### Glossary:

|                          |   |
|--------------------------|---|
| NORM <sub>x,y,z</sub>    | sensitivity in free space   |
| DCP                      | diode compression point   |
| CF                       | crest factor (1/duty_cycle) of the RF signal  |
| A, B, C, D               | modulation dependent linearization parameters   |
| En                       | incident E-field orientation normal to probe axis   |
| Ep                       | incident E-field orientation parallel to probe axis   |
| Polarization $\varphi$   | $\varphi$ rotation around probe axis  |
| Polarization $\vartheta$ | $\vartheta$ rotation around an axis that is in the plane normal to probe axis (at measurement center),<br>i.e., $\vartheta = 0$ is normal to probe axis |
| Connector Angle          | information used in DASY system to align probe sensor X to the robot coordinate system  |

#### Calibration is Performed According to the Following Standards:

- IEEE Std 1309-2005, " IEEE Standard for calibration of electromagnetic field sensors and probes, excluding antennas, from 9 kHz to 40 GHz", December 2005
- CTIA Test Plan for Hearing Aid Compatibility, Rev 3.1.1, May 2017

#### Methods Applied and Interpretation of Parameters:

- NORM<sub>x,y,z</sub>**: Assessed for E-field polarization  $\vartheta = 0$  for XY sensors and  $\vartheta = 90$  for Z sensor ( $f \leq 900$  MHz in TEM-cell;  $f > 1800$  MHz: R22 waveguide).
- NORM(f)<sub>x,y,z</sub>** = **NORM<sub>x,y,z</sub>** \* *frequency\_response* (see Frequency Response Chart).
- DCP<sub>x,y,z</sub>**: DCP are numerical linearization parameters assessed based on the data of power sweep with CW signal (no uncertainty required). DCP does not depend on frequency nor media.
- PAR**: PAR is the Peak to Average Ratio that is not calibrated but determined based on the signal characteristics
- A<sub>x,y,z</sub>; B<sub>x,y,z</sub>; C<sub>x,y,z</sub>; D<sub>x,y,z</sub>; VR<sub>x,y,z</sub>**: A, B, C, D are numerical linearization parameters assessed based on the data of power sweep for specific modulation signal. The parameters do not depend on frequency nor media. VR is the maximum calibration range expressed in RMS voltage across the diode.
- Spherical isotropy (3D deviation from isotropy)**: in a locally homogeneous field realized using an open waveguide setup.
- Sensor Offset**: The sensor offset corresponds to the offset of virtual measurement center from the probe tip (on probe axis). No tolerance required.
- Connector Angle**: The angle is assessed using the information gained by determining the **NORM<sub>x</sub>** (no uncertainty required).

EF3DV3 – SN:4060

May 13, 2022

## DASY/EASY - Parameters of Probe: EF3DV3 - SN:4060

### Basic Calibration Parameters

|                                       | Sensor X | Sensor Y | Sensor Z | Unc (k=2)    |
|---------------------------------------|----------|----------|----------|--------------|
| Norm ( $\mu\text{V}/(\text{V/m})^2$ ) | 0.80     | 0.74     | 1.29     | $\pm 10.1\%$ |
| DCP (mV) <sup>B</sup>                 | 94.7     | 96.7     | 93.6     |              |

### Calibration results for Frequency Response (30 MHz – 6 GHz)

| Frequency MHz | Target E-Field V/m | Measured E-field (En) V/m | Deviation E-normal in % | Measured E-field (Ep) V/m | Deviation E-normal in % | Unc (k=2) % |
|---------------|--------------------|---------------------------|-------------------------|---------------------------|-------------------------|-------------|
| 30            | 77.1               | 77.3                      | 0.2%                    | 76.9                      | -0.3%                   | $\pm 5.1\%$ |
| 100           | 77.0               | 78.0                      | 1.2%                    | 77.9                      | 1.1%                    | $\pm 5.1\%$ |
| 450           | 77.1               | 78.0                      | 1.1%                    | 78.0                      | 1.2%                    | $\pm 5.1\%$ |
| 600           | 77.2               | 77.6                      | 0.5%                    | 77.6                      | 0.6%                    | $\pm 5.1\%$ |
| 750           | 77.2               | 77.3                      | 0.1%                    | 77.2                      | 0.1%                    | $\pm 5.1\%$ |
| 1800          | 143.1              | 139.7                     | -2.4%                   | 139.7                     | -2.4%                   | $\pm 5.1\%$ |
| 2000          | 134.9              | 129.1                     | -4.3%                   | 129.3                     | -4.1%                   | $\pm 5.1\%$ |
| 2200          | 127.7              | 124.4                     | -2.5%                   | 125.4                     | -1.8%                   | $\pm 5.1\%$ |
| 2500          | 125.4              | 119.9                     | -4.4%                   | 121.0                     | -3.5%                   | $\pm 5.1\%$ |
| 3000          | 79.0               | 75.6                      | -4.3%                   | 76.7                      | -2.9%                   | $\pm 5.1\%$ |
| 3500          | 256.1              | 256.6                     | 0.2%                    | 253.2                     | -1.1%                   | $\pm 5.1\%$ |
| 3700          | 249.6              | 246.9                     | -1.1%                   | 245.0                     | -1.8%                   | $\pm 5.1\%$ |
| 5200          | 50.8               | 50.7                      | -0.1%                   | 51.0                      | 0.4%                    | $\pm 5.1\%$ |
| 5500          | 49.6               | 48.7                      | -1.7%                   | 47.4                      | -4.4%                   | $\pm 5.1\%$ |
| 5800          | 48.9               | 47.9                      | -2.0%                   | 49.0                      | 0.3%                    | $\pm 5.1\%$ |

The reported uncertainty of measurement is stated as the standard uncertainty of measurement multiplied by the coverage factor k=2, which for a normal distribution corresponds to a coverage probability of approximately 95%.

<sup>B</sup> Numerical linearization parameter: uncertainty not required.

<sup>E</sup> Uncertainty is determined using the max. deviation from linear response applying rectangular distribution and is expressed for the square of the field value.



EF3DV3 – SN:4060

May 13, 2022

**DASY/EASY - Parameters of Probe: EF3DV3 - SN:4060**
**Calibration Results for Modulation Response**

| UID       | Communication System Name   |   | A<br>dB | B<br>dB $\sqrt{\mu}$ V | C     | D<br>dB | VR<br>mV | Max<br>dev.  | Max<br>Unc <sup>E</sup><br>(k=2) |
|-----------|-----------------------------|---|---------|------------------------|-------|---------|----------|--------------|----------------------------------|
| 0         | CW                          | X | 0.00    | 0.00                   | 1.00  | 0.00    | 128.5    | $\pm 2.5 \%$ | $\pm 4.7 \%$                     |
|           |                             | Y | 0.00    | 0.00                   | 1.00  |         | 161.6    |              |                                  |
|           |                             | Z | 0.00    | 0.00                   | 1.00  |         | 126.0    |              |                                  |
| 10352-AAA | Pulse Waveform (200Hz, 10%) | X | 2.86    | 66.73                  | 10.11 | 10.00   | 60.0     | $\pm 2.7 \%$ | $\pm 9.6 \%$                     |
|           |                             | Y | 3.19    | 67.88                  | 10.96 |         | 60.0     |              |                                  |
|           |                             | Z | 2.92    | 66.86                  | 10.24 |         | 60.0     |              |                                  |
| 10353-AAA | Pulse Waveform (200Hz, 20%) | X | 1.64    | 64.88                  | 8.36  | 6.99    | 80.0     | $\pm 1.1 \%$ | $\pm 9.6 \%$                     |
|           |                             | Y | 1.94    | 66.74                  | 9.54  |         | 80.0     |              |                                  |
|           |                             | Z | 1.54    | 64.64                  | 8.24  |         | 80.0     |              |                                  |
| 10354-AAA | Pulse Waveform (200Hz, 40%) | X | 0.95    | 64.46                  | 7.35  | 3.98    | 95.0     | $\pm 0.9 \%$ | $\pm 9.6 \%$                     |
|           |                             | Y | 1.89    | 70.07                  | 9.92  |         | 95.0     |              |                                  |
|           |                             | Z | 0.67    | 62.65                  | 6.36  |         | 95.0     |              |                                  |
| 10355-AAA | Pulse Waveform (200Hz, 60%) | X | 20.00   | 83.48                  | 12.24 | 2.22    | 120.0    | $\pm 0.9 \%$ | $\pm 9.6 \%$                     |
|           |                             | Y | 20.00   | 88.16                  | 14.35 |         | 120.0    |              |                                  |
|           |                             | Z | 0.51    | 63.43                  | 5.89  |         | 120.0    |              |                                  |
| 10387-AAA | QPSK Waveform, 1 MHz        | X | 2.22    | 73.26                  | 18.56 | 1.00    | 150.0    | $\pm 2.2 \%$ | $\pm 9.6 \%$                     |
|           |                             | Y | 1.80    | 69.14                  | 16.22 |         | 150.0    |              |                                  |
|           |                             | Z | 1.87    | 70.42                  | 16.69 |         | 150.0    |              |                                  |
| 10388-AAA | QPSK Waveform, 10 MHz       | X | 2.71    | 72.48                  | 18.53 | 0.00    | 150.0    | $\pm 1.0 \%$ | $\pm 9.6 \%$                     |
|           |                             | Y | 2.34    | 69.47                  | 16.72 |         | 150.0    |              |                                  |
|           |                             | Z | 2.39    | 70.19                  | 17.11 |         | 150.0    |              |                                  |
| 10396-AAA | 64-QAM Waveform, 100 kHz    | X | 2.23    | 68.63                  | 18.88 | 3.01    | 150.0    | $\pm 2.2 \%$ | $\pm 9.6 \%$                     |
|           |                             | Y | 1.81    | 65.44                  | 17.77 |         | 150.0    |              |                                  |
|           |                             | Z | 2.18    | 68.07                  | 18.09 |         | 150.0    |              |                                  |
| 10399-AAA | 64-QAM Waveform, 40 MHz     | X | 3.72    | 68.50                  | 16.96 | 0.00    | 150.0    | $\pm 1.1 \%$ | $\pm 9.6 \%$                     |
|           |                             | Y | 3.49    | 67.25                  | 16.05 |         | 150.0    |              |                                  |
|           |                             | Z | 3.54    | 67.62                  | 16.30 |         | 150.0    |              |                                  |
| 10414-AAA | WLAN CCDF, 64-QAM, 40MHz    | X | 4.78    | 65.89                  | 16.06 | 0.00    | 150.0    | $\pm 2.5 \%$ | $\pm 9.6 \%$                     |
|           |                             | Y | 4.77    | 65.81                  | 15.78 |         | 150.0    |              |                                  |
|           |                             | Z | 4.63    | 65.46                  | 15.68 |         | 150.0    |              |                                  |

Note: For details on UID parameters see Appendix

The reported uncertainty of measurement is stated as the standard uncertainty of measurement multiplied by the coverage factor  $k=2$ , which for a normal distribution corresponds to a coverage probability of approximately 95%.

<sup>B</sup> Numerical linearization parameter: uncertainty not required.

<sup>E</sup> Uncertainty is determined using the max. deviation from linear response applying rectangular distribution and is expressed for the square of the field value.

EF3DV3 – SN:4060

May 13, 2022

## DASY/EASY - Parameters of Probe: EF3DV3 - SN:4060

### Sensor Frequency Model Parameters

|                      | Sensor X | Sensor Y | Sensor Z |
|----------------------|----------|----------|----------|
| Frequency Corr. (LF) | 0.11     | 0.19     | 4.60     |
| Frequency Corr. (HF) | 2.82     | 2.82     | 2.82     |

### Sensor Model Parameters

|   | C1<br>fF | C2<br>fF | $\alpha$<br>$V^{-1}$ | T1<br>$ms.V^{-2}$ | T2<br>$ms.V^{-1}$ | T3<br>ms | T4<br>$V^{-2}$ | T5<br>$V^{-1}$ | T6   |
|---|----------|----------|----------------------|-------------------|-------------------|----------|----------------|----------------|------|
| X | 38.6     | 259.37   | 38.06                | 6.78              | 0.04              | 4.96     | 0.19           | 0.13           | 1.00 |
| Y | 38.1     | 250.89   | 36.65                | 4.87              | 0.03              | 4.98     | 0.00           | 0.00           | 1.01 |
| Z | 35.7     | 239.69   | 37.83                | 4.44              | 0.04              | 4.97     | 0.47           | 0.08           | 1.00 |

### Other Probe Parameters

|   |             |
|---|-------------|
| Sensor Arrangement                      | Rectangular |
| Connector Angle (°)                     | 145.7       |
| Mechanical Surface Detection Mode       | enabled     |
| Optical Surface Detection Mode          | disabled    |
| Probe Overall Length                    | 337 mm      |
| Probe Body Diameter                     | 12 mm       |
| Tip Length                              | 25 mm       |
| Tip Diameter                            | 4 mm        |
| Probe Tip to Sensor X Calibration Point | 1.5 mm      |
| Probe Tip to Sensor Y Calibration Point | 1.5 mm      |
| Probe Tip to Sensor Z Calibration Point | 1.5 mm      |

EF3DV3 – SN:4060

May 13, 2022

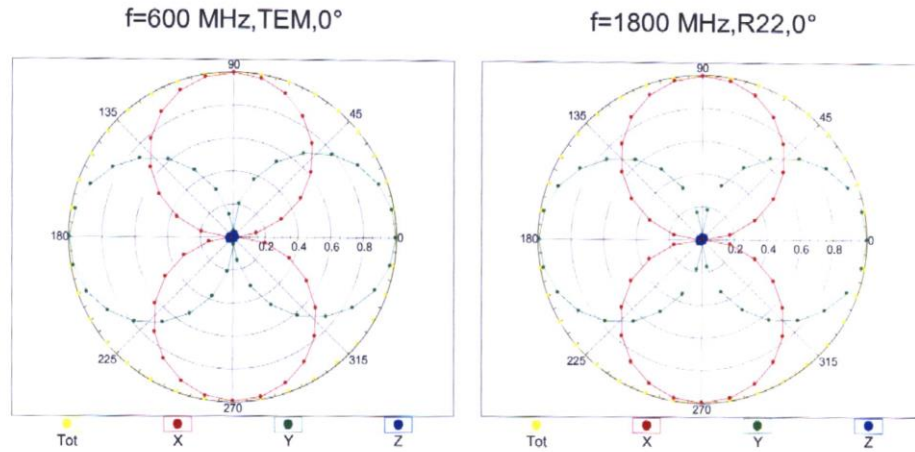
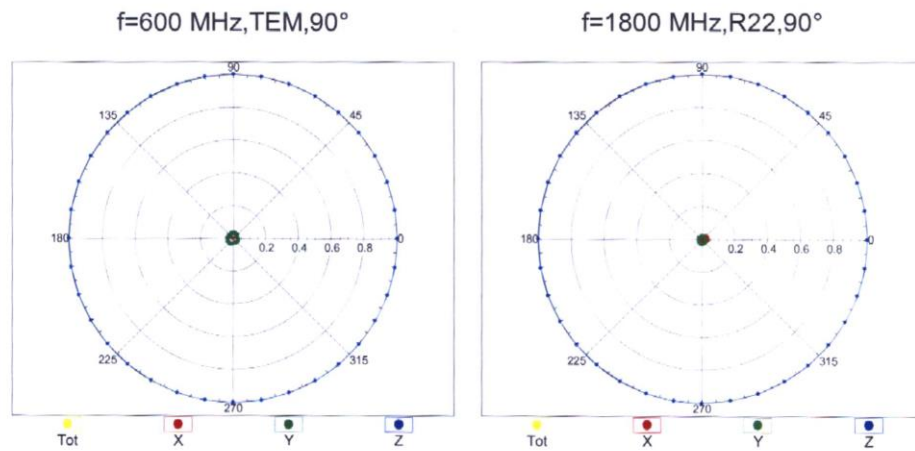
**Receiving Pattern ( $\phi$ ),  $\vartheta = 0^\circ$** **Receiving Pattern ( $\phi$ ),  $\vartheta = 90^\circ$** 

EF3DV3 – SN:4060

May 13, 2022

### Receiving Pattern ( $\phi$ ), $\vartheta = 0^\circ$

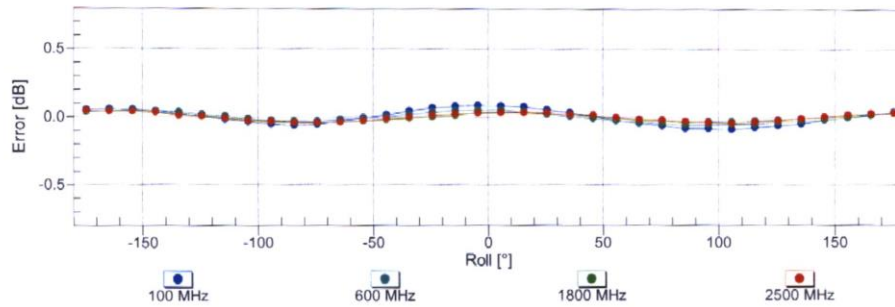
Uncertainty of Axial Isotropy Assessment:  $\pm 0.5\%$  ( $k=2$ )

### Receiving Pattern ( $\phi$ ), $\vartheta = 90^\circ$

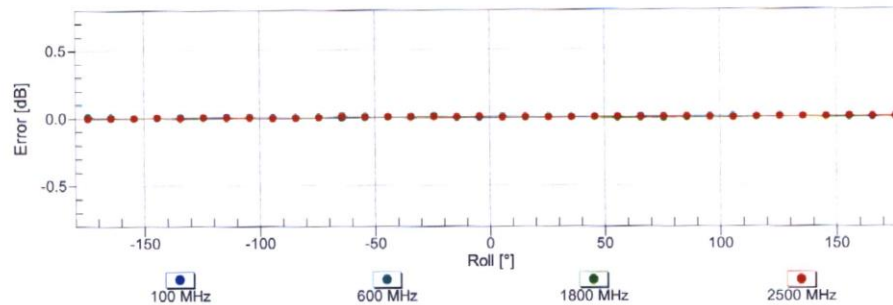
Uncertainty of Axial Isotropy Assessment:  $\pm 0.5\%$  ( $k=2$ )



### Dynamic Range f(E-field) (TEM cell, f = 900 MHz)

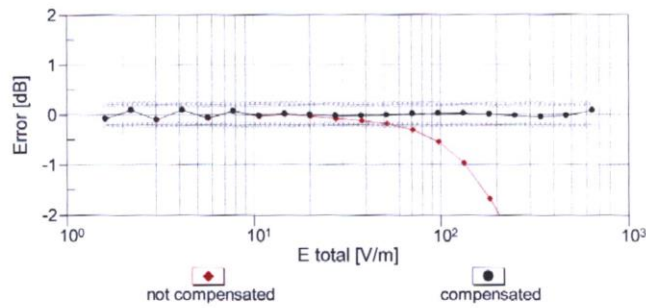
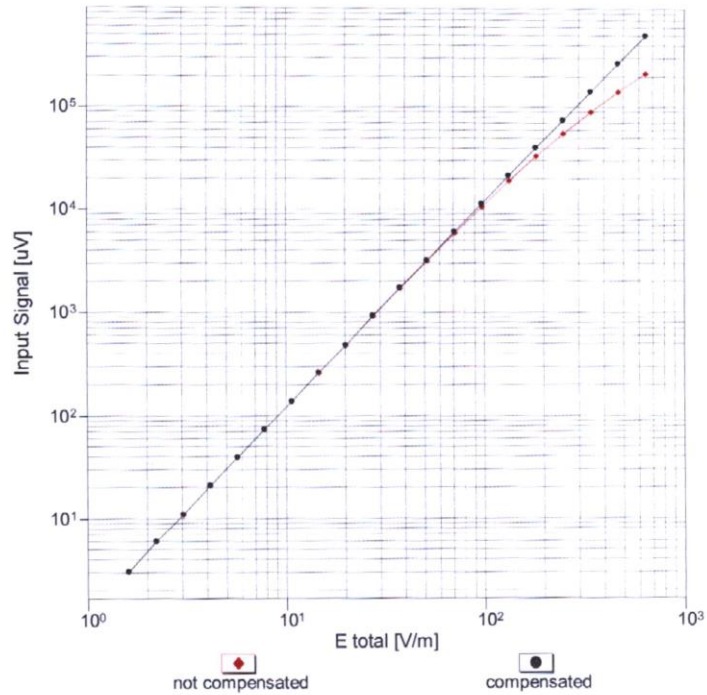

Uncertainty of Linearity Assessment:  $\pm 0.6\%$  (k=2)

### Deviation from Isotropy in Air Error ( $\phi$ , $\theta$ ), $f = 900$ MHz

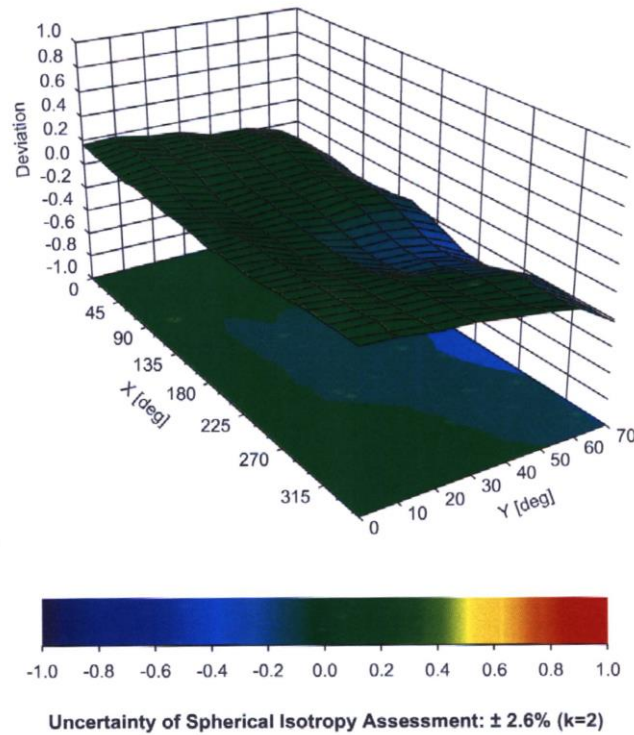

**Appendix: Modulation Calibration Parameters**

| UID   | Rev | Communication System Name                           | Group     | PAR (dB) | Unc <sup>E</sup> (k=2) |
|-------|-----|---|-----------|----------|------------------------|
| 0     | -   | CW  | CW        | 0.00     | ± 4.7 %                |
| 10010 | CAA | SAR Validation (Square, 100ms, 10ms)                | Test      | 10.00    | ± 9.6 %                |
| 10011 | CAB | UMTS-FDD (WCDMA)                                    | WCDMA     | 2.91     | ± 9.6 %                |
| 10012 | CAB | IEEE 802.11b WiFi 2.4 GHz (DSSS, 1 Mbps)            | WLAN      | 1.87     | ± 9.6 %                |
| 10013 | CAB | IEEE 802.11g WiFi 2.4 GHz (DSSS-OFDM, 6 Mbps)       | WLAN      | 9.46     | ± 9.6 %                |
| 10021 | DAC | GSM-FDD (TDMA, GMSK)                                | GSM       | 9.39     | ± 9.6 %                |
| 10023 | DAC | GPRS-FDD (TDMA, GMSK, TN 0)                         | GSM       | 9.57     | ± 9.6 %                |
| 10024 | DAC | GPRS-FDD (TDMA, GMSK, TN 0-1)                       | GSM       | 6.56     | ± 9.6 %                |
| 10025 | DAC | EDGE-FDD (TDMA, 8PSK, TN 0)                         | GSM       | 12.62    | ± 9.6 %                |
| 10026 | DAC | EDGE-FDD (TDMA, 8PSK, TN 0-1)                       | GSM       | 9.55     | ± 9.6 %                |
| 10027 | DAC | GPRS-FDD (TDMA, GMSK, TN 0-1-2)                     | GSM       | 4.80     | ± 9.6 %                |
| 10028 | DAC | GPRS-FDD (TDMA, GMSK, TN 0-1-2-3)                   | GSM       | 3.55     | ± 9.6 %                |
| 10029 | DAC | EDGE-FDD (TDMA, 8PSK, TN 0-1-2)                     | GSM       | 7.78     | ± 9.6 %                |
| 10030 | CAA | IEEE 802.15.1 Bluetooth (GFSK, DH1)                 | Bluetooth | 5.30     | ± 9.6 %                |
| 10031 | CAA | IEEE 802.15.1 Bluetooth (GFSK, DH3)                 | Bluetooth | 1.87     | ± 9.6 %                |
| 10032 | CAA | IEEE 802.15.1 Bluetooth (GFSK, DH5)                 | Bluetooth | 1.16     | ± 9.6 %                |
| 10033 | CAA | IEEE 802.15.1 Bluetooth (PI/4-DQPSK, DH1)           | Bluetooth | 7.74     | ± 9.6 %                |
| 10034 | CAA | IEEE 802.15.1 Bluetooth (PI/4-DQPSK, DH3)           | Bluetooth | 4.53     | ± 9.6 %                |
| 10035 | CAA | IEEE 802.15.1 Bluetooth (PI/4-DQPSK, DH5)           | Bluetooth | 3.83     | ± 9.6 %                |
| 10036 | CAA | IEEE 802.15.1 Bluetooth (8-DPSK, DH1)               | Bluetooth | 8.01     | ± 9.6 %                |
| 10037 | CAA | IEEE 802.15.1 Bluetooth (8-DPSK, DH3)               | Bluetooth | 4.77     | ± 9.6 %                |
| 10038 | CAA | IEEE 802.15.1 Bluetooth (8-DPSK, DH5)               | Bluetooth | 4.10     | ± 9.6 %                |
| 10039 | CAB | CDMA2000 (1xRTT, RC1)                               | CDMA2000  | 4.57     | ± 9.6 %                |
| 10042 | CAB | IS-54 / IS-136 FDD (TDMA/FDM, PI/4-DQPSK, Halfrate) | AMPS      | 7.78     | ± 9.6 %                |
| 10044 | CAA | IS-91/EIA/TIA-553 FDD (FDMA, FM)                    | AMPS      | 0.00     | ± 9.6 %                |
| 10048 | CAA | DECT (TDD, TDMA/FDM, GFSK, Full Slot, 24)           | DECT      | 13.80    | ± 9.6 %                |
| 10049 | CAA | DECT (TDD, TDMA/FDM, GFSK, Double Slot, 12)         | DECT      | 10.79    | ± 9.6 %                |
| 10056 | CAA | UMTS-TDD (TD-SCDMA, 1.28 Mcps)                      | TD-SCDMA  | 11.01    | ± 9.6 %                |
| 10058 | DAC | EDGE-FDD (TDMA, 8PSK, TN 0-1-2-3)                   | GSM       | 6.52     | ± 9.6 %                |
| 10059 | CAB | IEEE 802.11b WiFi 2.4 GHz (DSSS, 2 Mbps)            | WLAN      | 2.12     | ± 9.6 %                |
| 10060 | CAB | IEEE 802.11b WiFi 2.4 GHz (DSSS, 5.5 Mbps)          | WLAN      | 2.83     | ± 9.6 %                |
| 10061 | CAB | IEEE 802.11b WiFi 2.4 GHz (DSSS, 11 Mbps)           | WLAN      | 3.60     | ± 9.6 %                |
| 10062 | CAD | IEEE 802.11a/h WiFi 5 GHz (OFDM, 6 Mbps)            | WLAN      | 8.68     | ± 9.6 %                |
| 10063 | CAD | IEEE 802.11a/h WiFi 5 GHz (OFDM, 9 Mbps)            | WLAN      | 8.63     | ± 9.6 %                |
| 10064 | CAD | IEEE 802.11a/h WiFi 5 GHz (OFDM, 12 Mbps)           | WLAN      | 9.09     | ± 9.6 %                |
| 10065 | CAD | IEEE 802.11a/h WiFi 5 GHz (OFDM, 18 Mbps)           | WLAN      | 9.00     | ± 9.6 %                |
| 10066 | CAD | IEEE 802.11a/h WiFi 5 GHz (OFDM, 24 Mbps)           | WLAN      | 9.38     | ± 9.6 %                |
| 10067 | CAD | IEEE 802.11a/h WiFi 5 GHz (OFDM, 36 Mbps)           | WLAN      | 10.12    | ± 9.6 %                |
| 10068 | CAD | IEEE 802.11a/h WiFi 5 GHz (OFDM, 48 Mbps)           | WLAN      | 10.24    | ± 9.6 %                |
| 10069 | CAD | IEEE 802.11a/h WiFi 5 GHz (OFDM, 54 Mbps)           | WLAN      | 10.56    | ± 9.6 %                |
| 10071 | CAB | IEEE 802.11g WiFi 2.4 GHz (DSSS/OFDM, 9 Mbps)       | WLAN      | 9.83     | ± 9.6 %                |
| 10072 | CAB | IEEE 802.11g WiFi 2.4 GHz (DSSS/OFDM, 12 Mbps)      | WLAN      | 9.62     | ± 9.6 %                |
| 10073 | CAB | IEEE 802.11g WiFi 2.4 GHz (DSSS/OFDM, 18 Mbps)      | WLAN      | 9.94     | ± 9.6 %                |
| 10074 | CAB | IEEE 802.11g WiFi 2.4 GHz (DSSS/OFDM, 24 Mbps)      | WLAN      | 10.30    | ± 9.6 %                |
| 10075 | CAB | IEEE 802.11g WiFi 2.4 GHz (DSSS/OFDM, 36 Mbps)      | WLAN      | 10.77    | ± 9.6 %                |
| 10076 | CAB | IEEE 802.11g WiFi 2.4 GHz (DSSS/OFDM, 48 Mbps)      | WLAN      | 10.94    | ± 9.6 %                |
| 10077 | CAB | IEEE 802.11g WiFi 2.4 GHz (DSSS/OFDM, 54 Mbps)      | WLAN      | 11.00    | ± 9.6 %                |
| 10081 | CAB | CDMA2000 (1xRTT, RC3)                               | CDMA2000  | 3.97     | ± 9.6 %                |
| 10082 | CAB | IS-54 / IS-136 FDD (TDMA/FDM, PI/4-DQPSK, Fullrate) | AMPS      | 4.77     | ± 9.6 %                |
| 10090 | DAC | GPRS-FDD (TDMA, GMSK, TN 0-4)                       | GSM       | 6.56     | ± 9.6 %                |
| 10097 | CAB | UMTS-FDD (HSDPA)                                    | WCDMA     | 3.98     | ± 9.6 %                |
| 10098 | CAB | UMTS-FDD (HSUPA, Subtest 2)                         | WCDMA     | 3.98     | ± 9.6 %                |
| 10099 | DAC | EDGE-FDD (TDMA, 8PSK, TN 0-4)                       | GSM       | 9.55     | ± 9.6 %                |



EF3DV3 – SN:4060

May 13, 2022

|       |     |  |         |       |         |
|-------|-----|--|---------|-------|---------|
| 10100 | CAE | LTE-FDD (SC-FDMA, 100% RB, 20 MHz, QPSK)       | LTE-FDD | 5.67  | ± 9.6 % |
| 10101 | CAE | LTE-FDD (SC-FDMA, 100% RB, 20 MHz, 16-QAM)     | LTE-FDD | 6.42  | ± 9.6 % |
| 10102 | CAE | LTE-FDD (SC-FDMA, 100% RB, 20 MHz, 64-QAM)     | LTE-FDD | 6.60  | ± 9.6 % |
| 10103 | CAG | LTE-TDD (SC-FDMA, 100% RB, 20 MHz, QPSK)       | LTE-TDD | 9.29  | ± 9.6 % |
| 10104 | CAG | LTE-TDD (SC-FDMA, 100% RB, 20 MHz, 16-QAM)     | LTE-TDD | 9.97  | ± 9.6 % |
| 10105 | CAG | LTE-TDD (SC-FDMA, 100% RB, 20 MHz, 64-QAM)     | LTE-TDD | 10.01 | ± 9.6 % |
| 10108 | CAG | LTE-FDD (SC-FDMA, 100% RB, 10 MHz, QPSK)       | LTE-FDD | 5.80  | ± 9.6 % |
| 10109 | CAG | LTE-FDD (SC-FDMA, 100% RB, 10 MHz, 16-QAM)     | LTE-FDD | 6.43  | ± 9.6 % |
| 10110 | CAG | LTE-FDD (SC-FDMA, 100% RB, 5 MHz, QPSK)        | LTE-FDD | 5.75  | ± 9.6 % |
| 10111 | CAG | LTE-FDD (SC-FDMA, 100% RB, 5 MHz, 16-QAM)      | LTE-FDD | 6.44  | ± 9.6 % |
| 10112 | CAG | LTE-FDD (SC-FDMA, 100% RB, 10 MHz, 64-QAM)     | LTE-FDD | 6.59  | ± 9.6 % |
| 10113 | CAG | LTE-FDD (SC-FDMA, 100% RB, 5 MHz, 64-QAM)      | LTE-FDD | 6.62  | ± 9.6 % |
| 10114 | CAD | IEEE 802.11n (HT Greenfield, 13.5 Mbps, BPSK)  | WLAN    | 8.10  | ± 9.6 % |
| 10115 | CAD | IEEE 802.11n (HT Greenfield, 81 Mbps, 16-QAM)  | WLAN    | 8.46  | ± 9.6 % |
| 10116 | CAD | IEEE 802.11n (HT Greenfield, 135 Mbps, 64-QAM) | WLAN    | 8.15  | ± 9.6 % |
| 10117 | CAD | IEEE 802.11n (HT Mixed, 13.5 Mbps, BPSK)       | WLAN    | 8.07  | ± 9.6 % |
| 10118 | CAD | IEEE 802.11n (HT Mixed, 81 Mbps, 16-QAM)       | WLAN    | 8.59  | ± 9.6 % |
| 10119 | CAD | IEEE 802.11n (HT Mixed, 135 Mbps, 64-QAM)      | WLAN    | 8.13  | ± 9.6 % |
| 10140 | CAE | LTE-FDD (SC-FDMA, 100% RB, 15 MHz, 16-QAM)     | LTE-FDD | 6.49  | ± 9.6 % |
| 10141 | CAE | LTE-FDD (SC-FDMA, 100% RB, 15 MHz, 64-QAM)     | LTE-FDD | 6.53  | ± 9.6 % |
| 10142 | CAE | LTE-FDD (SC-FDMA, 100% RB, 3 MHz, QPSK)        | LTE-FDD | 5.73  | ± 9.6 % |
| 10143 | CAE | LTE-FDD (SC-FDMA, 100% RB, 3 MHz, 16-QAM)      | LTE-FDD | 6.35  | ± 9.6 % |
| 10144 | CAE | LTE-FDD (SC-FDMA, 100% RB, 3 MHz, 64-QAM)      | LTE-FDD | 6.65  | ± 9.6 % |
| 10145 | CAF | LTE-FDD (SC-FDMA, 100% RB, 1.4 MHz, QPSK)      | LTE-FDD | 5.76  | ± 9.6 % |
| 10146 | CAF | LTE-FDD (SC-FDMA, 100% RB, 1.4 MHz, 16-QAM)    | LTE-FDD | 6.41  | ± 9.6 % |
| 10147 | CAF | LTE-FDD (SC-FDMA, 100% RB, 1.4 MHz, 64-QAM)    | LTE-FDD | 6.72  | ± 9.6 % |
| 10149 | CAE | LTE-FDD (SC-FDMA, 50% RB, 20 MHz, 16-QAM)      | LTE-FDD | 6.42  | ± 9.6 % |
| 10150 | CAE | LTE-FDD (SC-FDMA, 50% RB, 20 MHz, 64-QAM)      | LTE-FDD | 6.60  | ± 9.6 % |
| 10151 | CAG | LTE-TDD (SC-FDMA, 50% RB, 20 MHz, QPSK)        | LTE-TDD | 9.28  | ± 9.6 % |
| 10152 | CAG | LTE-TDD (SC-FDMA, 50% RB, 20 MHz, 16-QAM)      | LTE-TDD | 9.92  | ± 9.6 % |
| 10153 | CAG | LTE-TDD (SC-FDMA, 50% RB, 20 MHz, 64-QAM)      | LTE-TDD | 10.05 | ± 9.6 % |
| 10154 | CAG | LTE-FDD (SC-FDMA, 50% RB, 10 MHz, QPSK)        | LTE-FDD | 5.75  | ± 9.6 % |
| 10155 | CAG | LTE-FDD (SC-FDMA, 50% RB, 10 MHz, 16-QAM)      | LTE-FDD | 6.43  | ± 9.6 % |
| 10156 | CAG | LTE-FDD (SC-FDMA, 50% RB, 5 MHz, QPSK)         | LTE-FDD | 5.79  | ± 9.6 % |
| 10157 | CAG | LTE-FDD (SC-FDMA, 50% RB, 5 MHz, 16-QAM)       | LTE-FDD | 6.49  | ± 9.6 % |
| 10158 | CAG | LTE-FDD (SC-FDMA, 50% RB, 10 MHz, 64-QAM)      | LTE-FDD | 6.62  | ± 9.6 % |
| 10159 | CAG | LTE-FDD (SC-FDMA, 50% RB, 5 MHz, 64-QAM)       | LTE-FDD | 6.56  | ± 9.6 % |
| 10160 | CAE | LTE-FDD (SC-FDMA, 50% RB, 15 MHz, QPSK)        | LTE-FDD | 5.82  | ± 9.6 % |
| 10161 | CAE | LTE-FDD (SC-FDMA, 50% RB, 15 MHz, 16-QAM)      | LTE-FDD | 6.43  | ± 9.6 % |
| 10162 | CAE | LTE-FDD (SC-FDMA, 50% RB, 15 MHz, 64-QAM)      | LTE-FDD | 6.58  | ± 9.6 % |
| 10166 | CAF | LTE-FDD (SC-FDMA, 50% RB, 1.4 MHz, QPSK)       | LTE-FDD | 5.46  | ± 9.6 % |
| 10167 | CAF | LTE-FDD (SC-FDMA, 50% RB, 1.4 MHz, 16-QAM)     | LTE-FDD | 6.21  | ± 9.6 % |
| 10168 | CAF | LTE-FDD (SC-FDMA, 50% RB, 1.4 MHz, 64-QAM)     | LTE-FDD | 6.79  | ± 9.6 % |
| 10169 | CAE | LTE-FDD (SC-FDMA, 1 RB, 20 MHz, QPSK)          | LTE-FDD | 5.73  | ± 9.6 % |
| 10170 | CAE | LTE-FDD (SC-FDMA, 1 RB, 20 MHz, 16-QAM)        | LTE-FDD | 6.52  | ± 9.6 % |
| 10171 | AAE | LTE-FDD (SC-FDMA, 1 RB, 20 MHz, 64-QAM)        | LTE-FDD | 6.49  | ± 9.6 % |
| 10172 | CAG | LTE-TDD (SC-FDMA, 1 RB, 20 MHz, QPSK)          | LTE-TDD | 9.21  | ± 9.6 % |
| 10173 | CAG | LTE-TDD (SC-FDMA, 1 RB, 20 MHz, 16-QAM)        | LTE-TDD | 9.48  | ± 9.6 % |
| 10174 | CAG | LTE-TDD (SC-FDMA, 1 RB, 20 MHz, 64-QAM)        | LTE-TDD | 10.25 | ± 9.6 % |
| 10175 | CAG | LTE-FDD (SC-FDMA, 1 RB, 10 MHz, QPSK)          | LTE-FDD | 5.72  | ± 9.6 % |
| 10176 | CAG | LTE-FDD (SC-FDMA, 1 RB, 10 MHz, 16-QAM)        | LTE-FDD | 6.52  | ± 9.6 % |
| 10177 | CAI | LTE-FDD (SC-FDMA, 1 RB, 5 MHz, QPSK)           | LTE-FDD | 5.73  | ± 9.6 % |
| 10178 | CAG | LTE-FDD (SC-FDMA, 1 RB, 5 MHz, 16-QAM)         | LTE-FDD | 6.52  | ± 9.6 % |
| 10179 | CAG | LTE-FDD (SC-FDMA, 1 RB, 10 MHz, 64-QAM)        | LTE-FDD | 6.50  | ± 9.6 % |
| 10180 | CAG | LTE-FDD (SC-FDMA, 1 RB, 5 MHz, 64-QAM)         | LTE-FDD | 6.50  | ± 9.6 % |
| 10181 | CAE | LTE-FDD (SC-FDMA, 1 RB, 15 MHz, QPSK)          | LTE-FDD | 5.73  | ± 9.6 % |



EF3DV3 – SN:4060

May 13, 2022

|       |     |   |         |       |         |
|-------|-----|---|---------|-------|---------|
| 10182 | CAE | LTE-FDD (SC-FDMA, 1 RB, 15 MHz, 16-QAM)       | LTE-FDD | 6.52  | ± 9.6 % |
| 10183 | AAD | LTE-FDD (SC-FDMA, 1 RB, 15 MHz, 64-QAM)       | LTE-FDD | 6.50  | ± 9.6 % |
| 10184 | CAE | LTE-FDD (SC-FDMA, 1 RB, 3 MHz, QPSK)          | LTE-FDD | 5.73  | ± 9.6 % |
| 10185 | CAE | LTE-FDD (SC-FDMA, 1 RB, 3 MHz, 16-QAM)        | LTE-FDD | 6.51  | ± 9.6 % |
| 10186 | AAE | LTE-FDD (SC-FDMA, 1 RB, 3 MHz, 64-QAM)        | LTE-FDD | 6.50  | ± 9.6 % |
| 10187 | CAF | LTE-FDD (SC-FDMA, 1 RB, 1.4 MHz, QPSK)        | LTE-FDD | 5.73  | ± 9.6 % |
| 10188 | CAF | LTE-FDD (SC-FDMA, 1 RB, 1.4 MHz, 16-QAM)      | LTE-FDD | 6.52  | ± 9.6 % |
| 10189 | AAF | LTE-FDD (SC-FDMA, 1 RB, 1.4 MHz, 64-QAM)      | LTE-FDD | 6.50  | ± 9.6 % |
| 10193 | CAD | IEEE 802.11n (HT Greenfield, 6.5 Mbps, BPSK)  | WLAN    | 8.09  | ± 9.6 % |
| 10194 | CAD | IEEE 802.11n (HT Greenfield, 39 Mbps, 16-QAM) | WLAN    | 8.12  | ± 9.6 % |
| 10195 | CAD | IEEE 802.11n (HT Greenfield, 65 Mbps, 64-QAM) | WLAN    | 8.21  | ± 9.6 % |
| 10196 | CAD | IEEE 802.11n (HT Mixed, 6.5 Mbps, BPSK)       | WLAN    | 8.10  | ± 9.6 % |
| 10197 | CAD | IEEE 802.11n (HT Mixed, 39 Mbps, 16-QAM)      | WLAN    | 8.13  | ± 9.6 % |
| 10198 | CAD | IEEE 802.11n (HT Mixed, 65 Mbps, 64-QAM)      | WLAN    | 8.27  | ± 9.6 % |
| 10219 | CAD | IEEE 802.11n (HT Mixed, 7.2 Mbps, BPSK)       | WLAN    | 8.03  | ± 9.6 % |
| 10220 | CAD | IEEE 802.11n (HT Mixed, 43.3 Mbps, 16-QAM)    | WLAN    | 8.13  | ± 9.6 % |
| 10221 | CAD | IEEE 802.11n (HT Mixed, 72.2 Mbps, 64-QAM)    | WLAN    | 8.27  | ± 9.6 % |
| 10222 | CAD | IEEE 802.11n (HT Mixed, 15 Mbps, BPSK)        | WLAN    | 8.06  | ± 9.6 % |
| 10223 | CAD | IEEE 802.11n (HT Mixed, 90 Mbps, 16-QAM)      | WLAN    | 8.48  | ± 9.6 % |
| 10224 | CAD | IEEE 802.11n (HT Mixed, 150 Mbps, 64-QAM)     | WLAN    | 8.08  | ± 9.6 % |
| 10225 | CAB | UMTS-FDD (HSPA+)                              | WCDMA   | 5.97  | ± 9.6 % |
| 10226 | CAB | LTE-TDD (SC-FDMA, 1 RB, 1.4 MHz, 16-QAM)      | LTE-TDD | 9.49  | ± 9.6 % |
| 10227 | CAB | LTE-TDD (SC-FDMA, 1 RB, 1.4 MHz, 64-QAM)      | LTE-TDD | 10.26 | ± 9.6 % |
| 10228 | CAB | LTE-TDD (SC-FDMA, 1 RB, 1.4 MHz, QPSK)        | LTE-TDD | 9.22  | ± 9.6 % |
| 10229 | CAD | LTE-TDD (SC-FDMA, 1 RB, 3 MHz, 16-QAM)        | LTE-TDD | 9.48  | ± 9.6 % |
| 10230 | CAD | LTE-TDD (SC-FDMA, 1 RB, 3 MHz, 64-QAM)        | LTE-TDD | 10.25 | ± 9.6 % |
| 10231 | CAD | LTE-TDD (SC-FDMA, 1 RB, 3 MHz, QPSK)          | LTE-TDD | 9.19  | ± 9.6 % |
| 10232 | CAG | LTE-TDD (SC-FDMA, 1 RB, 5 MHz, 16-QAM)        | LTE-TDD | 9.48  | ± 9.6 % |
| 10233 | CAG | LTE-TDD (SC-FDMA, 1 RB, 5 MHz, 64-QAM)        | LTE-TDD | 10.25 | ± 9.6 % |
| 10234 | CAG | LTE-TDD (SC-FDMA, 1 RB, 5 MHz, QPSK)          | LTE-TDD | 9.21  | ± 9.6 % |
| 10235 | CAG | LTE-TDD (SC-FDMA, 1 RB, 10 MHz, 16-QAM)       | LTE-TDD | 9.48  | ± 9.6 % |
| 10236 | CAG | LTE-TDD (SC-FDMA, 1 RB, 10 MHz, 64-QAM)       | LTE-TDD | 10.25 | ± 9.6 % |
| 10237 | CAG | LTE-TDD (SC-FDMA, 1 RB, 10 MHz, QPSK)         | LTE-TDD | 9.21  | ± 9.6 % |
| 10238 | CAF | LTE-TDD (SC-FDMA, 1 RB, 15 MHz, 16-QAM)       | LTE-TDD | 9.48  | ± 9.6 % |
| 10239 | CAF | LTE-TDD (SC-FDMA, 1 RB, 15 MHz, 64-QAM)       | LTE-TDD | 10.25 | ± 9.6 % |
| 10240 | CAF | LTE-TDD (SC-FDMA, 1 RB, 15 MHz, QPSK)         | LTE-TDD | 9.21  | ± 9.6 % |
| 10241 | CAB | LTE-TDD (SC-FDMA, 50% RB, 1.4 MHz, 16-QAM)    | LTE-TDD | 9.82  | ± 9.6 % |
| 10242 | CAB | LTE-TDD (SC-FDMA, 50% RB, 1.4 MHz, 64-QAM)    | LTE-TDD | 9.86  | ± 9.6 % |
| 10243 | CAB | LTE-TDD (SC-FDMA, 50% RB, 1.4 MHz, QPSK)      | LTE-TDD | 9.46  | ± 9.6 % |
| 10244 | CAD | LTE-TDD (SC-FDMA, 50% RB, 3 MHz, 16-QAM)      | LTE-TDD | 10.06 | ± 9.6 % |
| 10245 | CAD | LTE-TDD (SC-FDMA, 50% RB, 3 MHz, 64-QAM)      | LTE-TDD | 10.06 | ± 9.6 % |
| 10246 | CAD | LTE-TDD (SC-FDMA, 50% RB, 3 MHz, QPSK)        | LTE-TDD | 9.30  | ± 9.6 % |
| 10247 | CAG | LTE-TDD (SC-FDMA, 50% RB, 5 MHz, 16-QAM)      | LTE-TDD | 9.91  | ± 9.6 % |
| 10248 | CAG | LTE-TDD (SC-FDMA, 50% RB, 5 MHz, 64-QAM)      | LTE-TDD | 10.09 | ± 9.6 % |
| 10249 | CAG | LTE-TDD (SC-FDMA, 50% RB, 5 MHz, QPSK)        | LTE-TDD | 9.29  | ± 9.6 % |
| 10250 | CAG | LTE-TDD (SC-FDMA, 50% RB, 10 MHz, 16-QAM)     | LTE-TDD | 9.81  | ± 9.6 % |
| 10251 | CAG | LTE-TDD (SC-FDMA, 50% RB, 10 MHz, 64-QAM)     | LTE-TDD | 10.17 | ± 9.6 % |
| 10252 | CAG | LTE-TDD (SC-FDMA, 50% RB, 10 MHz, QPSK)       | LTE-TDD | 9.24  | ± 9.6 % |
| 10253 | CAF | LTE-TDD (SC-FDMA, 50% RB, 15 MHz, 16-QAM)     | LTE-TDD | 9.90  | ± 9.6 % |
| 10254 | CAF | LTE-TDD (SC-FDMA, 50% RB, 15 MHz, 64-QAM)     | LTE-TDD | 10.14 | ± 9.6 % |
| 10255 | CAF | LTE-TDD (SC-FDMA, 50% RB, 15 MHz, QPSK)       | LTE-TDD | 9.20  | ± 9.6 % |
| 10256 | CAB | LTE-TDD (SC-FDMA, 100% RB, 1.4 MHz, 16-QAM)   | LTE-TDD | 9.96  | ± 9.6 % |
| 10257 | CAB | LTE-TDD (SC-FDMA, 100% RB, 1.4 MHz, 64-QAM)   | LTE-TDD | 10.08 | ± 9.6 % |
| 10258 | CAB | LTE-TDD (SC-FDMA, 100% RB, 1.4 MHz, QPSK)     | LTE-TDD | 9.34  | ± 9.6 % |
| 10259 | CAD | LTE-TDD (SC-FDMA, 100% RB, 3 MHz, 16-QAM)     | LTE-TDD | 9.98  | ± 9.6 % |
| 10260 | CAD | LTE-TDD (SC-FDMA, 100% RB, 3 MHz, 64-QAM)     | LTE-TDD | 9.97  | ± 9.6 % |



EF3DV3 – SN:4060

May 13, 2022

|       |     |   |          |       |         |
|-------|-----|---|----------|-------|---------|
| 10261 | CAD | LTE-TDD (SC-FDMA, 100% RB, 3 MHz, QPSK)                   | LTE-TDD  | 9.24  | ± 9.6 % |
| 10262 | CAG | LTE-TDD (SC-FDMA, 100% RB, 5 MHz, 16-QAM)                 | LTE-TDD  | 9.83  | ± 9.6 % |
| 10263 | CAG | LTE-TDD (SC-FDMA, 100% RB, 5 MHz, 64-QAM)                 | LTE-TDD  | 10.16 | ± 9.6 % |
| 10264 | CAG | LTE-TDD (SC-FDMA, 100% RB, 5 MHz, QPSK)                   | LTE-TDD  | 9.23  | ± 9.6 % |
| 10265 | CAG | LTE-TDD (SC-FDMA, 100% RB, 10 MHz, 16-QAM)                | LTE-TDD  | 9.92  | ± 9.6 % |
| 10266 | CAG | LTE-TDD (SC-FDMA, 100% RB, 10 MHz, 64-QAM)                | LTE-TDD  | 10.07 | ± 9.6 % |
| 10267 | CAG | LTE-TDD (SC-FDMA, 100% RB, 10 MHz, QPSK)                  | LTE-TDD  | 9.30  | ± 9.6 % |
| 10268 | CAF | LTE-TDD (SC-FDMA, 100% RB, 15 MHz, 16-QAM)                | LTE-TDD  | 10.06 | ± 9.6 % |
| 10269 | CAF | LTE-TDD (SC-FDMA, 100% RB, 15 MHz, 64-QAM)                | LTE-TDD  | 10.13 | ± 9.6 % |
| 10270 | CAF | LTE-TDD (SC-FDMA, 100% RB, 15 MHz, QPSK)                  | LTE-TDD  | 9.58  | ± 9.6 % |
| 10274 | CAB | UMTS-FDD (HSUPA, Subtest 5, 3GPP Rel8.10)                 | WCDMA    | 4.87  | ± 9.6 % |
| 10275 | CAB | UMTS-FDD (HSUPA, Subtest 5, 3GPP Rel8.4)                  | WCDMA    | 3.96  | ± 9.6 % |
| 10277 | CAA | PHS (QPSK)  | PHS      | 11.81 | ± 9.6 % |
| 10278 | CAA | PHS (QPSK, BW 884MHz, Rolloff 0.5)                        | PHS      | 11.81 | ± 9.6 % |
| 10279 | CAA | PHS (QPSK, BW 884MHz, Rolloff 0.38)                       | PHS      | 12.18 | ± 9.6 % |
| 10290 | AAB | CDMA2000, RC1, SO55, Full Rate                            | CDMA2000 | 3.91  | ± 9.6 % |
| 10291 | AAB | CDMA2000, RC3, SO55, Full Rate                            | CDMA2000 | 3.46  | ± 9.6 % |
| 10292 | AAB | CDMA2000, RC3, SO32, Full Rate                            | CDMA2000 | 3.39  | ± 9.6 % |
| 10293 | AAB | CDMA2000, RC3, SO3, Full Rate                             | CDMA2000 | 3.50  | ± 9.6 % |
| 10295 | AAB | CDMA2000, RC1, SO3, 1/8th Rate 25 fr.                     | CDMA2000 | 12.49 | ± 9.6 % |
| 10297 | AAD | LTE-FDD (SC-FDMA, 50% RB, 20 MHz, QPSK)                   | LTE-FDD  | 5.81  | ± 9.6 % |
| 10298 | AAD | LTE-FDD (SC-FDMA, 50% RB, 3 MHz, QPSK)                    | LTE-FDD  | 5.72  | ± 9.6 % |
| 10299 | AAD | LTE-FDD (SC-FDMA, 50% RB, 3 MHz, 16-QAM)                  | LTE-FDD  | 6.39  | ± 9.6 % |
| 10300 | AAD | LTE-FDD (SC-FDMA, 50% RB, 3 MHz, 64-QAM)                  | LTE-FDD  | 6.60  | ± 9.6 % |
| 10301 | AAA | IEEE 802.16e WiMAX (29:18, 5ms, 10MHz, QPSK, PUSC)        | WiMAX    | 12.03 | ± 9.6 % |
| 10302 | AAA | IEEE 802.16e WiMAX (29:18, 5ms, 10MHz, QPSK, PUSC, 3CTRL) | WiMAX    | 12.57 | ± 9.6 % |
| 10303 | AAA | IEEE 802.16e WiMAX (31:15, 5ms, 10MHz, 64QAM, PUSC)       | WiMAX    | 12.52 | ± 9.6 % |
| 10304 | AAA | IEEE 802.16e WiMAX (29:18, 5ms, 10MHz, 64QAM, PUSC)       | WiMAX    | 11.86 | ± 9.6 % |
| 10305 | AAA | IEEE 802.16e WiMAX (31:15, 10ms, 10MHz, 64QAM, PUSC)      | WiMAX    | 15.24 | ± 9.6 % |
| 10306 | AAA | IEEE 802.16e WiMAX (29:18, 10ms, 10MHz, 64QAM, PUSC)      | WiMAX    | 14.67 | ± 9.6 % |
| 10307 | AAA | IEEE 802.16e WiMAX (29:18, 10ms, 10MHz, QPSK, PUSC)       | WiMAX    | 14.49 | ± 9.6 % |
| 10308 | AAA | IEEE 802.16e WiMAX (29:18, 10ms, 10MHz, 16QAM, PUSC)      | WiMAX    | 14.46 | ± 9.6 % |
| 10309 | AAA | IEEE 802.16e WiMAX (29:18, 10ms, 10MHz, 16QAM, AMC 2x3)   | WiMAX    | 14.58 | ± 9.6 % |
| 10310 | AAA | IEEE 802.16e WiMAX (29:18, 10ms, 10MHz, QPSK, AMC 2x3)    | WiMAX    | 14.57 | ± 9.6 % |
| 10311 | AAD | LTE-FDD (SC-FDMA, 100% RB, 15 MHz, QPSK)                  | LTE-FDD  | 6.06  | ± 9.6 % |
| 10313 | AAA | iDEN 1:3  | iDEN     | 10.51 | ± 9.6 % |
| 10314 | AAA | iDEN 1:6  | iDEN     | 13.48 | ± 9.6 % |
| 10315 | AAB | IEEE 802.11b WiFi 2.4 GHz (DSSS, 1 Mbps, 96pc dc)         | WLAN     | 1.71  | ± 9.6 % |
| 10316 | AAB | IEEE 802.11g WiFi 2.4 GHz (ERP-OFDM, 6 Mbps, 96pc dc)     | WLAN     | 8.36  | ± 9.6 % |
| 10317 | AAD | IEEE 802.11a WiFi 5 GHz (OFDM, 6 Mbps, 96pc dc)           | WLAN     | 8.36  | ± 9.6 % |
| 10352 | AAA | Pulse Waveform (200Hz, 10%)                               | Generic  | 10.00 | ± 9.6 % |
| 10353 | AAA | Pulse Waveform (200Hz, 20%)                               | Generic  | 6.99  | ± 9.6 % |
| 10354 | AAA | Pulse Waveform (200Hz, 40%)                               | Generic  | 3.98  | ± 9.6 % |
| 10355 | AAA | Pulse Waveform (200Hz, 60%)                               | Generic  | 2.22  | ± 9.6 % |
| 10356 | AAA | Pulse Waveform (200Hz, 80%)                               | Generic  | 0.97  | ± 9.6 % |
| 10387 | AAA | QPSK Waveform, 1 MHz                                      | Generic  | 5.10  | ± 9.6 % |
| 10388 | AAA | QPSK Waveform, 10 MHz                                     | Generic  | 5.22  | ± 9.6 % |
| 10396 | AAA | 64-QAM Waveform, 100 kHz                                  | Generic  | 6.27  | ± 9.6 % |
| 10399 | AAA | 64-QAM Waveform, 40 MHz                                   | Generic  | 6.27  | ± 9.6 % |
| 10400 | AAE | IEEE 802.11ac WiFi (20MHz, 64-QAM, 99pc dc)               | WLAN     | 8.37  | ± 9.6 % |
| 10401 | AAE | IEEE 802.11ac WiFi (40MHz, 64-QAM, 99pc dc)               | WLAN     | 8.60  | ± 9.6 % |
| 10402 | AAE | IEEE 802.11ac WiFi (80MHz, 64-QAM, 99pc dc)               | WLAN     | 8.53  | ± 9.6 % |
| 10403 | AAB | CDMA2000 (1xEV-DO, Rev. 0)                                | CDMA2000 | 3.76  | ± 9.6 % |
| 10404 | AAB | CDMA2000 (1xEV-DO, Rev. A)                                | CDMA2000 | 3.77  | ± 9.6 % |
| 10406 | AAB | CDMA2000, RC3, SO32, SCH0, Full Rate                      | CDMA2000 | 5.22  | ± 9.6 % |
| 10410 | AAG | LTE-TDD (SC-FDMA, 1 RB, 10 MHz, QPSK, UL Sub=2,3,4,7,8,9) | LTE-TDD  | 7.82  | ± 9.6 % |



EF3DV3 – SN:4060

May 13, 2022

|       |     |  |          |       |         |
|-------|-----|--|----------|-------|---------|
| 10414 | AAA | WLAN CCDF, 64-QAM, 40MHz                                   | Generic  | 8.54  | ± 9.6 % |
| 10415 | AAA | IEEE 802.11b WiFi 2.4 GHz (DSSS, 1 Mbps, 99pc dc)          | WLAN     | 1.54  | ± 9.6 % |
| 10416 | AAA | IEEE 802.11g WiFi 2.4 GHz (ERP-OFDM, 6 Mbps, 99pc dc)      | WLAN     | 8.23  | ± 9.6 % |
| 10417 | AAC | IEEE 802.11a/h WiFi 5 GHz (OFDM, 6 Mbps, 99pc dc)          | WLAN     | 8.23  | ± 9.6 % |
| 10418 | AAA | IEEE 802.11g WiFi 2.4 GHz (DSSS-OFDM, 6 Mbps, 99pc, Long)  | WLAN     | 8.14  | ± 9.6 % |
| 10419 | AAA | IEEE 802.11g WiFi 2.4 GHz (DSSS-OFDM, 6 Mbps, 99pc, Short) | WLAN     | 8.19  | ± 9.6 % |
| 10422 | AAC | IEEE 802.11n (HT Greenfield, 7.2 Mbps, BPSK)               | WLAN     | 8.32  | ± 9.6 % |
| 10423 | AAC | IEEE 802.11n (HT Greenfield, 43.3 Mbps, 16-QAM)            | WLAN     | 8.47  | ± 9.6 % |
| 10424 | AAC | IEEE 802.11n (HT Greenfield, 72.2 Mbps, 64-QAM)            | WLAN     | 8.40  | ± 9.6 % |
| 10425 | AAC | IEEE 802.11n (HT Greenfield, 15 Mbps, BPSK)                | WLAN     | 8.41  | ± 9.6 % |
| 10426 | AAC | IEEE 802.11n (HT Greenfield, 90 Mbps, 16-QAM)              | WLAN     | 8.45  | ± 9.6 % |
| 10427 | AAC | IEEE 802.11n (HT Greenfield, 150 Mbps, 64-QAM)             | WLAN     | 8.41  | ± 9.6 % |
| 10430 | AAD | LTE-FDD (OFDMA, 5 MHz, E-TM 3.1)                           | LTE-FDD  | 8.28  | ± 9.6 % |
| 10431 | AAD | LTE-FDD (OFDMA, 10 MHz, E-TM 3.1)                          | LTE-FDD  | 8.38  | ± 9.6 % |
| 10432 | AAC | LTE-FDD (OFDMA, 15 MHz, E-TM 3.1)                          | LTE-FDD  | 8.34  | ± 9.6 % |
| 10433 | AAC | LTE-FDD (OFDMA, 20 MHz, E-TM 3.1)                          | LTE-FDD  | 8.34  | ± 9.6 % |
| 10434 | AAA | W-CDMA (BS Test Model 1, 64 DPCH)                          | WCDMA    | 8.60  | ± 9.6 % |
| 10435 | AAF | LTE-TDD (SC-FDMA, 1 RB, 20 MHz, QPSK, UL Sub)              | LTE-TDD  | 7.82  | ± 9.6 % |
| 10447 | AAD | LTE-FDD (OFDMA, 5 MHz, E-TM 3.1, Clipping 44%)             | LTE-FDD  | 7.56  | ± 9.6 % |
| 10448 | AAD | LTE-FDD (OFDMA, 10 MHz, E-TM 3.1, Clipping 44%)            | LTE-FDD  | 7.53  | ± 9.6 % |
| 10449 | AAC | LTE-FDD (OFDMA, 15 MHz, E-TM 3.1, Clipping 44%)            | LTE-FDD  | 7.51  | ± 9.6 % |
| 10450 | AAC | LTE-FDD (OFDMA, 20 MHz, E-TM 3.1, Clipping 44%)            | LTE-FDD  | 7.48  | ± 9.6 % |
| 10451 | AAA | W-CDMA (BS Test Model 1, 64 DPCH, Clipping 44%)            | WCDMA    | 7.59  | ± 9.6 % |
| 10453 | AAD | Validation (Square, 10ms, 1ms)                             | Test     | 10.00 | ± 9.6 % |
| 10456 | AAC | IEEE 802.11ac WiFi (160MHz, 64-QAM, 99pc dc)               | WLAN     | 8.63  | ± 9.6 % |
| 10457 | AAA | UMTS-FDD (DC-HSDPA)  | WCDMA    | 6.62  | ± 9.6 % |
| 10458 | AAA | CDMA2000 (1xEV-DO, Rev. B, 2 carriers)                     | CDMA2000 | 6.55  | ± 9.6 % |
| 10459 | AAA | CDMA2000 (1xEV-DO, Rev. B, 3 carriers)                     | CDMA2000 | 8.25  | ± 9.6 % |
| 10460 | AAA | UMTS-FDD (WCDMA, AMR)                                      | WCDMA    | 2.39  | ± 9.6 % |
| 10461 | AAB | LTE-TDD (SC-FDMA, 1 RB, 1.4 MHz, QPSK, UL Sub)             | LTE-TDD  | 7.82  | ± 9.6 % |
| 10462 | AAB | LTE-TDD (SC-FDMA, 1 RB, 1.4 MHz, 16-QAM, UL Sub)           | LTE-TDD  | 8.30  | ± 9.6 % |
| 10463 | AAB | LTE-TDD (SC-FDMA, 1 RB, 1.4 MHz, 64-QAM, UL Sub)           | LTE-TDD  | 8.56  | ± 9.6 % |
| 10464 | AAC | LTE-TDD (SC-FDMA, 1 RB, 3 MHz, QPSK, UL Sub)               | LTE-TDD  | 7.82  | ± 9.6 % |
| 10465 | AAC | LTE-TDD (SC-FDMA, 1 RB, 3 MHz, 16-QAM, UL Sub)             | LTE-TDD  | 8.32  | ± 9.6 % |
| 10466 | AAC | LTE-TDD (SC-FDMA, 1 RB, 3 MHz, 64-QAM, UL Sub)             | LTE-TDD  | 8.57  | ± 9.6 % |
| 10467 | AAF | LTE-TDD (SC-FDMA, 1 RB, 5 MHz, QPSK, UL Sub)               | LTE-TDD  | 7.82  | ± 9.6 % |
| 10468 | AAF | LTE-TDD (SC-FDMA, 1 RB, 5 MHz, 16-QAM, UL Sub)             | LTE-TDD  | 8.32  | ± 9.6 % |
| 10469 | AAF | LTE-TDD (SC-FDMA, 1 RB, 5 MHz, 64-QAM, UL Sub)             | LTE-TDD  | 8.56  | ± 9.6 % |
| 10470 | AAF | LTE-TDD (SC-FDMA, 1 RB, 10 MHz, QPSK, UL Sub)              | LTE-TDD  | 7.82  | ± 9.6 % |
| 10471 | AAF | LTE-TDD (SC-FDMA, 1 RB, 10 MHz, 16-QAM, UL Sub)            | LTE-TDD  | 8.32  | ± 9.6 % |
| 10472 | AAF | LTE-TDD (SC-FDMA, 1 RB, 10 MHz, 64-QAM, UL Sub)            | LTE-TDD  | 8.57  | ± 9.6 % |
| 10473 | AAE | LTE-TDD (SC-FDMA, 1 RB, 15 MHz, QPSK, UL Sub)              | LTE-TDD  | 7.82  | ± 9.6 % |
| 10474 | AAE | LTE-TDD (SC-FDMA, 1 RB, 15 MHz, 16-QAM, UL Sub)            | LTE-TDD  | 8.32  | ± 9.6 % |
| 10475 | AAE | LTE-TDD (SC-FDMA, 1 RB, 15 MHz, 64-QAM, UL Sub)            | LTE-TDD  | 8.57  | ± 9.6 % |
| 10477 | AAF | LTE-TDD (SC-FDMA, 1 RB, 20 MHz, 16-QAM, UL Sub)            | LTE-TDD  | 8.32  | ± 9.6 % |
| 10478 | AAF | LTE-TDD (SC-FDMA, 1 RB, 20 MHz, 64-QAM, UL Sub)            | LTE-TDD  | 8.57  | ± 9.6 % |
| 10479 | AAB | LTE-TDD (SC-FDMA, 50% RB, 1.4 MHz, QPSK, UL Sub)           | LTE-TDD  | 7.74  | ± 9.6 % |
| 10480 | AAB | LTE-TDD (SC-FDMA, 50% RB, 1.4 MHz, 16-QAM, UL Sub)         | LTE-TDD  | 8.18  | ± 9.6 % |
| 10481 | AAB | LTE-TDD (SC-FDMA, 50% RB, 1.4 MHz, 64-QAM, UL Sub)         | LTE-TDD  | 8.45  | ± 9.6 % |
| 10482 | AAC | LTE-TDD (SC-FDMA, 50% RB, 3 MHz, QPSK, UL Sub)             | LTE-TDD  | 7.71  | ± 9.6 % |
| 10483 | AAC | LTE-TDD (SC-FDMA, 50% RB, 3 MHz, 16-QAM, Sub)              | LTE-TDD  | 8.39  | ± 9.6 % |
| 10484 | AAC | LTE-TDD (SC-FDMA, 50% RB, 3 MHz, 64-QAM, UL Sub)           | LTE-TDD  | 8.47  | ± 9.6 % |
| 10485 | AAF | LTE-TDD (SC-FDMA, 50% RB, 5 MHz, QPSK, UL Sub)             | LTE-TDD  | 7.59  | ± 9.6 % |
| 10486 | AAF | LTE-TDD (SC-FDMA, 50% RB, 5 MHz, 16-QAM, UL Sub)           | LTE-TDD  | 8.38  | ± 9.6 % |
| 10487 | AAF | LTE-TDD (SC-FDMA, 50% RB, 5 MHz, 64-QAM, UL Sub)           | LTE-TDD  | 8.60  | ± 9.6 % |
| 10488 | AAF | LTE-TDD (SC-FDMA, 50% RB, 10 MHz, QPSK, UL Sub)            | LTE-TDD  | 7.70  | ± 9.6 % |

Certificate No: EF3-4060\_May22

Page 14 of 23



EF3DV3 – SN-4060

May 13, 2022

|       |     |   |         |      |         |
|-------|-----|---|---------|------|---------|
| 10489 | AAF | LTE-TDD (SC-FDMA, 50% RB, 10 MHz, 16-QAM, UL Sub)   | LTE-TDD | 8.31 | ± 9.6 % |
| 10490 | AAF | LTE-TDD (SC-FDMA, 50% RB, 10 MHz, 64-QAM, UL Sub)   | LTE-TDD | 8.54 | ± 9.6 % |
| 10491 | AAE | LTE-TDD (SC-FDMA, 50% RB, 15 MHz, QPSK, UL Sub)     | LTE-TDD | 7.74 | ± 9.6 % |
| 10492 | AAE | LTE-TDD (SC-FDMA, 50% RB, 15 MHz, 16-QAM, UL Sub)   | LTE-TDD | 8.41 | ± 9.6 % |
| 10493 | AAE | LTE-TDD (SC-FDMA, 50% RB, 15 MHz, 64-QAM, UL Sub)   | LTE-TDD | 8.55 | ± 9.6 % |
| 10494 | AAF | LTE-TDD (SC-FDMA, 50% RB, 20 MHz, QPSK, UL Sub)     | LTE-TDD | 7.74 | ± 9.6 % |
| 10495 | AAF | LTE-TDD (SC-FDMA, 50% RB, 20 MHz, 16-QAM, UL Sub)   | LTE-TDD | 8.37 | ± 9.6 % |
| 10496 | AAF | LTE-TDD (SC-FDMA, 50% RB, 20 MHz, 64-QAM, UL Sub)   | LTE-TDD | 8.54 | ± 9.6 % |
| 10497 | AAB | LTE-TDD (SC-FDMA, 100% RB, 1.4 MHz, QPSK, UL Sub)   | LTE-TDD | 7.67 | ± 9.6 % |
| 10498 | AAB | LTE-TDD (SC-FDMA, 100% RB, 1.4 MHz, 16-QAM, UL Sub) | LTE-TDD | 8.40 | ± 9.6 % |
| 10499 | AAB | LTE-TDD (SC-FDMA, 100% RB, 1.4 MHz, 64-QAM, UL Sub) | LTE-TDD | 8.68 | ± 9.6 % |
| 10500 | AAC | LTE-TDD (SC-FDMA, 100% RB, 3 MHz, QPSK, UL Sub)     | LTE-TDD | 7.67 | ± 9.6 % |
| 10501 | AAC | LTE-TDD (SC-FDMA, 100% RB, 3 MHz, 16-QAM, UL Sub)   | LTE-TDD | 8.44 | ± 9.6 % |
| 10502 | AAC | LTE-TDD (SC-FDMA, 100% RB, 3 MHz, 64-QAM, UL Sub)   | LTE-TDD | 8.52 | ± 9.6 % |
| 10503 | AAF | LTE-TDD (SC-FDMA, 100% RB, 5 MHz, QPSK, UL Sub)     | LTE-TDD | 7.72 | ± 9.6 % |
| 10504 | AAF | LTE-TDD (SC-FDMA, 100% RB, 5 MHz, 16-QAM, UL Sub)   | LTE-TDD | 8.31 | ± 9.6 % |
| 10505 | AAF | LTE-TDD (SC-FDMA, 100% RB, 5 MHz, 64-QAM, UL Sub)   | LTE-TDD | 8.54 | ± 9.6 % |
| 10506 | AAF | LTE-TDD (SC-FDMA, 100% RB, 10 MHz, QPSK, UL Sub)    | LTE-TDD | 7.74 | ± 9.6 % |
| 10507 | AAF | LTE-TDD (SC-FDMA, 100% RB, 10 MHz, 16-QAM, UL Sub)  | LTE-TDD | 8.36 | ± 9.6 % |
| 10508 | AAF | LTE-TDD (SC-FDMA, 100% RB, 10 MHz, 64-QAM, UL Sub)  | LTE-TDD | 8.55 | ± 9.6 % |
| 10509 | AAE | LTE-TDD (SC-FDMA, 100% RB, 15 MHz, QPSK, UL Sub)    | LTE-TDD | 7.99 | ± 9.6 % |
| 10510 | AAE | LTE-TDD (SC-FDMA, 100% RB, 15 MHz, 16-QAM, UL Sub)  | LTE-TDD | 8.49 | ± 9.6 % |
| 10511 | AAE | LTE-TDD (SC-FDMA, 100% RB, 15 MHz, 64-QAM, UL Sub)  | LTE-TDD | 8.51 | ± 9.6 % |
| 10512 | AAF | LTE-TDD (SC-FDMA, 100% RB, 20 MHz, QPSK, UL Sub)    | LTE-TDD | 7.74 | ± 9.6 % |
| 10513 | AAF | LTE-TDD (SC-FDMA, 100% RB, 20 MHz, 16-QAM, UL Sub)  | LTE-TDD | 8.42 | ± 9.6 % |
| 10514 | AAF | LTE-TDD (SC-FDMA, 100% RB, 20 MHz, 64-QAM, UL Sub)  | LTE-TDD | 8.45 | ± 9.6 % |
| 10515 | AAA | IEEE 802.11b WiFi 2.4 GHz (DSSS, 2 Mbps, 99pc dc)   | WLAN    | 1.58 | ± 9.6 % |
| 10516 | AAA | IEEE 802.11b WiFi 2.4 GHz (DSSS, 5.5 Mbps, 99pc dc) | WLAN    | 1.57 | ± 9.6 % |
| 10517 | AAA | IEEE 802.11b WiFi 2.4 GHz (DSSS, 11 Mbps, 99pc dc)  | WLAN    | 1.58 | ± 9.6 % |
| 10518 | AAC | IEEE 802.11a/h WiFi 5 GHz (OFDM, 9 Mbps, 99pc dc)   | WLAN    | 8.23 | ± 9.6 % |
| 10519 | AAC | IEEE 802.11a/h WiFi 5 GHz (OFDM, 12 Mbps, 99pc dc)  | WLAN    | 8.39 | ± 9.6 % |
| 10520 | AAC | IEEE 802.11a/h WiFi 5 GHz (OFDM, 18 Mbps, 99pc dc)  | WLAN    | 8.12 | ± 9.6 % |
| 10521 | AAC | IEEE 802.11a/h WiFi 5 GHz (OFDM, 24 Mbps, 99pc dc)  | WLAN    | 7.97 | ± 9.6 % |
| 10522 | AAC | IEEE 802.11a/h WiFi 5 GHz (OFDM, 36 Mbps, 99pc dc)  | WLAN    | 8.45 | ± 9.6 % |
| 10523 | AAC | IEEE 802.11a/h WiFi 5 GHz (OFDM, 48 Mbps, 99pc dc)  | WLAN    | 8.08 | ± 9.6 % |
| 10524 | AAC | IEEE 802.11a/h WiFi 5 GHz (OFDM, 54 Mbps, 99pc dc)  | WLAN    | 8.27 | ± 9.6 % |
| 10525 | AAC | IEEE 802.11ac WiFi (20MHz, MCS0, 99pc dc)           | WLAN    | 8.36 | ± 9.6 % |
| 10526 | AAC | IEEE 802.11ac WiFi (20MHz, MCS1, 99pc dc)           | WLAN    | 8.42 | ± 9.6 % |
| 10527 | AAC | IEEE 802.11ac WiFi (20MHz, MCS2, 99pc dc)           | WLAN    | 8.21 | ± 9.6 % |
| 10528 | AAC | IEEE 802.11ac WiFi (20MHz, MCS3, 99pc dc)           | WLAN    | 8.36 | ± 9.6 % |
| 10529 | AAC | IEEE 802.11ac WiFi (20MHz, MCS4, 99pc dc)           | WLAN    | 8.36 | ± 9.6 % |
| 10531 | AAC | IEEE 802.11ac WiFi (20MHz, MCS6, 99pc dc)           | WLAN    | 8.43 | ± 9.6 % |
| 10532 | AAC | IEEE 802.11ac WiFi (20MHz, MCS7, 99pc dc)           | WLAN    | 8.29 | ± 9.6 % |
| 10533 | AAC | IEEE 802.11ac WiFi (20MHz, MCS8, 99pc dc)           | WLAN    | 8.38 | ± 9.6 % |
| 10534 | AAC | IEEE 802.11ac WiFi (40MHz, MCS0, 99pc dc)           | WLAN    | 8.45 | ± 9.6 % |
| 10535 | AAC | IEEE 802.11ac WiFi (40MHz, MCS1, 99pc dc)           | WLAN    | 8.45 | ± 9.6 % |
| 10536 | AAC | IEEE 802.11ac WiFi (40MHz, MCS2, 99pc dc)           | WLAN    | 8.32 | ± 9.6 % |
| 10537 | AAC | IEEE 802.11ac WiFi (40MHz, MCS3, 99pc dc)           | WLAN    | 8.44 | ± 9.6 % |
| 10538 | AAC | IEEE 802.11ac WiFi (40MHz, MCS4, 99pc dc)           | WLAN    | 8.54 | ± 9.6 % |
| 10540 | AAC | IEEE 802.11ac WiFi (40MHz, MCS6, 99pc dc)           | WLAN    | 8.39 | ± 9.6 % |
| 10541 | AAC | IEEE 802.11ac WiFi (40MHz, MCS7, 99pc dc)           | WLAN    | 8.46 | ± 9.6 % |
| 10542 | AAC | IEEE 802.11ac WiFi (40MHz, MCS8, 99pc dc)           | WLAN    | 8.65 | ± 9.6 % |
| 10543 | AAC | IEEE 802.11ac WiFi (40MHz, MCS9, 99pc dc)           | WLAN    | 8.65 | ± 9.6 % |
| 10544 | AAC | IEEE 802.11ac WiFi (80MHz, MCS0, 99pc dc)           | WLAN    | 8.47 | ± 9.6 % |
| 10545 | AAC | IEEE 802.11ac WiFi (80MHz, MCS1, 99pc dc)           | WLAN    | 8.55 | ± 9.6 % |
| 10546 | AAC | IEEE 802.11ac WiFi (80MHz, MCS2, 99pc dc)           | WLAN    | 8.35 | ± 9.6 % |



EF3DV3 – SN:4060

May 13, 2022

|       |     |   |      |      |         |
|-------|-----|---|------|------|---------|
| 10547 | AAC | IEEE 802.11ac WiFi (80MHz, MCS3, 99pc dc)               | WLAN | 8.49 | ± 9.6 % |
| 10548 | AAC | IEEE 802.11ac WiFi (80MHz, MCS4, 99pc dc)               | WLAN | 8.37 | ± 9.6 % |
| 10550 | AAC | IEEE 802.11ac WiFi (80MHz, MCS6, 99pc dc)               | WLAN | 8.39 | ± 9.6 % |
| 10551 | AAC | IEEE 802.11ac WiFi (80MHz, MCS7, 99pc dc)               | WLAN | 8.50 | ± 9.6 % |
| 10552 | AAC | IEEE 802.11ac WiFi (80MHz, MCS8, 99pc dc)               | WLAN | 8.42 | ± 9.6 % |
| 10553 | AAC | IEEE 802.11ac WiFi (80MHz, MCS9, 99pc dc)               | WLAN | 8.45 | ± 9.6 % |
| 10554 | AAD | IEEE 802.11ac WiFi (160MHz, MCS0, 99pc dc)              | WLAN | 8.48 | ± 9.6 % |
| 10555 | AAD | IEEE 802.11ac WiFi (160MHz, MCS1, 99pc dc)              | WLAN | 8.47 | ± 9.6 % |
| 10556 | AAD | IEEE 802.11ac WiFi (160MHz, MCS2, 99pc dc)              | WLAN | 8.50 | ± 9.6 % |
| 10557 | AAD | IEEE 802.11ac WiFi (160MHz, MCS3, 99pc dc)              | WLAN | 8.52 | ± 9.6 % |
| 10558 | AAD | IEEE 802.11ac WiFi (160MHz, MCS4, 99pc dc)              | WLAN | 8.61 | ± 9.6 % |
| 10560 | AAD | IEEE 802.11ac WiFi (160MHz, MCS6, 99pc dc)              | WLAN | 8.73 | ± 9.6 % |
| 10561 | AAD | IEEE 802.11ac WiFi (160MHz, MCS7, 99pc dc)              | WLAN | 8.56 | ± 9.6 % |
| 10562 | AAD | IEEE 802.11ac WiFi (160MHz, MCS8, 99pc dc)              | WLAN | 8.69 | ± 9.6 % |
| 10563 | AAD | IEEE 802.11ac WiFi (160MHz, MCS9, 99pc dc)              | WLAN | 8.77 | ± 9.6 % |
| 10564 | AAA | IEEE 802.11g WiFi 2.4 GHz (DSSS-OFDM, 9 Mbps, 99pc dc)  | WLAN | 8.25 | ± 9.6 % |
| 10565 | AAA | IEEE 802.11g WiFi 2.4 GHz (DSSS-OFDM, 12 Mbps, 99pc dc) | WLAN | 8.45 | ± 9.6 % |
| 10566 | AAA | IEEE 802.11g WiFi 2.4 GHz (DSSS-OFDM, 18 Mbps, 99pc dc) | WLAN | 8.13 | ± 9.6 % |
| 10567 | AAA | IEEE 802.11g WiFi 2.4 GHz (DSSS-OFDM, 24 Mbps, 99pc dc) | WLAN | 8.00 | ± 9.6 % |
| 10568 | AAA | IEEE 802.11g WiFi 2.4 GHz (DSSS-OFDM, 36 Mbps, 99pc dc) | WLAN | 8.37 | ± 9.6 % |
| 10569 | AAA | IEEE 802.11g WiFi 2.4 GHz (DSSS-OFDM, 48 Mbps, 99pc dc) | WLAN | 8.10 | ± 9.6 % |
| 10570 | AAA | IEEE 802.11g WiFi 2.4 GHz (DSSS-OFDM, 54 Mbps, 99pc dc) | WLAN | 8.30 | ± 9.6 % |
| 10571 | AAA | IEEE 802.11b WiFi 2.4 GHz (DSSS, 1 Mbps, 90pc dc)       | WLAN | 1.99 | ± 9.6 % |
| 10572 | AAA | IEEE 802.11b WiFi 2.4 GHz (DSSS, 2 Mbps, 90pc dc)       | WLAN | 1.99 | ± 9.6 % |
| 10573 | AAA | IEEE 802.11b WiFi 2.4 GHz (DSSS, 5.5 Mbps, 90pc dc)     | WLAN | 1.98 | ± 9.6 % |
| 10574 | AAA | IEEE 802.11b WiFi 2.4 GHz (DSSS, 11 Mbps, 90pc dc)      | WLAN | 1.98 | ± 9.6 % |
| 10575 | AAA | IEEE 802.11g WiFi 2.4 GHz (DSSS-OFDM, 6 Mbps, 90pc dc)  | WLAN | 8.59 | ± 9.6 % |
| 10576 | AAA | IEEE 802.11g WiFi 2.4 GHz (DSSS-OFDM, 9 Mbps, 90pc dc)  | WLAN | 8.60 | ± 9.6 % |
| 10577 | AAA | IEEE 802.11g WiFi 2.4 GHz (DSSS-OFDM, 12 Mbps, 90pc dc) | WLAN | 8.70 | ± 9.6 % |
| 10578 | AAA | IEEE 802.11g WiFi 2.4 GHz (DSSS-OFDM, 18 Mbps, 90pc dc) | WLAN | 8.49 | ± 9.6 % |
| 10579 | AAA | IEEE 802.11g WiFi 2.4 GHz (DSSS-OFDM, 24 Mbps, 90pc dc) | WLAN | 8.36 | ± 9.6 % |
| 10580 | AAA | IEEE 802.11g WiFi 2.4 GHz (DSSS-OFDM, 36 Mbps, 90pc dc) | WLAN | 8.76 | ± 9.6 % |
| 10581 | AAA | IEEE 802.11g WiFi 2.4 GHz (DSSS-OFDM, 48 Mbps, 90pc dc) | WLAN | 8.35 | ± 9.6 % |
| 10582 | AAA | IEEE 802.11g WiFi 2.4 GHz (DSSS-OFDM, 54 Mbps, 90pc dc) | WLAN | 8.67 | ± 9.6 % |
| 10583 | AAC | IEEE 802.11a/h WiFi 5 GHz (OFDM, 6 Mbps, 90pc dc)       | WLAN | 8.59 | ± 9.6 % |
| 10584 | AAC | IEEE 802.11a/h WiFi 5 GHz (OFDM, 9 Mbps, 90pc dc)       | WLAN | 8.60 | ± 9.6 % |
| 10585 | AAC | IEEE 802.11a/h WiFi 5 GHz (OFDM, 12 Mbps, 90pc dc)      | WLAN | 8.70 | ± 9.6 % |
| 10586 | AAC | IEEE 802.11a/h WiFi 5 GHz (OFDM, 18 Mbps, 90pc dc)      | WLAN | 8.49 | ± 9.6 % |
| 10587 | AAC | IEEE 802.11a/h WiFi 5 GHz (OFDM, 24 Mbps, 90pc dc)      | WLAN | 8.36 | ± 9.6 % |
| 10588 | AAC | IEEE 802.11a/h WiFi 5 GHz (OFDM, 36 Mbps, 90pc dc)      | WLAN | 8.76 | ± 9.6 % |
| 10589 | AAC | IEEE 802.11a/h WiFi 5 GHz (OFDM, 48 Mbps, 90pc dc)      | WLAN | 8.35 | ± 9.6 % |
| 10590 | AAC | IEEE 802.11a/h WiFi 5 GHz (OFDM, 54 Mbps, 90pc dc)      | WLAN | 8.67 | ± 9.6 % |
| 10591 | AAC | IEEE 802.11n (HT Mixed, 20MHz, MCS0, 90pc dc)           | WLAN | 8.63 | ± 9.6 % |
| 10592 | AAC | IEEE 802.11n (HT Mixed, 20MHz, MCS1, 90pc dc)           | WLAN | 8.79 | ± 9.6 % |
| 10593 | AAC | IEEE 802.11n (HT Mixed, 20MHz, MCS2, 90pc dc)           | WLAN | 8.64 | ± 9.6 % |
| 10594 | AAC | IEEE 802.11n (HT Mixed, 20MHz, MCS3, 90pc dc)           | WLAN | 8.74 | ± 9.6 % |
| 10595 | AAC | IEEE 802.11n (HT Mixed, 20MHz, MCS4, 90pc dc)           | WLAN | 8.74 | ± 9.6 % |
| 10596 | AAC | IEEE 802.11n (HT Mixed, 20MHz, MCS5, 90pc dc)           | WLAN | 8.71 | ± 9.6 % |
| 10597 | AAC | IEEE 802.11n (HT Mixed, 20MHz, MCS6, 90pc dc)           | WLAN | 8.72 | ± 9.6 % |
| 10598 | AAC | IEEE 802.11n (HT Mixed, 20MHz, MCS7, 90pc dc)           | WLAN | 8.50 | ± 9.6 % |
| 10599 | AAC | IEEE 802.11n (HT Mixed, 40MHz, MCS0, 90pc dc)           | WLAN | 8.79 | ± 9.6 % |
| 10600 | AAC | IEEE 802.11n (HT Mixed, 40MHz, MCS1, 90pc dc)           | WLAN | 8.88 | ± 9.6 % |
| 10601 | AAC | IEEE 802.11n (HT Mixed, 40MHz, MCS2, 90pc dc)           | WLAN | 8.82 | ± 9.6 % |
| 10602 | AAC | IEEE 802.11n (HT Mixed, 40MHz, MCS3, 90pc dc)           | WLAN | 8.94 | ± 9.6 % |
| 10603 | AAC | IEEE 802.11n (HT Mixed, 40MHz, MCS4, 90pc dc)           | WLAN | 9.03 | ± 9.6 % |
| 10604 | AAC | IEEE 802.11n (HT Mixed, 40MHz, MCS5, 90pc dc)           | WLAN | 8.76 | ± 9.6 % |